

JAPAN INTERNATIONAL COOPERATION AGENCY

YANGON CITY DEVELOPMENT COMMITTEE

**THE STUDY  
ON  
IMPROVEMENT OF WATER SUPPLY  
SYSTEM  
IN  
YANGON CITY  
IN THE UNION OF MYANMAR**

**FINAL REPORT  
VOLUME IV: DRAWINGS**

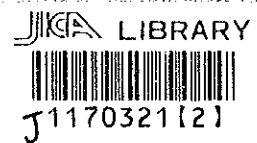

**SEPTEMBER 2002**

**TOKYO ENGINEERING CONSULTANTS CO., LTD.  
NJS CONSULTANTS CO., LTD.**

SSS
JR
02-122

**THE STUDY  
ON  
IMPROVEMENT OF WATER SUPPLY  
SYSTEM  
IN  
YANGON CITY  
IN THE UNION OF MYANMAR**

**FINAL REPORT  
VOLUME IV: DRAWINGS**

**SEPTEMBER 2002**

**TOKYO ENGINEERING CONSULTANTS CO., LTD.  
NJS CONSULTANTS CO., LTD.**



1170321 [2]

**THE STUDY  
ON  
IMPROVEMENT OF WATER SUPPLY SYSTEM  
IN  
YANGON CITY  
IN THE UNION OF MYANMAR**

**FINAL REPORT  
CONSTITUENT VOLUMES**

<b>VOLUME I</b>	<b>SUMMARY REPORT</b>
<b>VOLUME II</b>	<b>MAIN REPORT</b>
<b>VOLUME III</b>	<b>APPENDIX</b>
<b>VOLUME IV</b>	<b>DRAWINGS</b>

## List of Drawings

No.	Contents	Scale
<b>Hlaing Water Treatment Plant (Coagulated Sedimentation and Rapid Sand Filtration) Q = 470,000 m<sup>3</sup>/day</b>		
A-1	General Plan	Not to Scale
A-2	Hydraulic Profile	Not to Scale
A-3	Intake Gate	Plan 1/150
A-4		Section A-A 1/150
A-5	Grit Chamber	Plan 1/500
A-6		Section A-A, B-B 1/500
A-7	Receiving Well	Plan, Section A-A, Section B-B 1/200
A-8	Flocculation and Sedimentation Basin	Plan 1/600
A-9		Section A-A, Section B-B, Section C-C 1/400
A-10	Rapid Sand Filter	Plan 1/300
A-11		Section A-A, B-B 1/300
A-12		Section C-C, D-D 1/200
A-13	Clear Water Reservoir	Plan 1/500
A-14		Section A-A, B-B 1/300
A-15	Backwashing Storage Basin	Plan, Section A-A 1/300
A-16	Sludge Lagoon	Plan, Section 1/2,000 1/1,000
A-17	Administration Building	Plan 1/200

No.	Contents	Scale
<b>Hlawga Water Treatment Plant (Biological Contact Aeration) Q = 820,000 m<sup>3</sup>/day</b>		
B-1	General Plan	Not to Scale
B-2	Hydraulic Profile	Not to Scale
B-3	Intake Tower, Receiving Well A	Plan 1/400
B-4		Section A-A 1/400
B-5	Receiving Well B	Plan, Section A-A 1/300
B-6	Terminal Reservoir	Plan 1/500
B-7		Section A-A, B-B 1/300
B-8	Sludge Lagoon	Plan, Section A-A 1/2,500 1/1,250
B-9	Administration Building	Plan 1/200

No.	Name of Reservoir	Drawing Size
<b>Service Reservoirs</b>		
C-1	CB Hlawga Service Reservoir	Plan 1/500
C-2		Section A-A, B-B 1/400
C-3	CB West Service Reservoir	Plan 1/500
C-4		Section A-A, B-B 1/400
C-5	CB DT East Service Res	Plan 1/500
C-6		Section A-A, B-B 1/400
C-7	EB South Service Res	Plan 1/500
C-8		Section A-A, B-B 1/400
C-9	WB North Service Res	Plan 1/400
C-10		Section A-A, B-B 1/400

No.	Title	Drawing Size
<b>Pipeline Network</b>		
D-1	Existing Transmission Mains	Not to Scale
D-2	Existing Distribution Networks (1/2)	Not to Scale
D-3	Existing Distribution Networks (2/2)	Not to Scale
D-4	Proposed Transmission Mains in 2020 (MP)	Not to Scale
D-5	Proposed Transmission Mains in 2010 (FS)	Not to Scale
D-6	Proposed Distribution Mains in 2020 (MP) (MP)	Not to Scale

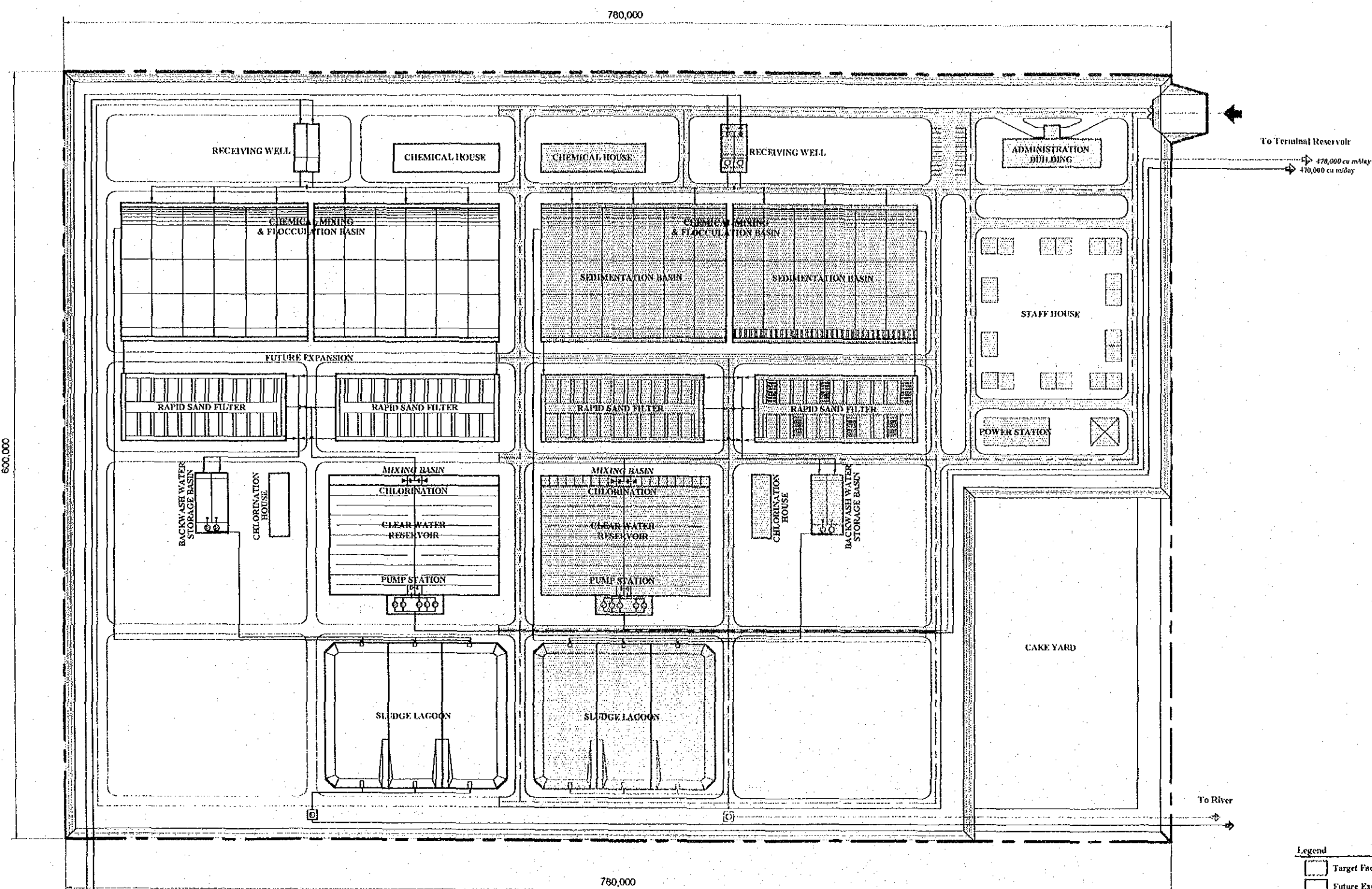

Legend  
 [Dashed Box] Target Facilities in 2010  
 [Solid Box] Future Expansion

**Hlaing WTP General Plan**  
 Not to Scale

project	The Study on Improvement of Water Supply System in Yangon City		
Drawing Title	Hlaing WTP General Plan		
Date	Scale	Drawing No.	
August 2002	Not to Scale	A - 1	

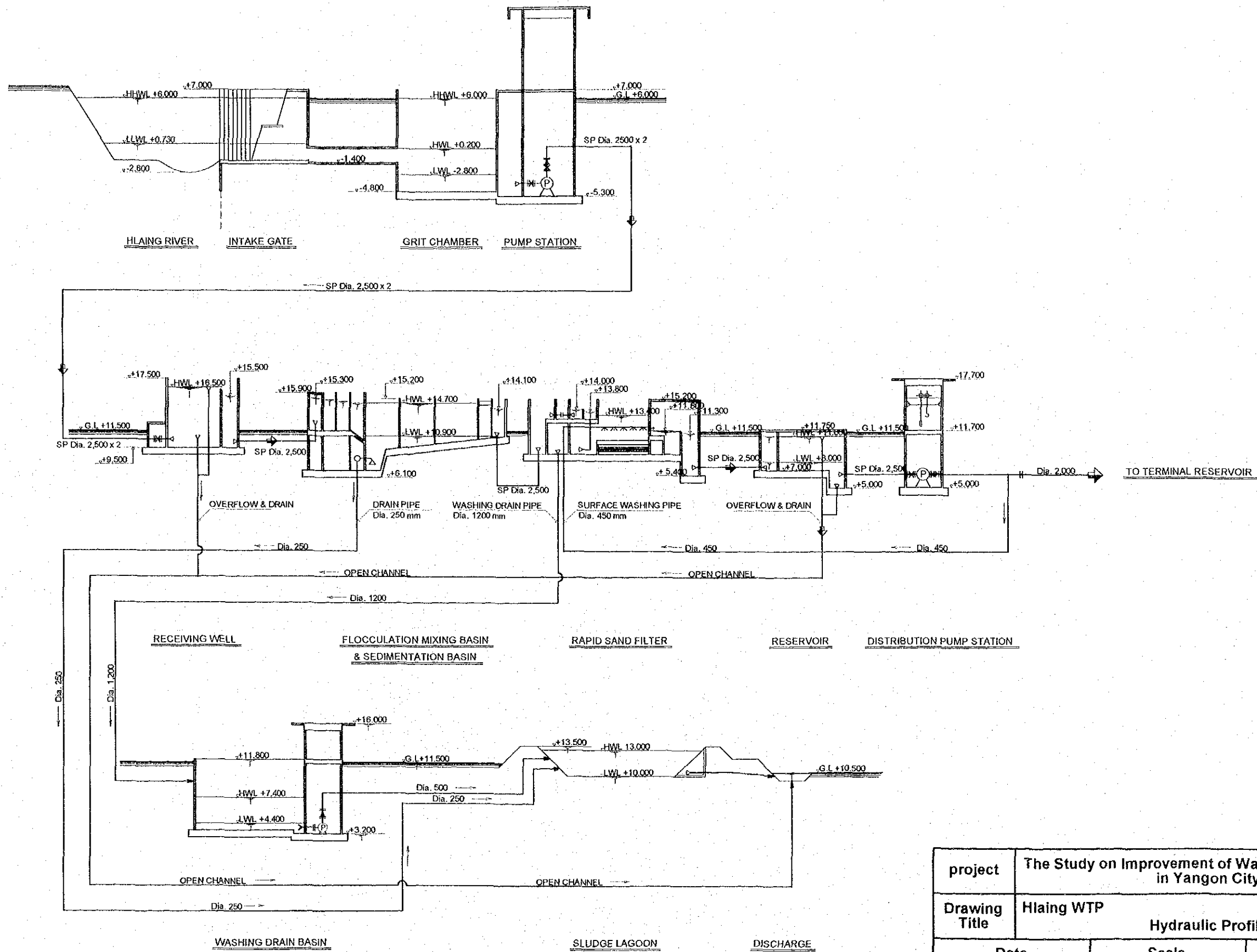

project	The Study on Improvement of Water Supply System in Yangon City		
Drawing Title	Hlaing WTP		
	Hydraulic Profile		
Date	Scale	Drawing No.	
August 2002	Not to Scale	A - 2	

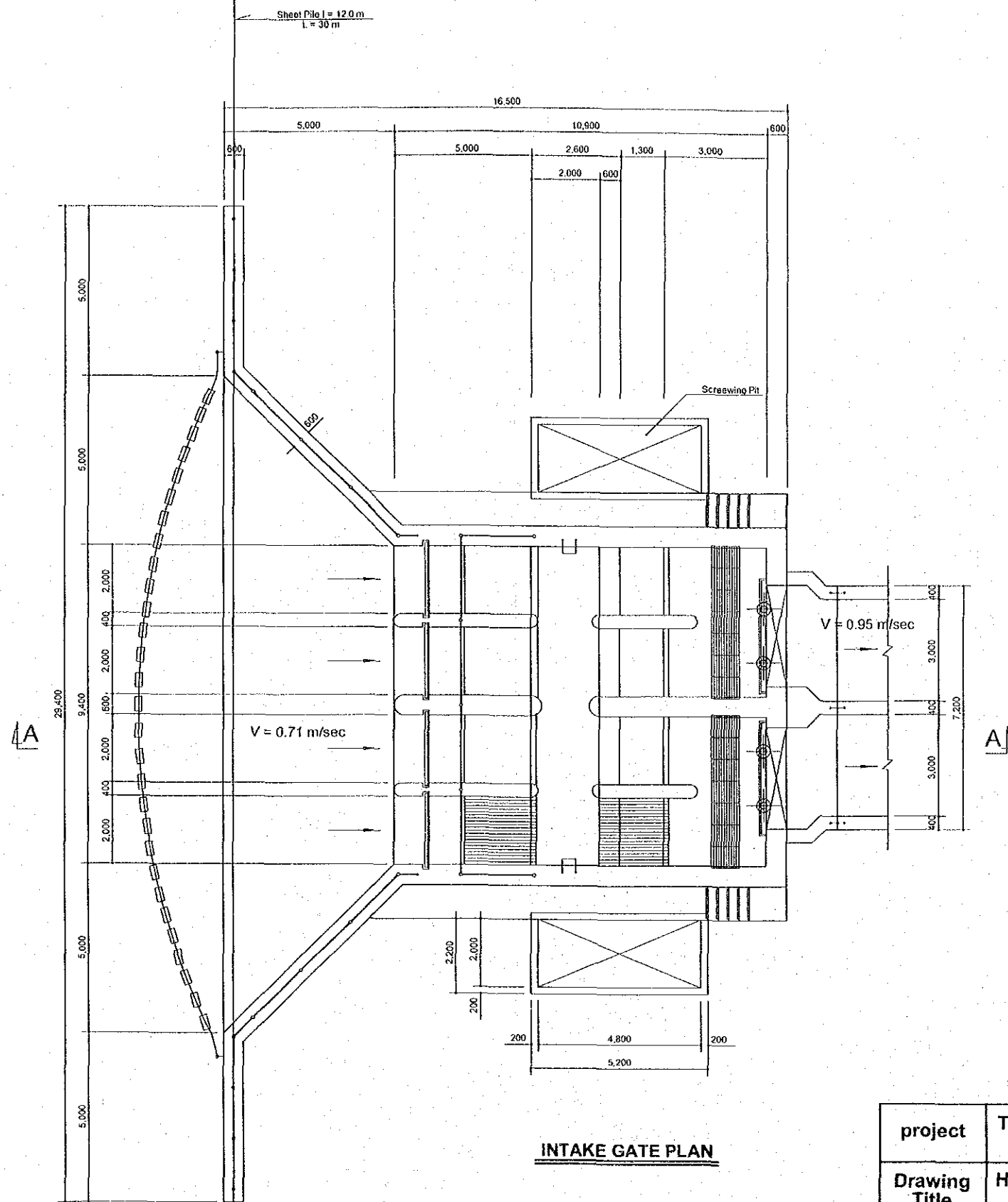

**INTAKE GATE PLAN**

project	The Study on Improvement of Water Supply System in Yangon City		
Drawing Title	Hlaing WTP Intake Gate Plan		
Date	Scale	Drawing No.	
August 2002	1 : 150	A - 3	



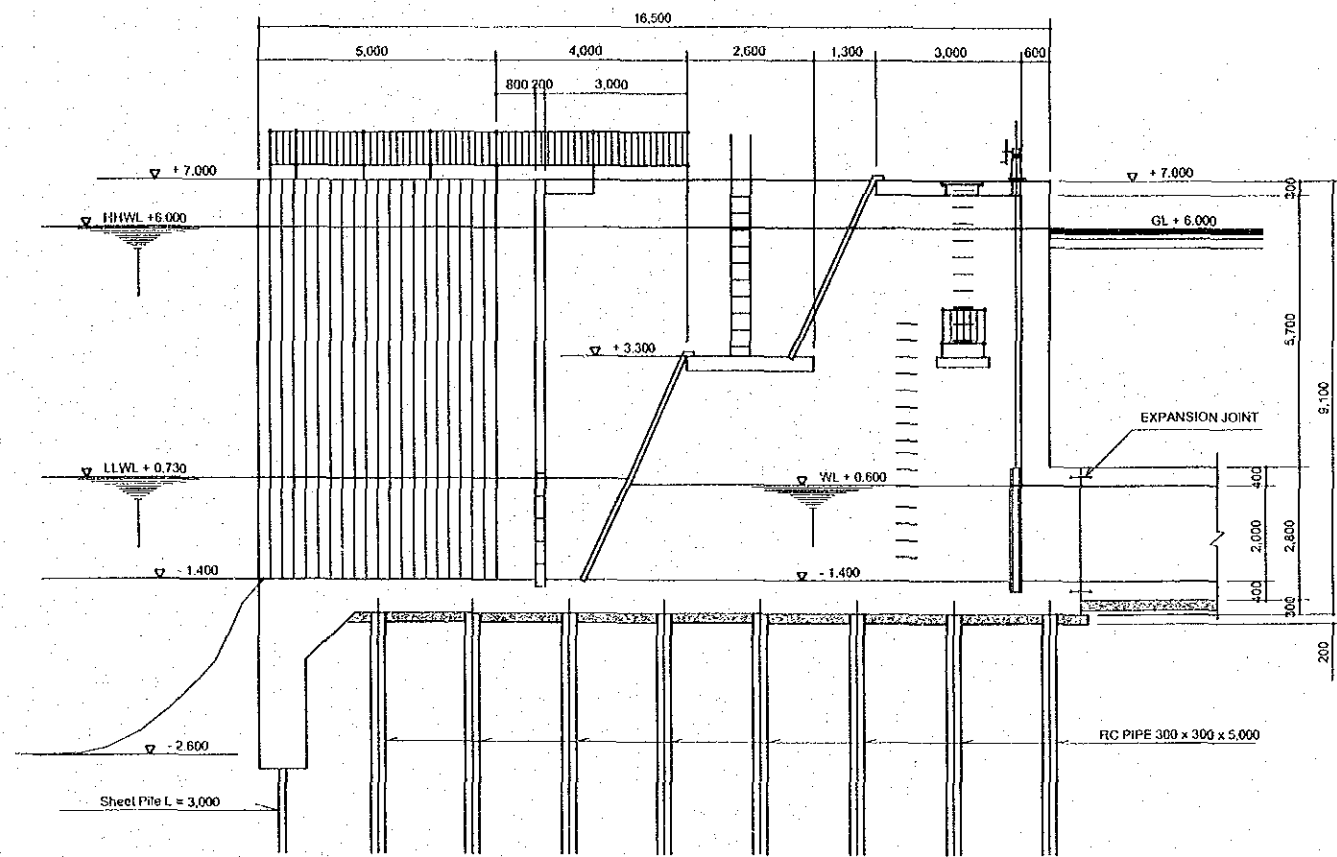

**SECTION A - A**

project	The Study on Improvement of Water Supply System in Yangon City		
Drawing Title	Hlaing WTP Intake Gate Section A - A		
Date	Scale	Drawing No.	
August 2002	1 : 150	A - 4	

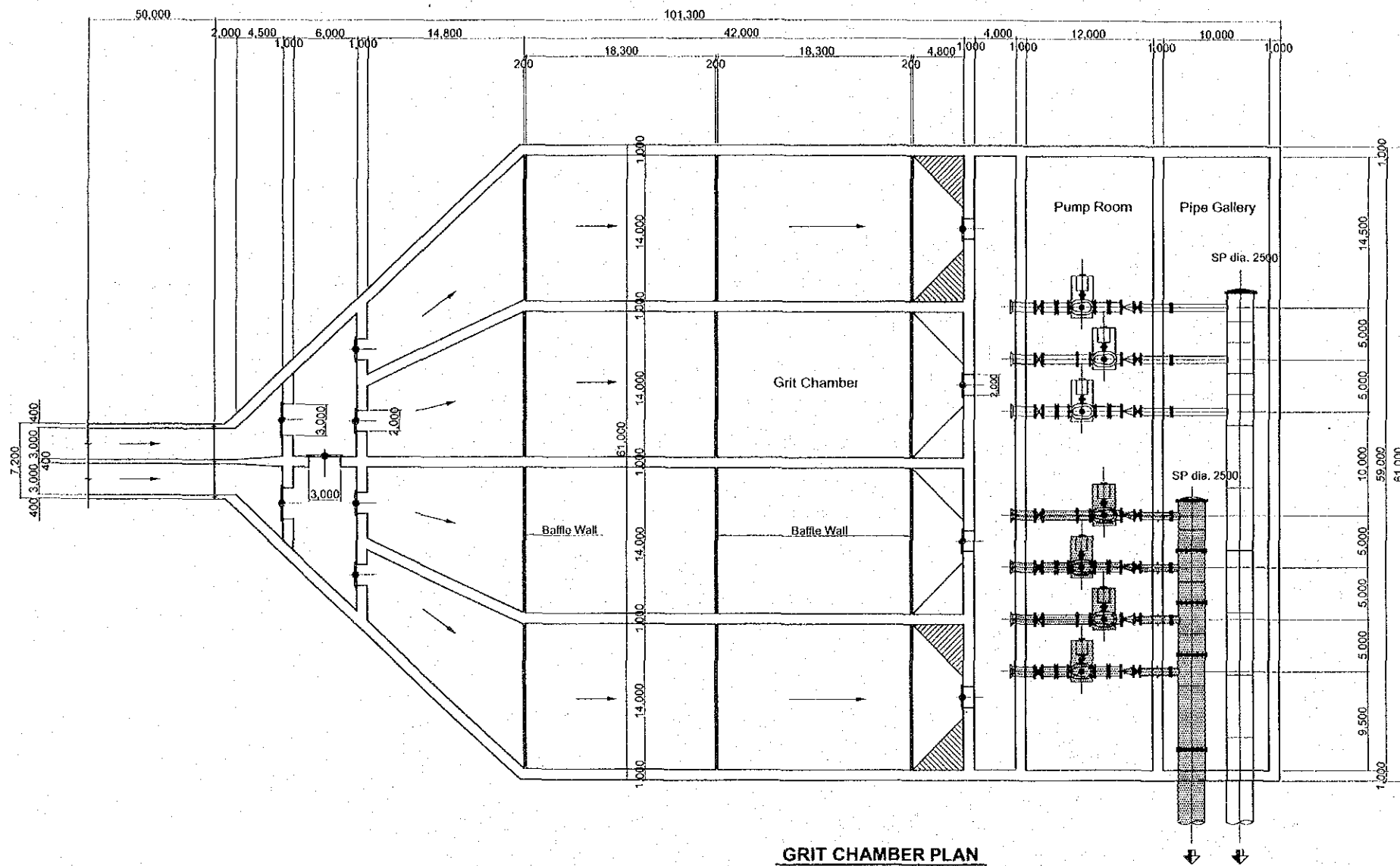

**GRIT CHAMBER PLAN**

Legend  
 [Hatched Box] 2010  
 [White Box] 2020

project	The Study on Improvement of Water Supply System in Yangon City		
Drawing Title	Hlaing WTP Grit Chamber Plan		
Date	Scale	Drawing No.	
August 2002	1 : 500	A - 5	

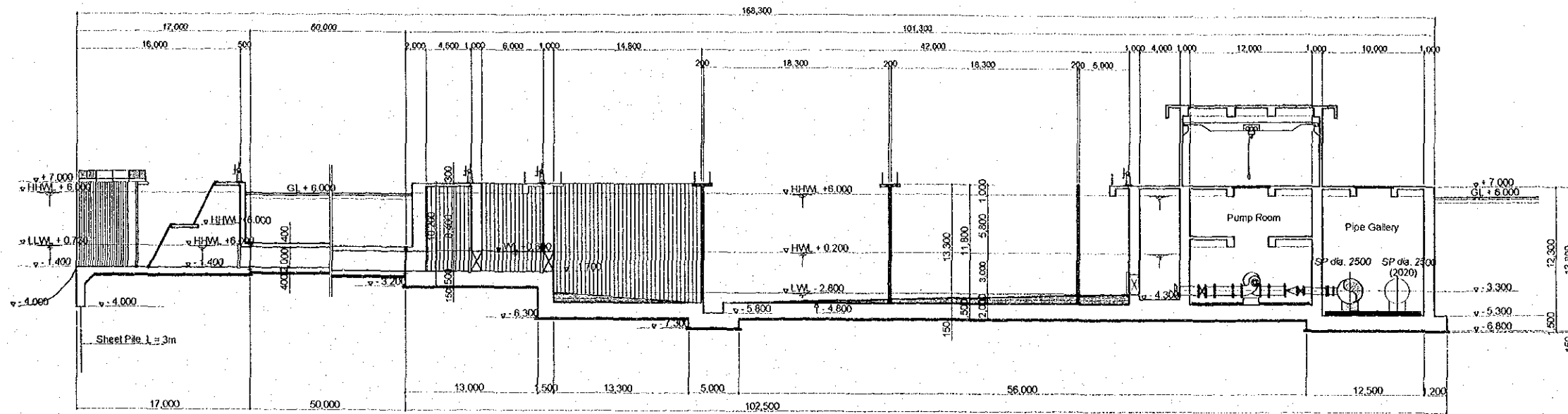

**SECTION A - A**

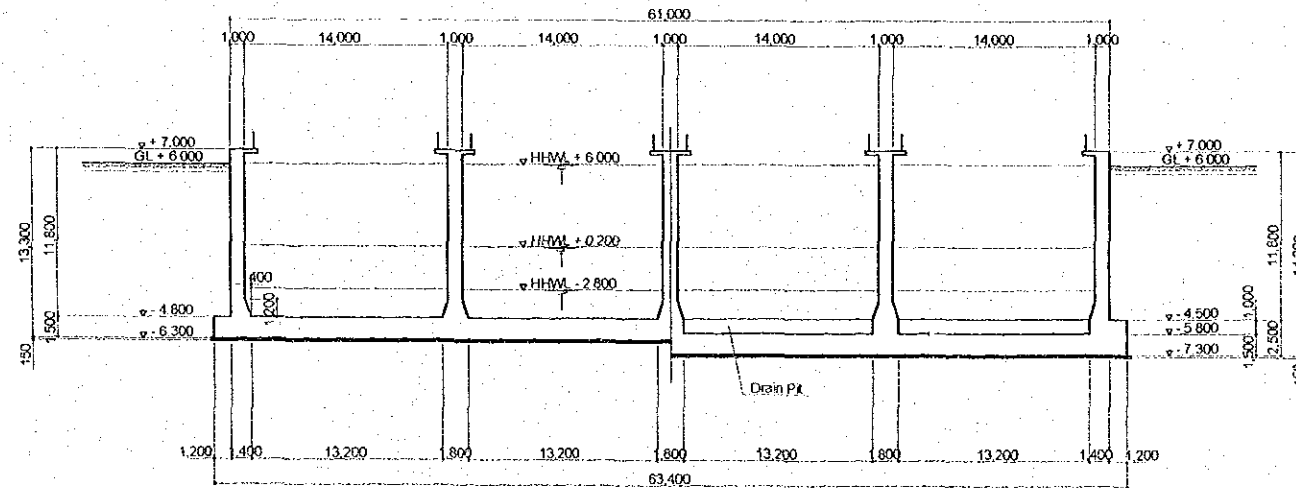

**SECTION B - B**

project	The Study on Improvement of Water Supply System in Yangon City	
Drawing Title	Hlaing WTP Grit Chamber Section A - A, B - B	
Date	Scale	Drawing No.
August 2002	1 : 500	A - 6

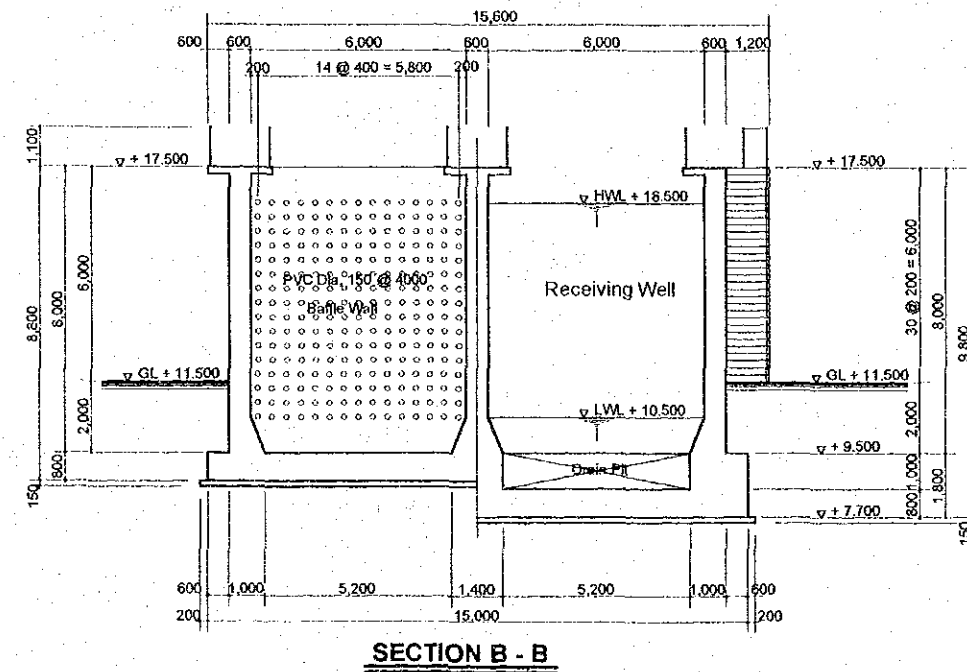
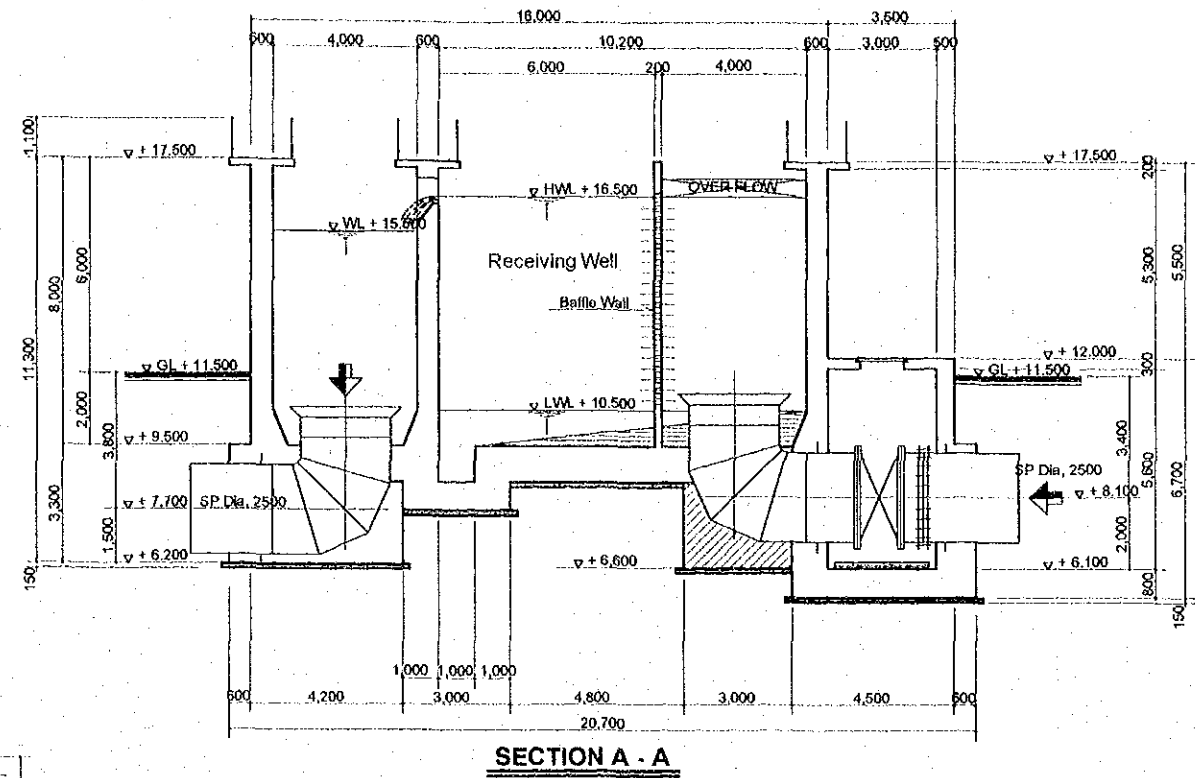
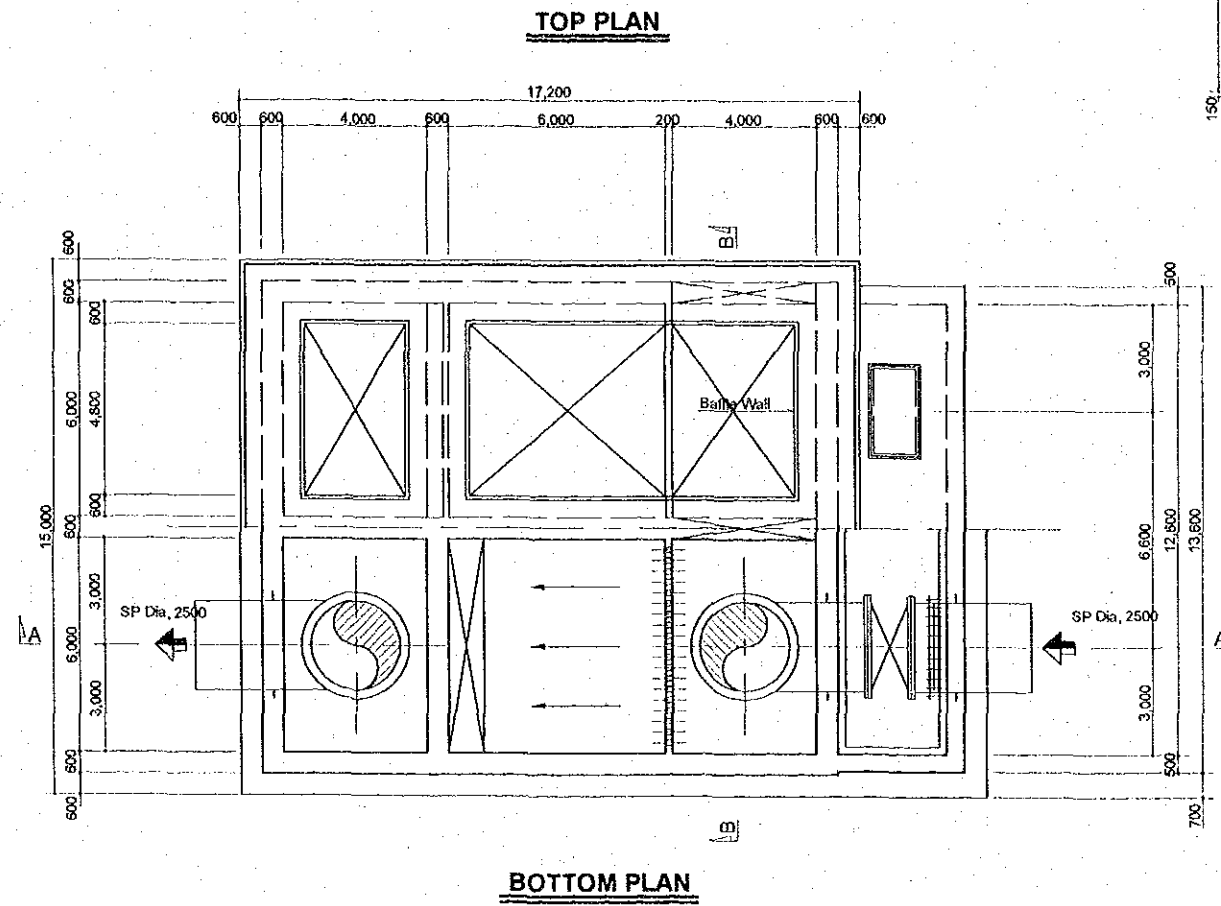

project	The Study on Improvement of Water Supply System in Yangon City	
Drawing Title	Hlaing WTP Receiving Well Plan, Section A - A, Section B - B	
Date	Scale	Drawing No.
August 2002	1 : 200	A - 7

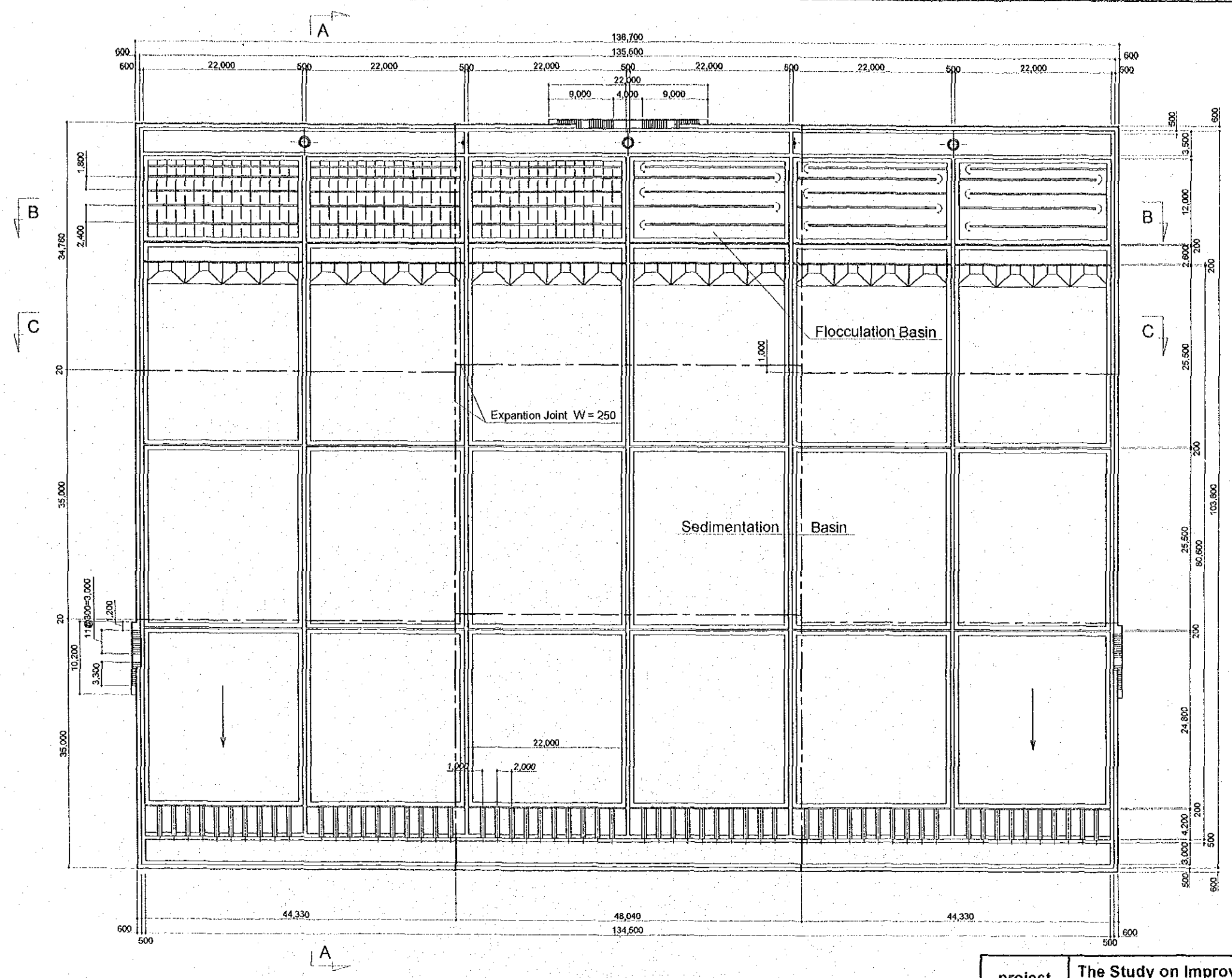

**Flocculation and Sedimentation Basin Plan**

project	The Study on Improvement of Water Supply System in Yangon City	
Drawing Title	Hlaing WTP Flocculation and Sedimentation Basin Plan	
Date	Scale	Drawing No.
August 2002	1 : 600	A - 8

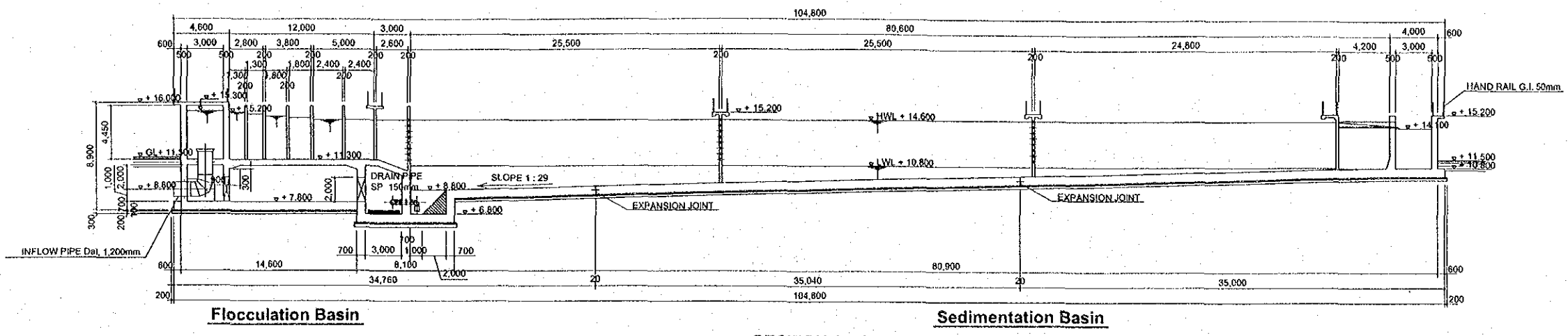

**SECTION A - A**

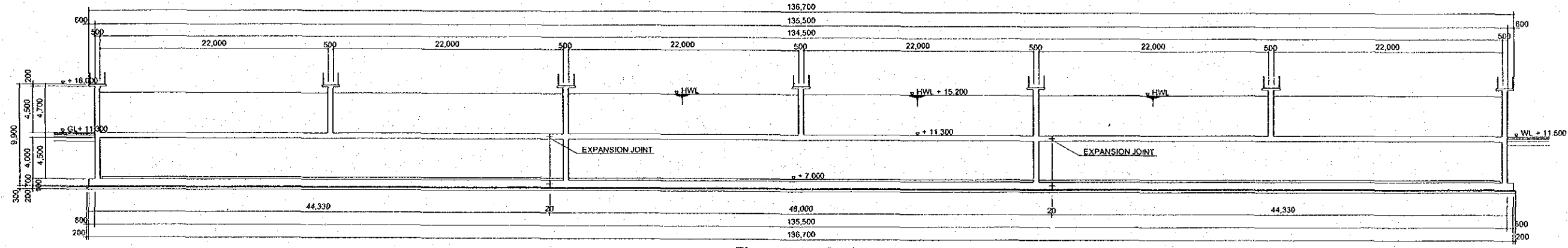

**SECTION B - B**

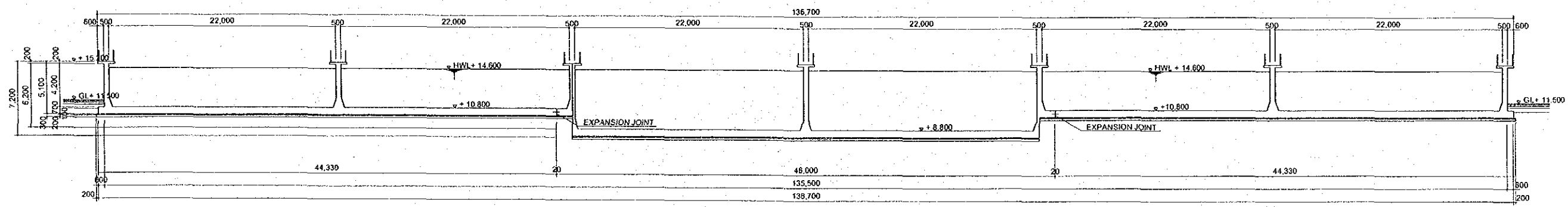

**SECTION C - C**

project	The Study on Improvement of Water Supply System in Yangon City		
Drawing Title	Hlaing WTP Flocculation and Sedimentation Basin Section A - A, B - B, C - C		
Date	Scale	Drawing No.	
August 2002	1 : 400	A - 9	

**TOP PLAN**

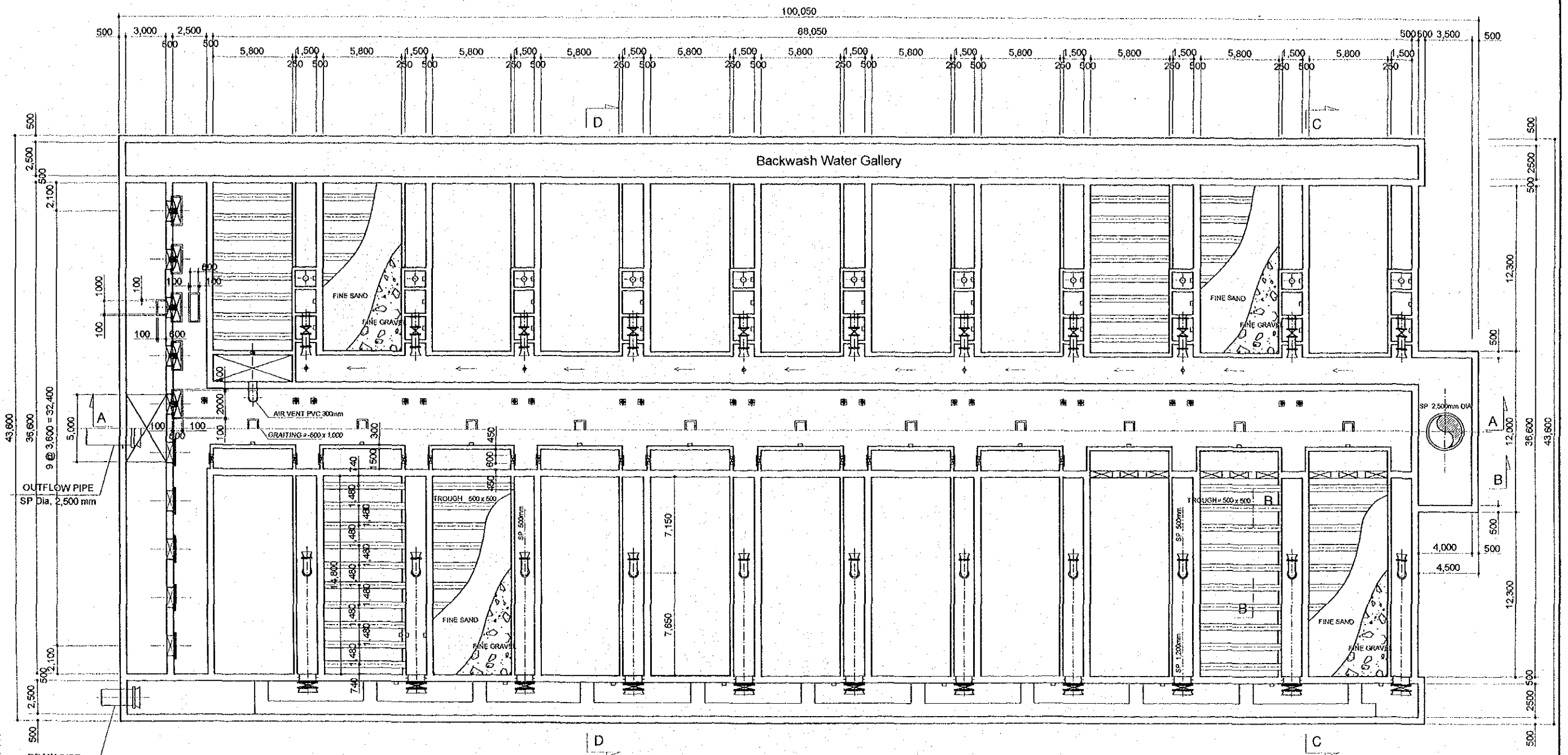

**BOTTOM PLAN**

project	The Study on Improvement of Water Supply System in Yangon City		
Drawing Title	Hlaing WTP Rapid Sand Filter Plan		
Date	Scale	Drawing No.	
August 2002	1 : 300	A - 10	

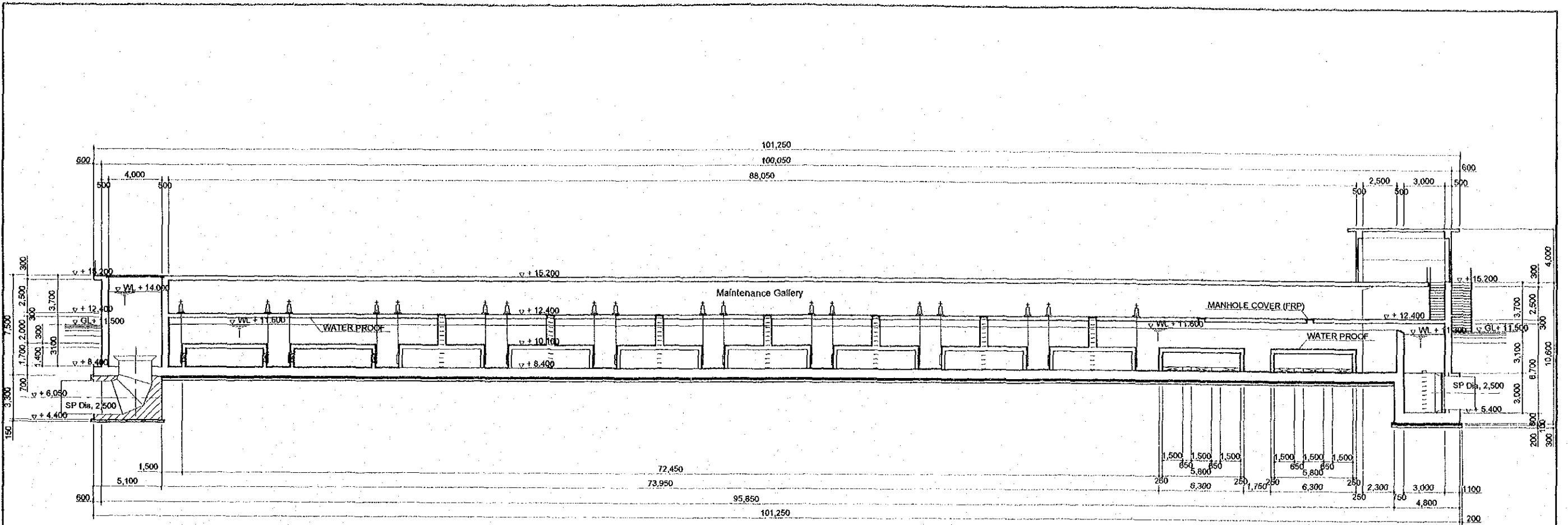

**SECTION A - A**

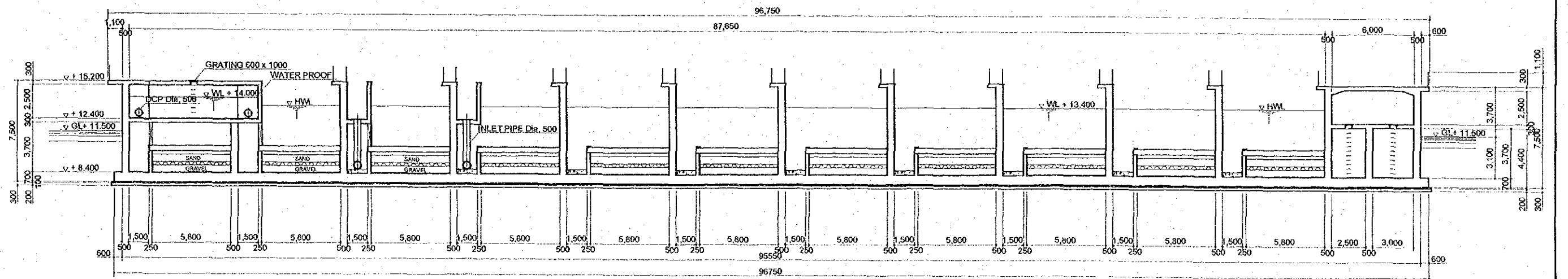

**SECTION B - B**

project	The Study on Improvement of Water Supply System in Yangon City		
Drawing Title	Hlaing WTP Rapid Sand Filter Section A - A, B - B		
Date	Scale	Drawing No.	
August 2002	1 : 300	A - 11	



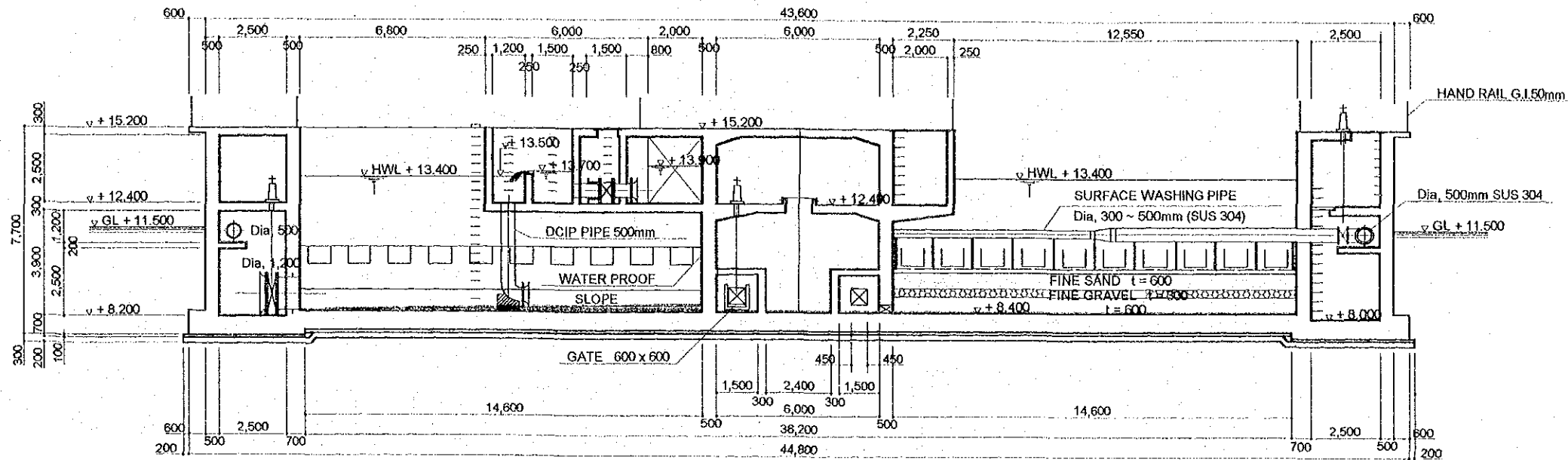

**SECTION C - C**

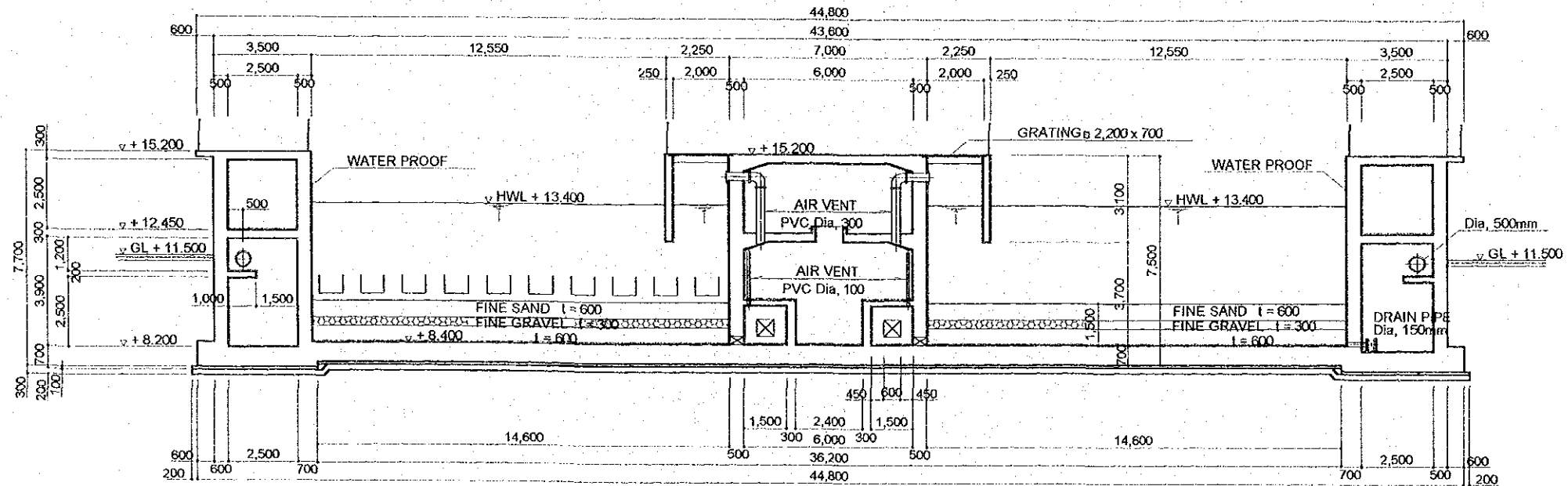

**SECTION D - D**

project	The Study on Improvement of Water Supply System in Yangon City		
Drawing Title	Hlaing WTP Rapid Sand Filter Section C - C, D - D		
Date	Scale	Drawing No.	
August 2002	1 : 200	A - 12	

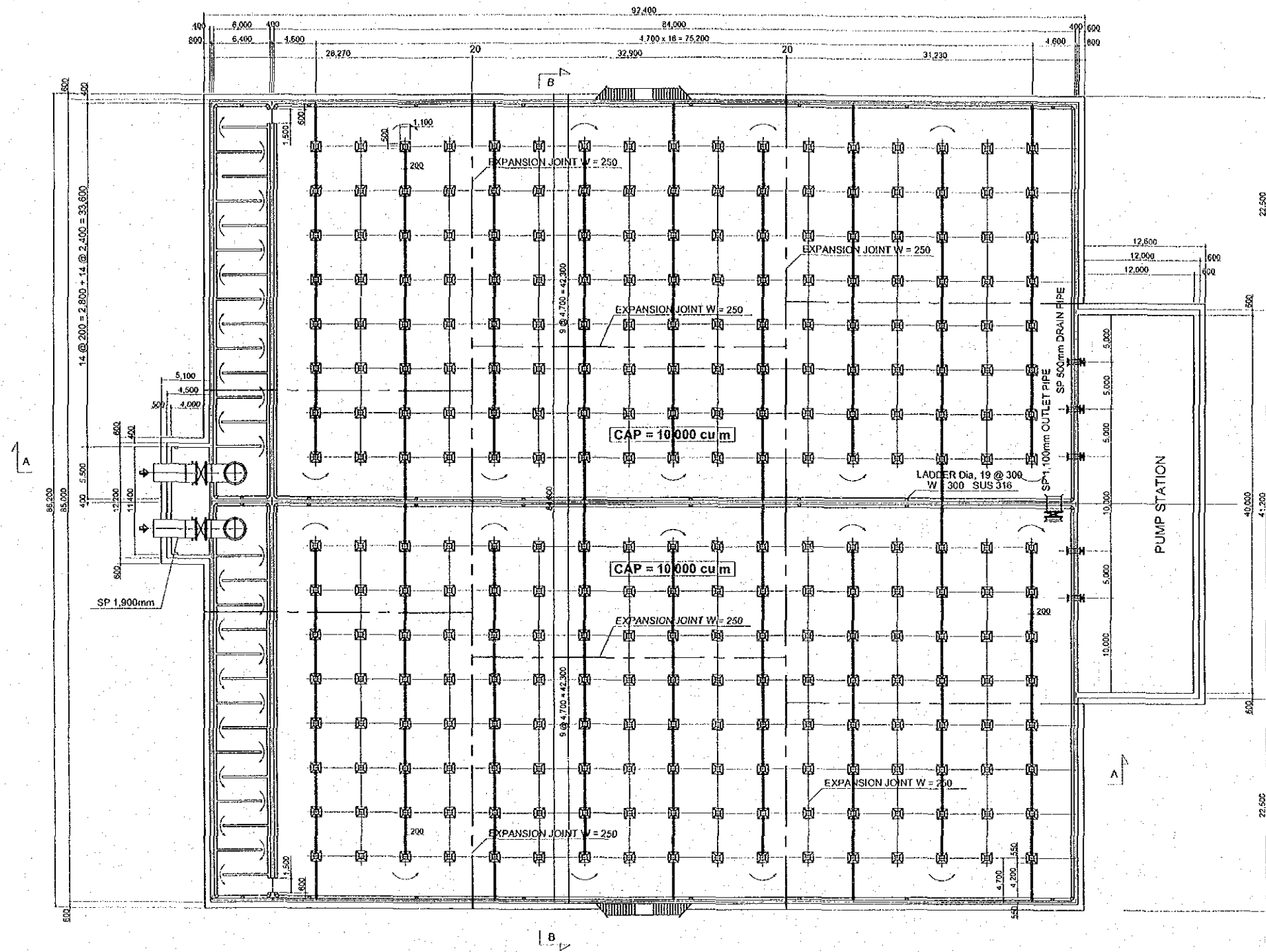

**BOTTOM PLAN**

project	The Study on Improvement of Water Supply System in Yangon City		
Drawing Title	Hlaing WTP Clear Water Reservoir Plan		
Date	Scale	Drawing No.	
August 2002	1 : 500	A - 13	

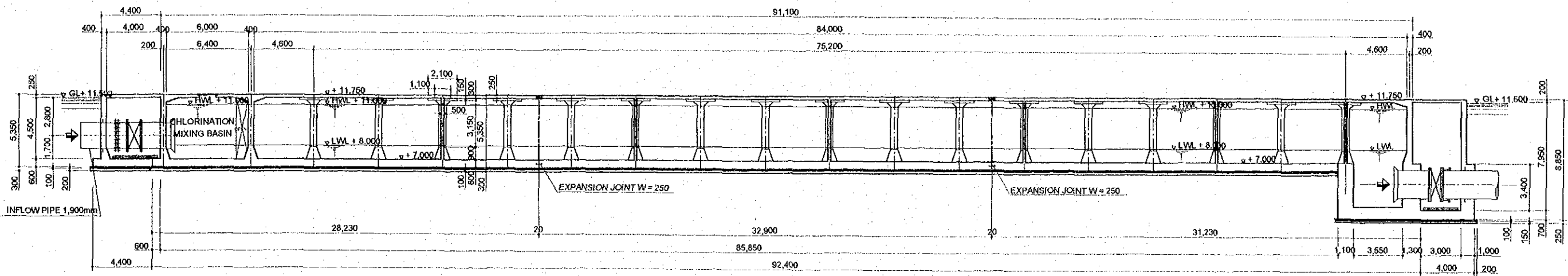

**SECTION A - A**

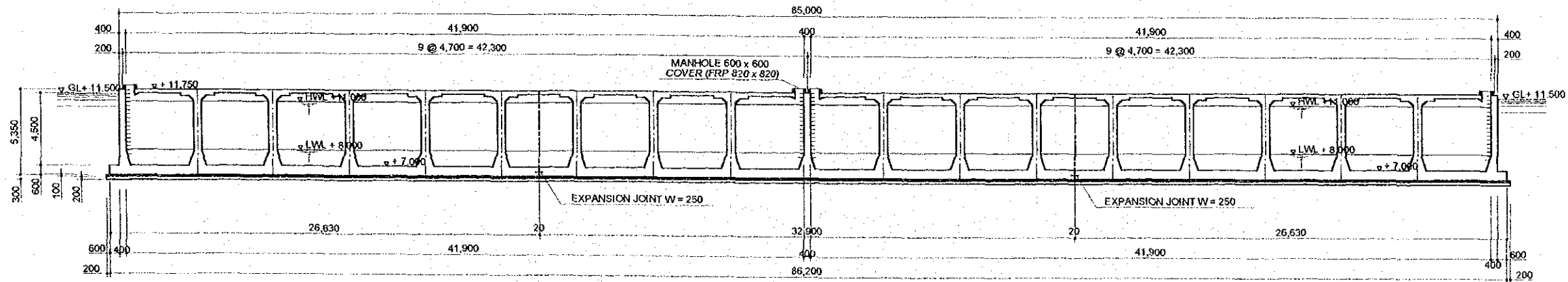

**SECTION B - B**

project	The Study on Improvement of Water Supply System in Yangon City	
Drawing Title	Hlaing WTP Clear Water Reservoir Section A - A, B - B	
Date	Scale	Drawing No.
August 2002	1 : 300	A - 14

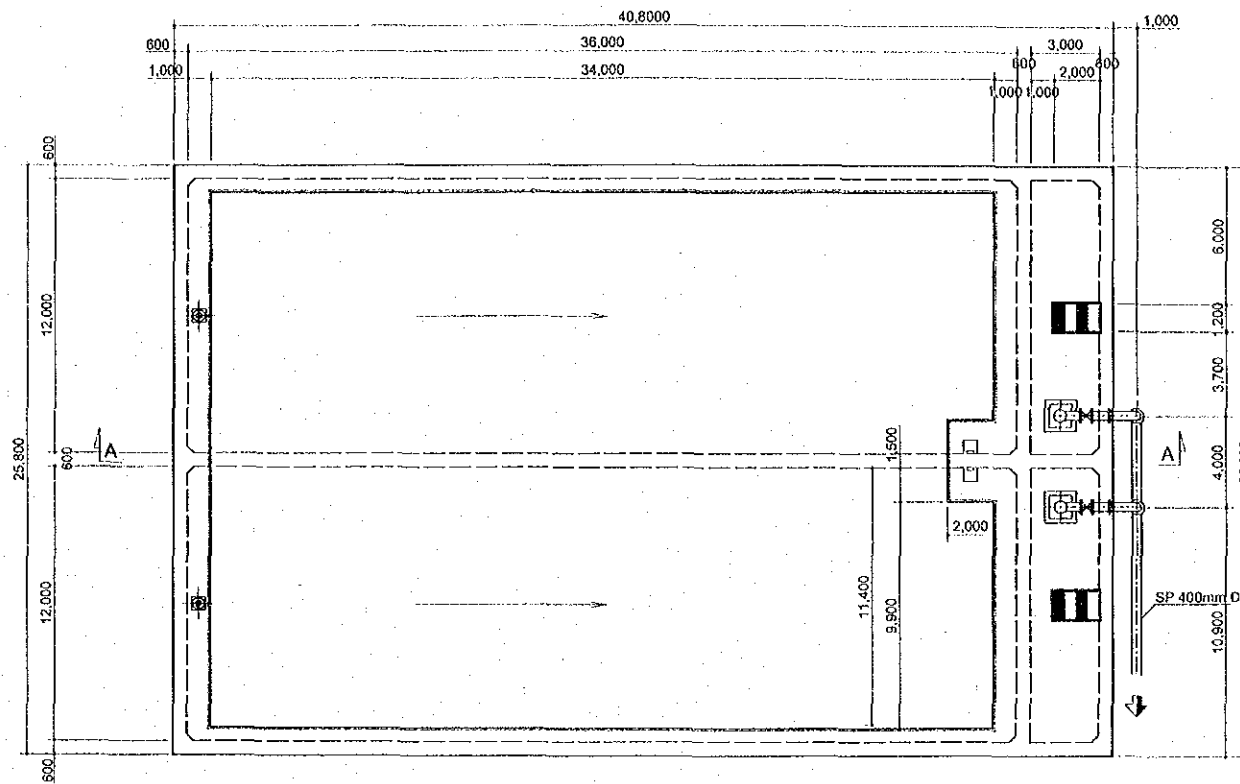

**PLAN**

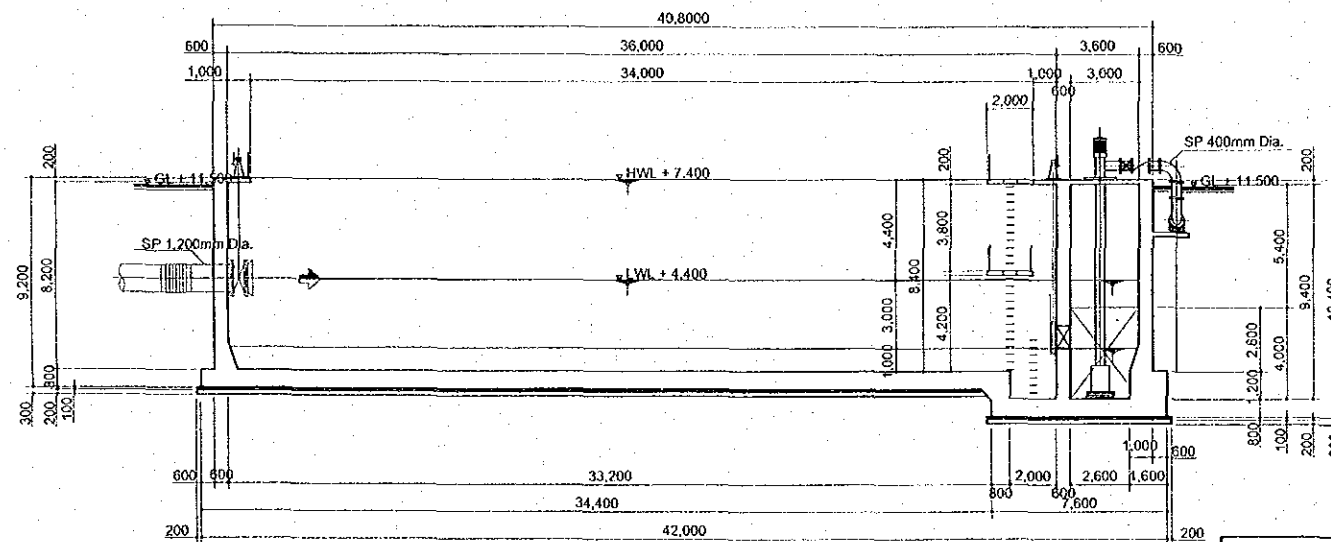

**SECTION A - A**

project	The Study on Improvement of Water Supply System in Yangon City	
Drawing Title	Hlaing WTP Backwashing Storage Basin Plan, Section A - A	
Date	Scale	Drawing No.
August 2002	1 : 300	A - 15

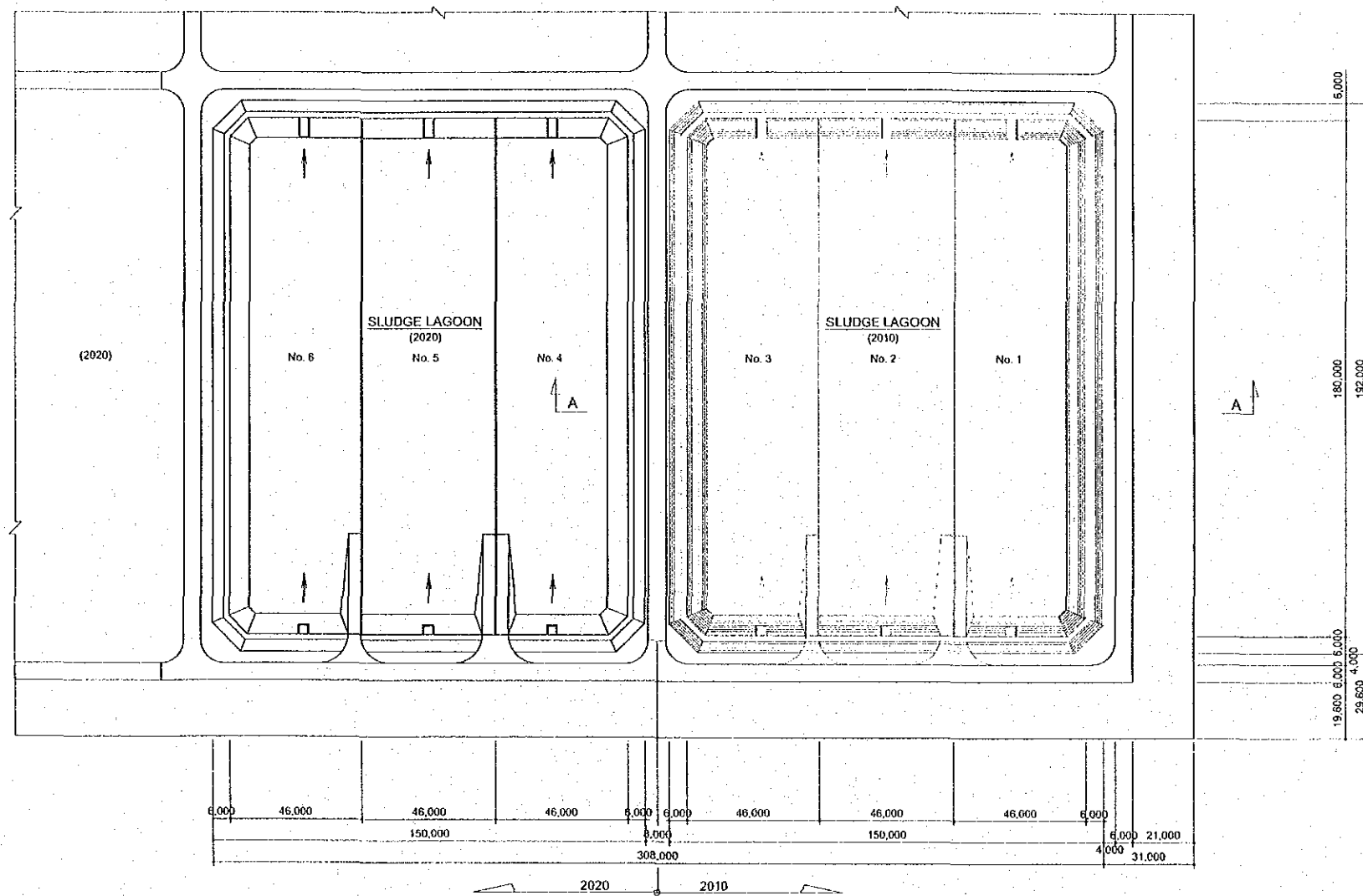

**TOP PLAN**  
SCALE ~ 1 : 2000

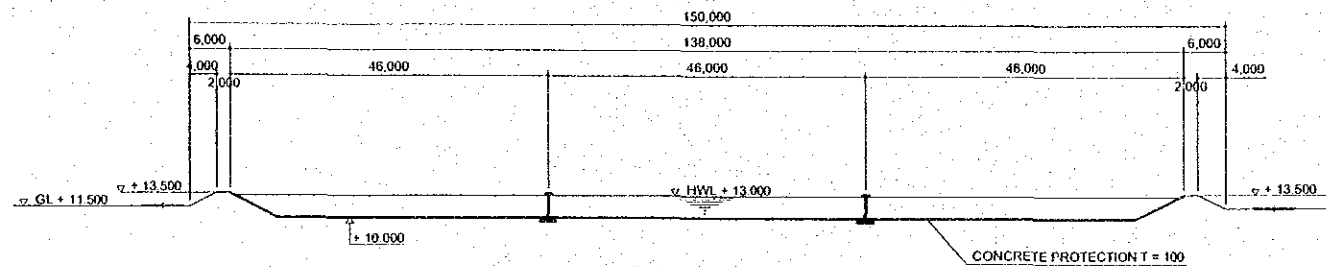

**TOP PLAN**  
SCALE ~ 1 : 1000

Legend

- 2010
- 2020

project	The Study on Improvement of Water Supply System in Yangon City		
Drawing Title	Hlaing WTP Sludge Lagoon		
Date	Scale	Drawing No.	
August 2002	Shown	A - 16	

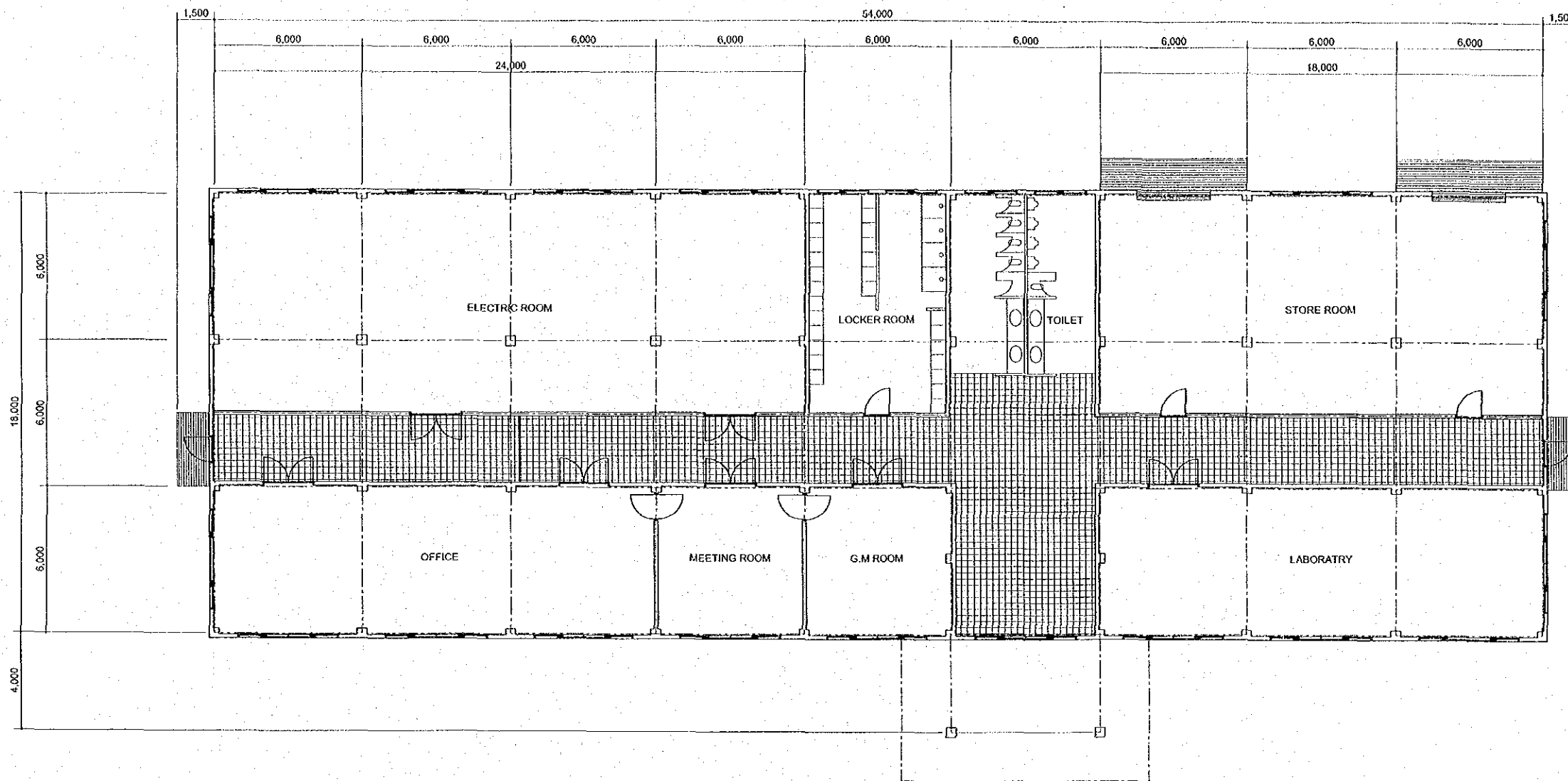

project	The Study on Improvement of Water Supply System in Yangon City		
Drawing Title	Hlaing WTP Administration Building		
Date	Scale	Drawing No.	
August 2002	1 : 200	A - 17	

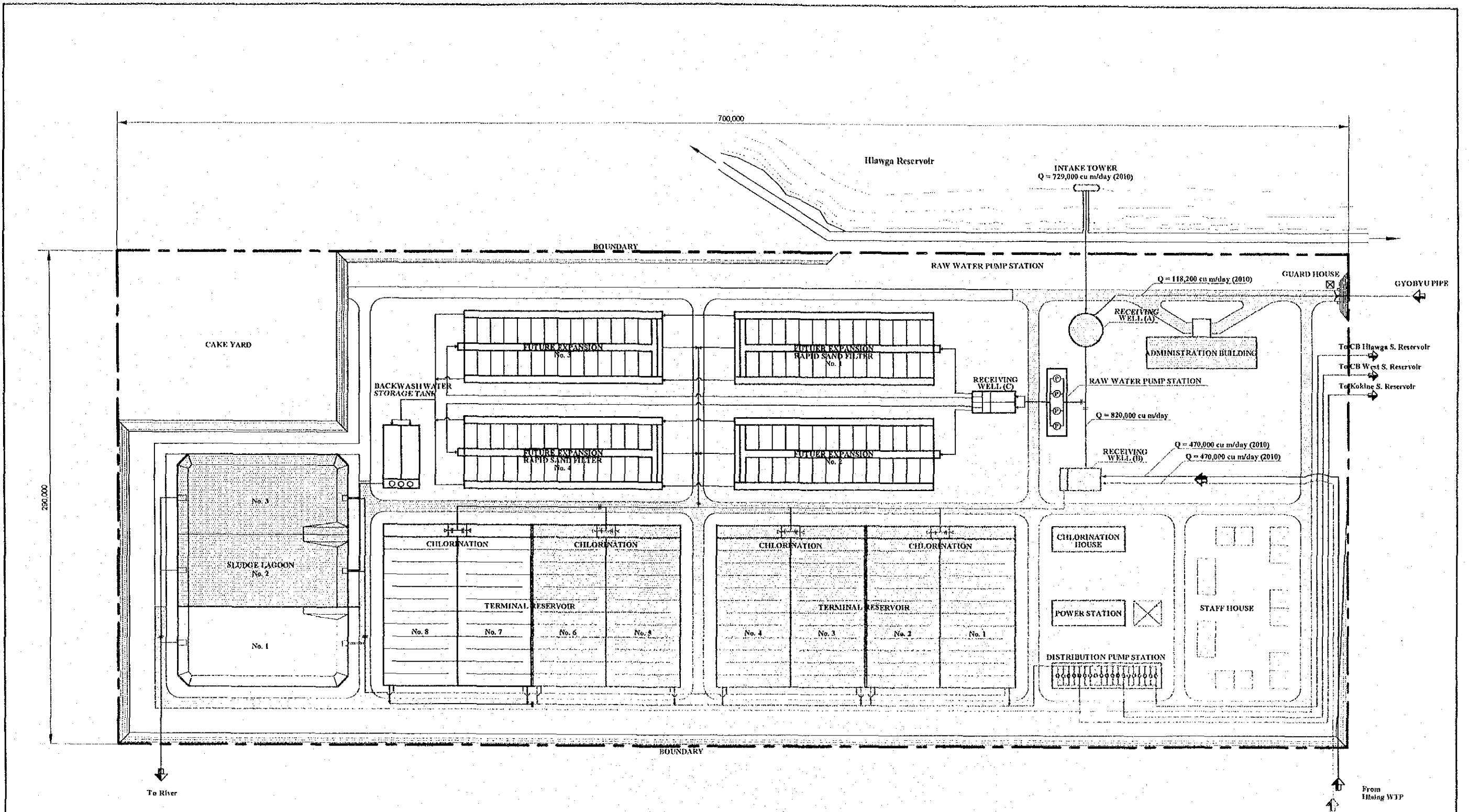

**Hlawga WTP General Plan**  
Not to Scale

**Legend**  
 [Dashed Line] Target Facilities In 2010  
 [Solid Line] Future Expansion

project	The Study on Improvement of Water Supply System in Yangon City		
Drawing Title	Hlawga WTP General Plan		
Date	Scale	Drawing No.	
August 2002	Not to Scale	B - 1	

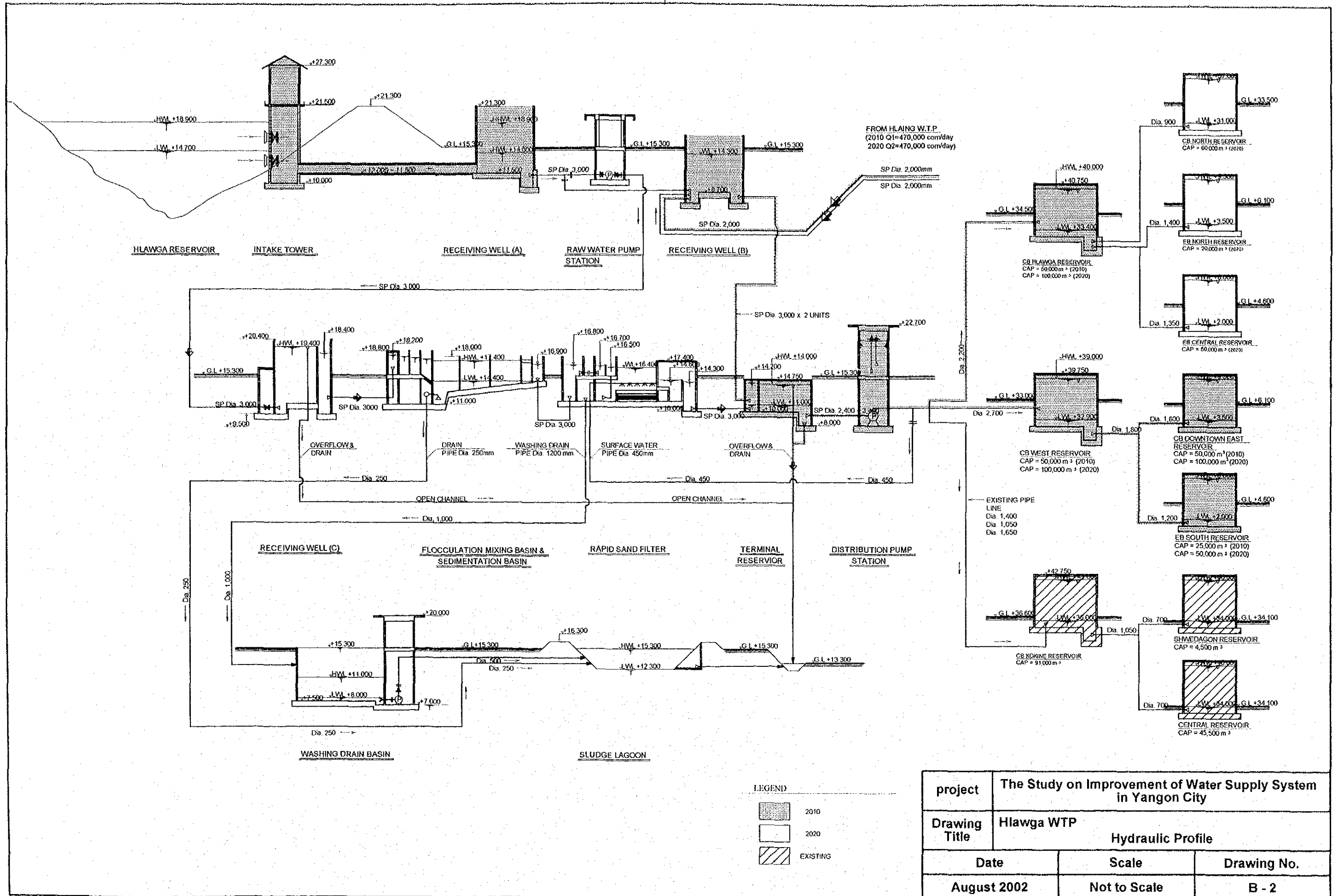



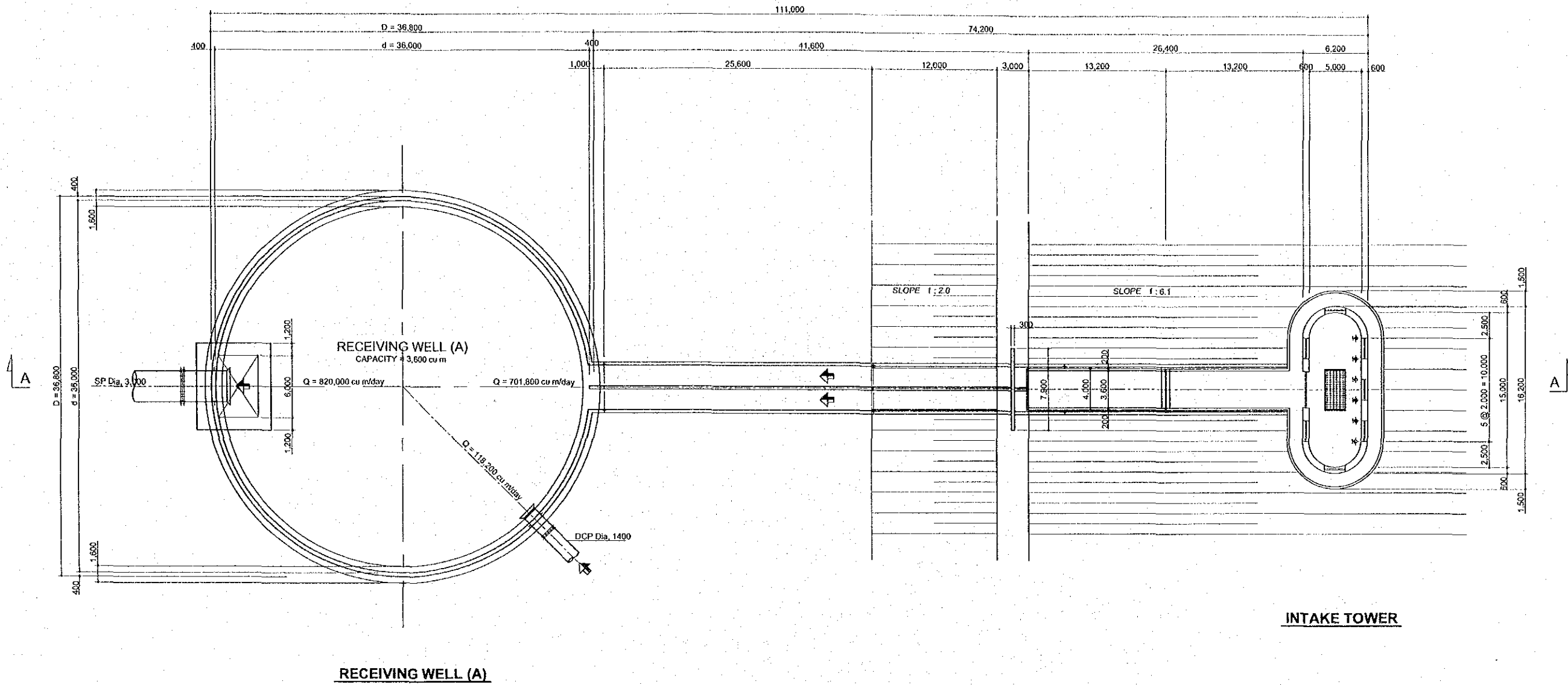

TOP PLAN

project	The Study on Improvement of Water Supply System in Yangon City	
Drawing Title	Hlawga WTP Intake Tower, Receiving Well (A) Plan	
Date	Scale	Drawing No.
August 2002	1 : 400	B - 3

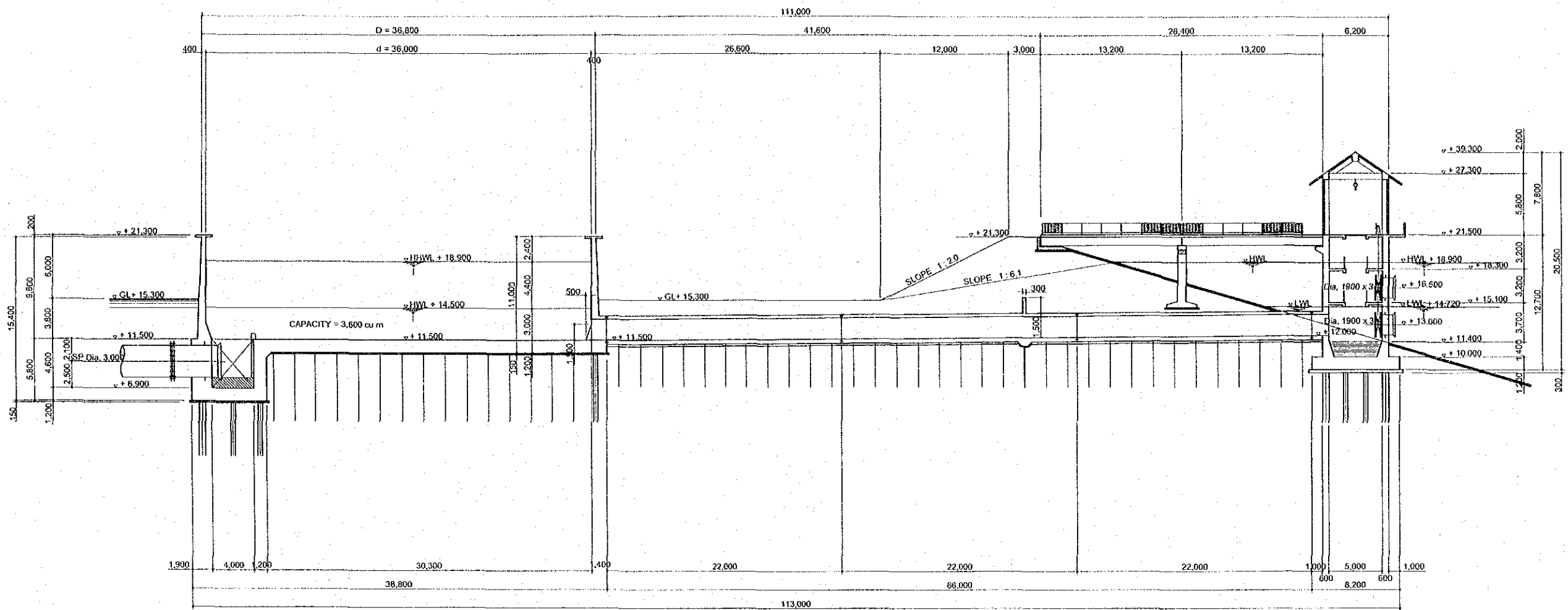

**SECTION A - A**

project	The Study on Improvement of Water Supply System in Yangon City	
Drawing Title	Hlawga WTP Intake Tower, Receiving Well (A) Section A - A	
Date	Scale	Drawing No.
August 2002	1 : 400	B - 4

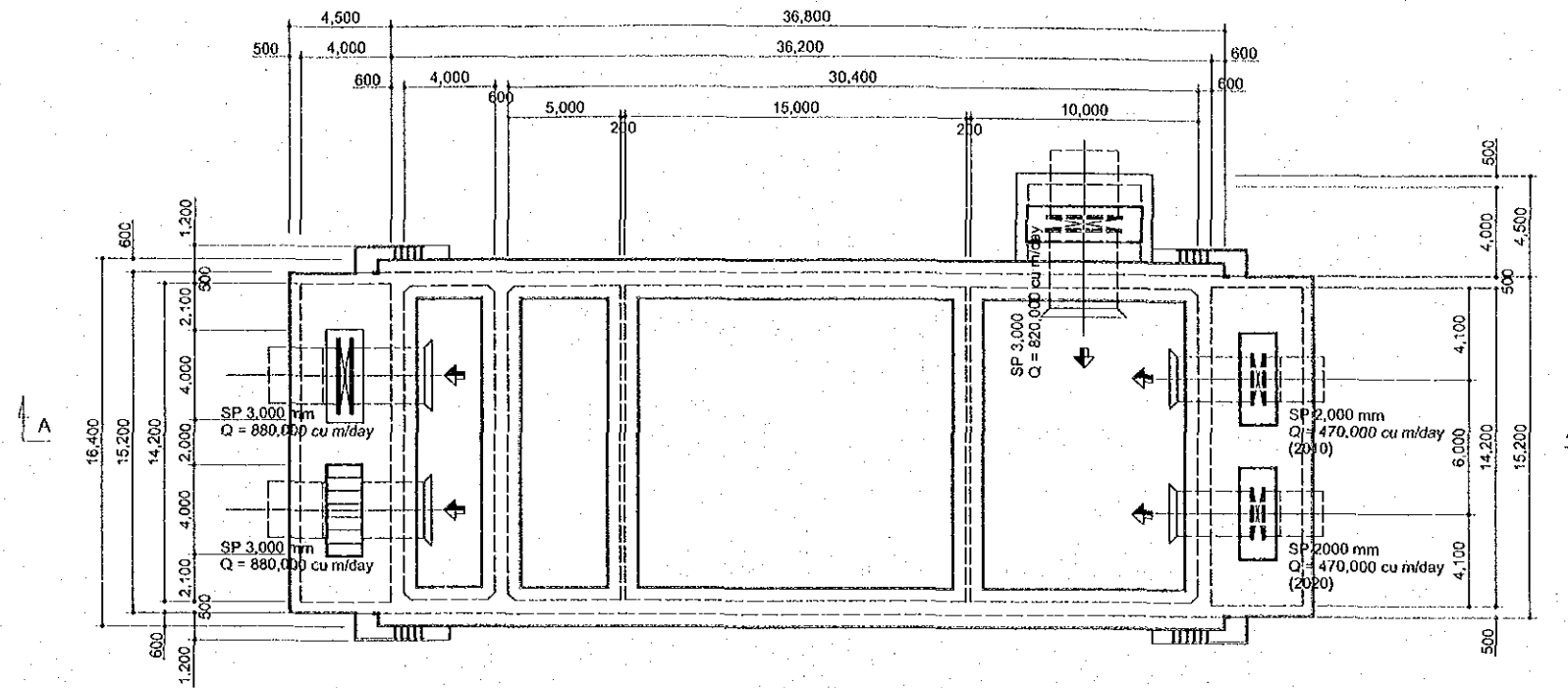

**TOP PLAN**

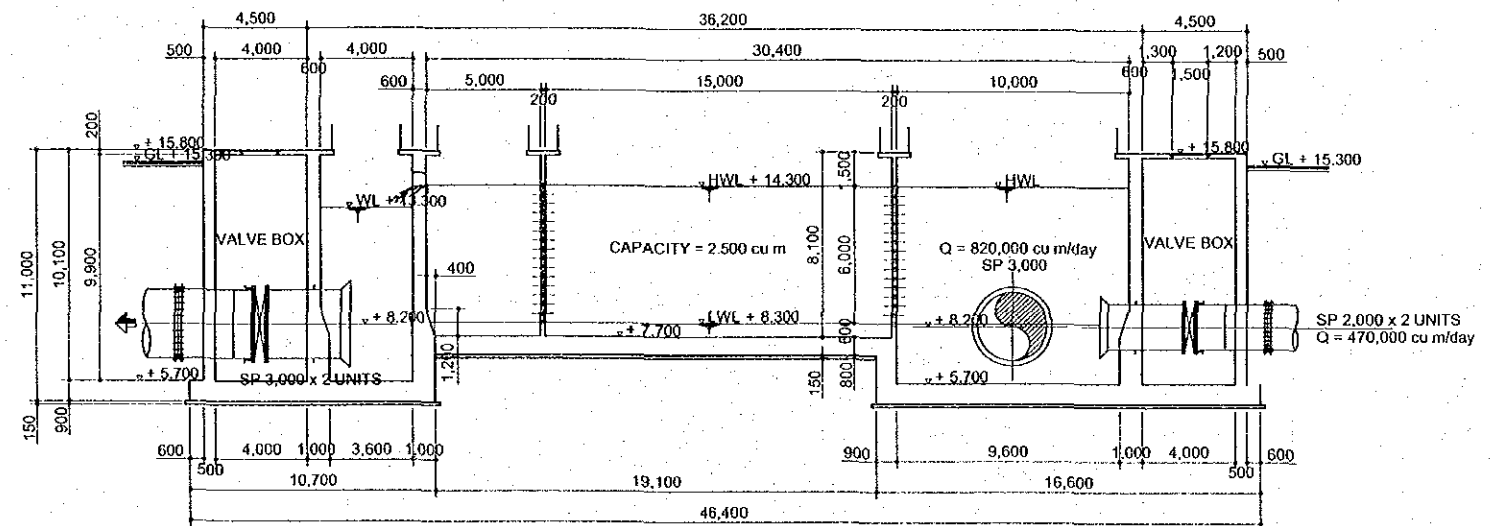

**SECTION A - A**

project	The Study on Improvement of Water Supply System in Yangon City	
Drawing Title	Hiawga WTP Receiving Well (B) Plan, Section A - A	
Date	Scale	Drawing No.
August 2002	1 : 300	B - 5

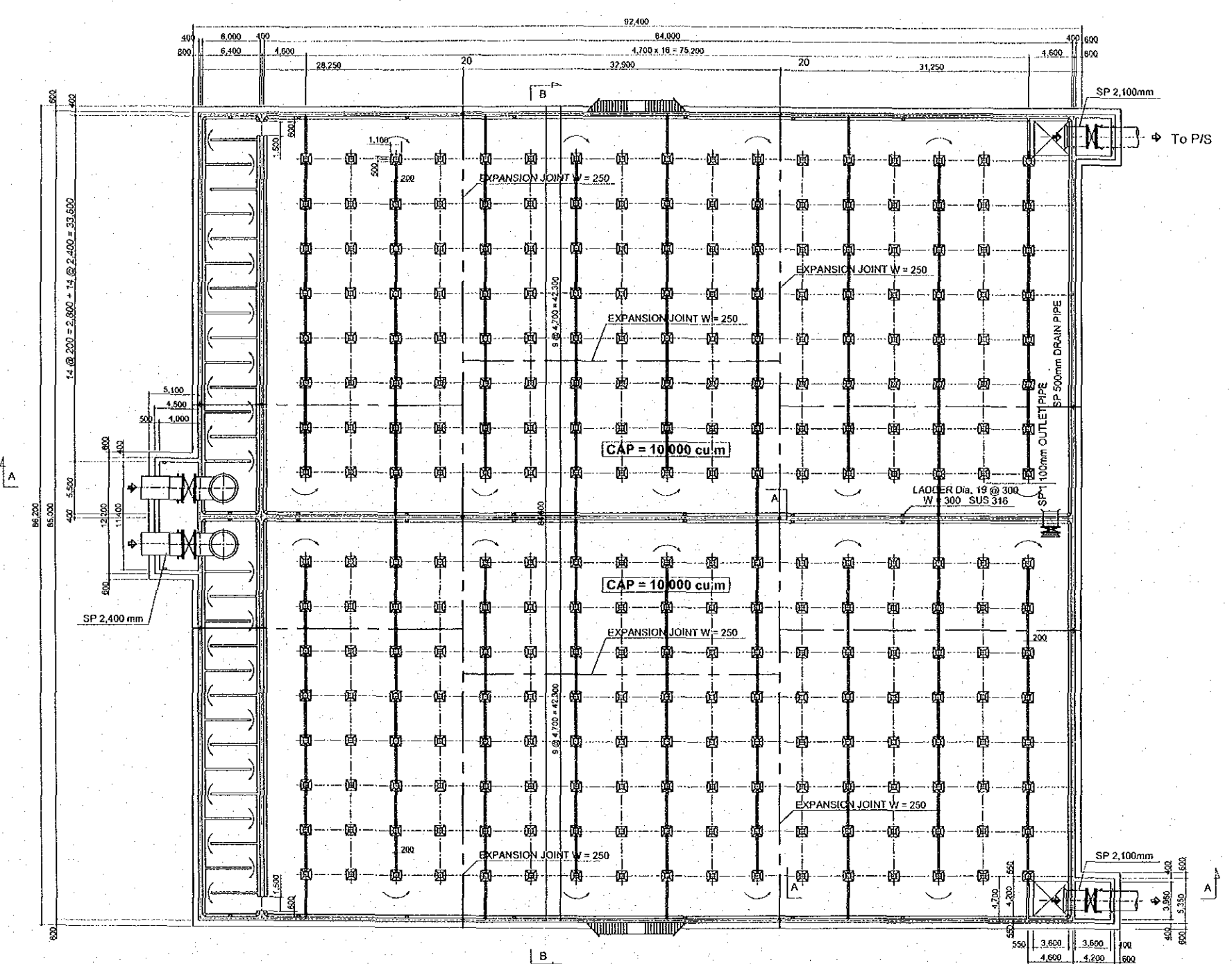

project	The Study on Improvement of Water Supply System in Yangon City		
Drawing Title	Hlawga WTP Terminal Reservoir Plan		
Date	Scale	Drawing No.	
August 2002	1 : 500	B - 6	

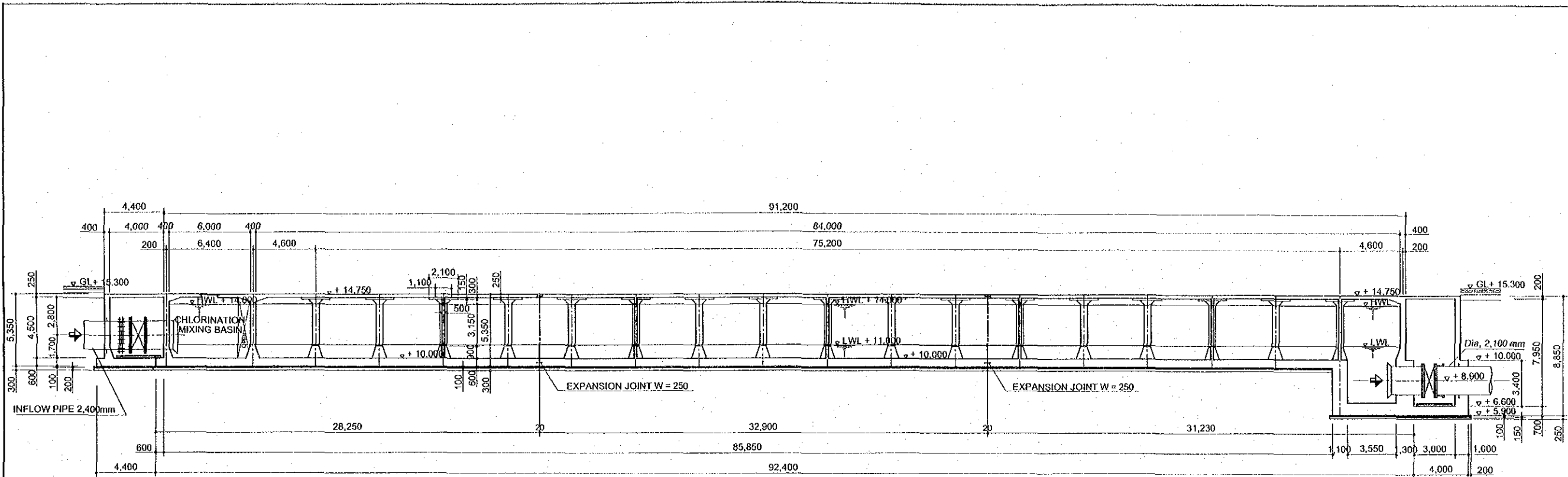

**SECTION A - A**

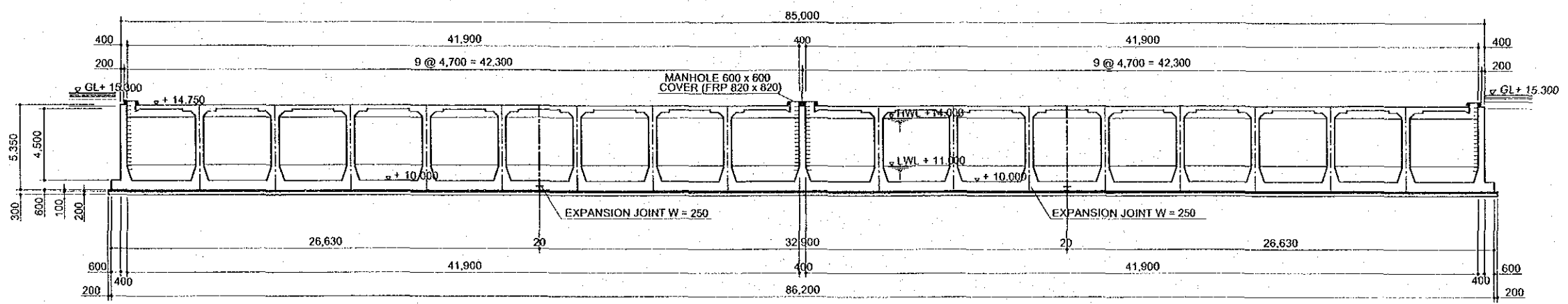

**SECTION B - B**

project	The Study on Improvement of Water Supply System in Yangon City		
Drawing Title	Hlawga WTP Terminal Reservoir Section A -A, B - B		
Date	Scale	Drawing No.	
August 2002	1 : 300	B - 7	

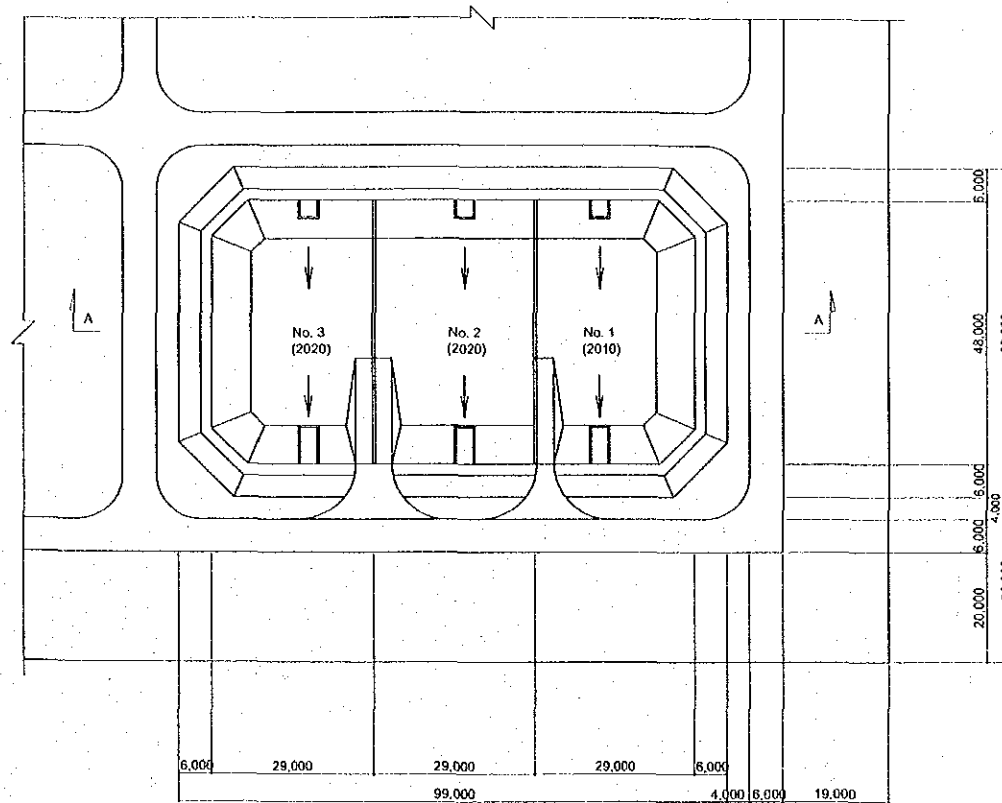

**TOP PLAN**

SCALE ~ 1 : 1250

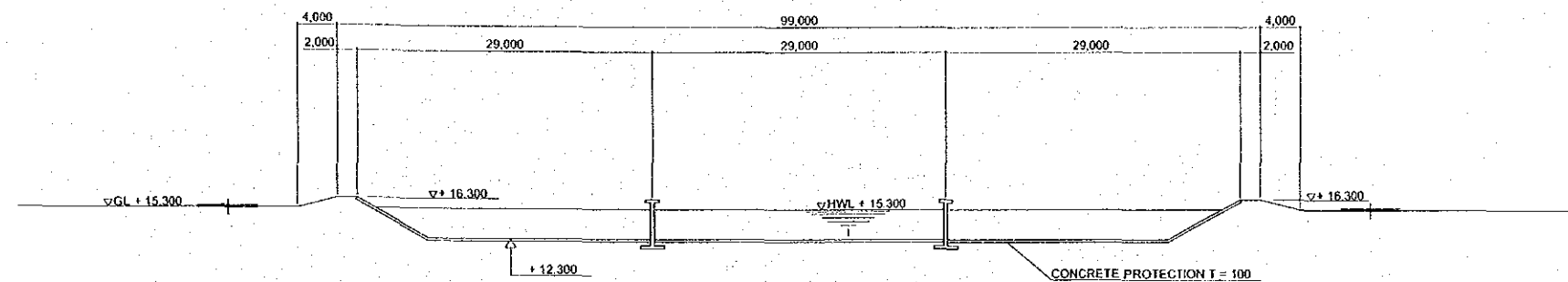

**SECTION A - A**

SCALE ~ 1 : 2500

project	The Study on Improvement of Water Supply System in Yangon City		
Drawing Title	Hlawga WTP Sludge Lagoon Plan, Section A - A		
Date	Scale	Drawing No.	
August 2002	Shown	B - 8	

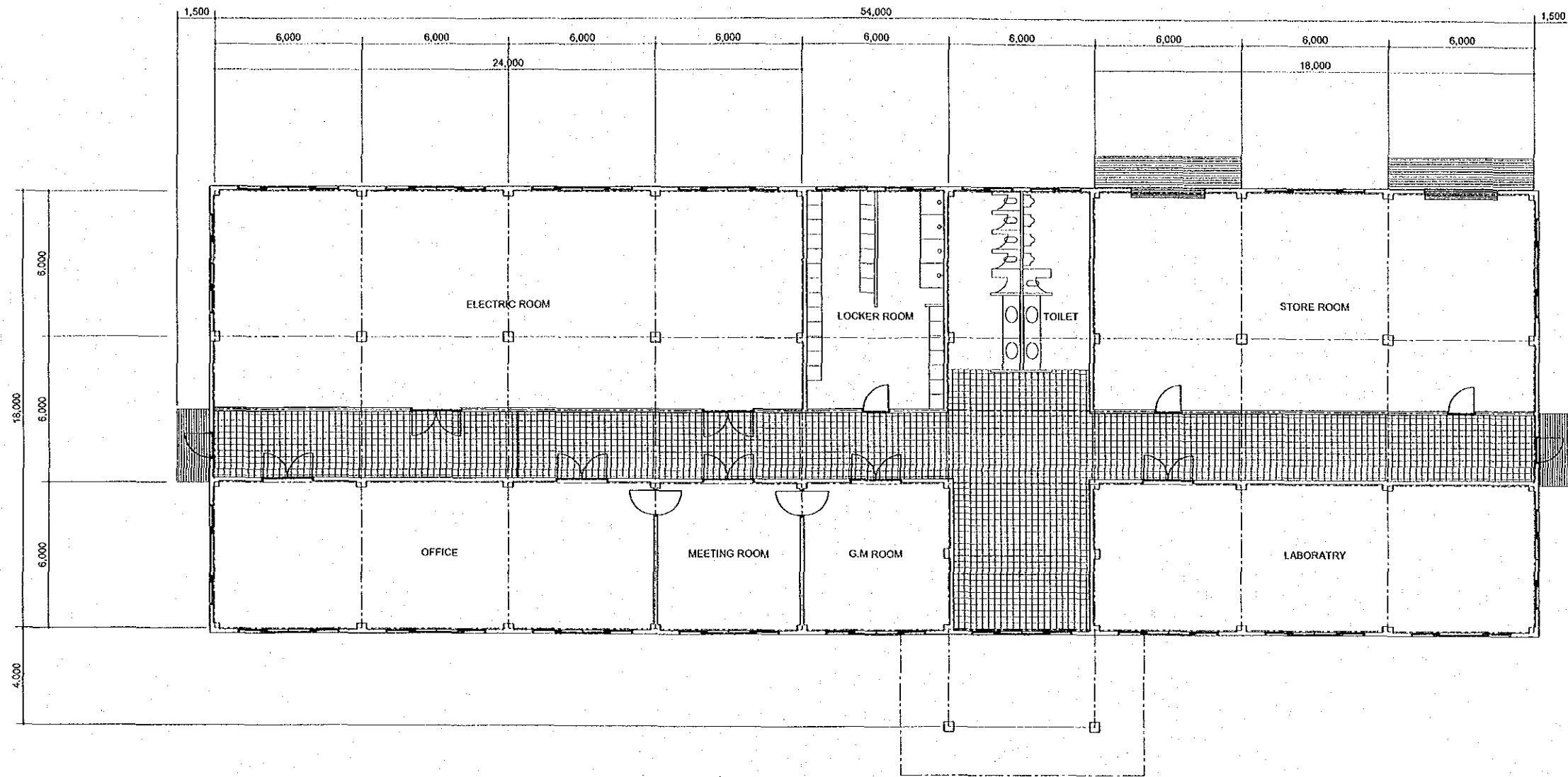

project	The Study on Improvement of Water Supply System in Yangon City	
Drawing Title	Hlawga WTP Administration Building	
Date	Scale	Drawing No.
August 2002	1 : 200	B - 9