

SANITARY APPLIANCES AND TOILET ACCESSORIES

QUANTITY CALCULATION COVER SHEET								
Project	Detailed Design on Port Reactivation Project in La Union Province			Project Code	JC1N004/2N001			
Work Section Title	Plumbing & Sanitary Appliances			Pay Item No. (BOQ)	4E			
Quantity Item	Sanitary & Toilet Appliances			Unit	No.			
<u>Calculation Procedure Applied</u>								
<p>Quantity Calculation was divided per location first and then per pay item.</p> <p>The quantity of each pay item was established by summarizing the number of each item per location.</p>								
<u>References, Calculation Base and Revisions</u>								
<p>Drawing N^o: BD-01-068 to 080 BD-02-030 to 032 BD-03-030 to 033 BD-06-017</p>								
Rev	Prepared		No. of Pages	Checked		Reviewed		Superseded by Calc No.
	by	Date		by	Date	by	Date	
0	H. Iruk	02/07/17	22	D. Endo	17 July, 01	FF	16 July 02	
1	<i>[Signature]</i>							
2								
3								

Project	Detailed Design on Port Reactivation Project in La Union	Calc. File No.	
Section	UTILITY WORK	Calc. Index No.	
Subject	Sanitary Appliances, Plumbing & Toilet Accessories	Page No. 2/22	Rev.

Item	Description	Administration Building										Subtotal
		Count										
4E01	SANITARY APPLIANCES											
4E0101	Water Closet, American Standard model "Hydra"	7	1	4	4	1	4	1	1			23
4E0102	Wash Basin, American Standard model "Sakama"	6	1	2	6	6	1	4	2	1		28
4E0103	Urinal, American Standard model "Avico"	4	3	3	2	2	1					15
4E0104	Metal Sink Type 1, stainless steel, one bowl-one drainboard	1	2									3
4E0105	Metal Sink Type 2, stainless steel, two bowls-two drainboards	1										1
4E0106	Concrete Sink	1										1
4E0107	Service Floor Sink	1	2	2	1	1						7
4E02	PLUMBING ACCESSORIES											
4E0201	Shower, chromium plated bronze head and gate valve	1	1									2
4E0202	Sanitary Cleanout, cast iron body, nickel plated bronze cover, 50mm	1										1
4E0203	Sanitary Cleanout, cast iron body, nickel plated bronze cover, 63mm	1	3	2	1	1						8
4E0204	Sanitary Cleanout, cast iron body, nickel plated bronze cover, 75mm	4	3	4	2	7	4	3				27
4E0205	Sanitary Cleanout, cast iron body, nickel plated bronze cover, 100 mm	2	2	2								6
4E0205	Shower Drain, cast iron body, nickel plated bronze grating, 50 mm	2										2
4E0206	Floor Drain, cast iron body, bronze dome strainer, 75mm	3	1	3	3	3	2					15
4E03	TOILET ACCESSORIES											
4E0301	Shower Curtain Holder	2										2
4E0302	Toilet Tissue Dispenser	7	1	4	4	1	4	1	1			23
4E0303	Hand Drier, electrical, automatic	3	2	3	2	1	1	1				13
4E0304	Grab Bars, stainless steel	2	2	2	2	2						10

Item	Description	Power Station			OFS			MERS			Total	
		Count	Subtotal	Count	Subtotal	Count	Subtotal					
4E01	SANITARY APPLIANCES											
4E0101	Water Closet, American Standard model "Hydra"	1		1	3			3	4		4	31
4E0102	Wash Basin, American Standard model "Sakama"	1		1	2	2		4	5		5	39
4E0103	Urinal, American Standard model "Avico"			0	3			3	3		3	21
4E0104	Metal Sink Type 1, stainless steel, one bowl-one drainboard			0	1			1	0		0	4
4E0105	Metal Sink Type 2, stainless steel, two bowls-two drainboards			0	0			0	0		0	1
4E0106	Concrete Sink			0	0			0	0		0	1
4E0107	Service Floor Sink			0	0			0	0		0	7
4E02	PLUMBING ACCESSORIES											
4E0201	Shower, chromium plated bronze head and gate valve	0		0	2			2	3		3	7
4E0202	Sanitary Cleanout, cast iron body, nickel plated bronze cover, 50mm	0		0	1			1	1		1	3
4E0203	Sanitary Cleanout, cast iron body, nickel plated bronze cover, 63mm	0		0	0			0	2		2	10
4E0204	Sanitary Cleanout, cast iron body, nickel plated bronze cover, 75mm	1		1	3			3	2		2	33
4E0205	Sanitary Cleanout, cast iron body, nickel plated bronze cover, 100 mm	0		0	0			0	0		0	6
4E0205	Shower Drain, cast iron body, nickel plated bronze grating, 50 mm	0		0	2			2	3		3	7
4E0206	Floor Drain, cast iron body, bronze dome strainer, 75mm	1		1	3			3	2		2	21
4E03	TOILET ACCESSORIES											
4E0301	Shower Curtain Holder	2		2	3			3			0	7
4E0302	Toilet Tissue Dispenser	3		3	4			4	1		1	31
4E0303	Hand Drier, electrical, automatic	2		2	2			2	1		1	18
4E0304	Grab Bars, stainless steel			0				0			0	10

Prepared by	Checked by
H. Iruha	S. Endo
02/07/17	17 July, 2017



Project	Detailed Design on Port Reactivation Project In La Union Province of the Republic of El Salvador	Calc. File N°.	
Section:	UTILITY WORK	Calc. Index N°.	
Subject:	SANITARY APPLIANCES, PLUMBING & TOILET ACCESSORIES	Page N°.	3/22

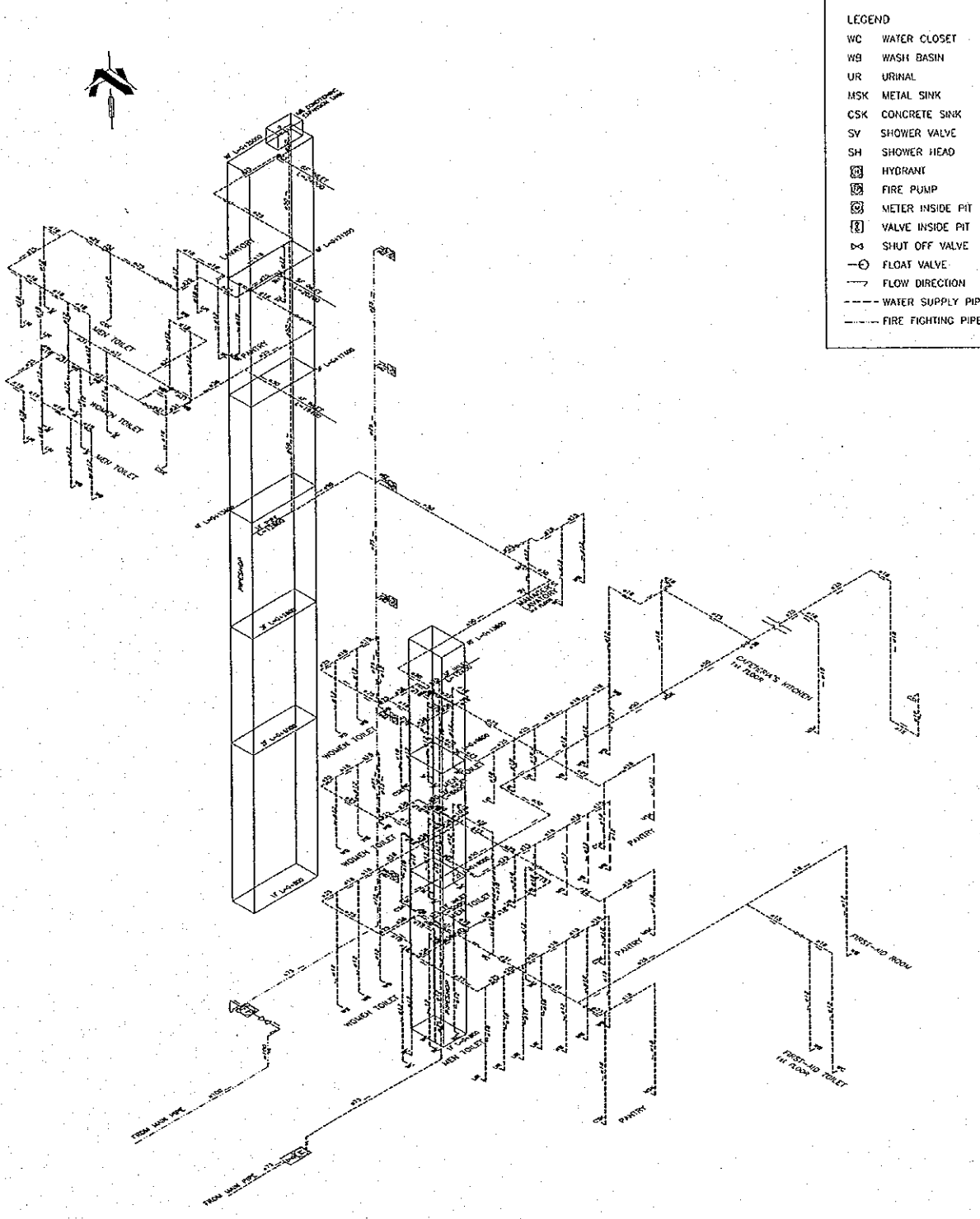

WATER SUPPLY PLUMBING ISOMETRIC
NOT TO SCALE

Prepared by	Checked by
A. Iruw	S. Endo
02/07/17	17 July, 02



Project	Detailed Design on Port Reactivation Project in La Union Province of the Republic of El Salvador	Calc. File N°.	
Section:	UTILITY WORK	Calc. Index N°.	
Subject:	SANITARY APPLIANCES, PLUMBING & TOILET ACCESSORIES	Page N°.	4/22

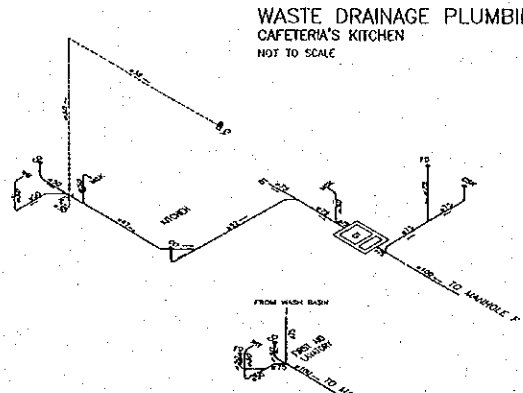
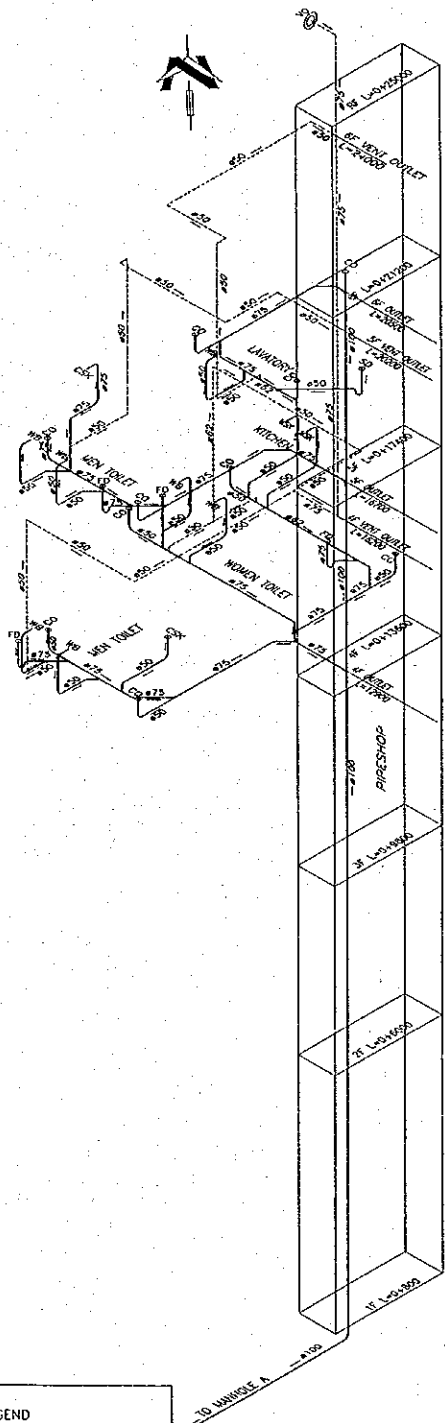

WASTE DRAINAGE PLUMBING ISOMETRIC
CAFETERIA'S KITCHEN
NOT TO SCALE

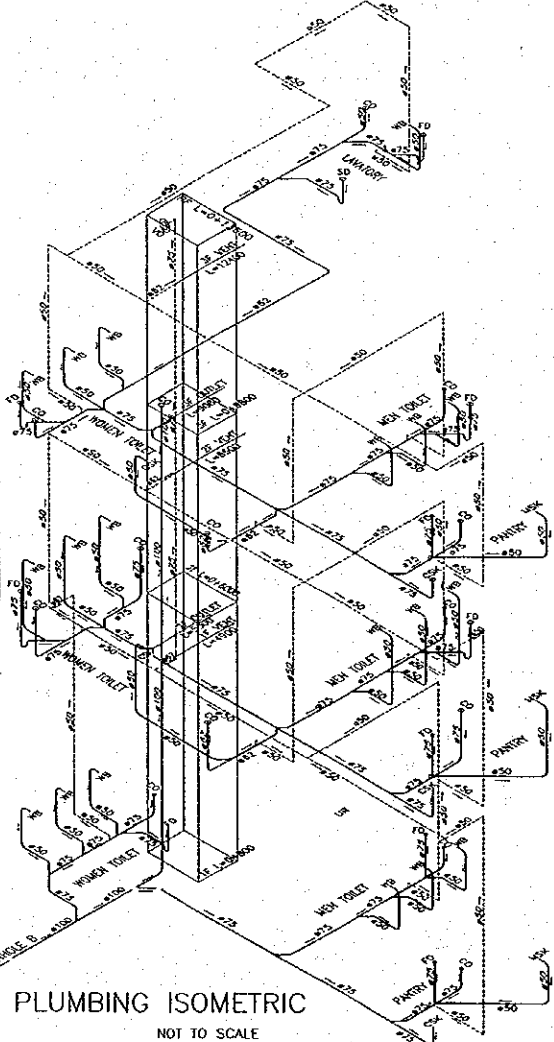

WASTE DRAINAGE PLUMBING ISOMETRIC
GENERAL
NOT TO SCALE

LEGEND	
VO	VENT OULET
CO	CLEAN OUT
WB	WASH BASIN
MSK	METAL SINK
CSK	CONCRETE SINK
FD	FLOOR DRAIN
SD	SHOWER DRAIN
GT	GREASE TRAP
DT	DRAIN TRENCH
TR	TRAP
—	WASTE DRAINAGE PIPE
---	VENT PIPE
→	FLOW DIRECTION

Prepared by		Checked by	
A. Iruke	02/07/17	S. Endo	17 July, 02'



Project	Detailed Design on Port Reactivation Project In La Union Province of the Republic of El Salvador	Calc. File N°.	
Section:	UTILITY WORK	Calc. Index N°.	
Subject:	SANITARY APPLIANCES, PLUMBING & TOILET ACCESSORIES	Page N°.	5/22

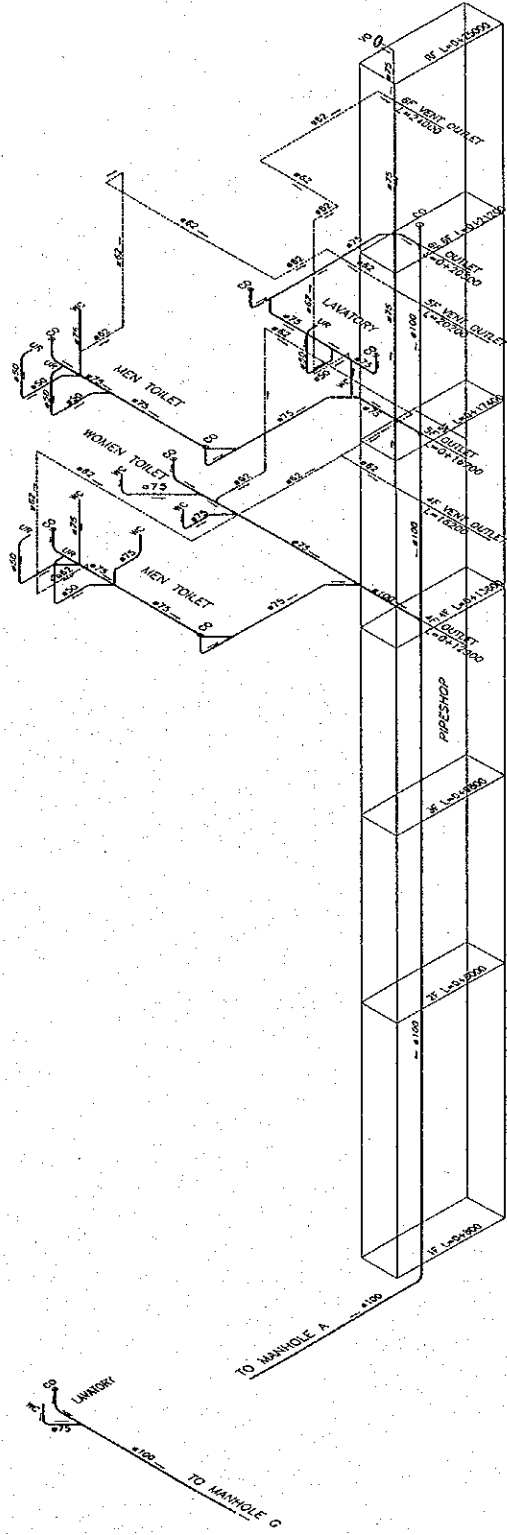

LEGEND

VO	VENT OUTLET
CO	CLEAN OUT
WC	WATER CLOSET
UR	URINAL
—	SANITARY DRAINAGE
—	VENT PIPE
→	FLOW DIRECTION

SANITARY DRAINAGE PLUMBING
ISOMETRIC
GENERAL NOT TO SCALE

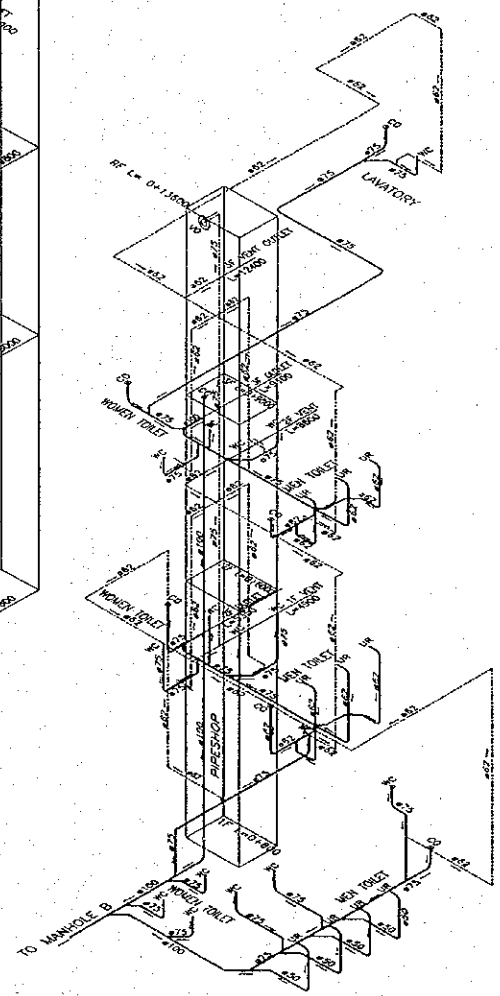

SANITARY DRAINAGE PLUMBING
ISOMETRIC
FIRST-AID LAVATORY NOT TO SCALE

Prepared by	H. Iruw	02/07/17	Checked by	P. Endo	17 July, 02
-------------	---------	----------	------------	---------	-------------



Project	Detailed Design on Port Reactivation Project in La Union Province of the Republic of El Salvador	Calc. File N°.
Section:	UTILITY WORK	Calc. Index N°.
Subject:	SANITARY APPLIANCES, PLUMBING & TOILET ACCESSORIES	Page N°. 6/22

<p>ROOM LIST</p> <ul style="list-style-type: none"> ① CAFETERIA'S KITCHEN ② FIRST AID ROOM ③ FIRST AID LAVATORY ④ PANTRY ⑤ JANITOR'S ROOM ⑥ TOILET (WOMEN) ⑦ TOILET (MEN) 	<p>PLUMBING SYMBOLS</p> <ul style="list-style-type: none"> ○ VERTICAL PIPE DOWN ⊙ VERTICAL PIPE UP ⊗ METER INSIDE PIT ⊗ VALVE INSIDE PIT ⊗ SHUT OFF VALVE ⊗ HOSE FAUCET INSIDE PIT ⊗ CHECK VALVE ⊗ CLEAN OUT ⊗ FIRE PUMP ⊗ GREASE TRAP ⊗ WATER SUPPLY PIPE ⊗ WASTE DRAINAGE ⊗ SANITARY DRAINAGE ⊗ WASTE VENT PIPE ⊗ SANITARY VENT PIPE ⊗ FIRE FIGHTING PIPE 	<p>NOTES</p> <ol style="list-style-type: none"> 1) WASTE AND SANITARY DRAINAGE PIPES TO BE PVC 2) WATER SUPPLY PIPES TO BE PVC 3) FIRE FIGHTING SYSTEM PIPES TO BE GALVANIZED IRON <p>FIRE FIGHTING SYSTEM SYMBOLS</p> <ul style="list-style-type: none"> △ ABC CLASS DRY POWDER EXTINGUISHER △ SC CLASS CO2 EXTINGUISHER △ KITCHEN CLASS EXTINGUISHER △ RECESSED CABINET WITH HOSE RACK AND EXTINGUISHER <p>LEGEND</p> <ul style="list-style-type: none"> c CHARGE h PLACEMENT HEIGHT m LENGTH OF HOSE (meters)
--	---	--

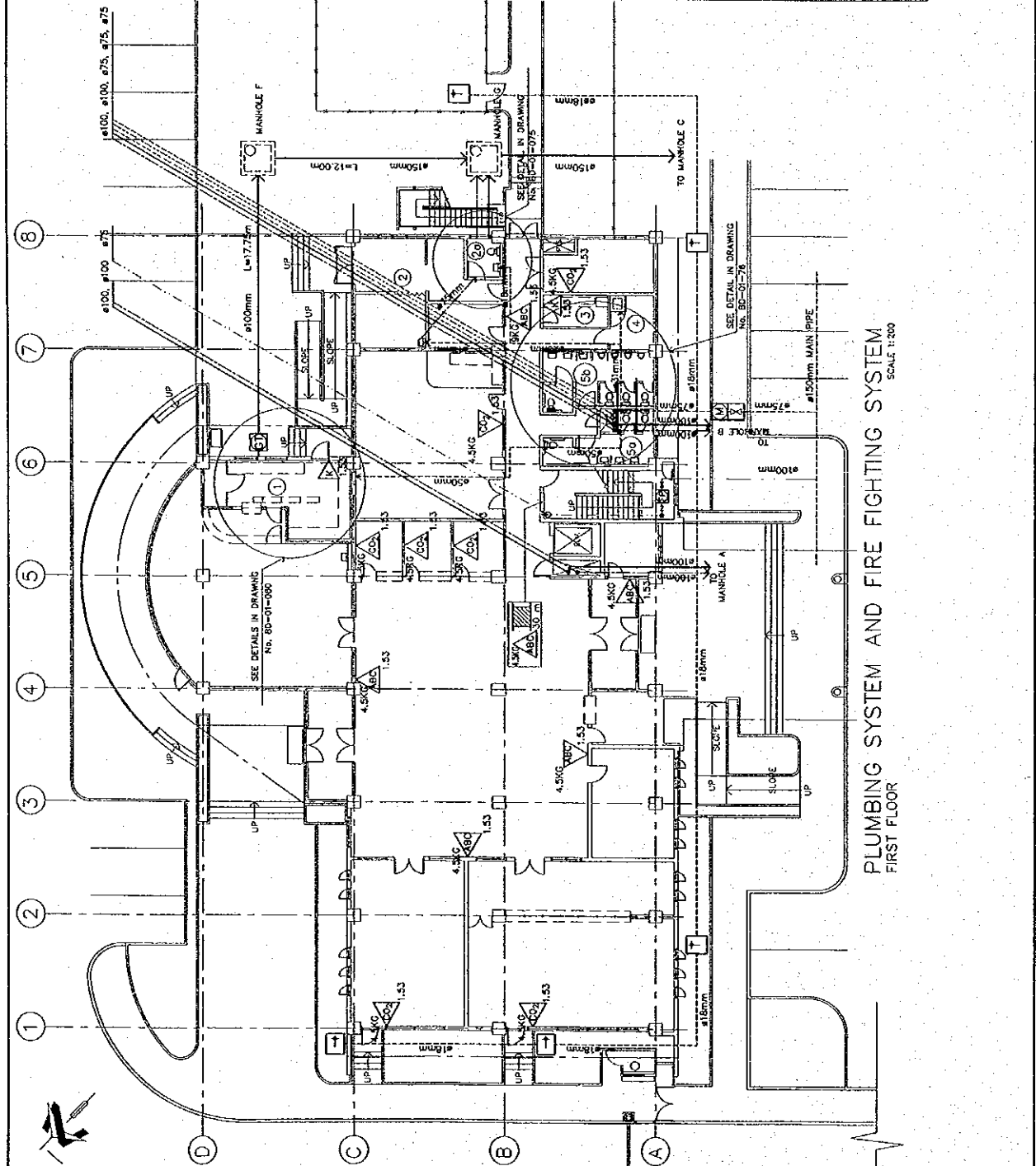

Prepared by	A. Irub	02/07/17	Checked by	S. Endo	17 July, 02
-------------	---------	----------	------------	---------	-------------



Project	Detailed Design on Port Reactivation Project In La Union Province of the Republic of El Salvador	Calc. File N°	
Section:	UTILITY WORK	Calc. Index N°	
Subject:	SANITARY APPLIANCES, PLUMBING & TOILET ACCESSORIES	Page N°	7/22

<p>ROOM LIST</p> <p>① PANTRY</p> <p>② JANITOR'S ROOM</p> <p>③④ TOILET (MEN)</p> <p>⑤⑥ TOILET (WOMEN)</p> <p>⑦ MANAGER'S LAVATORY</p>	<p>PLUMBING SYMBOLS</p> <p>● VERTICAL PIPE DOWN</p> <p>○ VERTICAL PIPE UP</p> <p>⊗ METER INSIDE PIT</p> <p>⊘ VALVE INSIDE PIT</p> <p>⊙ SHUT OFF VALVE</p> <p>⊚ HOSE FAUCET INSIDE PIT</p> <p>⊛ CHECK VALVE</p> <p>⊜ CLEAN OUT</p> <p>⊝ FIRE PUMP</p> <p>⊞ GREASE TRAP</p> <p>⊟ WATER SUPPLY PIPE</p> <p>⊠ WASTE DRAINAGE</p> <p>⊡ SANITARY DRAINAGE</p> <p>⊢ WASTE VENT PIPE</p> <p>⊣ SANITARY VENT PIPE</p> <p>⊤ FIRE FIGHTING PIPE</p>	<p>NOTES</p> <p>1) WASTE AND SANITARY DRAINAGE PIPES TO BE PVC</p> <p>2) WATER SUPPLY PIPES TO BE PVC</p> <p>3) FIRE FIGHTING SYSTEM PIPES TO BE GALVANIZED IRON</p>	<p>FIRE FIGHTING SYSTEM SYMBOLS</p> <p>△ ABC CLASS DRY POWDER EXTINGUISHER</p> <p>△ SC CLASS CO2 EXTINGUISHER</p> <p>△ KITCHEN CLASS EXTINGUISHER</p> <p>△ RECESSED CABINET WITH HOSE RACK AND EXTINGUISHER</p> <p>LEGEND</p> <p>c CHARGE</p> <p>h PLACEMENT HEIGHT</p> <p>m LENGTH OF HOSE (meters)</p>
--	--	--	--

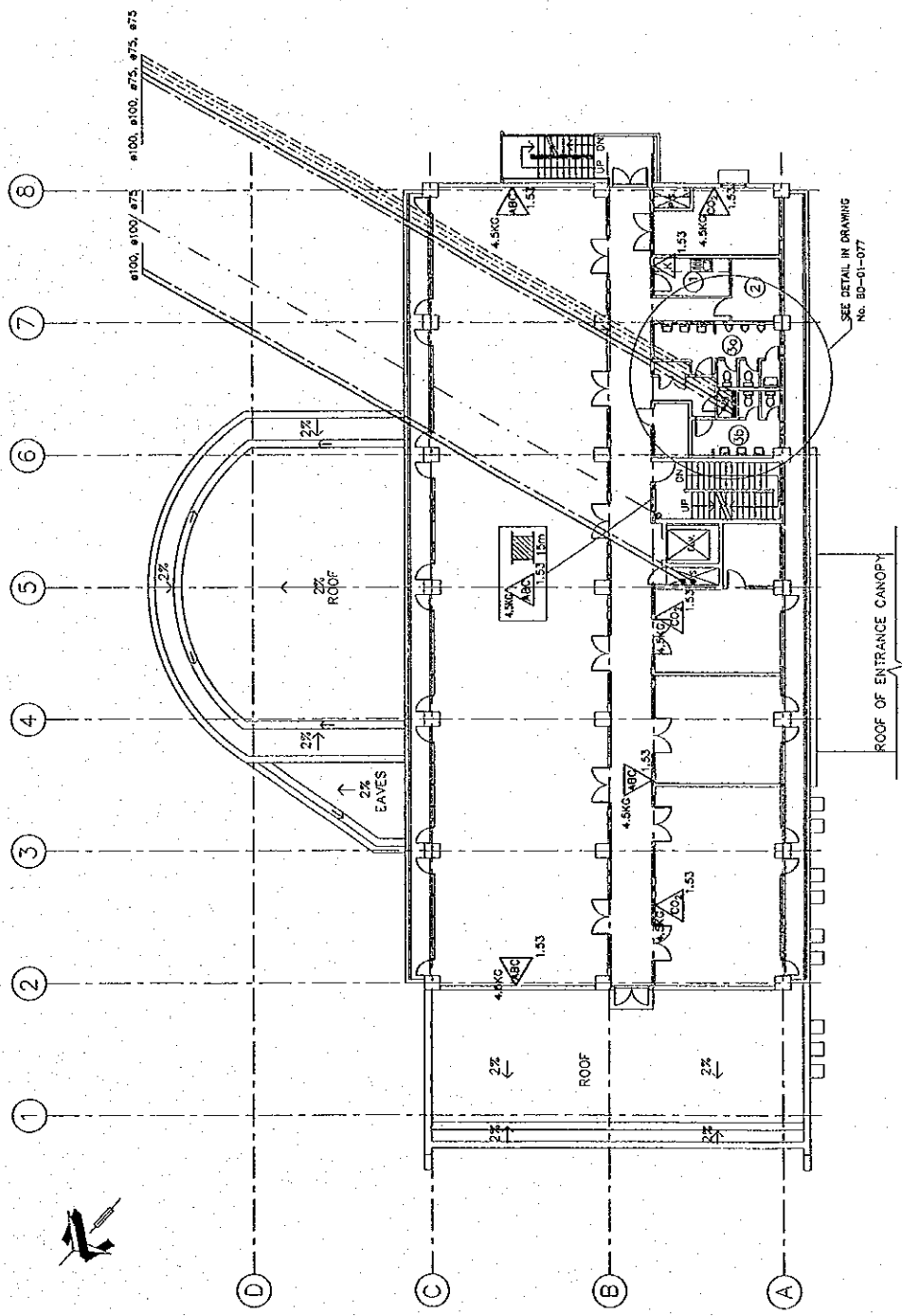

PLUMBING SYSTEM AND FIRE FIGHTING SYSTEM
SECOND FLOOR
SCALE 1:200

Prepared by	A. Iruva	02/07/17	Checked by	S. Endo	17 July, 2017
-------------	----------	----------	------------	---------	---------------



Project	Detailed Design on Port Reactivation Project In La Union Province of the Republic of El Salvador	Calc. File N°.	
Section:	UTILITY WORK	Calc. Index N°.	
Subject:	SANITARY APPLIANCES, PLUMBING & TOILET ACCESSORIES	Page N°.	8/22

<p>ROOM LIST</p> <p>① PANTRY</p> <p>② JANITOR'S ROOM</p> <p>③ TOILET (MEN)</p> <p>④ TOILET (WOMEN)</p> <p>⑤ MANAGER'S LAVATORY</p>	<p>PLUMBING SYMBOLS</p> <p>VERTICAL PIPE DOWN</p> <p>VERTICAL PIPE UP</p> <p>METER INSIDE PIT</p> <p>VALVE INSIDE PIT</p> <p>SHUT OFF VALVE</p> <p>HOSE FAUCET INSIDE PIT</p> <p>CHECK VALVE</p> <p>CLEAN OUT</p> <p>FIRE PUMP</p> <p>GREASE TRAP</p> <p>WATER SUPPLY PIPE</p> <p>WASTE DRAINAGE</p> <p>SANITARY DRAINAGE</p> <p>WASTE VENT PIPE</p> <p>SANITARY VENT PIPE</p> <p>FIRE FIGHTING PIPE</p>	<p>NOTES</p> <p>1) WASTE AND SANITARY DRAINAGE PIPES TO BE PVC</p> <p>2) WATER SUPPLY PIPES TO BE PVC</p> <p>3) FIRE FIGHTING SYSTEM PIPES TO BE GALVANIZED IRON</p> <p>FIRE FIGHTING SYSTEM SYMBOLS</p> <p>ABC CLASS DRY POWDER EXTINGUISHER</p> <p>BC CLASS CO2 EXTINGUISHER</p> <p>KITCHEN CLASS EXTINGUISHER</p> <p>RECESSED CABINET WITH HOSE RACK AND EXTINGUISHER</p> <p>LEGEND</p> <p>c CHARGE</p> <p>h PLACEMENT HEIGHT</p> <p>m LENGTH OF HOSE (meters)</p>
--	---	---

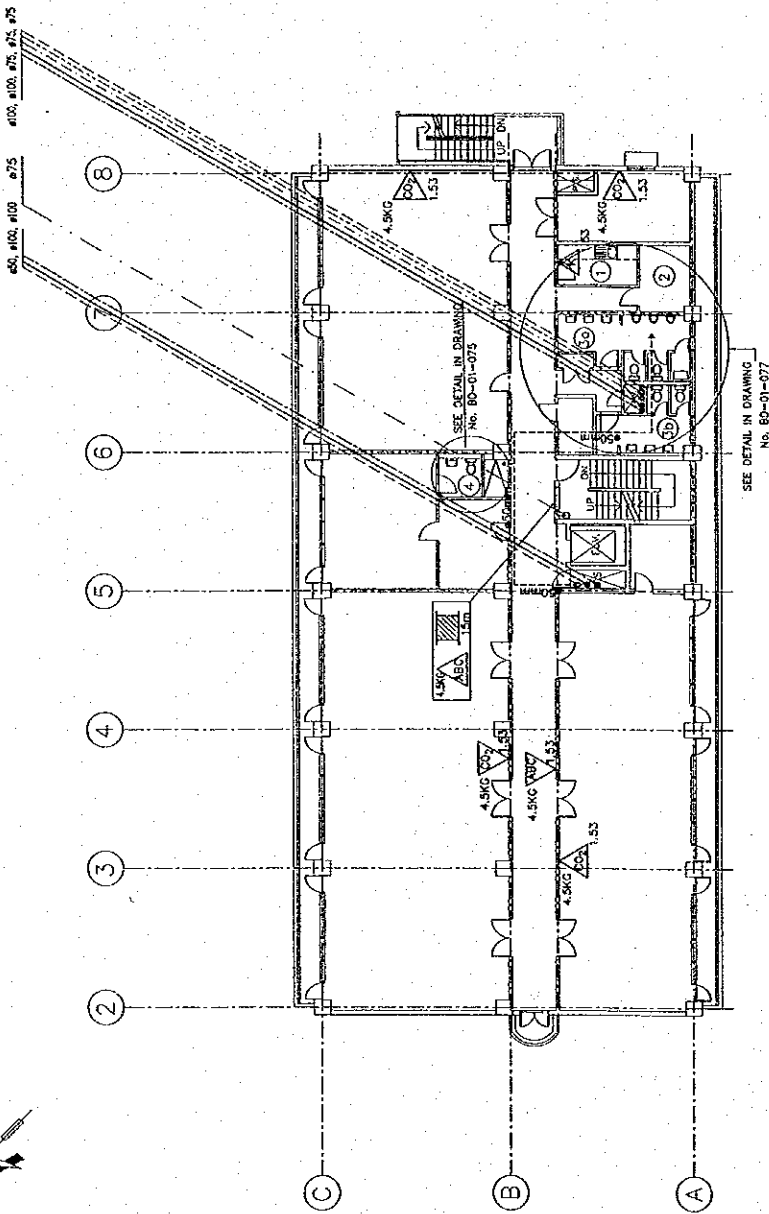

PLUMBING SYSTEM AND FIRE FIGHTING SYSTEM
THIRD FLOOR
SCALE 1:200

Prepared by	H. Iruja	02/07/77	Checked by	P. Endo	17 July, 1977
-------------	----------	----------	------------	---------	---------------



Project	Detailed Design on Port Reactivation Project in La Union Province of the Republic of El Salvador	Calc. File No.	
Section:	UTILITY WORK	Calc. Index No.	
Subject:	SANITARY APPLIANCES, PLUMBING & TOILET ACCESSORIES	Page No.	9/22

ROOM LIST Pantry TOILET (MEN) TOILET (WOMEN)	PLUMBING SYMBOLS VERTICAL PIPE DOWN VERTICAL PIPE UP METER INSIDE PIT VALVE INSIDE PIT SHUT OFF VALVE HOSE FAUCET INSIDE PIT CHECK VALVE CLEAN OUT FIRE PUMP GREASE TRAP WATER SUPPLY PIPE WASTE DRAINAGE SANITARY DRAINAGE WASTE VENT PIPE SANITARY VENT PIPE FIRE FIGHTING PIPE	NOTES 1) WASTE AND SANITARY DRAINAGE PIPES TO BE PVC 2) WATER SUPPLY PIPES TO BE PVC 3) FIRE FIGHTING SYSTEM PIPES TO BE GALVANIZED IRON	FIRE FIGHTING SYSTEM SYMBOLS ABC CLASS DRY POWDER EXTINGUISHER BC CLASS CO2 EXTINGUISHER KITCHEN CLASS EXTINGUISHER RECESSED CABINET WITH HOSE RACK AND EXTINGUISHER LEGEND c CHARGE h PLACEMENT HEIGHT m LENGTH OF HOSE (meters)
---	---	---	---

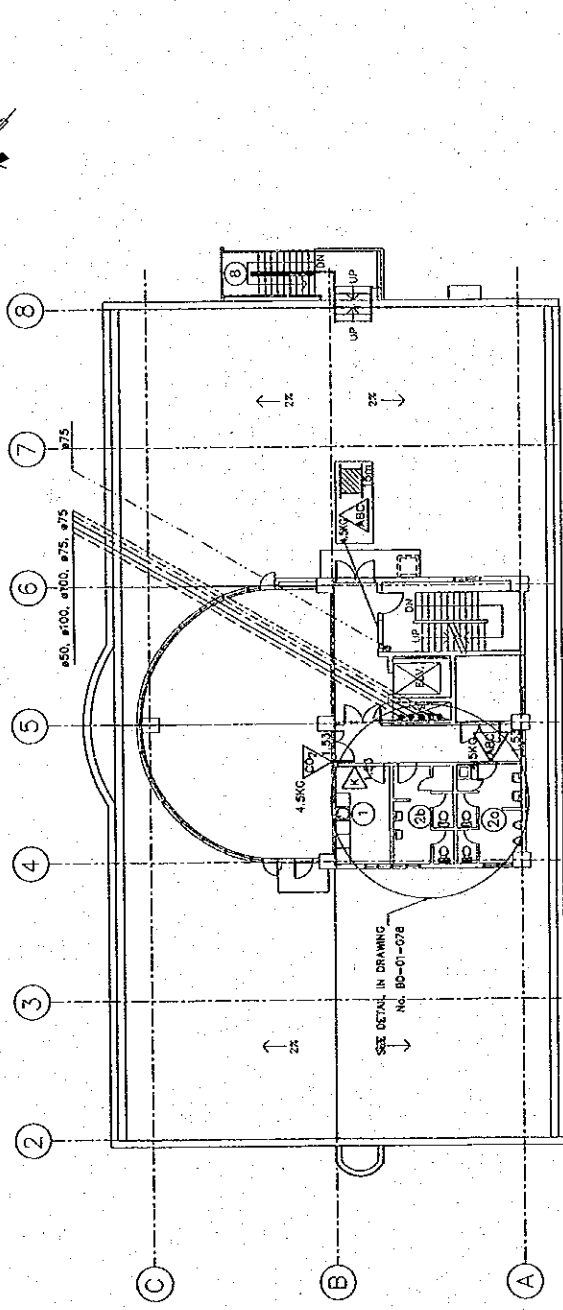

PLUMBING SYSTEM AND FIRE FIGHTING SYSTEM
FOURTH FLOOR
SCALE 1:200

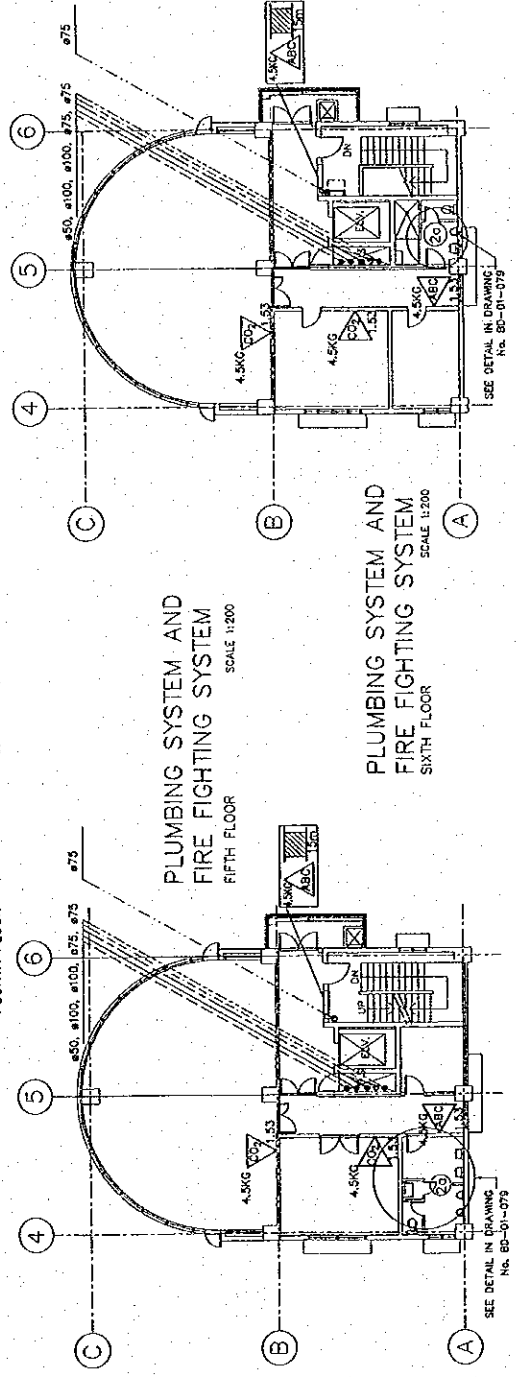

PLUMBING SYSTEM AND FIRE FIGHTING SYSTEM
FIFTH FLOOR
SCALE 1:200

PLUMBING SYSTEM AND FIRE FIGHTING SYSTEM
SIXTH FLOOR
SCALE 1:200

Prepared by	H. Iruka	02/02/17	Checked by	S. Endo	17 July 2017
-------------	----------	----------	------------	---------	--------------



Project	Detailed Design on Port Reactivation Project In La Union Province of the Republic of El Salvador	Calc. File N°.
Section:	UTILITY WORK	Calc. Index N°.
Subject:	SANITARY APPLIANCES, PLUMBING & TOILET ACCESSORIES	Page N°. 11/22



PLUMBING SYMBOLS

●	○	⊠	Z	∞	⊞	T	⌒	---	----
VERTICAL PIPE DOWN	VERTICAL PIPE UP	METER INSIDE PIT	CHECK VALVE	SHUT OFF VALVE	FLOOR / SHOWER DRAIN	CLEAN OUT	TRAP	WATER SUPPLY PIPE (AT CEILING LEVEL)	WASTE DRAINAGE PIPE (UNDER SLAB LEVEL)
								WASTE VENTILATION PIPE (AT CEILING LEVEL)	SANITARY DRAINAGE PIPE (UNDER SLAB LEVEL)
								SANITARY DRAINAGE VENTILATION PIPE (AT CEILING LEVEL)	

NOTES

- 1) SANITARY AND WASTE DRAINAGE PIPES TO BE PVC
- 2) WATER SUPPLY PIPES TO BE PVC
- 3) FIRE FIGHTING SYSTEM PIPES TO BE GALVANIZED IRON

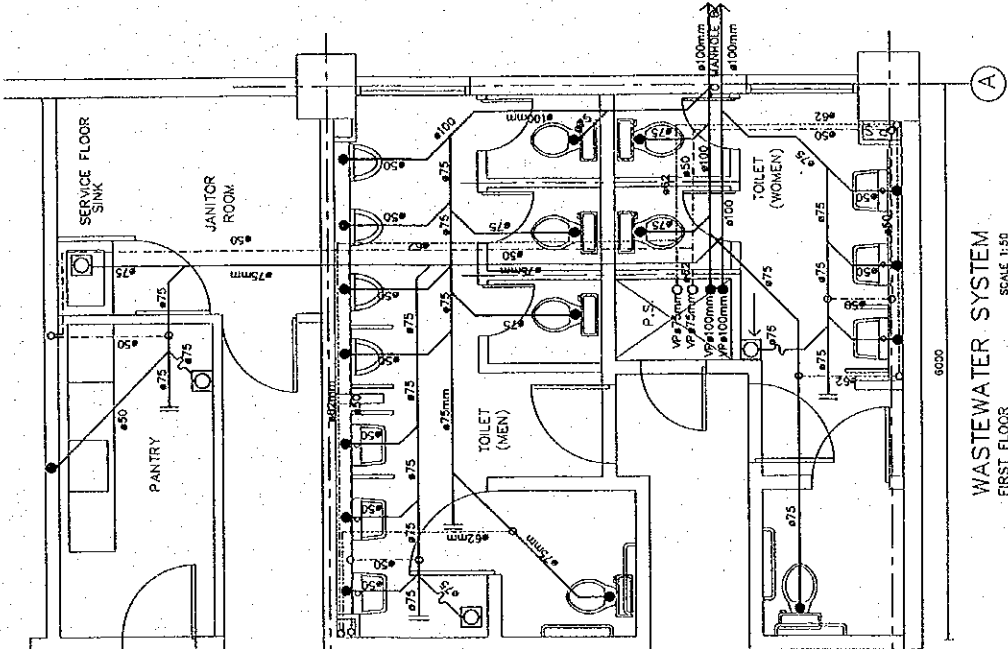

WASTEWATER SYSTEM
FIRST FLOOR
SCALE 1:50

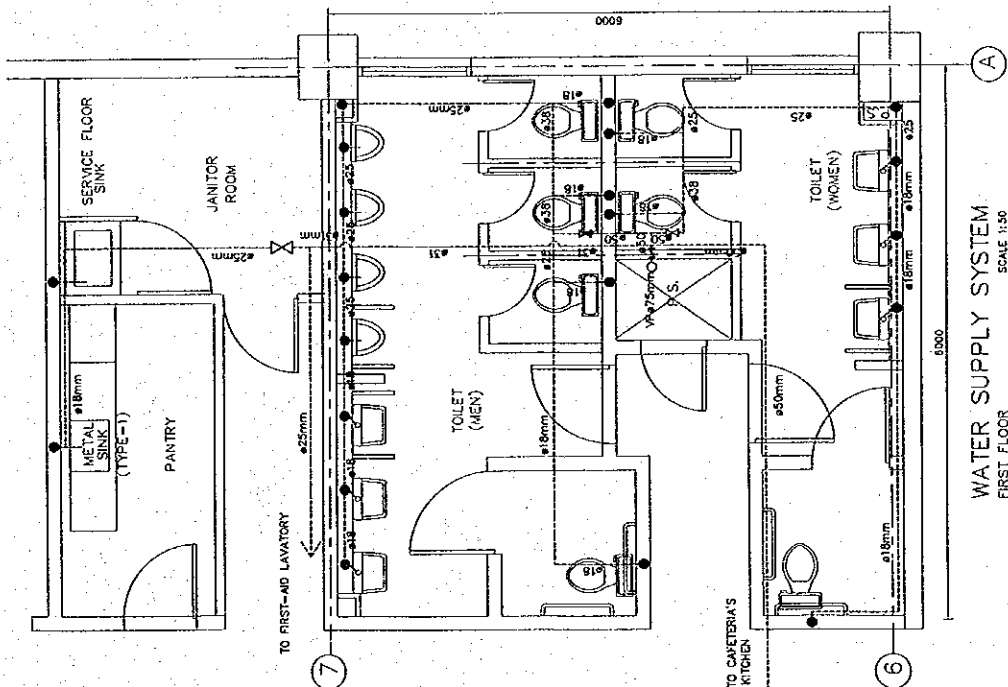

WATER SUPPLY SYSTEM
FIRST FLOOR
SCALE 1:50

Prepared by	H. Irua	02/07/17	Checked by	P. Enciso	17 July, 2017
-------------	---------	----------	------------	-----------	---------------



Project	Detailed Design on Port Reactivation Project In La Union Province of the Republic of El Salvador	Calc. File N°	
Section:	UTILITY WORK	Calc. Index N°	
Subject:	SANITARY APPLIANCES, PLUMBING & TOILET ACCESSORIES	Page N°	12/22



PLUMBING SYMBOLS

●	VERTICAL PIPE DOWN
○	VERTICAL PIPE UP
⊗	METER INSIDE PIT
⊕	CHECK VALVE
⊘	SHUT OFF VALVE
⊚	FLOOR/SHOWER DRAIN
⊛	CLEAN OUT
⊜	GREASE TRAP
⊝	TRAP
⊞	WATER SUPPLY PIPE (AT CEILING LEVEL)
⊟	WASTE DRAINAGE PIPE (UNDER SLAB LEVEL)
⊠	WASTE VENTILATION PIPE (AT CEILING LEVEL)
⊡	SANITARY DRAINAGE PIPE (UNDER SLAB LEVEL)
⊢	SANITARY DRAINAGE PIPE (AT CEILING LEVEL)
⊣	SANITARY DRAINAGE PIPE (UNDER SLAB LEVEL)
⊤	SANITARY DRAINAGE PIPE (AT CEILING LEVEL)

NOTES

- 1) SANITARY AND WASTE DRAINAGE PIPES TO BE PVC
- 2) WATER SUPPLY PIPES TO BE PVC
- 3) FIRE FIGHTING SYSTEM PIPES TO BE GALVANIZED IRON

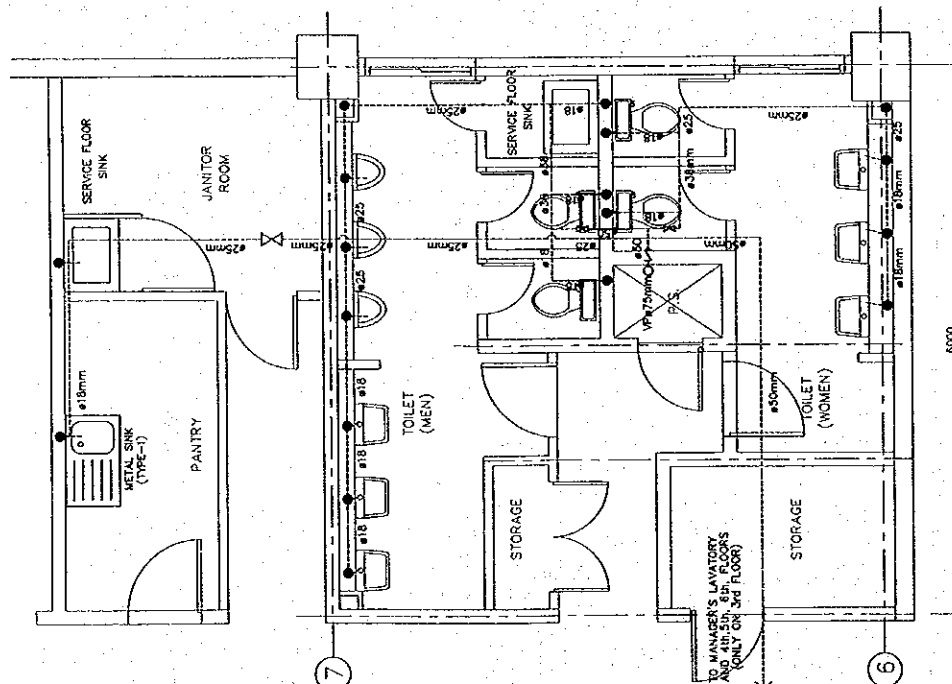
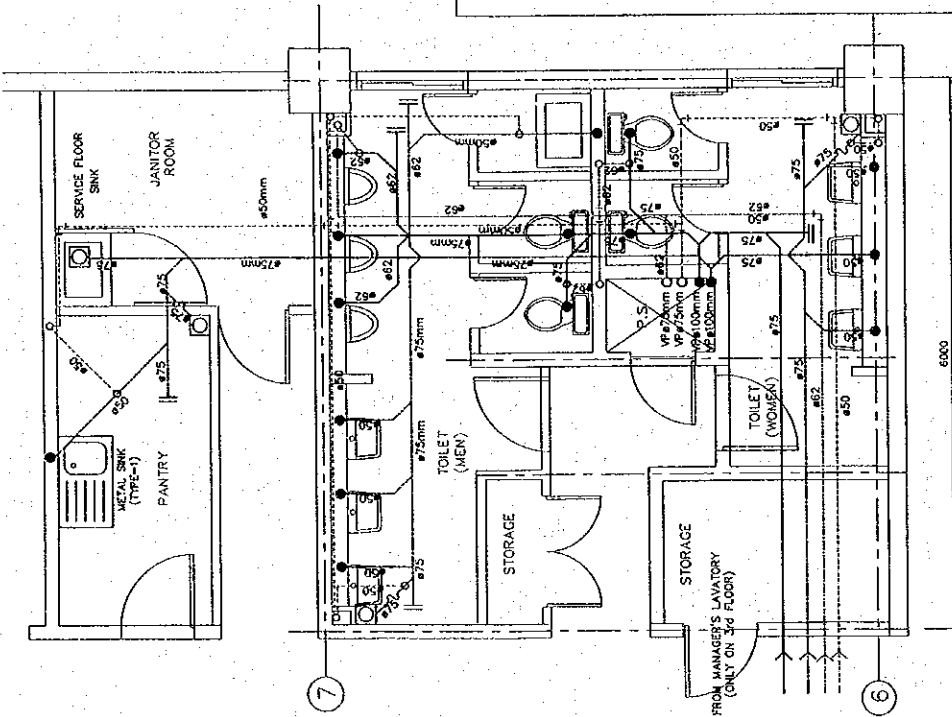

Prepared by	H. Irola	02/03/17	Checked by	S. Eudo	17 Jul, 02
-------------	----------	----------	------------	---------	------------



Project	Detailed Design on Port Reactivation Project in La Union Province of the Republic of El Salvador	Calc. File N°.
Section:	UTILITY WORK	Calc. Index N°.
Subject:	SANITARY APPLIANCES, PLUMBING & TOILET ACCESSORIES	Page N°. 13/22



PLUMBING SYMBOLS

●	VERTICAL PIPE DOWN
○	VERTICAL PIPE UP
⊗	METER INSIDE PIT
⊘	CHECK VALVE
⊙	SHUT OFF VALVE
⊚	FLOOR/SHOWER DRAIN
⊛	CLEAN OUT
⊜	GREASE TRAP
⊝	TRAP
—	WATER SUPPLY PIPE (AT CEILING LEVEL)
—	WASTE DRAINAGE PIPE (UNDER SLAB LEVEL)
—	WASTE VENTILATION PIPE (AT CEILING LEVEL)
—	SANITARY DRAINAGE PIPE (UNDER SLAB LEVEL)
—	SANITARY DRAINAGE PIPE (AT CEILING LEVEL)
—	VENTILATION PIPE (AT CEILING LEVEL)

NOTES
 1) SANITARY AND WASTE DRAINAGE PIPES TO BE PVC
 2) WATER SUPPLY PIPES TO BE PVC
 3) FIRE FIGHTING SYSTEM PIPES TO BE GALVANIZED IRON

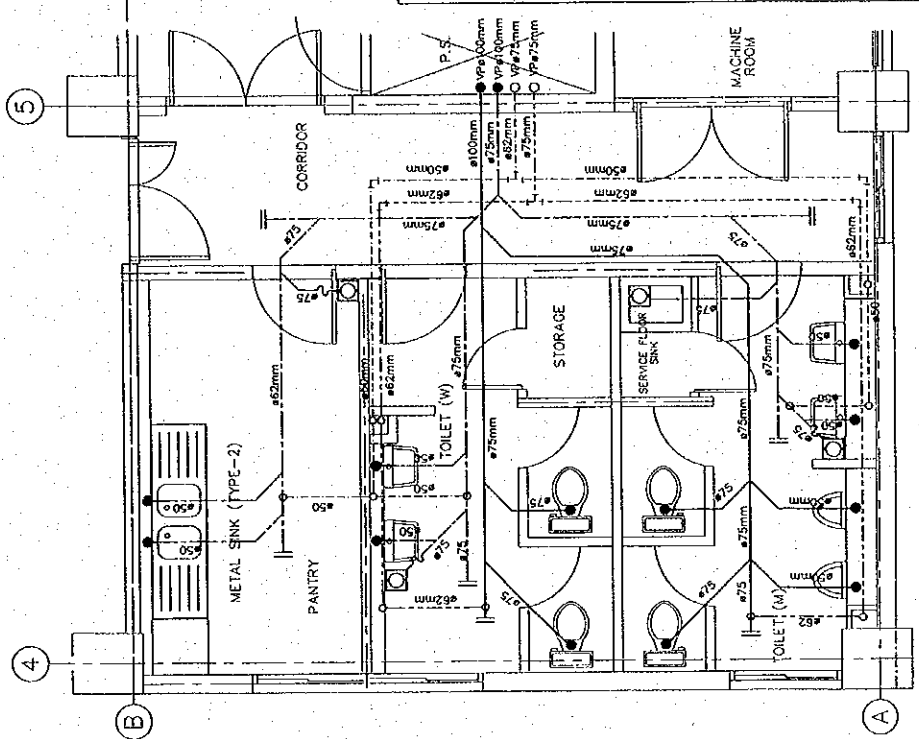

WASTEWATER SYSTEM
FOURTH FLOOR
SCALE 1:50

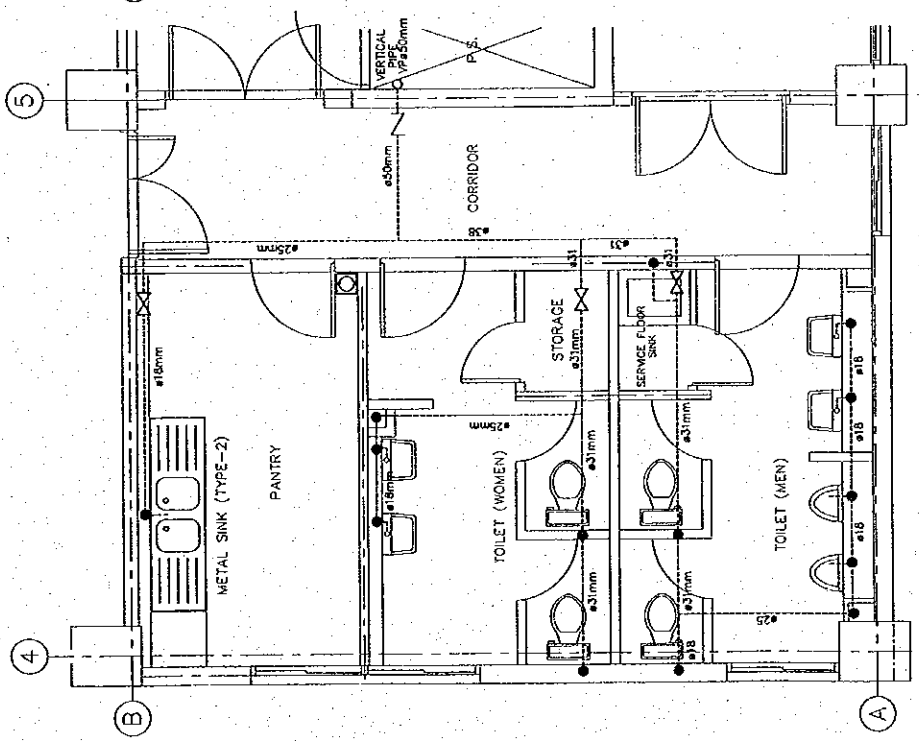

WATER SUPPLY SYSTEM
FOURTH FLOOR
SCALE 1:50

Prepared by	H. Iroh	02/07/17	Checked by	N. Ende	17 July, 2017
-------------	---------	----------	------------	---------	---------------



Project	Detailed Design on Port Reactivation Project in La Union Province of the Republic of El Salvador	Calc. File N°.
Section:	UTILITY WORK	Calc. Index N°.
Subject:	SANITARY APPLIANCES, PLUMBING & TOILET ACCESSORIES	Page N°. 14/22



PLUMBING SYMBOLS

○	VERTICAL PIPE DOWN
○	VERTICAL PIPE UP
~	TRAP
△	SHOWER HEAD
⊗	SHUT OFF VALVE
⊠	FLOOR/SHOWER DRAIN
⊥	CLEAN OUT
∟	CHECK VALVE
—	WATER SUPPLY PIPE (AT CEILING LEVEL)
—	WASTE DRAINAGE PIPE (UNDER SLAB LEVEL)
—	WASTE VENTILATION PIPE (AT CEILING LEVEL)
—	SANITARY DRAINAGE PIPE (UNDER SLAB LEVEL)
—	SANITARY DRAINAGE VENTILATION PIPE (AT CEILING LEVEL)

- NOTES
- 1) SANITARY AND WASTE DRAINAGE PIPES TO BE PVC.
 - 2) WATER SUPPLY PIPES TO BE PVC.
 - 3) FIRE FIGHTING SYSTEM PIPES TO BE GALVANIZED IRON.

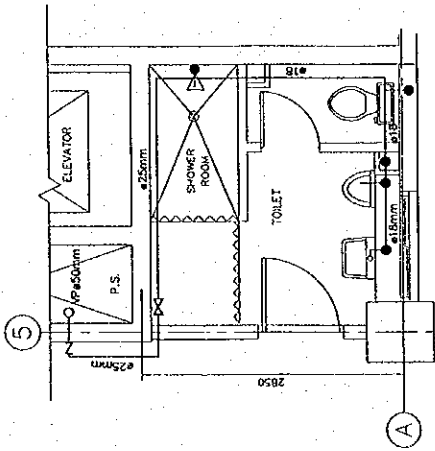

WATER SUPPLY SYSTEM
LAVATORY SIXTH FLOOR
SCALE 1:50

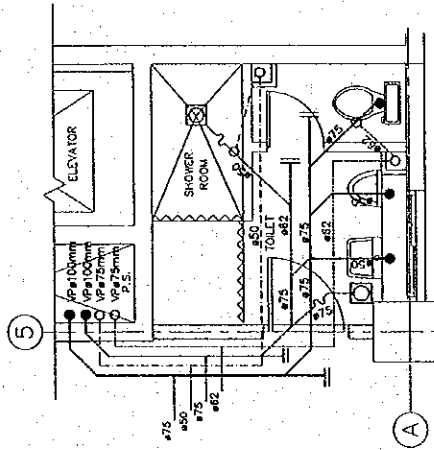

WASTEWATER SYSTEM
LAVATORY SIXTH FLOOR
SCALE 1:50

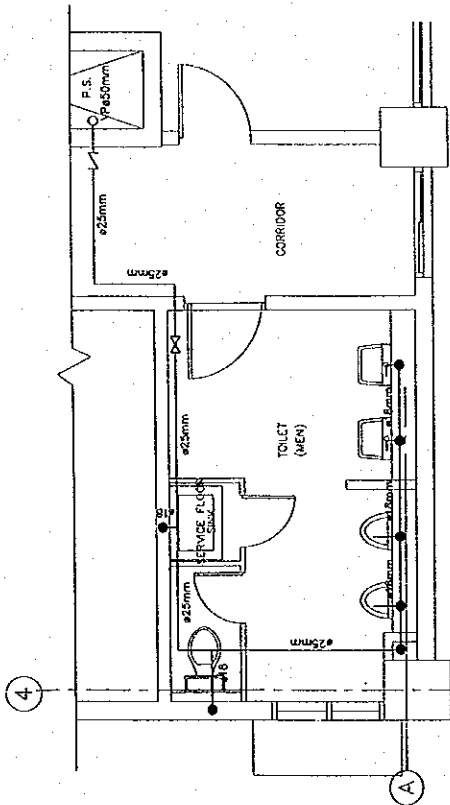

WATER SUPPLY SYSTEM
LAVATORY FIFTH FLOOR
SCALE 1:50

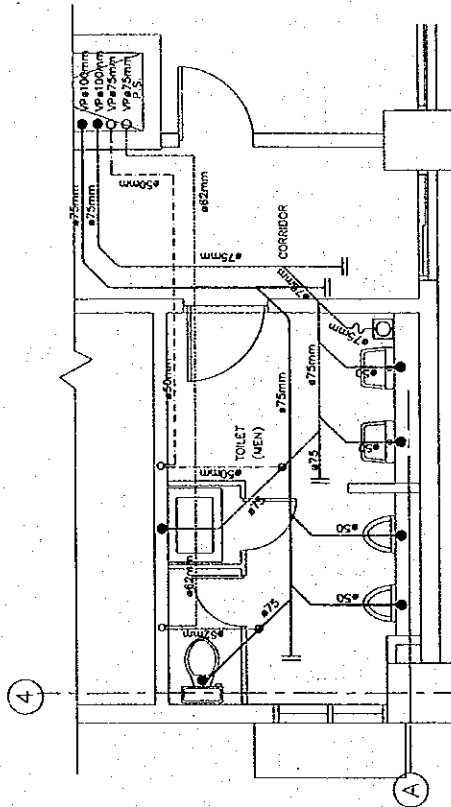

WASTEWATER SYSTEM
LAVATORY FIFTH FLOOR
SCALE 1:50

Prepared by

A. Irub

Checked by

S. Endo

02/07/17

17 July 2017



Project	Detailed Design on Port Reactivation Project in La Union Province of the Republic of El Salvador	Calc. File N°.	
Section:	UTILITY WORK	Calc. Index N°.	
Subject:	SANITARY APPLIANCES, PLUMBING & TOILET ACCESSORIES	Page N°.	15/22

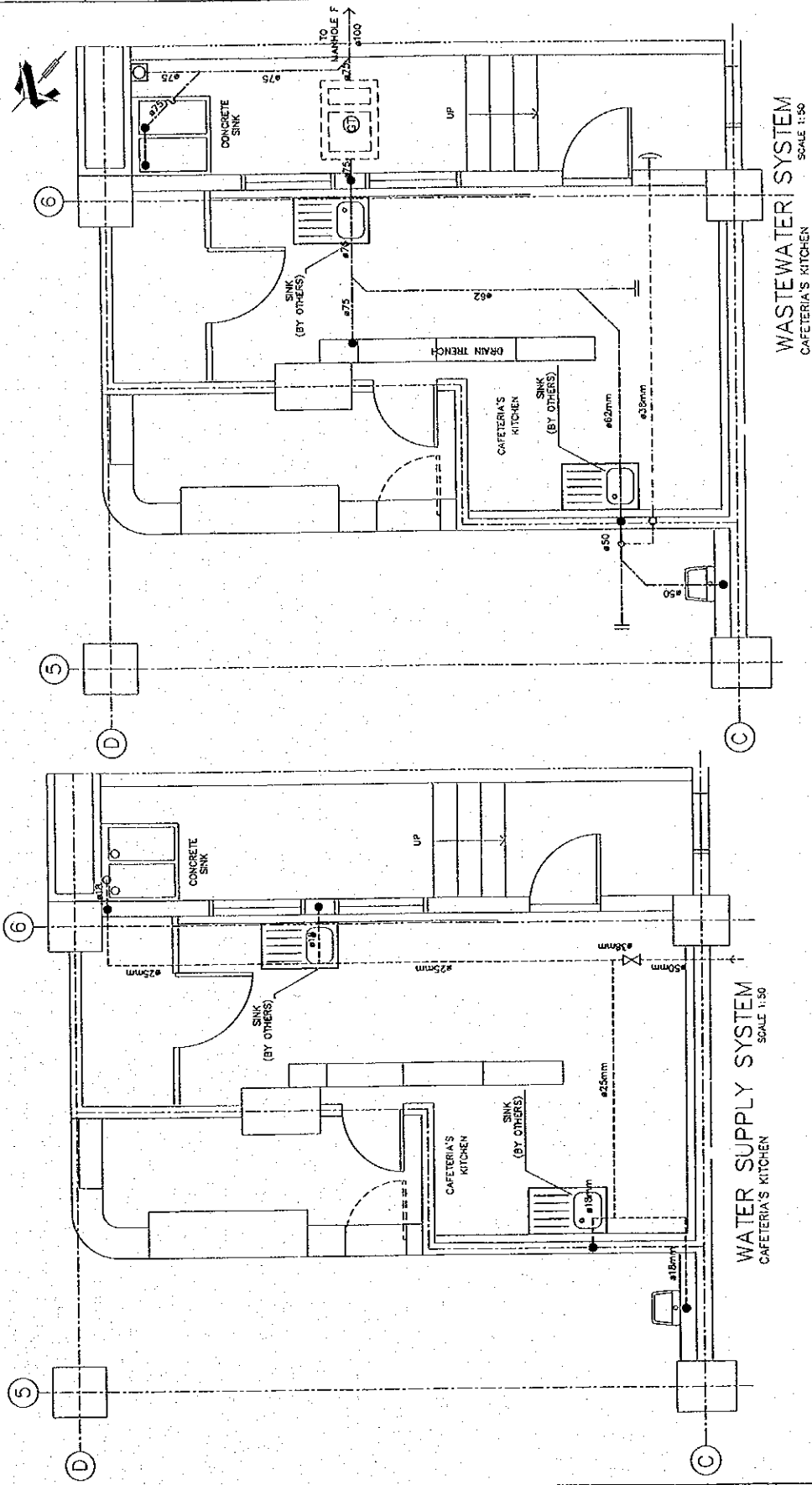

PLUMBING SYMBOLS	NOTES
VERTICAL PIPE DOWN VERTICAL PIPE UP TRAP SHUT OFF VALVE	1) SANITARY AND WASTE DRAINAGE PIPES TO BE PVC 2) WATER SUPPLY PIPES TO BE PVC 3) FIRE FIGHTING SYSTEM PIPES TO BE GALVANIZED IRON
FLOOR/SHOWER DRAIN CLEAN OUT GREASE TRAP VENT OUTLET COVER WATER SUPPLY PIPE (AT CEILING LEVEL)	WASTE DRAINAGE PIPE (UNDER SLAB LEVEL) WASTE VENTILATION PIPE (AT CEILING LEVEL) SANITARY DRAINAGE PIPE (UNDER SLAB LEVEL) SANITARY DRAINAGE VENTILATION PIPE (AT CEILING LEVEL)

Prepared by	A. Iruca	02/07/17	Checked by	P. Endo	17 July, 02
-------------	----------	----------	------------	---------	-------------



Project	Detailed Design on Port Reactivation Project in La Union Province of the Republic of El Salvador	Calc. File N°.	
Section:	UTILITY WORK	Calc. Index N°.	
Subject:	SANITARY APPLIANCES, PLUMBING & TOILET ACCESSORIES	Page N°.	16/22

LEGEND	
WC	WATER CLOSET
WB	WASH BASIN
UR	URINAL
MSK	METAL SINK
SV	SHOWER VALVE
SH	SHOWER HEAD
VO	VENT OUTLET
CO	CLEAN OUT
FD	FLOOR DRAIN
SD	SHOWER DRAIN
MI	METER INSIDE PIT
VI	VALVE INSIDE PIT
SO	SHUT OFF VALVE
TR	TRAP
GT	GREASE TRAP
FD	FLOW DIRECTION
WS	WATER SUPPLY PIPE
SD	SANITARY DRAINAGE PIPE
SV	SANITARY VENT
WD	WASTE DRAINAGE PIPE
VE	WASTE DRAINAGE VENT

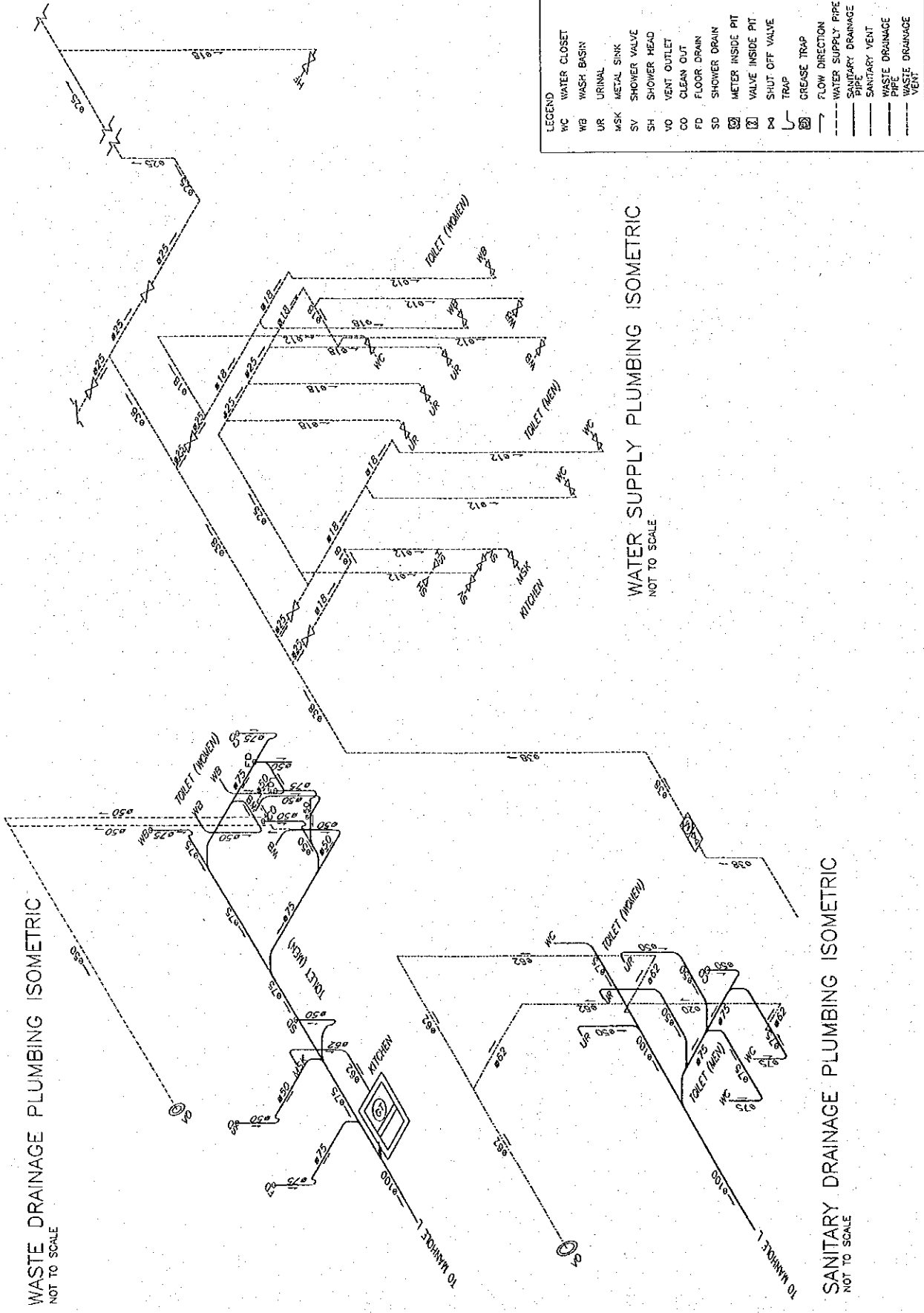

Prepared by	H. Irua	Checked by	D. Irua
Date	02/07/17	Date	17 July, 2017



Project	Detailed Design on Port Reactivation Project in La Union Province of the Republic of El Salvador	Calc. File N°.	
Section:	UTILITY WORK	Calc. Index N°.	
Subject:	SANITARY APPLIANCES, PLUMBING & TOILET ACCESSORIES	Page N°.	17/22

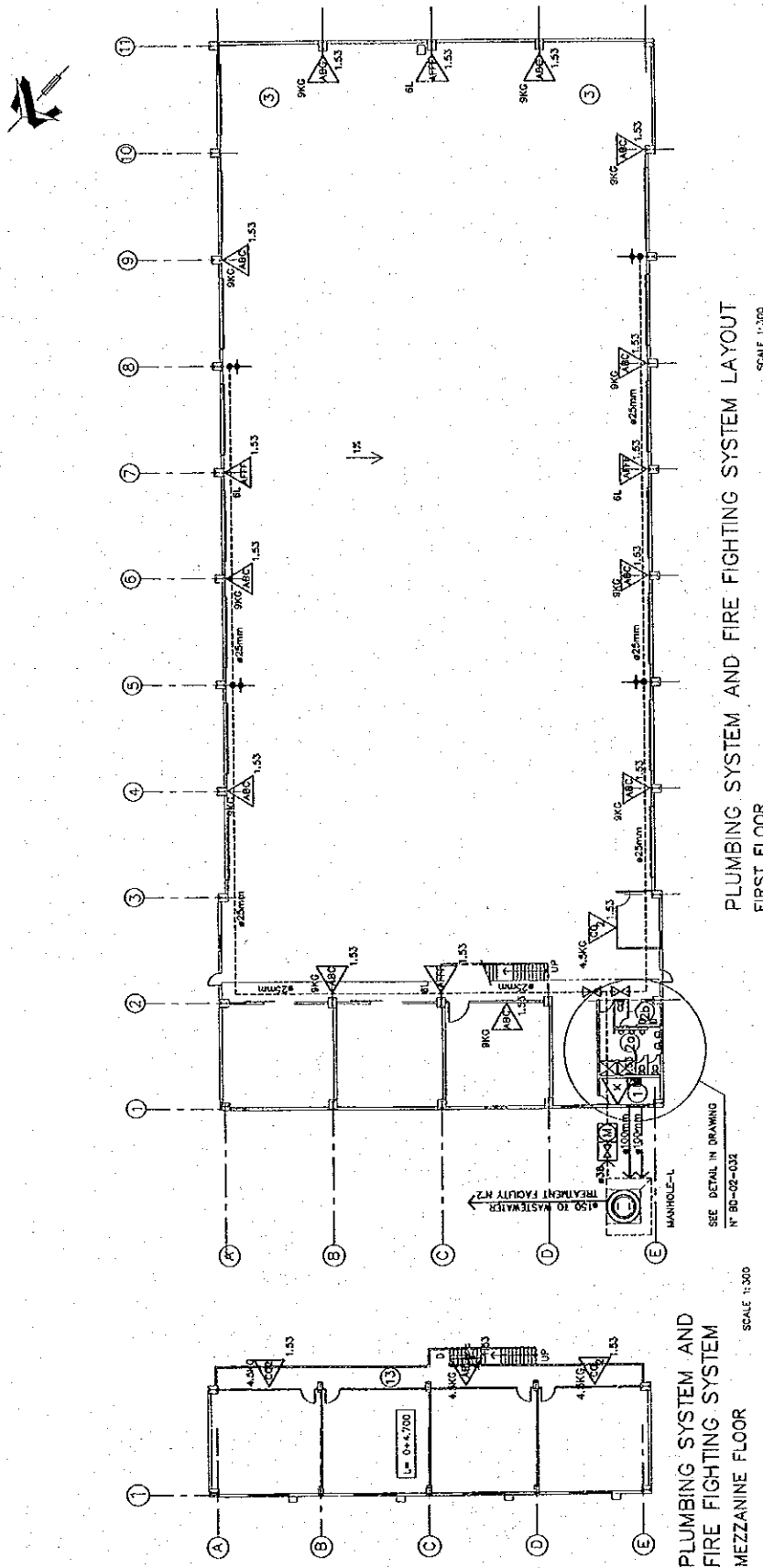

PLUMBING SYSTEM AND FIRE FIGHTING SYSTEM LAYOUT
FIRST FLOOR
SCALE 1:300

PLUMBING SYSTEM AND
FIRE FIGHTING SYSTEM
MEZZANINE FLOOR
SCALE 1:300

NOTES

- 1) SEWERAGE/WASTE PIPES TO BE PVC
- 2) WATER SUPPLY PIPES TO BE PVC
- 3) FIRE FIGHTING SYSTEM PIPES TO BE GALVANIZED IRON

<p>ROOM LIST</p> <ul style="list-style-type: none"> ① KITCHEN ② TOILET (MEN) ③ TOILET (WOMEN) 	<p>(PLUMBING SYMBOLS)</p> <ul style="list-style-type: none"> METER INSIDE PIT VALVE INSIDE PIT SHUT OFF VALVE HOSE FAUCET 1/8"mm WATER SUPPLY PIPE VERTICAL PIPE DOWN VERTICAL PIPE UP 	<p>FIRE FIGHTING SYMBOLS</p> <ul style="list-style-type: none"> ABC (MULTIPURPOSE) DRY POWDER EXTINGUISHER AS CLASS AFFY EXTINGUISHER AB CLASS AFFY CO2 EXTINGUISHER KITCHEN CLASS EXTINGUISHER <p>LEGEND</p> <ul style="list-style-type: none"> P CHARGE h PLACEMENT HEIGHT
--	---	--

Prepared by	H. Irjala	02/07/17	Checked by	N. Endo	17 July, 02'
-------------	-----------	----------	------------	---------	--------------



Project	Detailed Design on Port Reactivation Project In La Union Province of the Republic of El Salvador	Calc. File N°.	
Section:	UTILITY WORK	Calc. Index N°.	
Subject:	SANITARY APPLIANCES, PLUMBING & TOILET ACCESSORIES	Page N°.	18/22

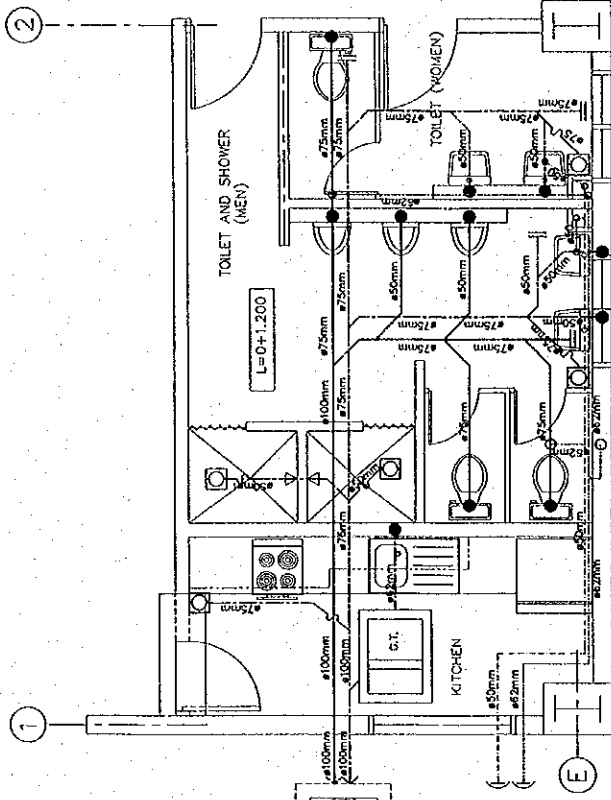

WASTEWATER SYSTEM
SCALE 1:50

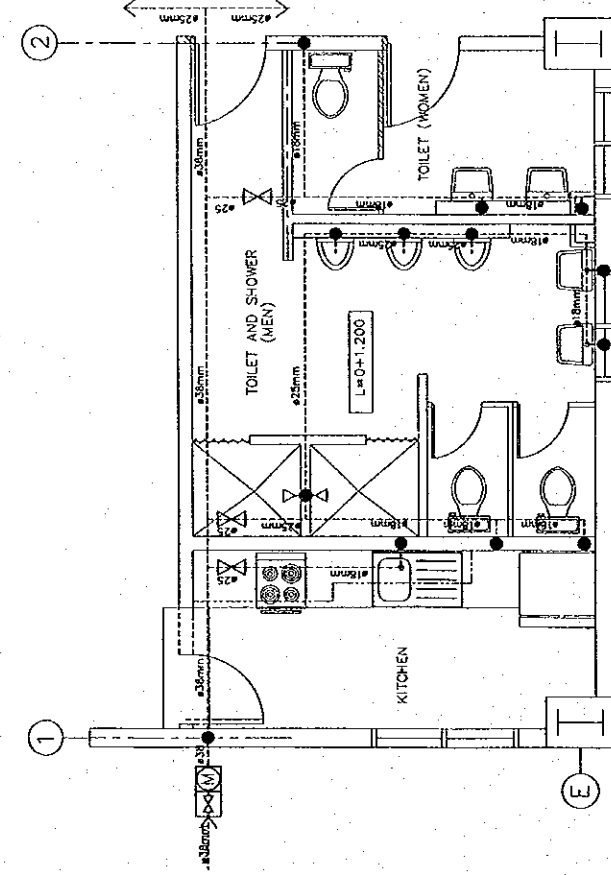

WATER SUPPLY SYSTEM
SCALE 1:50

PLUMBING SYMBOLS

	VERTICAL PIPE DOWN		WATER SUPPLY PIPE
	VERTICAL PIPE UP		WASTE DRAINAGE PIPE
	METER INSIDE PIT		WASTE VENTILATION PIPE
	VALVE INSIDE PIT		SANITARY DRAINAGE PIPE
	SHUT OFF VALVE		SANITARY DRAINAGE VENTILATION PIPE
	FLOOR/SHOWER DRAIN		
	VENT OUTLET		

Prepared by	H. Irak	Checked by	P. Gudo	17 July, 2017
	02/07/17			



Project	Detailed Design on Port Reactivation Project In La Union Province of the Republic of El Salvador	Calc. File N°.	
Section:	UTILITY WORK	Calc. Index N°.	
Subject:	SANITARY APPLIANCES, PLUMBING & TOILET ACCESSORIES	Page N°.	19/22

LEGEND

WC	WATER CLOSET
WB	WASH BASIN
UR	URINAL
MSK	METAL SINK
SV	SHOWER VALVE
SH	SHOWER HEAD
VO	VENT OUTLET
CO	CLEAN OUT
FD	FLOOR DRAIN
SD	SHOWER DRAIN
	METER INSIDE PIT
	VALVE INSIDE PIT
	SHUT OFF VALVE
	TRAP
	GREASE TRAP
	FLOW DIRECTION
	WATER SUPPLY PIPE
	SANITARY DRAINAGE PIPE
	SANITARY VENT PIPE
	WASTE DRAINAGE PIPE
	WASTE VENT PIPE

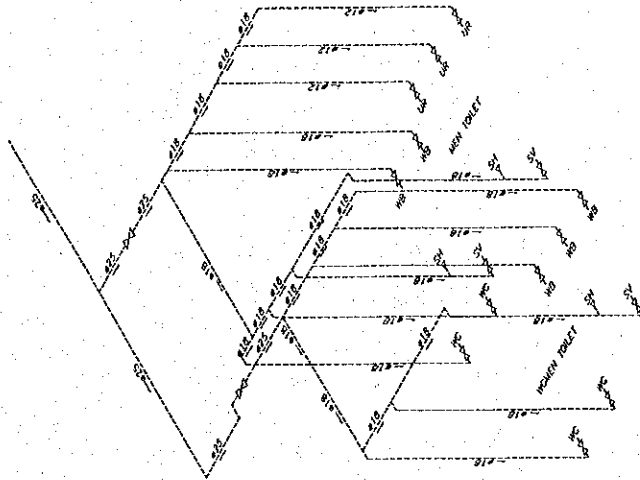

WATER SUPPLY PLUMBING ISOMETRIC
NOT TO SCALE

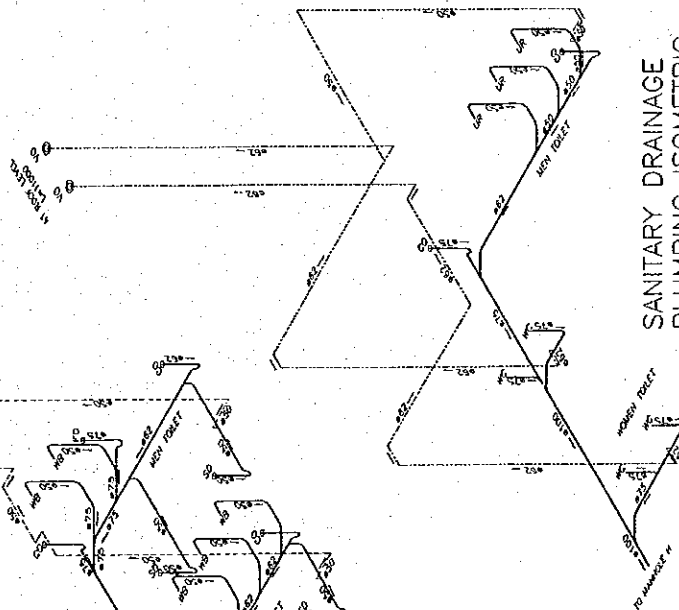

SANITARY DRAINAGE PLUMBING ISOMETRIC
NOT TO SCALE

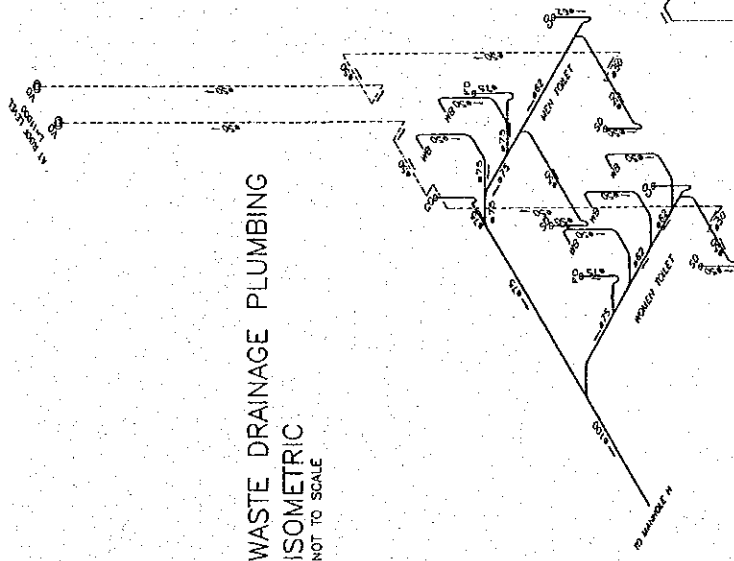

WASTE DRAINAGE PLUMBING ISOMETRIC
NOT TO SCALE

Prepared by	H. Iruh	02/07/17	Checked by	S. Endo	17 July 02
-------------	---------	----------	------------	---------	------------



Project	Detailed Design on Port Reactivation Project in La Union Province of the Republic of El Salvador	Calc. File N°.	
Section:	UTILITY WORK	Calc. Index N°.	
Subject:	SANITARY APPLIANCES, PLUMBING & TOILET ACCESSORIES	Page N°.	20/22

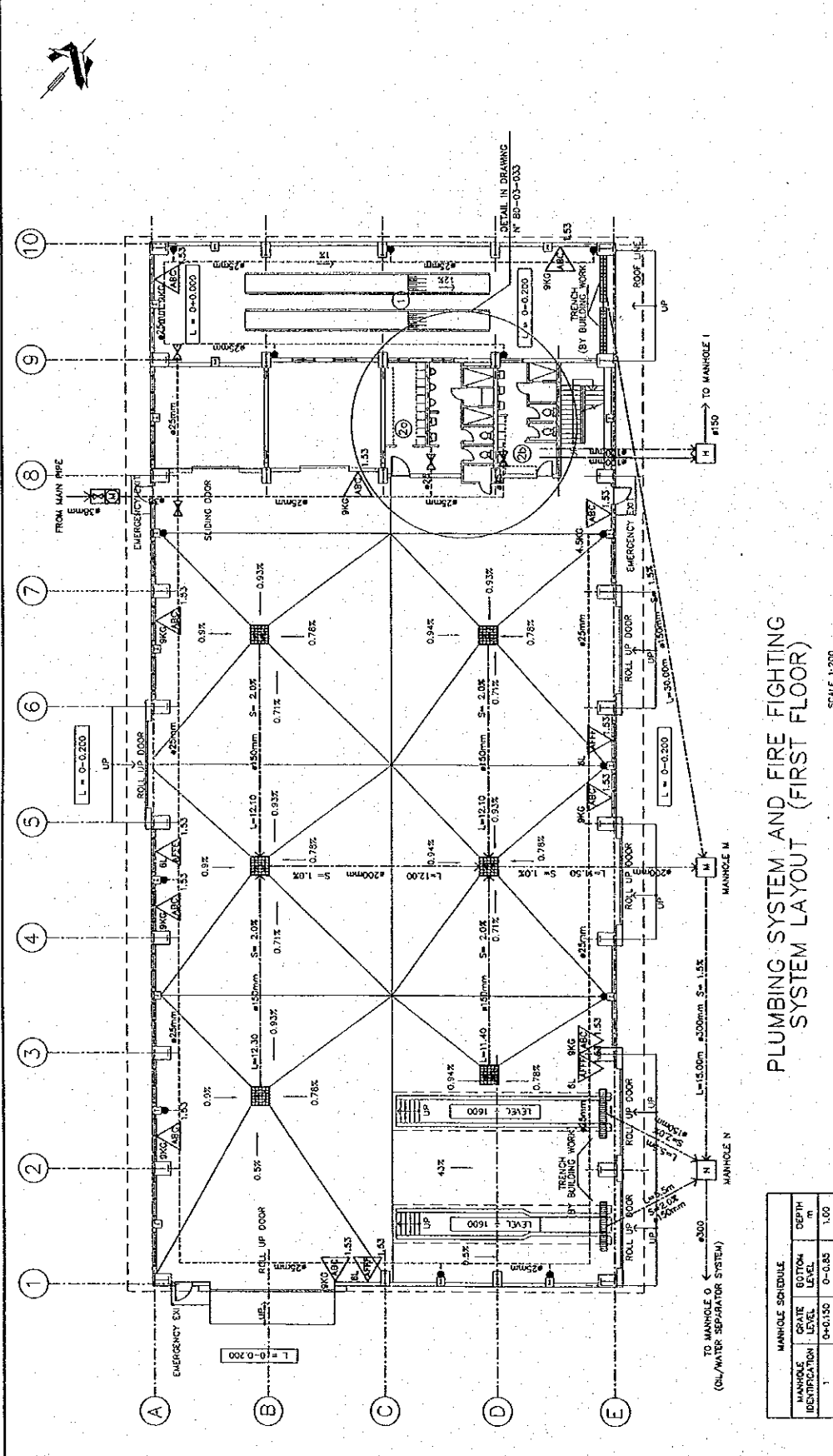

<p>(ROOM LIST)</p> <p>WASH UNIT (1)</p> <p>TOILETS (M&F) (2)</p> <p>TOILETS (WOMEN) (3)</p>	<p>PLUMBING SYMBOLS</p> <p>VERTICAL PIPE DOWN (●)</p> <p>WATER SUPPLY PIPE (—)</p> <p>WASTE DRAINAGE PIPE (---)</p> <p>SANITARY DRAINAGE PIPE (---)</p> <p>METER INSIDE PIT (⊗)</p> <p>VALVE INSIDE PIT (⊗)</p> <p>MANHOLE WITH GRATING COVER (⊗)</p>	<p>FIRE FIGHTING SYMBOLS</p> <p>ABC (MULTIPURPOSE) EXTINGUISHER (▲)</p> <p>DRY POWDER EXTINGUISHER (▲)</p> <p>AB CLASS AFF EXTINGUISHER (▲)</p> <p>AB CLASS AFF CO2 EXTINGUISHER (▲)</p> <p>KITCHEN CLASS EXTINGUISHER (▲)</p> <p>LEGEND (P)</p> <p>CHARGE (h)</p> <p>PLACEMENT HEIGHT (h)</p>
--	--	---

PLUMBING SYSTEM AND FIRE FIGHTING SYSTEM LAYOUT (FIRST FLOOR)

SCALE 1:200

- NOTES**
- 1) WASTE AND SANITARY DRAINAGE PIPES TO BE PVC
 - 2) WATER SUPPLY PIPES TO BE PVC
 - 3) FIRE FIGHTING SYSTEM PIPES TO BE GALVANIZED IRON

MANHOLE IDENTIFICATION	GRATE LEVEL	BOTTOM LEVEL	DEPTH m
1	0+0.150	0-0.85	1.00
2	0+0.150	0-0.85	1.00
3	0+0.150	0-1.25	1.40
4	0+0.150	0-0.85	1.00
5	0+0.150	0-1.40	1.55
6	0+0.150	0-0.85	1.00

Prepared by	H. Irula	02/07/17	Checked by	S. Sudo	17 July, 2017
-------------	----------	----------	------------	---------	---------------



Project	Detailed Design on Port Reactivation Project in La Union Province of the Republic of El Salvador	Calc. File N°.	
Section:	UTILITY WORK	Calc. Index N°.	
Subject:	SANITARY APPLIANCES, PLUMBING & TOILET ACCESSORIES	Page N°.	21/22

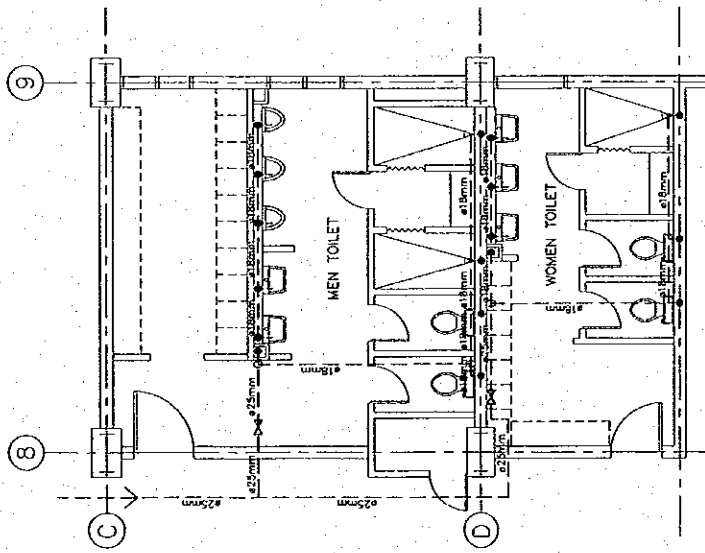
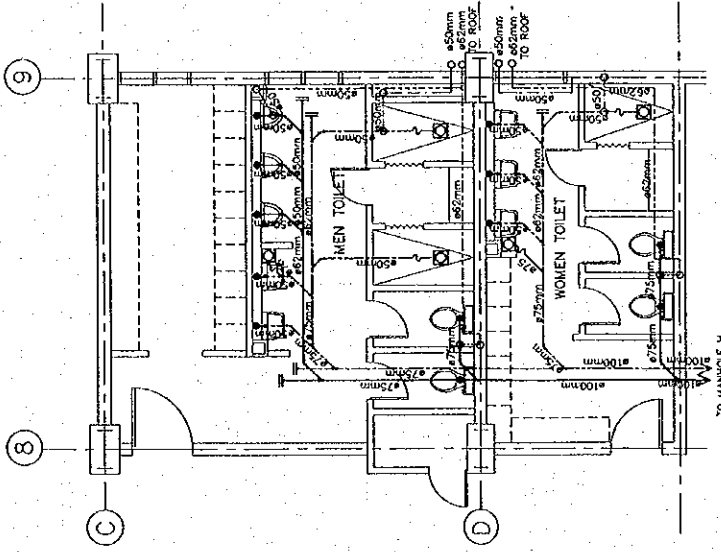

PLUMBING SYMBOLS

○	WATER SUPPLY PIPE
○	WASTE DRAINAGE PIPE
○	WASTE VENTILATION PIPE (IN UNDERGROUND PIPE)
○	SANITARY DRAINAGE PIPE
○	SANITARY VENTILATION PIPE
—	VERTICAL PIPE DOWN
—	VERTICAL PIPE UP
—	METER INSIDE PIT
—	VALVE INSIDE PIT
—	SHUT OFF VALVE
—	FLOOR DRAIN

- NOTES
- 1) SANITARY AND WASTE DRAINAGE PIPES TO BE PVC
 - 2) WATER SUPPLY PIPES TO BE PVC
 - 3) FIRE PROTECTING SYSTEM PIPES TO BE GALVANIZED IRON

Prepared by	H. Irular	02/07/17	Checked by	S. Sudo	17 July 2017
-------------	-----------	----------	------------	---------	--------------



Project	Detailed Design on Port Reactivation Project in La Union Province of the Republic of El Salvador	Calc. File N°.
Section:	UTILITY WORK	Calc. Index N°.
Subject:	SANITARY APPLIANCES, PLUMBING & TOILET ACCESSORIES	Page N°. 22/22

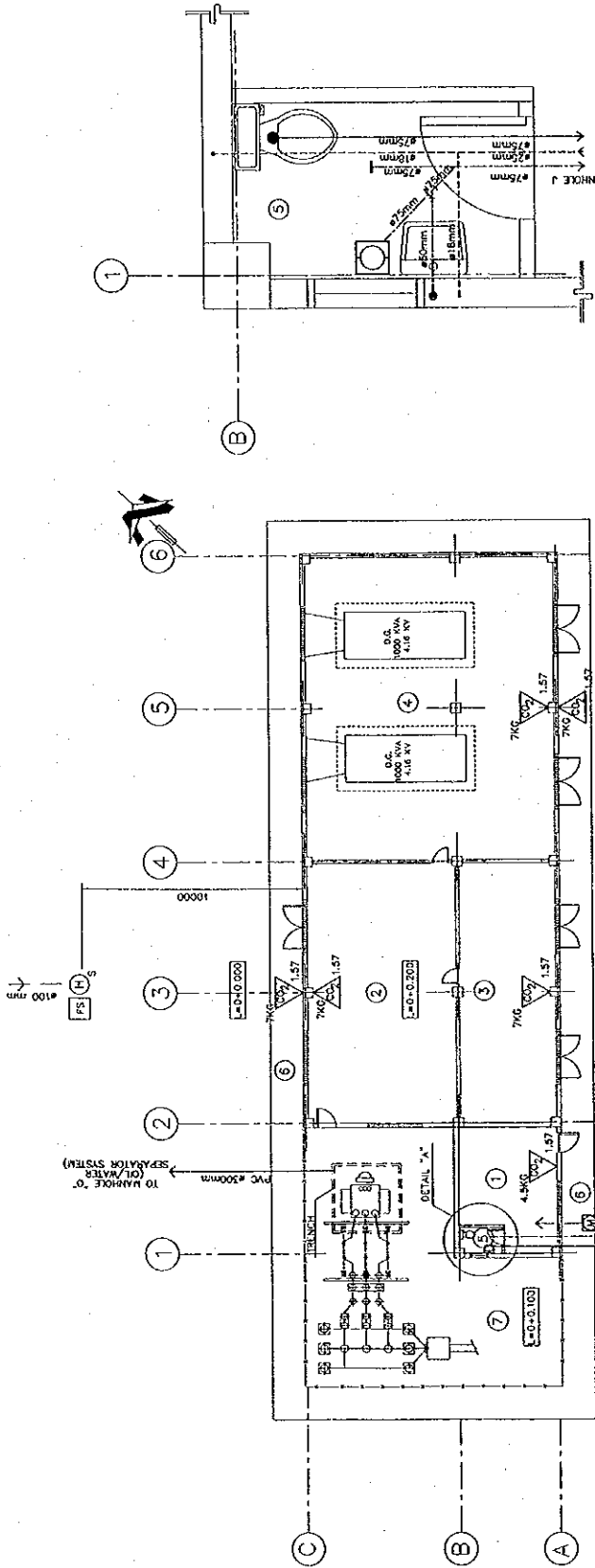

PLUMBING AND FIRE FIGHTING SYSTEMS
SCALE 1:200

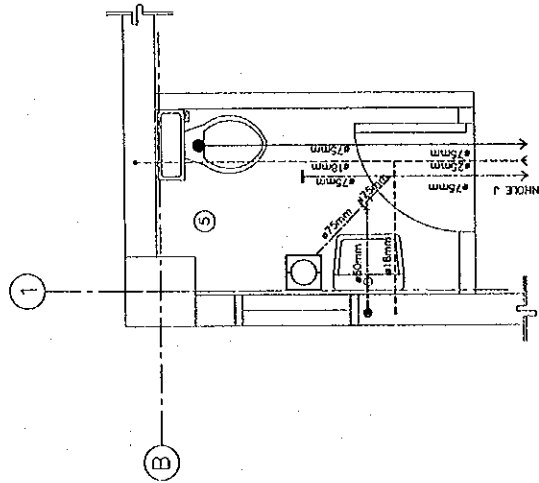

DETAIL "A"
SCALE 1:30

<p>PLUMBING SYMBOLS</p> <ul style="list-style-type: none"> ● VERTICAL PIPE DOWN ○ WATER SUPPLY PIPE ○ WASTE INSIDE PIT ○ WASTE DRAINAGE PIPE ○ VALVE INSIDE PIT ○ SANITARY DRAINAGE PIPE ○ FLOOR DRAIN 	<p>NOTES</p> <ol style="list-style-type: none"> WASTE AND SANITARY DRAINAGE PIPES TO BE PVC WATER SUPPLY PIPES TO BE PVC FIRE FIGHTING SYSTEM PIPES TO BE GALVANIZED IRON 	<p>FIRE FIGHTING SYMBOLS</p> <ul style="list-style-type: none"> △ AB CLASS CO2 EXTINGUISHER ○ FIRE HYDRANT □ FIRE STATION CABINET <p>LEGEND</p> <ul style="list-style-type: none"> P WEIGHT IN KGS h PLACEMENT HEIGHT 	<p>(ROOM LIST)</p> <ol style="list-style-type: none"> OFFICE ROOM SWITCHGEAR ROOM TRANSFORMER ROOM GENERATOR ROOM TOILET SIDEWALK TRANSFORMER YARD
--	---	--	--

Prepared by	H. Iruka	02/07/17	Checked by	S. Endo	17 July, 02
-------------	----------	----------	------------	---------	-------------