

東立面図

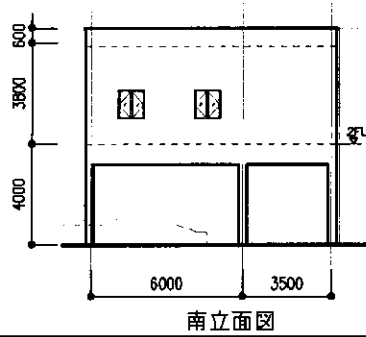

南立面図

立面図 1/300

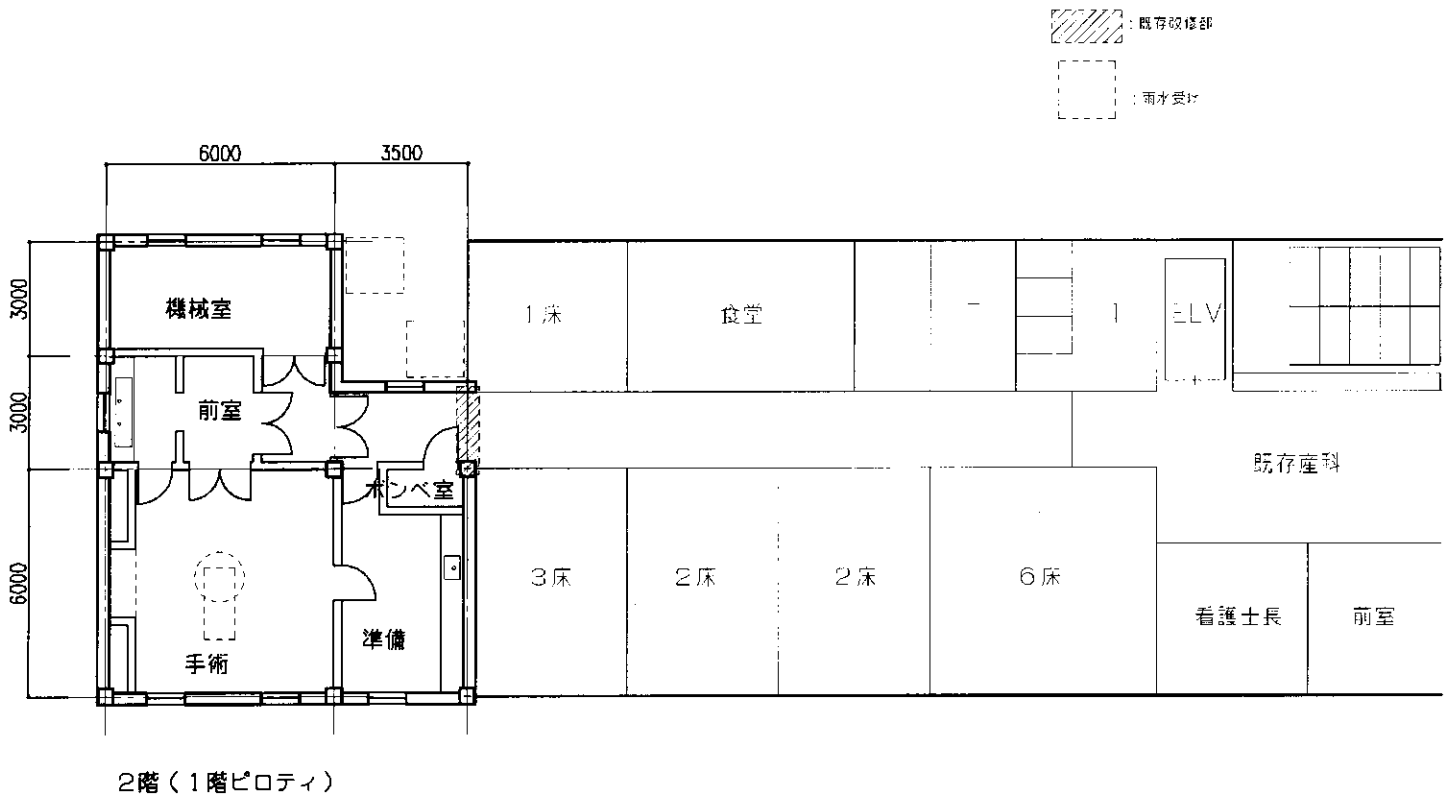

2階 (1階ピロティ)

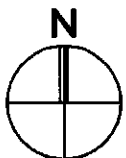

平面図 1/200  
No.1 モハメド5世県病院  
(Mohamed V)

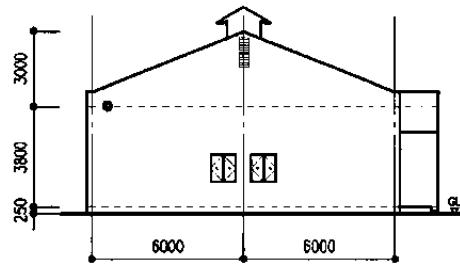
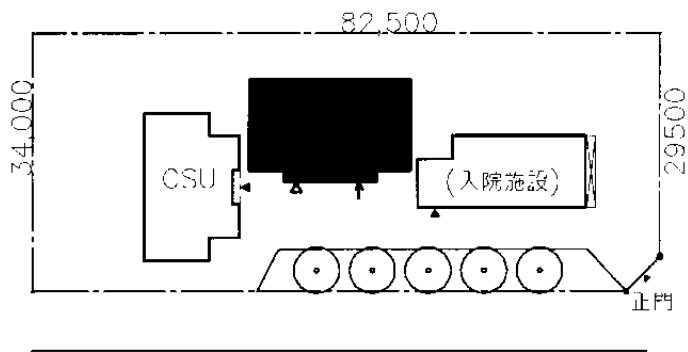

西立面図

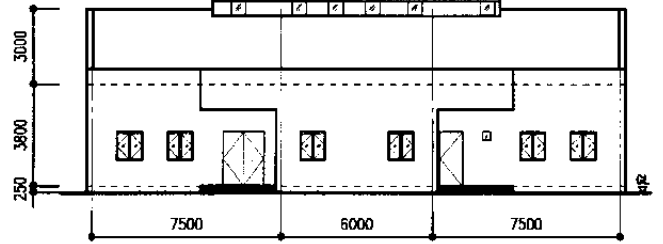

南立面図

配置図 1/1000  
立面図 1/300

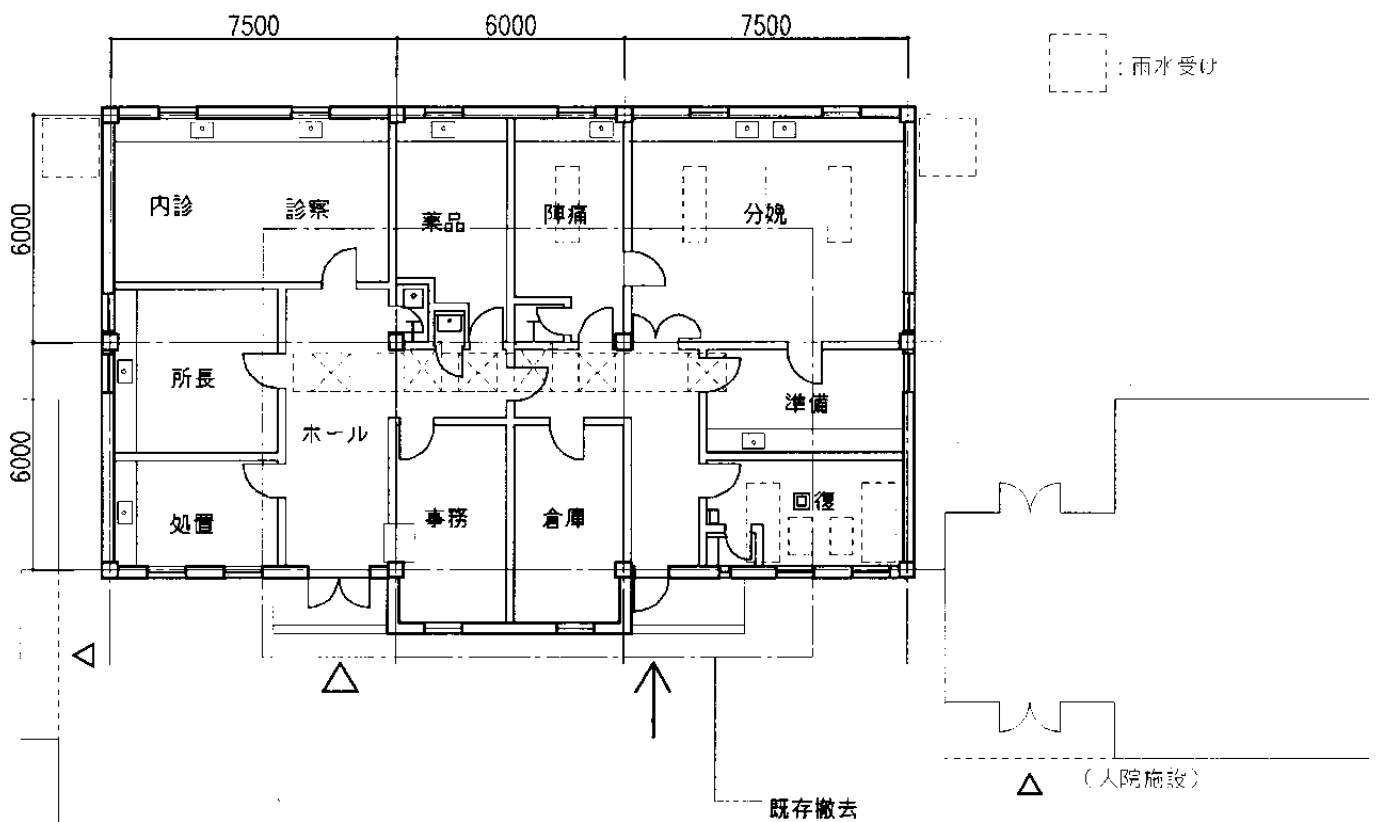

平面図 1/200

No.2 イムゼル保健センター  
(Immouzer)

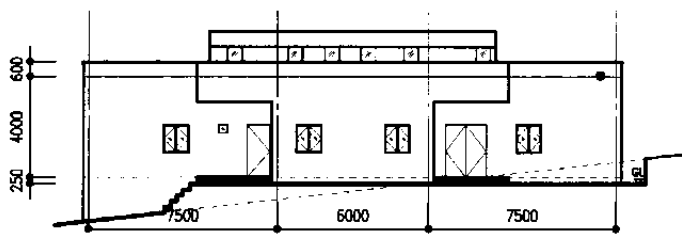
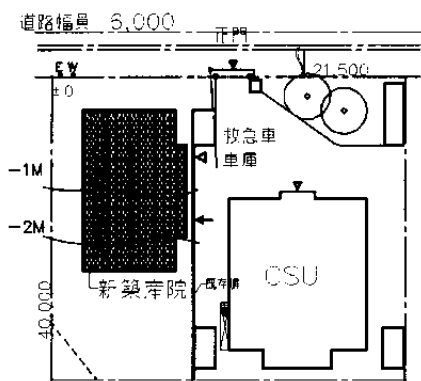

西立面図

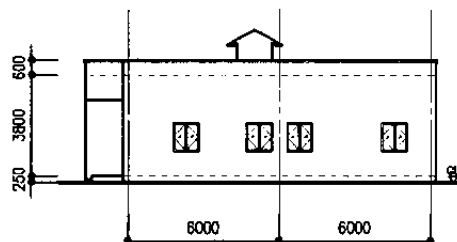

南立面図



配置図 1/1000  
立面図 1/300

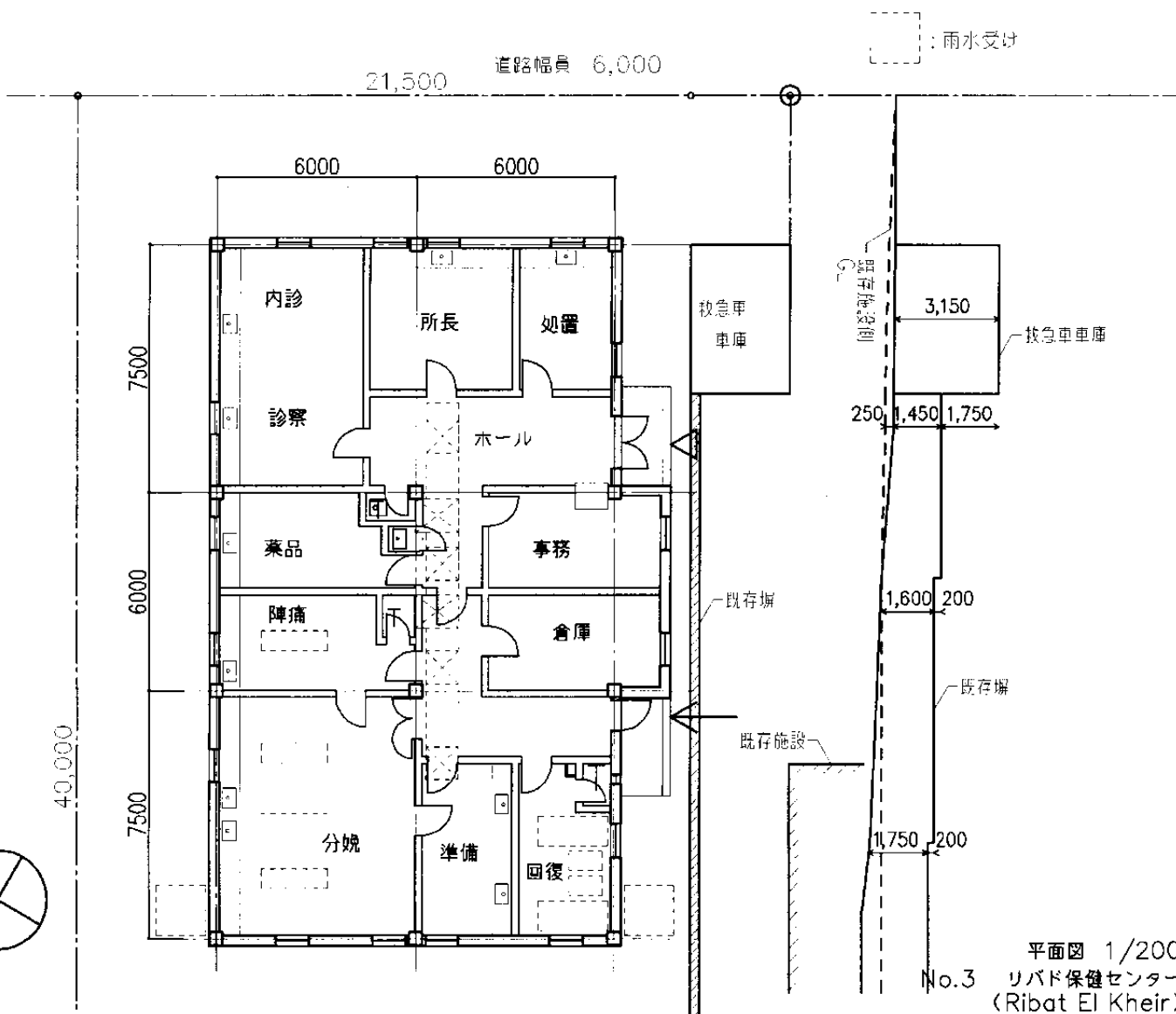

平面図 1/200  
No.3 リバド保健センター (Ribad El Kheir)

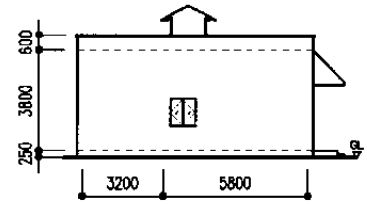
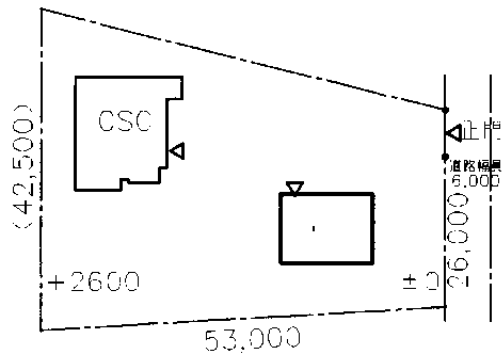

東立面図

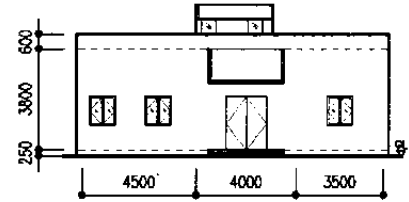

北立面図

配置図 1/1000  
立面図 1/300

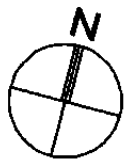
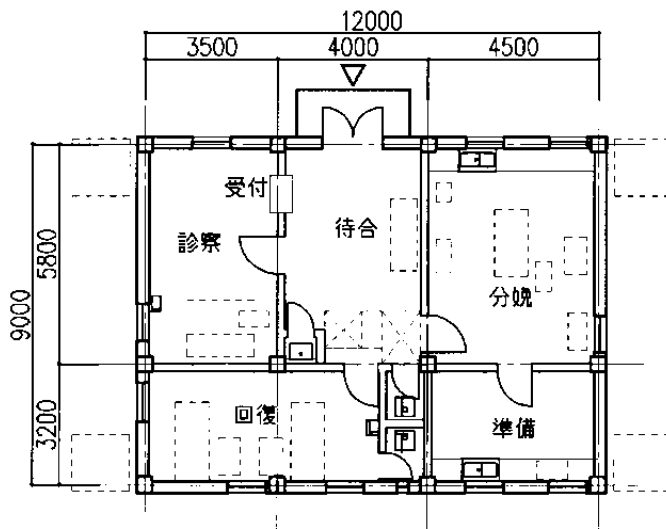

平面図 1/200

No.4 アドレジ保健センター  
(Adrej)

モロッコ王国母性ヘルスケア改善計画基本設計調査

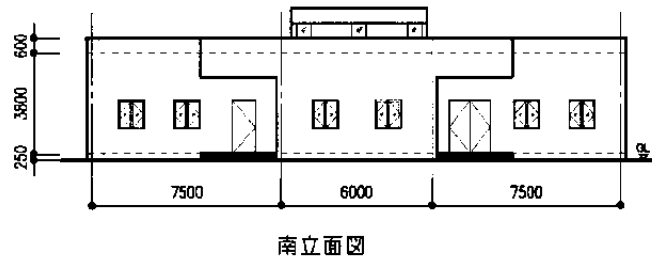
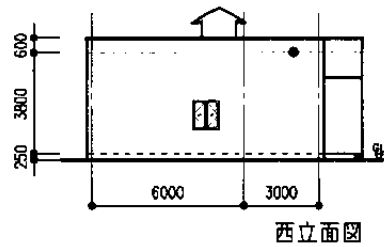
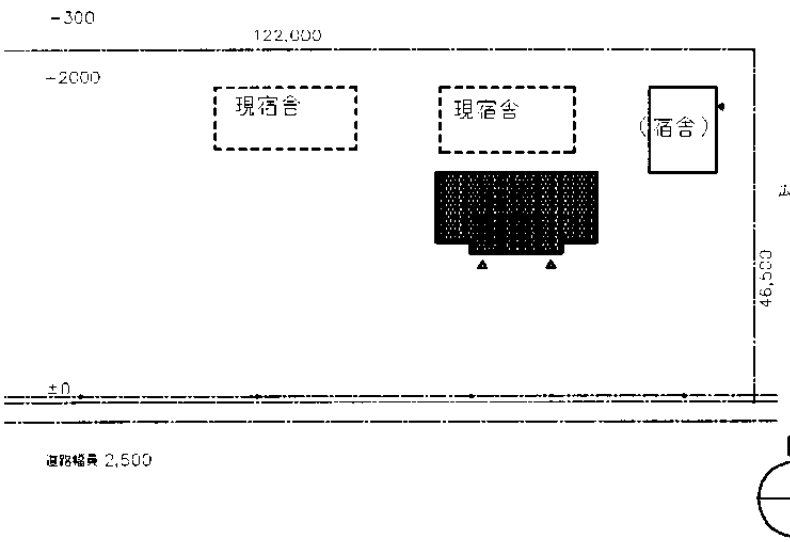

配置図 1/1000  
立面図 1/300

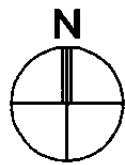

雨水受け

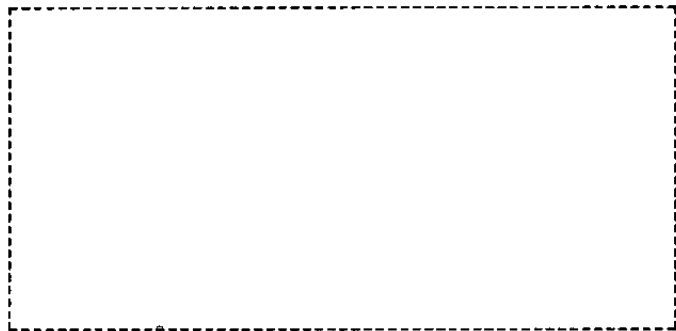

倉庫(撤去)

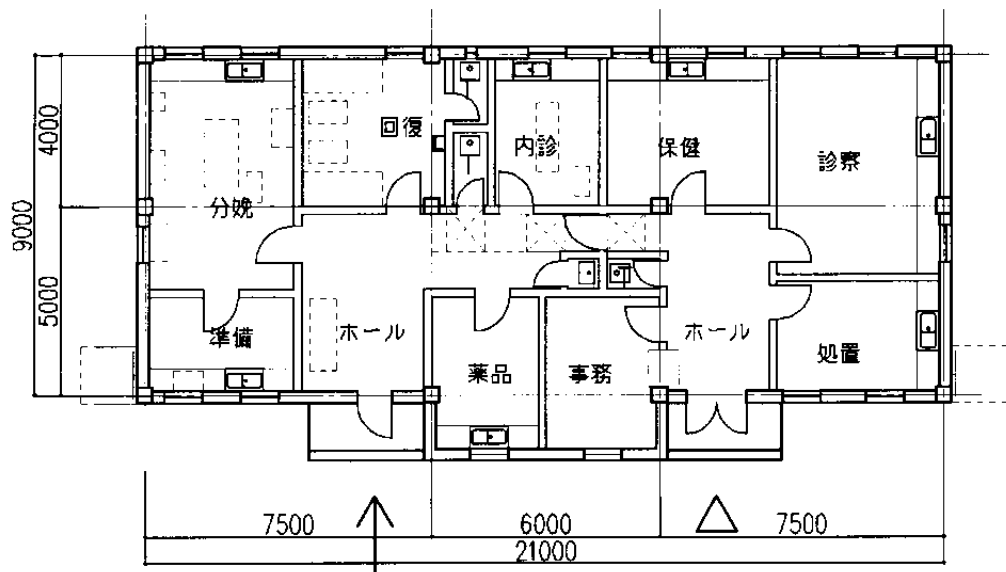

平面図 1/200  
No.5 アユンスナン診療所  
(Ayoun Senan)

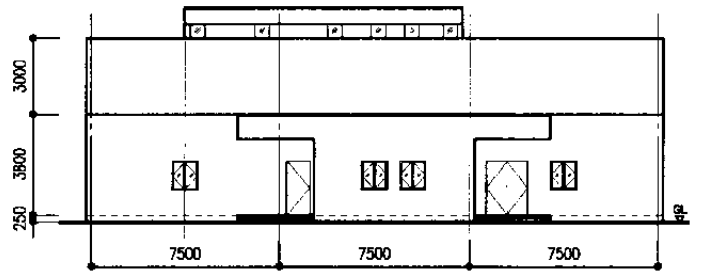
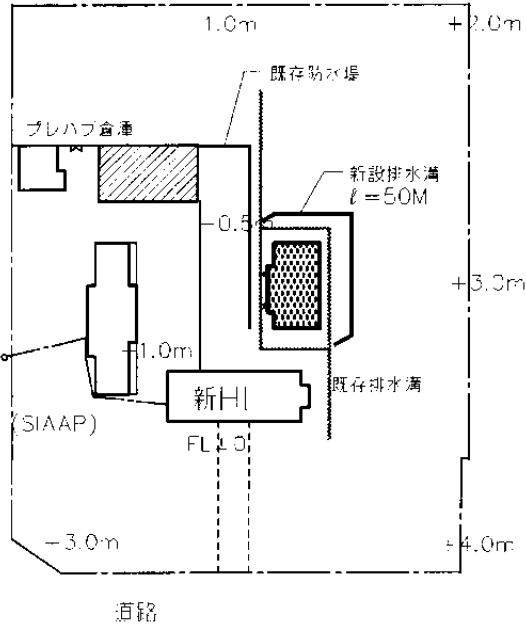

西立面図

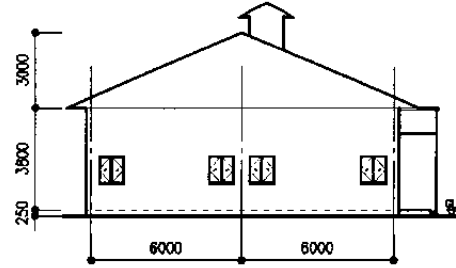

北立面図

配置図 1/2000  
立面図 1/300

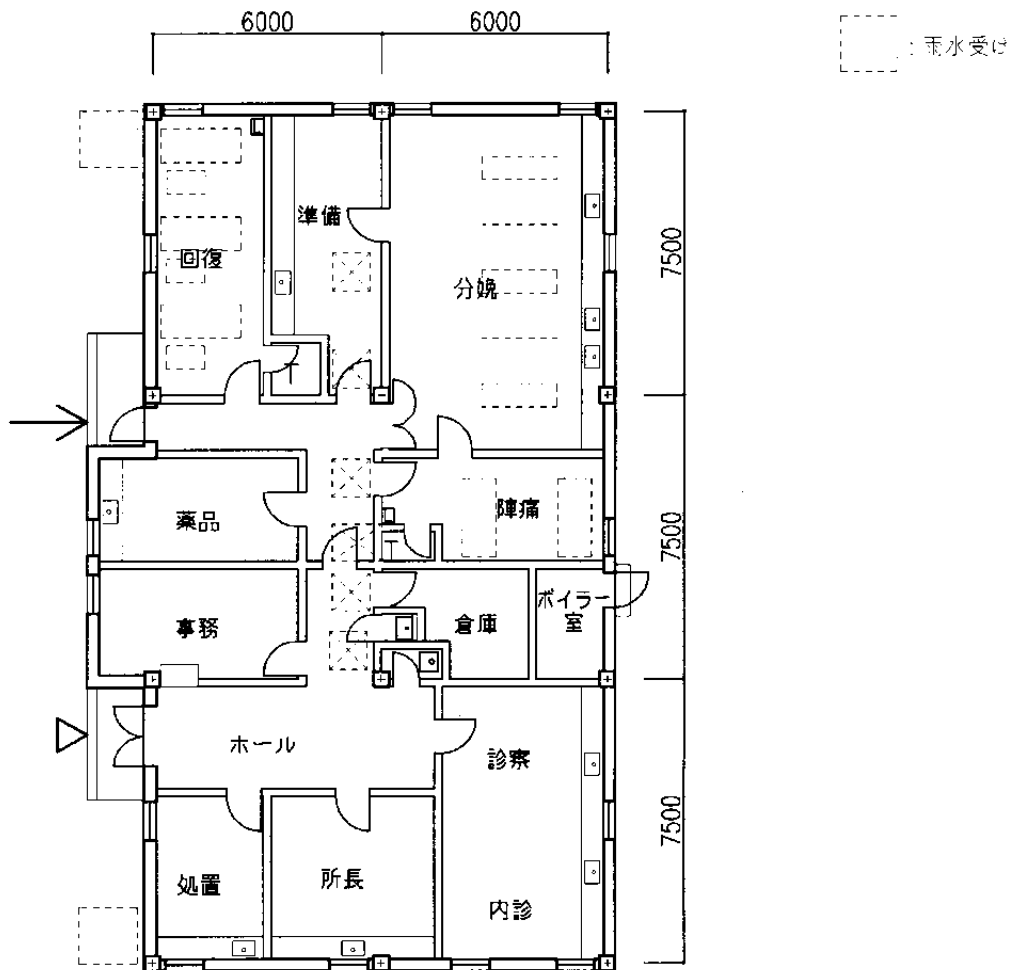

平面図 1/200  
No.6 ブルマン地域病院  
(Boulemane)

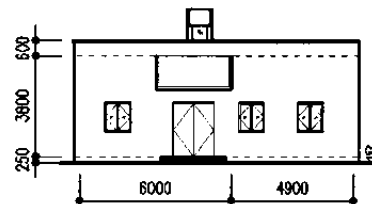

西立面図

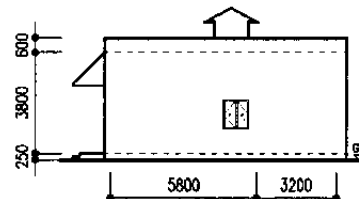

南立面図

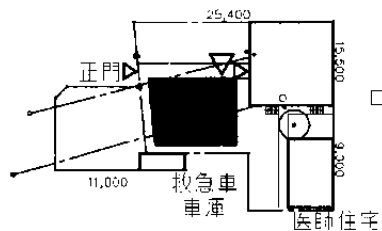

配置図 1/1000  
立面図 1/300

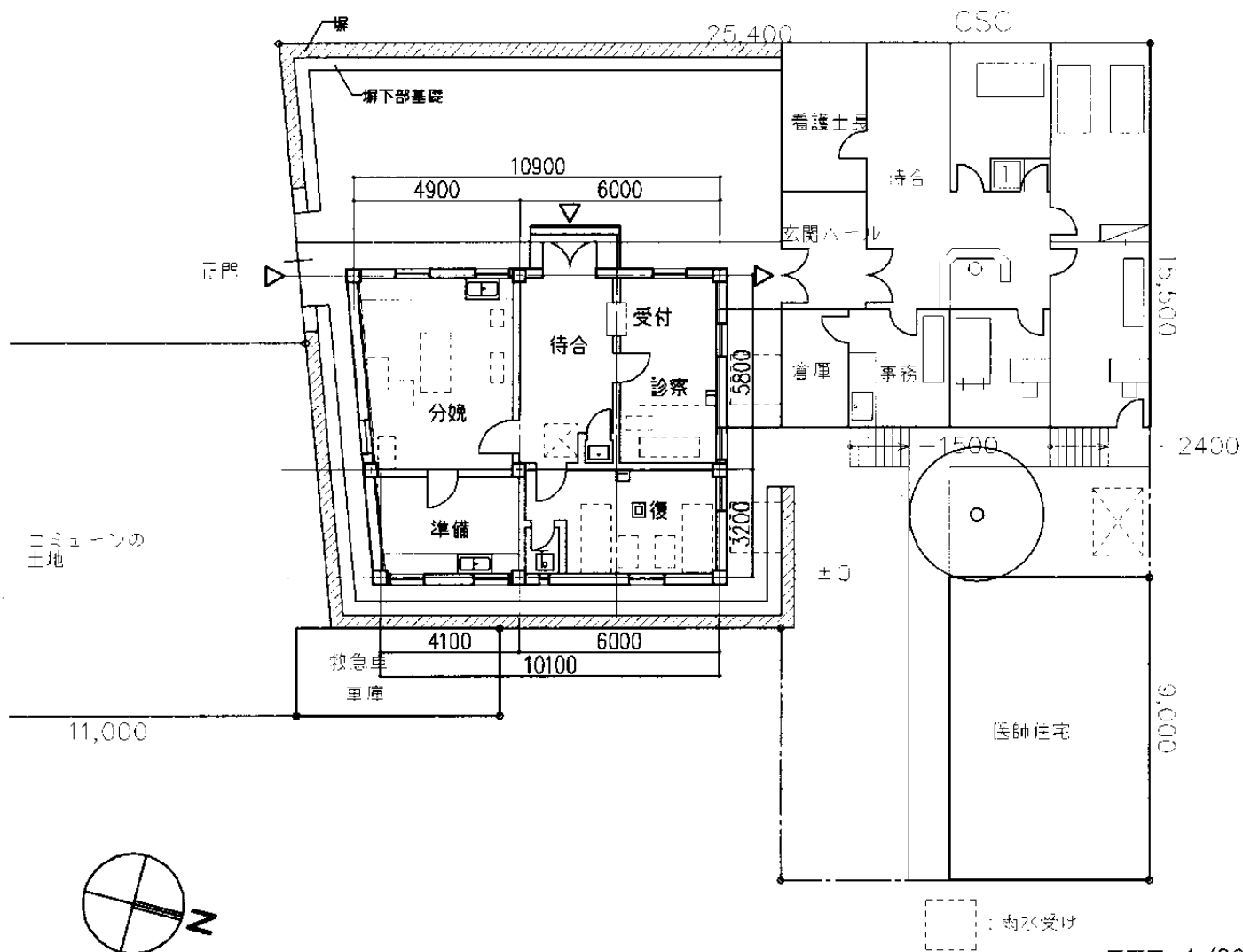

平面図 1/200  
No.7 スコラ保健センター  
(Skoura)

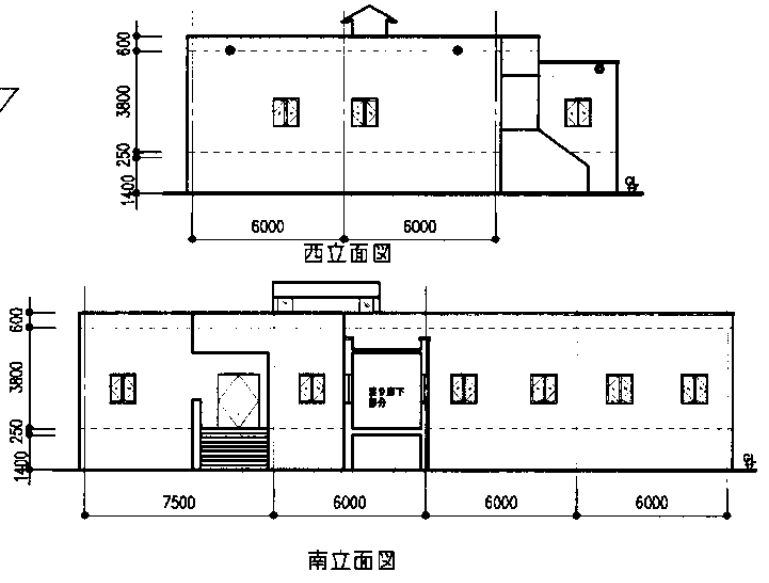
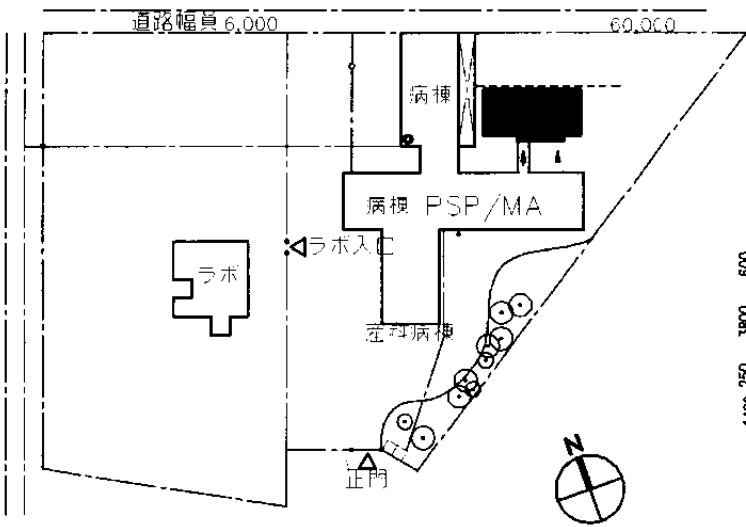

配置図 1/1000  
立面図 1/300

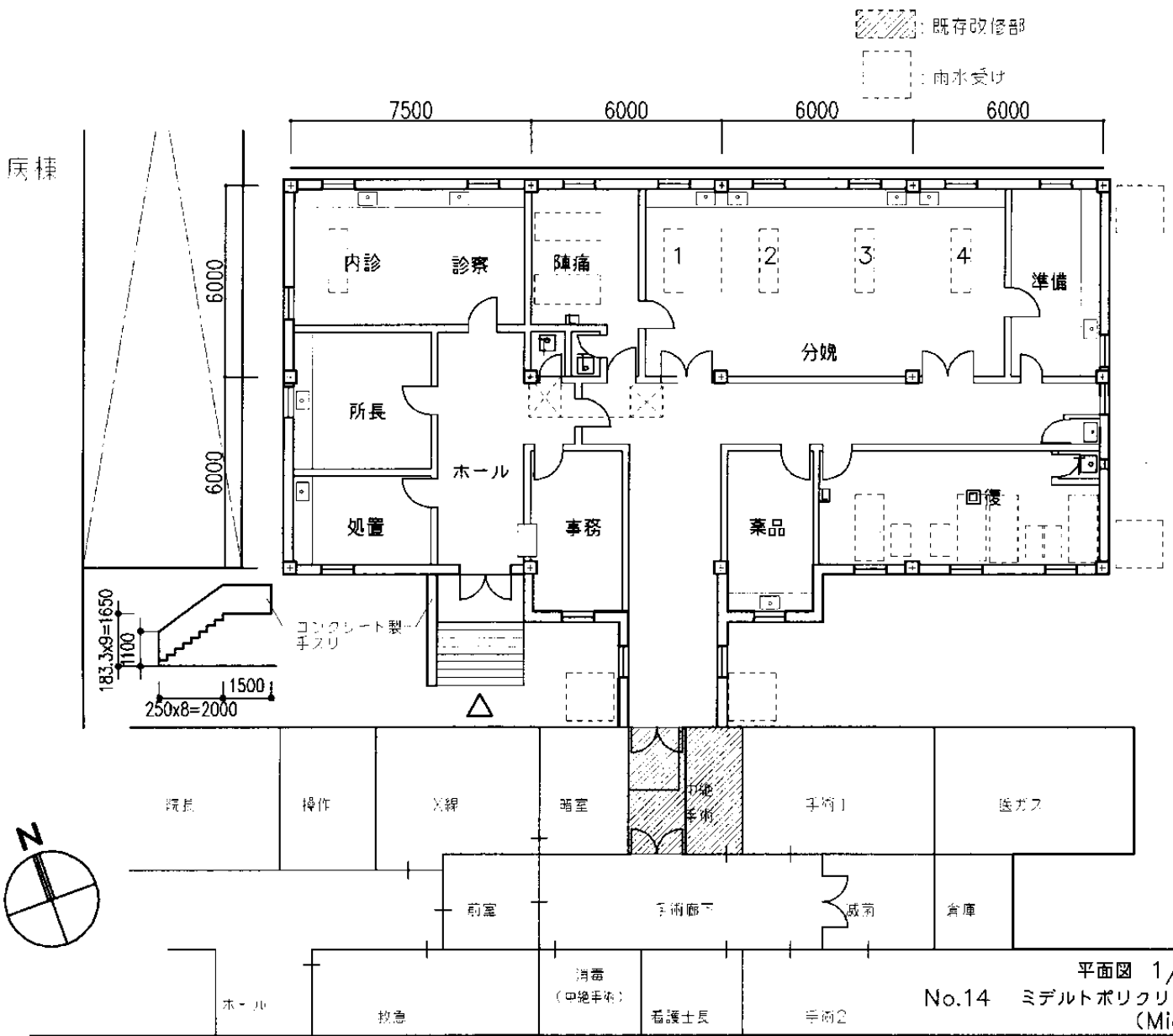



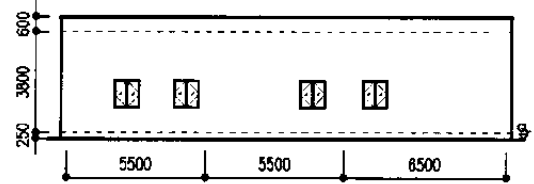
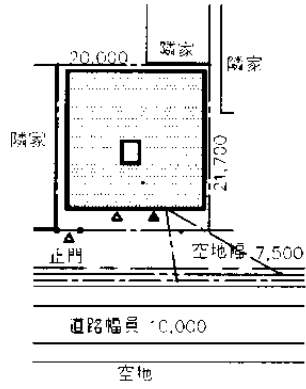

西立面図

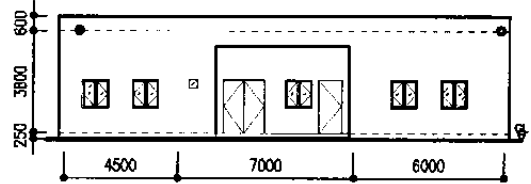

南立面図

配置図 1/1000  
立面図 1/300

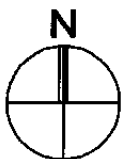
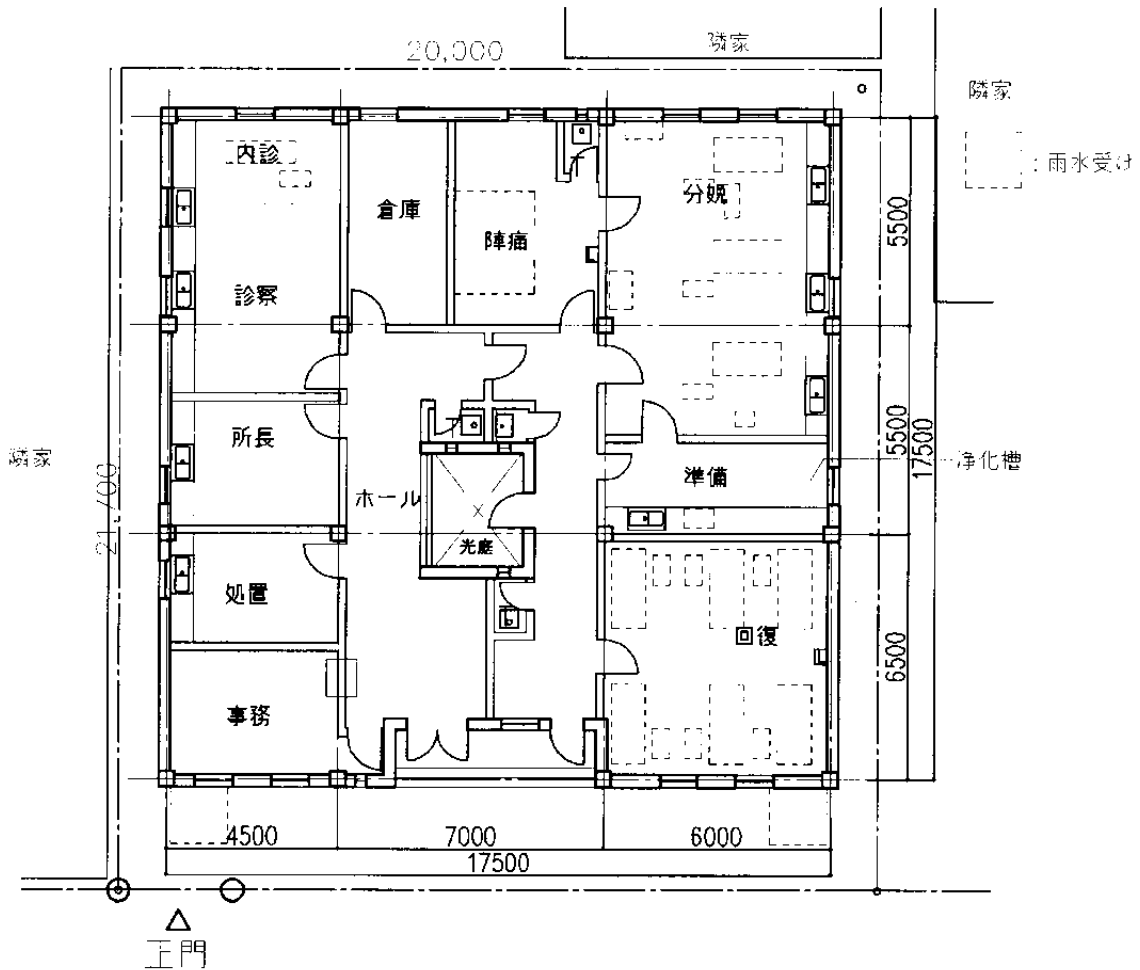

平面図 1/200  
No.15 ムリルト保健センター  
(Mirt)

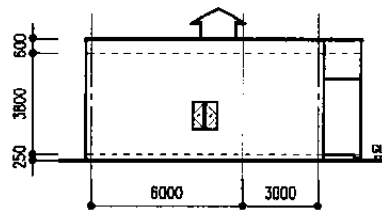
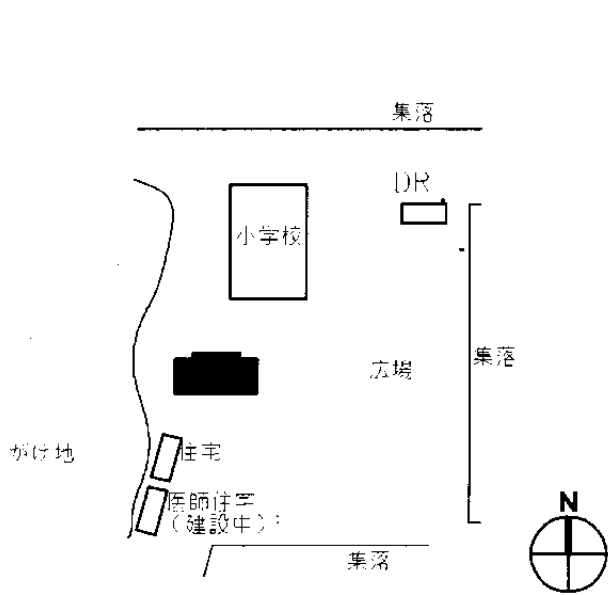

東立面図

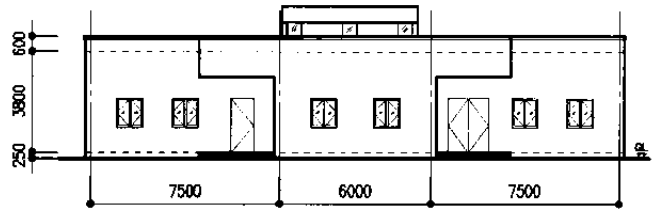

北立面図

配置図 1/1000  
立面図 1/300

雨水受け

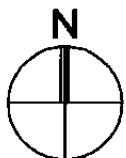
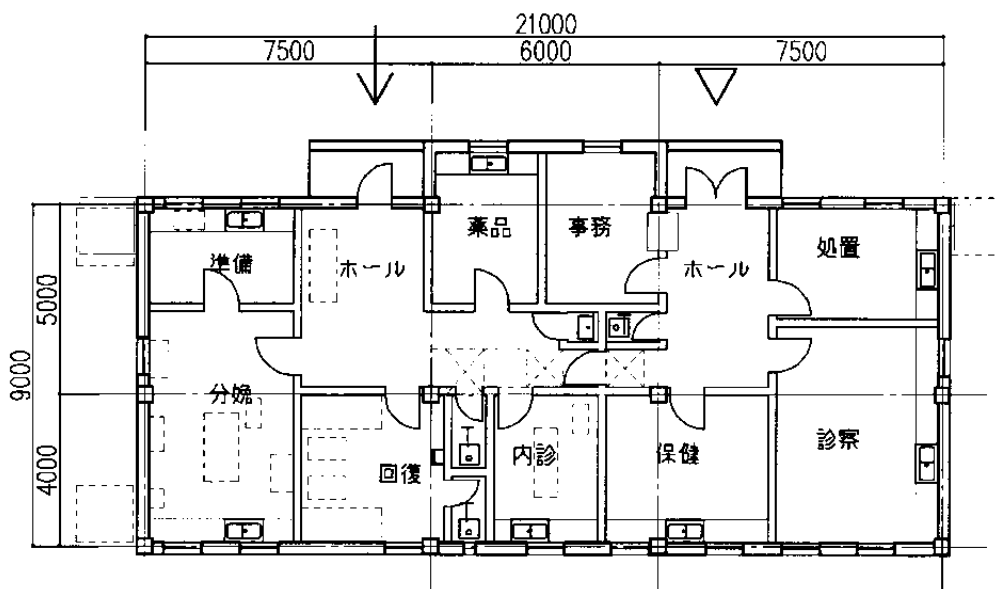

平面図 1/200  
No.16 ウマナ診療所  
(Oumana)

モロッコ王国母性ヘルスケア改善計画基本設計調査

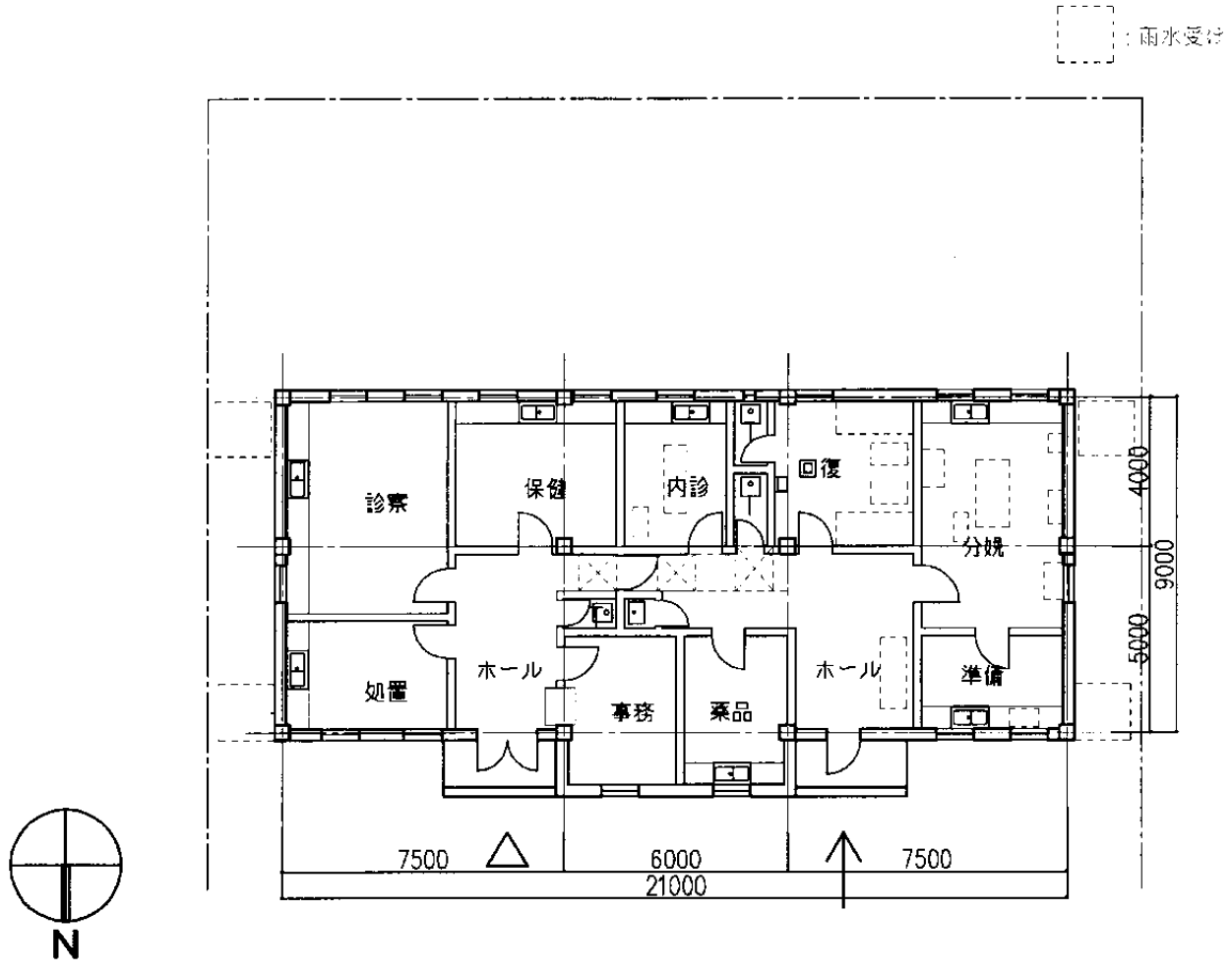
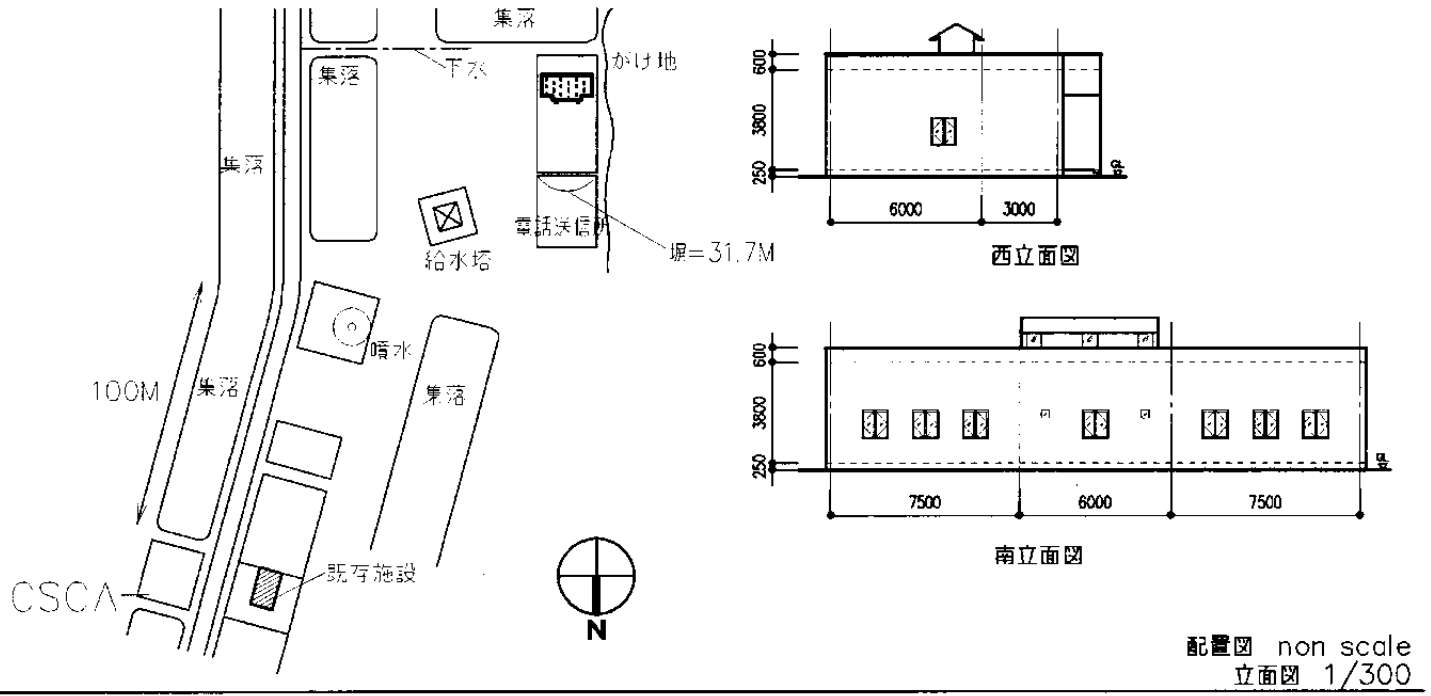

平面図 1/200  
 No.17 ティサリン保健センター  
 (Tighsline)

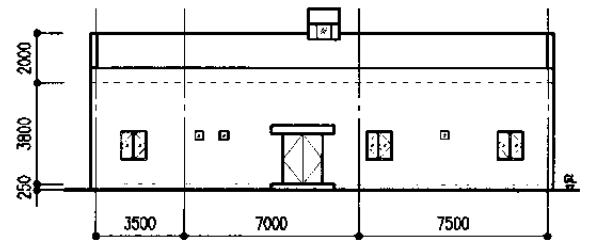
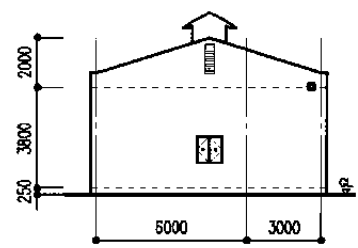
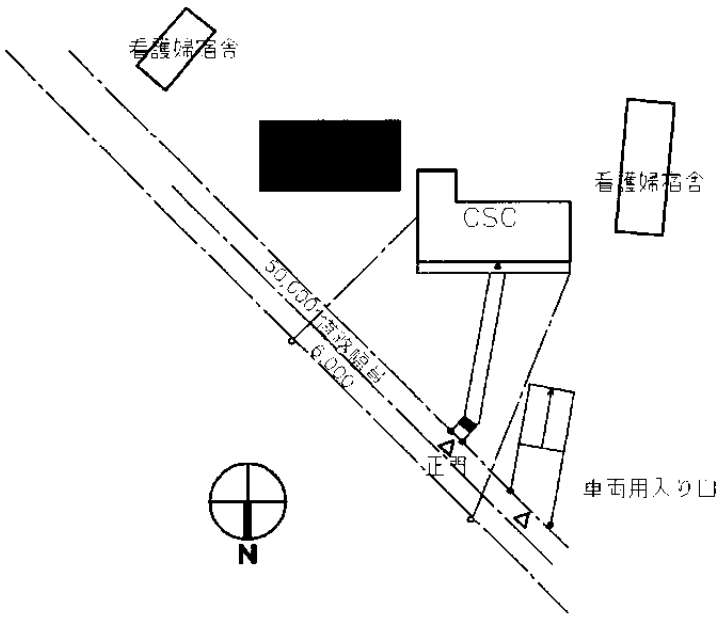

配置図 1/1000  
立面図 1/300

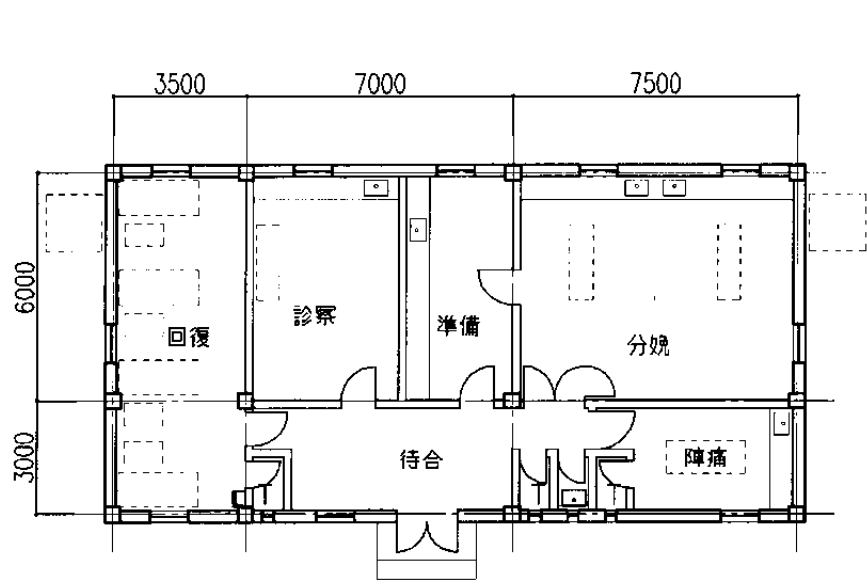

雨水受け (Rainwater Catcher)

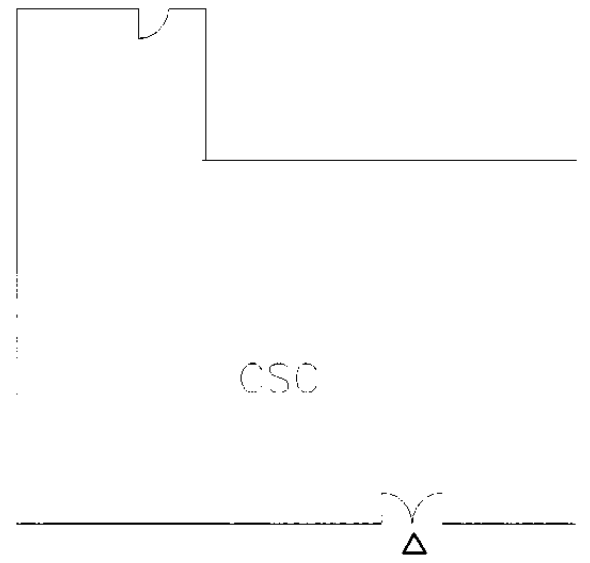

平面図 1/200  
No.18 トゥネフィット保健センター  
(Tounefite)

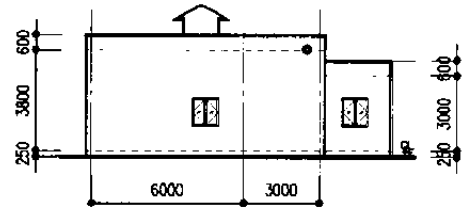
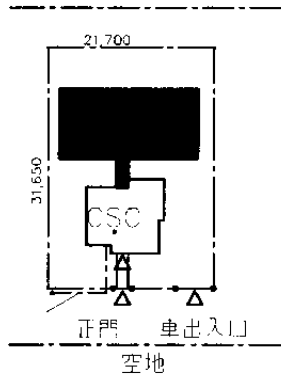

西立面図

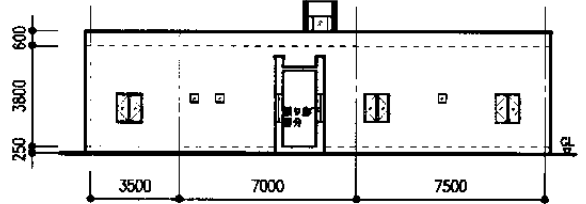

南立面図

配置図 1/1000  
立面図 1/300

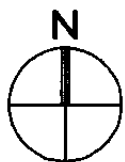
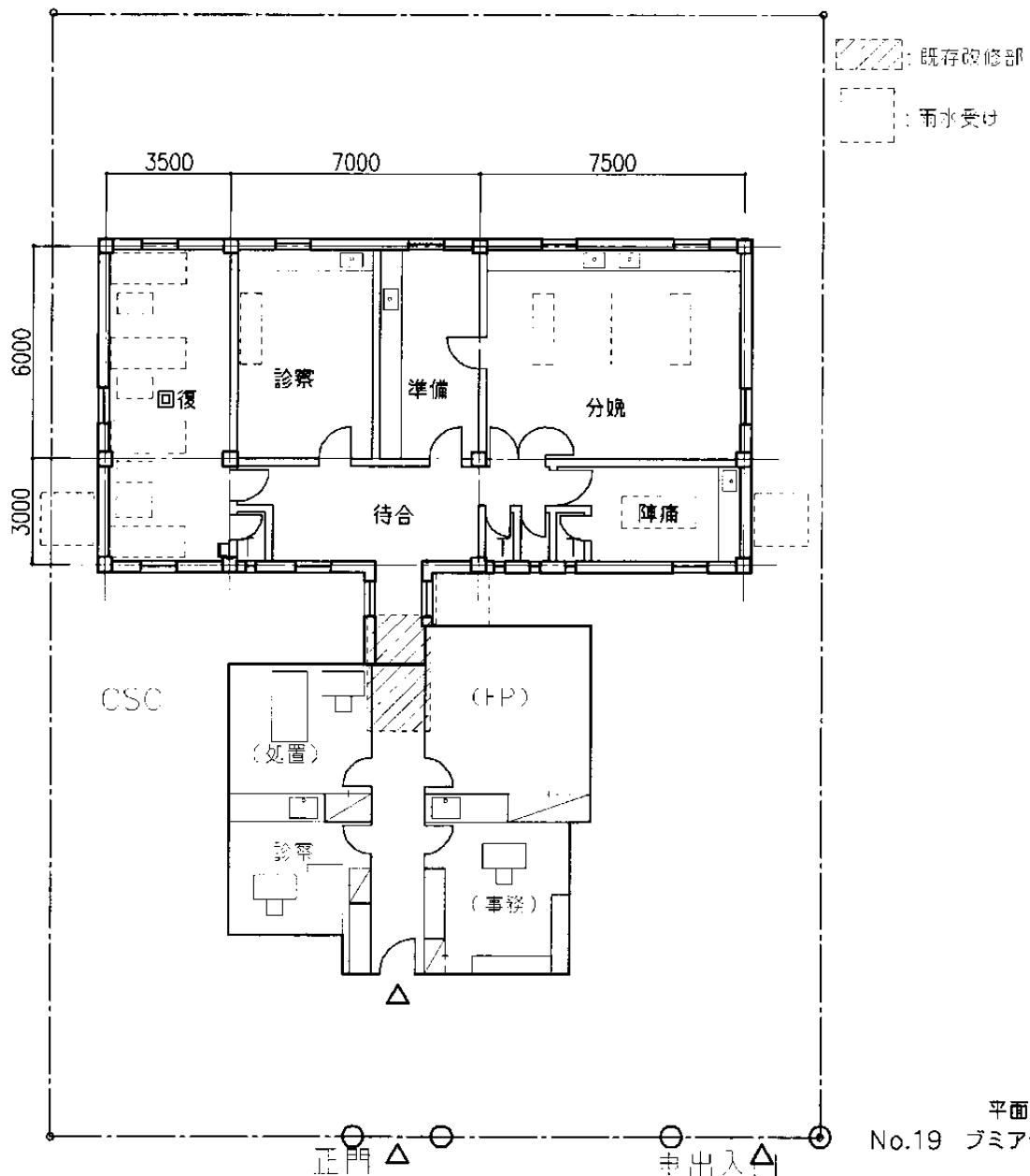

平面図 1/200  
No.19 プミア保健センター  
(Boumia)

モロッコ王国母性ヘルスケア改善計画基本設計調査

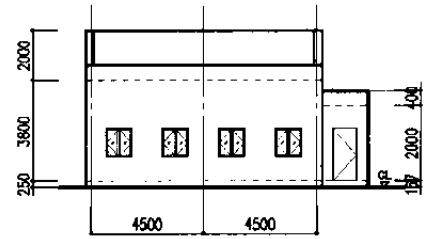
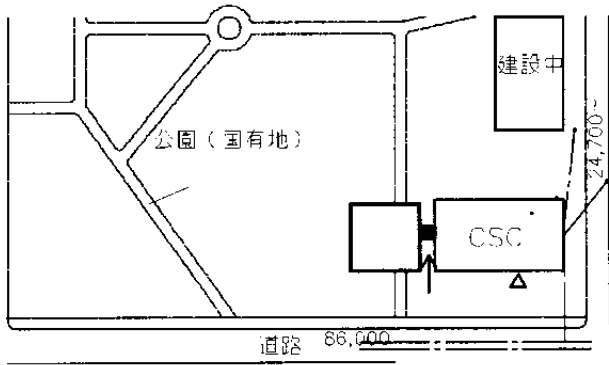

南立面図

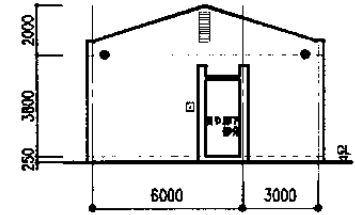

東立面図

配置図 1/1000  
立面図 1/300

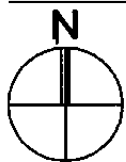
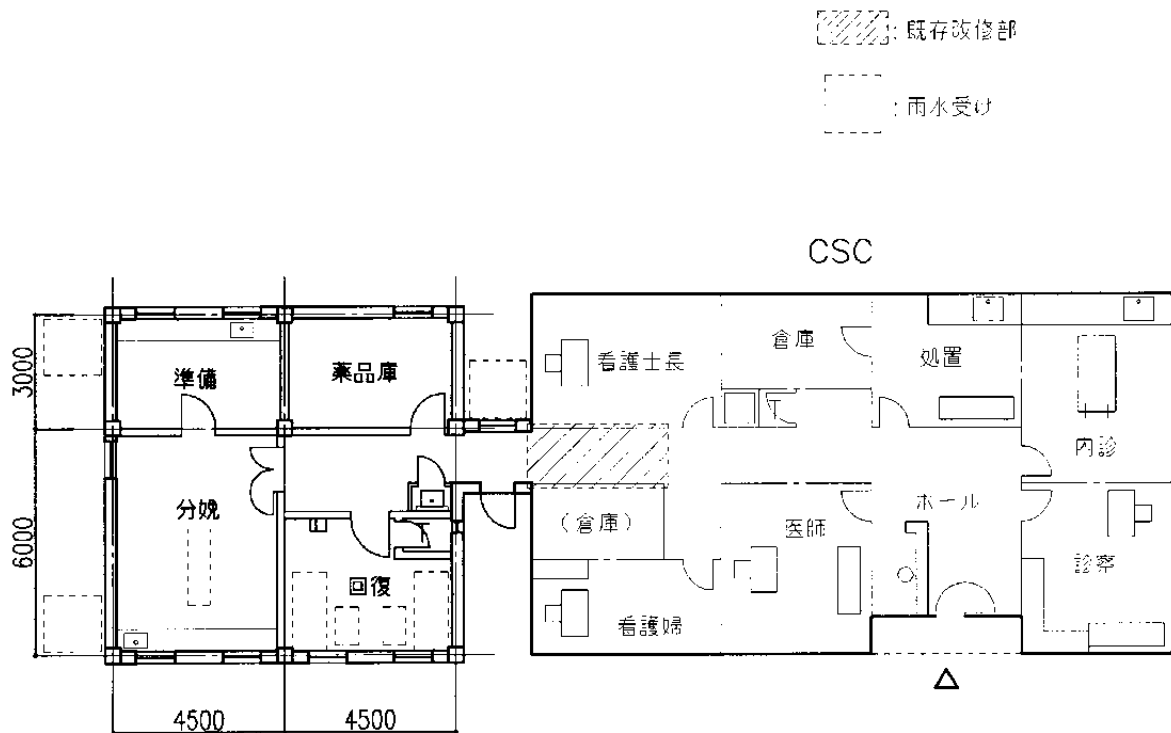

平面図 1/200  
No.22 イフラン保健センター  
(Ifrane)

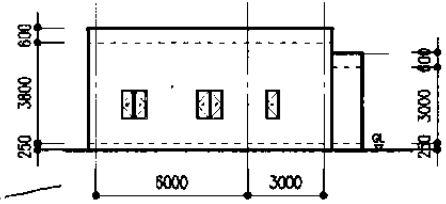
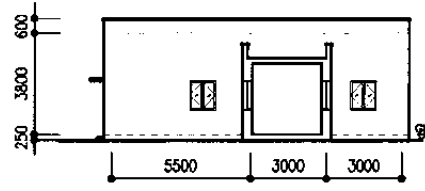
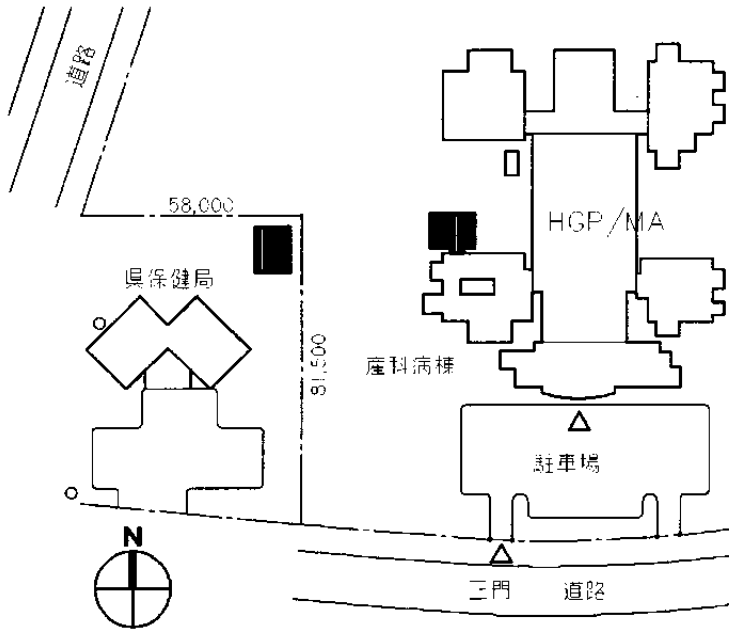

配置図 1/2000  
立面図 1/300

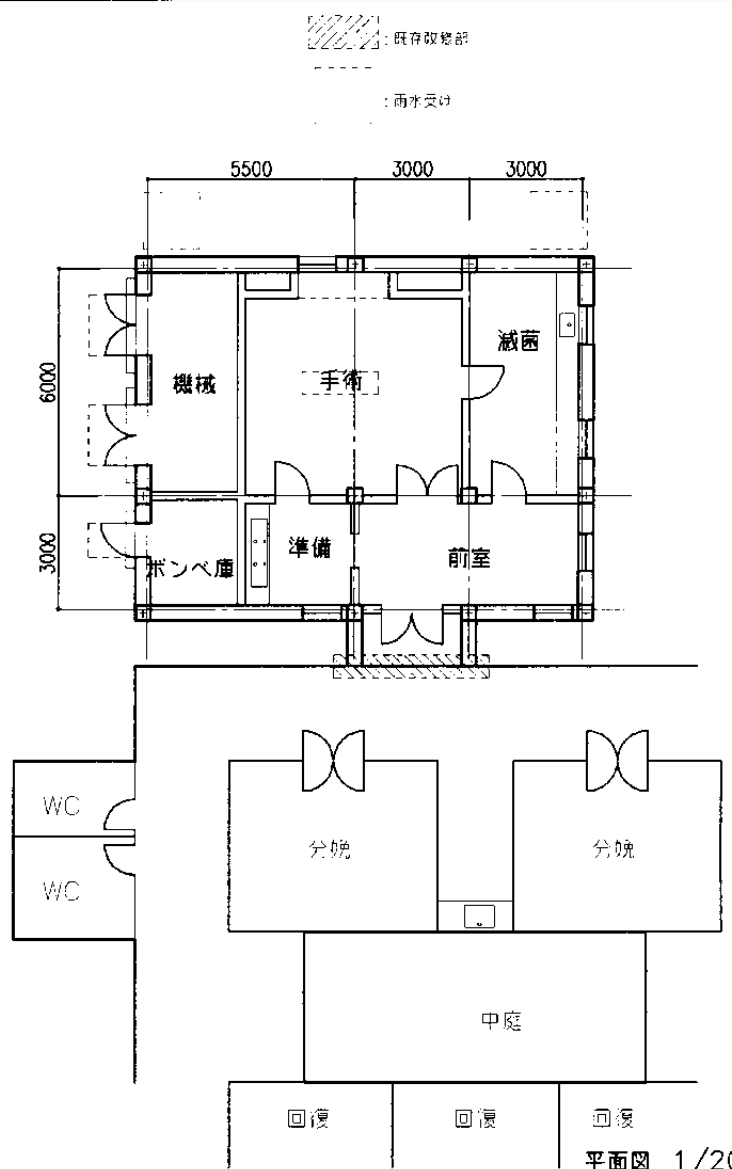
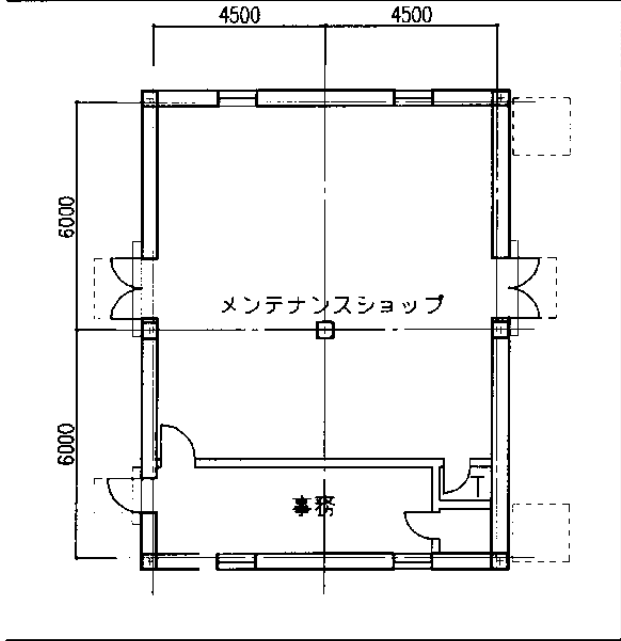

平面図 1/200

No.26 グルミン県病院 (Guelmim)

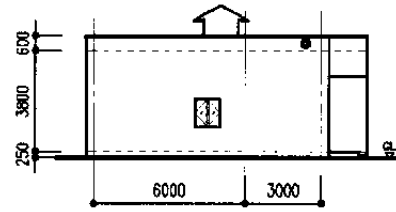
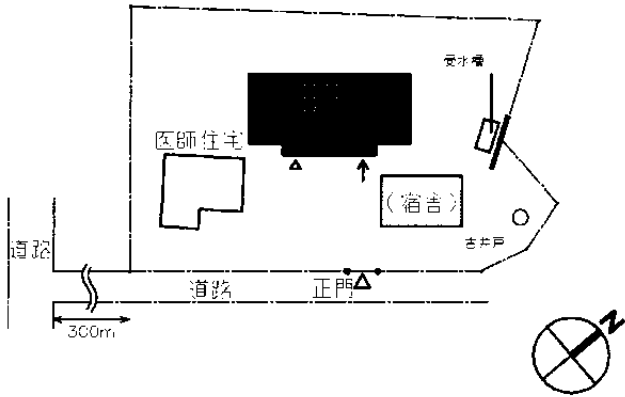

西立面図

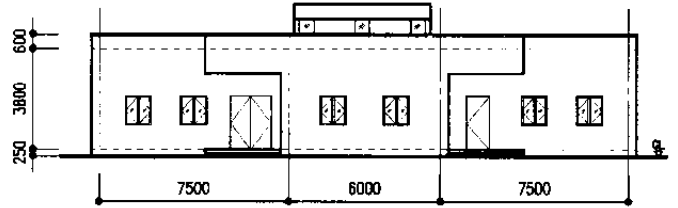

南立面図

配置図 1/1000  
立面図 1/300

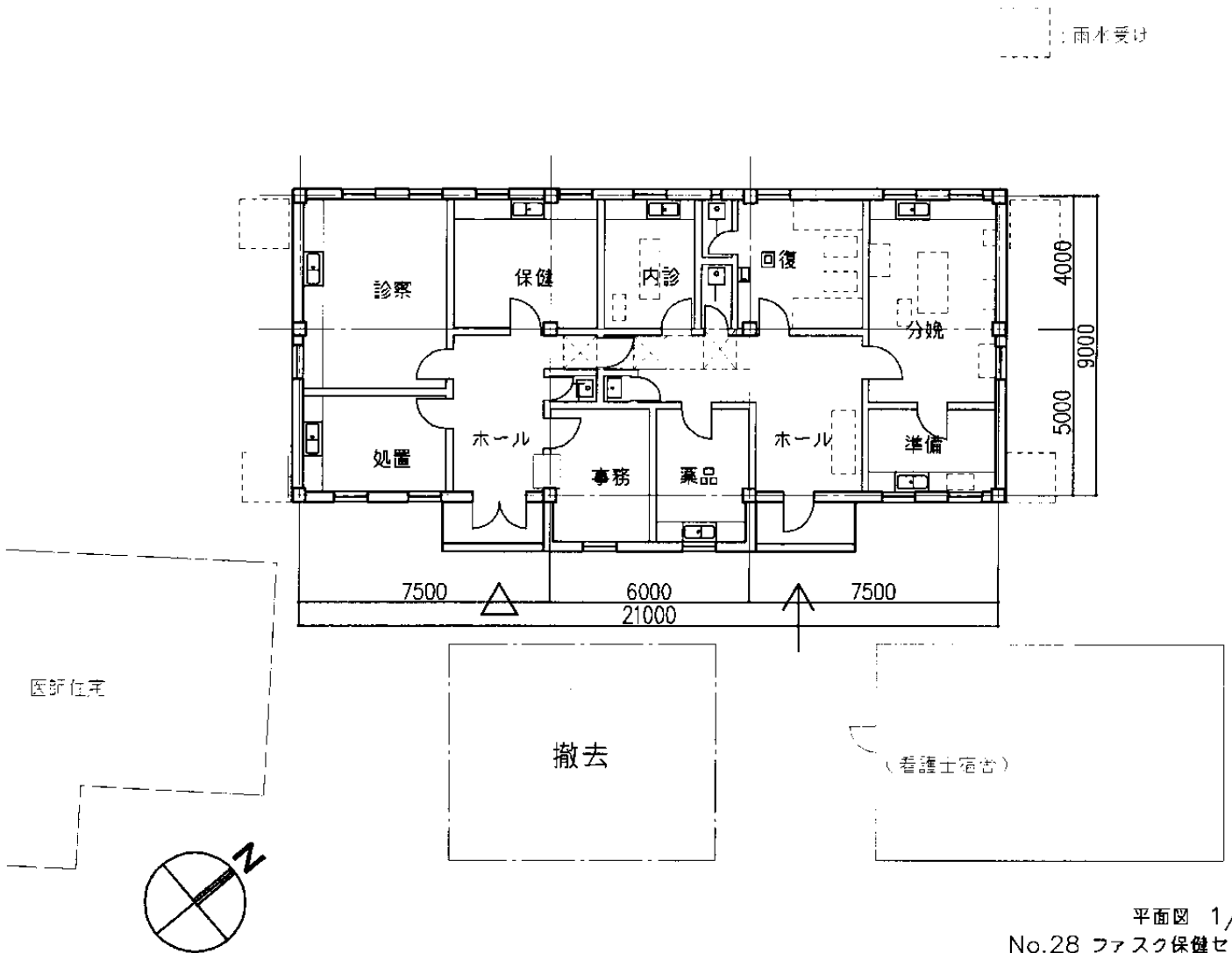

平面図 1/200  
No.28 ファスク保健センター  
(Fask)



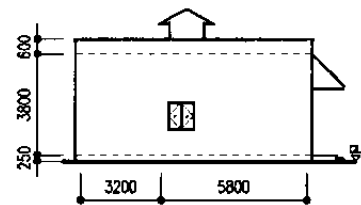
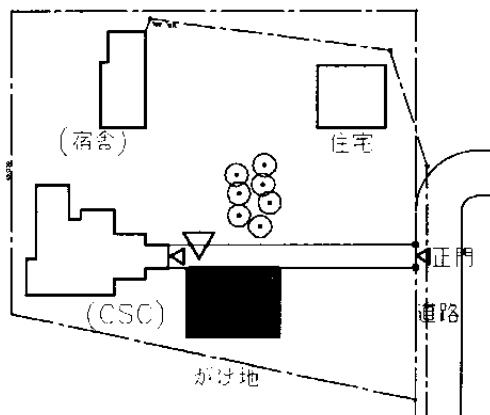

東立面図

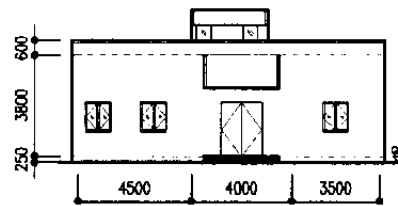

北立面図

配置図 1/1000  
立面図 1/300

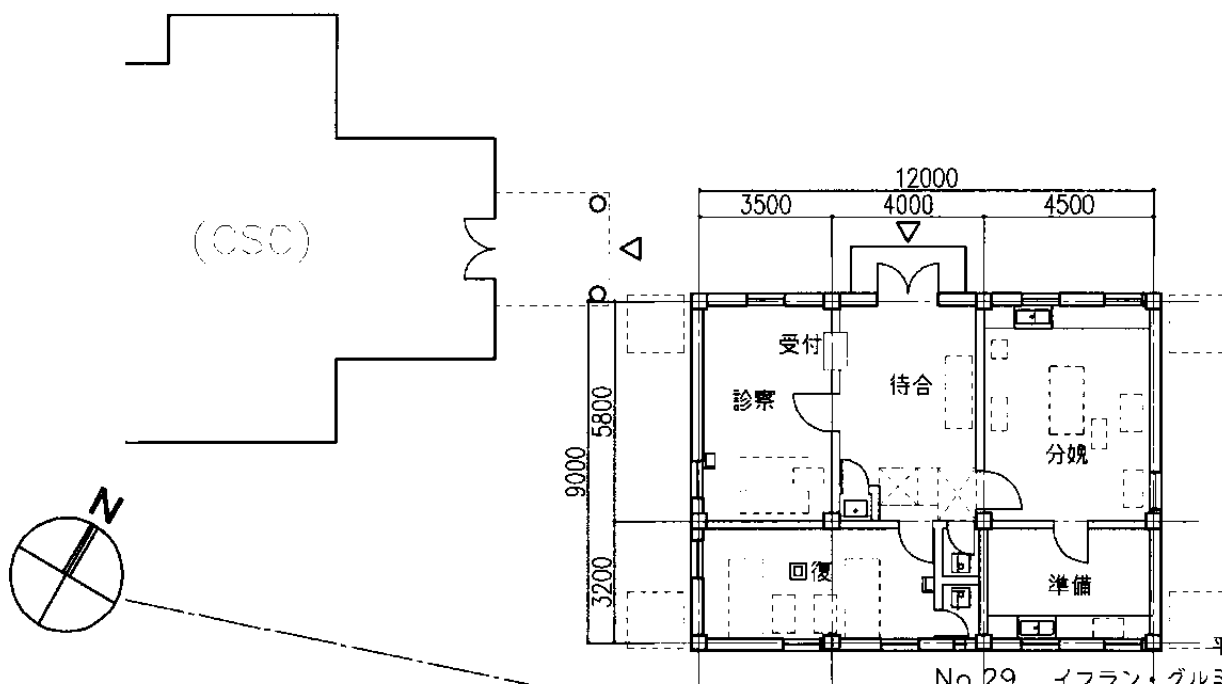
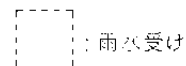

平面図 1/200  
No.29 イフラン・グルミン保健センター (Ifrane Guelmim)

モロッコ王国母性ヘルスケア改善計画基本設計調査

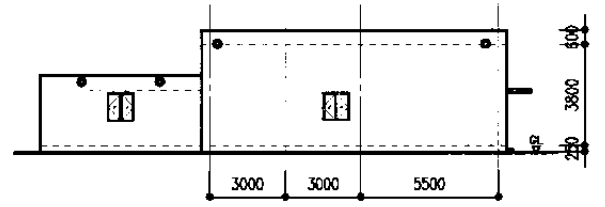
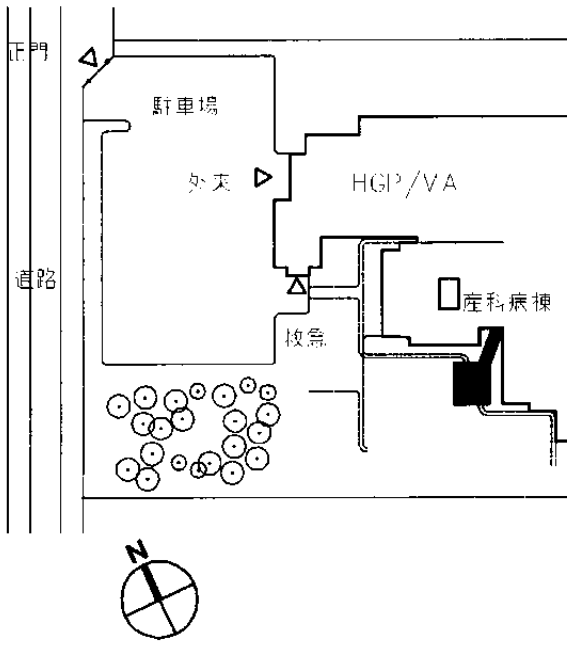

西立面図

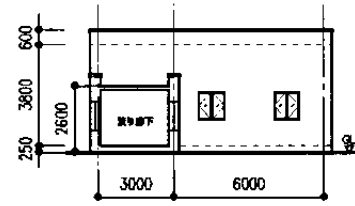

北立面図

配置図 1/2000  
立面図 1/300

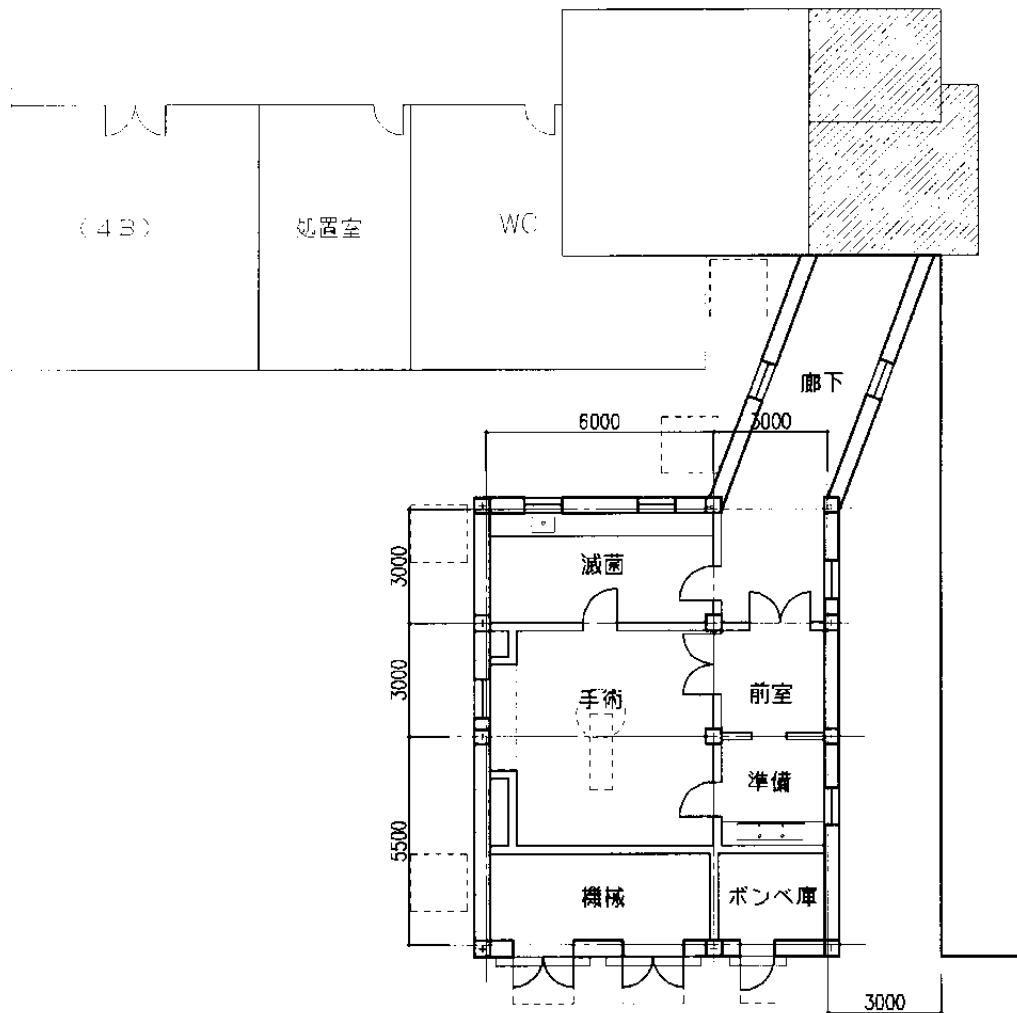

平面図 1/200  
No.30 ハッサン2世県病院  
(Hassan)

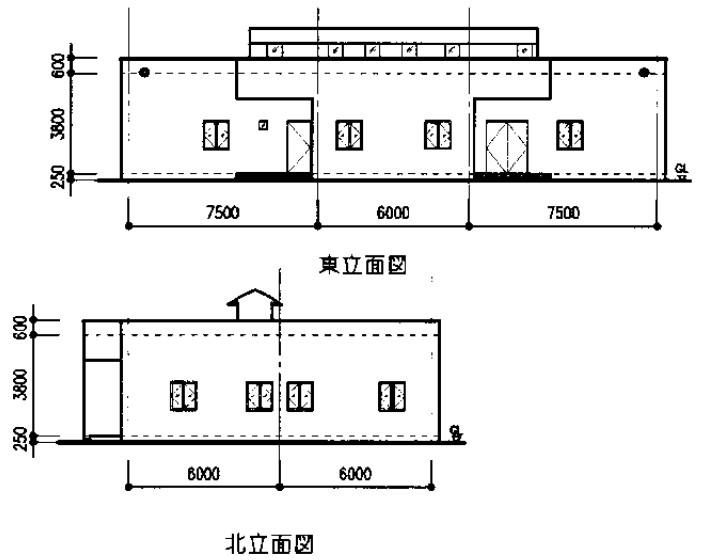
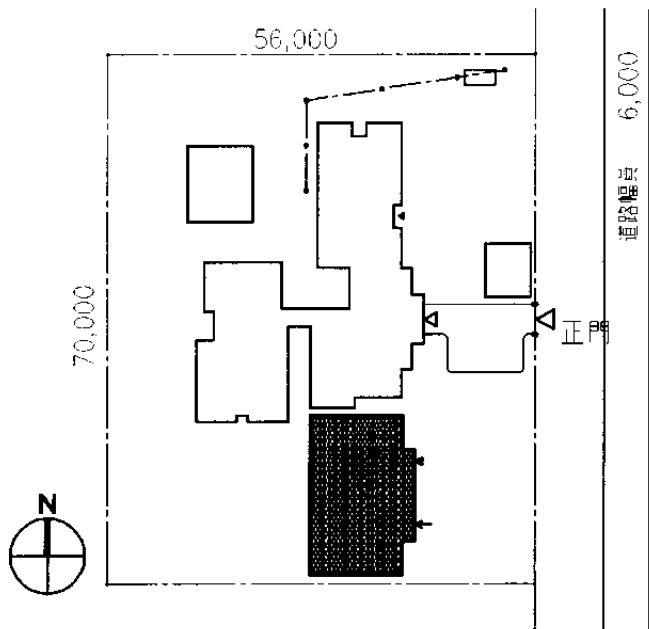

配置図 1/1000  
立面図 1/300

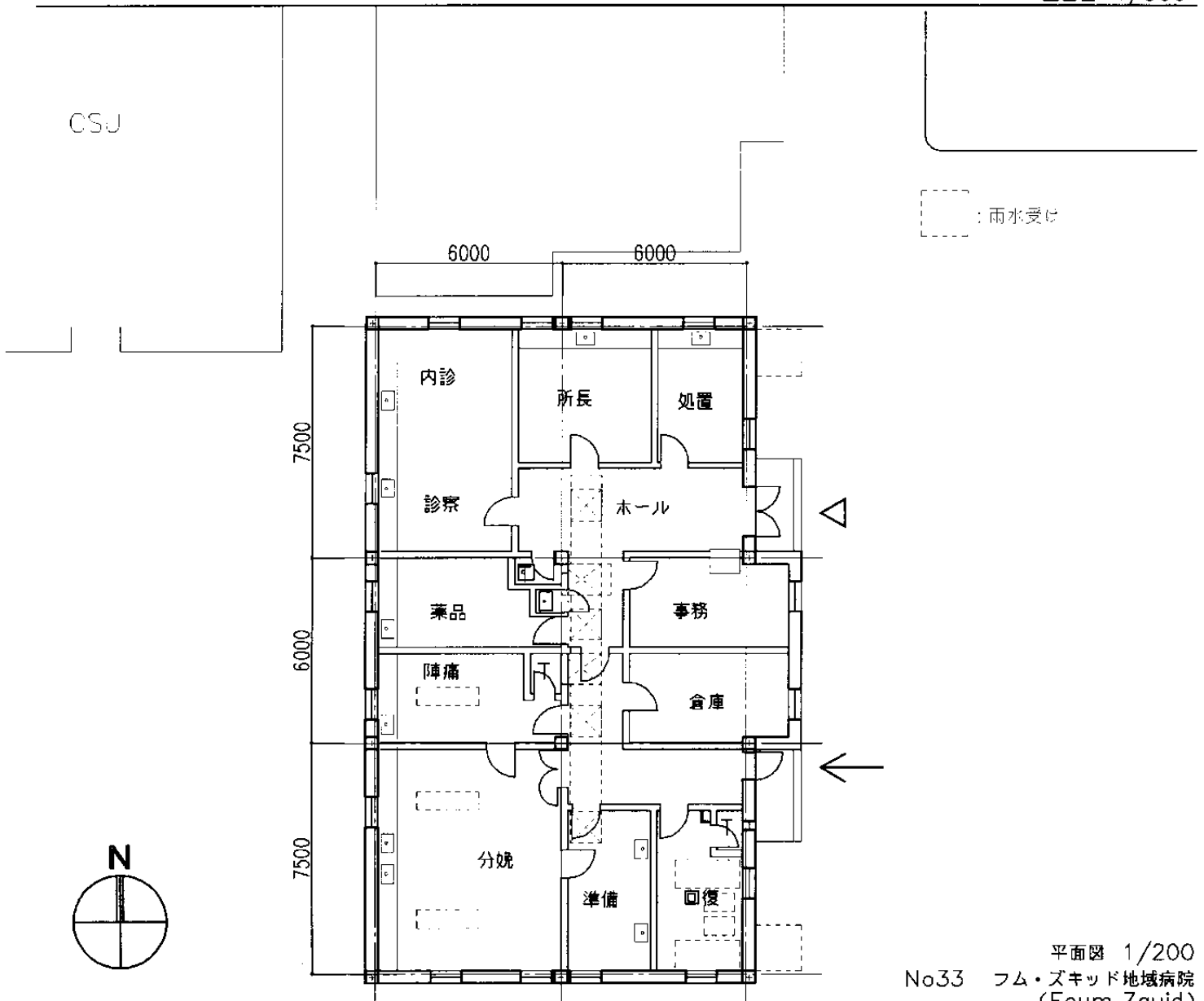

平面図 1/200  
No33 フム・ズキッド地域病院  
(Foum Zquid)

モロッコ王国母性ヘルスケア改善計画基本設計調査

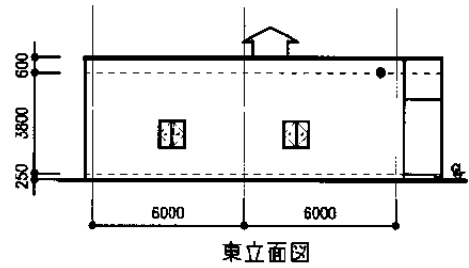
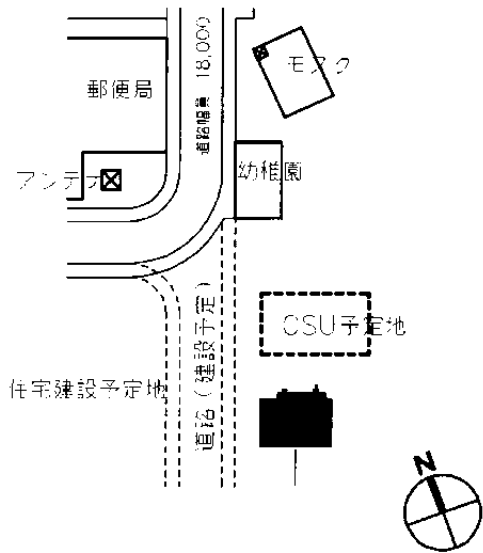

東立面図

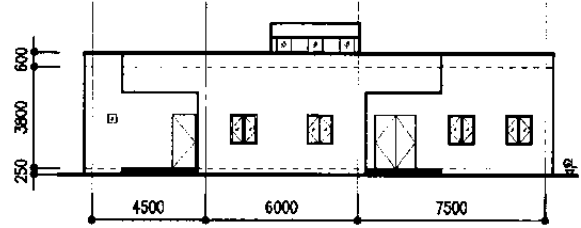

北立面図

配置図 1/2000  
立面図 1/300

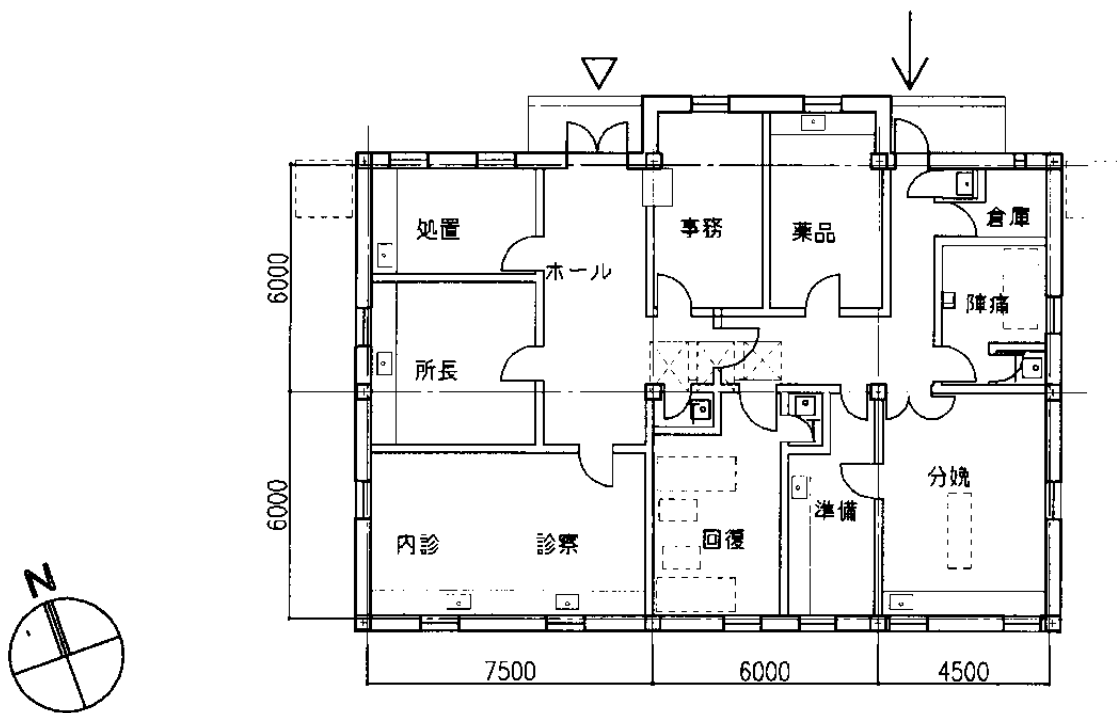
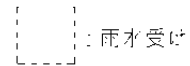
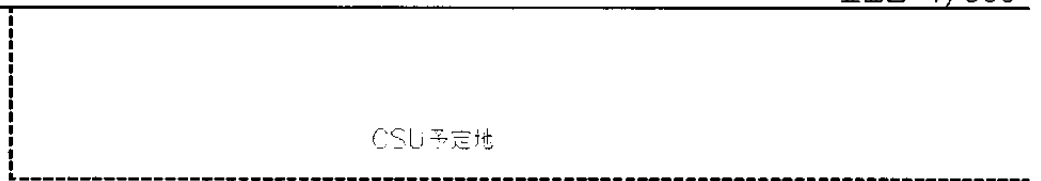

平面図 1/200

No.34 フム・エル・イシシ保健センター  
(Foum EL Hisin)

モロッコ王国母性ヘルスケア改善計画基本設計調査

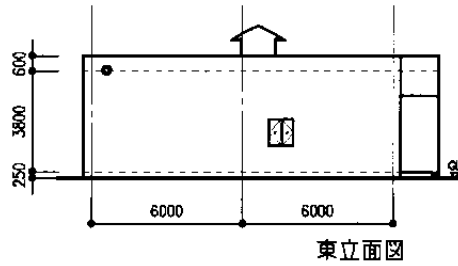
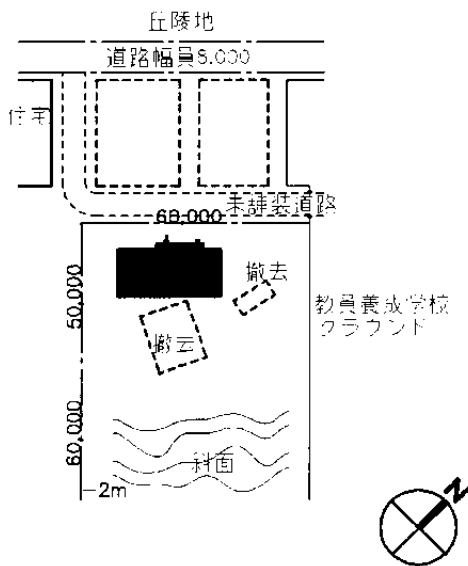

東立面図

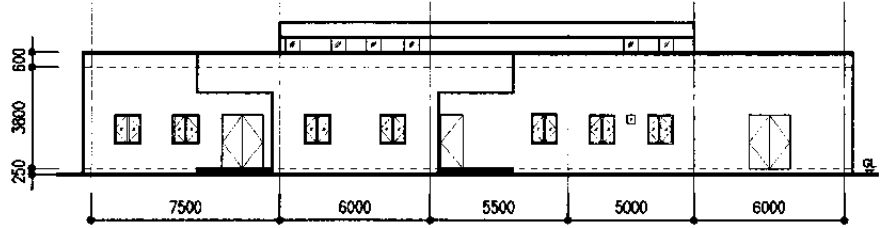

北立面図

配置図 1/2000  
立面図 1/300

未舗装道路

60,000

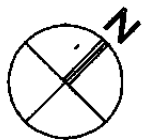
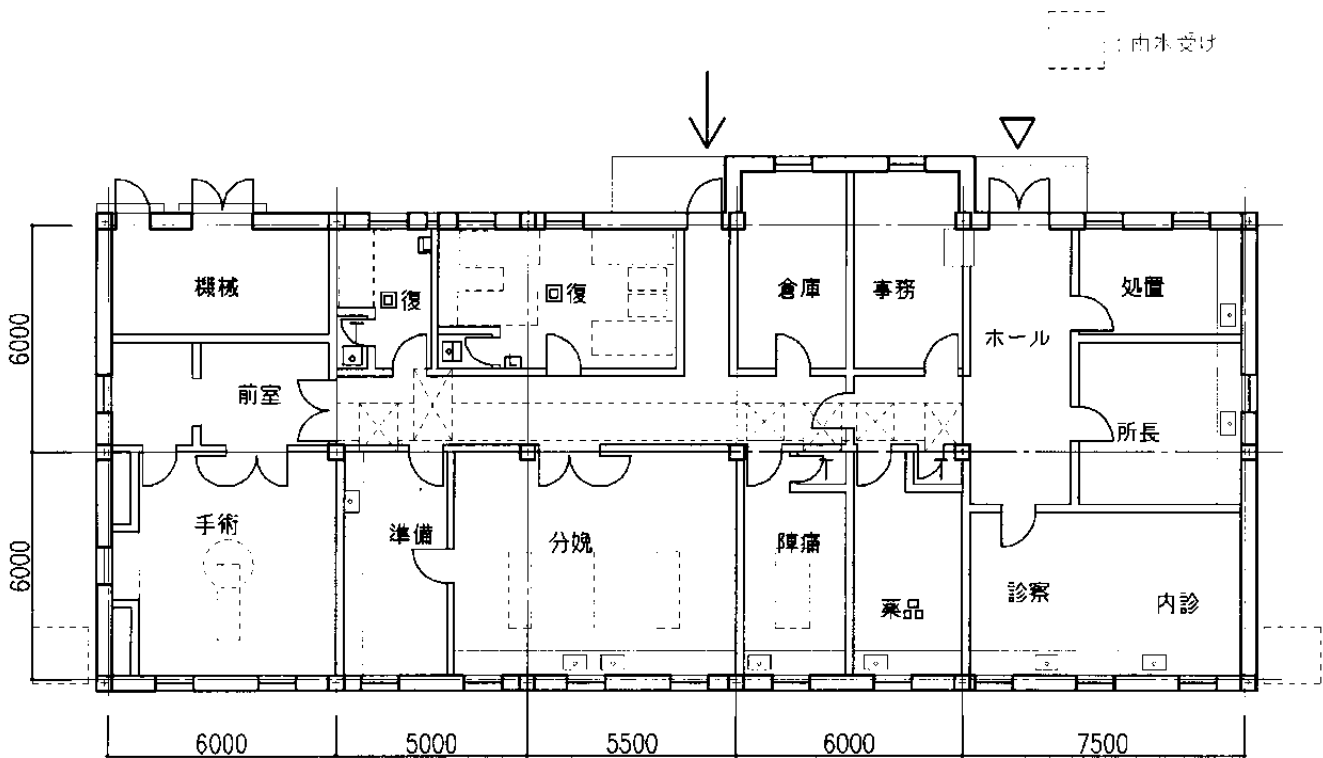

平面図 1/200  
No.37 タタ地域病院  
(TaTa)

モロッコ王国母性ヘルスケア改善計画基本設計調査