

モロッコ国地方水資源開発計画調査

最終報告書

和文要約

添付図

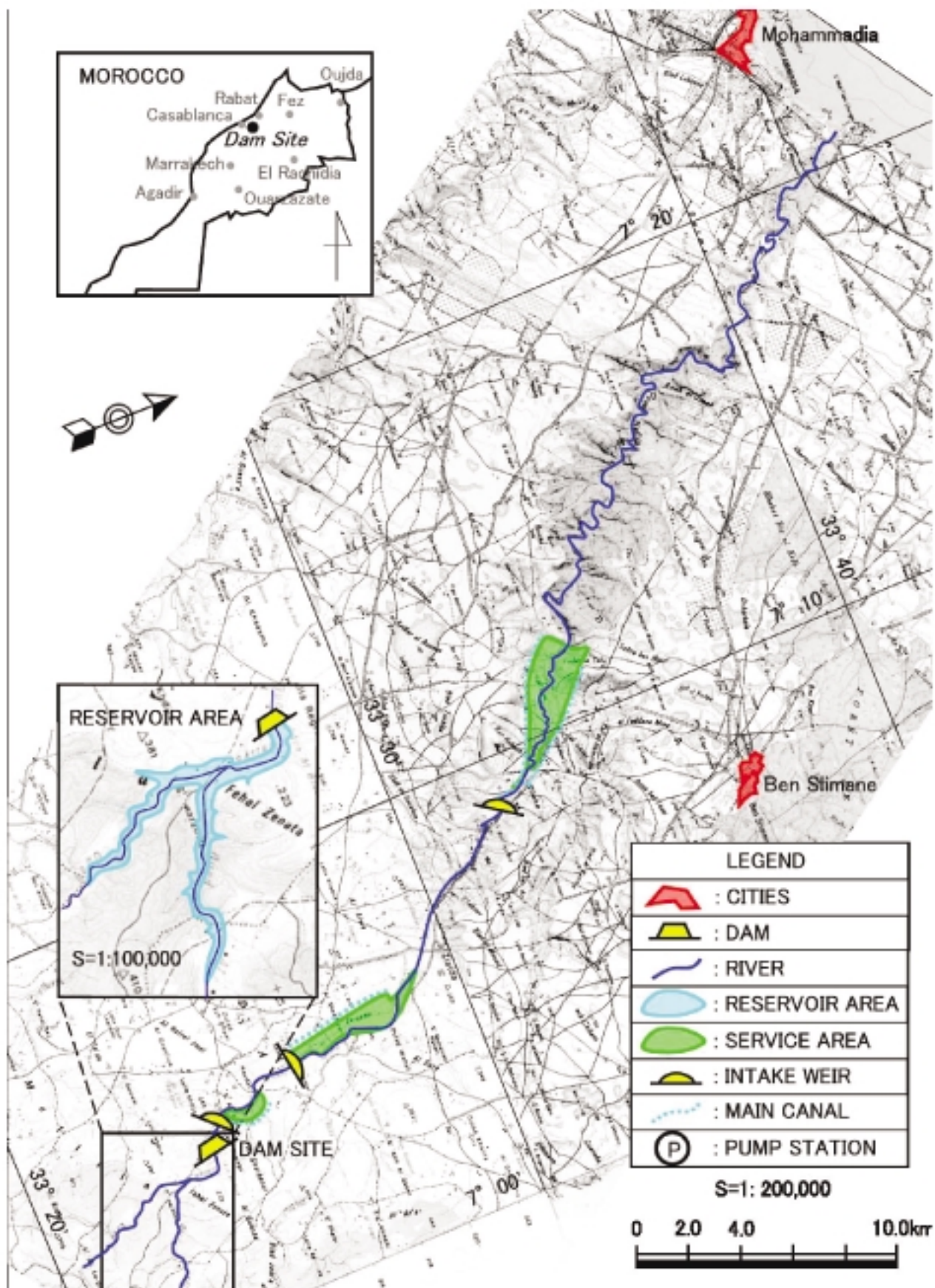

FEASIBILITY STUDY ON
WATER RESOURCES DEVELOPMENT
IN RURAL AREA

Figure S1

N'Fifikh案件位置図

JAPAN INTERNATIONAL COOPERATION AGENCY

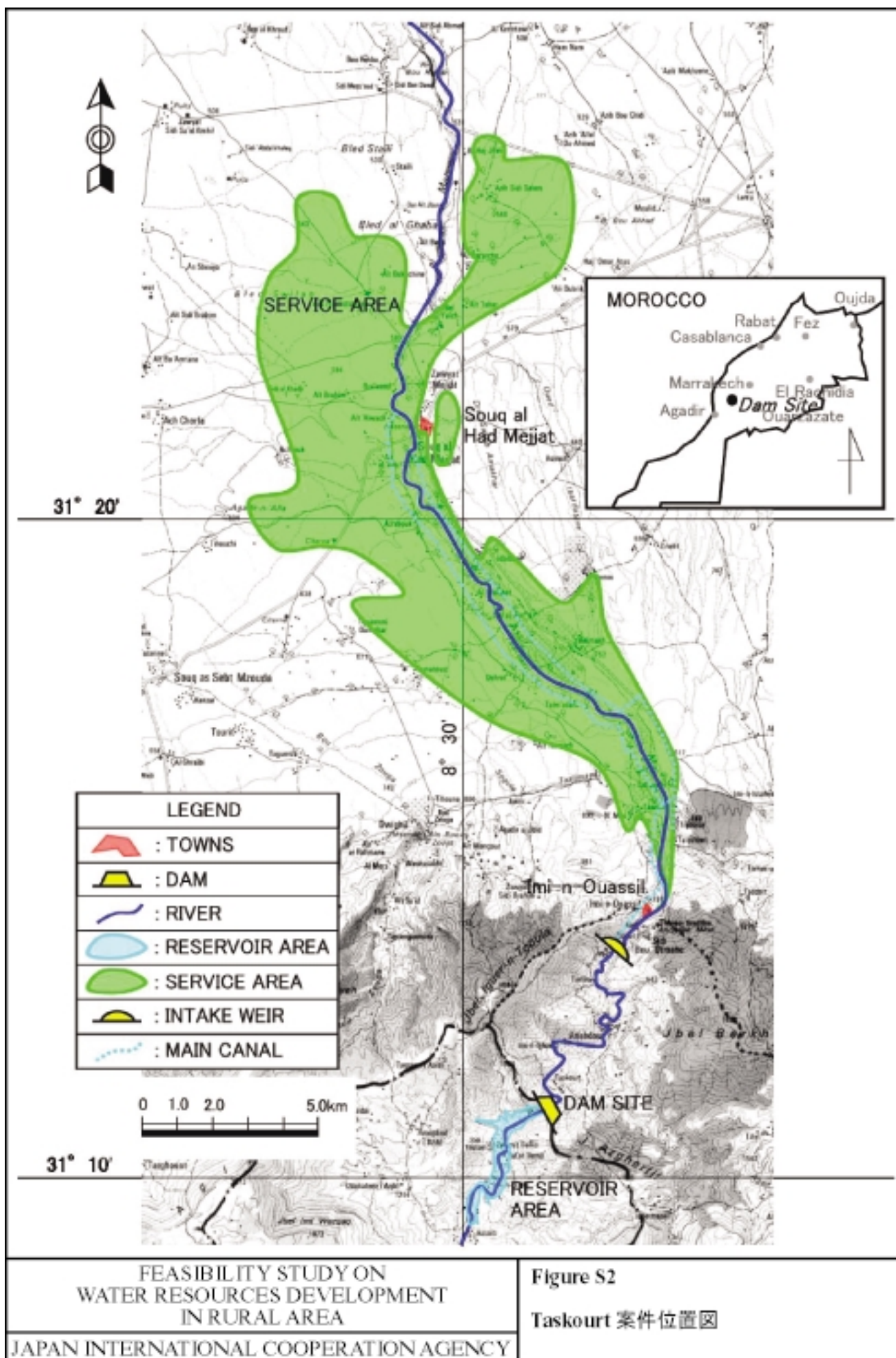

FEASIBILITY STUDY ON
WATER RESOURCES DEVELOPMENT
IN RURAL AREA

Figure S2

Taskourt 案件位置図

JAPAN INTERNATIONAL COOPERATION AGENCY

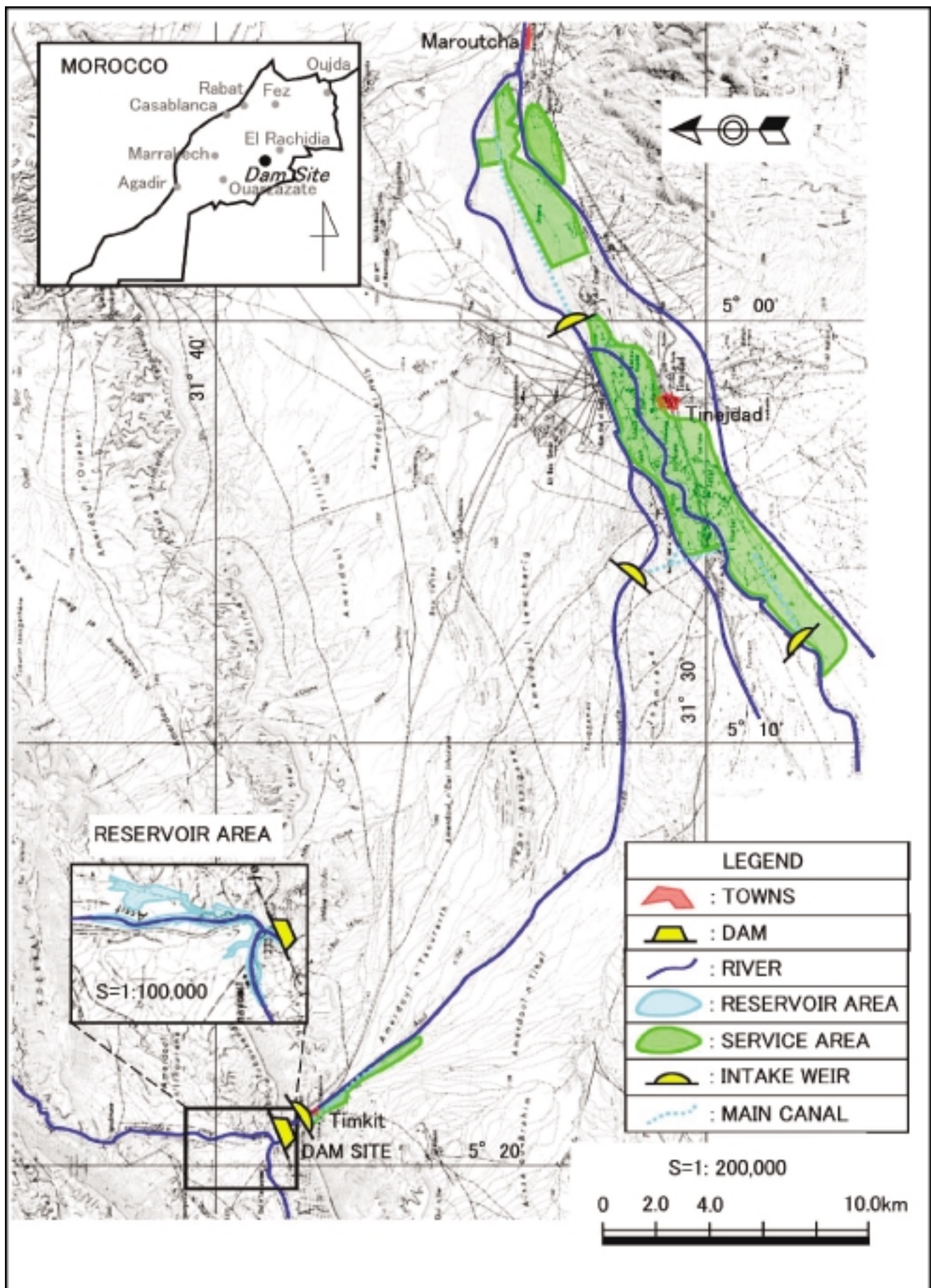

FEASIBILITY STUDY ON
WATER RESOURCES DEVELOPMENT
IN RURAL AREA

Figure 1.2.3

Timkit 案件位置図

JAPAN INTERNATIONAL COOPERATION AGENCY

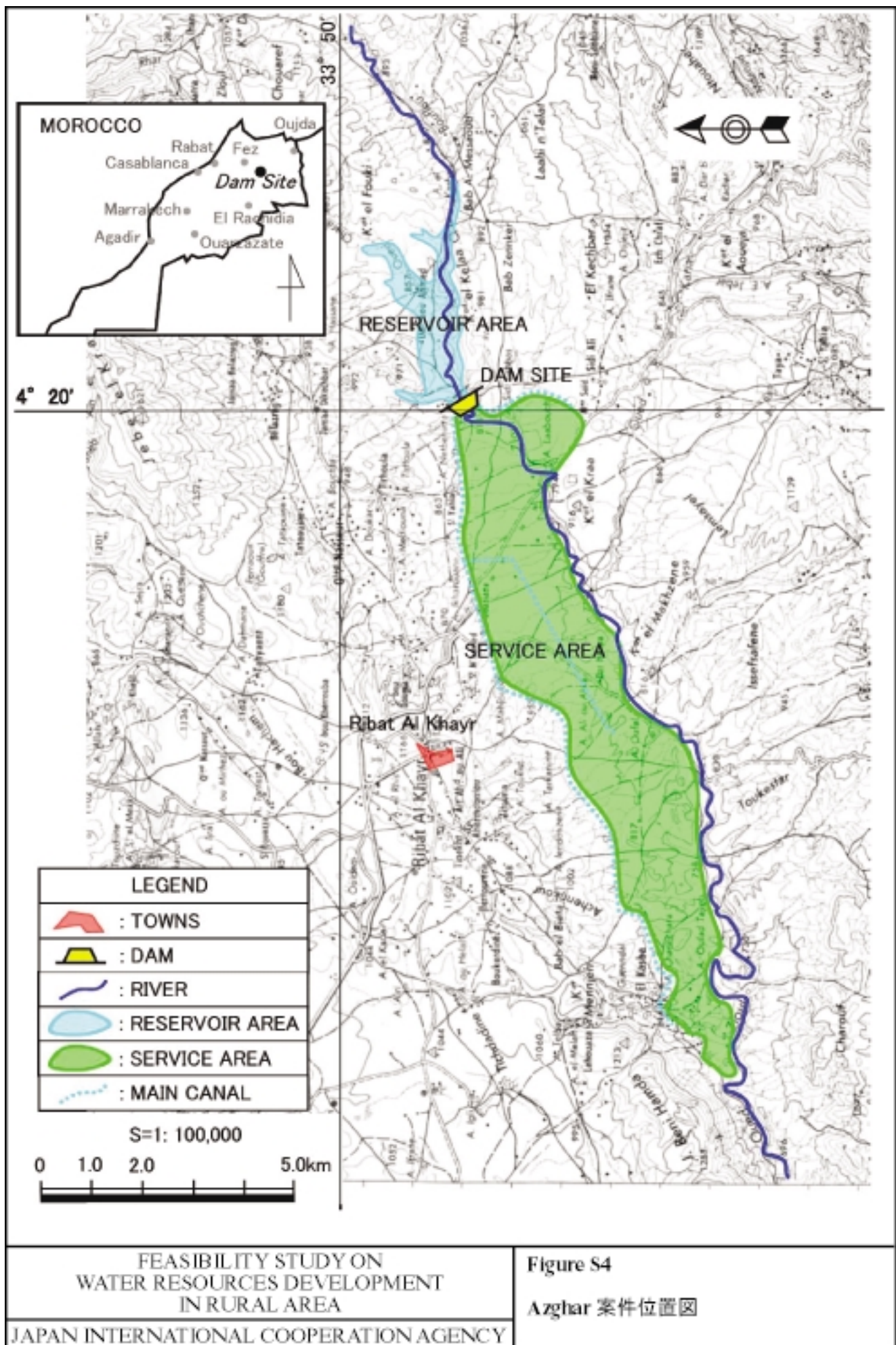

FEASIBILITY STUDY ON
WATER RESOURCES DEVELOPMENT
IN RURAL AREA

Figure S4

Azghar 案件位置図

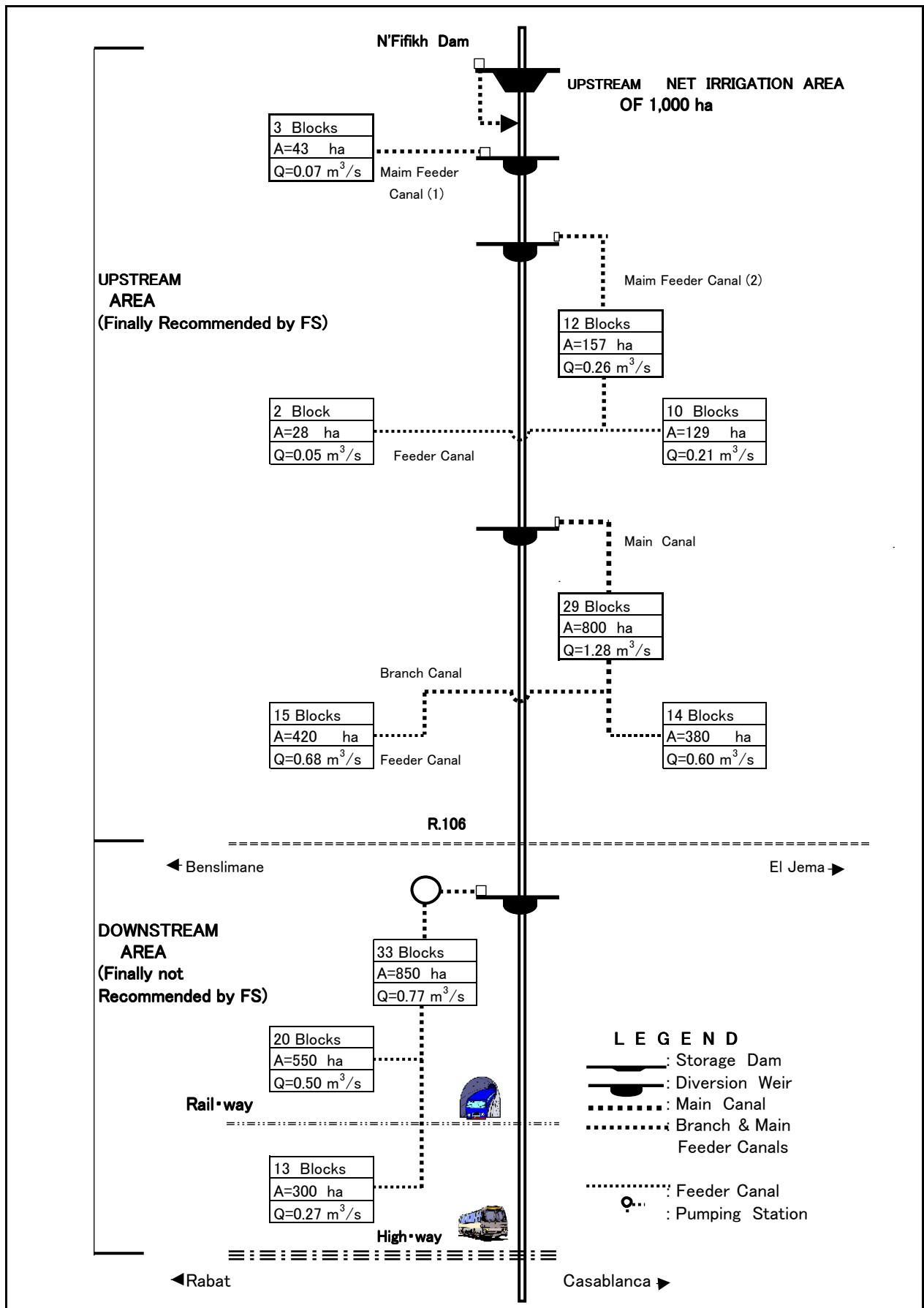

FEASIBILITY STUDY ON
WATER RESSOURCES DEVELOPMENT
IN RURAL AREA

Figure S6

N'Fifikh灌溉計画

JAPAN INTERNATIONAL COOPERATION AGENCY

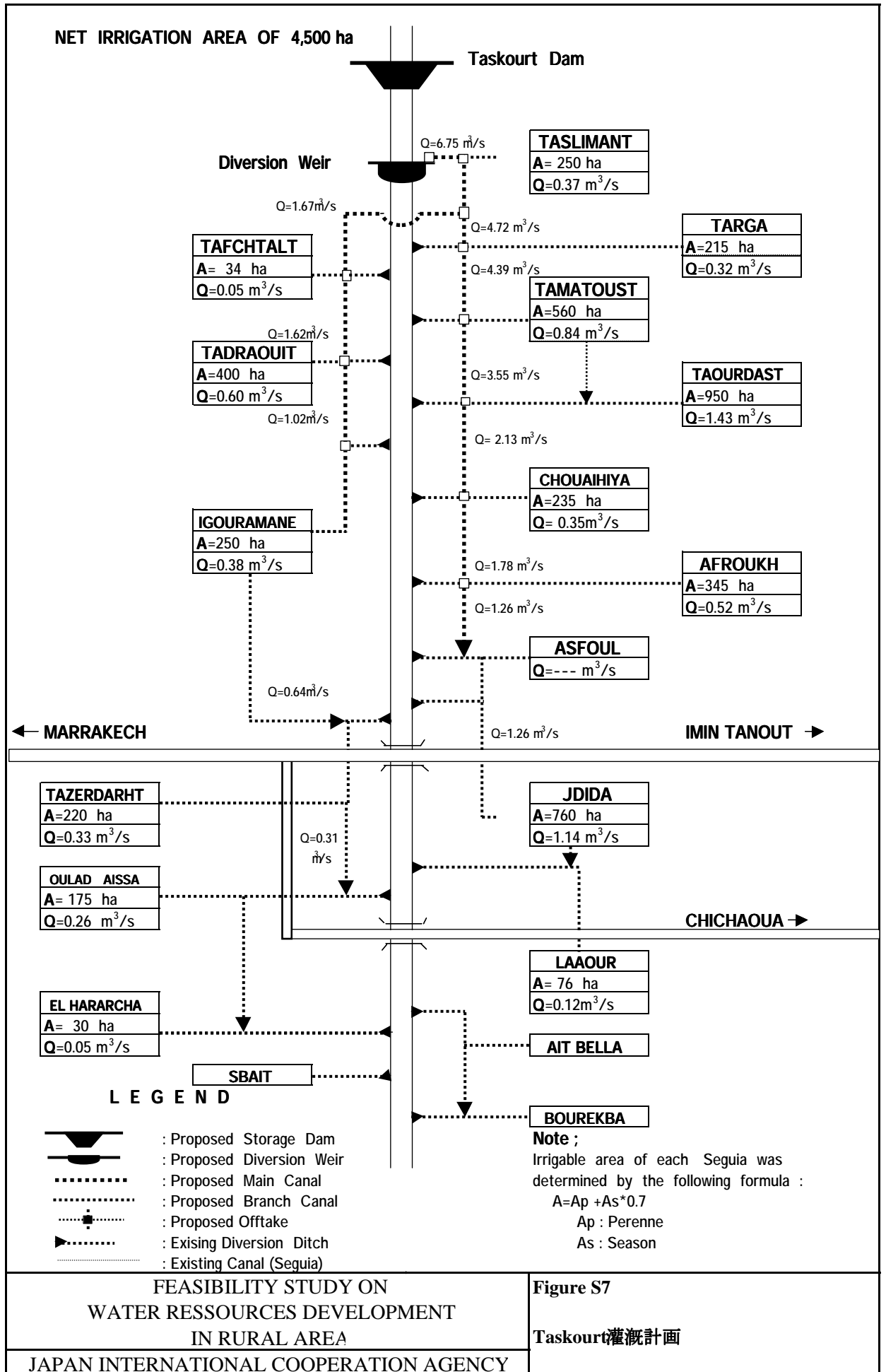
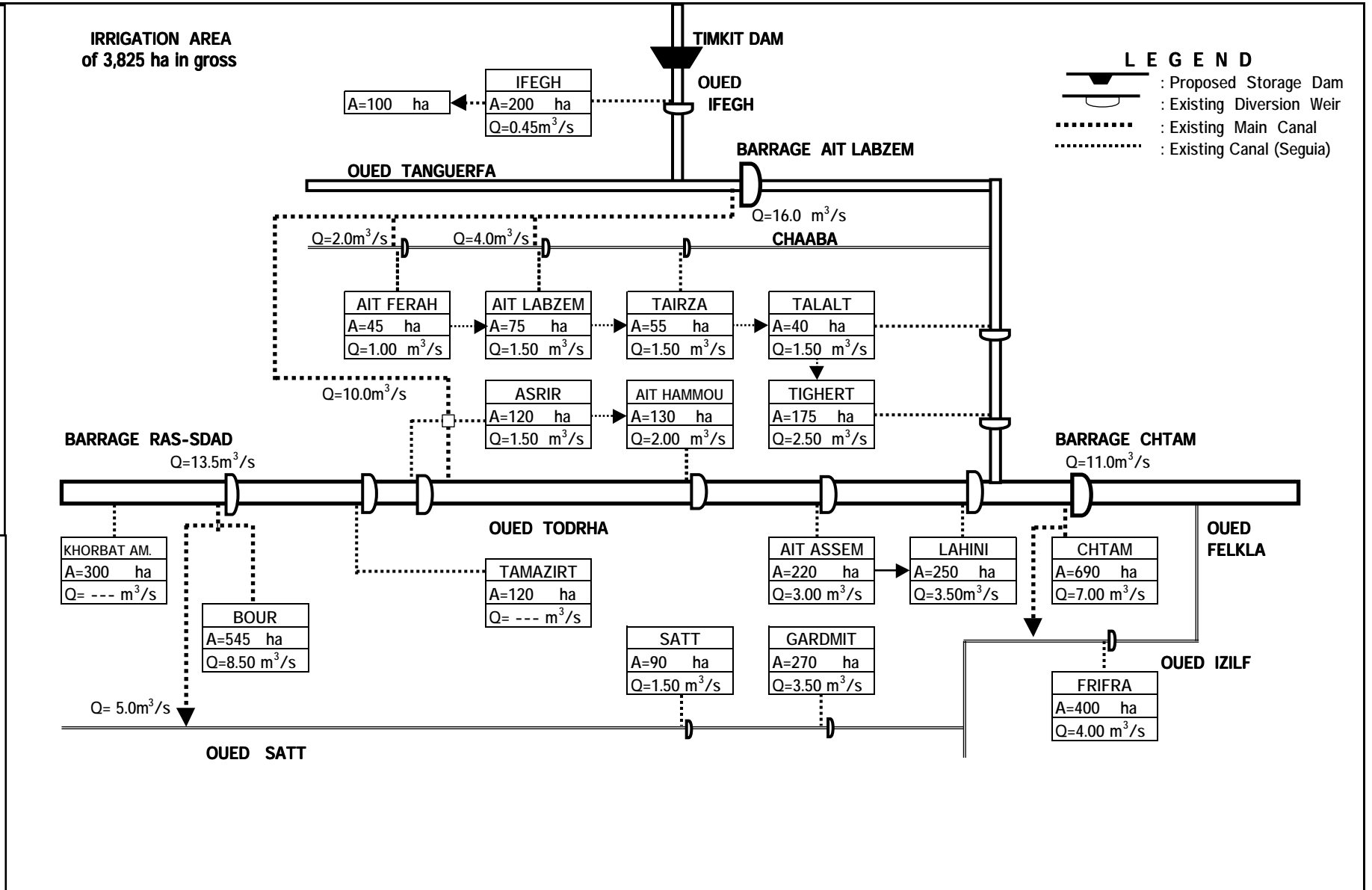
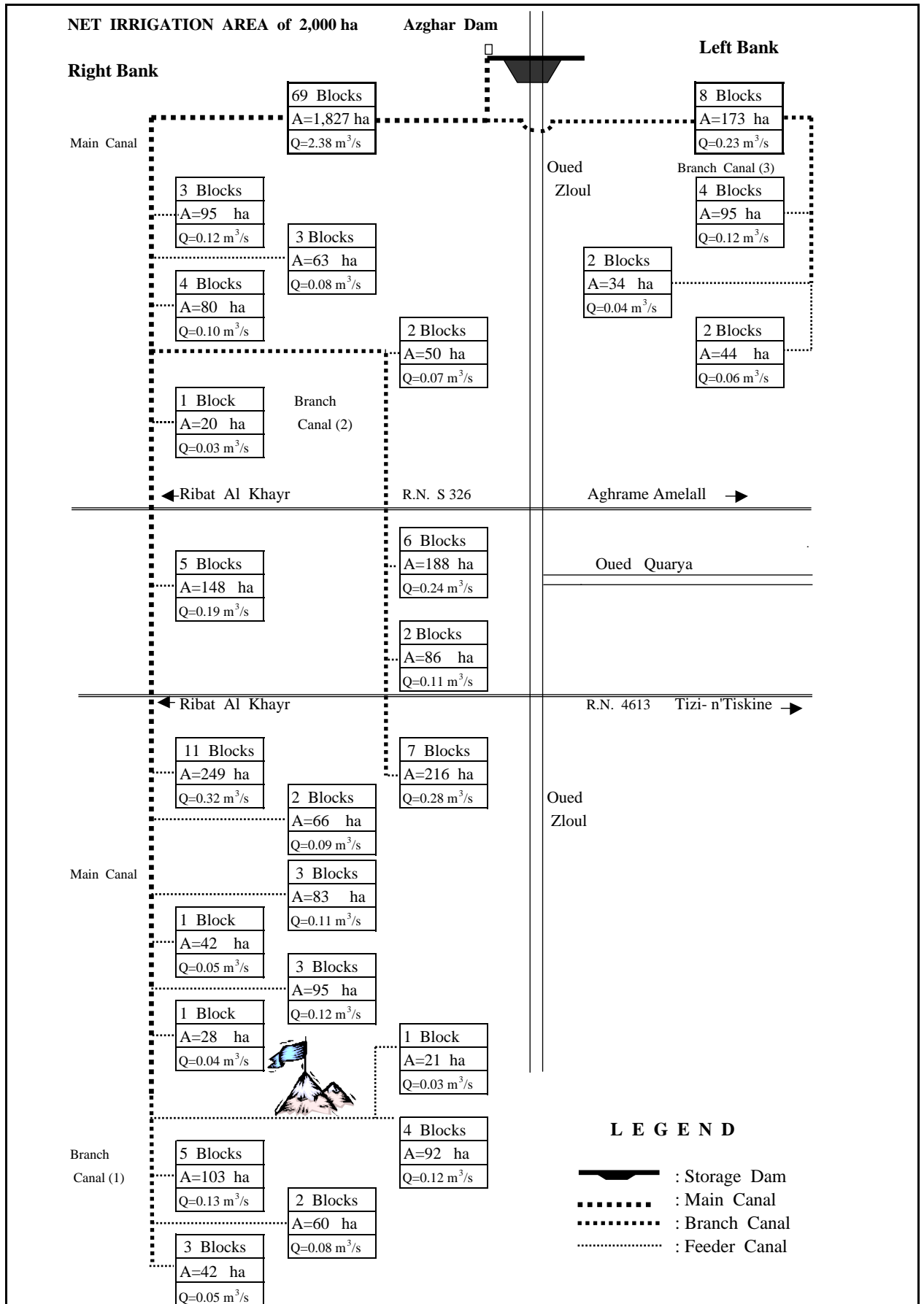

Figure S8
 Timiki灌漑計画





JAPAN INTERNATIONAL COOPERATION AGENCY FEASIBILITY STUDY ON WATER RESOURCES DEVELOPMENT IN RURAL AREA		Items	2000	01	02	03	04	05	06	07	08	09	10	11	12	13	14	15	16	17	18	19	20		
		I. First Step (Short Term): Implementation for Group A Projects (1) Completion of feasibility study for (4 projects) (2) Detailed Design (D.D) of the above (3) Tendering for No. 9 Taskourt Project (4) Construction of No. 9 Taskourt Project (5) Tendering for remaining 3 projects of the above (No. 5 N'Fifikh, No. 10 Timkit and No. 17 Azghar) (6) Construction of the above 3 projects II. Second Step (Long Term): Master Plan for Group B and C Projects III. Third Step (Long Term): Implementation for the priority Projects for Group B and C Projects (4 projects) IV. Further Step (Long Term): - First Priority Projects (4 Projects) - Second Priority Projects (4 Projects)		Aug	Aug																				
					Jan	Dec																			
						Oct	Sep																		
								Dec					Nov												
									Feb	Jan															
											Apr			Sep											
						Dec	July																		
									Aug								Nov								
									(FS)								(Const)								
												Dec										Nov			
										(MP)										(Const)					
														Dec						(Const)			Nov		
														(MP)									(Const)		
Remarks: 1) FS: Feasibility Study 2) MP: Master Plan Study 3) Const: Construction																									

Figure S10
 中規模ダム、全体実施予定

