

プロジェクト・サイト位置図

都市番号98 寧夏自治区·石嘴山市(第二次計画No.59)

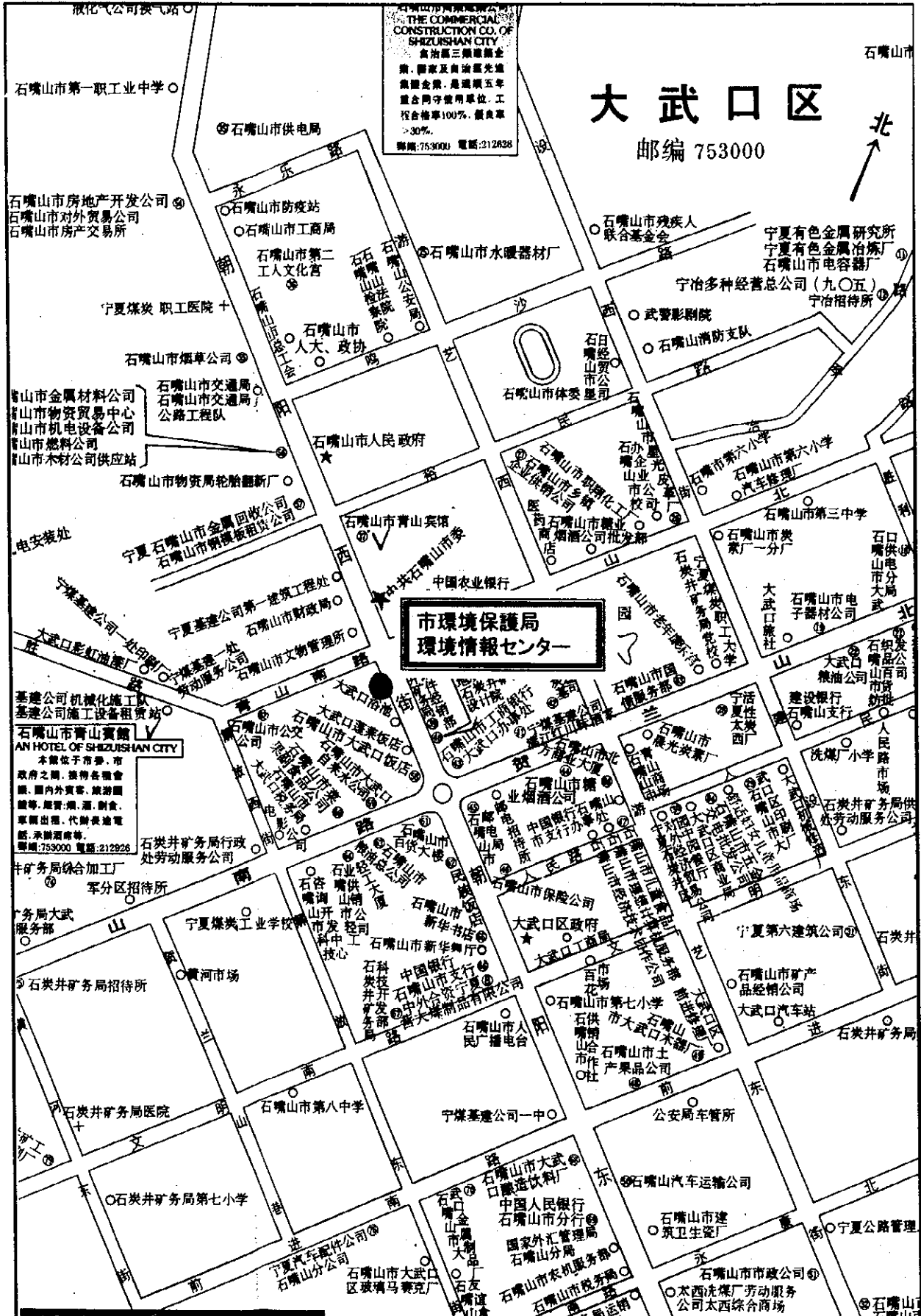

プロジェクト・サイト位置図

都市番号99 新疆自治区・伊寧市(伊犁州)(第二次計画No.60)

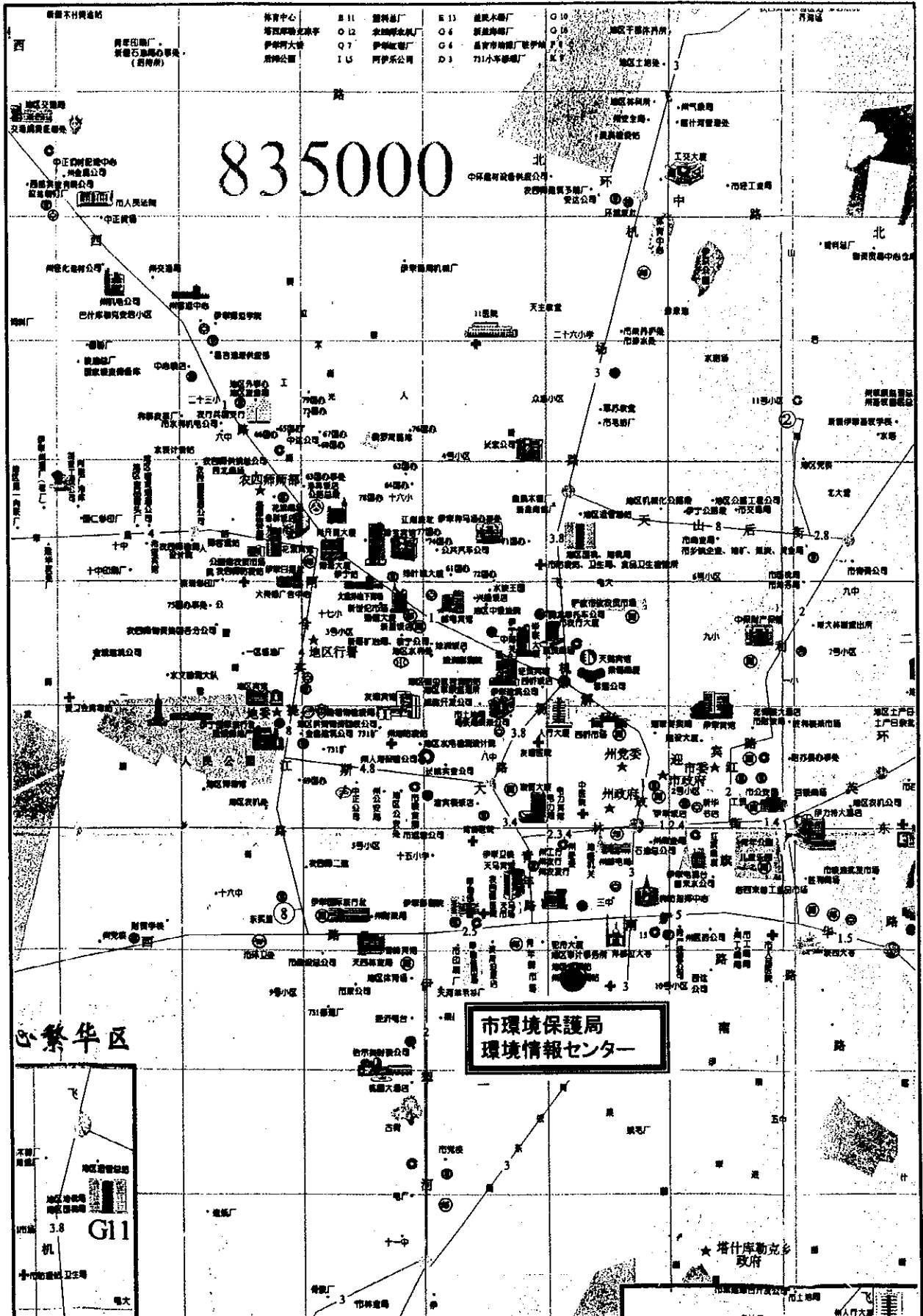

都市番号100 新疆自治区·石河子市(第二次計画No.61)

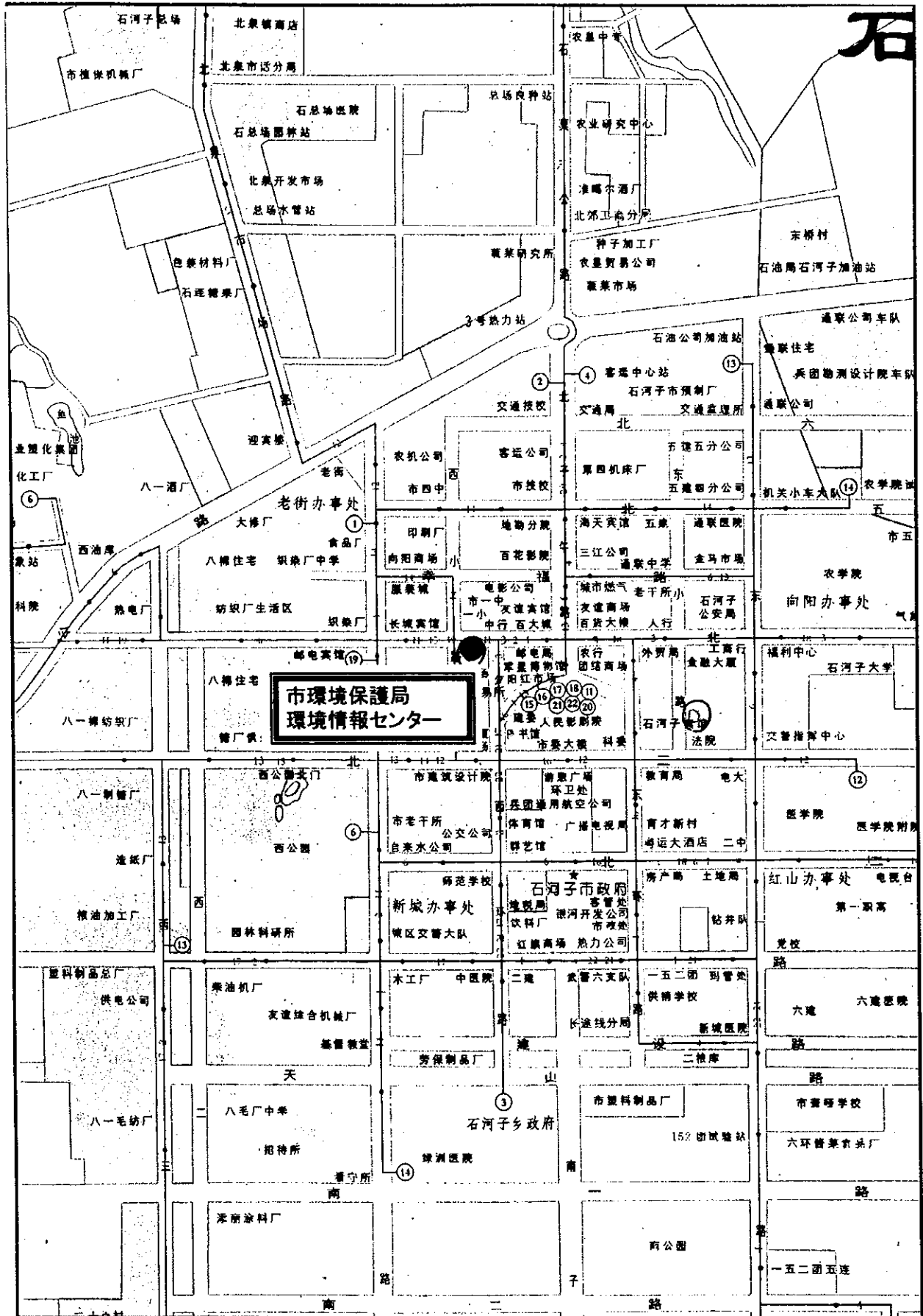

プロジェクト・サイト位置図

資料9. 都市環境情報センターの情報機器配置図

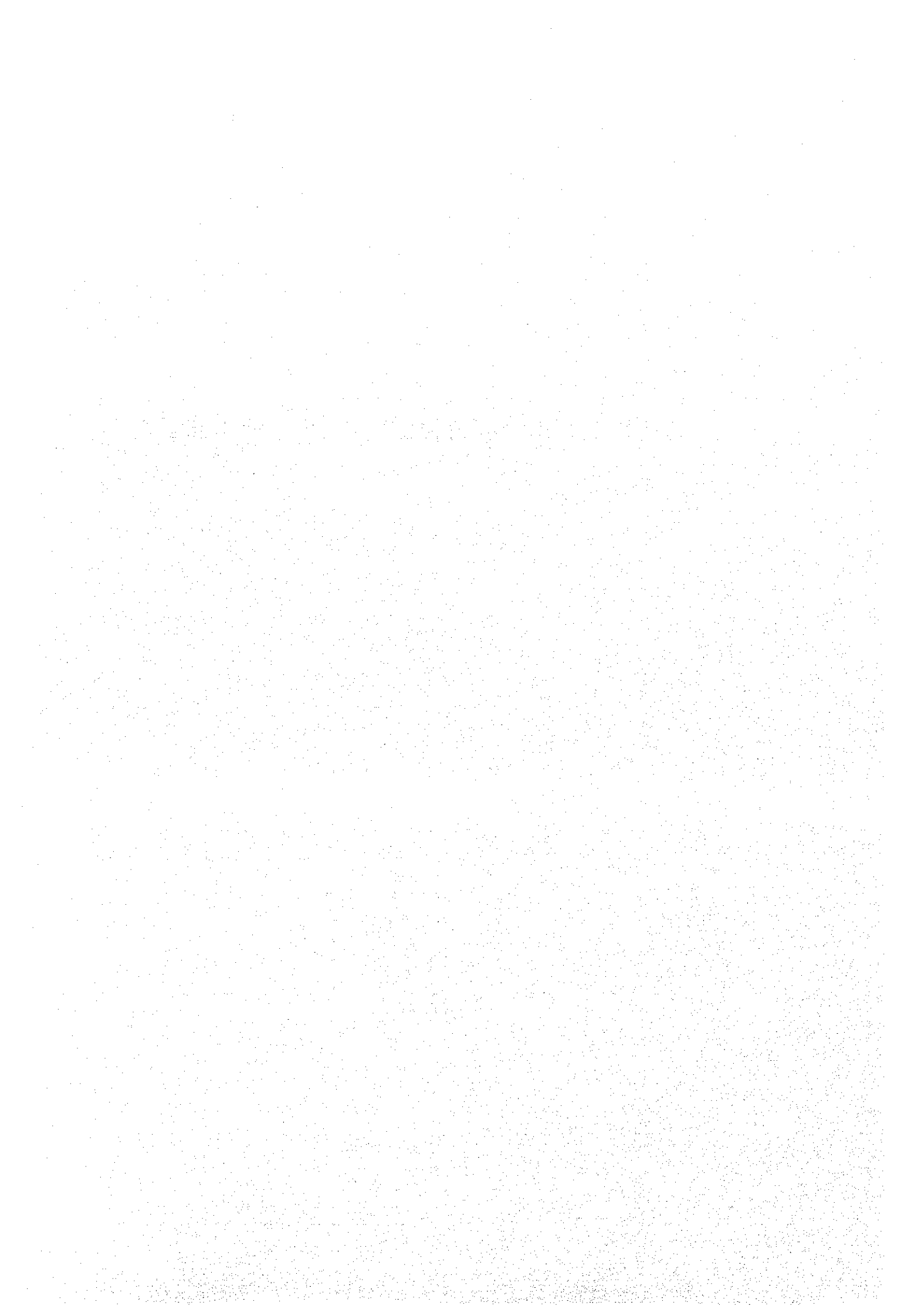

都市番号3 河北省・唐山市 No.1

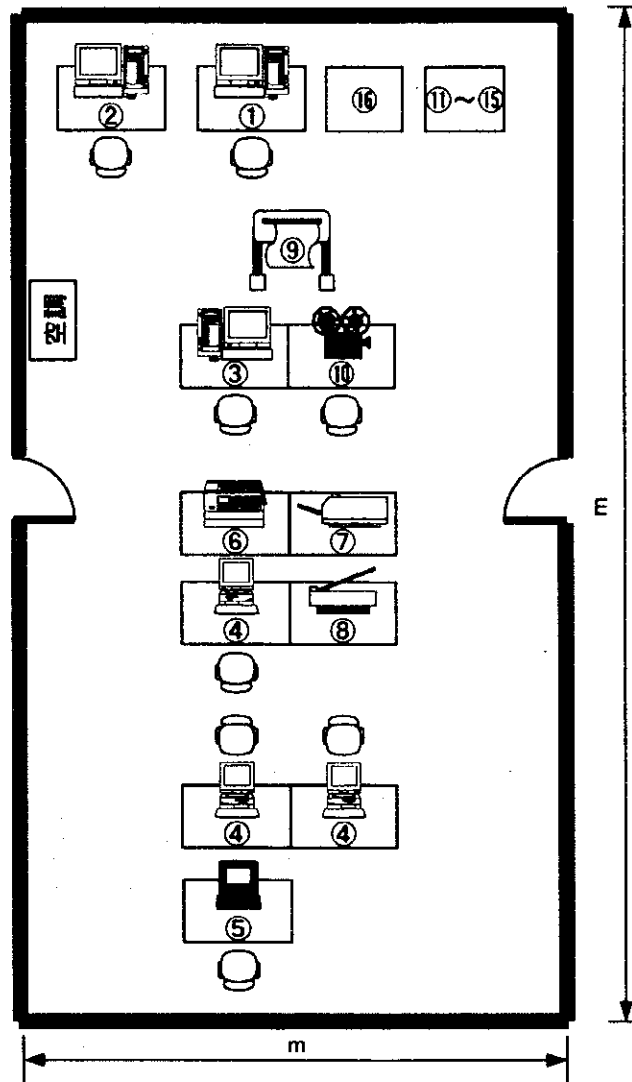

	Equipment	Unit	W (mm)	D (mm)	H (mm)		Equipment	Unit	W (mm)	D (mm)	H (mm)
①	Network Server	1	1200	700		⑨	Plotter	1	2000	800	1300
②	DBMS Server	1	1200	700		⑩	Projector	1	1100	700	
③	GIS Workstation	1	1200	700		⑪	Switch	1	800	600	2000
④	Desktop PC	3	1000	700		⑫	Hub				
⑤	NotePC	1	1000	700		⑬	Router				
⑥	Printer (L B)	1	1000	700		⑭	Modem				
⑦	Printer (L J)	1	1100	700		⑮	VSAT IDU				
⑧	Scanner	1	1000	700		⑯	UPS	1			

コンピュータ室フロアレイアウト

都市番号4 河北省・承德市 No.2

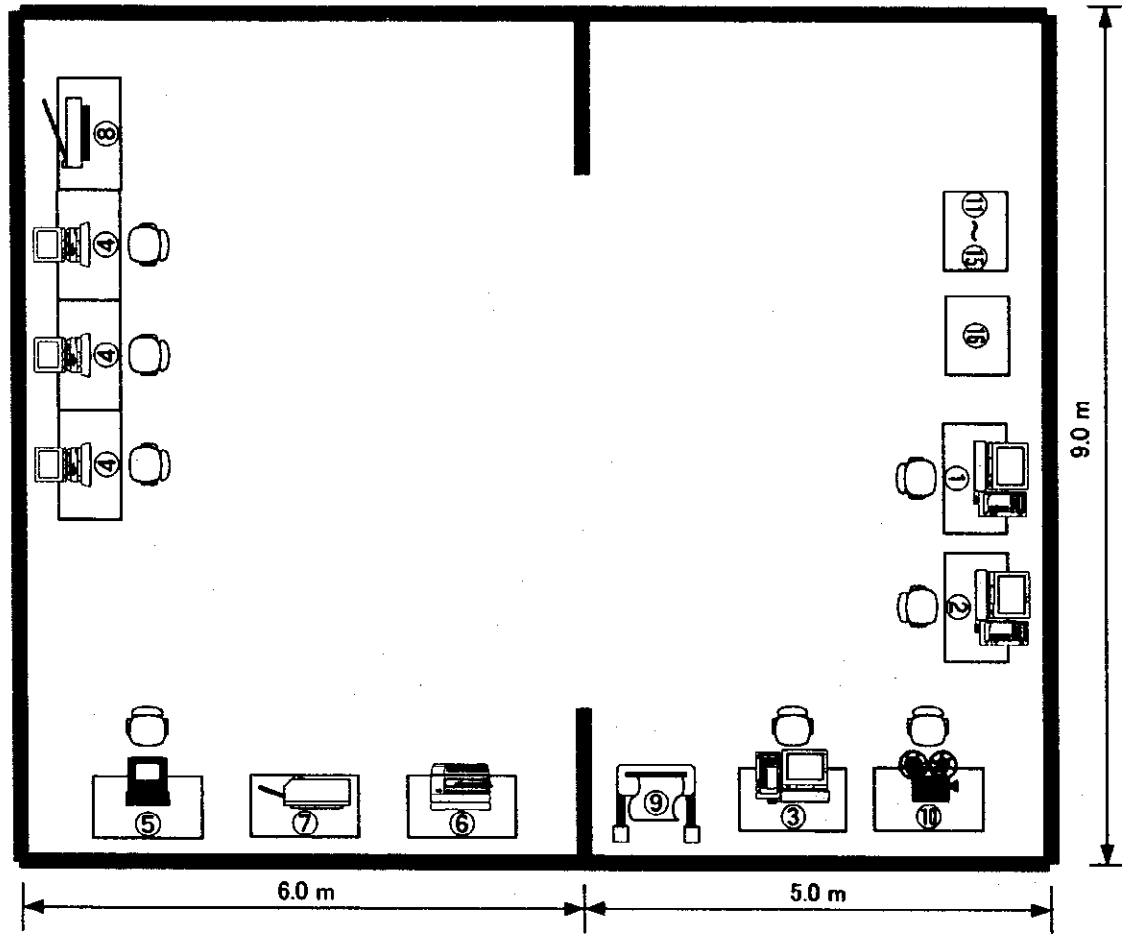

	Equipment	Unit	W (mm)	D (mm)	H (mm)		Equipment	Unit	W (mm)	D (mm)	H (mm)
①	Network Server	1	1200	700		⑨	Plotter	1	2000	800	1300
②	DBMS Server	1	1200	700		⑩	Projector	1	1100	700	
③	GIS Workstation	1	1200	700		⑪	Switch				
④	Desktop PC	3	1000	700		⑫	Hub				
⑤	NotePC	1	1000	700		⑬	Router	1	800	600	2000
⑥	Printer (L. B)	1	1000	700		⑭	Modem				
⑦	Printer (L. J)	1	1100	700		⑮	VSAT IDU				
⑧	Scanner	1	1000	700		⑯	UPS	1			

コンピュータ室フロアレイアウト

都市番号6 河北省・保定市 No.3

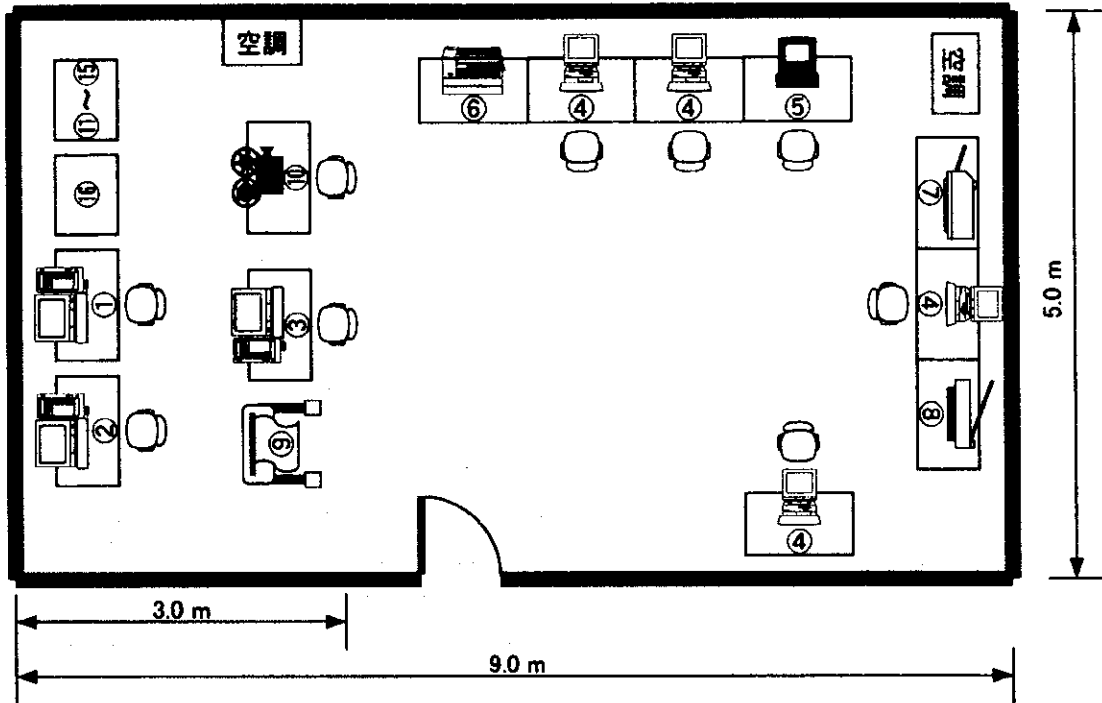

	Equipment	Unit	W (mm)	D (mm)	H (mm)		Equipment	Unit	W (mm)	D (mm)	H (mm)
①	Network Server	1	1200	700		⑨	Plotter	1	2000	800	1300
②	DBMS Server	1	1200	700		⑩	Projector	1	1100	700	
③	GIS Workstation	1	1200	700		⑪	Switch	1	800	600	2000
④	Desktop PC	4	1000	700		⑫	Hub				
⑤	NotePC	1	1000	700		⑬	Router				
⑥	Printer (L B)	1	1000	700		⑭	Modem				
⑦	Printer (L J)	1	1100	700		⑮	VSAT IDU				
⑧	Scanner	1	1000	700		⑯	UPS	1			

コンピュータ室フロアレイアウト

都市番号7 河北省・張家口市 No.4

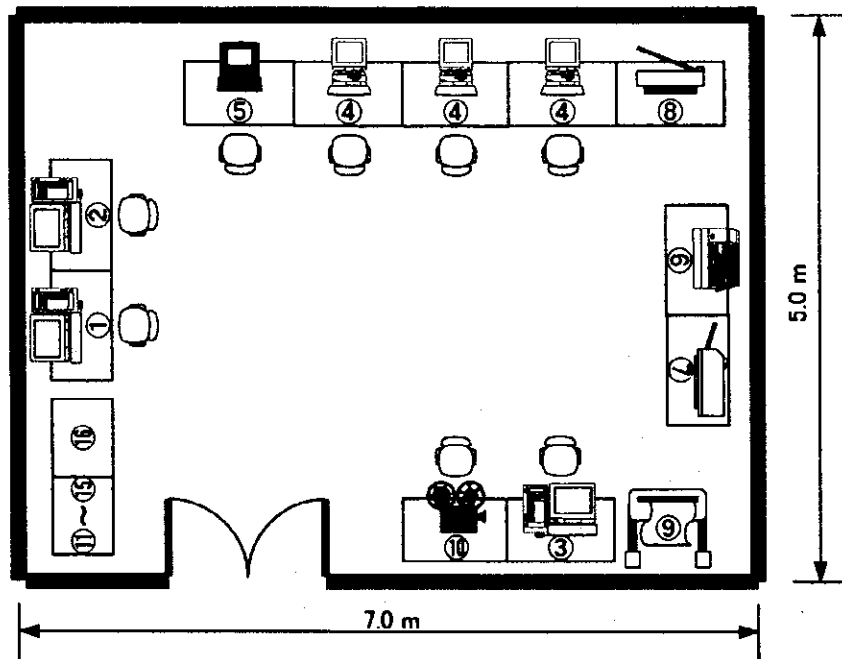

	Equipment	Unit	W (mm)	D (mm)	H (mm)		Equipment	Unit	W (mm)	D (mm)	H (mm)
①	Network Server	1	1200	700		⑨	Plotter	1	2000	800	1300
②	DBMS Server	1	1200	700		⑩	Projector	1	1100	700	
③	GIS Workstation	1	1200	700		⑪	Switch	1	800	600	2000
④	Desktop PC	3	1000	700		⑫	Hub				
⑤	NotePC	1	1000	700		⑬	Router				
⑥	Printer (L. B)	1	1000	700		⑭	Modem				
⑦	Printer (L. J)	1	1100	700		⑮	VSAT IDU				
⑧	Scanner	1	1000	700		⑯	UPS				

コンピュータ室フロアレイアウト

都市番号9 山西省・大同市 No.5

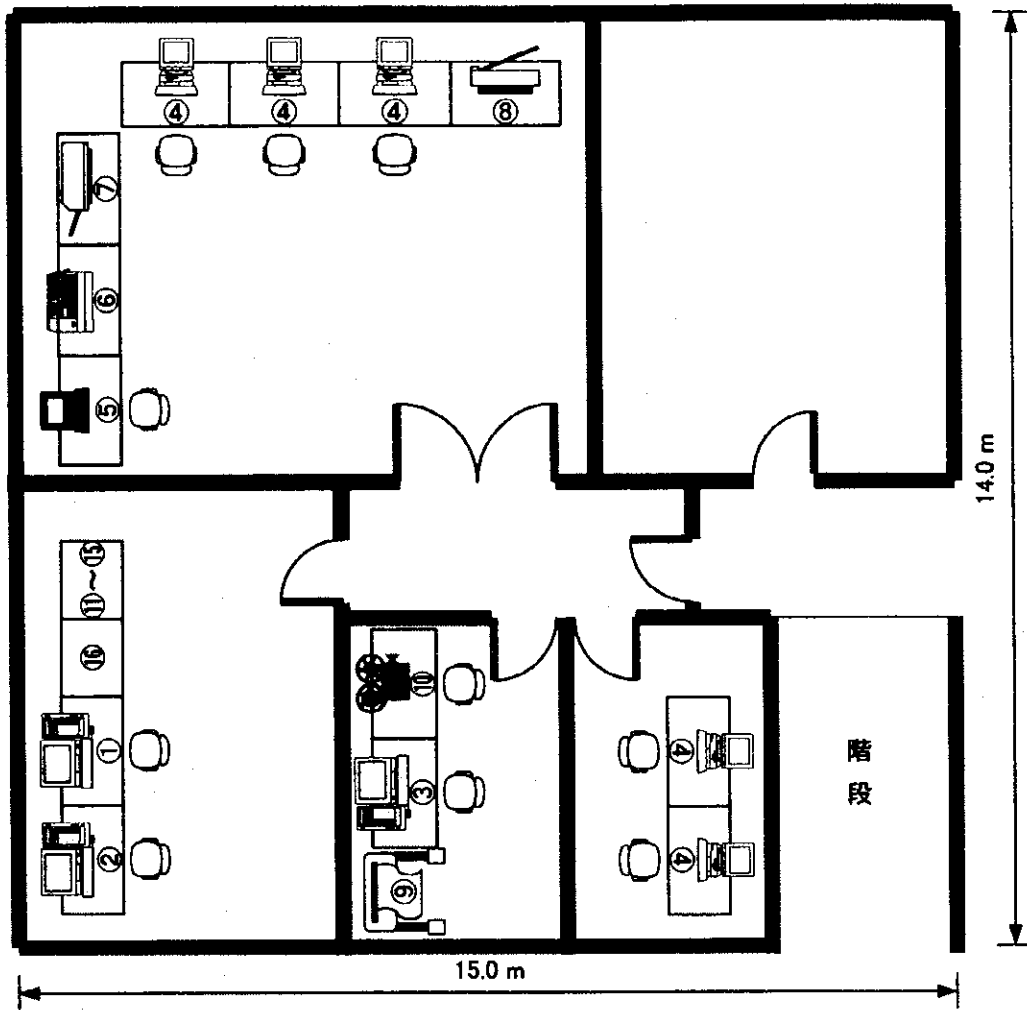

	Equipment	Unit	W (mm)	D (mm)	H (mm)		Equipment	Unit	W (mm)	D (mm)	H (mm)
①	Network Server	1	1200	700		⑨	Plotter	1	2000	800	1300
②	DBMS Server	1	1200	700		⑩	Projector	1	1100	700	
③	GIS Workstation	1	1200	700		⑪	Switch	1	800	600	2000
④	Desktop PC	5	1000	700		⑫	Hub				
⑤	NotePC	1	1000	700		⑬	Router				
⑥	Printer (L B)	1	1000	700		⑭	Modem				
⑦	Printer (L J)	1	1100	700		⑮	VSAT IDU				
⑧	Scanner	1	1000	700		⑯	UPS	1			

コンピュータ室フロアレイアウト

都市番号10 山西省・臨汾市 No.6

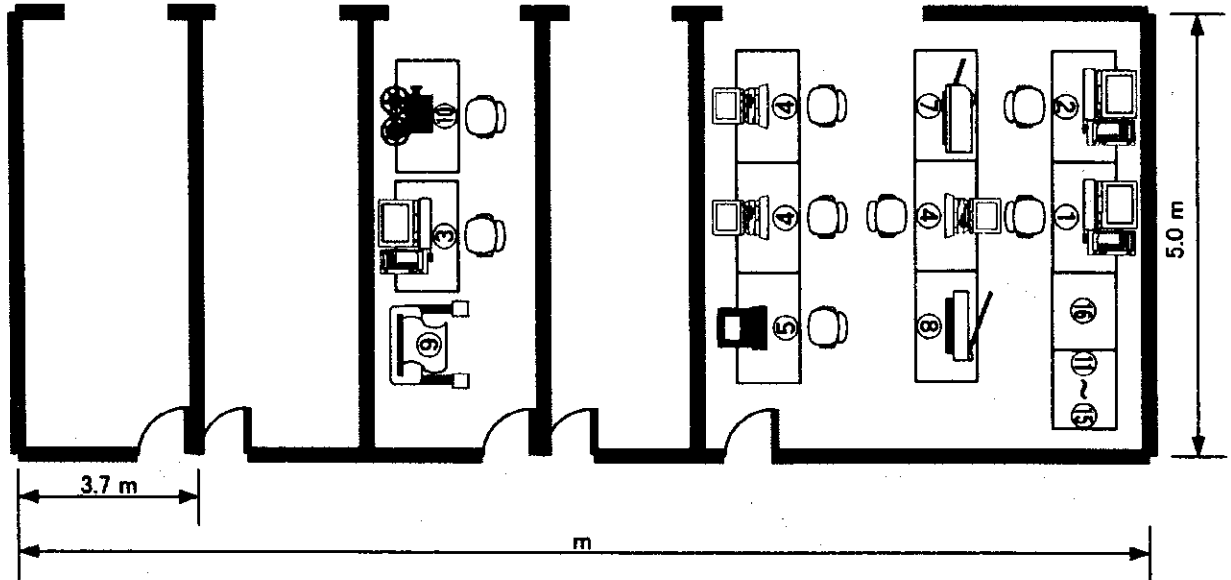

	Equipment	Unit	W (mm)	D (mm)	H (mm)		Equipment	Unit	W (mm)	D (mm)	H (mm)
①	Network Server	1	1200	700		⑨	Plotter	1	2000	800	1300
②	DBMS Server	1	1200	700		⑩	Projector	1	1100	700	
③	GIS Workstation	1	1200	700		⑪	Switch	1	800	600	2000
④	Desktop PC	3	1000	700		⑫	Hub				
⑤	NotePC	1	1000	700		⑬	Router				
⑥	Printer (L B)	1	1000	700		⑭	Modem				
⑦	Printer (I J)	1	1100	700		⑮	VSAT IDU				
⑧	Scanner	1	1000	700		⑯	UPS	1			

コンピュータ室フロアレイアウト

都市番号11 山西省・運城市 No.7

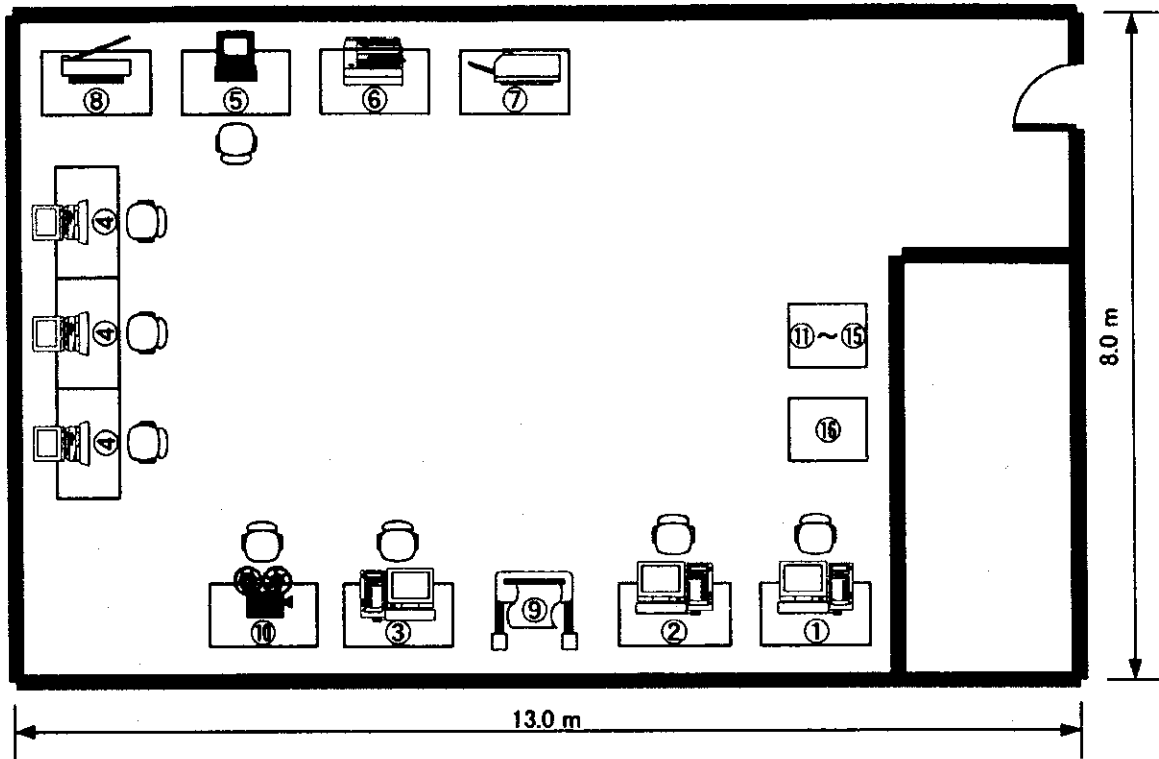

	Equipment	Unit	W (mm)	D (mm)	H (mm)		Equipment	Unit	W (mm)	D (mm)	H (mm)
①	Network Server	1	1200	700		⑨	Plotter	1	2000	800	1300
②	DBMS Server	1	1200	700		⑩	Projector	1	1100	700	
③	GIS Workstation	1	1200	700		⑪	Switch	1	800	600	2000
④	Desktop PC	3	1000	700		⑫	Hub				
⑤	NotePC	1	1000	700		⑬	Router				
⑥	Printer (L. B)	1	1000	700		⑭	Modem				
⑦	Printer (L. J)	1	1100	700		⑮	VSAT IDU				
⑧	Scanner	1	1000	700		⑯	UPS	1			

コンピュータ室フロアレイアウト

都市番号12 内蒙古自治区・包頭市 No.8

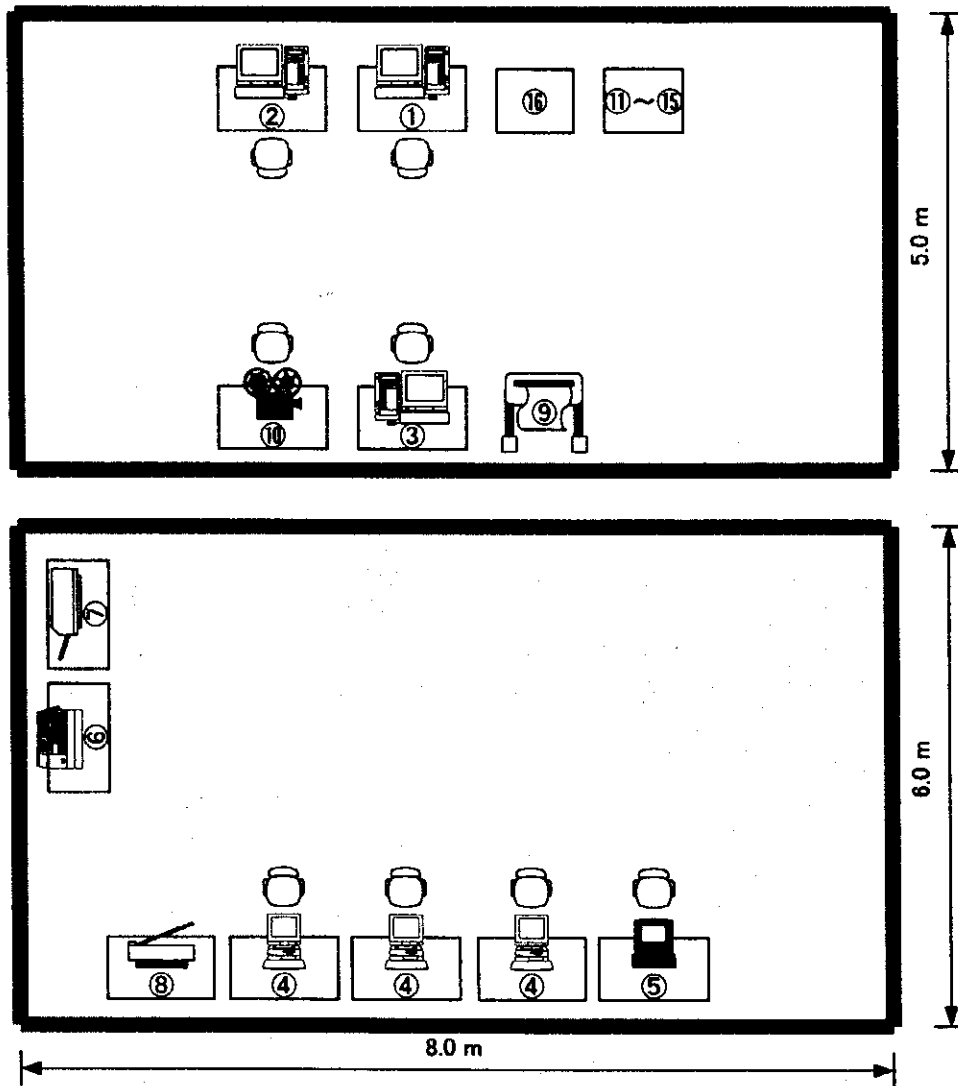

	Equipment	Unit	W (mm)	D (mm)	H (mm)		Equipment	Unit	W (mm)	D (mm)	H (mm)
①	Network Server	1	1200	700		⑨	Plotter	1	2000	800	1300
②	DBMS Server	1	1200	700		⑩	Projector	1	1100	700	
③	GIS Workstation	1	1200	700		⑪	Switch	1	800	600	2000
④	Desktop PC	3	1000	700		⑫	Hub				
⑤	NotePC	1	1000	700		⑬	Router				
⑥	Printer (L. B)	1	1000	700		⑭	Modem				
⑦	Printer (L. J)	1	1100	700		⑮	VSAT IDU				
⑧	Scanner	1	1000	700		⑯	UPS	1			

コンピュータ室フロアレイアウト

都市番号16 遼寧省・鞍山市 No.9

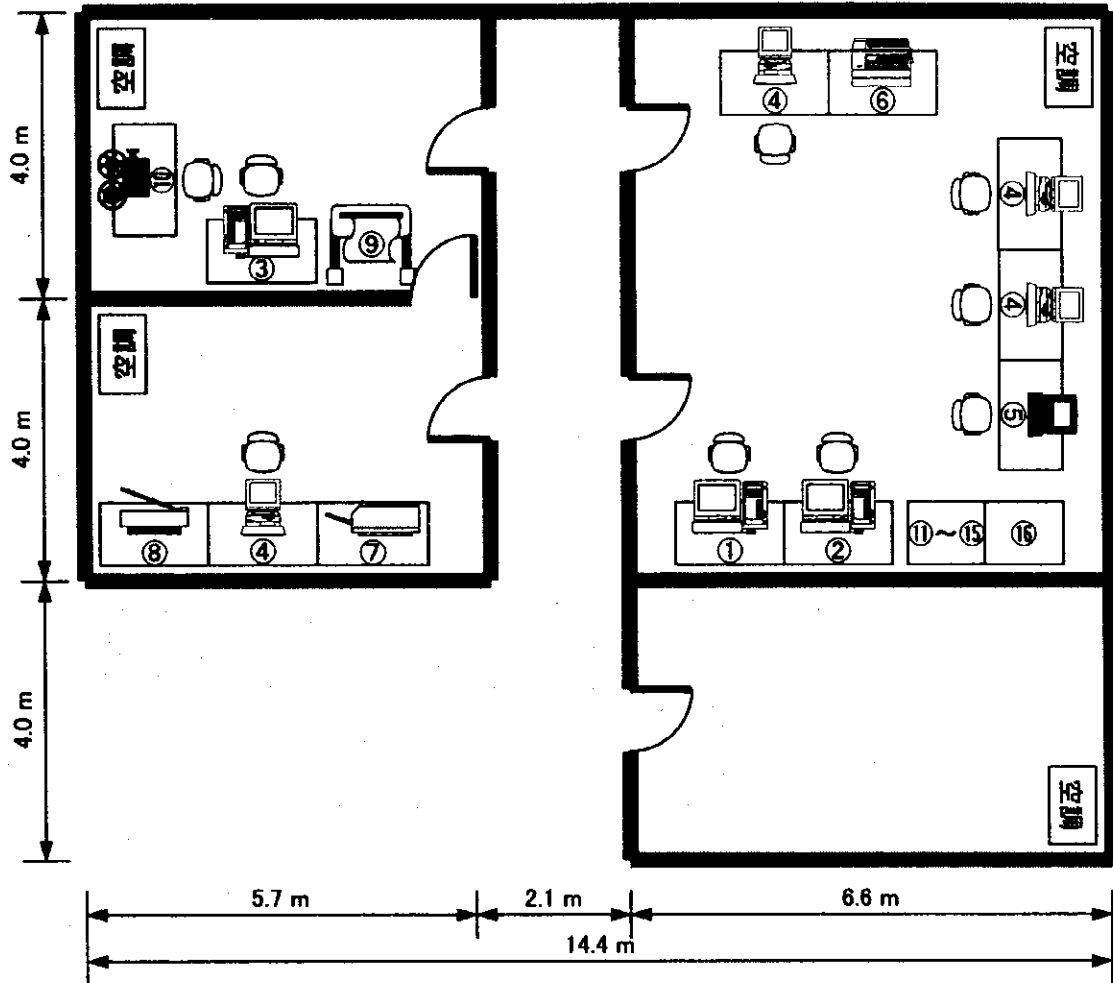

	Equipment	Unit	W (mm)	D (mm)	H (mm)		Equipment	Unit	W (mm)	D (mm)	H (mm)
①	Network Server	1	1200	700		⑨	Plotter	1	2000	800	1300
②	DBMS Server	1	1200	700		⑩	Projector	1	1100	700	
③	GIS Workstation	1	1200	700		⑪	Switch	1	800	600	2000
④	Desktop PC	4	1000	700		⑫	Hub				
⑤	NotePC	1	1000	700		⑬	Router				
⑥	Printer (L B)	1	1000	700		⑭	Modem				
⑦	Printer (L J)	1	1100	700		⑮	VSAT IDU	1			
⑧	Scanner	1	1000	700		⑯	UPS				

コンピュータ室フロアレイアウト

都市番号17 遼寧省・营口市 No.10

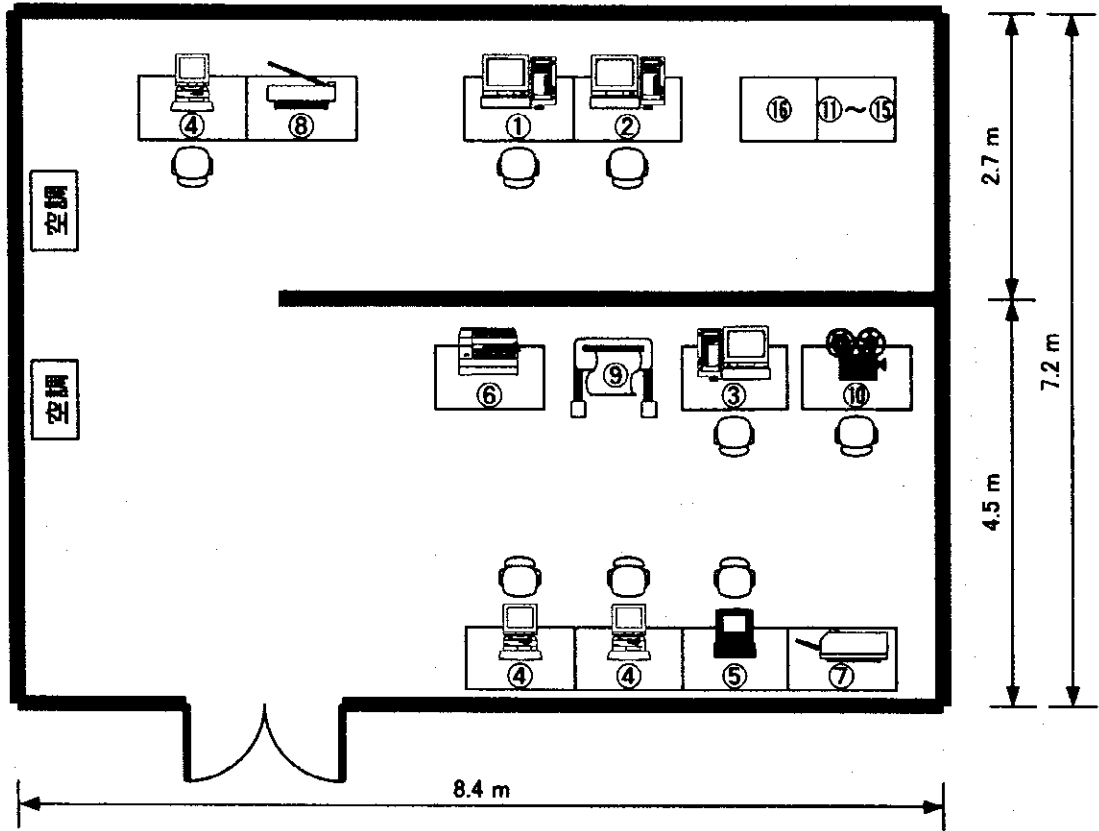

	Equipment	Unit	W (mm)	D (mm)	H (mm)		Equipment	Unit	W (mm)	D (mm)	H (mm)
①	Network Server	1	1200	700		⑨	Plotter	1	2000	800	1300
②	DBMS Server	1	1200	700		⑩	Projector	1	1100	700	
③	GIS Workstation	1	1200	700		⑪	Switch	1	800	600	2000
④	Desktop PC	3	1000	700		⑫	Hub				
⑤	NotePC	1	1000	700		⑬	Router				
⑥	Printer (L B)	1	1000	700		⑭	Modem				
⑦	Printer (L J)	1	1100	700		⑮	VSAT IDU	1			
⑧	Scanner	1	1000	700		⑯	UPS				

コンピュータ室フロアレイアウト

都市番号18 遼寧省・本溪市 No.11

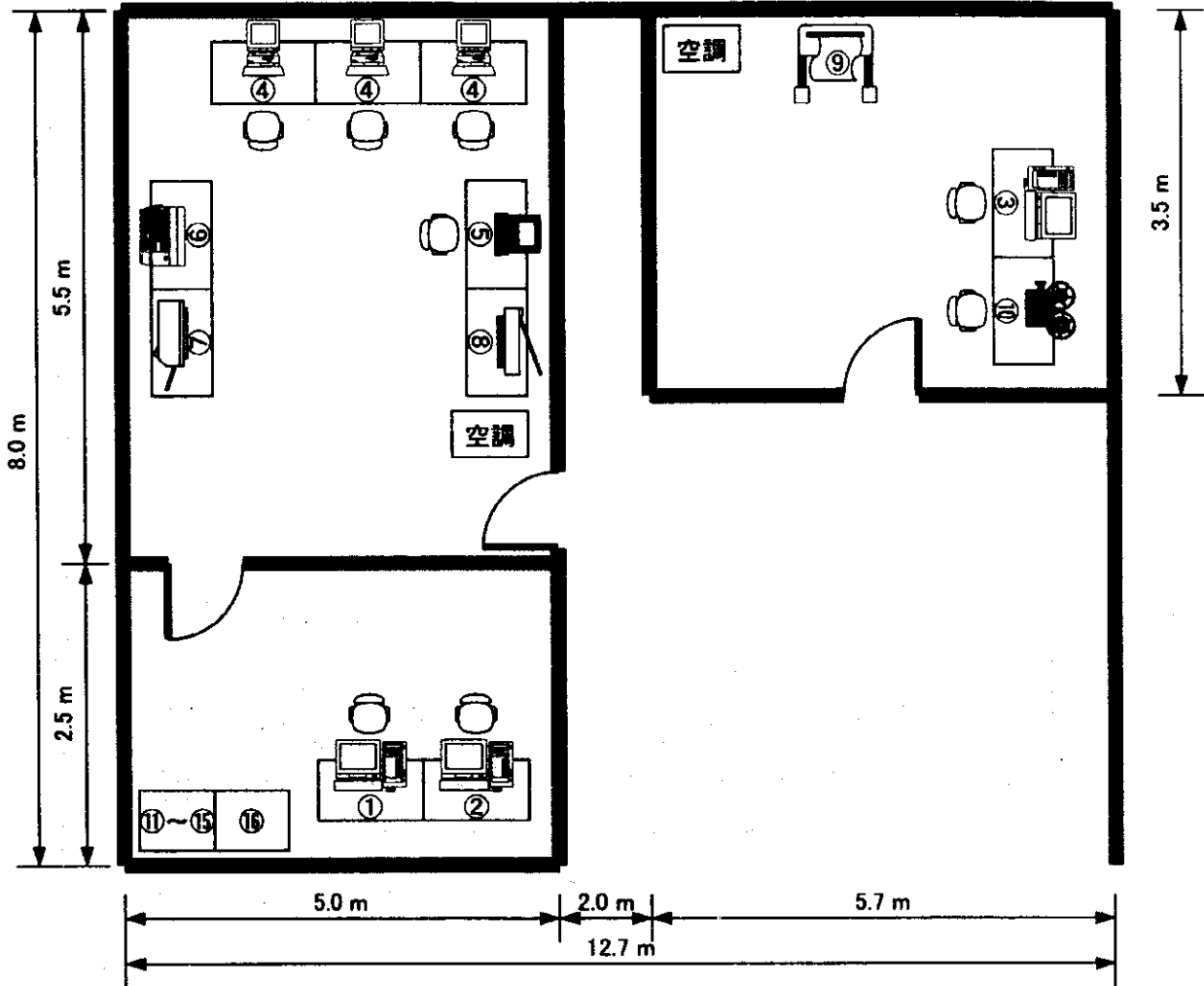

	Equipment	Unit	W (mm)	D (mm)	H (mm)		Equipment	Unit	W (mm)	D (mm)	H (mm)
①	Network Server	1	1200	700		⑨	Plotter	1	2000	800	1300
②	DBMS Server	1	1200	700		⑩	Projector	1	1100	700	
③	GIS Workstation	1	1200	700		⑪	Switch	1	800	600	2000
④	Desktop PC	3	1000	700		⑫	Hub				
⑤	NotePC	1	1000	700		⑬	Router				
⑥	Printer (L B)	1	1000	700		⑭	Modem				
⑦	Printer (I J)	1	1100	700		⑮	VSAT IDU	1			
⑧	Scanner	1	1000	700		⑯	UPS				

コンピュータ室フロアレイアウト

都市番号19 遼寧省・錦州市 No.12

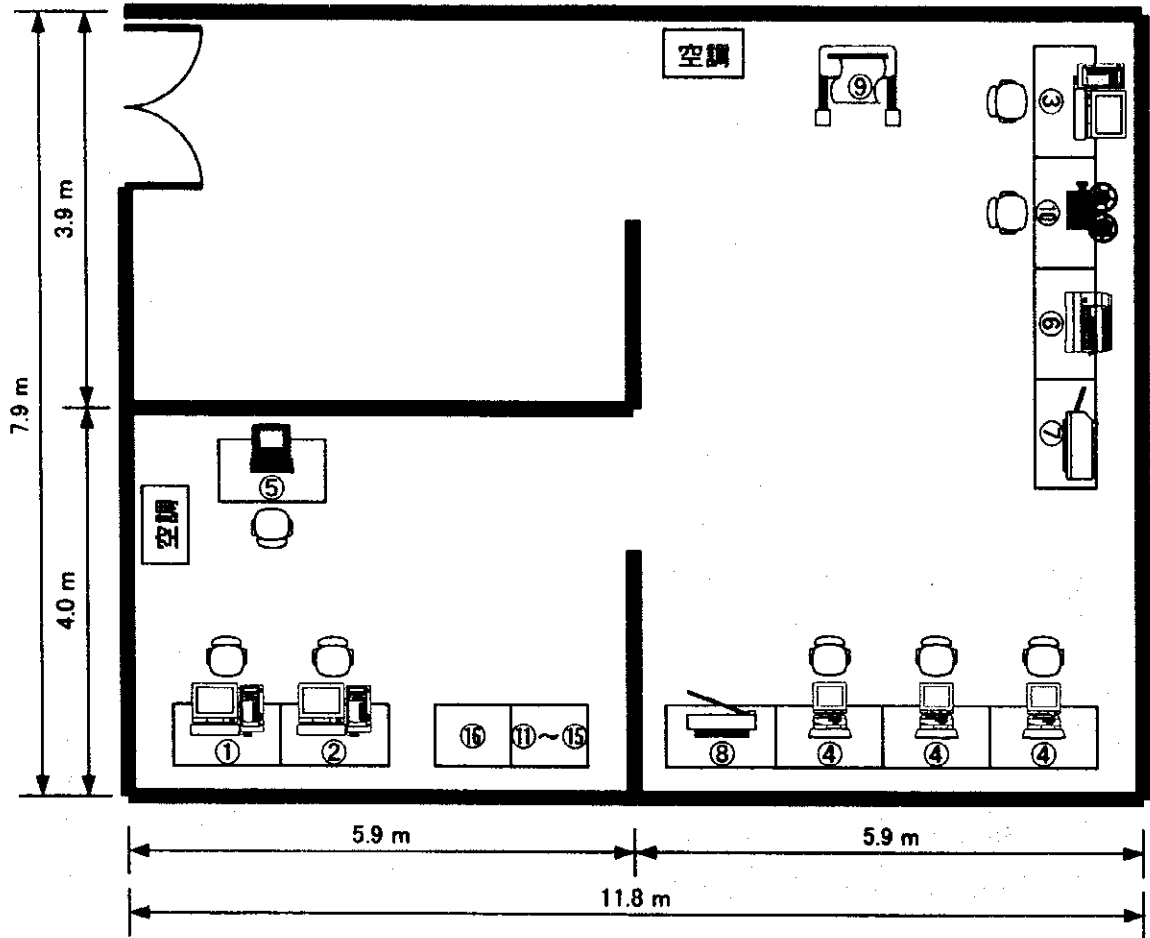

	Equipment	Unit	W (mm)	D (mm)	H (mm)		Equipment	Unit	W (mm)	D (mm)	H (mm)
①	Network Server	1	1200	700		⑨	Plotter	1	2000	800	1300
②	DBMS Server	1	1200	700		⑩	Projector	1	1100	700	
③	GIS Workstation	1	1200	700		⑪	Switch	1	800	600	2000
④	Desktop PC	3	1000	700		⑫	Hub				
⑤	NotePC	1	1000	700		⑬	Router				
⑥	Printer (L B)	1	1000	700		⑭	Modem				
⑦	Printer (I J)	1	1100	700		⑮	VSAT IDU				
⑧	Scanner	1	1000	700		⑯	UPS	1			

コンピュータ室フロアレイアウト

都市番号20 遼寧省・丹東市 No.13

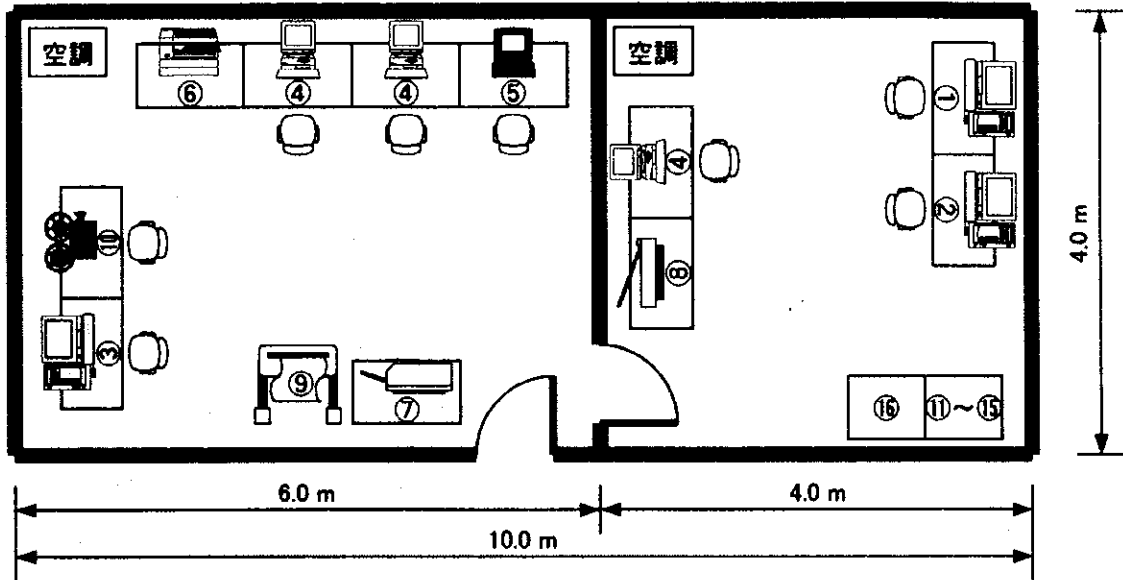

	Equipment	Unit	W (mm)	D (mm)	H (mm)		Equipment	Unit	W (mm)	D (mm)	H (mm)
①	Network Server	1	1200	700		⑨	Plotter	1	2000	800	1300
②	DBMS Server	1	1200	700		⑩	Projector	1	1100	700	
③	GIS Workstation	1	1200	700		⑪	Switch	1	800	600	2000
④	Desktop PC	3	1000	700		⑫	Hub				
⑤	NotePC	1	1000	700		⑬	Router				
⑥	Printer (L. B)	1	1000	700		⑭	Modem				
⑦	Printer (I. J)	1	1100	700		⑮	VSAT IDU				
⑧	Scanner	1	1000	700		⑯	UPS	1			

コンピュータ室フロアレイアウト

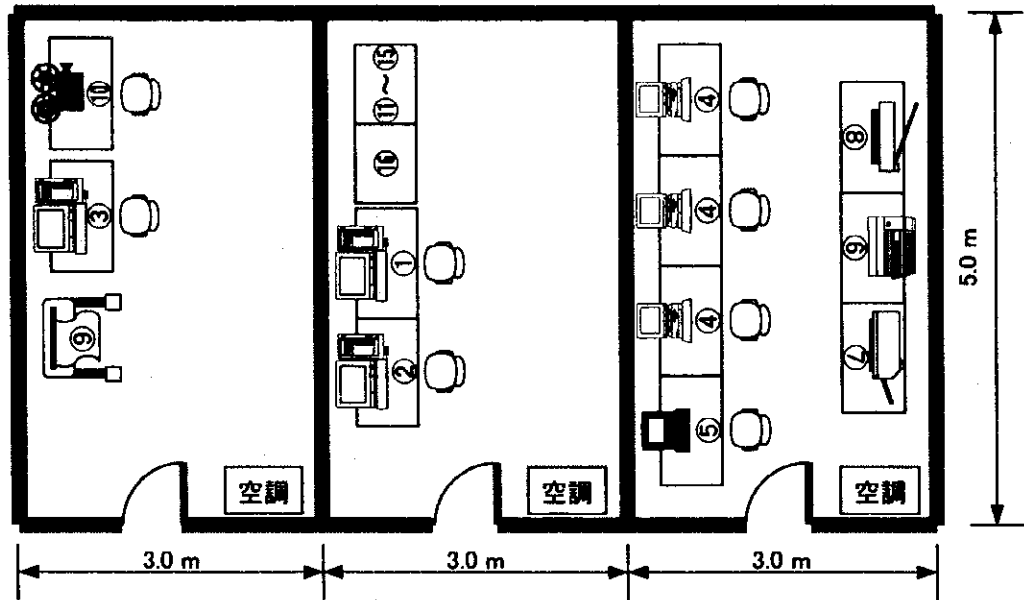

	Equipment	Unit	W (mm)	D (mm)	H (mm)		Equipment	Unit	W (mm)	D (mm)	H (mm)
①	Network Server	1	1200	700		⑨	Plotter	1	2000	800	1300
②	DBMS Server	1	1200	700		⑩	Projector	1	1100	700	
③	GIS Workstation	1	1200	700		⑪	Switch	1	800	600	2000
④	Desktop PC	3	1000	700		⑫	Hub				
⑤	NotePC	1	1000	700		⑬	Router				
⑥	Printer (L. B)	1	1000	700		⑭	Modem				
⑦	Printer (L. J)	1	1100	700		⑮	VSAT IDU				
⑧	Scanner	1	1000	700		⑯	UPS	1			

コンピュータ室フロアレイアウト

都市番号23 吉林省・通化市 No.15

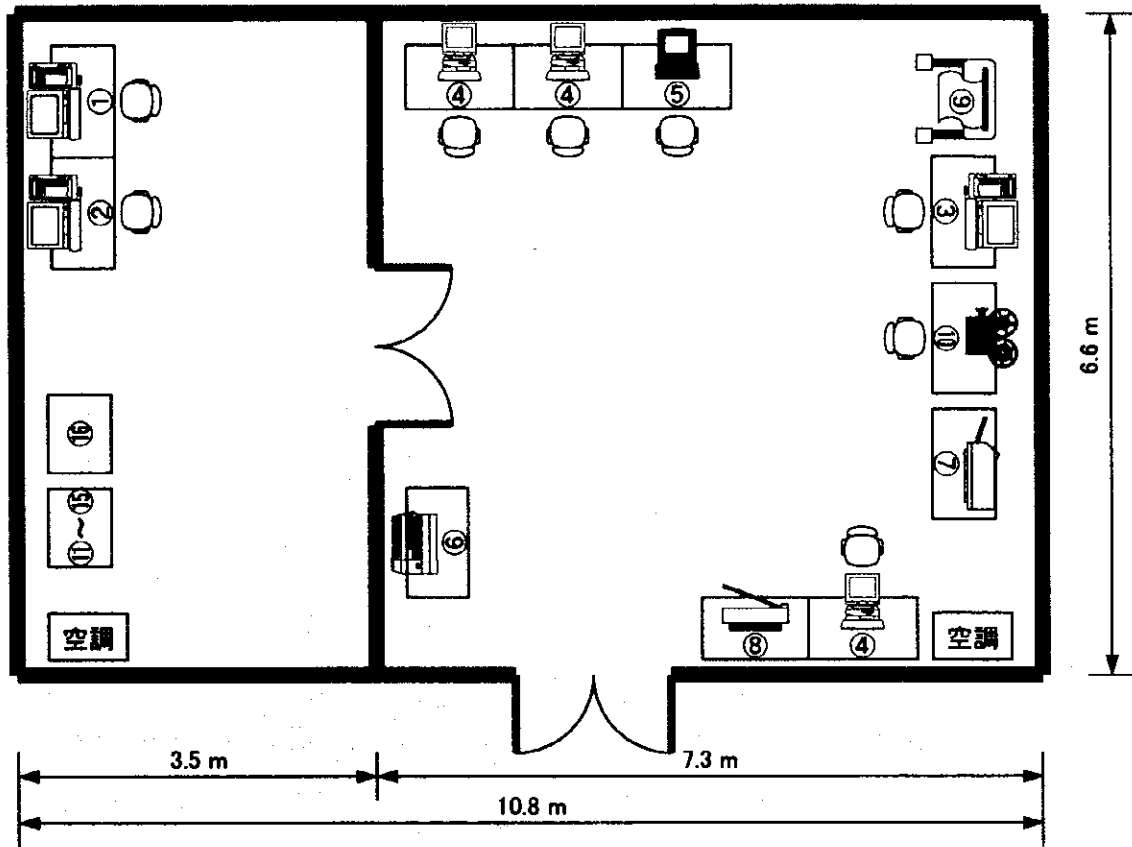

	Equipment	Unit	W (mm)	D (mm)	H (mm)		Equipment	Unit	W (mm)	D (mm)	H (mm)
①	Network Server	1	1200	700		⑨	Plotter	1	2000	800	1300
②	DBMS Server	1	1200	700		⑩	Projector	1	1100	700	
③	GIS Workstation	1	1200	700		⑪	Switch	1	800	600	2000
④	Desktop PC	3	1000	700		⑫	Hub				
⑤	NotePC	1	1000	700		⑬	Router				
⑥	Printer (L B)	1	1000	700		⑭	Modem				
⑦	Printer (L J)	1	1100	700		⑮	VSAT IDU				
⑧	Scanner	1	1000	700		⑯	UPS	1			

コンピュータ室フロアレイアウト

都市番号24 吉林省・四平市 No.16

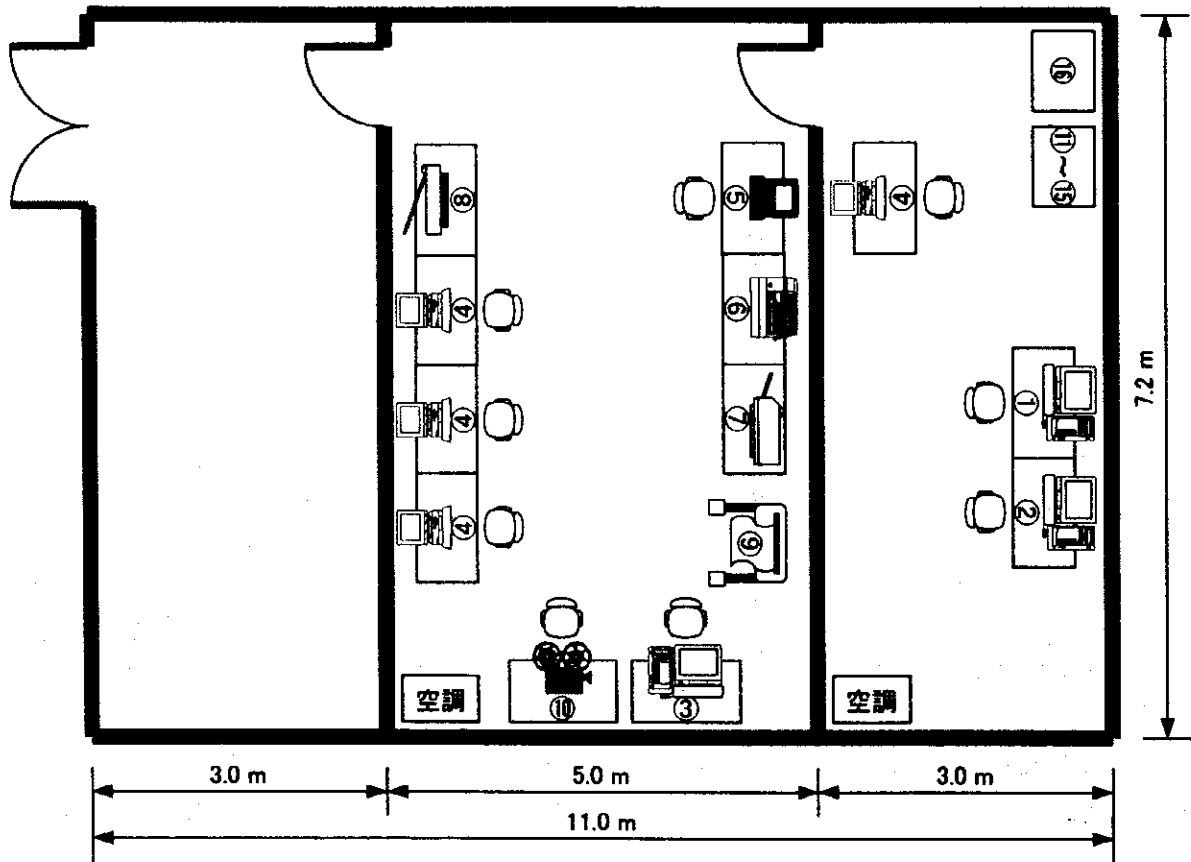

	Equipment	Unit	W (mm)	D (mm)	H (mm)		Equipment	Unit	W (mm)	D (mm)	H (mm)
①	Network Server	1	1200	700		⑨	Plotter	1	2000	800	1300
②	DBMS Server	1	1200	700		⑩	Projector	1	1100	700	
③	GIS Workstation	1	1200	700		⑪	Switch	1	800	600	2000
④	Desktop PC	4	1000	700		⑫	Hub				
⑤	NotePC	1	1000	700		⑬	Router				
⑥	Printer (L. B)	1	1000	700		⑭	Modem				
⑦	Printer (L. J)	1	1100	700		⑮	VSAT IDU				
⑧	Scanner	1	1000	700		⑯	UPS	1			

コンピュータ室フロアレイアウト

都市番号26 黒龍江省・佳木斯市 No.17

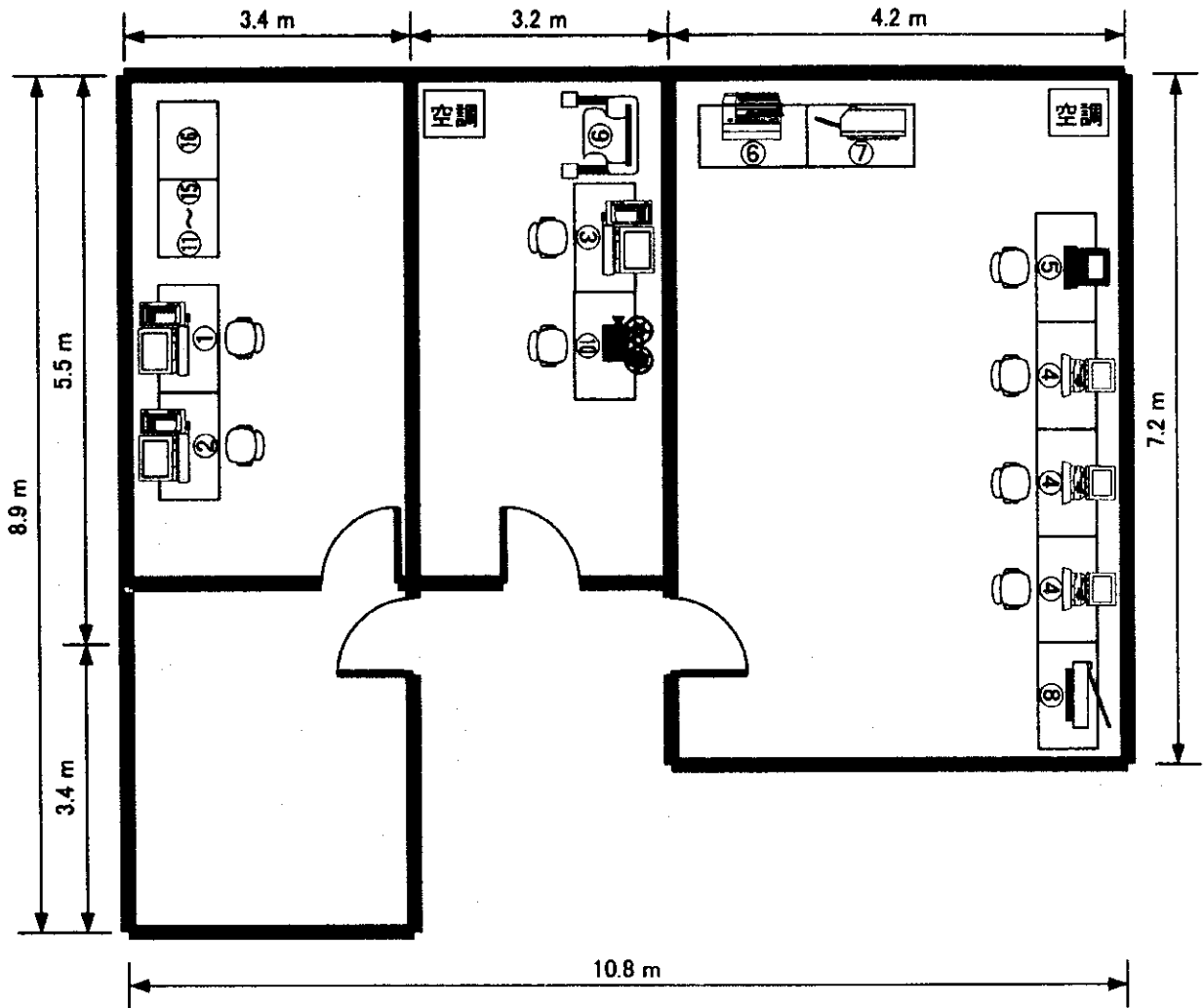

	Equipment	Unit	W (mm)	D (mm)	H (mm)		Equipment	Unit	W (mm)	D (mm)	H (mm)
①	Network Server	1	1200	700		⑨	Plotter	1	2000	800	1300
②	DBMS Server	1	1200	700		⑩	Projector	1	1100	700	
③	GIS Workstation	1	1200	700		⑪	Switch	1	800	600	2000
④	Desktop PC	3	1000	700		⑫	Hub				
⑤	NotePC	1	1000	700		⑬	Router				
⑥	Printer (L B)	1	1000	700		⑭	Modem				
⑦	Printer (I J)	1	1100	700		⑮	VSAT IDU				
⑧	Scanner	1	1000	700		⑯	UPS	1			

コンピュータ室フロアレイアウト

都市番号27 黒龍江省・伊春市 No.18

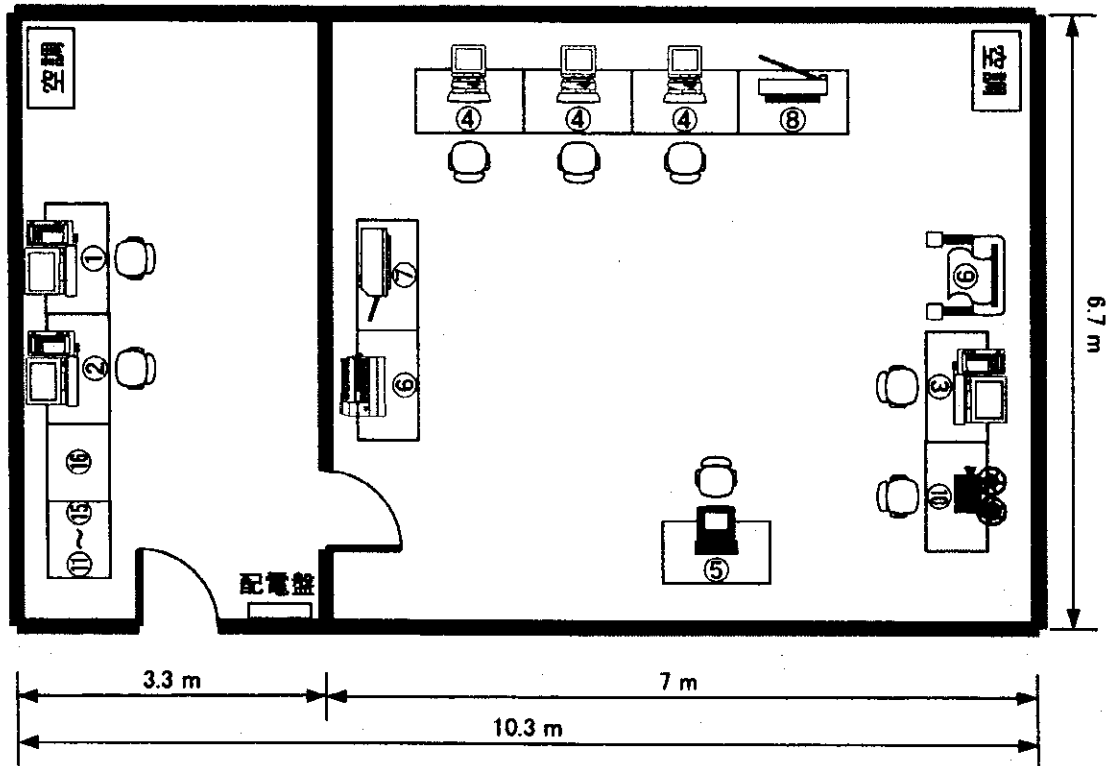

	Equipment	Unit	W (mm)	D (mm)	H (mm)		Equipment	Unit	W (mm)	D (mm)	H (mm)
①	Network Server	1	1200	700		⑨	Plotter	1	2000	800	1300
②	DBMS Server	1	1200	700		⑩	Projector	1	1100	700	
③	GIS Workstation	1	1200	700		⑪	Switch	1	800	600	2000
④	Desktop PC	3	1000	700		⑫	Hub				
⑤	NotePC	1	1000	700		⑬	Router				
⑥	Printer (L B)	1	1000	700		⑭	Modem				
⑦	Printer (L J)	1	1100	700		⑮	VSAT IDU				
⑧	Scanner	1	1000	700		⑯	UPS	1			

コンピュータ室フロアレイアウト

都市番号28 黒龍江省・大慶市 No.19

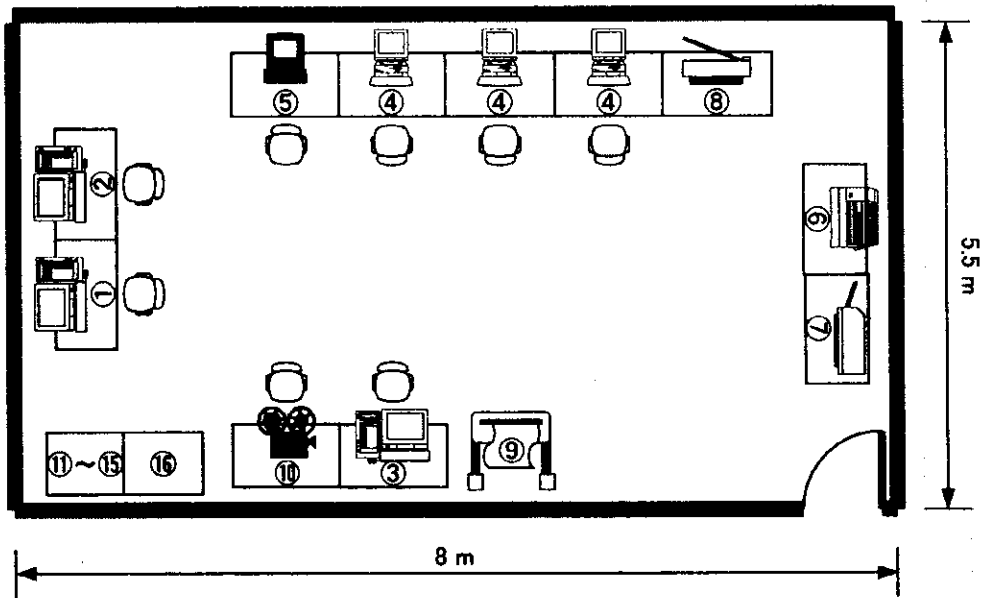

	Equipment	Unit	W (mm)	D (mm)	H (mm)		Equipment	Unit	W (mm)	D (mm)	H (mm)
①	Network Server	1	1200	700		⑨	Plotter	1	2000	800	1300
②	DBMS Server	1	1200	700		⑩	Projector	1	1100	700	
③	GIS Workstation	1	1200	700		⑪	Switch	1	800	600	2000
④	Desktop PC	3	1000	700		⑫	Hub				
⑤	NotePC	1	1000	700		⑬	Router				
⑥	Printer (L. B)	1	1000	700		⑭	Modem				
⑦	Printer (L. J)	1	1100	700		⑮	VSAT IDU				
⑧	Scanner	1	1000	700		⑯	UPS	1			

コンピュータ室フロアレイアウト

都市番号29 黒龍江省・鶴崗市 No.20

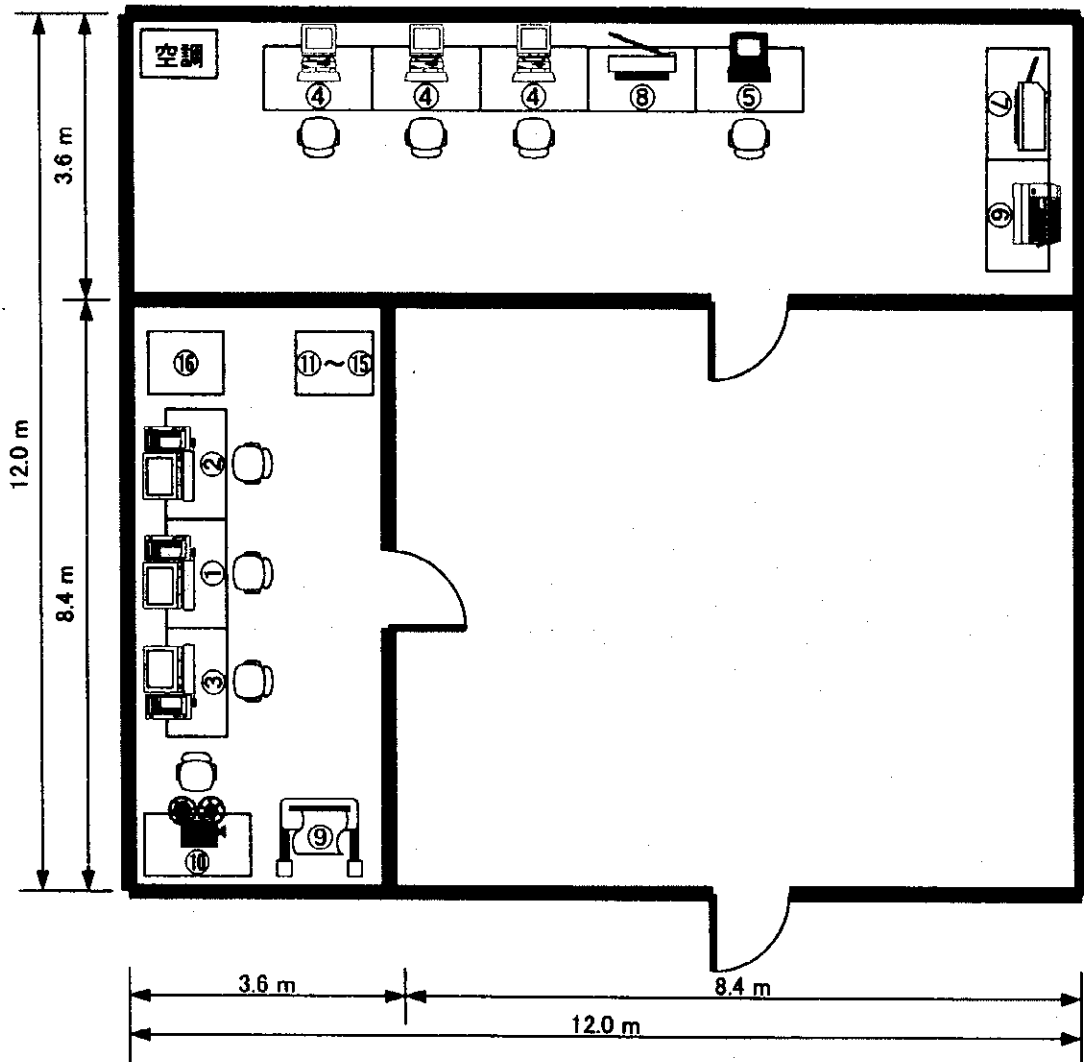

	Equipment	Unit	W (mm)	D (mm)	H (mm)		Equipment	Unit	W (mm)	D (mm)	H (mm)
①	Network Server	1	1200	700		⑨	Plotter	1	2000	800	1300
②	DBMS Server	1	1200	700		⑩	Projector	1	1100	700	
③	GIS Workstation	1	1200	700		⑪	Switch	1	800	600	2000
④	Desktop PC	3	1000	700		⑫	Hub				
⑤	NotePC	1	1000	700		⑬	Router				
⑥	Printer (L B)	1	1000	700		⑭	Modem				
⑦	Printer (L J)	1	1100	700		⑮	VSAT IDU				
⑧	Scanner	1	1000	700		⑯	UPS	1			

コンピュータ室フロアレイアウト

都市番号30 黒龍江省・齊齊哈爾市 No.21

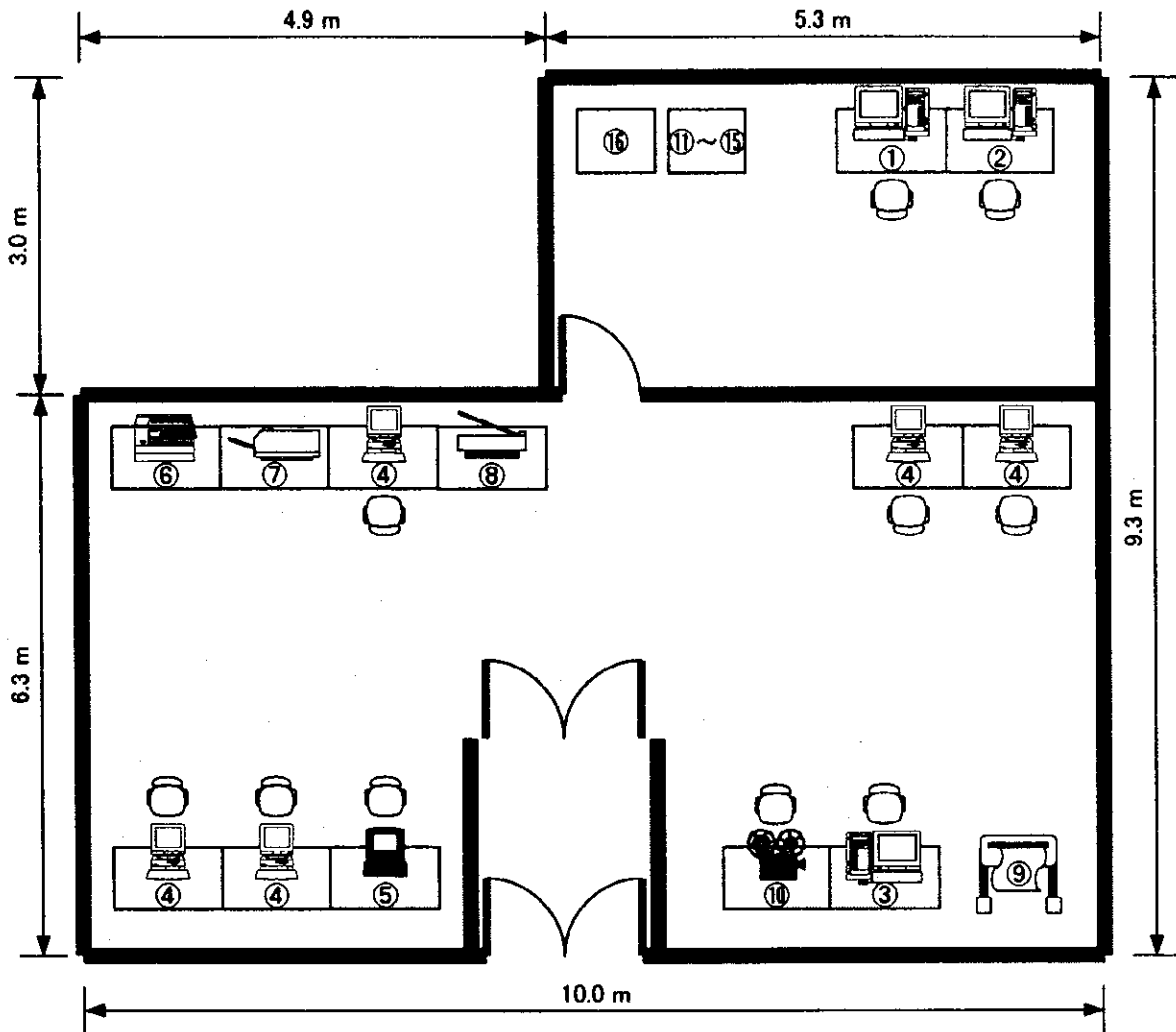

	Equipment	Unit	W (mm)	D (mm)	H (mm)		Equipment	Unit	W (mm)	D (mm)	H (mm)
①	Network Server	1	1200	700		⑨	Plotter	1	2000	800	1300
②	DBMS Server	1	1200	700		⑩	Projector	1	1100	700	
③	GIS Workstation	1	1200	700		⑪	Switch	1	800	600	2000
④	Desktop PC	5	1000	700		⑫	Hub				
⑤	NotePC	1	1000	700		⑬	Router				
⑥	Printer (L B)	1	1000	700		⑭	Modem				
⑦	Printer (L J)	1	1100	700		⑮	VSAT IDU				
⑧	Scanner	1	1000	700		⑯	UPS	1			

コンピュータ室フロアレイアウト

都市番号31 江蘇省・揚州市 No.22

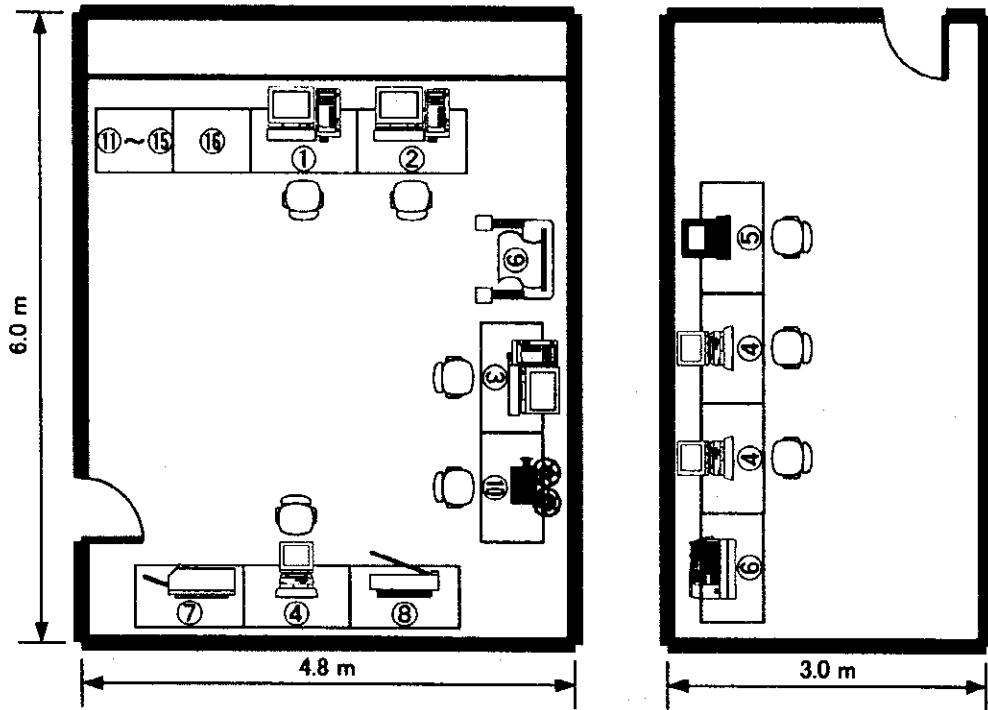

	Equipment	Unit	W (mm)	D (mm)	H (mm)		Equipment	Unit	W (mm)	D (mm)	H (mm)
①	Network Server	1	1200	700		⑨	Plotter	1	2000	800	1300
②	DBMS Server	1	1200	700		⑩	Projector	1	1100	700	
③	GIS Workstation	1	1200	700		⑪	Switch	1	800	600	2000
④	Desktop PC	3	1000	700		⑫	Hub				
⑤	NotePC	1	1000	700		⑬	Router				
⑥	Printer (L. B)	1	1000	700		⑭	Modem				
⑦	Printer (I. J)	1	1100	700		⑮	VSAT IDU				
⑧	Scanner	1	1000	700		⑯	UPS	1			

コンピュータ室フロアレイアウト

都市番号36 江蘇省・鎮江市 No.23

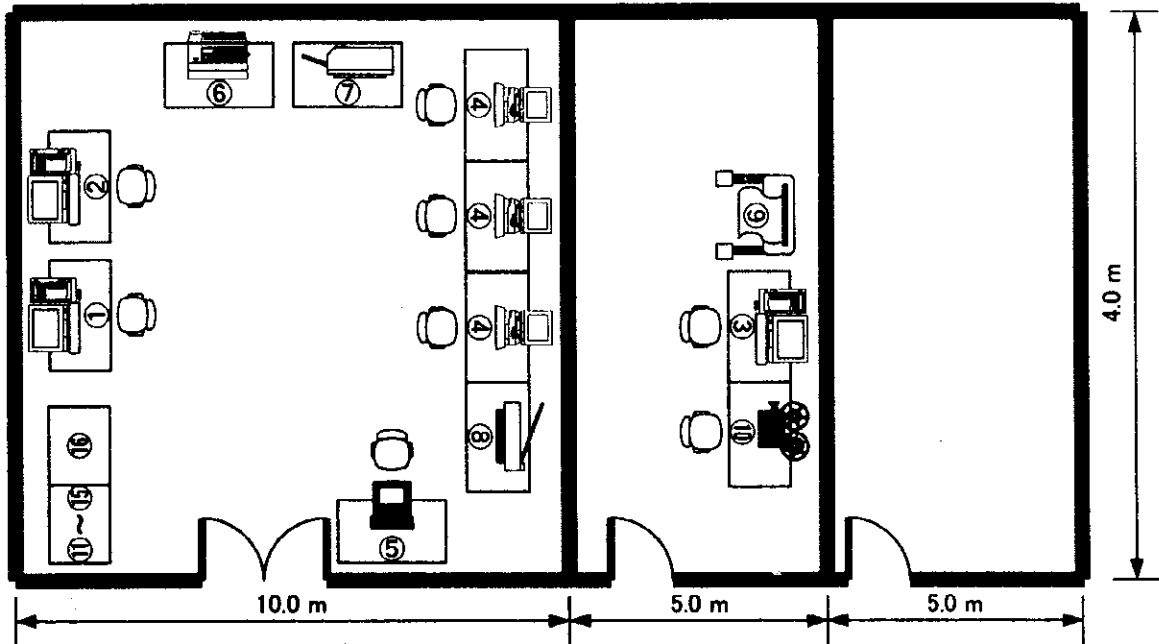

	Equipment	Unit	W (mm)	D (mm)	H (mm)		Equipment	Unit	W (mm)	D (mm)	H (mm)
①	Network Server	1	1200	700		⑨	Plotter	1	2000	800	1300
②	DBMS Server	1	1200	700		⑩	Projector	1	1100	700	
③	GIS Workstation	1	1200	700		⑪	Switch	1	800	600	2000
④	Desktop PC	3	1000	700		⑫	Hub				
⑤	NotePC	1	1000	700		⑬	Router				
⑥	Printer (L B)	1	1000	700		⑭	Modem				
⑦	Printer (L J)	1	1100	700		⑮	VSAT IDU	1			
⑧	Scanner	1	1000	700		⑯	UPS	1			

コンピュータ室フロアレイアウト

都市番号40 浙江省・舟山市 No.24

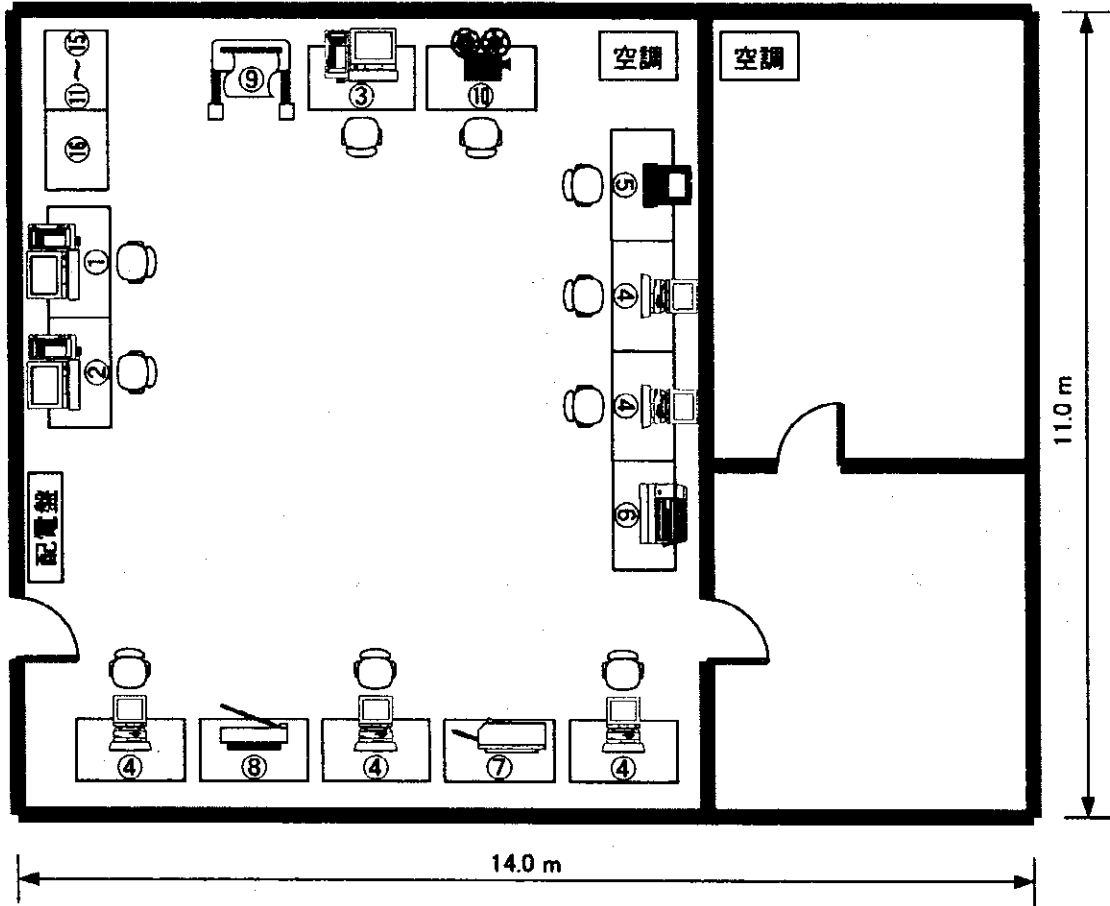

	Equipment	Unit	W (mm)	D (mm)	H (mm)		Equipment	Unit	W (mm)	D (mm)	H (mm)
①	Network Server	1	1200	700		⑨	Plotter	1	2000	800	1300
②	DBMS Server	1	1200	700		⑩	Projector	1	1100	700	
③	GIS Workstation	1	1200	700		⑪	Switch	1	800	600	2000
④	Desktop PC	5	1000	700		⑫	Hub				
⑤	NotePC	1	1000	700		⑬	Router				
⑥	Printer (L. B)	1	1000	700		⑭	Modem				
⑦	Printer (I. J)	1	1100	700		⑮	VSAT IDU				
⑧	Scanner	1	1000	700		⑯	UPS	1			

コンピュータ室フロアレイアウト

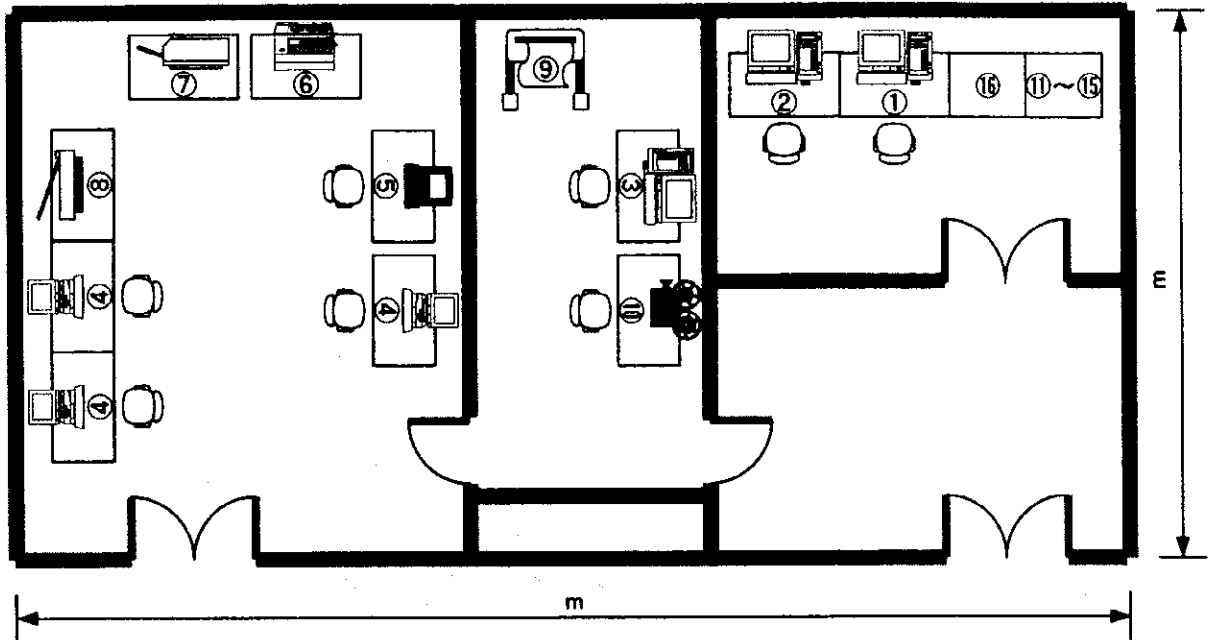

	Equipment	Unit	W (mm)	D (mm)	H (mm)		Equipment	Unit	W (mm)	D (mm)	H (mm)
①	Network Server	1	1200	700		⑨	Plotter	1	2000	800	1300
②	DBMS Server	1	1200	700		⑩	Projector	1	1100	700	
③	GIS Workstation	1	1200	700		⑪	Switch	1	800	600	2000
④	Desktop PC	3	1000	700		⑫	Hub				
⑤	NotePC	1	1000	700		⑬	Router				
⑥	Printer (L. B)	1	1000	700		⑭	Modem				
⑦	Printer (I. J)	1	1100	700		⑮	VSAT IDU				
⑧	Scanner	1	1000	700		⑯	UPS	1			

コンピュータ室フロアレイアウト

都市番号46 安徽省・蕪湖市 No.26

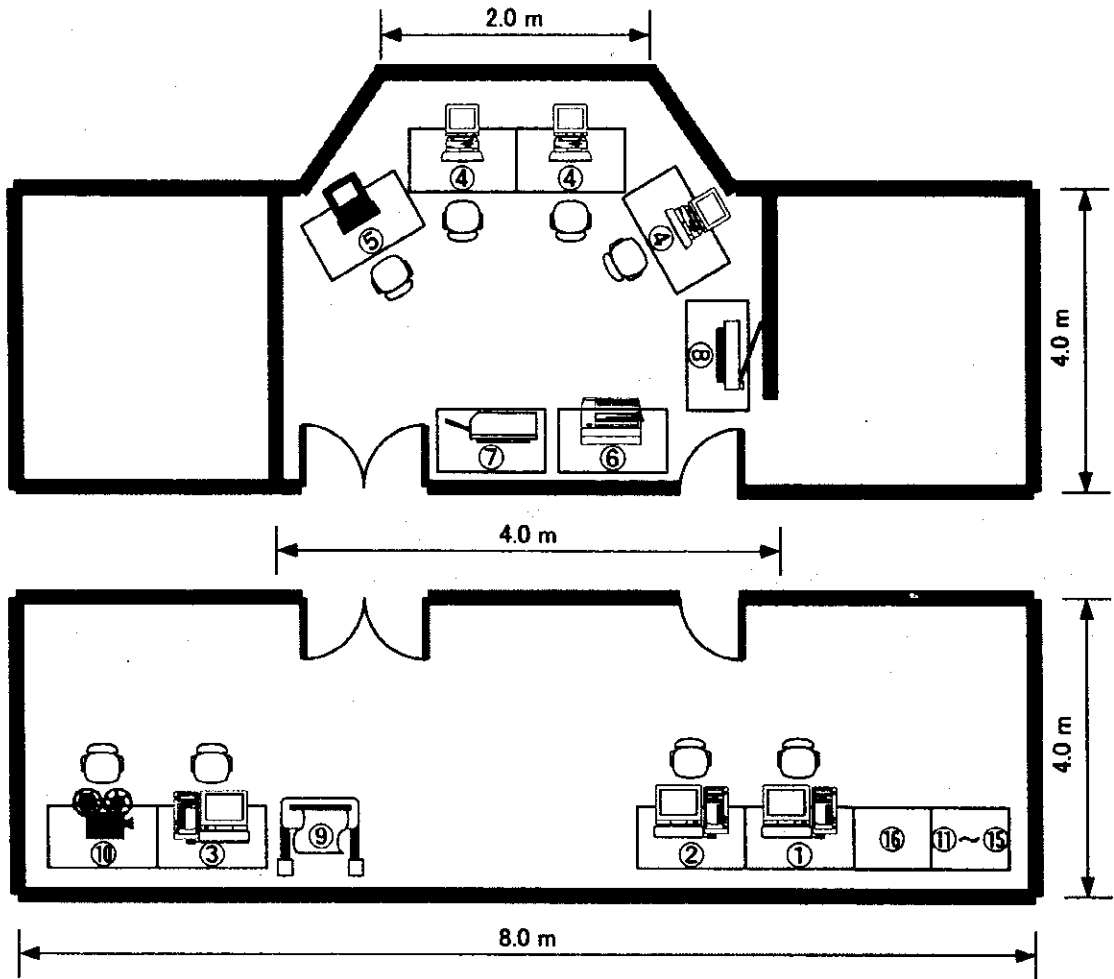

	Equipment	Unit	W (mm)	D (mm)	H (mm)		Equipment	Unit	W (mm)	D (mm)	H (mm)
①	Network Server	1	1200	700		⑨	Plotter	1	2000	800	1300
②	DBMS Server	1	1200	700		⑩	Projector	1	1100	700	
③	GIS Workstation	1	1200	700		⑪	Switch	1	800	600	2000
④	Desktop PC	3	1000	700		⑫	Hub				
⑤	NotePC	1	1000	700		⑬	Router				
⑥	Printer (L B)	1	1000	700		⑭	Modem				
⑦	Printer (I J)	1	1100	700		⑮	VSAT IDU				
⑧	Scanner	1	1000	700		⑯	UPS	1			

コンピュータ室フロアレイアウト

都市番号47 福建省・泉州市 No.27

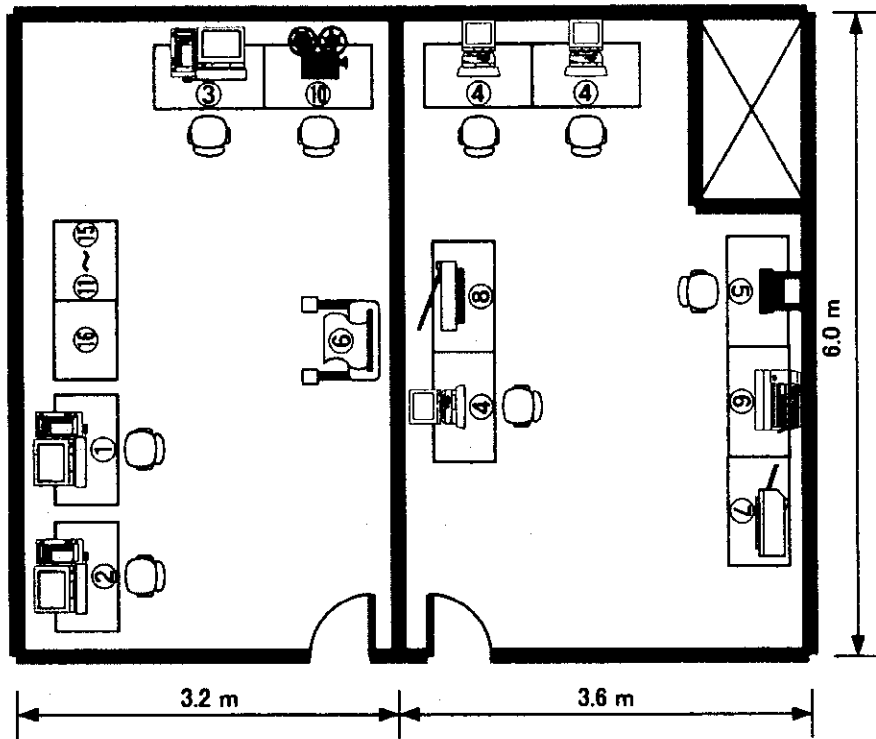

	Equipment	Unit	W (mm)	D (mm)	H (mm)		Equipment	Unit	W (mm)	D (mm)	H (mm)
①	Network Server	1	1200	700		⑨	Plotter	1	2000	800	1300
②	DBMS Server	1	1200	700		⑩	Projector	1	1100	700	
③	GIS Workstation	1	1200	700		⑪	Switch	1	800	600	2000
④	Desktop PC	3	1000	700		⑫	Hub				
⑤	NotePC	1	1000	700		⑬	Router				
⑥	Printer (L B)	1	1000	700		⑭	Modem				
⑦	Printer (I J)	1	1100	700		⑮	VSAT IDU				
⑧	Scanner	1	1000	700		⑯	UPS	1			

コンピュータ室フロアレイアウト

都市番号48 福建省・三明市 No.28

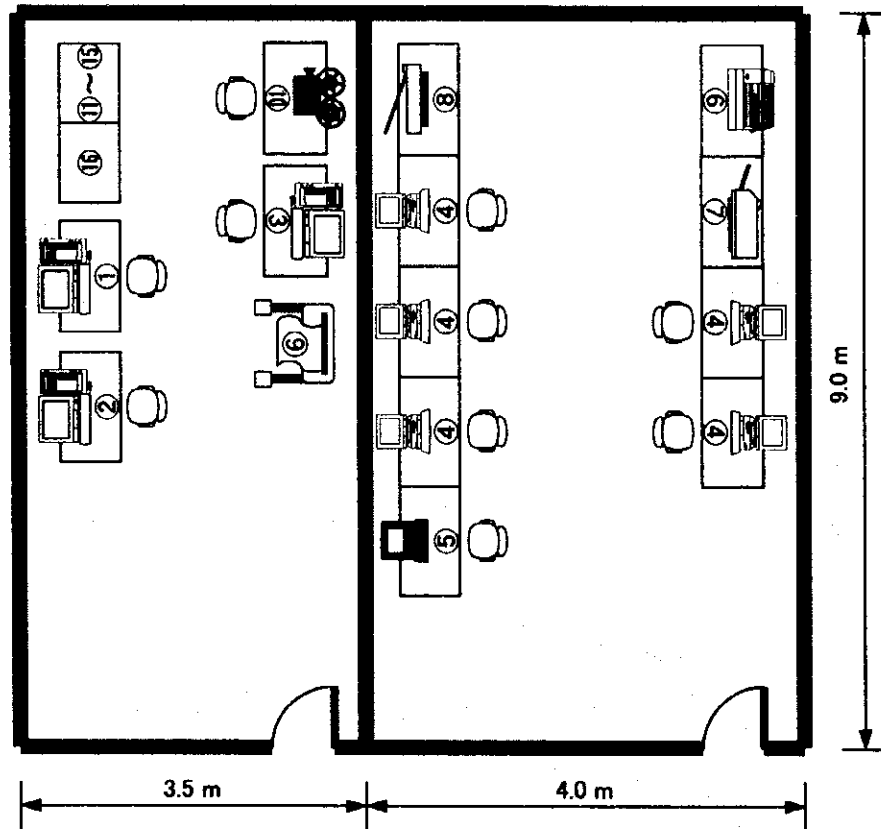

	Equipment	Unit	W (mm)	D (mm)	H (mm)		Equipment	Unit	W (mm)	D (mm)	H (mm)
①	Network Server	1	1200	700		⑨	Plotter	1	2000	800	1300
②	DBMS Server	1	1200	700		⑩	Projector	1	1100	700	
③	GIS Workstation	1	1200	700		⑪	Switch	1	800	600	2000
④	Desktop PC	5	1000	700		⑫	Hub				
⑤	NotePC	1	1000	700		⑬	Router				
⑥	Printer (L B)	1	1000	700		⑭	Modem				
⑦	Printer (L J)	1	1100	700		⑮	VSAT IDU				
⑧	Scanner	1	1000	700		⑯	UPS	1			

コンピュータ室フロアレイアウト

都市番号49 江西省・萍郷市 No.29

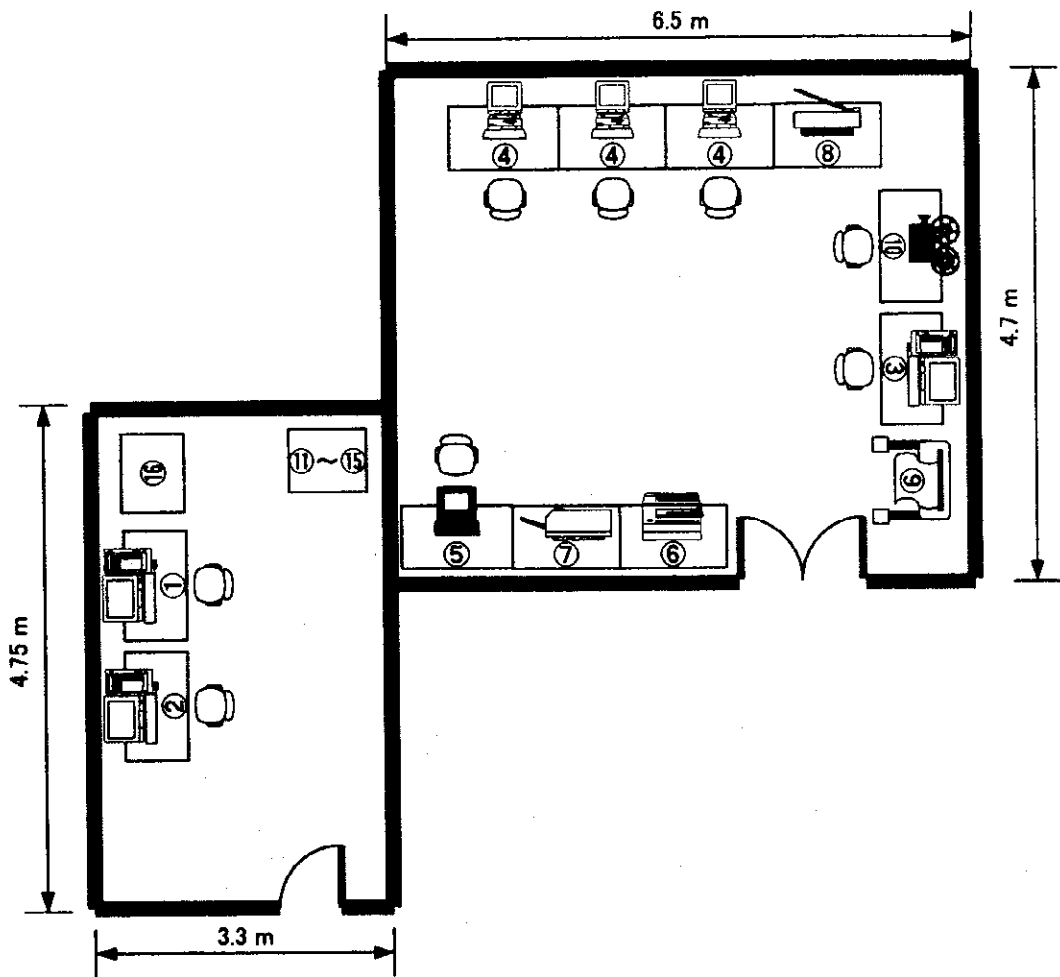

	Equipment	Unit	W (mm)	D (mm)	H (mm)		Equipment	Unit	W (mm)	D (mm)	H (mm)
①	Network Server	1	1200	700		⑨	Plotter	1	2000	800	1300
②	DBMS Server	1	1200	700		⑩	Projector	1	1100	700	
③	GIS Workstation	1	1200	700		⑪	Switch	1	800	600	2000
④	Desktop PC	3	1000	700		⑫	Hub				
⑤	NotePC	1	1000	700		⑬	Router				
⑥	Printer (L. B)	1	1000	700		⑭	Modem				
⑦	Printer (I. J)	1	1100	700		⑮	VSAT IDU				
⑧	Scanner	1	1000	700		⑯	UPS	1			

コンピュータ室フロアレイアウト

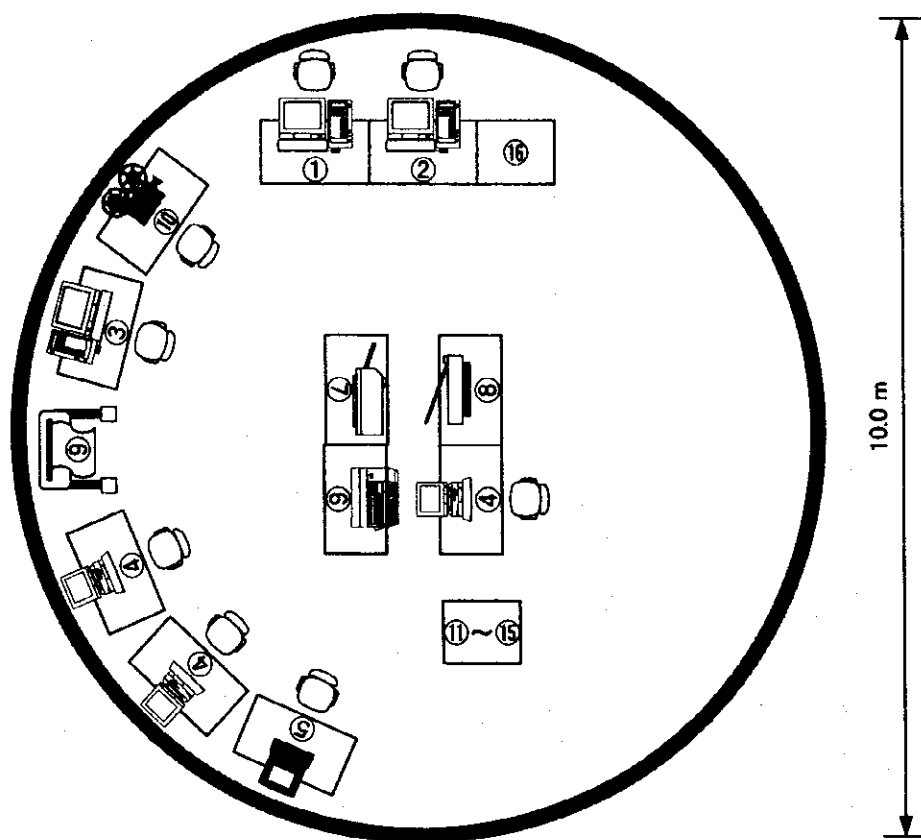

	Equipment	Unit	W (mm)	D (mm)	H (mm)		Equipment	Unit	W (mm)	D (mm)	H (mm)
①	Network Server	1	1200	700		⑨	Plotter	1	2000	800	1300
②	DBMS Server	1	1200	700		⑩	Projector	1	1100	700	
③	GIS Workstation	1	1200	700		⑪	Switch	1	800	600	2000
④	Desktop PC	3	1000	700		⑫	Hub				
⑤	NotePC	1	1000	700		⑬	Router				
⑥	Printer (L B)	1	1000	700		⑭	Modem				
⑦	Printer (L J)	1	1100	700		⑮	VSAT IDU				
⑧	Scanner	1	1000	700		⑯	UPS	1			

コンピュータ室フロアレイアウト

都市番号51 江西省・赣州市 No.31

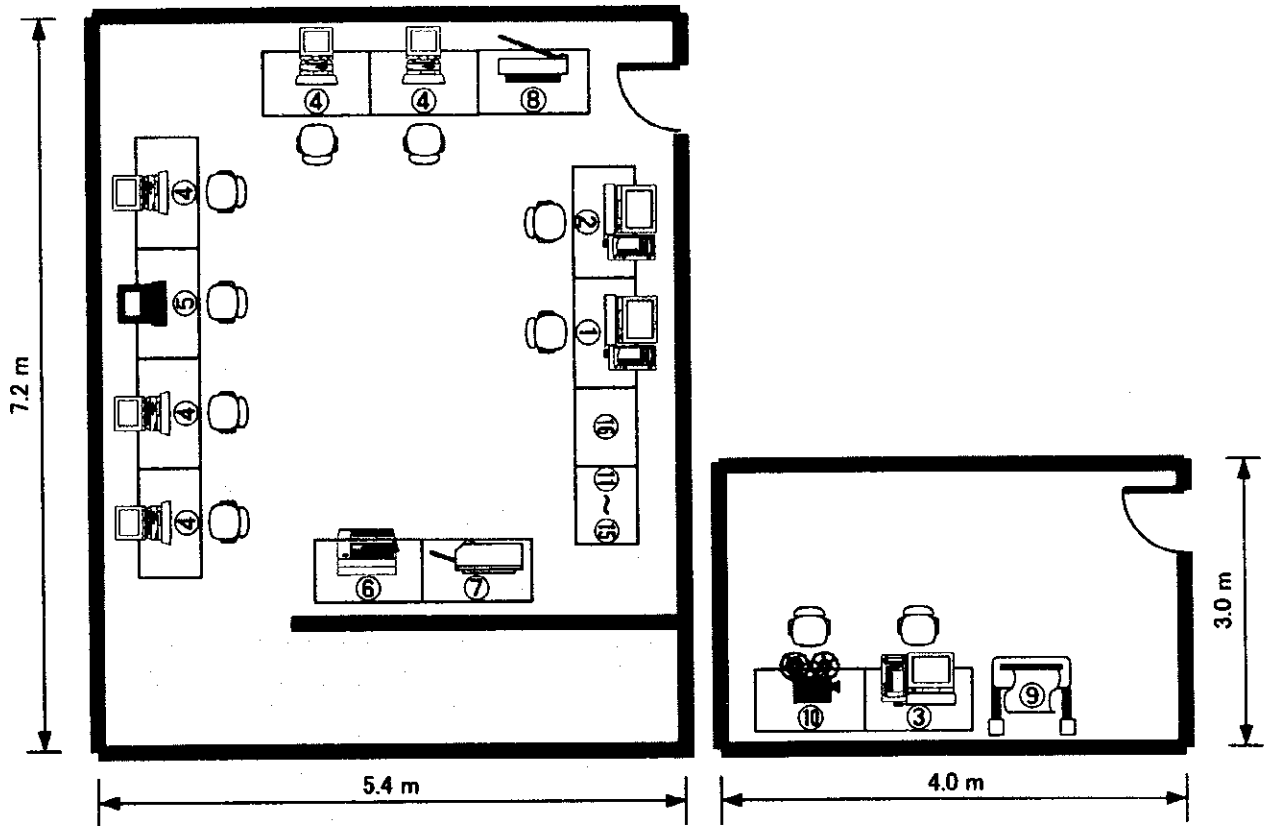

	Equipment	Unit	W (mm)	D (mm)	H (mm)		Equipment	Unit	W (mm)	D (mm)	H (mm)
①	Network Server	1	1200	700		⑨	Plotter	1	2000	800	1300
②	DBMS Server	1	1200	700		⑩	Projector	1	1100	700	
③	GIS Workstation	1	1200	700		⑪	Switch	1	800	600	2000
④	Desktop PC	5	1000	700		⑫	Hub				
⑤	NotePC	1	1000	700		⑬	Router				
⑥	Printer (L B)	1	1000	700		⑭	Modem				
⑦	Printer (L J)	1	1100	700		⑮	VSAT IDU				
⑧	Scanner	1	1000	700		⑯	UPS	1			

コンピュータ室フロアレイアウト

都市番号52 江西省・景德镇市 No.32

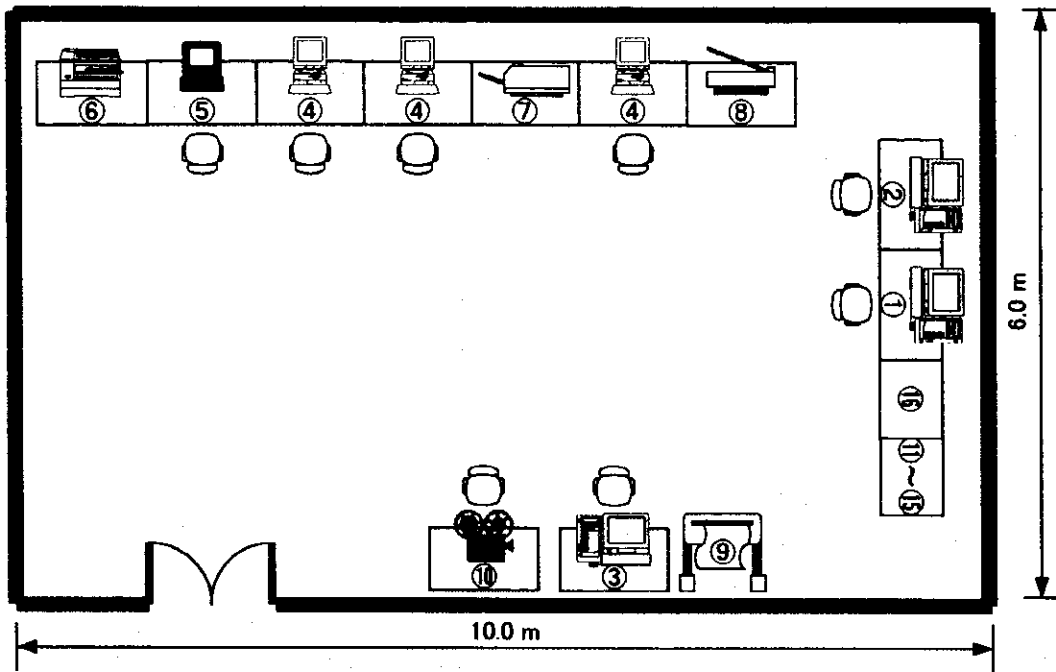

	Equipment	Unit	W (mm)	D (mm)	H (mm)		Equipment	Unit	W (mm)	D (mm)	H (mm)
①	Network Server	1	1200	700		⑨	Plotter	1	2000	800	1300
②	DBMS Server	1	1200	700		⑩	Projector	1	1100	700	
③	GIS Workstation	1	1200	700		⑪	Switch	1	800	600	2000
④	Desktop PC	3	1000	700		⑫	Hub				
⑤	NotePC	1	1000	700		⑬	Router				
⑥	Printer (L. B)	1	1000	700		⑭	Modem				
⑦	Printer (I. J)	1	1100	700		⑮	VSAT IDU				
⑧	Scanner	1	1000	700		⑯	UPS	1			

コンピュータ室フロアレイアウト

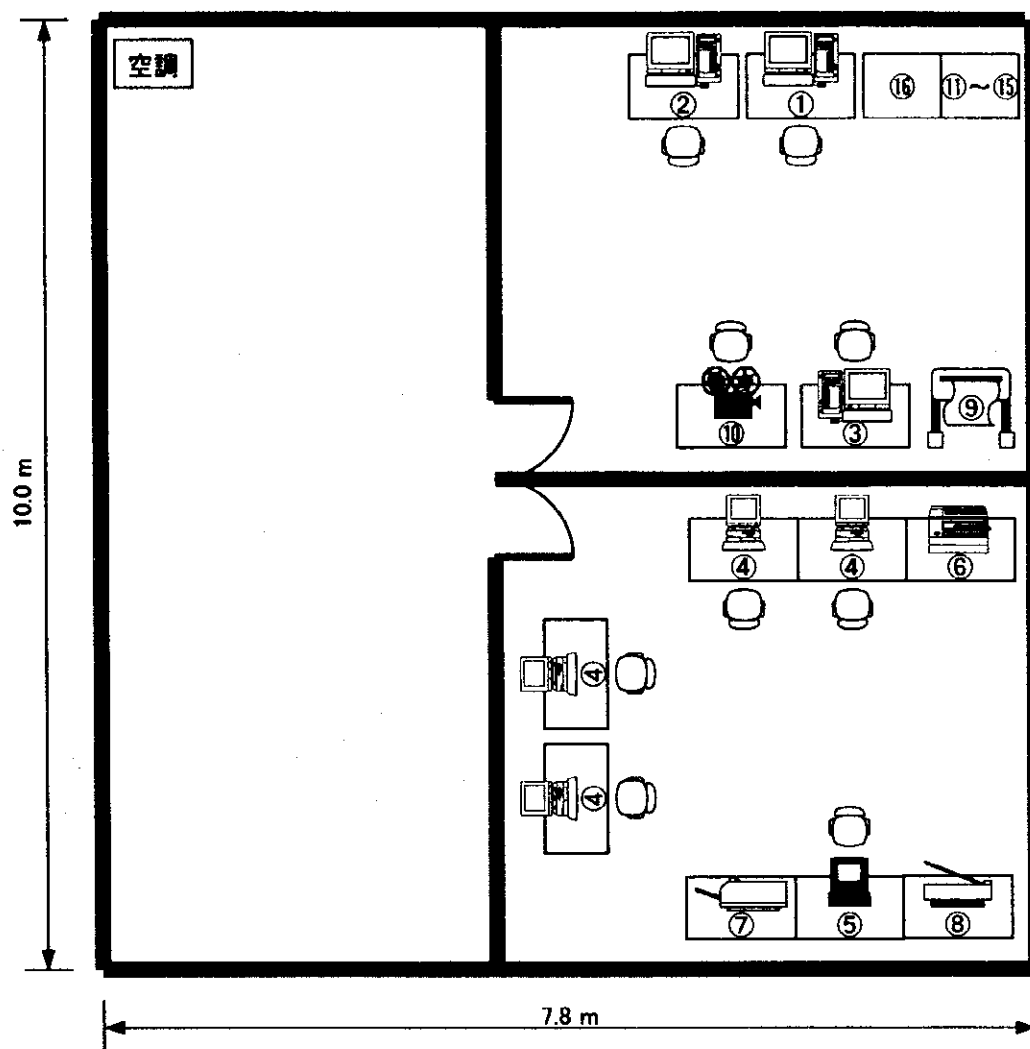

	Equipment	Unit	W (mm)	D (mm)	H (mm)		Equipment	Unit	W (mm)	D (mm)	H (mm)
①	Network Server	1	1200	700		⑨	Plotter	1	2000	800	1300
②	DBMS Server	1	1200	700		⑩	Projector	1	1100	700	
③	GIS Workstation	1	1200	700		⑪	Switch	1	800	600	2000
④	Desktop PC	4	1000	700	⑫	Hub					
⑤	NotePC	1	1000	700	⑬	Router					
⑥	Printer (L B)	1	1000	700	⑭	Modem					
⑦	Printer (L J)	1	1100	700	⑮	VSAT IDU					
⑧	Scanner	1	1000	700	⑯	UPS	1				

コンピュータ室フロアレイアウト

都市番号59 河南省・焦作市 No.34

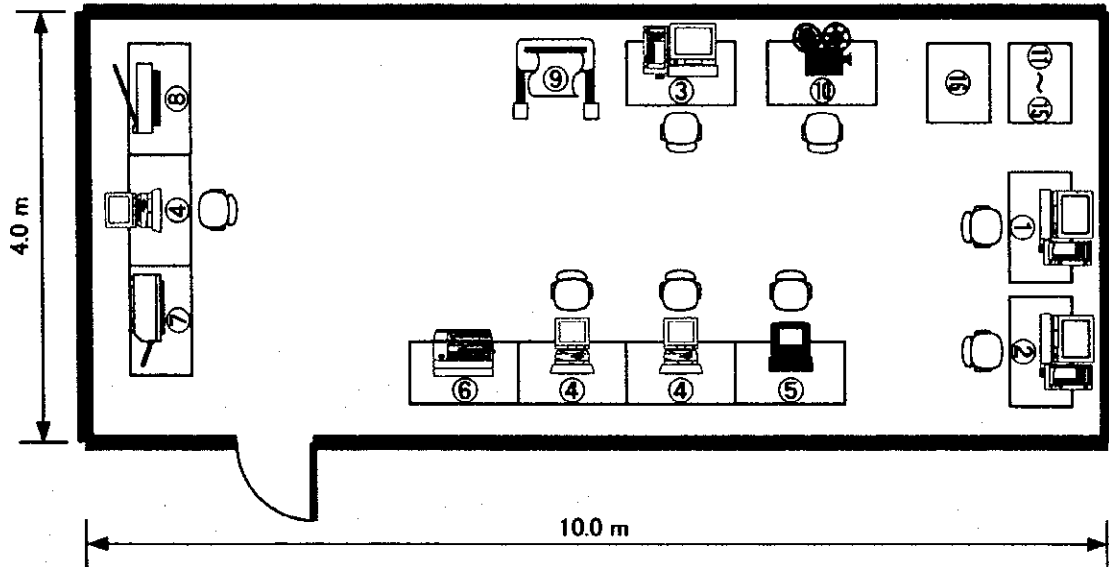

	Equipment	Unit	W (mm)	D (mm)	H (mm)		Equipment	Unit	W (mm)	D (mm)	H (mm)
①	Network Server	1	1200	700		⑨	Plotter	1	2000	800	1300
②	DBMS Server	1	1200	700		⑩	Projector	1	1100	700	
③	GIS Workstation	1	1200	700		⑪	Switch	1	800	600	2000
④	Desktop PC	3	1000	700		⑫	Hub				
⑤	NotePC	1	1000	700		⑬	Router				
⑥	Printer (L. B)	1	1000	700		⑭	Modem				
⑦	Printer (I. J)	1	1100	700		⑮	VSAT IDU	1			
⑧	Scanner	1	1000	700		⑯	UPS				

コンピュータ室フロアレイアウト

都市番号61 河南省・安陽市 No.35

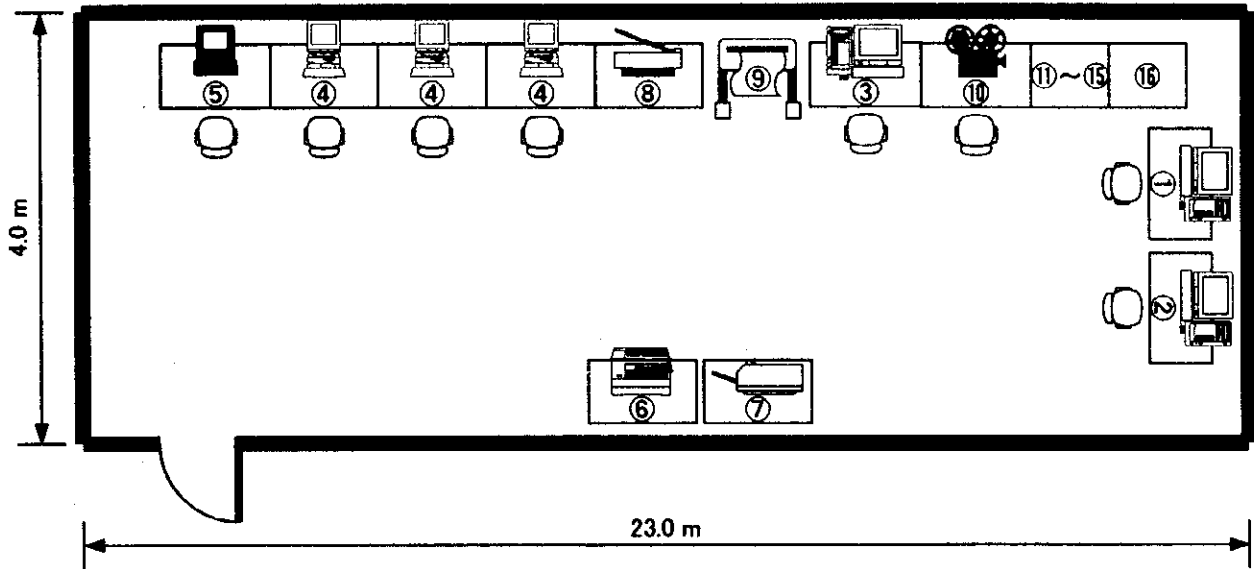

	Equipment	Unit	W (mm)	D (mm)	H (mm)		Equipment	Unit	W (mm)	D (mm)	H (mm)
①	Network Server	1	1200	700		⑨	Plotter	1	2000	800	1300
②	DBMS Server	1	1200	700		⑩	Projector	1	1100	700	
③	GIS Workstation	1	1200	700		⑪	Switch	1	800	600	2000
④	Desktop PC	3	1000	700		⑫	Hub				
⑤	NotePC	1	1000	700		⑬	Router				
⑥	Printer (L.B)	1	1000	700		⑭	Modem				
⑦	Printer (L.J)	1	1100	700		⑮	VSAT IDU				
⑧	Scanner	1	1000	700		⑯	UPS	1			

コンピュータ室フロアレイアウト

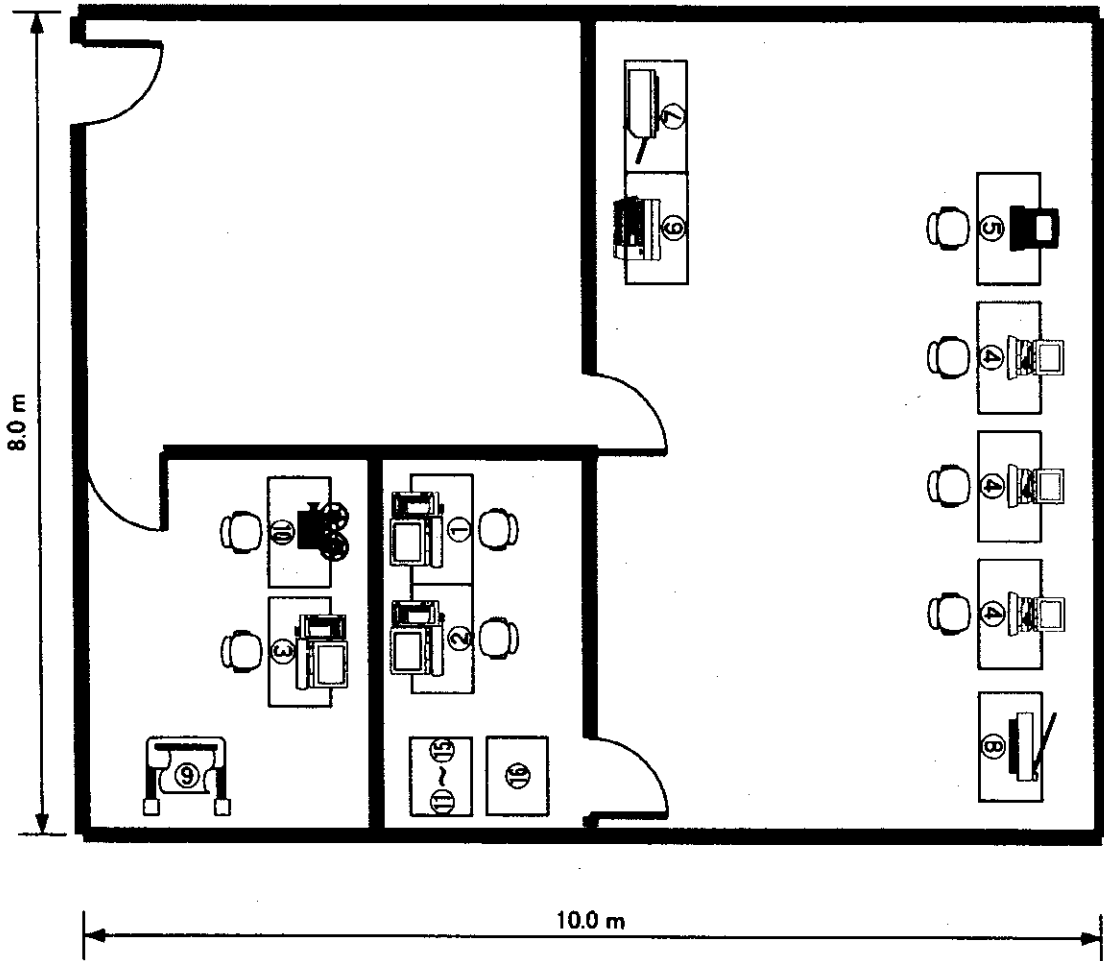

	Equipment	Unit	W (mm)	D (mm)	H (mm)		Equipment	Unit	W (mm)	D (mm)	H (mm)
①	Network Server	1	1200	700		⑨	Plotter	1	2000	800	1300
②	DBMS Server	1	1200	700		⑩	Projector	1	1100	700	
③	GIS Workstation	1	1200	700		⑪	Switch	1	800	600	2000
④	Desktop PC	3	1000	700		⑫	Hub				
⑤	NotePC	1	1000	700		⑬	Router				
⑥	Printer (L B)	1	1000	700		⑭	Modem				
⑦	Printer (I J)	1	1100	700		⑮	VSAT IDU				
⑧	Scanner	1	1000	700		⑯	UPS	1			

コンピュータ室フロアレイアウト

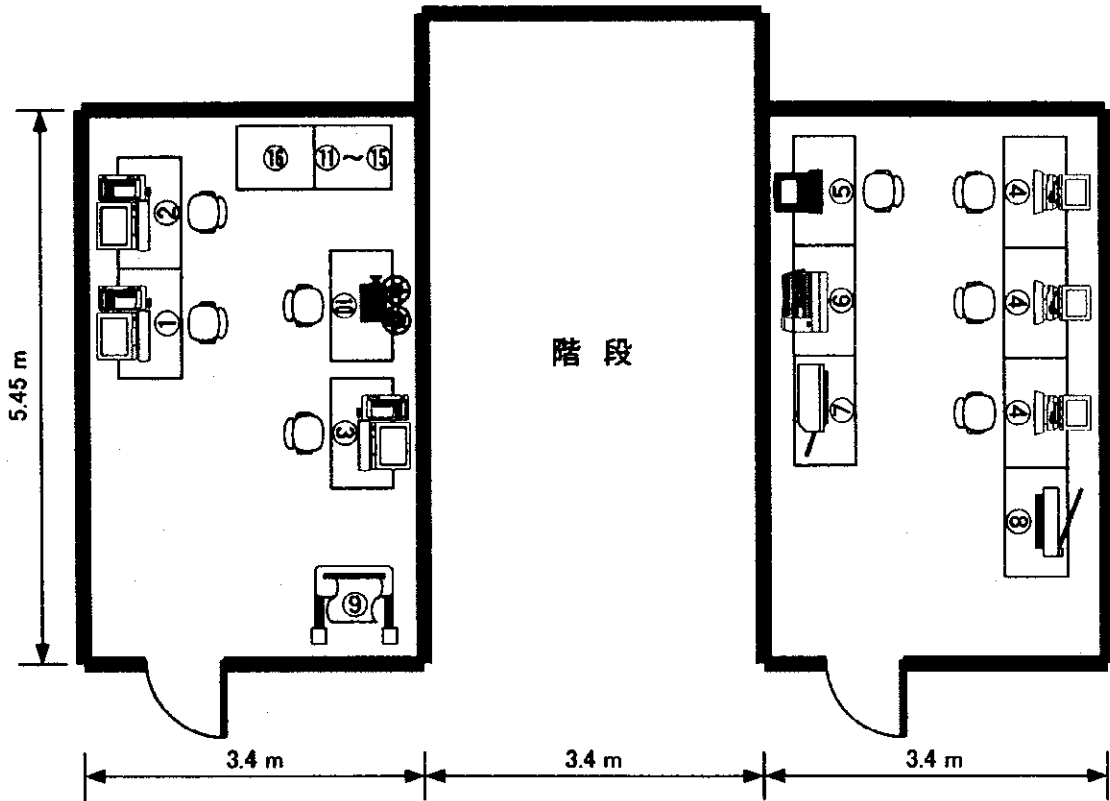

	Equipment	Unit	W (mm)	D (mm)	H (mm)		Equipment	Unit	W (mm)	D (mm)	H (mm)
①	Network Server	1	1200	700		⑨	Plotter	1	2000	800	1300
②	DBMS Server	1	1200	700		⑩	Projector	1	1100	700	
③	GIS Workstation	1	1200	700		⑪	Switch	1	800	600	2000
④	Desktop PC	3	1000	700		⑫	Hub				
⑤	NotePC	1	1000	700		⑬	Router				
⑥	Printer (L. B.)	1	1000	700		⑭	Modem				
⑦	Printer (I. J.)	1	1100	700		⑮	VSAT IDU				
⑧	Scanner	1	1000	700		⑯	UPS	1			

コンピュータ室フロアレイアウト

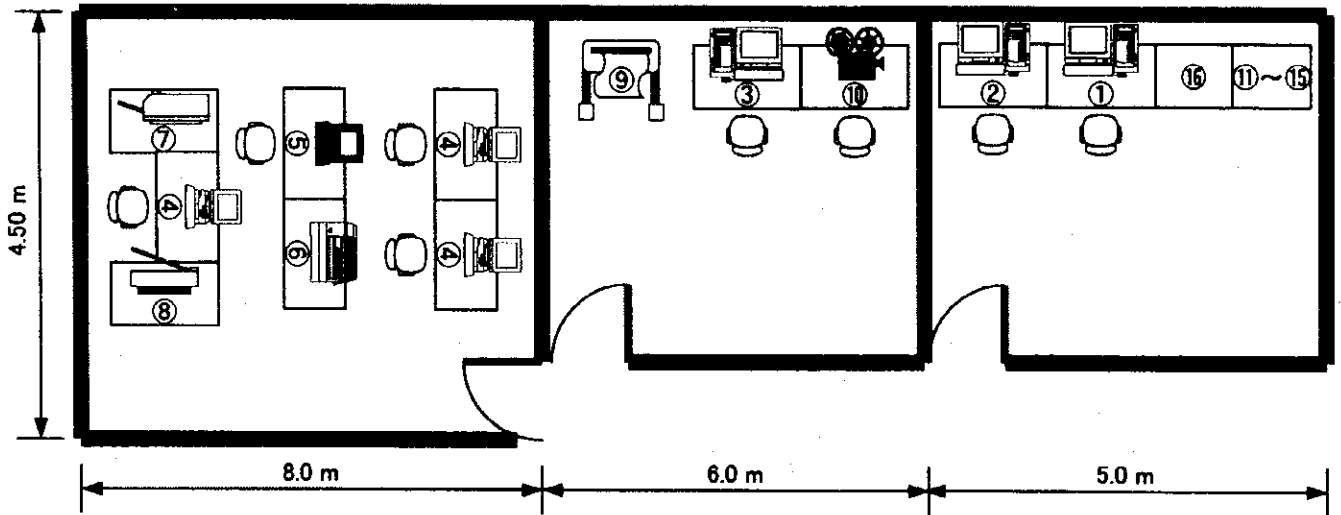

	Equipment	Unit	W (mm)	D (mm)	H (mm)		Equipment	Unit	W (mm)	D (mm)	H (mm)
①	Network Server	1	1200	700		⑨	Plotter	1	2000	800	1300
②	DBMS Server	1	1200	700		⑩	Projector	1	1100	700	
③	GIS Workstation	1	1200	700		⑪	Switch	1	800	600	2000
④	Desktop PC	3	1000	700		⑫	Hub				
⑤	NotePC	1	1000	700		⑬	Router				
⑥	Printer (L B)	1	1000	700		⑭	Modem				
⑦	Printer (I J)	1	1100	700		⑮	VSAT IDU				
⑧	Scanner	1	1000	700		⑯	UPS	1			

コンピュータ室フロアレイアウト

都市番号65 湖北省・宜昌市 No.39

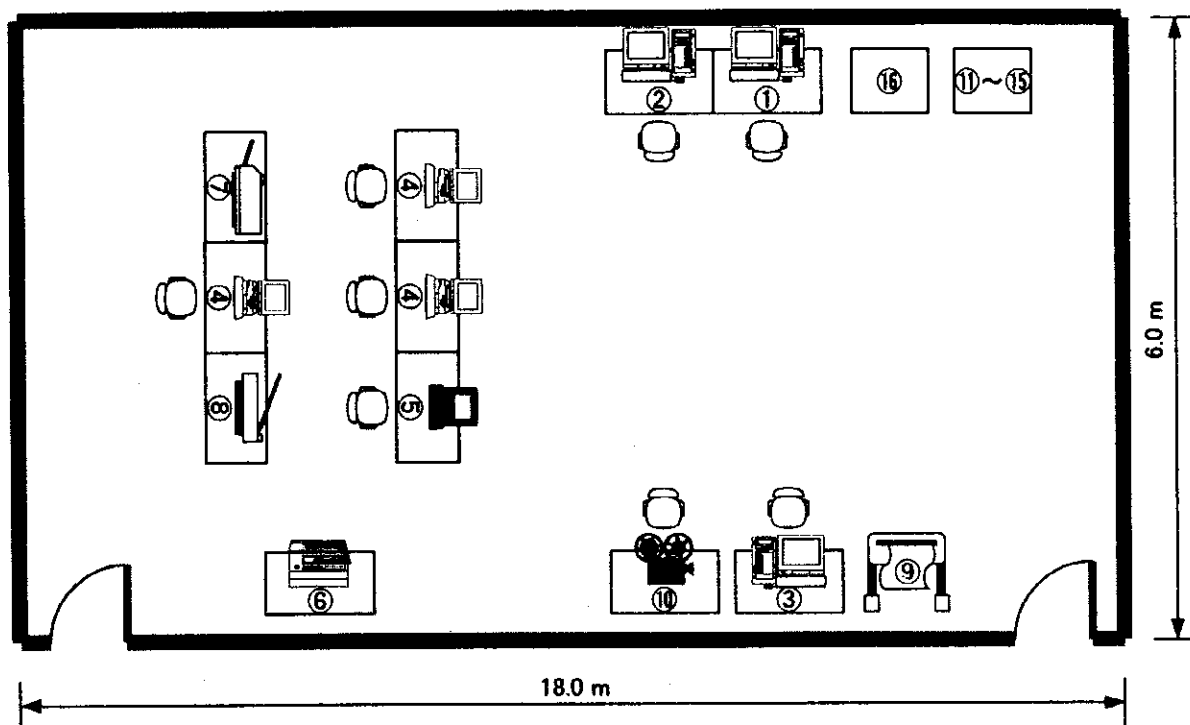

	Equipment	Unit	W (mm)	D (mm)	H (mm)		Equipment	Unit	W (mm)	D (mm)	H (mm)
①	Network Server	1	1200	700		⑨	Plotter	1	2000	800	1300
②	DBMS Server	1	1200	700		⑩	Projector	1	1100	700	
③	GIS Workstation	1	1200	700		⑪	Switch	1	800	600	2000
④	Desktop PC	3	1000	700		⑫	Hub				
⑤	NotePC	1	1000	700		⑬	Router				
⑥	Printer (L B)	1	1000	700		⑭	Modem				
⑦	Printer (L J)	1	1100	700		⑮	VSAT IDU				
⑧	Scanner	1	1000	700		⑯	UPS	1			

コンピュータ室フロアレイアウト

都市番号67 湖南省・衡陽市 No.40

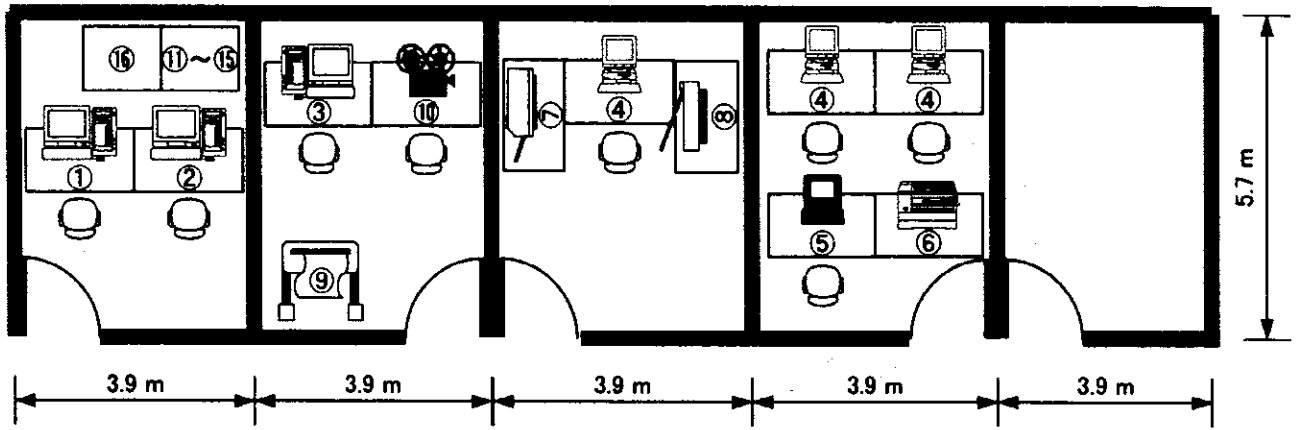

	Equipment	Unit	W (mm)	D (mm)	H (mm)		Equipment	Unit	W (mm)	D (mm)	H (mm)
①	Network Server	1	1200	700		⑨	Plotter	1	2000	800	1300
②	DBMS Server	1	1200	700		⑩	Projector	1	1100	700	
③	GIS Workstation	1	1200	700		⑪	Switch	1	800	600	2000
④	Desktop PC	3	1000	700		⑫	Hub				
⑤	NotePC	1	1000	700		⑬	Router				
⑥	Printer (L B)	1	1000	700		⑭	Modem				
⑦	Printer (I J)	1	1100	700		⑮	VSAT IDU				
⑧	Scanner	1	1000	700		⑯	UPS	1			

コンピュータ室フロアレイアウト

都市番号68 湖南省・岳陽市 No.41

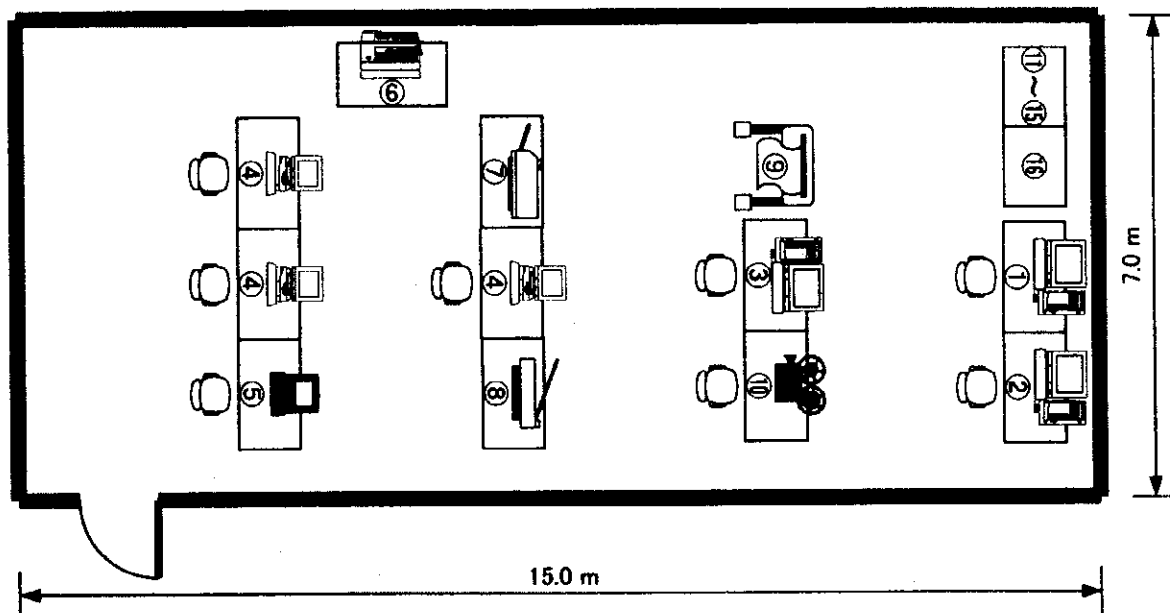

	Equipment	Unit	W (mm)	D (mm)	H (mm)		Equipment	Unit	W (mm)	D (mm)	H (mm)
①	Network Server	1	1200	700		⑨	Plotter	1	2000	800	1300
②	DBMS Server	1	1200	700		⑩	Projector	1	1100	700	
③	GIS Workstation	1	1200	700		⑪	Switch				
④	Desktop PC	3	1000	700		⑫	Hub				
⑤	NotePC	1	1000	700		⑬	Router	1	800	600	2000
⑥	Printer (L B)	1	1000	700		⑭	Modem				
⑦	Printer (L J)	1	1100	700		⑮	VSAT IDU				
⑧	Scanner	1	1000	700		⑯	UPS	1			

コンピュータ室フロアレイアウト

都市番号69 湖南省・株州市 No.42

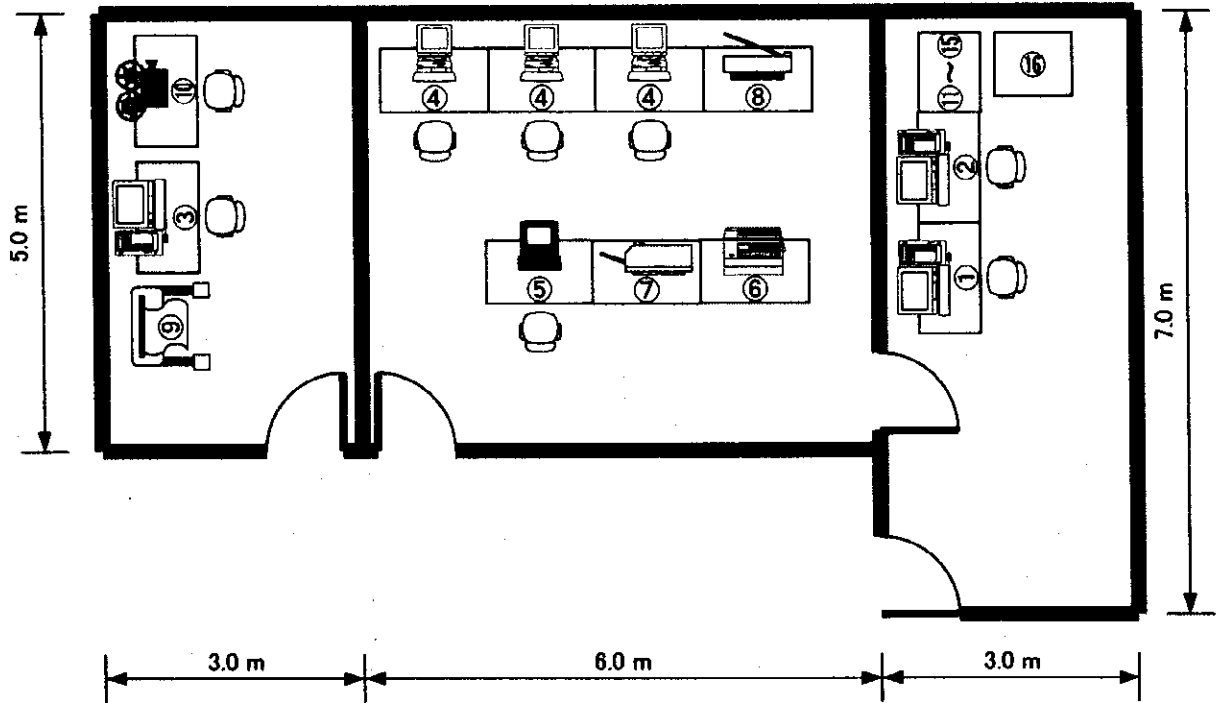

	Equipment	Unit	W (mm)	D (mm)	H (mm)		Equipment	Unit	W (mm)	D (mm)	H (mm)
①	Network Server	1	1200	700		⑨	Plotter	1	2000	800	1300
②	DBMS Server	1	1200	700		⑩	Projector	1	1100	700	
③	GIS Workstation	1	1200	700		⑪	Switch	1	800	600	2000
④	Desktop PC	3	1000	700		⑫	Hub				
⑤	NotePC	1	1000	700		⑬	Router				
⑥	Printer (L B)	1	1000	700		⑭	Modem				
⑦	Printer (L J)	1	1100	700		⑮	VSAT IDU				
⑧	Scanner	1	1000	700		⑯	UPS	1			

コンピュータ室フロアレイアウト

都市番号72 広東省・肇慶市 No.43

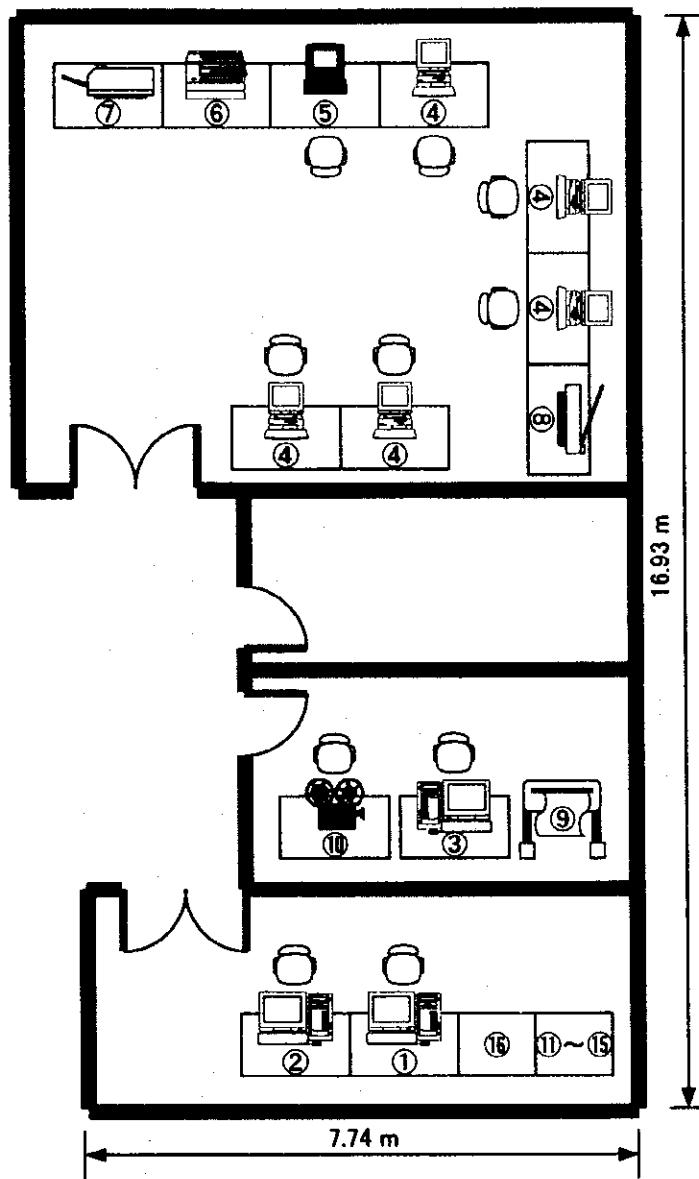

	Equipment	Unit	W (mm)	D (mm)	H (mm)		Equipment	Unit	W (mm)	D (mm)	H (mm)
①	Network Server	1	1200	700		⑨	Plotter	1	2000	800	1300
②	DBMS Server	1	1200	700		⑩	Projector	1	1100	700	
③	GIS Workstation	1	1200	700		⑪	Switch	1	800	600	2000
④	Desktop PC	5	1000	700		⑫	Hub				
⑤	NotePC	1	1000	700		⑬	Router				
⑥	Printer (L B)	1	1000	700		⑭	Modem				
⑦	Printer (L J)	1	1100	700		⑮	VSAT IDU				
⑧	Scanner	1	1000	700		⑯	UPS	1			

コンピュータ室フロアレイアウト

都市番号74 広東省・韶関市 No.44

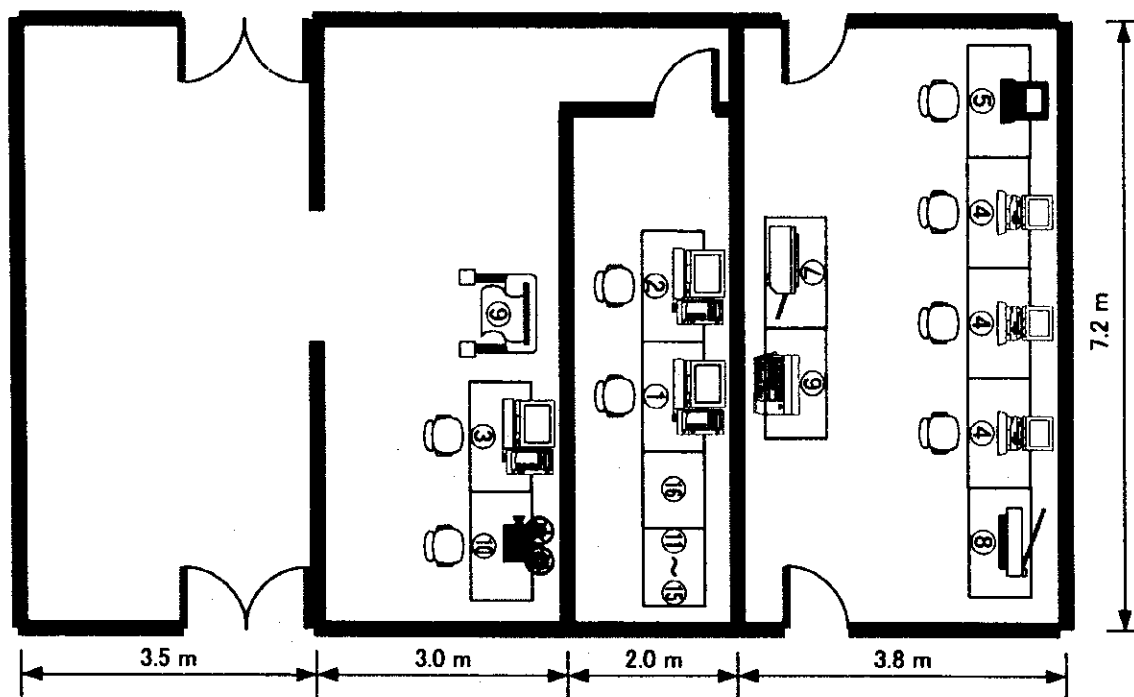

	Equipment	Unit	W (mm)	D (mm)	H (mm)		Equipment	Unit	W (mm)	D (mm)	H (mm)
①	Network Server	1	1200	700		⑨	Plotter	1	2000	800	1300
②	DBMS Server	1	1200	700		⑩	Projector	1	1100	700	
③	GIS Workstation	1	1200	700		⑪	Switch	1	800	600	2000
④	Desktop PC	3	1000	700		⑫	Hub				
⑤	NotePC	1	1000	700		⑬	Router				
⑥	Printer (L B)	1	1000	700		⑭	Modem				
⑦	Printer (I J)	1	1100	700		⑮	VSAT IDU				
⑧	Scanner	1	1000	700		⑯	UPS	1			

コンピュータ室フロアレイアウト

都市番号76 広西自治区・梧州市 No.45

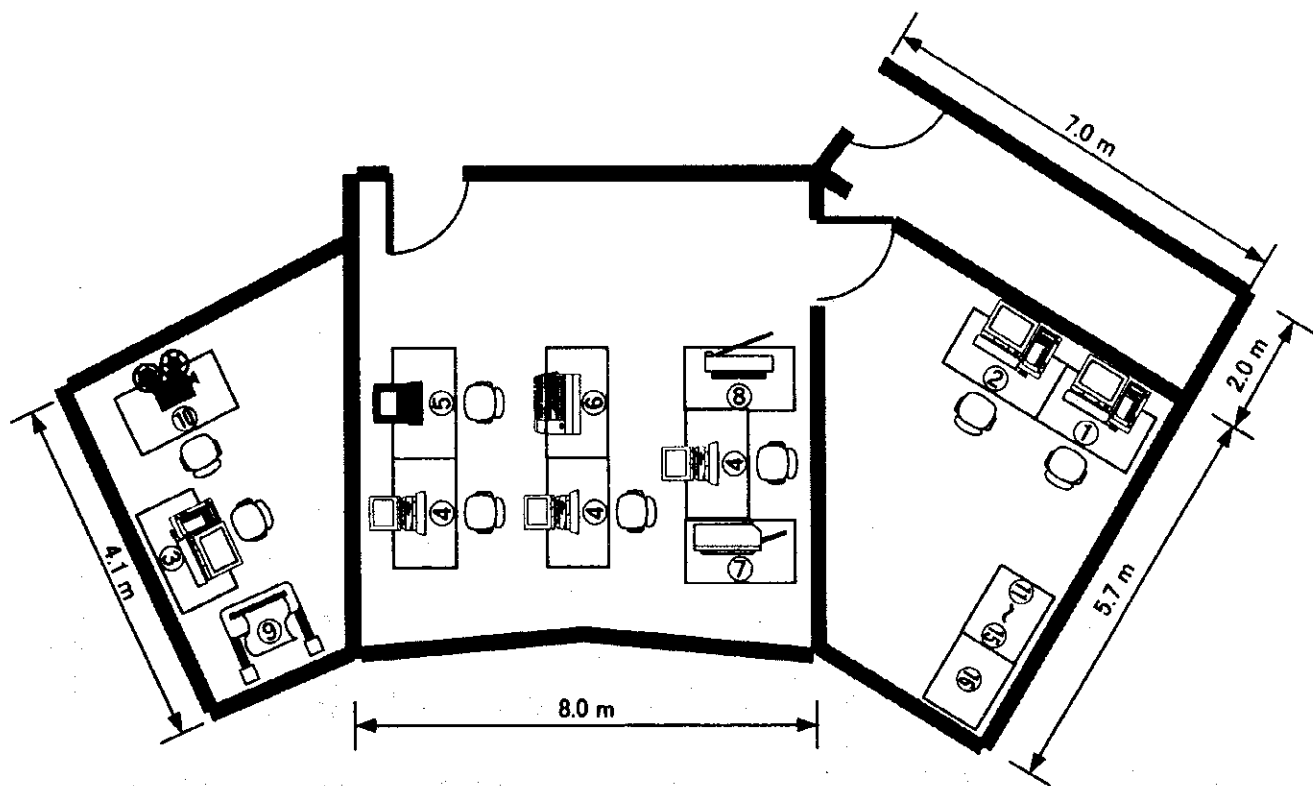

	Equipment	Unit	W (mm)	D (mm)	H (mm)		Equipment	Unit	W (mm)	D (mm)	H (mm)
①	Network Server	1	1200	700		⑨	Plotter	1	2000	800	1300
②	DBMS Server	1	1200	700		⑩	Projector	1	1100	700	
③	GIS Workstation	1	1200	700		⑪	Switch	1	800	600	2000
④	Desktop PC	3	1000	700		⑫	Hub				
⑤	NotePC	1	1000	700		⑬	Router				
⑥	Printer (L. B)	1	1000	700		⑭	Modem				
⑦	Printer (I. J)	1	1100	700		⑮	VSAT IDU				
⑧	Scanner	1	1000	700		⑯	UPS	1			

コンピュータ室フロアレイアウト

都市番号77 広西自治区・柳州市 No.46

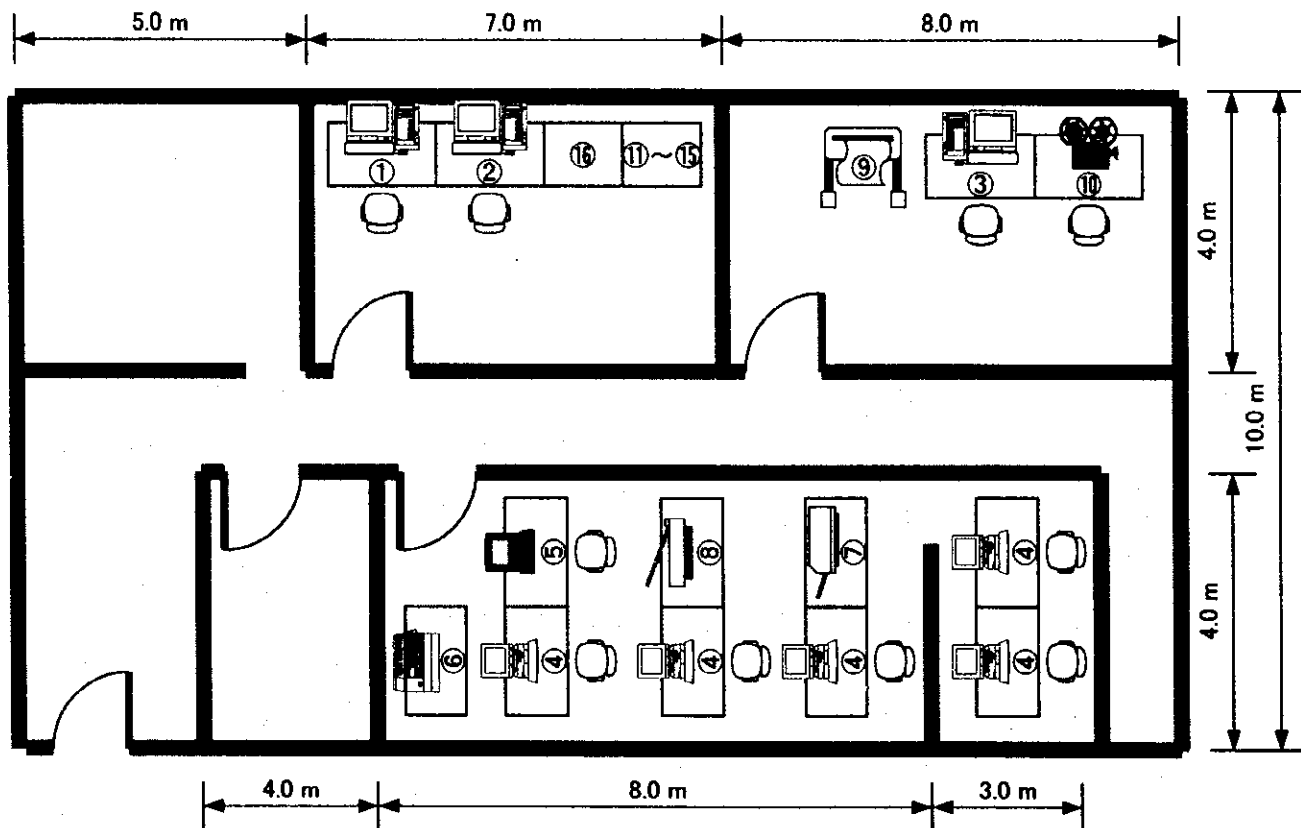

	Equipment	Unit	W (mm)	D (mm)	H (mm)		Equipment	Unit	W (mm)	D (mm)	H (mm)
①	Network Server	1	1200	700		⑨	Plotter	1	2000	800	1300
②	DBMS Server	1	1200	700		⑩	Projector	1	1100	700	
③	GIS Workstation	1	1200	700		⑪	Switch	1	800	600	2000
④	Desktop PC	5	1000	700		⑫	Hub				
⑤	NotePC	1	1000	700		⑬	Router				
⑥	Printer (L B)	1	1000	700		⑭	Modem				
⑦	Printer (L J)	1	1100	700		⑮	VSAT IDU				
⑧	Scanner	1	1000	700		⑯	UPS	1			

コンピュータ室フロアレイアウト

都市番号80 四川省・自贡市 No.47

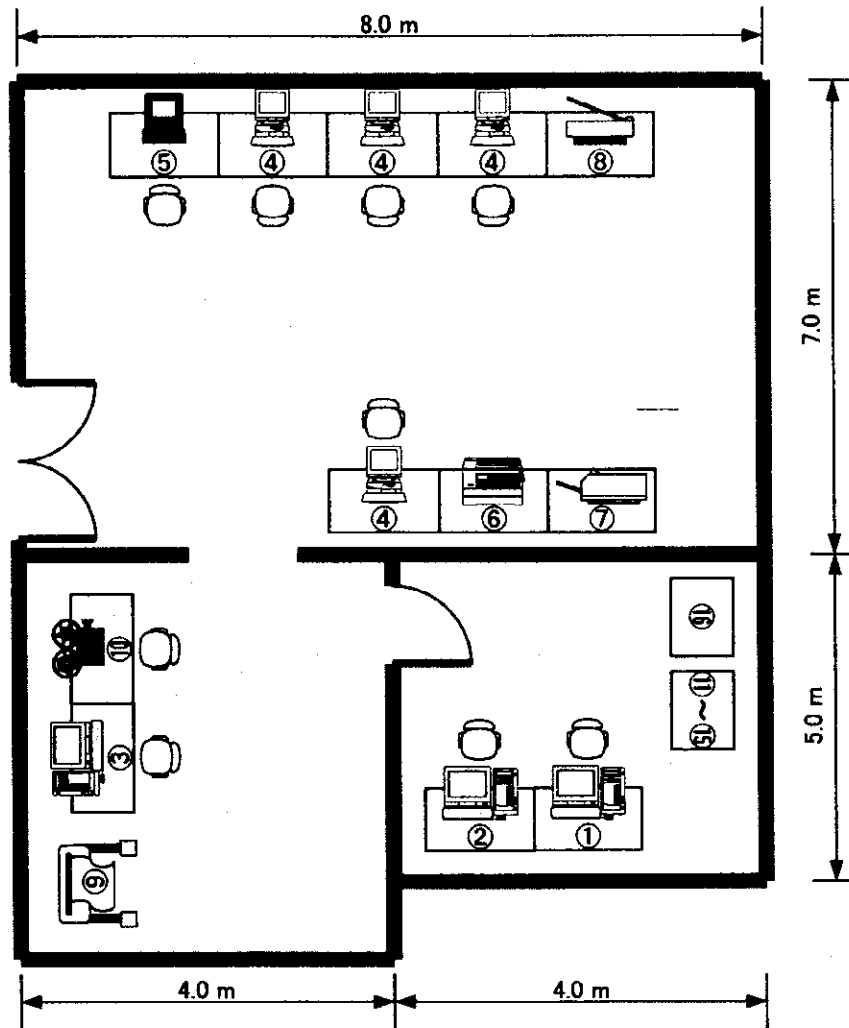

	Equipment	Unit	W (mm)	D (mm)	H (mm)		Equipment	Unit	W (mm)	D (mm)	H (mm)
①	Network Server	1	1200	700		⑨	Plotter	1	2000	800	1300
②	DBMS Server	1	1200	700		⑩	Projector	1	1100	700	
③	GIS Workstation	1	1200	700		⑪	Switch	1	800	600	2000
④	Desktop PC	4	1000	700		⑫	Hub				
⑤	NotePC	1	1000	700		⑬	Router				
⑥	Printer (L. B)	1	1000	700		⑭	Modem				
⑦	Printer (L. J)	1	1100	700		⑮	VSAT IDU				
⑧	Scanner	1	1000	700		⑯	UPS	1			

コンピュータ室フロアレイアウト

都市番号81 四川省・内江市 No.48

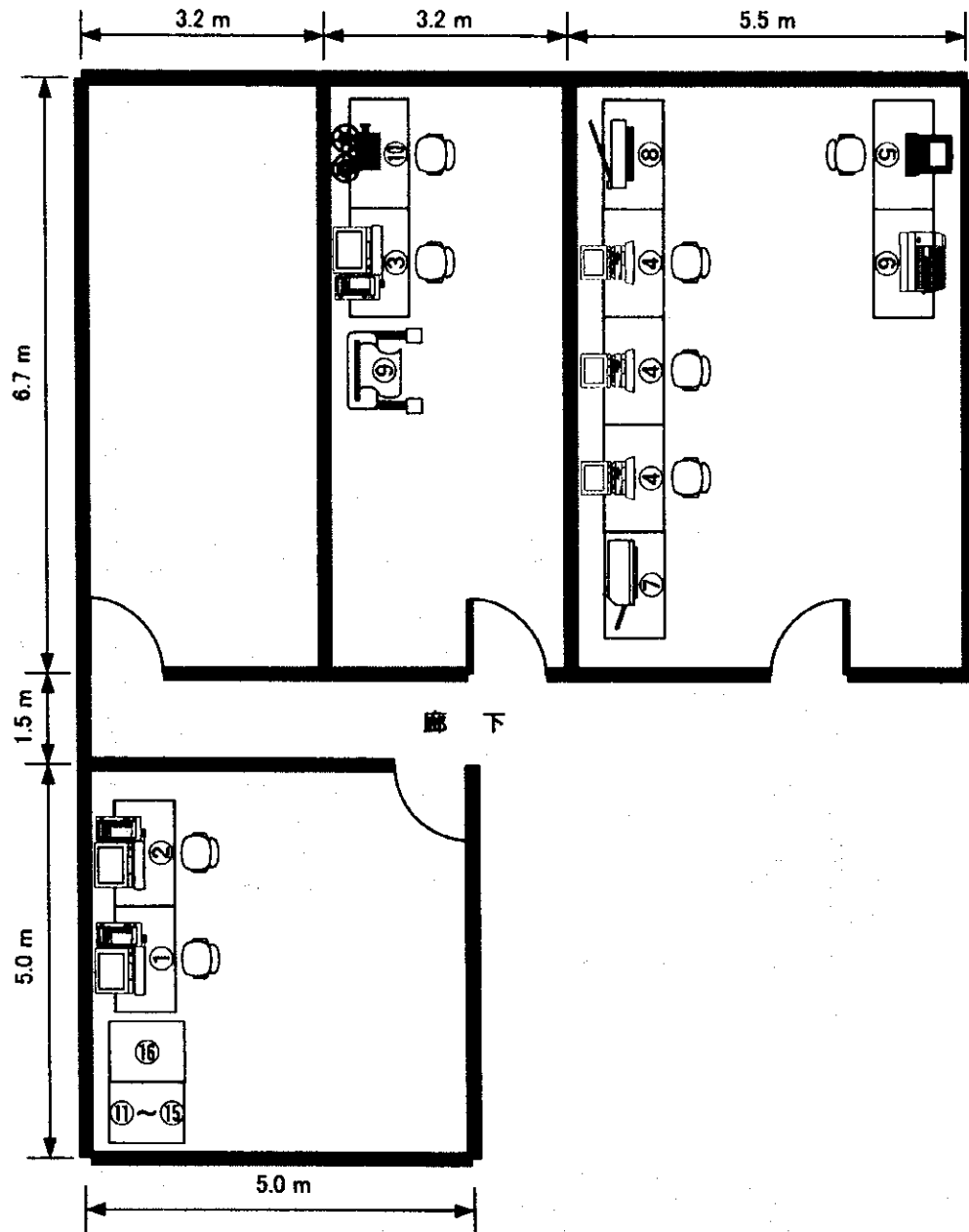

	Equipment	Unit	W (mm)	D (mm)	H (mm)		Equipment	Unit	W (mm)	D (mm)	H (mm)
①	Network Server	1	1200	700		⑨	Plotter	1	2000	800	1300
②	DBMS Server	1	1200	700		⑩	Projector	1	1100	700	
③	GIS Workstation	1	1200	700		⑪	Switch	1	800	600	2000
④	Desktop PC	3	1000	700	⑫	Hub					
⑤	NotePC	1	1000	700	⑬	Router					
⑥	Printer (L B)	1	1000	700	⑭	Modem					
⑦	Printer (L J)	1	1100	700	⑮	VSAT IDU					
⑧	Scanner	1	1000	700	⑯	UPS	1				

コンピュータ室フロアレイアウト

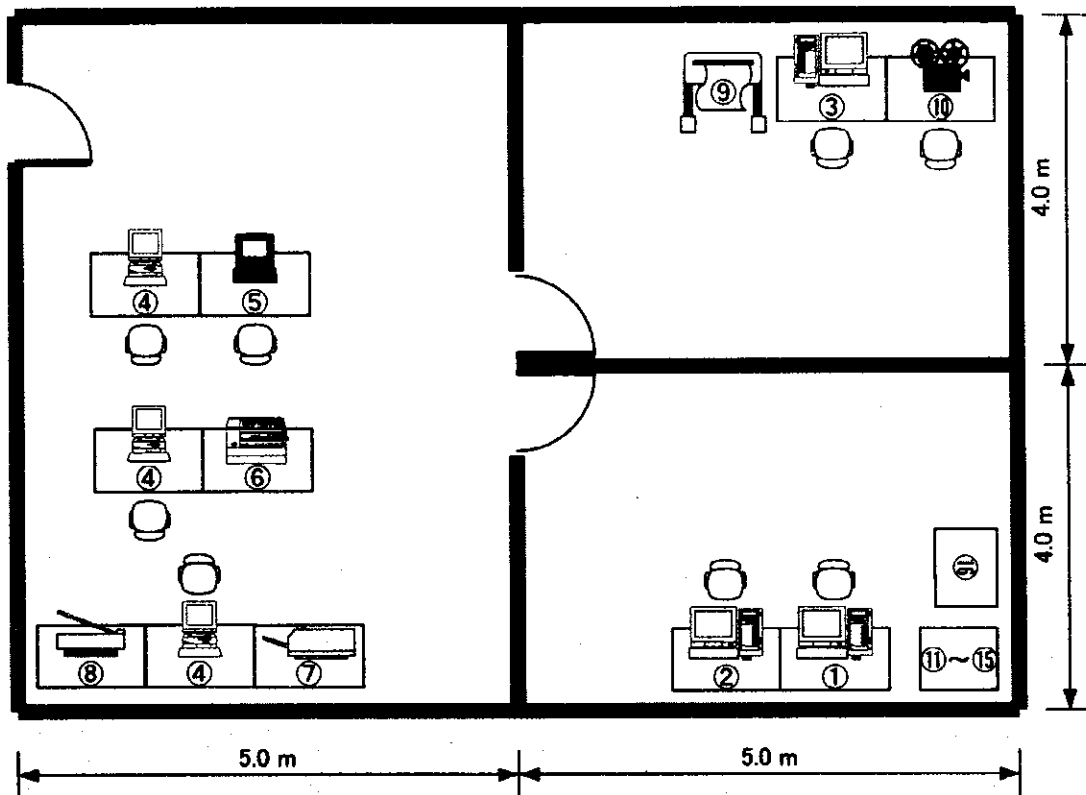

	Equipment	Unit	W (mm)	D (mm)	H (mm)		Equipment	Unit	W (mm)	D (mm)	H (mm)
①	Network Server	1	1200	700		⑨	Plotter	1	2000	800	1300
②	DBMS Server	1	1200	700		⑩	Projector	1	1100	700	
③	GIS Workstation	1	1200	700		⑪	Switch	1	800	600	2000
④	Desktop PC	3	1000	700		⑫	Hub				
⑤	NotePC	1	1000	700		⑬	Router				
⑥	Printer (L B)	1	1000	700		⑭	Modem				
⑦	Printer (L J)	1	1100	700		⑮	VSAT IDU				
⑧	Scanner	1	1000	700		⑯	UPS	1			

コンピュータ室フロアレイアウト

都市番号85 雲南省・箇旧市(紅河州) No.50

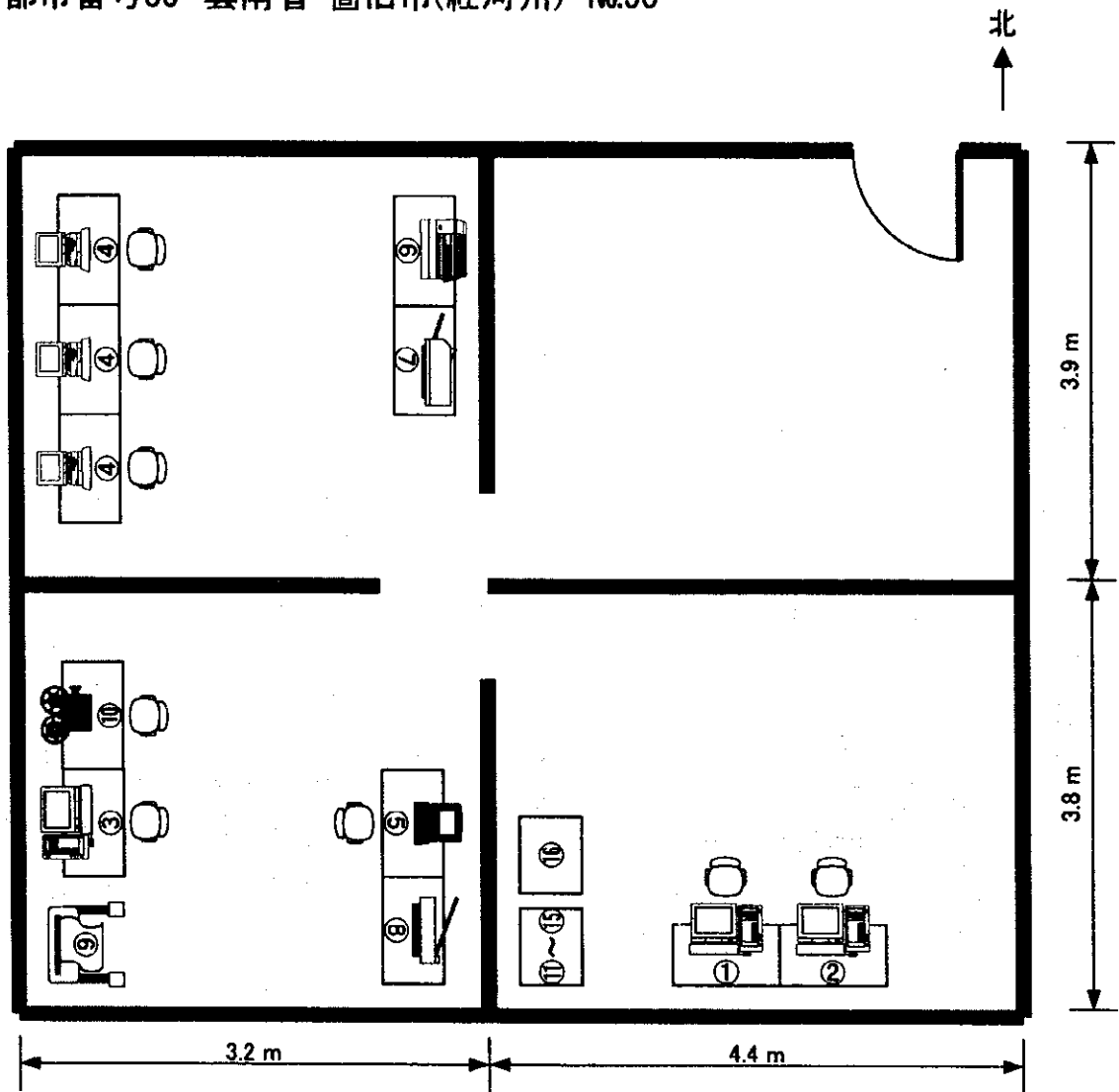

	Equipment	Unit	W (mm)	D (mm)	H (mm)		Equipment	Unit	W (mm)	D (mm)	H (mm)
①	Network Server	1	1200	700		⑨	Plotter	1	2000	800	1300
②	DBMS Server	1	1200	700		⑩	Projector	1	1100	700	
③	GIS Workstation	1	1200	700		⑪	Switch	1	800	600	2000
④	Desktop PC	3	1000	700		⑫	Hub				
⑤	NotePC	1	1000	700		⑬	Router				
⑥	Printer (L. B)	1	1000	700		⑭	Modem				
⑦	Printer (I. J)	1	1100	700		⑮	VSAT IDU				
⑧	Scanner	1	1000	700		⑯	UPS	1			

コンピュータ室フロアレイアウト

都市番号86 雲南省・大理(大理州) No.51

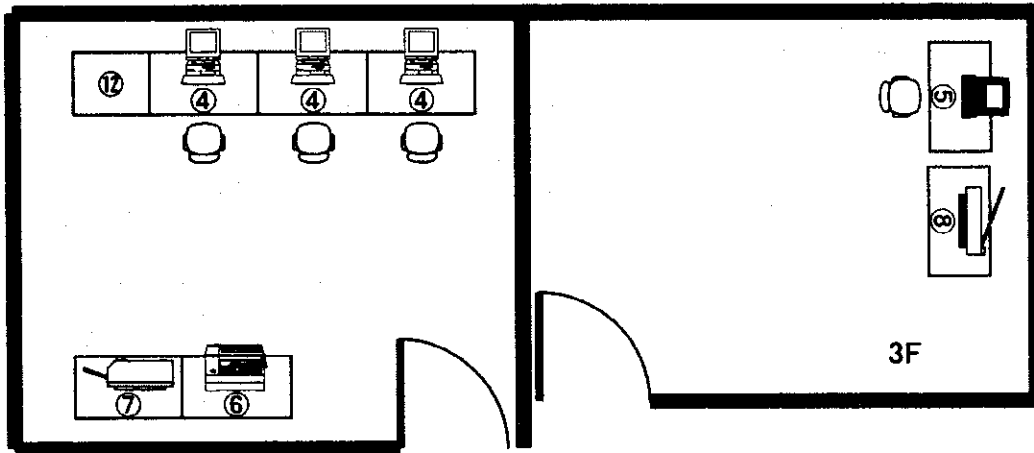
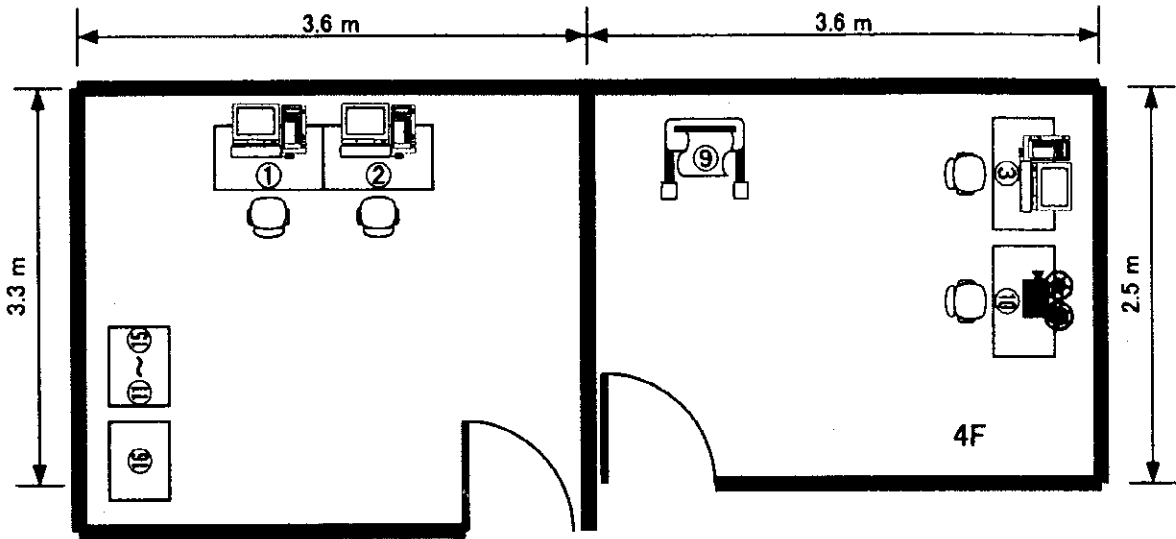

	Equipment	Unit	W (mm)	D (mm)	H (mm)		Equipment	Unit	W (mm)	D (mm)	H (mm)
①	Network Server	1	1200	700		⑨	Plotter	1	2000	800	1300
②	DBMS Server	1	1200	700		⑩	Projector	1	1100	700	
③	GIS Workstation	1	1200	700		⑪	Switch	1	800	600	2000
④	Desktop PC	3	1000	700		⑫	Hub				
⑤	NotePC	1	1000	700		⑬	Router				
⑥	Printer (L B)	1	1000	700		⑭	Modem				
⑦	Printer (L J)	1	1100	700		⑮	VSAT IDU	1			
⑧	Scanner	1	1000	700		⑯	UPS				

コンピュータ室フロアレイアウト

都市番号87 西藏自治区・拉萨市 No.52

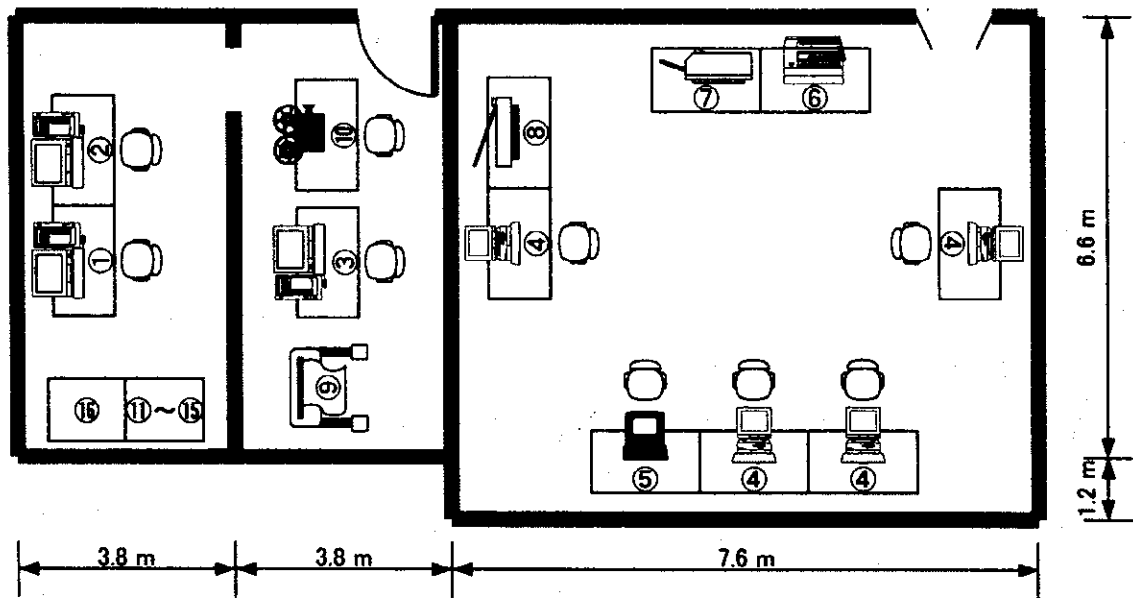

	Equipment	Unit	W (mm)	D (mm)	H (mm)		Equipment	Unit	W (mm)	D (mm)	H (mm)
①	Network Server	1	1200	700		⑨	Plotter	1	2000	800	1300
②	DBMS Server	1	1200	700		⑩	Projector	1	1100	700	
③	GIS Workstation	1	1200	700		⑪	Switch	1	800	600	2000
④	Desktop PC	4	1000	700		⑫	Hub				
⑤	NotePC	1	1000	700		⑬	Router				
⑥	Printer (L. B)	1	1000	700		⑭	Modem				
⑦	Printer (L. J)	1	1100	700		⑮	VSAT IDU				
⑧	Scanner	1	1000	700		⑯	UPS	1			

コンピュータ室フロアレイアウト

都市番号89 陕西省·宝鸡市 No.53

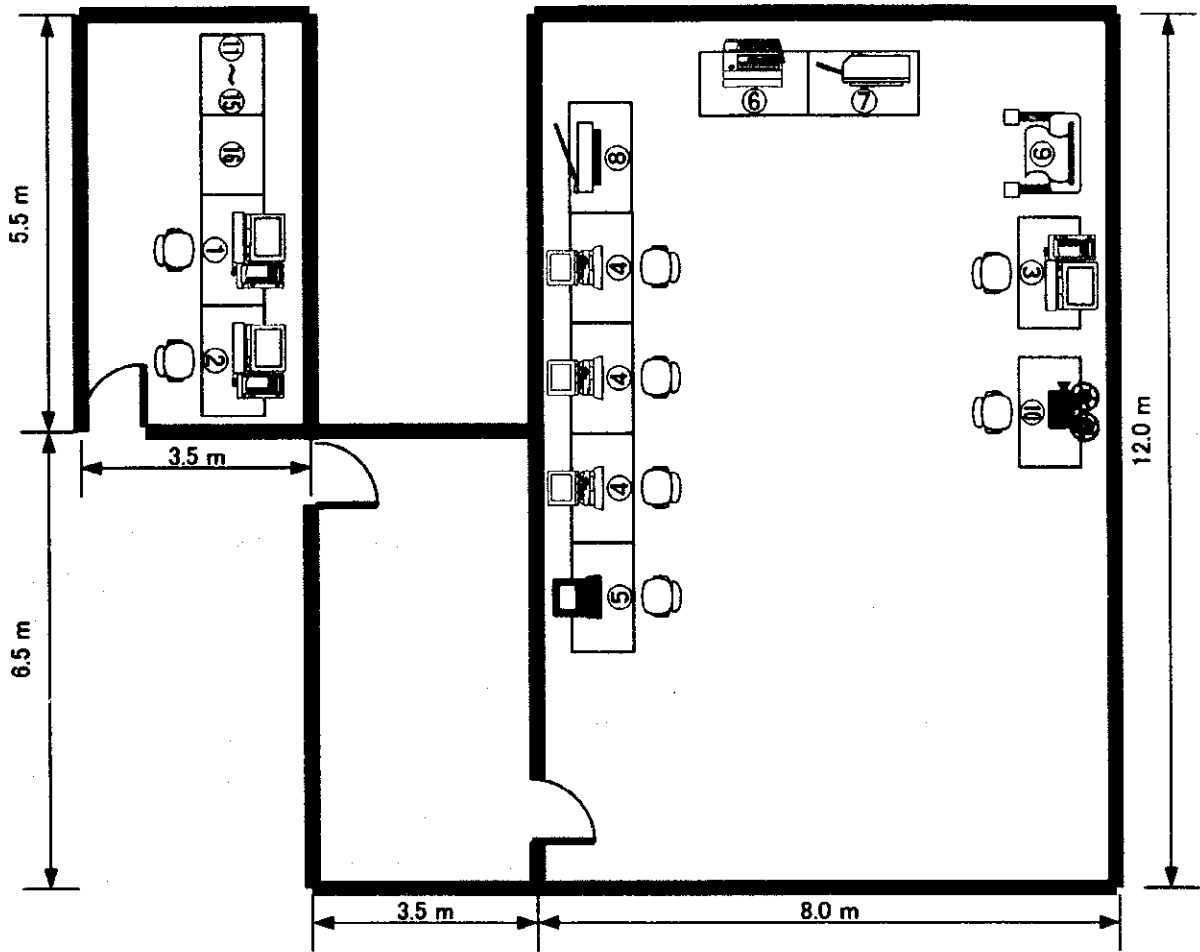

	Equipment	Unit	W (mm)	D (mm)	H (mm)		Equipment	Unit	W (mm)	D (mm)	H (mm)
①	Network Server	1	1200	700		⑨	Plotter	1	2000	800	1300
②	DBMS Server	1	1200	700		⑩	Projector	1	1100	700	
③	GIS Workstation	1	1200	700		⑪	Switch	1	800	600	2000
④	Desktop PC	3	1000	700		⑫	Hub				
⑤	NotePC	1	1000	700		⑬	Router				
⑥	Printer (L B)	1	1000	700		⑭	Modem				
⑦	Printer (L J)	1	1100	700		⑮	VSAT IDU				
⑧	Scanner	1	1000	700		⑯	UPS	1			

コンピュータ室フロアレイアウト

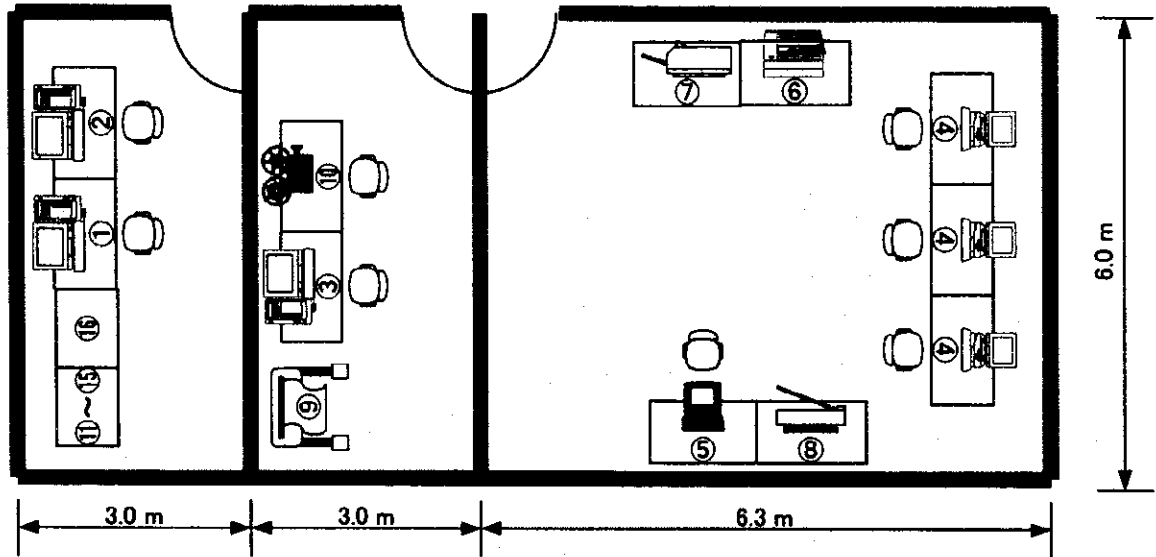

	Equipment	Unit	W (mm)	D (mm)	H (mm)		Equipment	Unit	W (mm)	D (mm)	H (mm)
①	Network Server	1	1200	700		⑨	Plotter	1	2000	800	1300
②	DBMS Server	1	1200	700		⑩	Projector	1	1100	700	
③	GIS Workstation	1	1200	700		⑪	Switch	1	800	600	2000
④	Desktop PC	3	1000	700		⑫	Hub				
⑤	NotePC	1	1000	700		⑬	Router				
⑥	Printer (L B)	1	1000	700		⑭	Modem				
⑦	Printer (L J)	1	1100	700		⑮	VSAT IDU				
⑧	Scanner	1	1000	700		⑯	UPS				

コンピュータ室フロアレイアウト

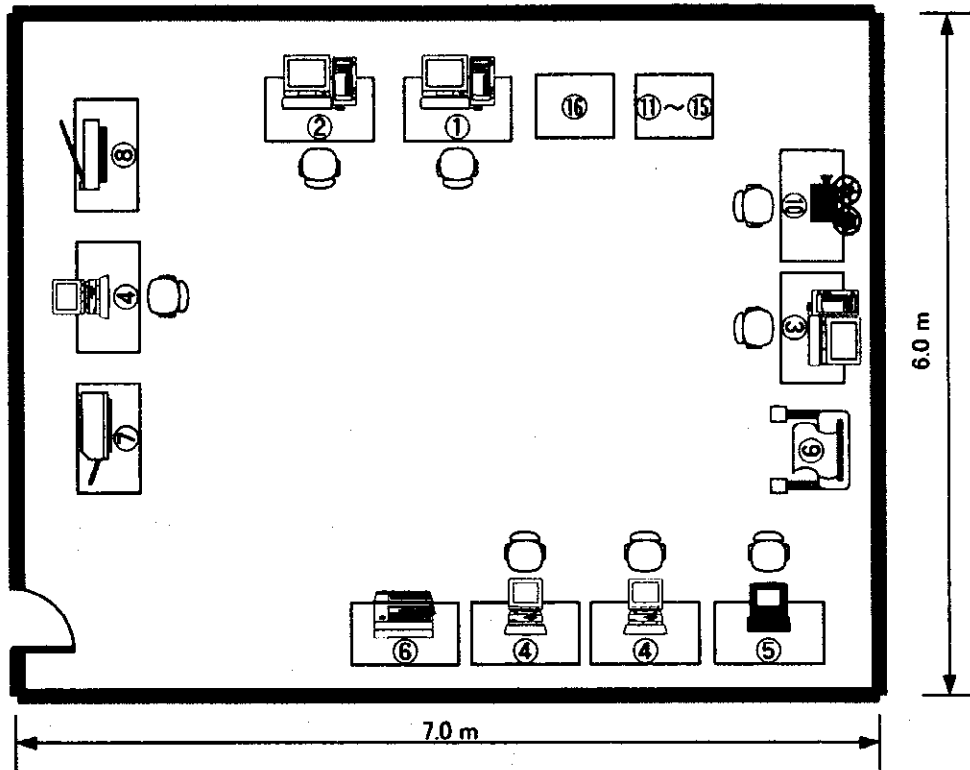

	Equipment	Unit	W (mm)	D (mm)	H (mm)		Equipment	Unit	W (mm)	D (mm)	H (mm)
①	Network Server	1	1200	700		⑨	Plotter	1	2000	800	1300
②	DBMS Server	1	1200	700		⑩	Projector	1	1100	700	
③	GIS Workstation	1	1200	700		⑪	Switch	1	800	600	2000
④	Desktop PC	3	1000	700		⑫	Hub				
⑤	NotePC	1	1000	700		⑬	Router				
⑥	Printer (L. B)	1	1000	700		⑭	Modem				
⑦	Printer (L. J)	1	1100	700		⑮	VSAT IDU				
⑧	Scanner	1	1000	700		⑯	UPS	1			

コンピュータ室フロアレイアウト

都市番号93 甘肃省・天水市 No.56

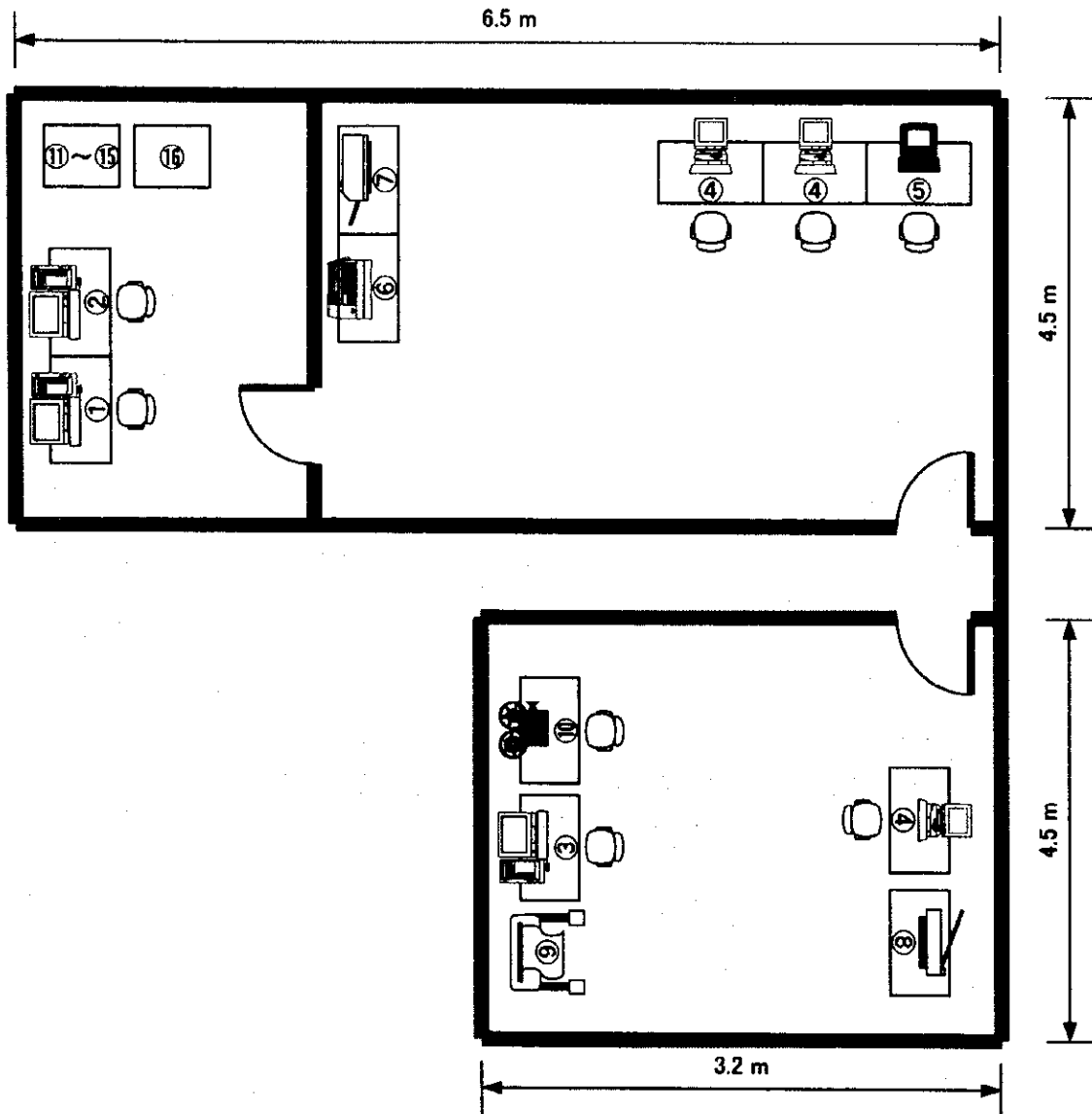

	Equipment	Unit	W (mm)	D (mm)	H (mm)		Equipment	Unit	W (mm)	D (mm)	H (mm)
①	Network Server	1	1200	700		⑨	Plotter	1	2000	800	1300
②	DBMS Server	1	1200	700		⑩	Projector	1	1100	700	
③	GIS Workstation	1	1200	700		⑪	Switch	1	800	600	2000
④	Desktop PC	3	1000	700	⑫	Hub					
⑤	NotePC	1	1000	700	⑬	Router					
⑥	Printer (L B)	1	1000	700	⑭	Modem					
⑦	Printer (L J)	1	1100	700	⑮	VSAT IDU					
⑧	Scanner	1	1000	700	⑯	UPS	1				

コンピュータ室フロアレイアウト

都市番号94 甘肅省・嘉峪関市 No.57

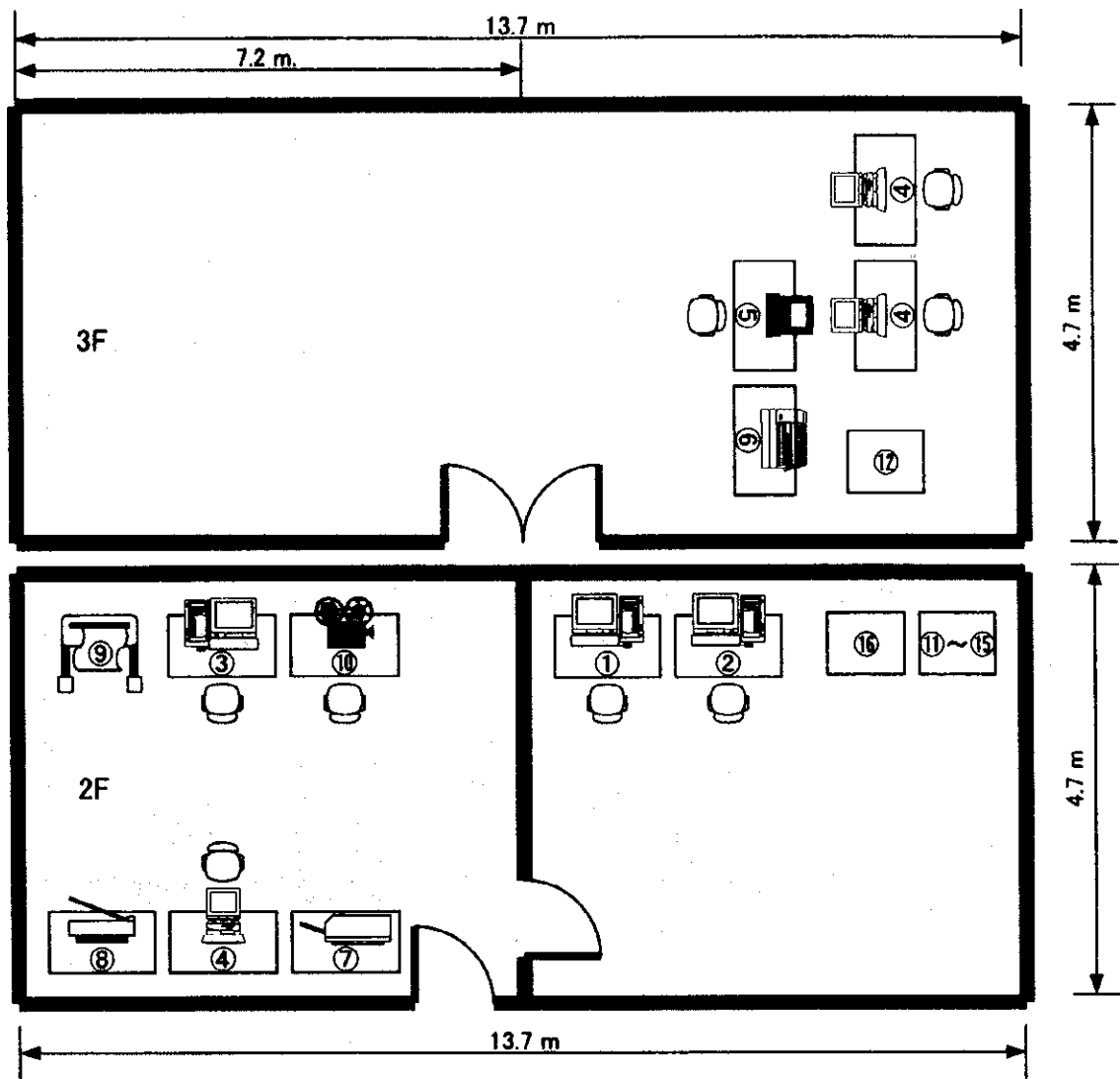

	Equipment	Unit	W (mm)	D (mm)	H (mm)		Equipment	Unit	W (mm)	D (mm)	H (mm)
①	Network Server	1	1200	700		⑨	Plotter	1	2000	800	1300
②	DBMS Server	1	1200	700		⑩	Projector	1	1100	700	
③	GIS Workstation	1	1200	700		⑪	Switch	1	800	600	2000
④	Desktop PC	3	1000	700	⑫	Hub					
⑤	NotePC	1	1000	700	⑬	Router					
⑥	Printer (L B)	1	1000	700	⑭	Modem					
⑦	Printer (L J)	1	1100	700	⑮	VSAT IDU					
⑧	Scanner	1	1000	700	⑯	UPS	1				

コンピュータ室フロアレイアウト

都市番号96 青海省・格尔木市 No.58

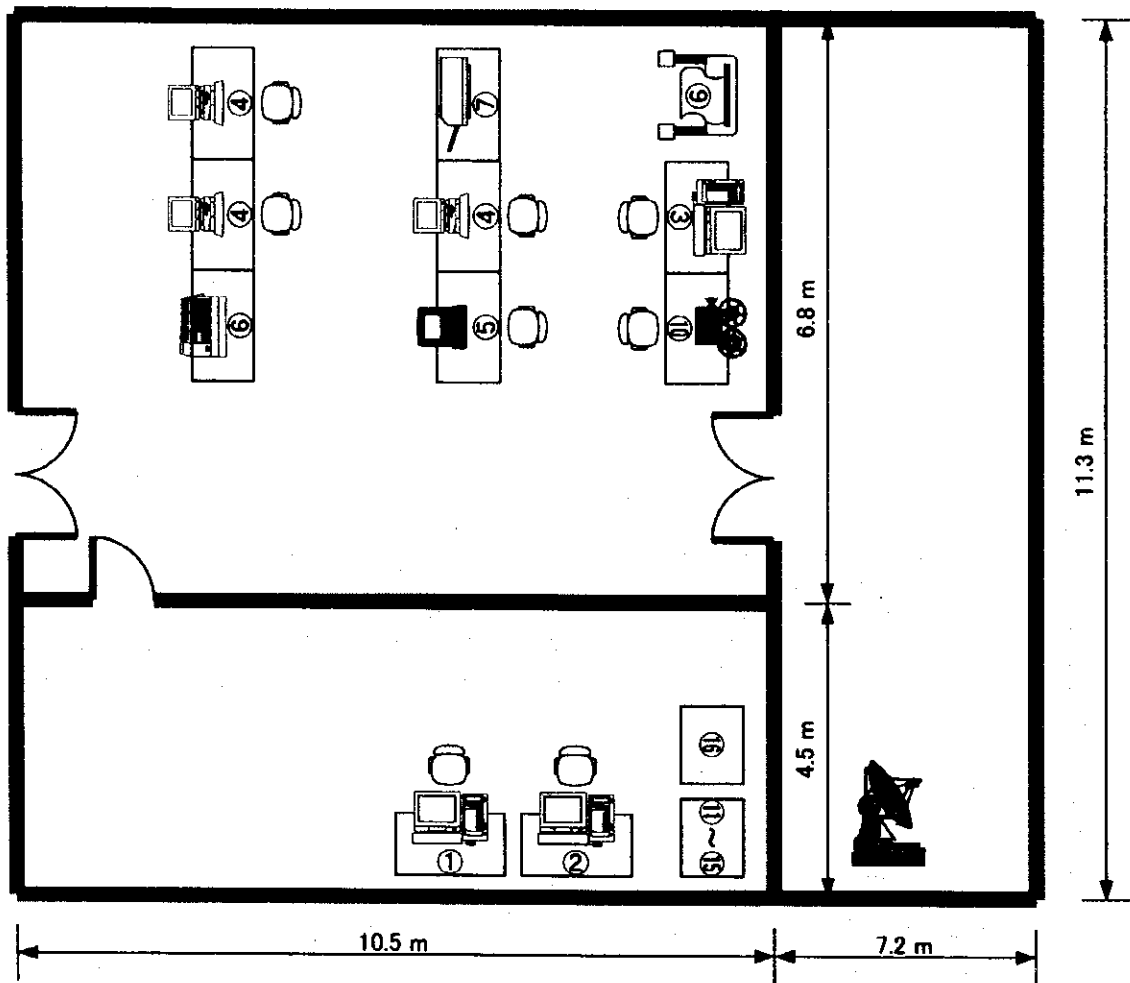

	Equipment	Unit	W (mm)	D (mm)	H (mm)		Equipment	Unit	W (mm)	D (mm)	H (mm)
①	Network Server	1	1200	700		⑨	Plotter	1	2000	800	1300
②	DBMS Server	1	1200	700		⑩	Projector	1	1100	700	
③	GIS Workstation	1	1200	700		⑪	Switch	1	800	600	2000
④	Desktop PC	3	1000	700		⑫	Hub				
⑤	NotePC	1	1000	700		⑬	Router				
⑥	Printer (L B)	1	1000	700		⑭	Modem				
⑦	Printer (I J)	1	1100	700		⑮	VSAT IDU				
⑧	Scanner	1	1000	700		⑯	UPS	1			

コンピュータ室フロアレイアウト

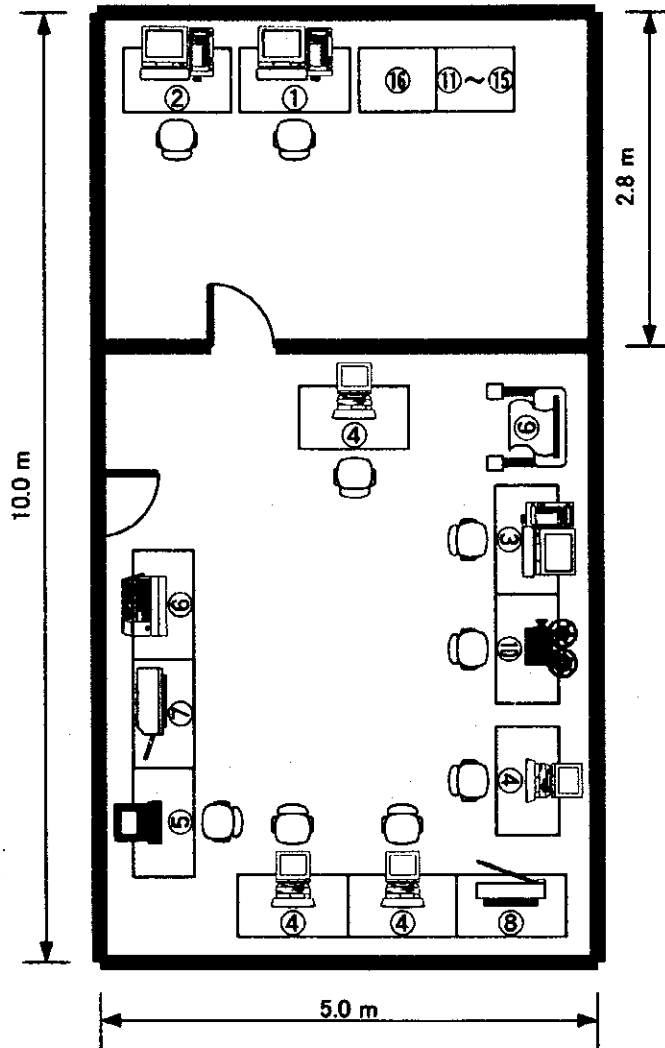

	Equipment	Unit	W (mm)	D (mm)	H (mm)		Equipment	Unit	W (mm)	D (mm)	H (mm)
①	Network Server	1	1200	700		⑨	Plotter	1	2000	800	1300
②	DBMS Server	1	1200	700		⑩	Projector	1	1100	700	
③	GIS Workstation	1	1200	700		⑪	Switch	1	800	600	2000
④	Desktop PC	4	1000	700		⑫	Hub				
⑤	NotePC	1	1000	700		⑬	Router				
⑥	Printer (L. B)	1	1000	700		⑭	Modem				
⑦	Printer (I. J)	1	1100	700		⑮	VSAT IDU				
⑧	Scanner	1	1000	700		⑯	UPS	1			

コンピュータ室フロアレイアウト

都市番号99 新疆自治区・伊寧市(伊犁州) No.60

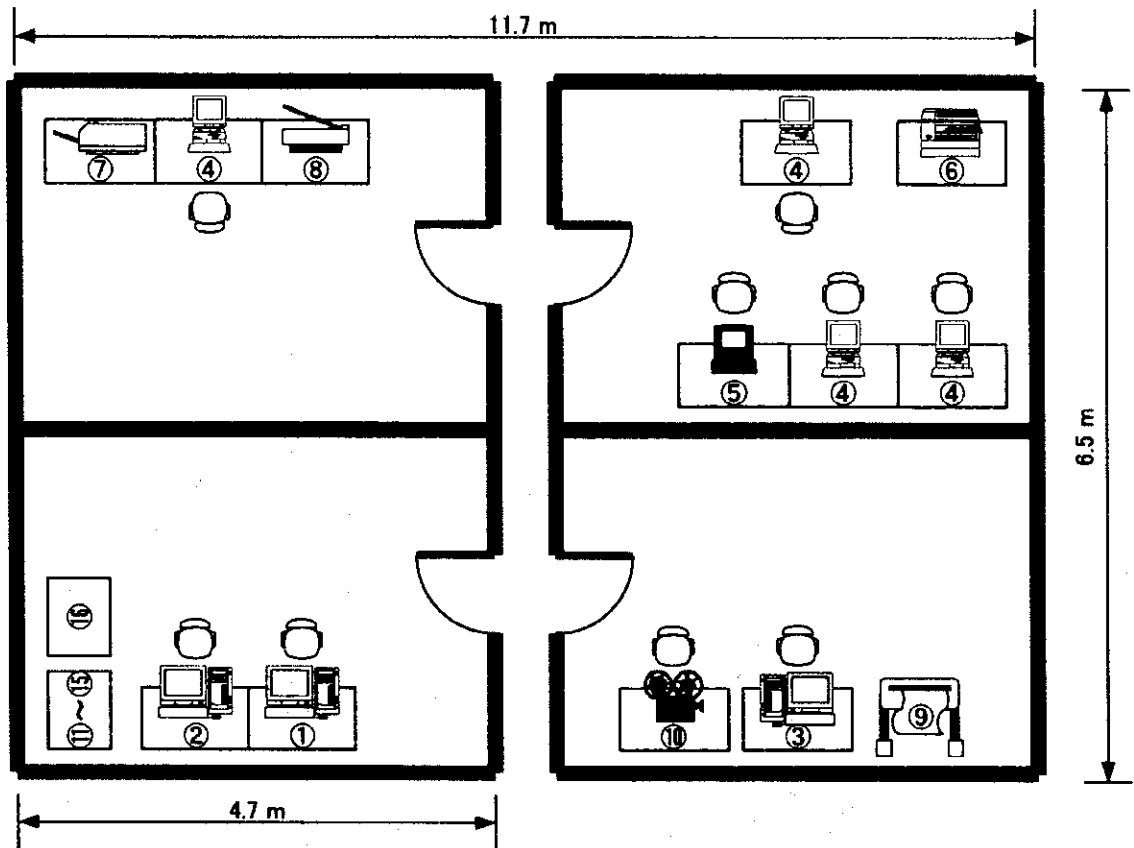

	Equipment	Unit	W (mm)	D (mm)	H (mm)		Equipment	Unit	W (mm)	D (mm)	H (mm)
①	Network Server	1	1200	700		⑨	Plotter	1	2000	800	1300
②	DBMS Server	1	1200	700		⑩	Projector	1	1100	700	
③	GIS Workstation	1	1200	700		⑪	Switch	1	800	600	2000
④	Desktop PC	4	1000	700		⑫	Hub				
⑤	NotePC	1	1000	700		⑬	Router				
⑥	Printer (L. B)	1	1000	700		⑭	Modem				
⑦	Printer (I. J)	1	1100	700		⑮	VSAT IDU	1			
⑧	Scanner	1	1000	700		⑯	UPS				

コンピュータ室フロアレイアウト

都市番号100 新疆自治区・石河子市 No.61

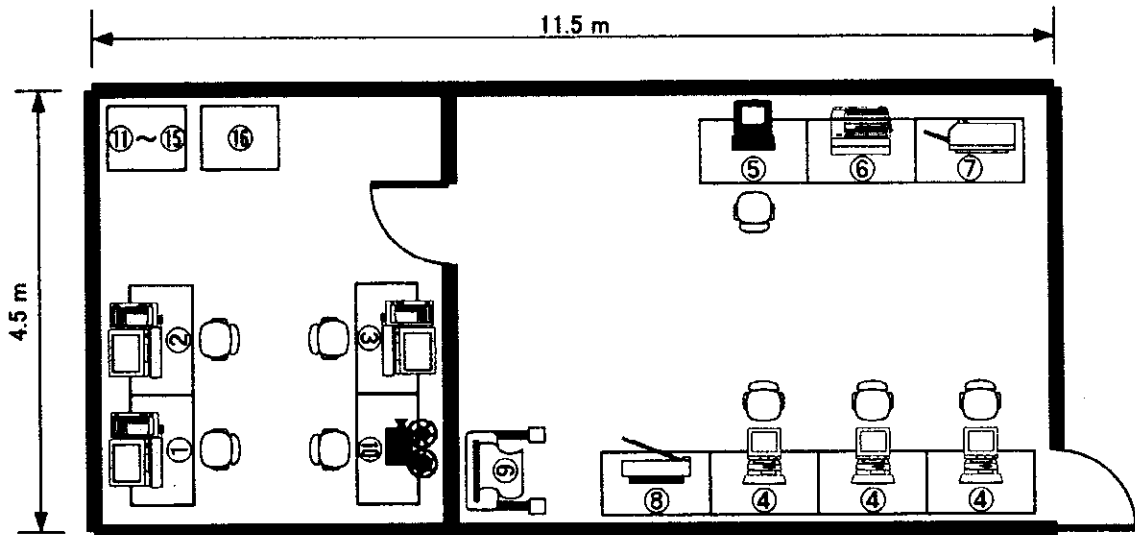

	Equipment	Unit	W (mm)	D (mm)	H (mm)		Equipment	Unit	W (mm)	D (mm)	H (mm)
①	Network Server	1	1200	700		⑨	Plotter	1	2000	800	1300
②	DBMS Server	1	1200	700		⑩	Projector	1	1100	700	
③	GIS Workstation	1	1200	700		⑪	Switch	1	800	600	2000
④	Desktop PC	3	1000	700		⑫	Hub				
⑤	NotePC	1	1000	700		⑬	Router				
⑥	Printer (L B)	1	1000	700		⑭	Modem				
⑦	Printer (L J)	1	1100	700		⑮	VSAT IDU				
⑧	Scanner	1	1000	700		⑯	UPS	1			

コンピュータ室フロアレイアウト

資料10. 都市環境情報センターの通信機器配置図

都市番号2 河北省・石家庄市（第一次No.2）

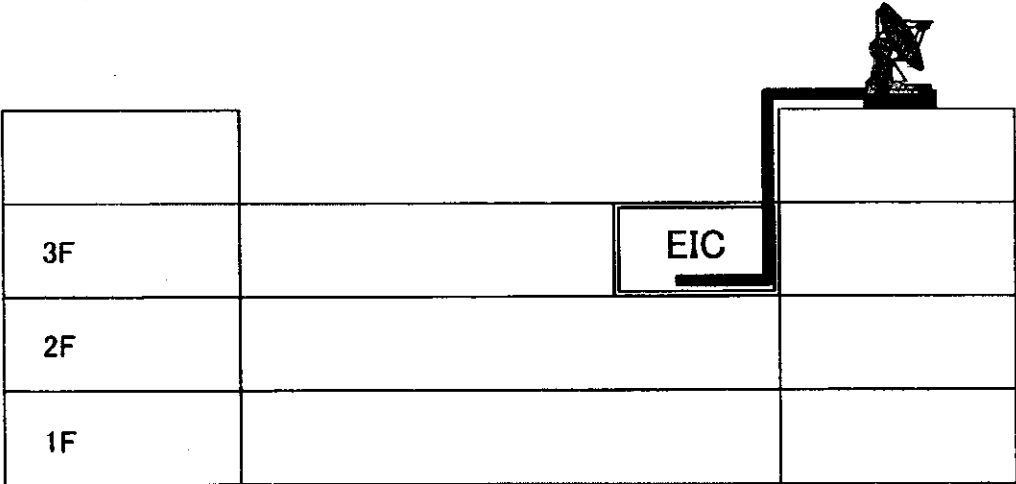

概算ケーブル長：80m

衛星通信用アンテナ配置図

都市番号3 河北省・唐山市 No.1

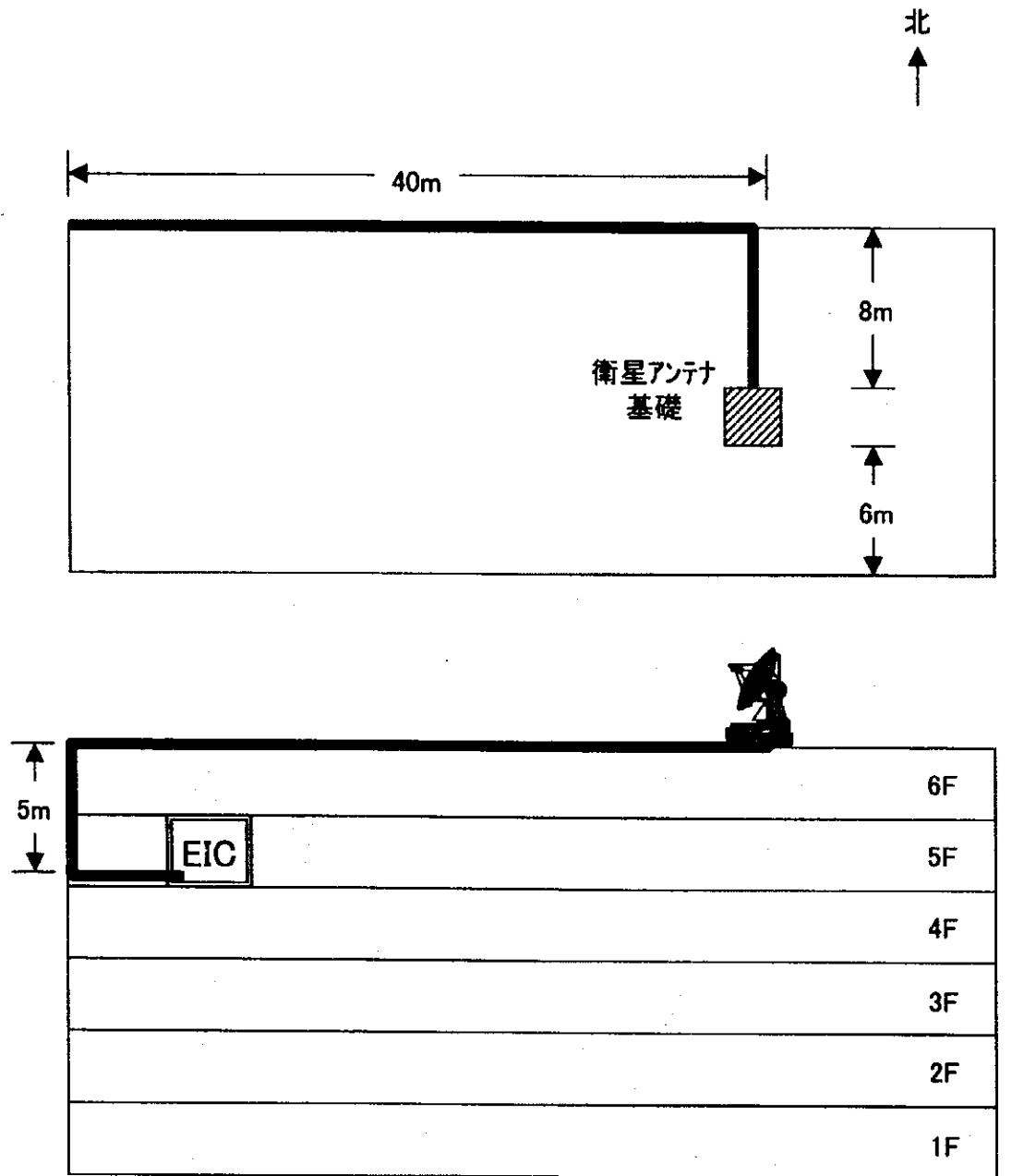

概算ケーブル長: 80m

衛星通信用アンテナ配置図

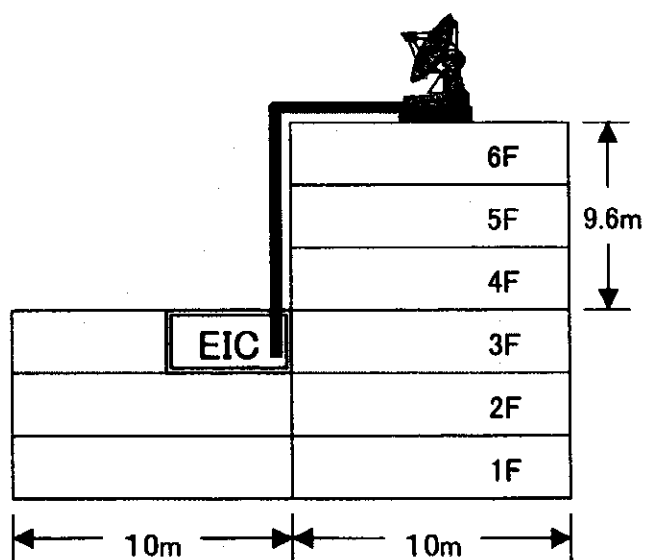
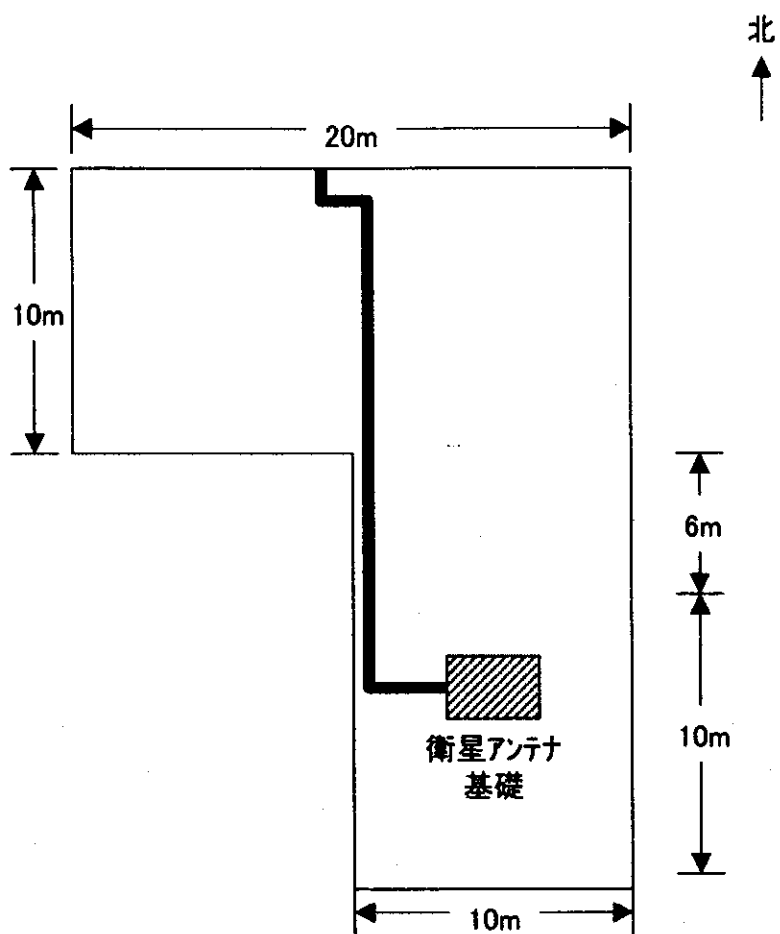

概算ケーブル長：80m

衛星通信用アンテナ配置図

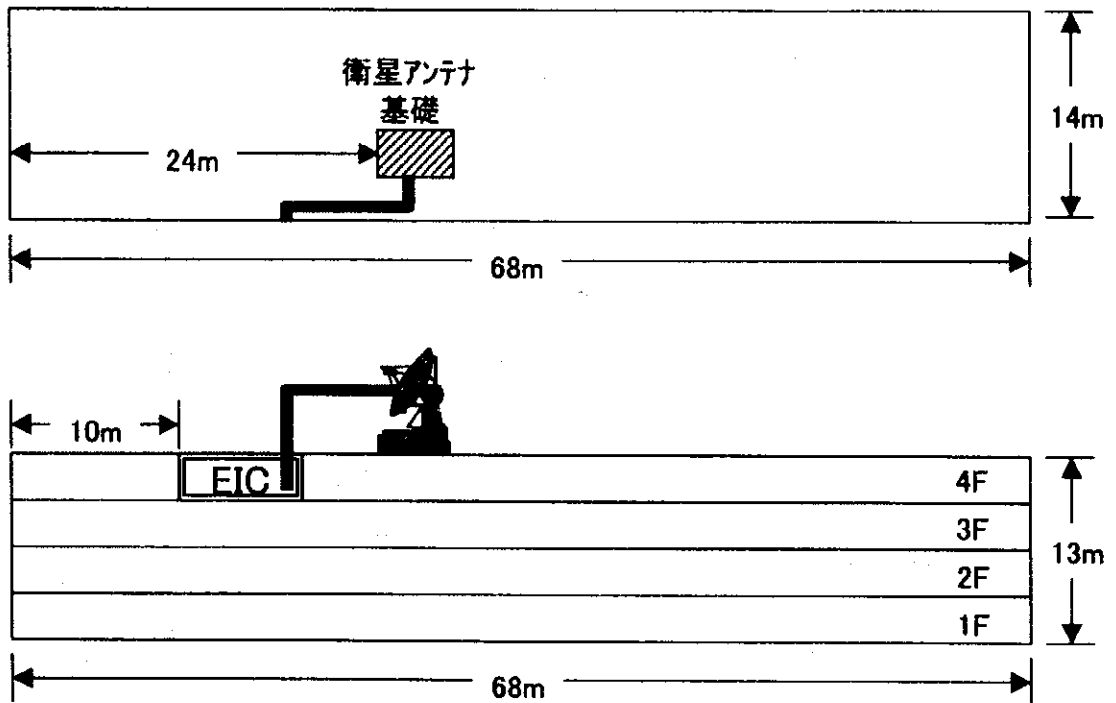

概算ケーブル長：80m

衛星通信用アンテナ配置図

都市番号7 河北省・張家口市 No.4

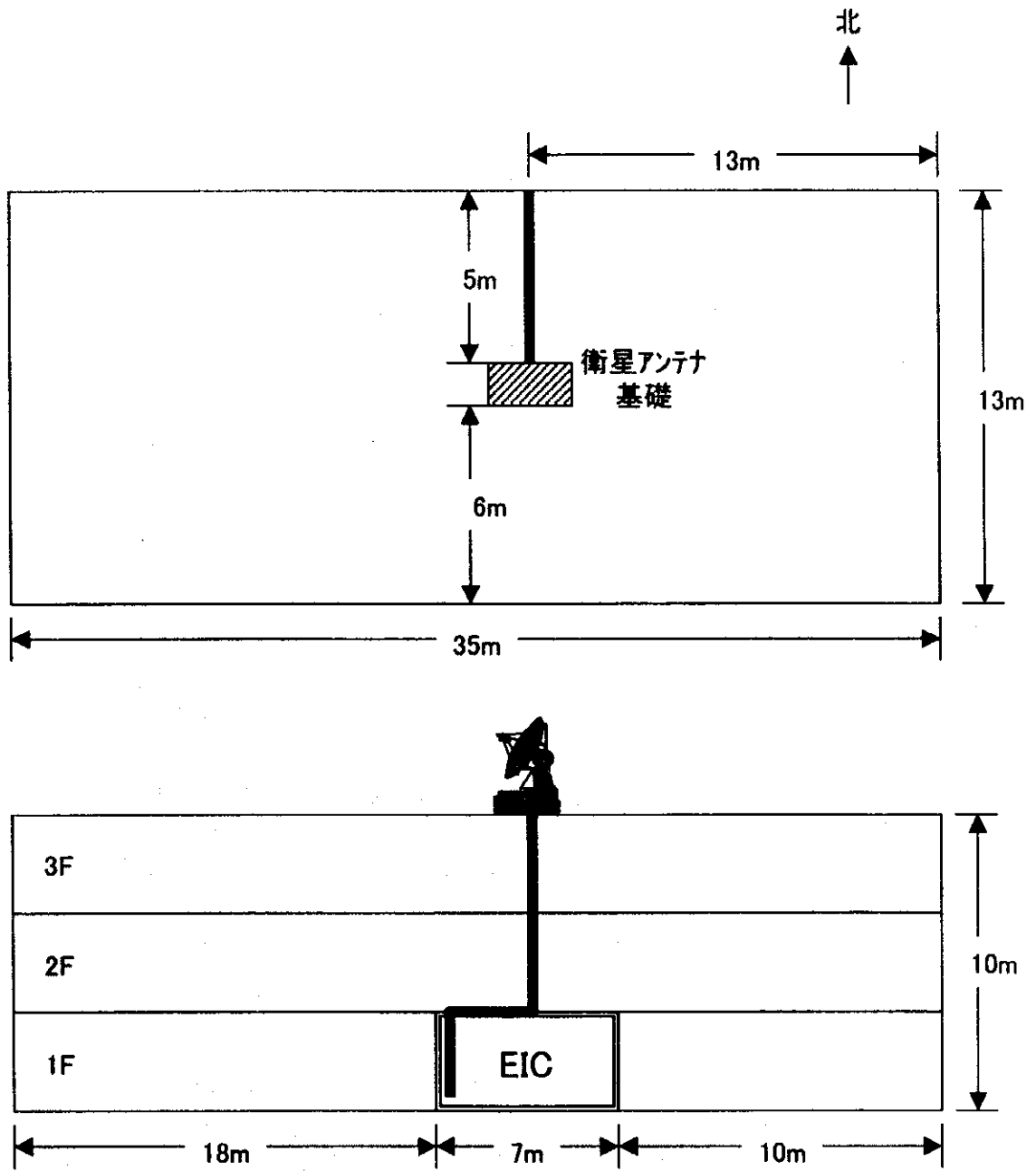

概算ケーブル長: 80m

衛星通信用アンテナ配置図

都市番号8 山西省・太原市（第一次No.4）

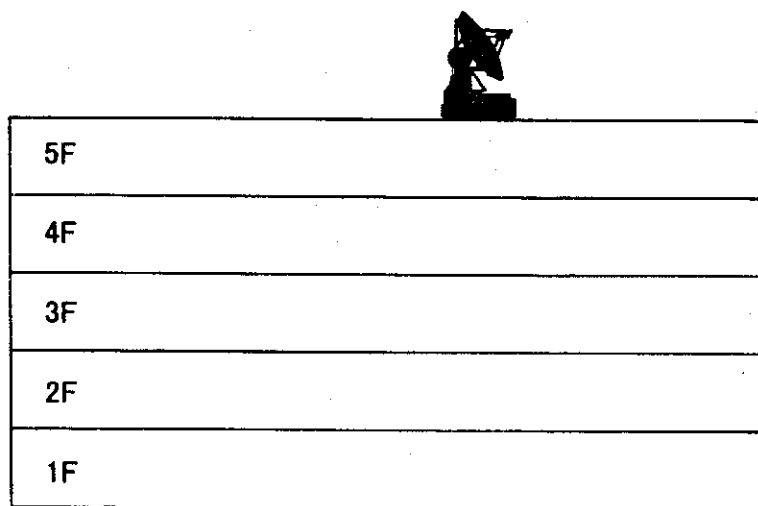
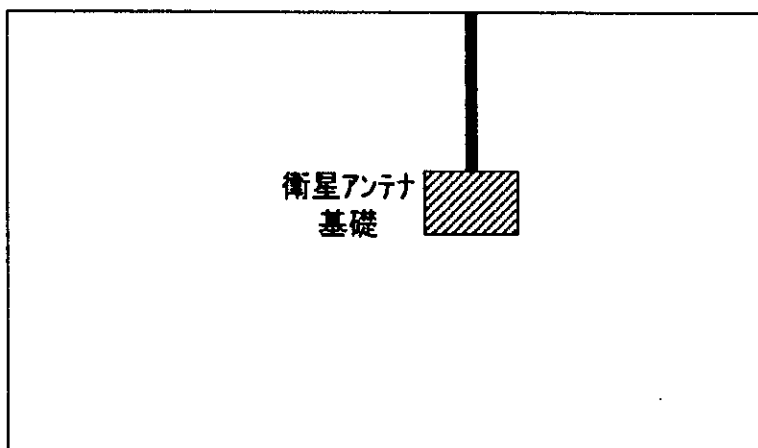

概算ケーブル長：80m

衛星通信用アンテナ配置図

都市番号9 山西省・大同市 No.5

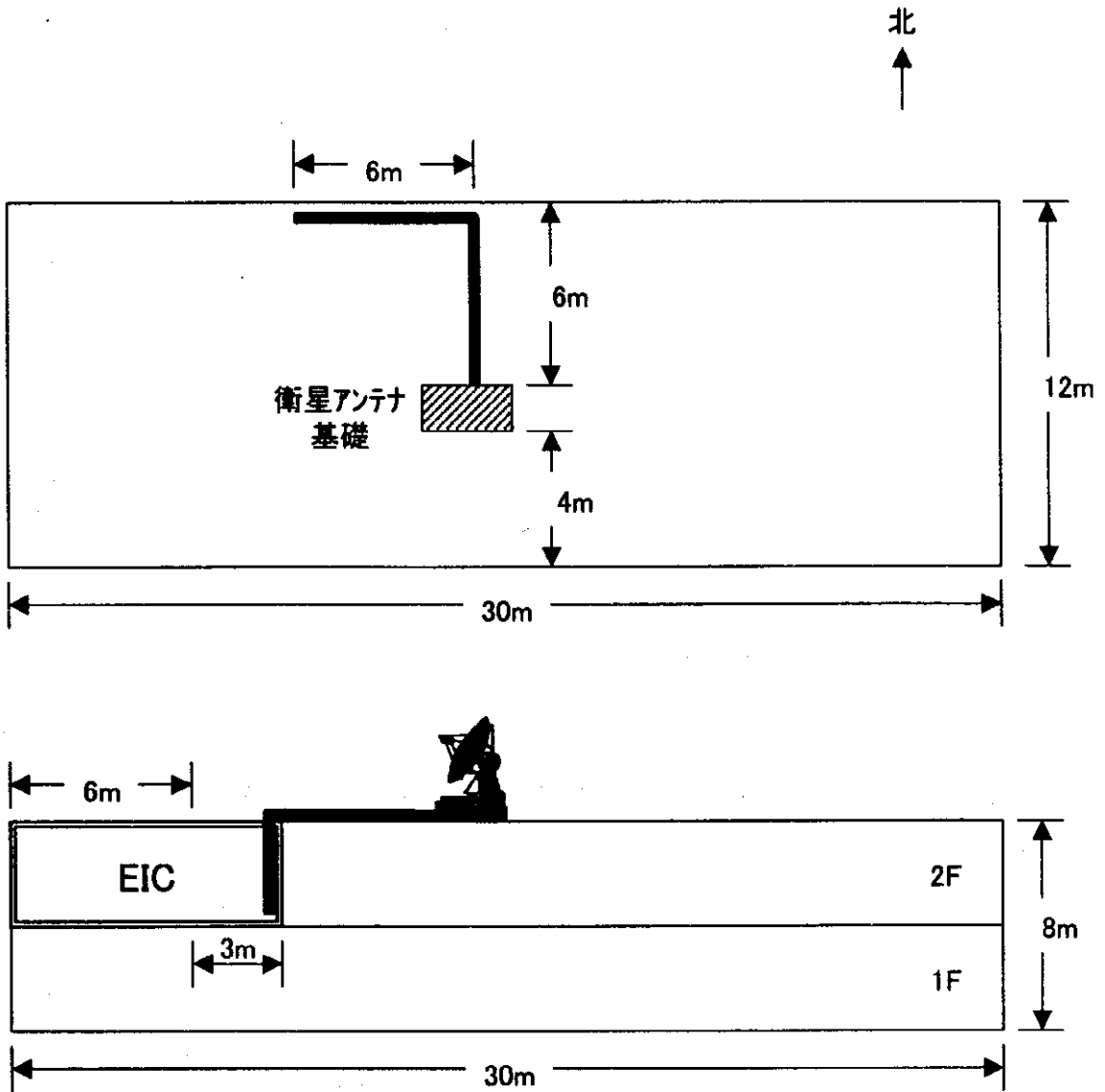

概算ケーブル長: 80m

衛星通信用アンテナ配置図

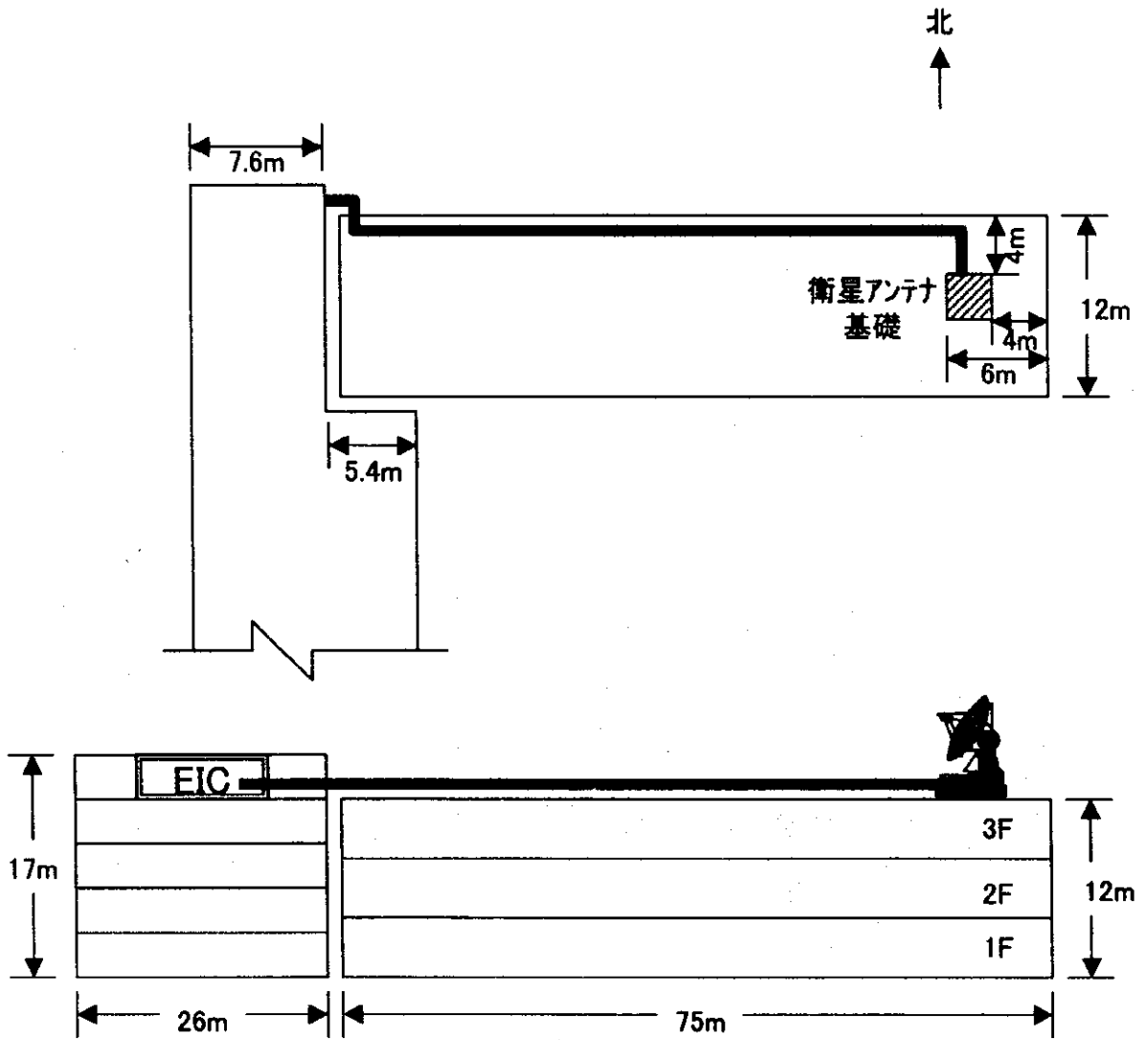

衛星通信用アンテナ配置図

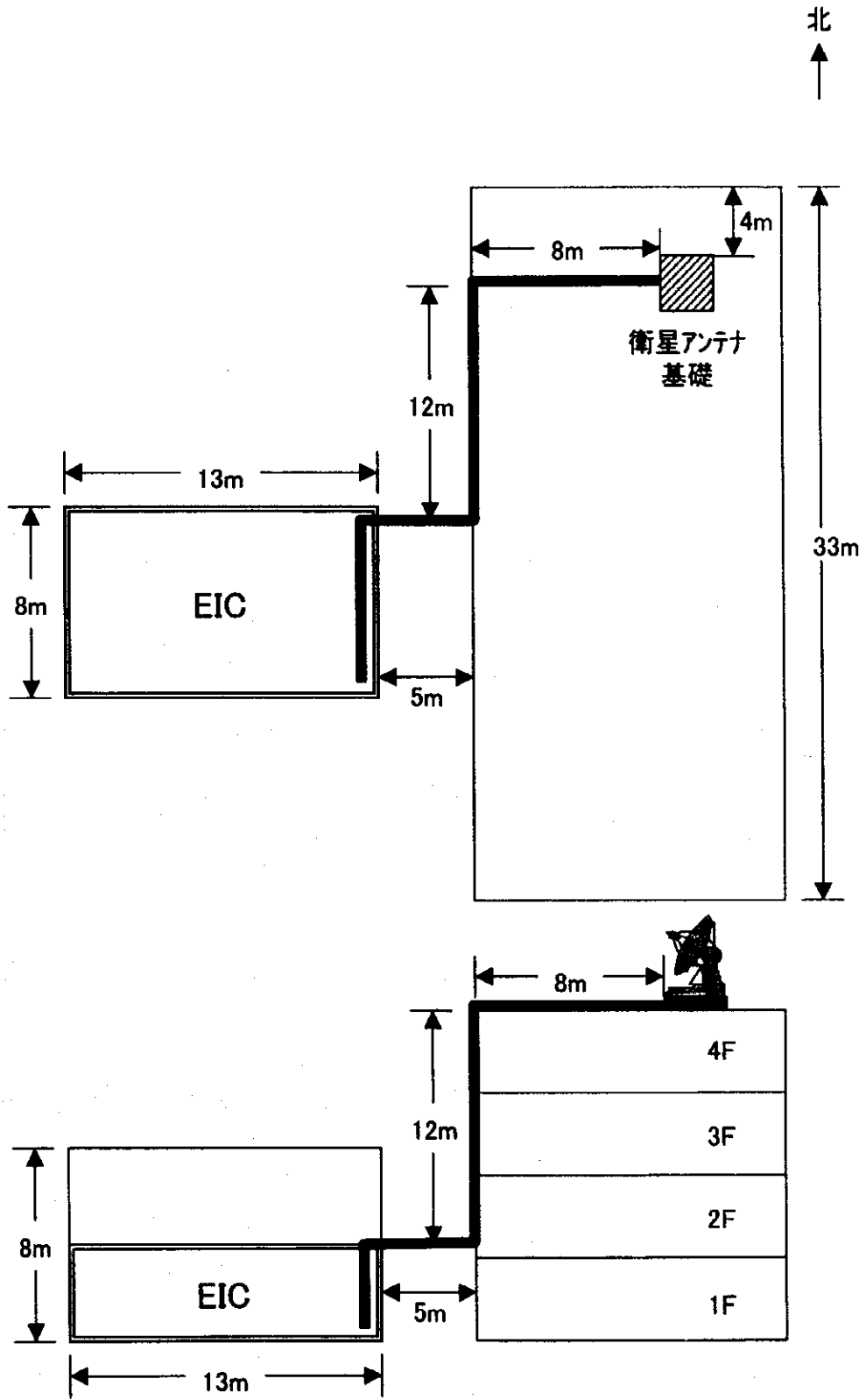

衛星通信用アンテナ配置図

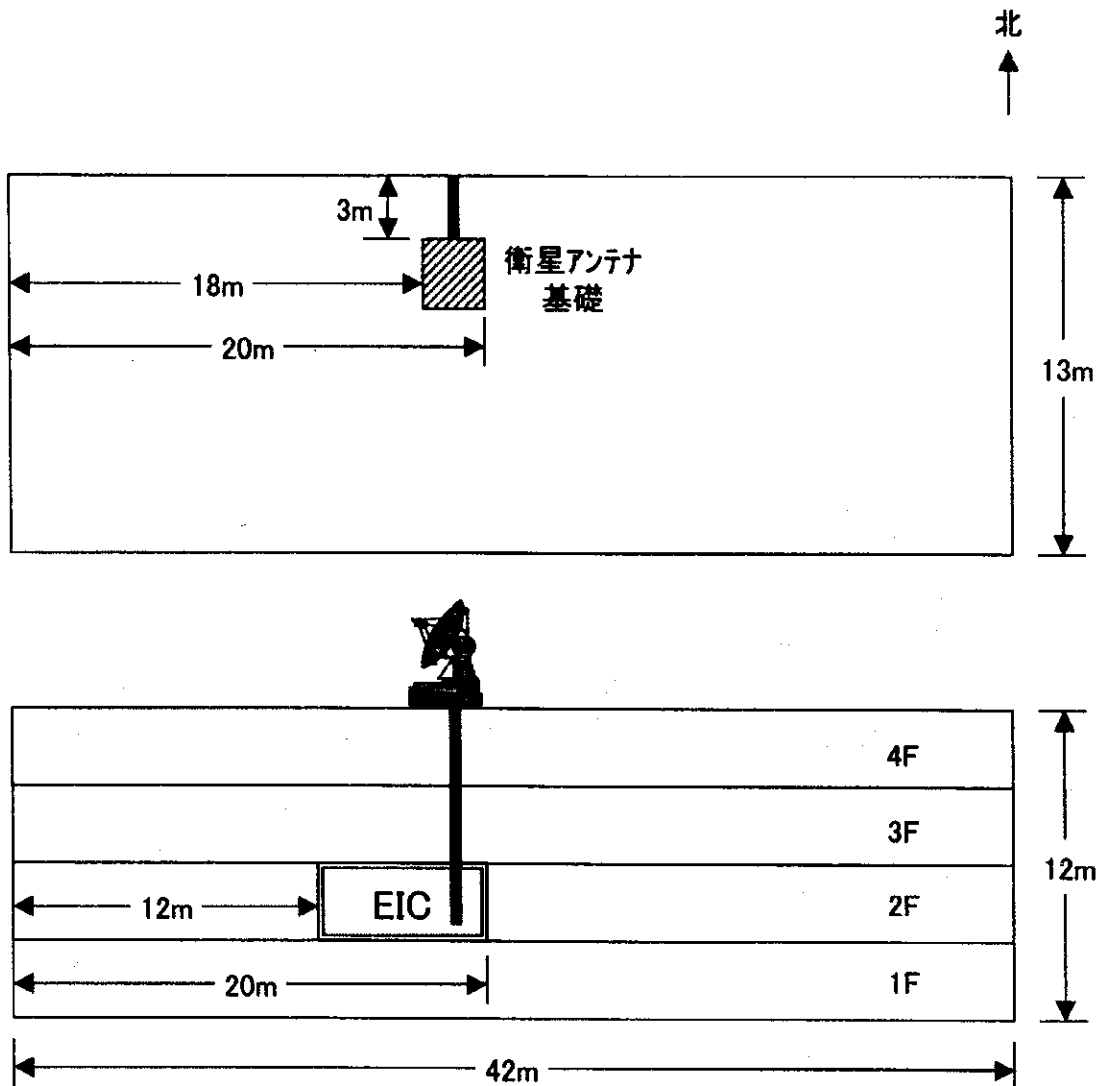

概算ケーブル長: 80m

衛星通信用アンテナ配置図

都市番号13 内蒙古自治区・呼和浩特市（第一次No.5）

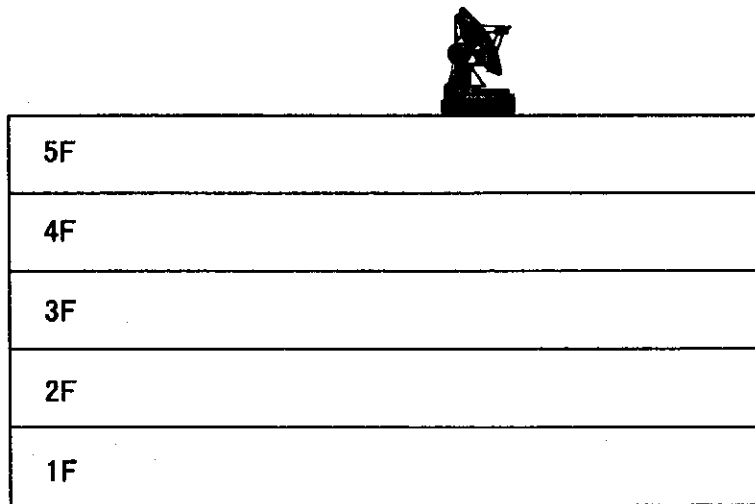
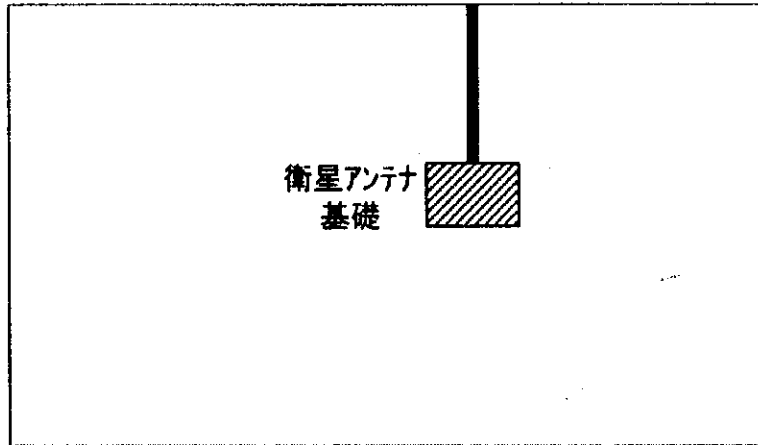

概算ケーブル長：80m

衛星通信用アンテナ配置図

都市番号14 遼寧省・瀋陽市（第一次No.6）

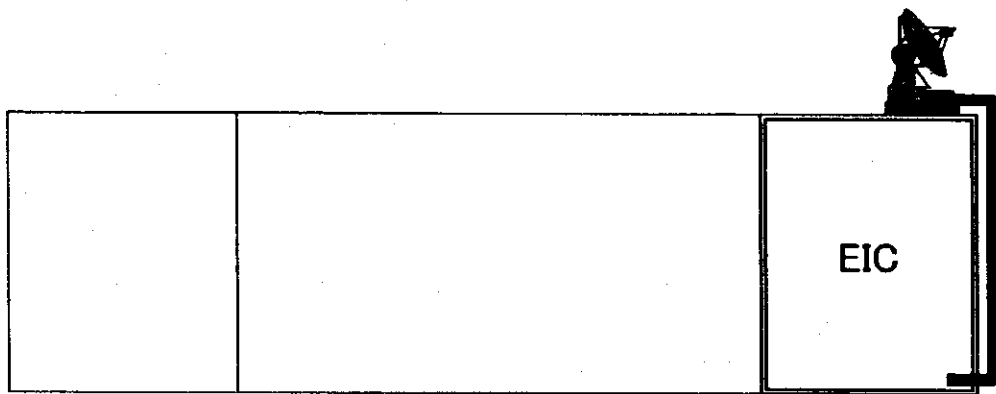
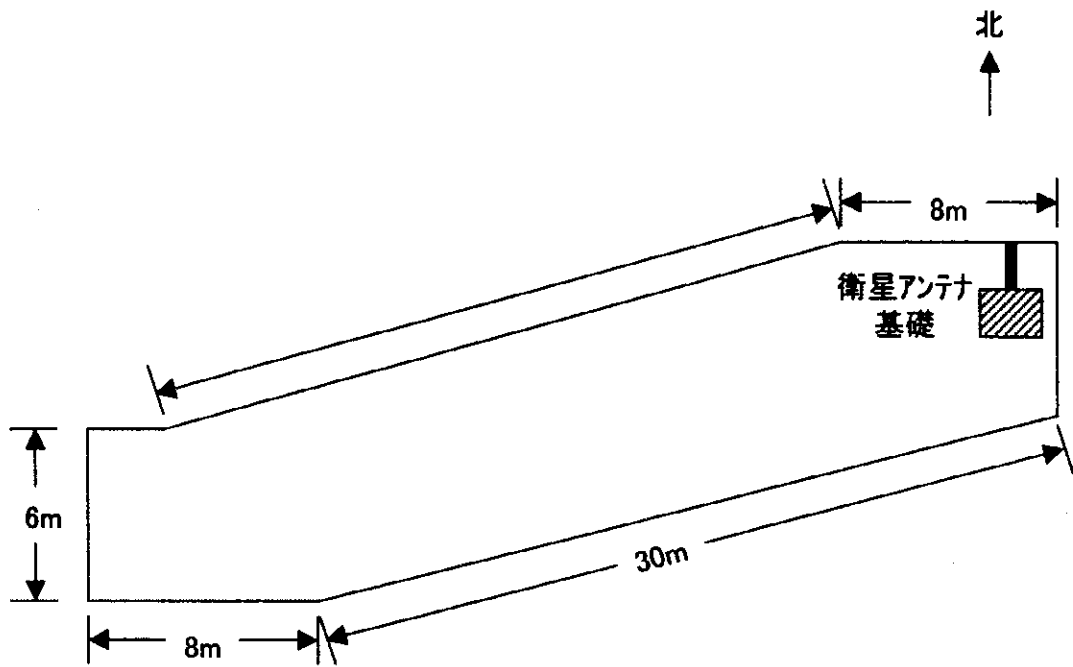

概算ケーブル長：80m

衛星通信用アンテナ配置図

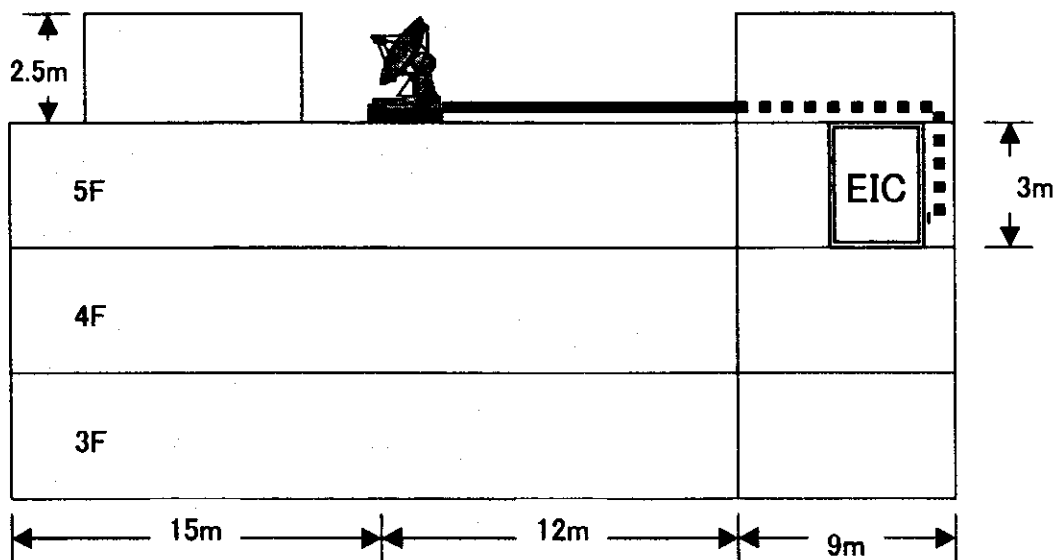
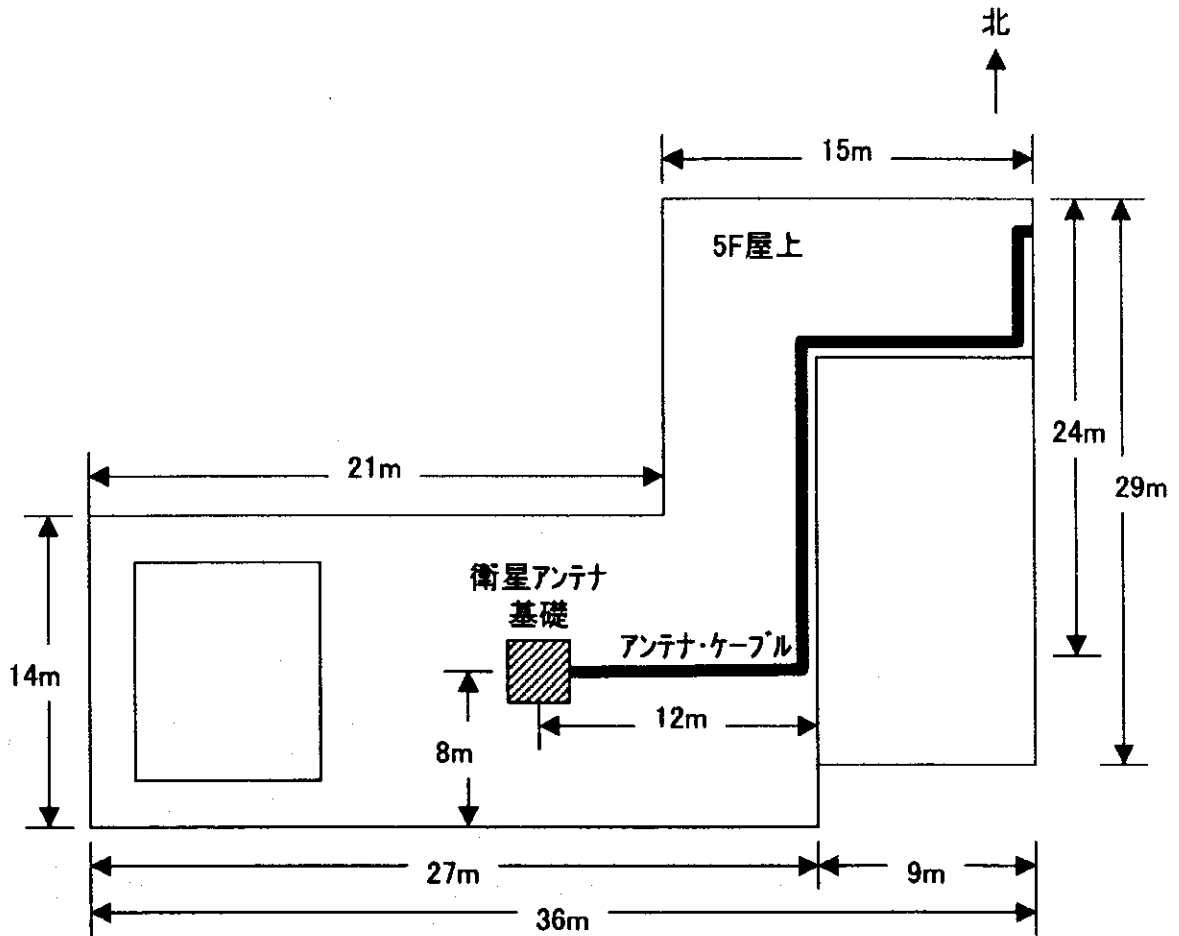

概算ケーブル長：80m

衛星通信用アンテナ配置図

都市番号17 遼寧省・营口市 No.10

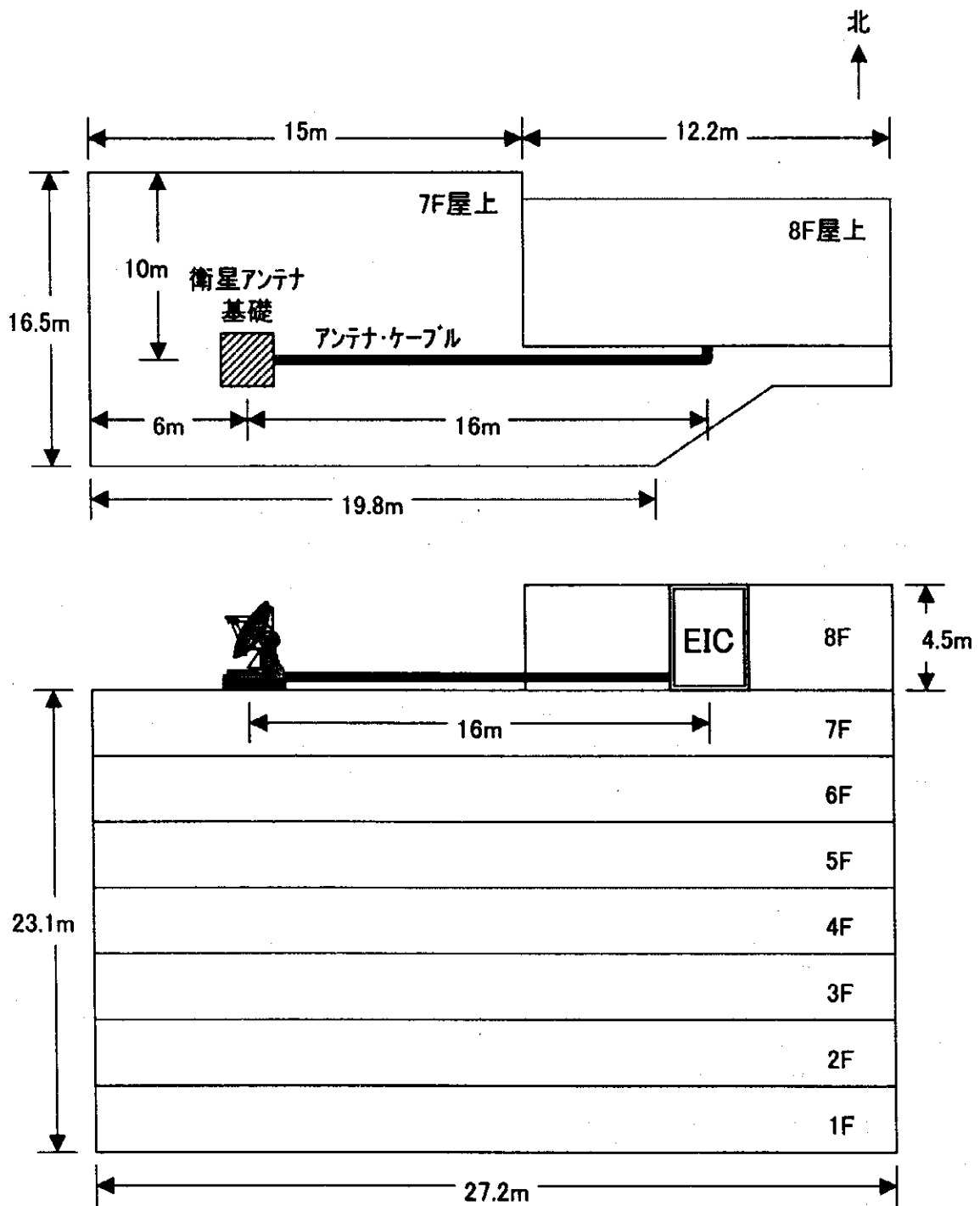

概算ケーブル長: 80m

衛星通信用アンテナ配置図

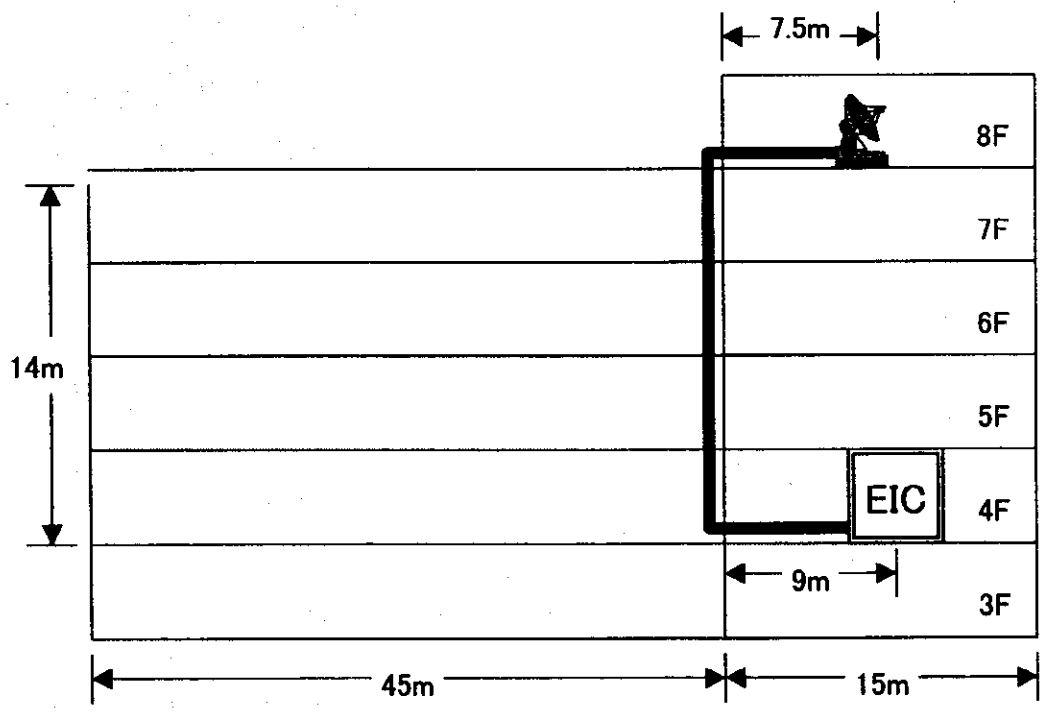
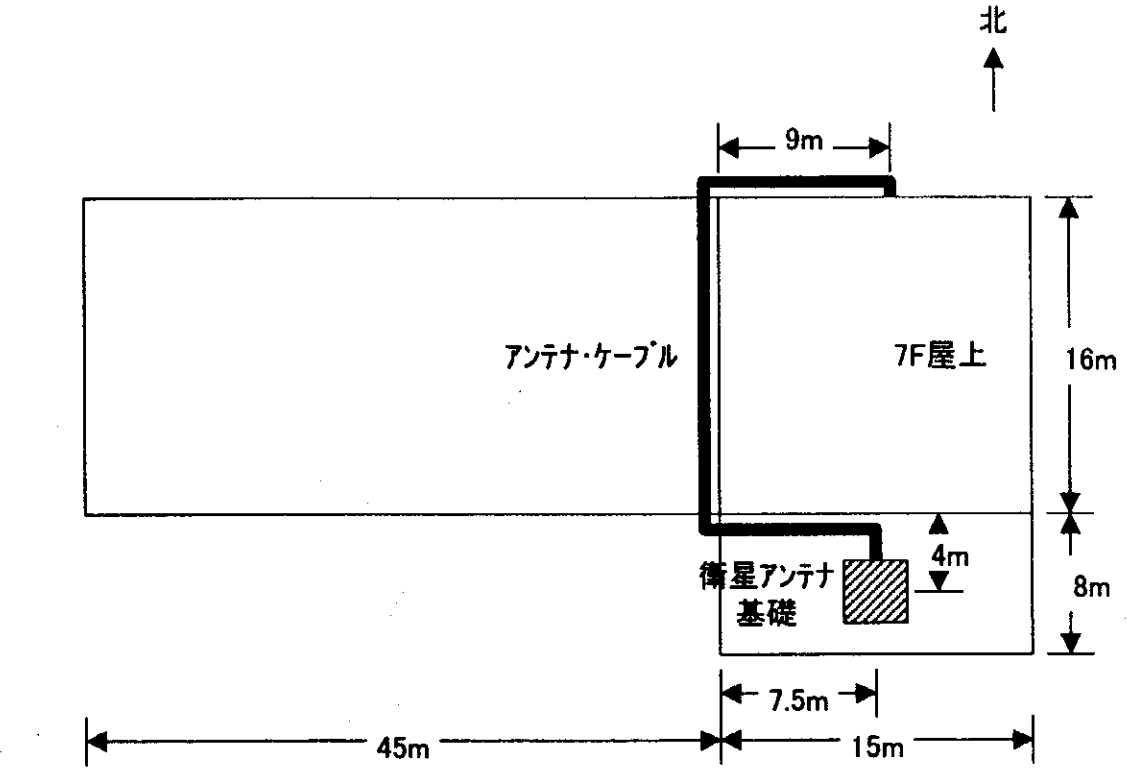

概算ケーブル長: 80m

衛星通信用アンテナ配置図

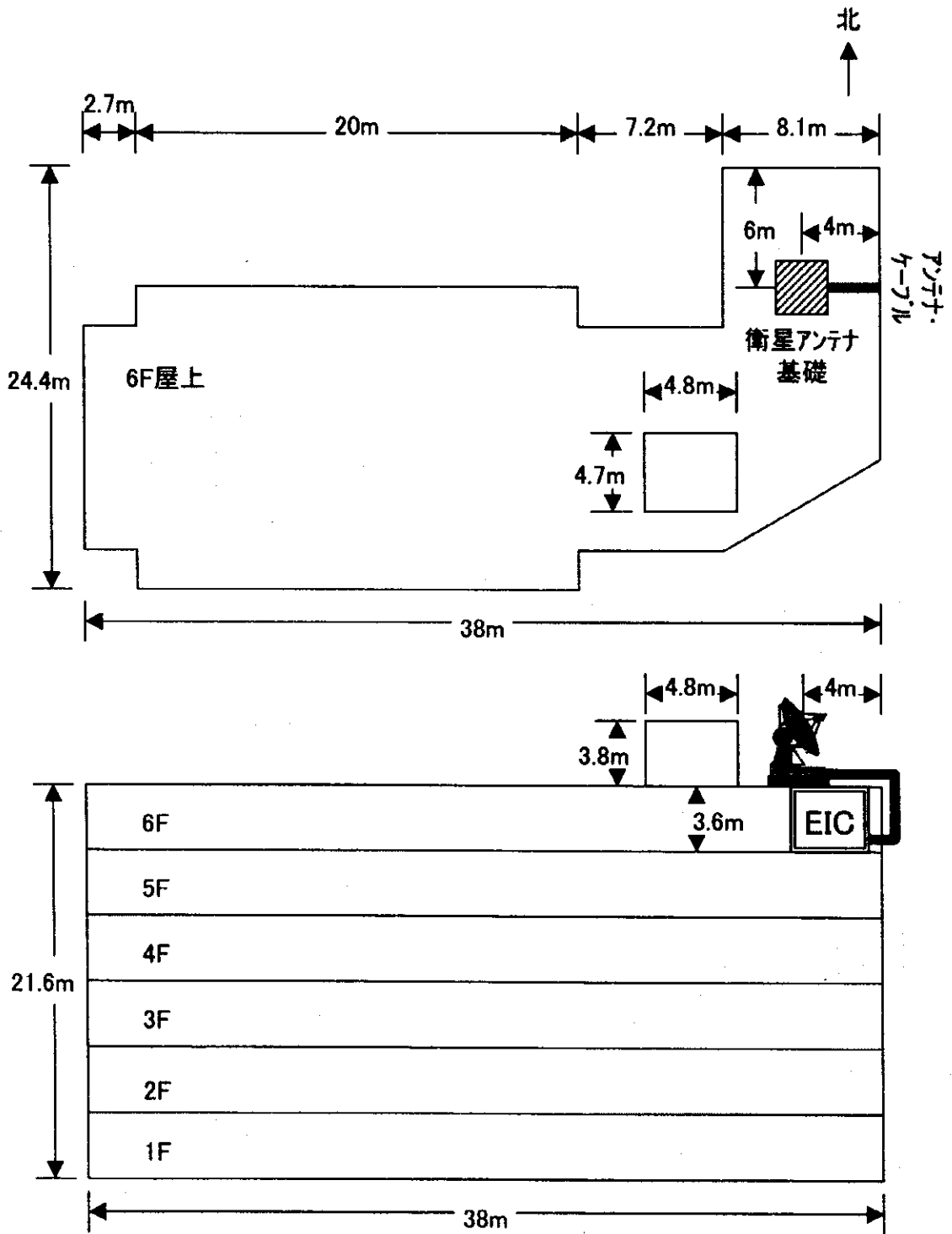

概算ケーブル長: 80m

衛星通信用アンテナ配置図

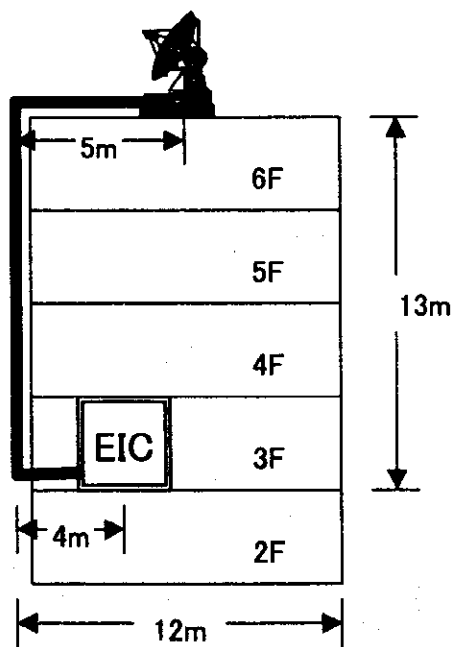
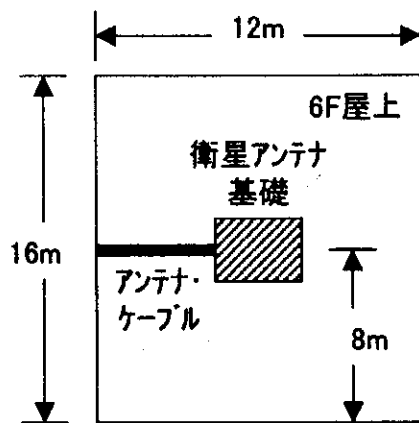

概算ケーブル長: 80m

衛星通信用アンテナ配置図

都市番号21 吉林省・長春市（第一次No.8）

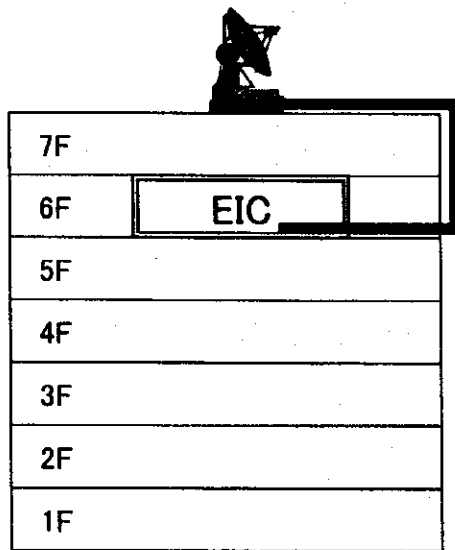
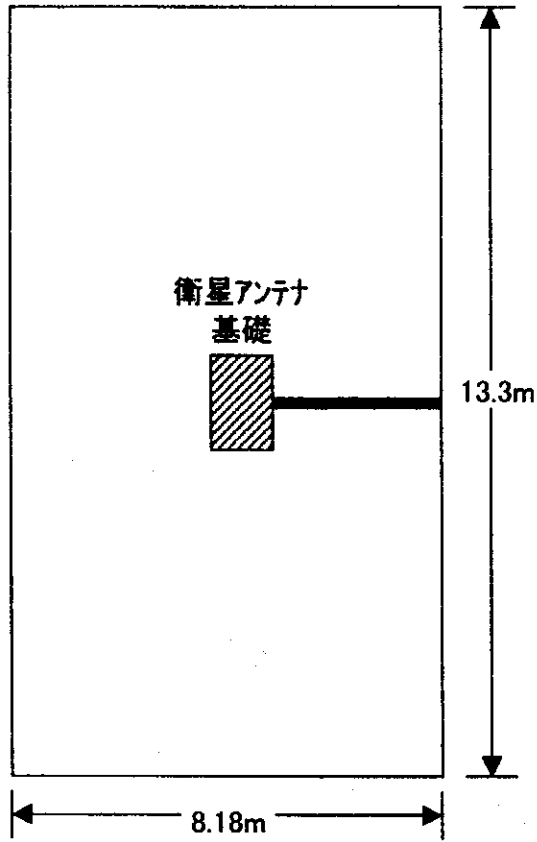

概算ケーブル長：80m

衛星通信用アンテナ配置図

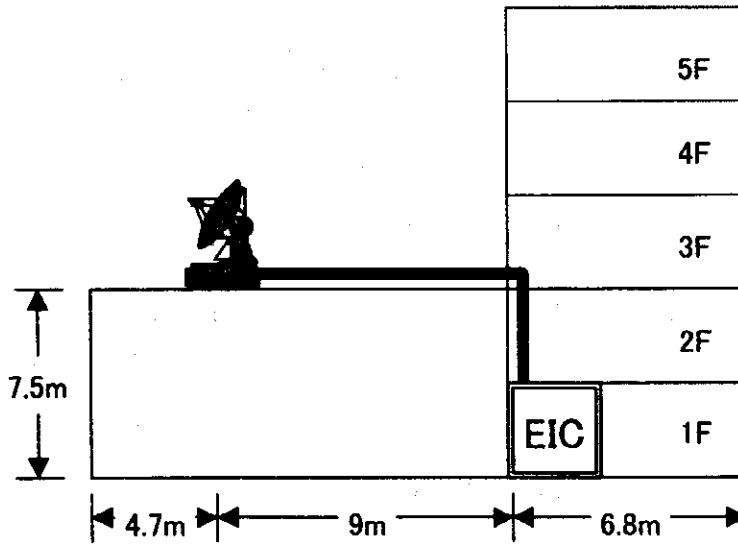
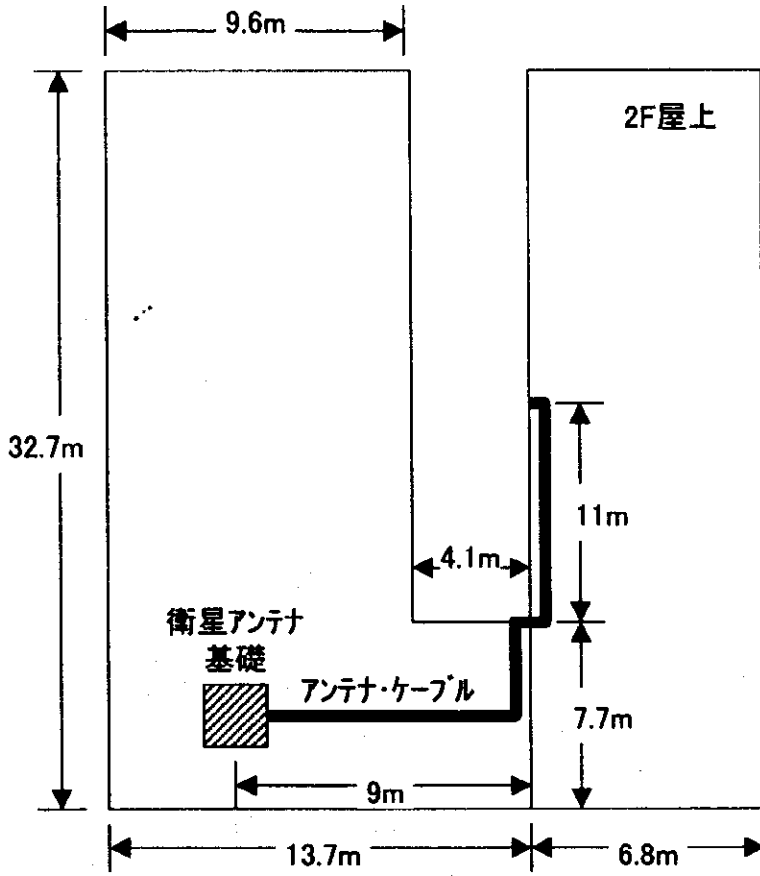

概算ケーブル長: 80m

衛星通信用アンテナ配置図

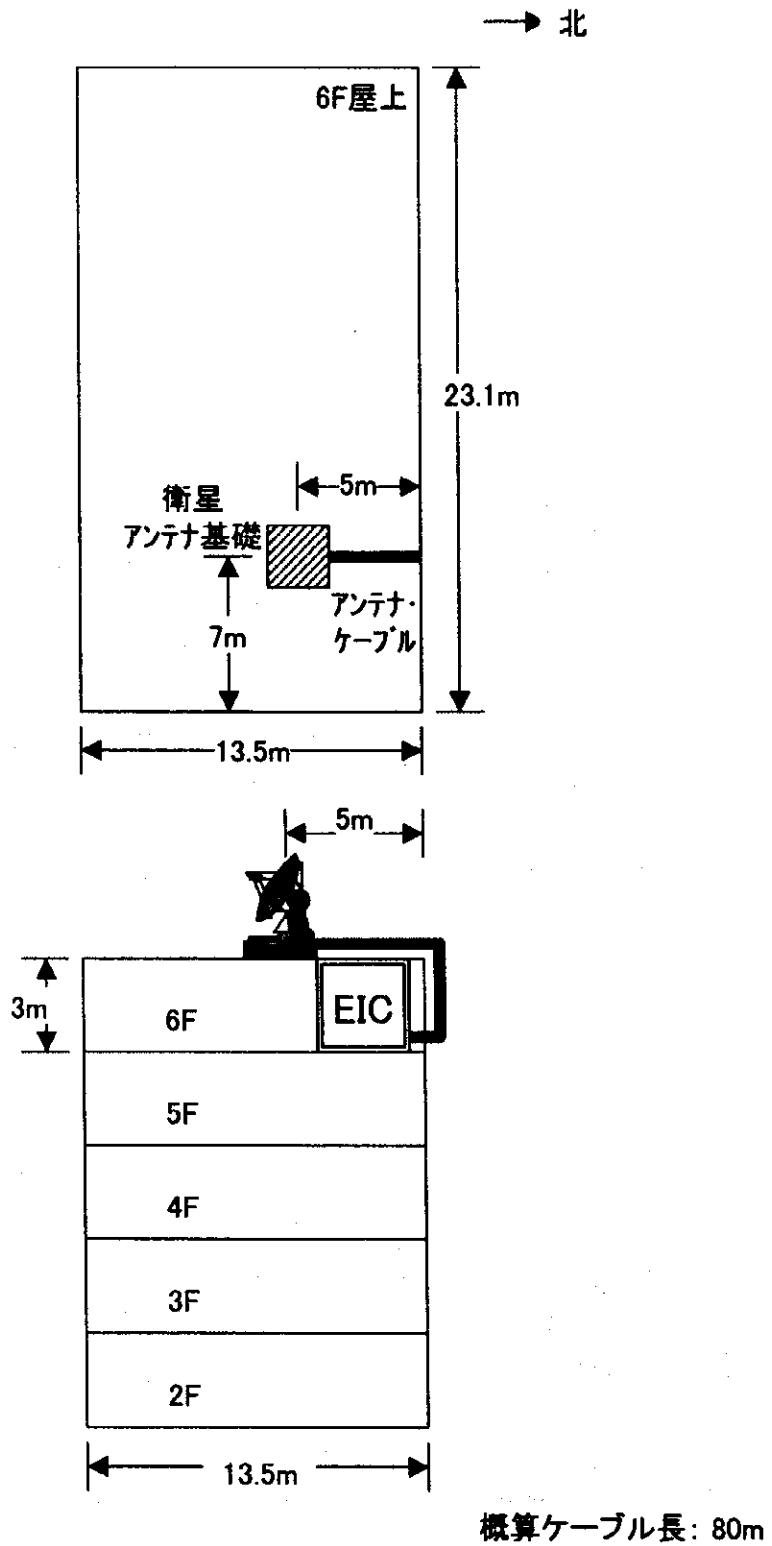

衛星通信用アンテナ配置図

北 ←

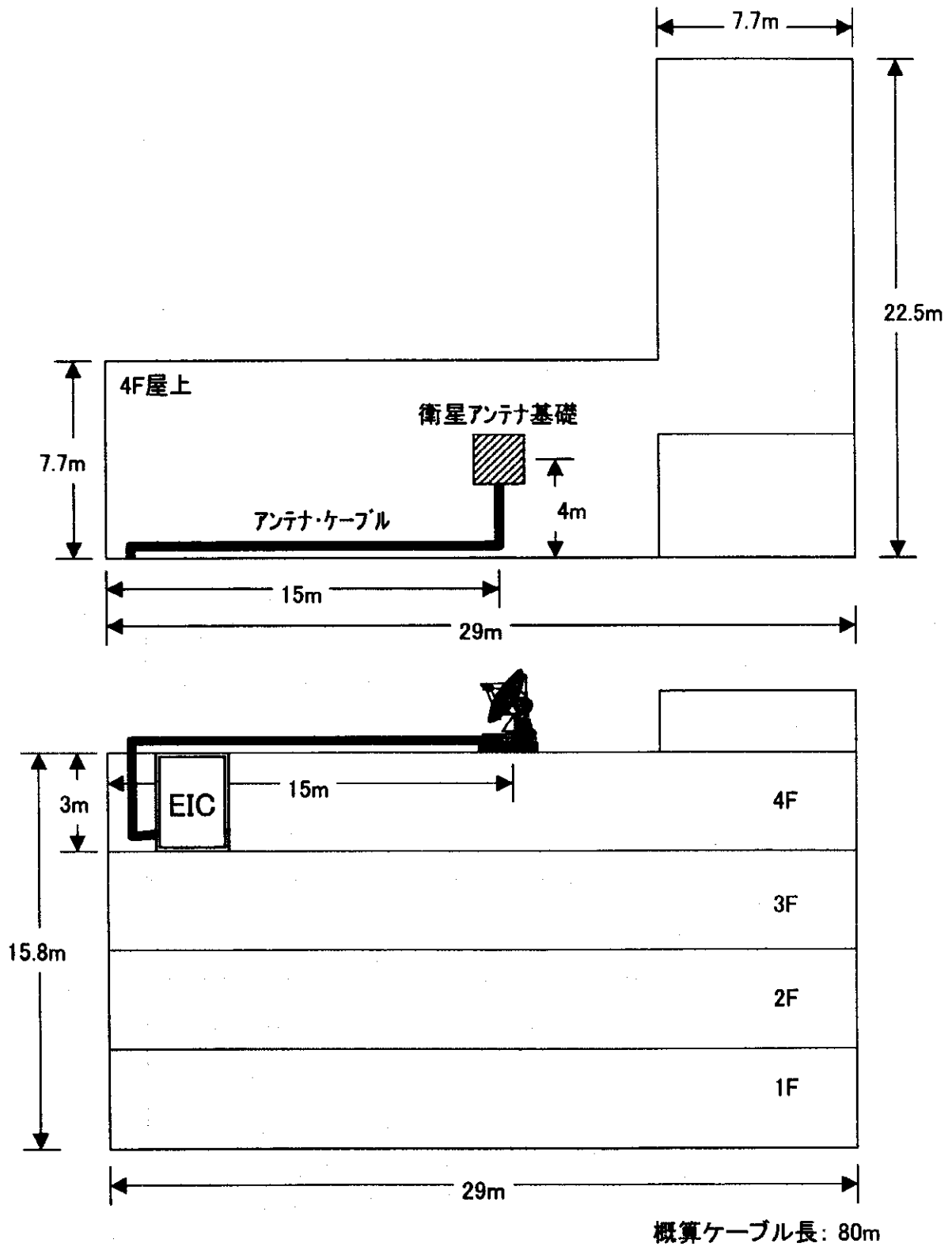

概算ケーブル長：80m

衛星通信用アンテナ配置図

都市番号25 黒龍江省・哈尔滨市（第一次No.9）

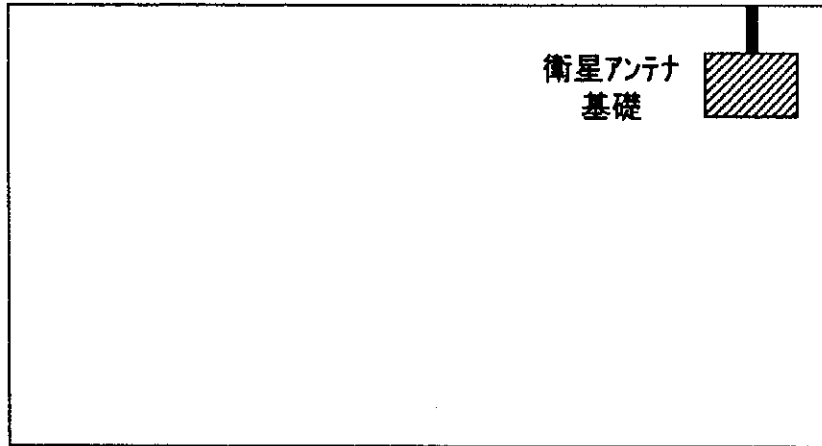

10F
9F
8F
7F
6F
5F
4F
3F
2F
1F

概算ケーブル長：80m

衛星通信用アンテナ配置図

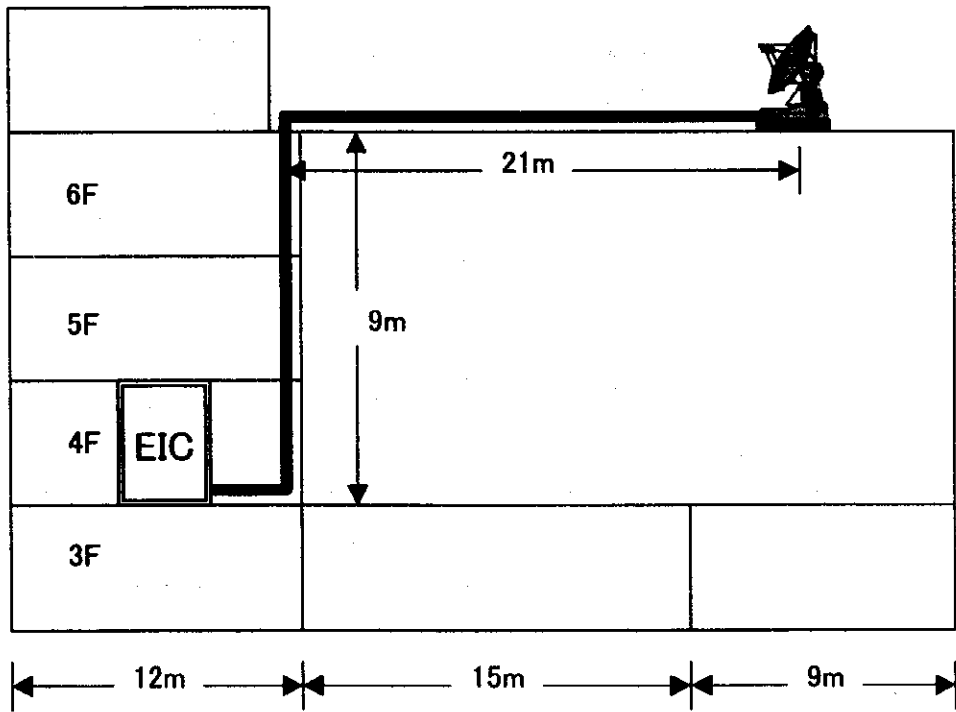
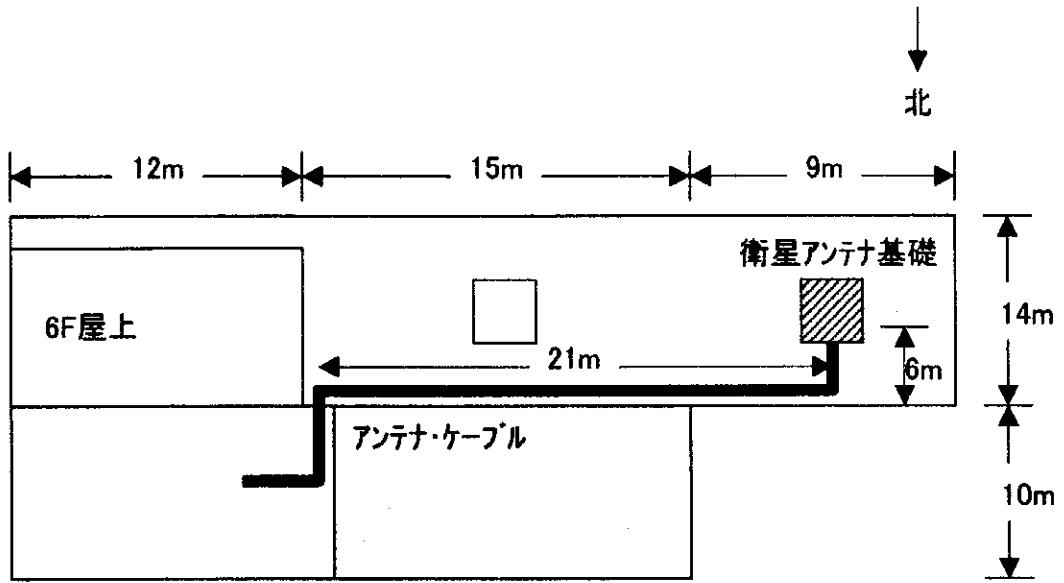

概算ケーブル長: 80m

衛星通信用アンテナ配置図

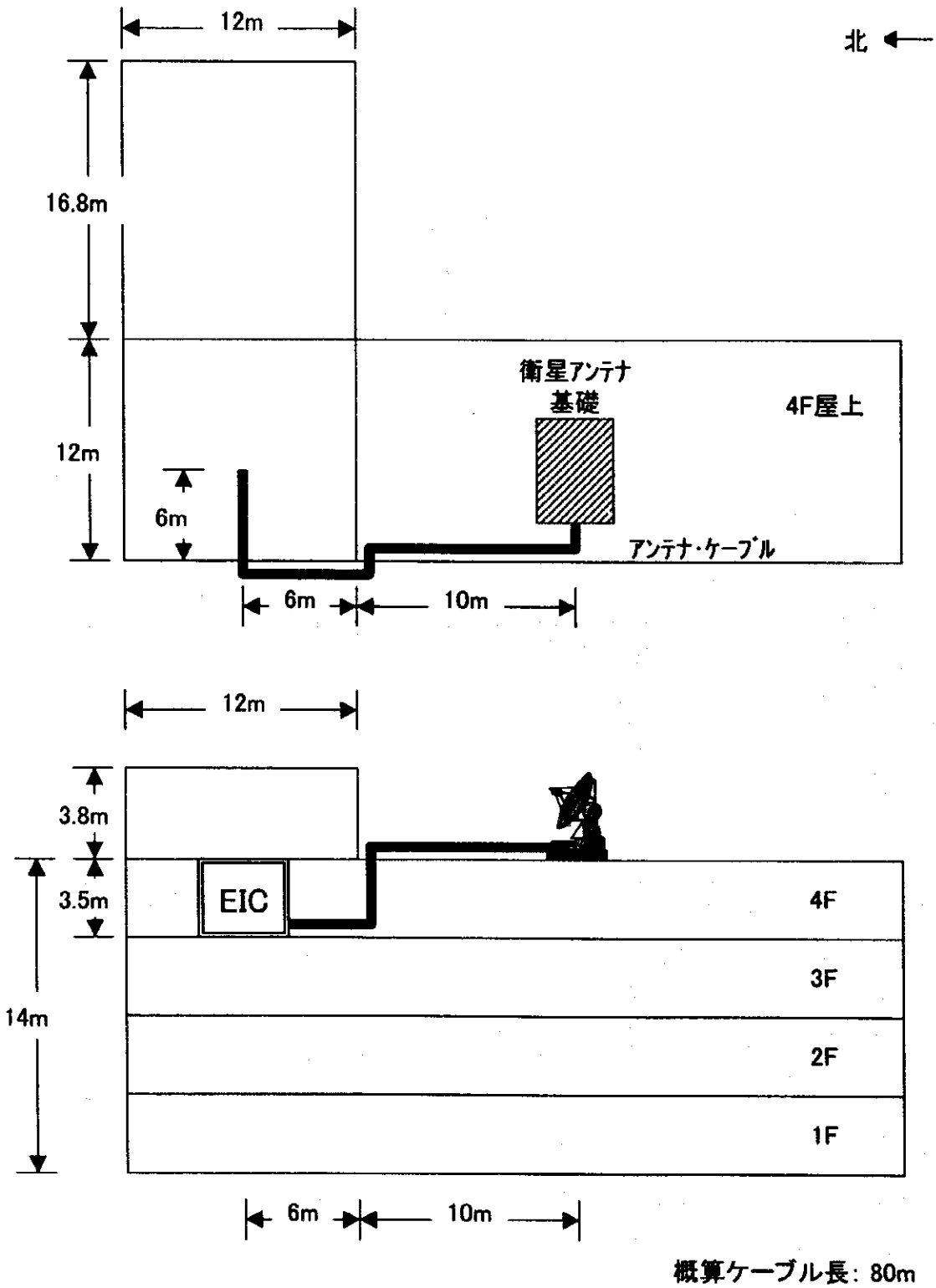

衛星通信用アンテナ配置図

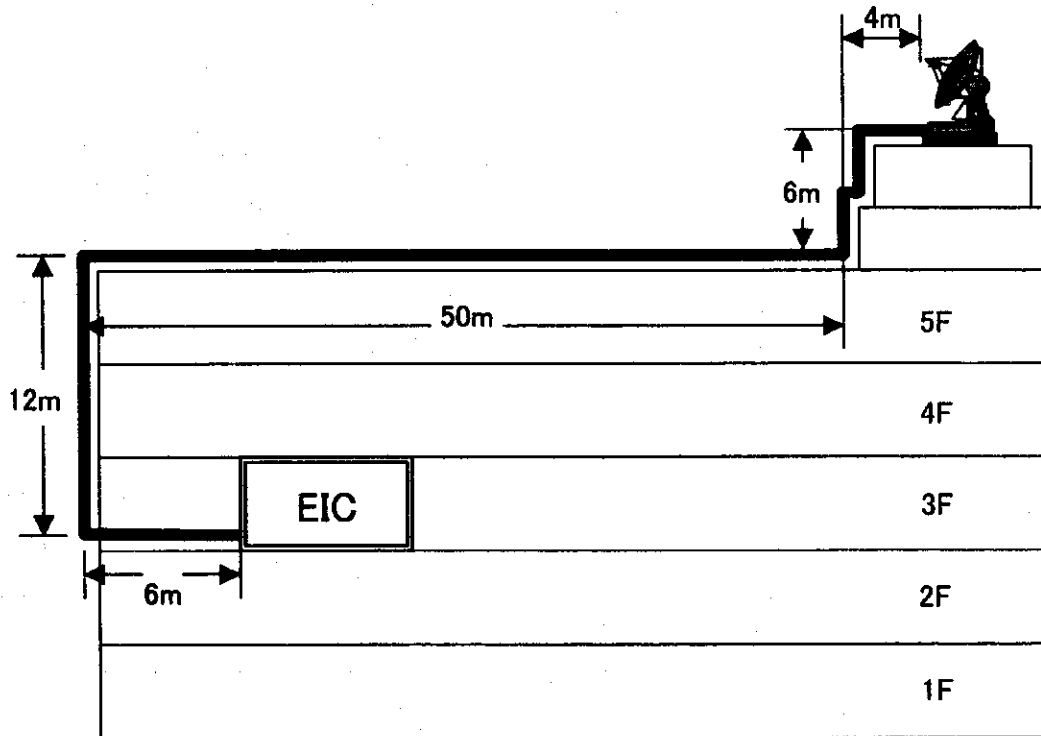
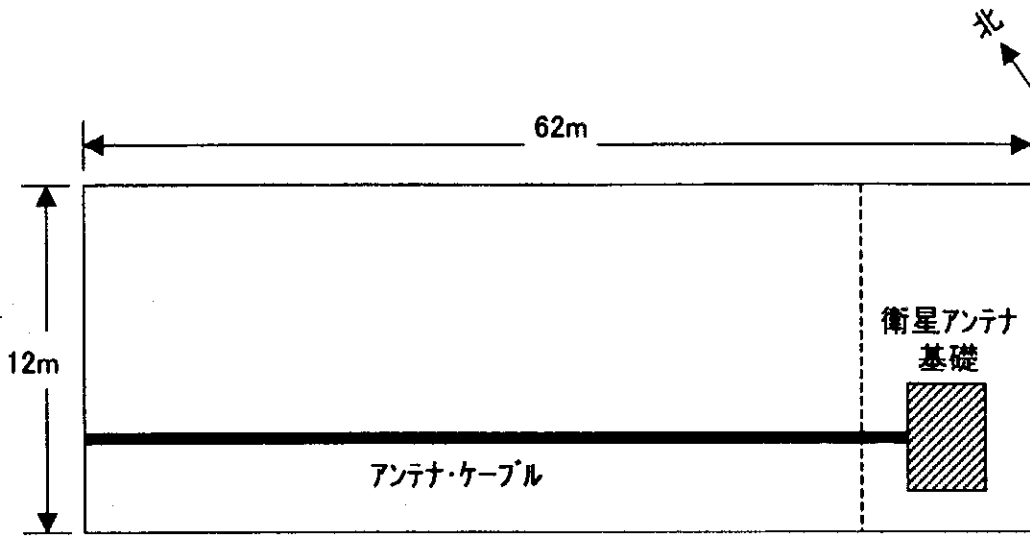

概算ケーブル長：80m

衛星通信用アンテナ配置図

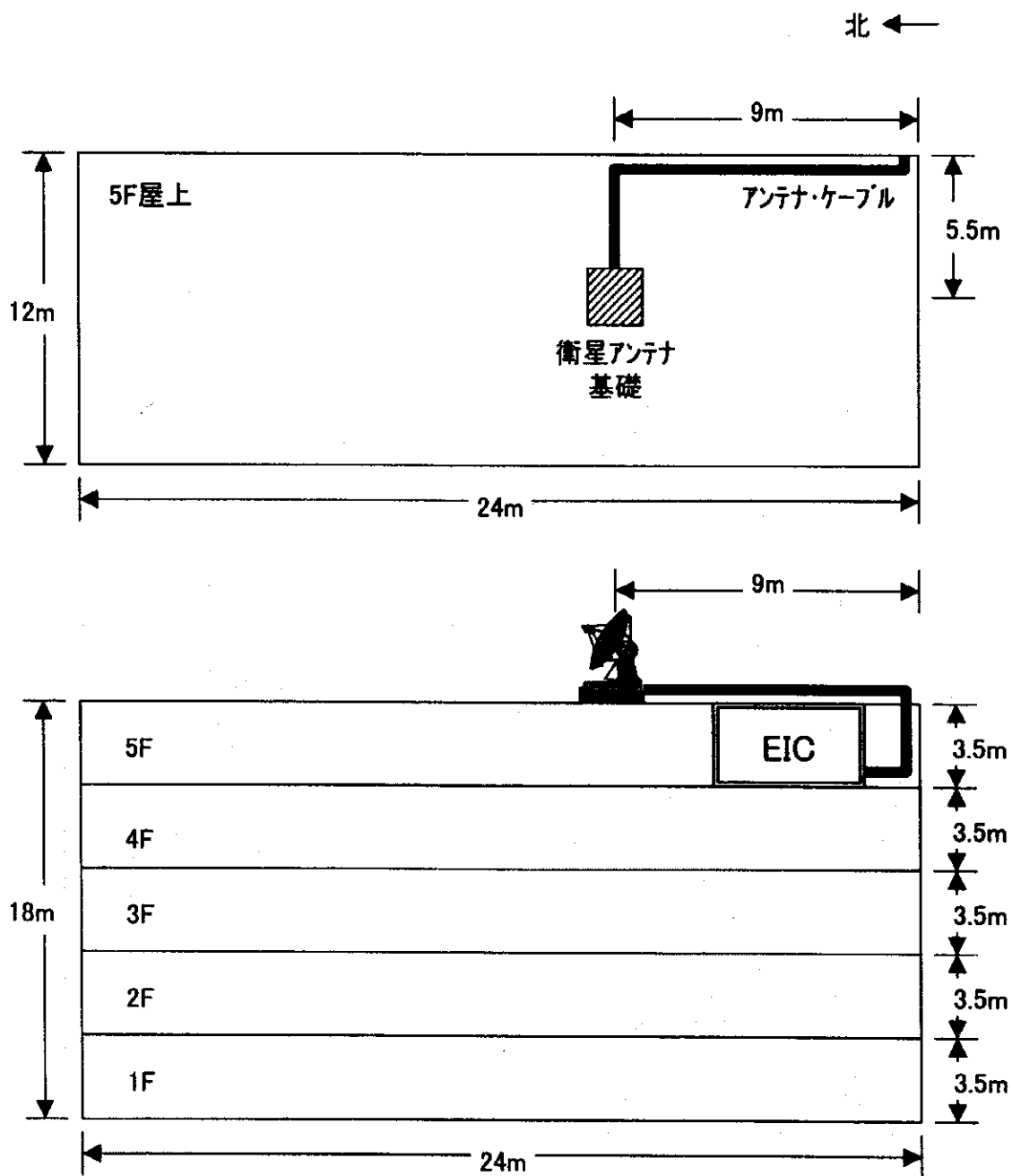

概算ケーブル長: 80m

衛星通信用アンテナ配置図

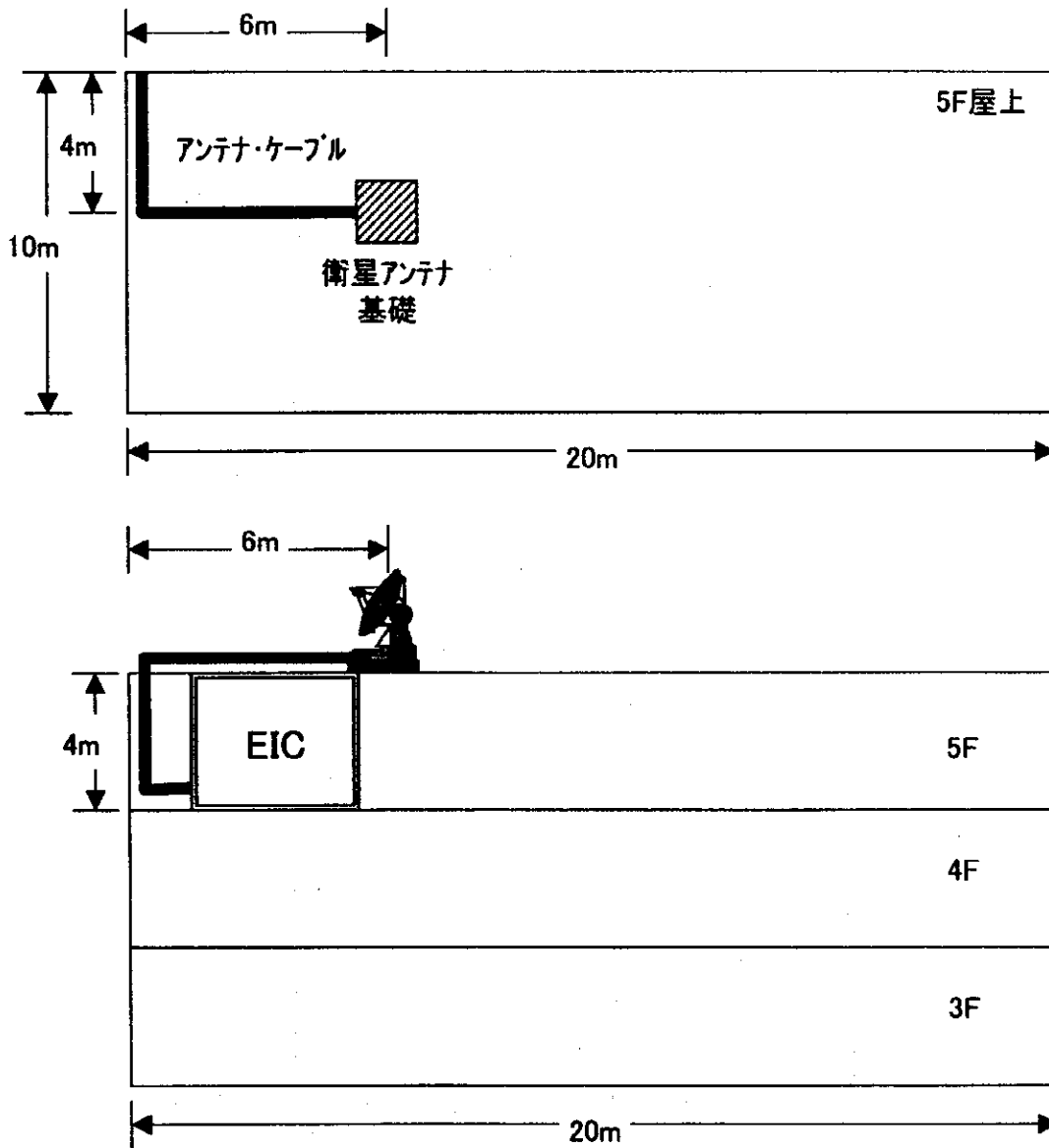

概算ケーブル長: 80m

衛星通信用アンテナ配置図

北 ←

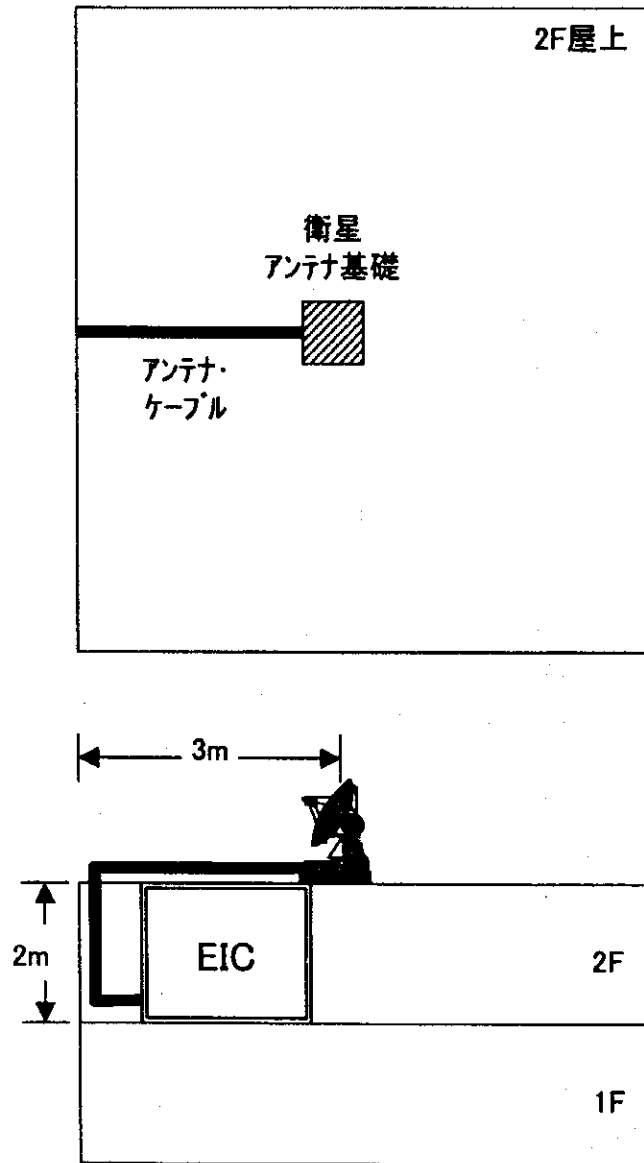

概算ケーブル長：80m

衛星通信用アンテナ配置図

都市番号32 江蘇省・無錫市（第一次No.10）

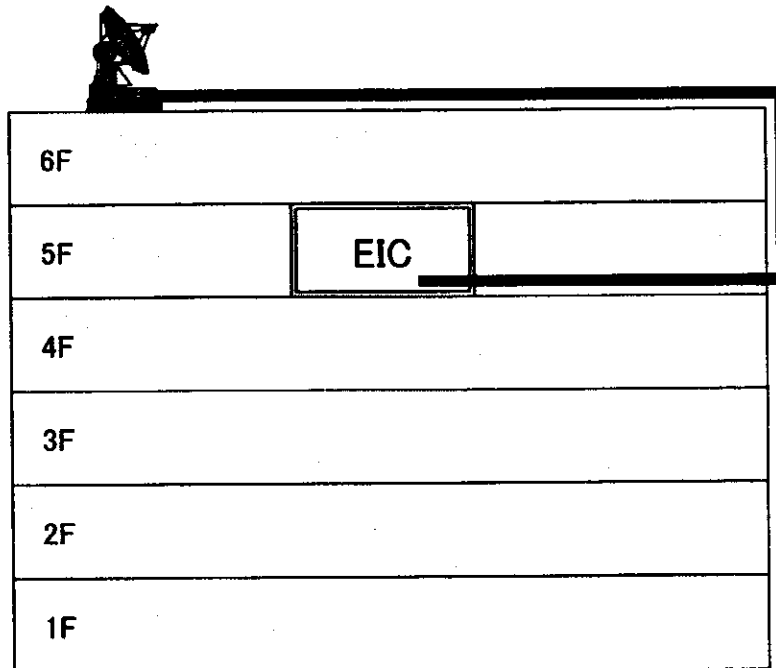
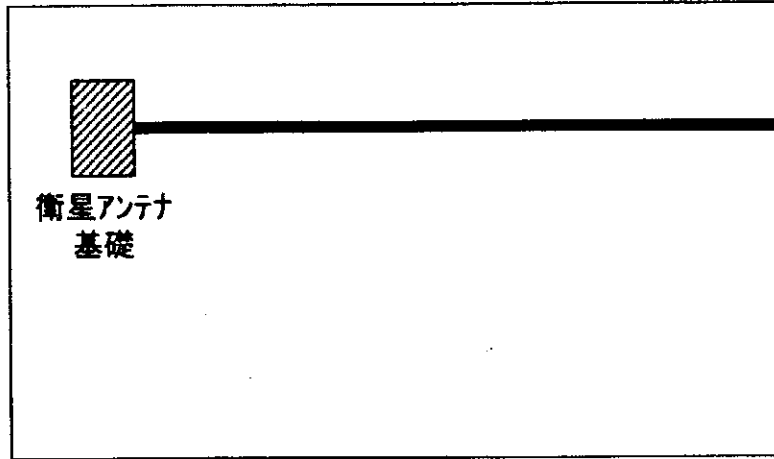

概算ケーブル長：80m

衛星通信用アンテナ配置図

都市番号33 江蘇省・徐州市（第一次No.11）

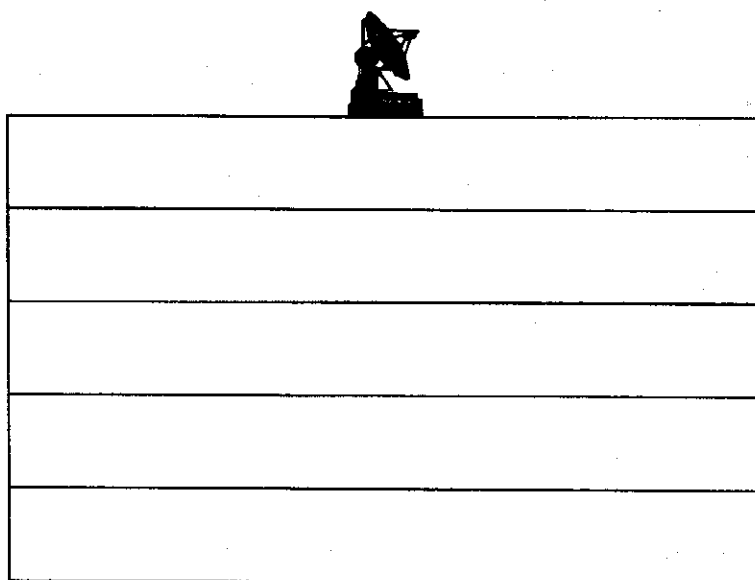
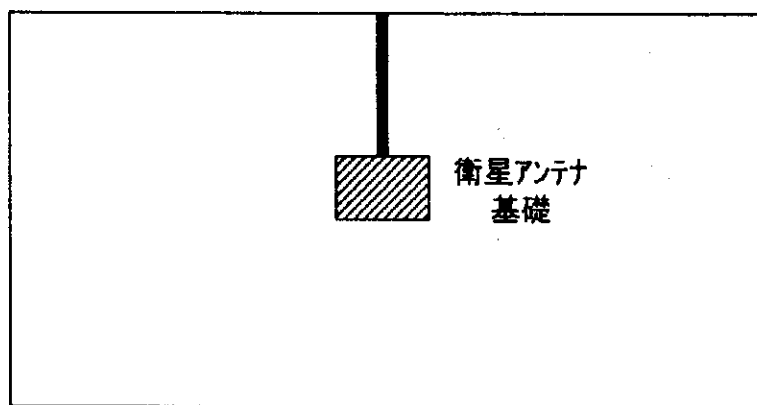

概算ケーブル長：80m

衛星通信用アンテナ配置図

都市番号34 江蘇省・常州市（第一次No.12）

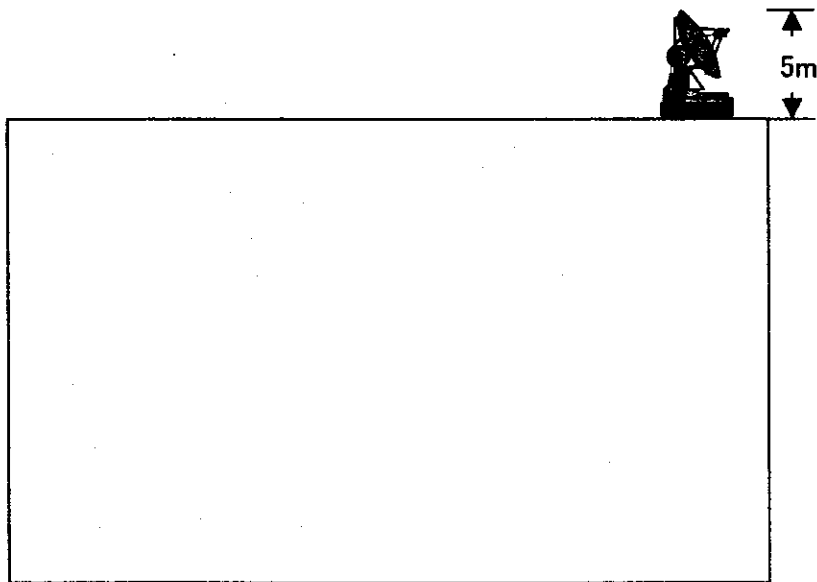
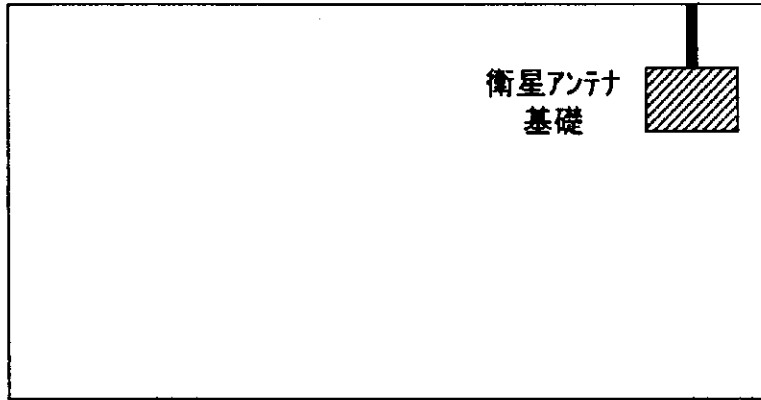

概算ケーブル長：80m

衛星通信用アンテナ配置図

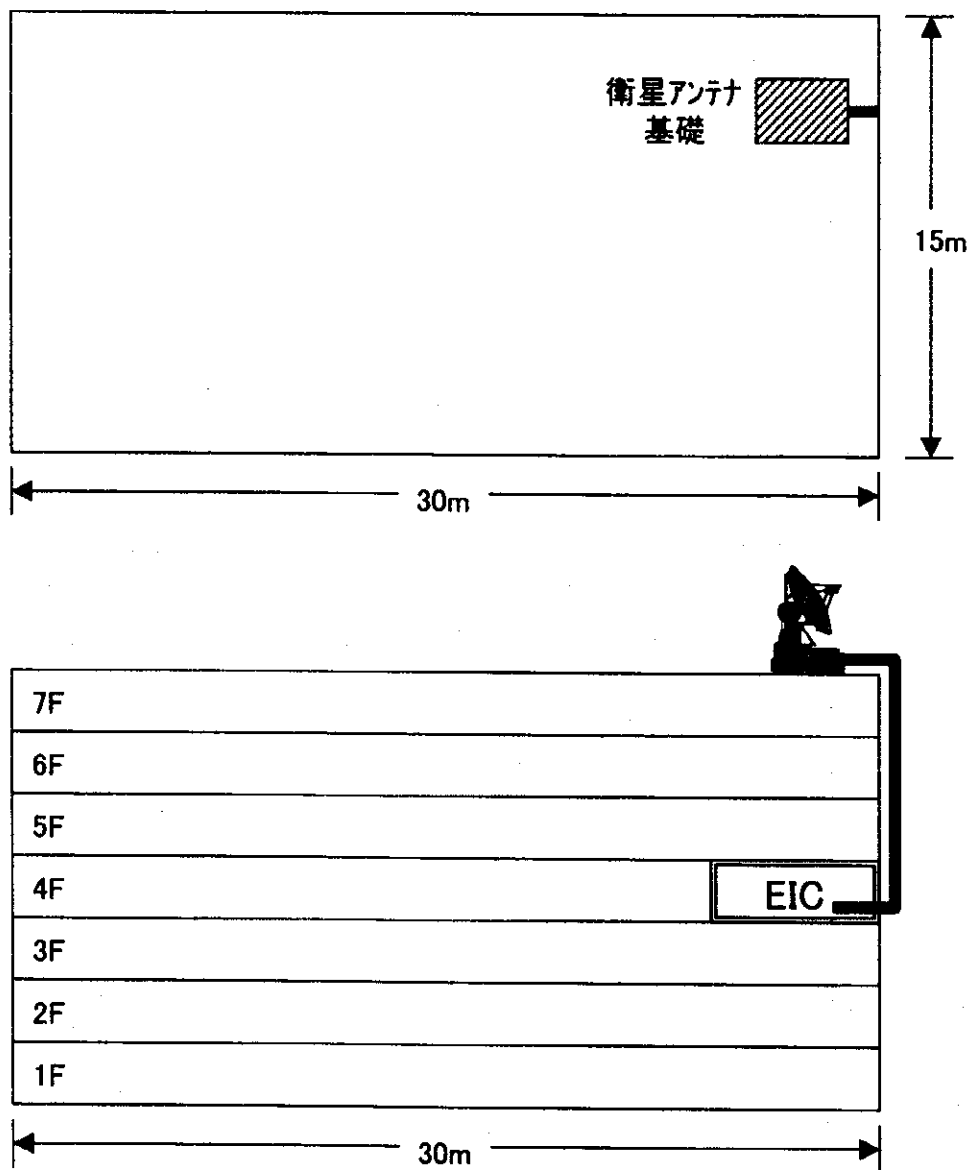

概算ケーブル長：80m

衛星通信用アンテナ配置図

都市番号37 江蘇省・淮陰市（第一次No.14）

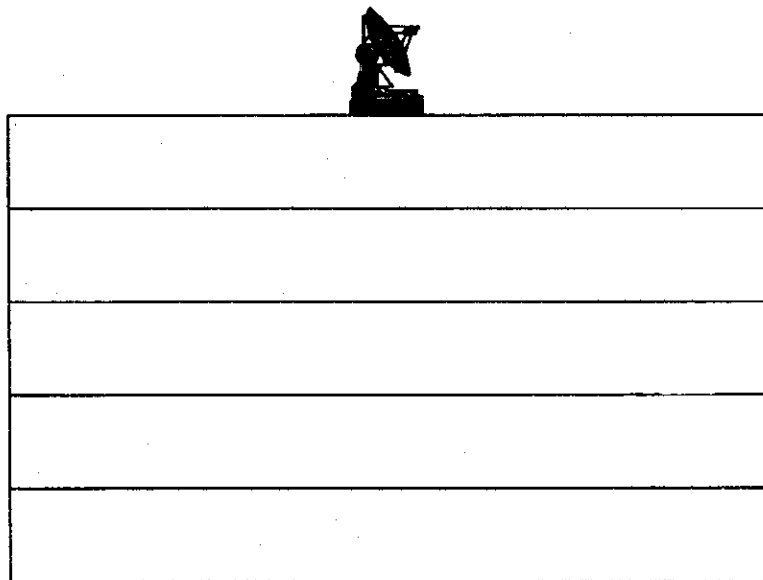
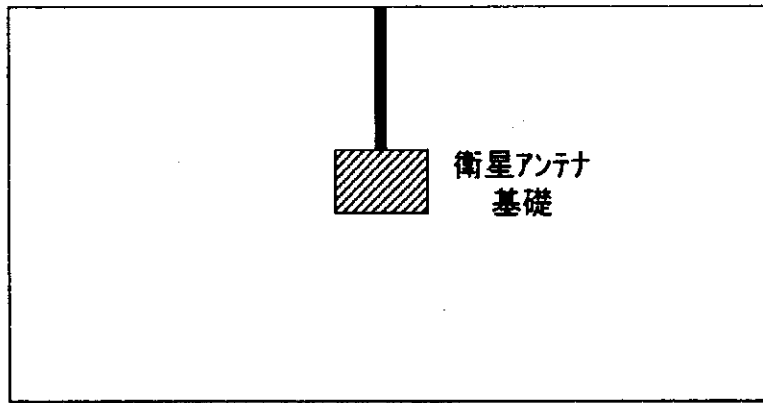

概算ケーブル長：80m

衛星通信用アンテナ配置図

都市番号38 浙江省・杭州市（第一次No.15）

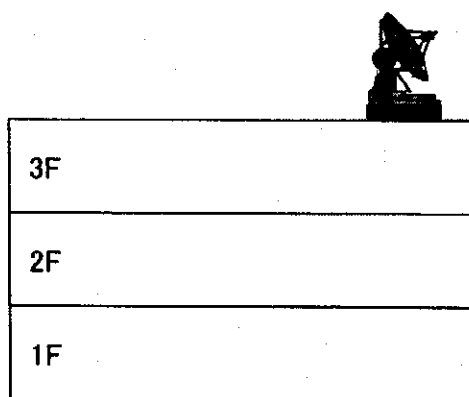
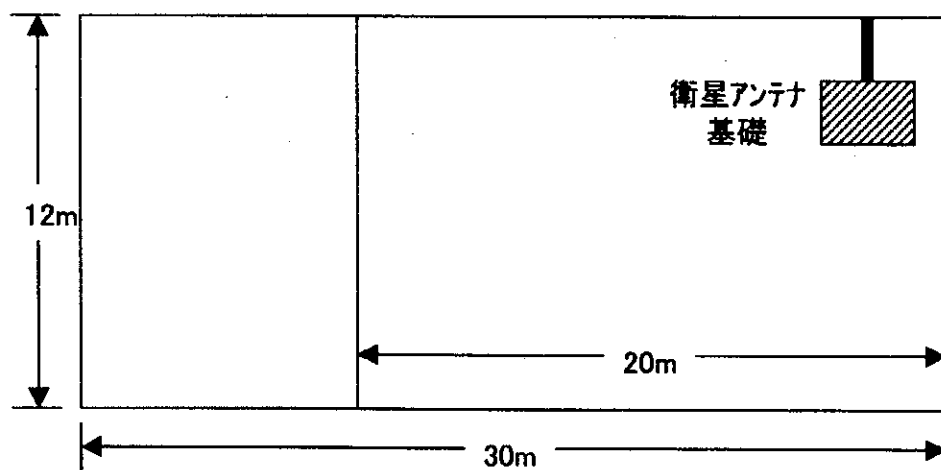

概算ケーブル長：80m

衛星通信用アンテナ配置図

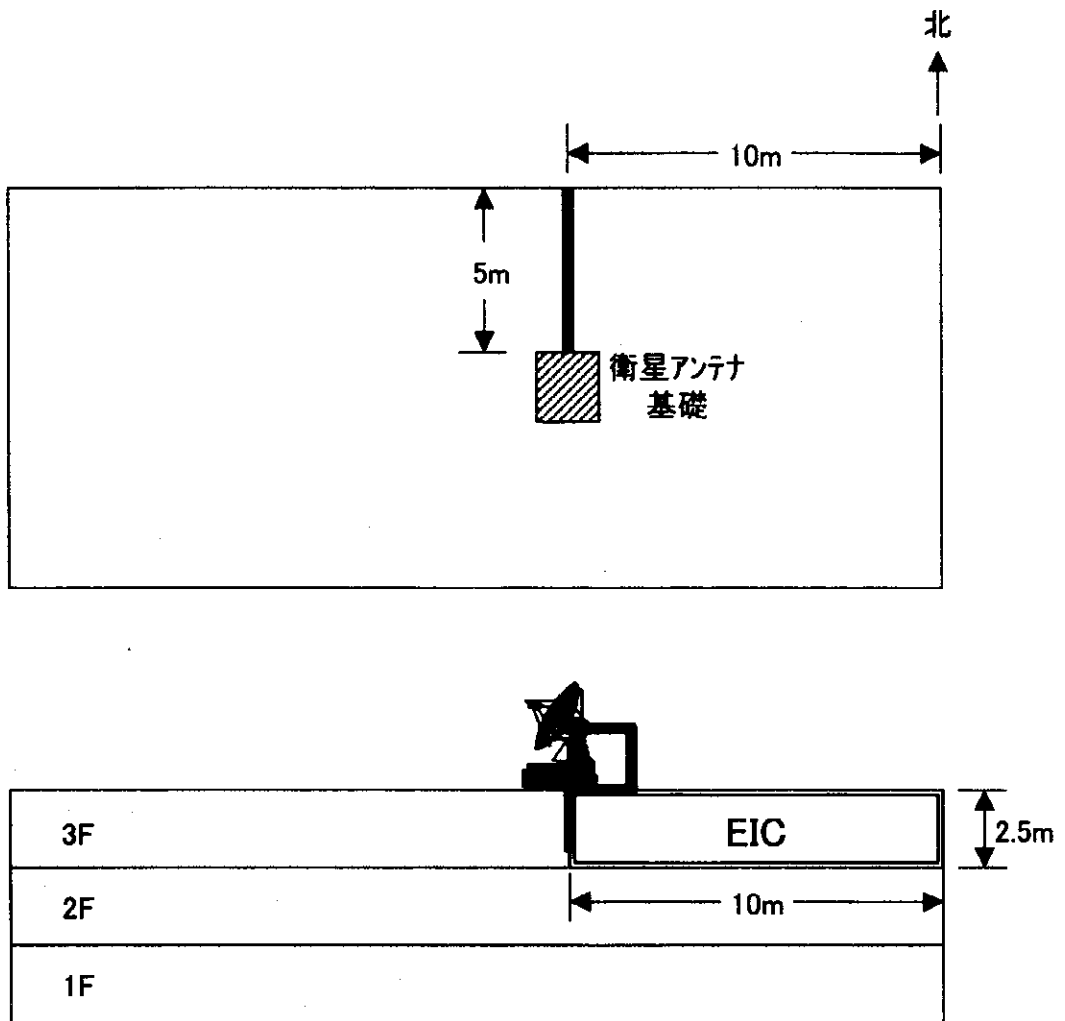

概算ケーブル長: 80m

衛星通信用アンテナ配置図

都市番号42 安徽省・合肥市（第一次No.18）

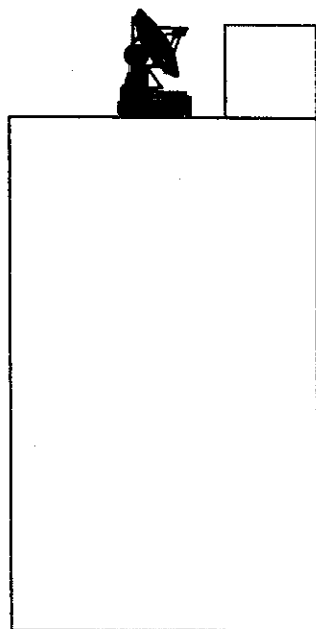
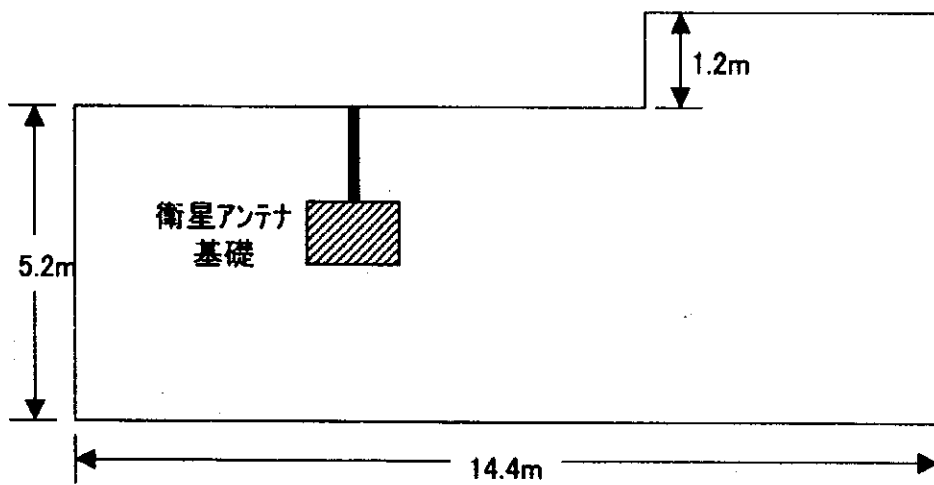

概算ケーブル長：80m

衛星通信用アンテナ配置図

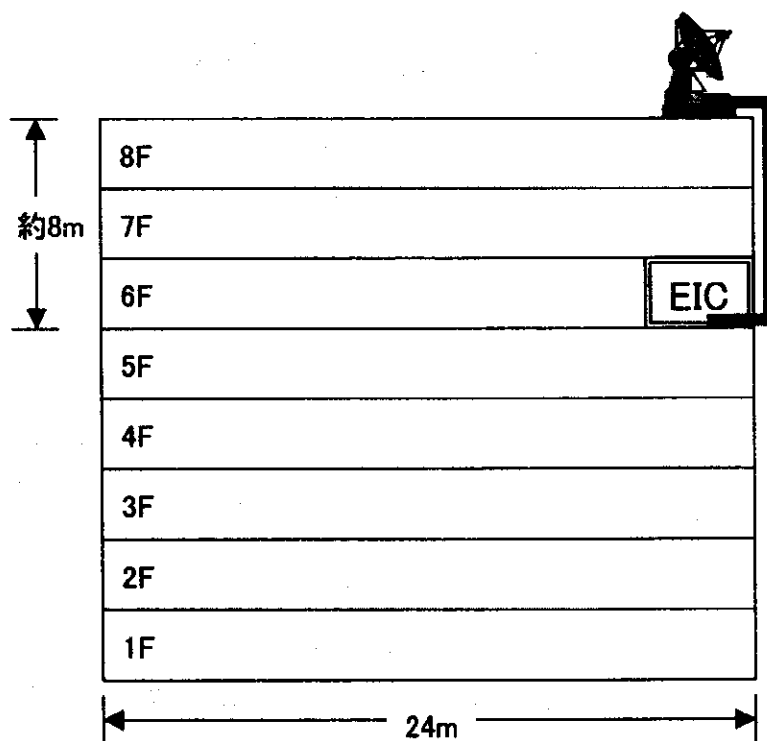
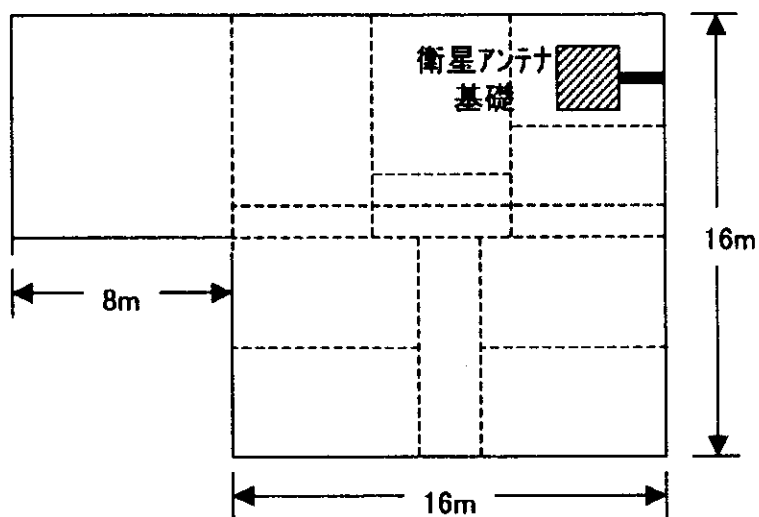

概算ケーブル長: 80m

衛星通信用アンテナ配置図

都市番号44 安徽省・淮南市（第一次No.18）

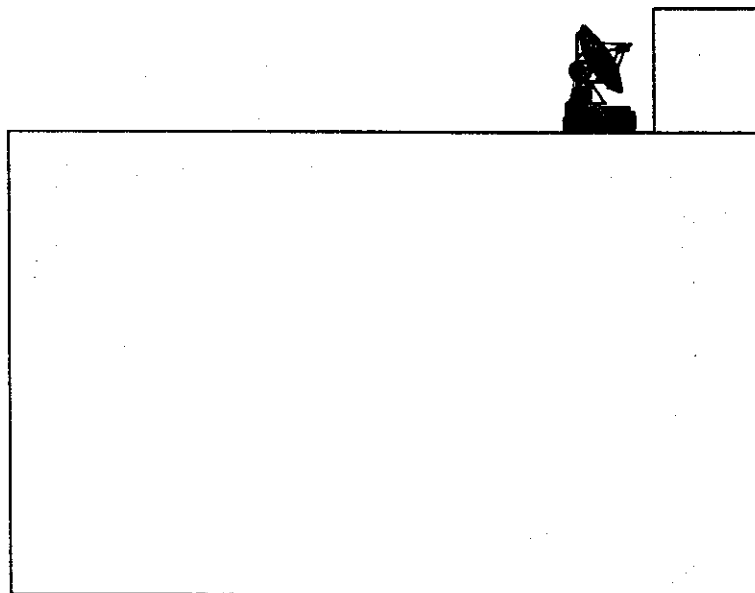
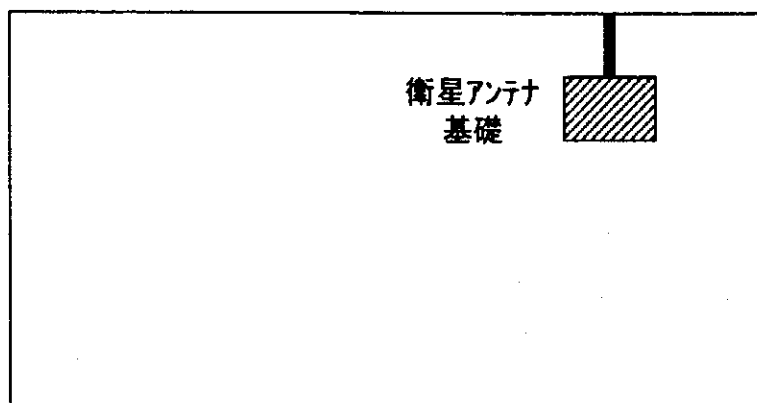

概算ケーブル長：80m

衛星通信用アンテナ配置図

都市番号45 安徽省・蚌埠市（第一次No.20）

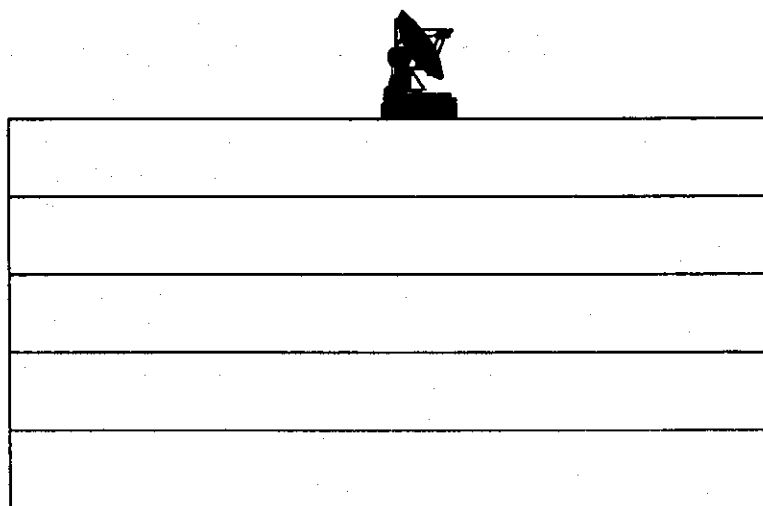
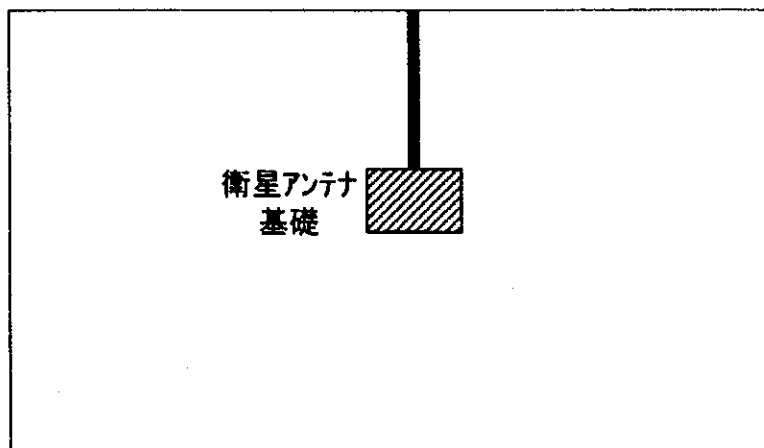

概算ケーブル長：80m

衛星通信用アンテナ配置図

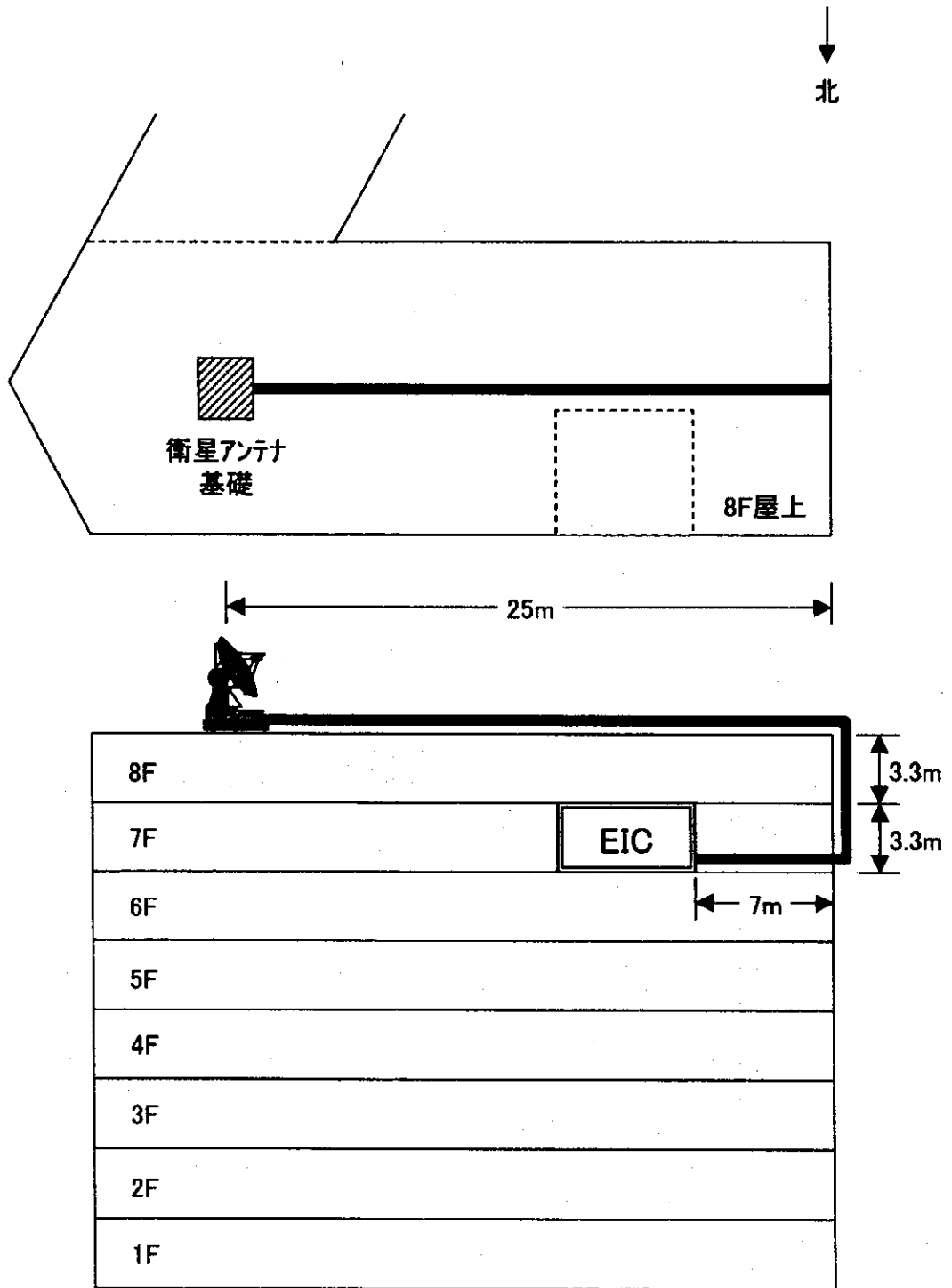

概算ケーブル長：80m

衛星通信用アンテナ配置図

都市番号47 福建省・泉州市 No.27

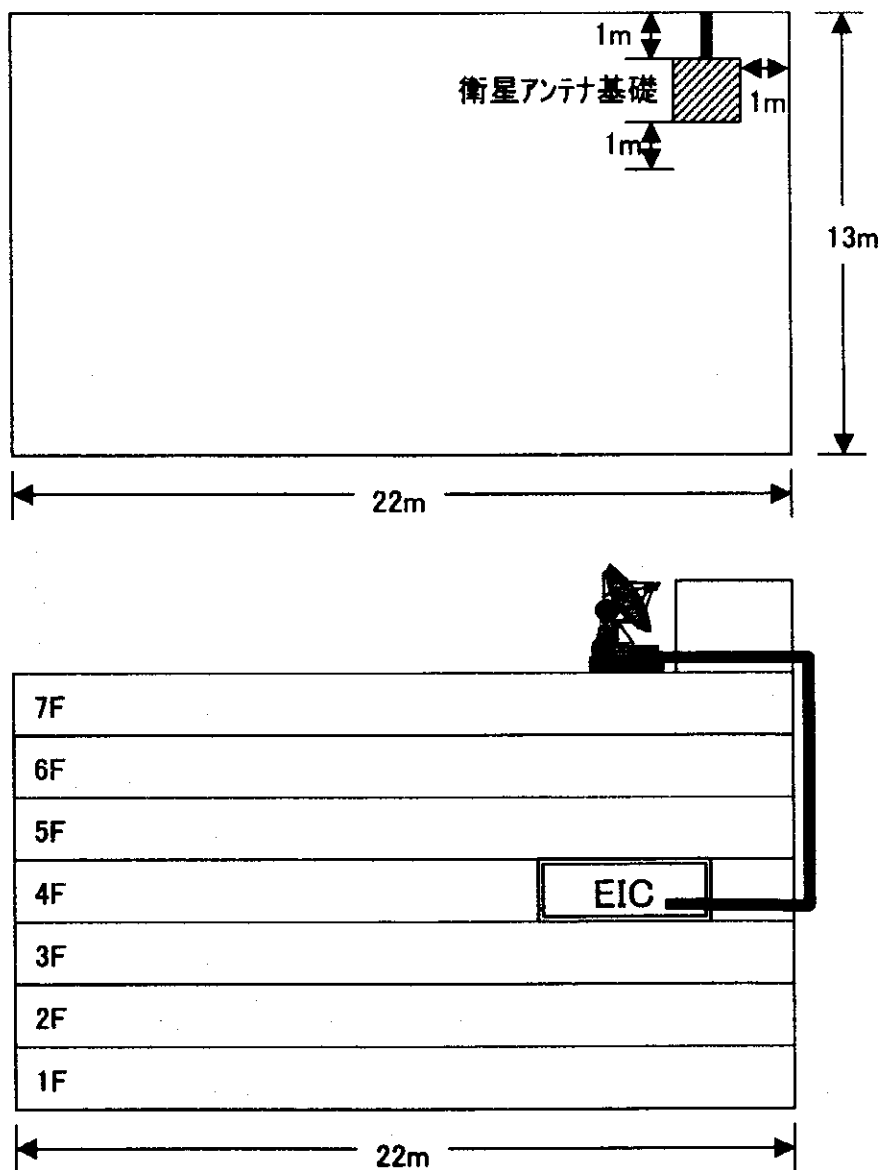

概算ケーブル長：80m

衛星通信用アンテナ配置図

都市番号48 福建省・三明市 No.28

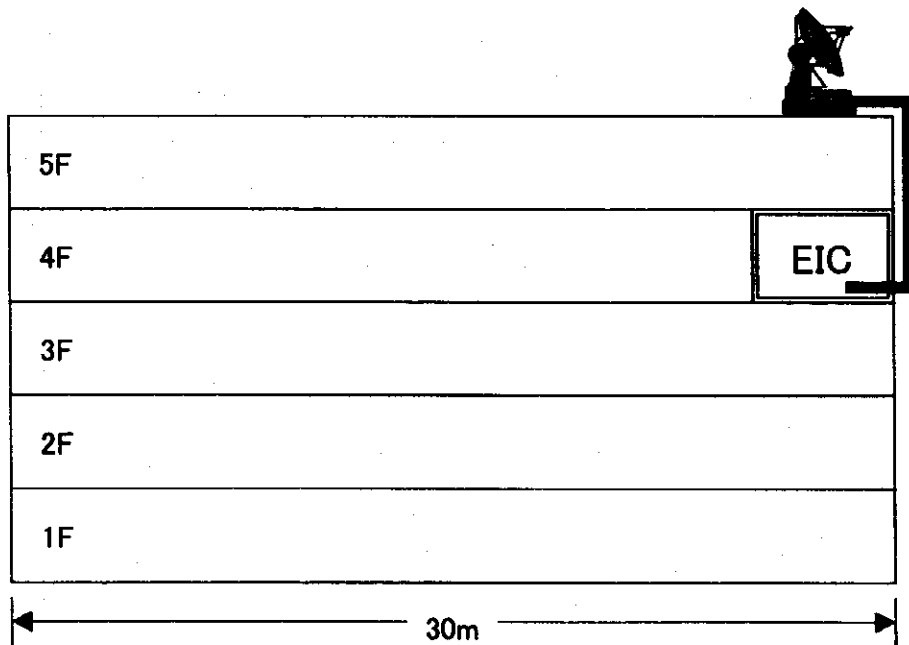
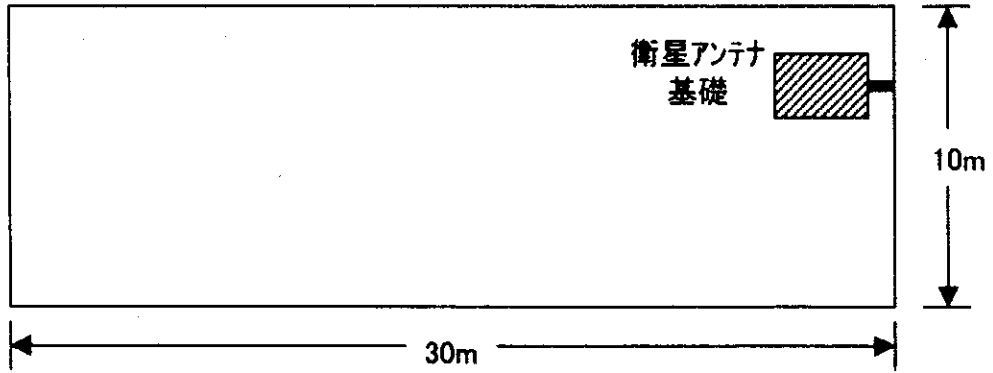

概算ケーブル長: 80m

衛星通信用アンテナ配置図

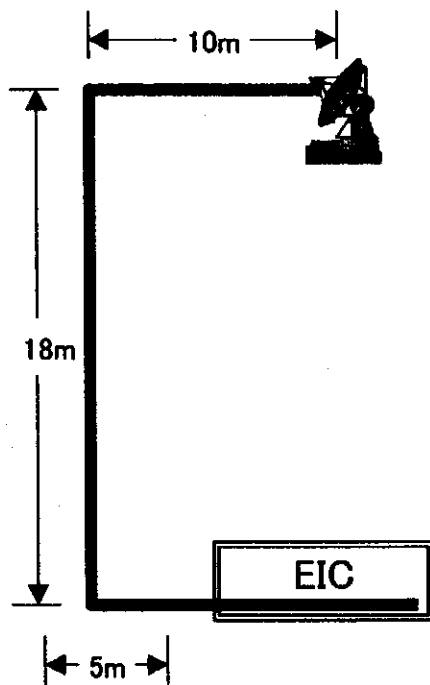
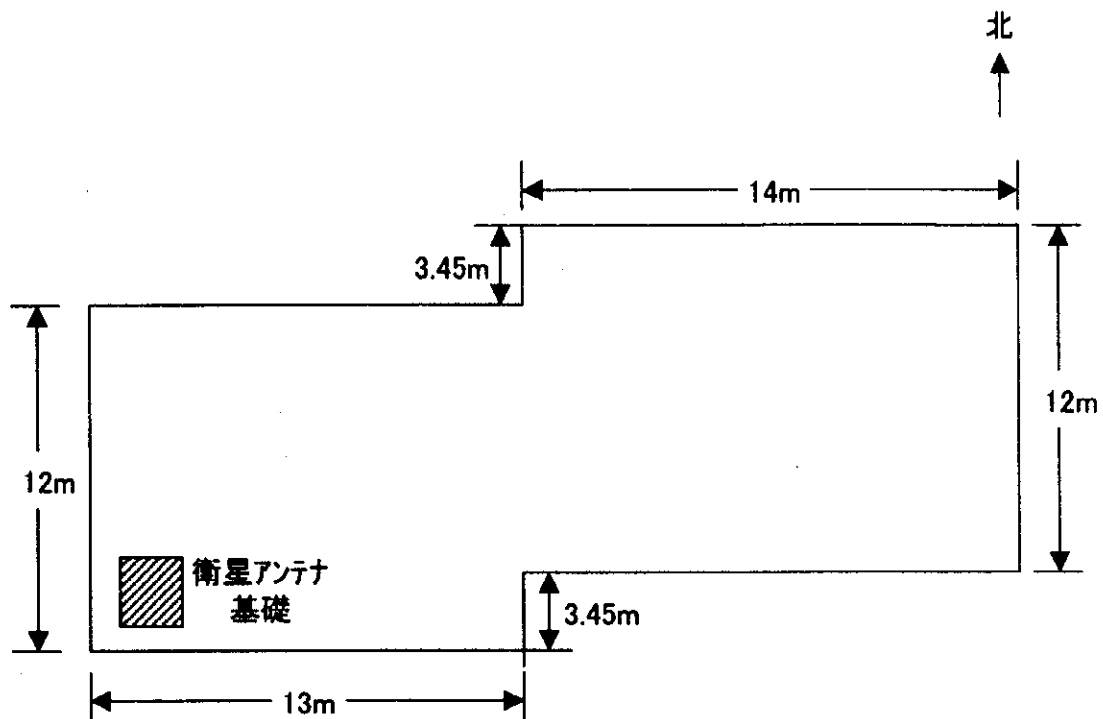

概算ケーブル長: 80m

衛星通信用アンテナ配置図

都市番号50 江西省・九江市 No.30

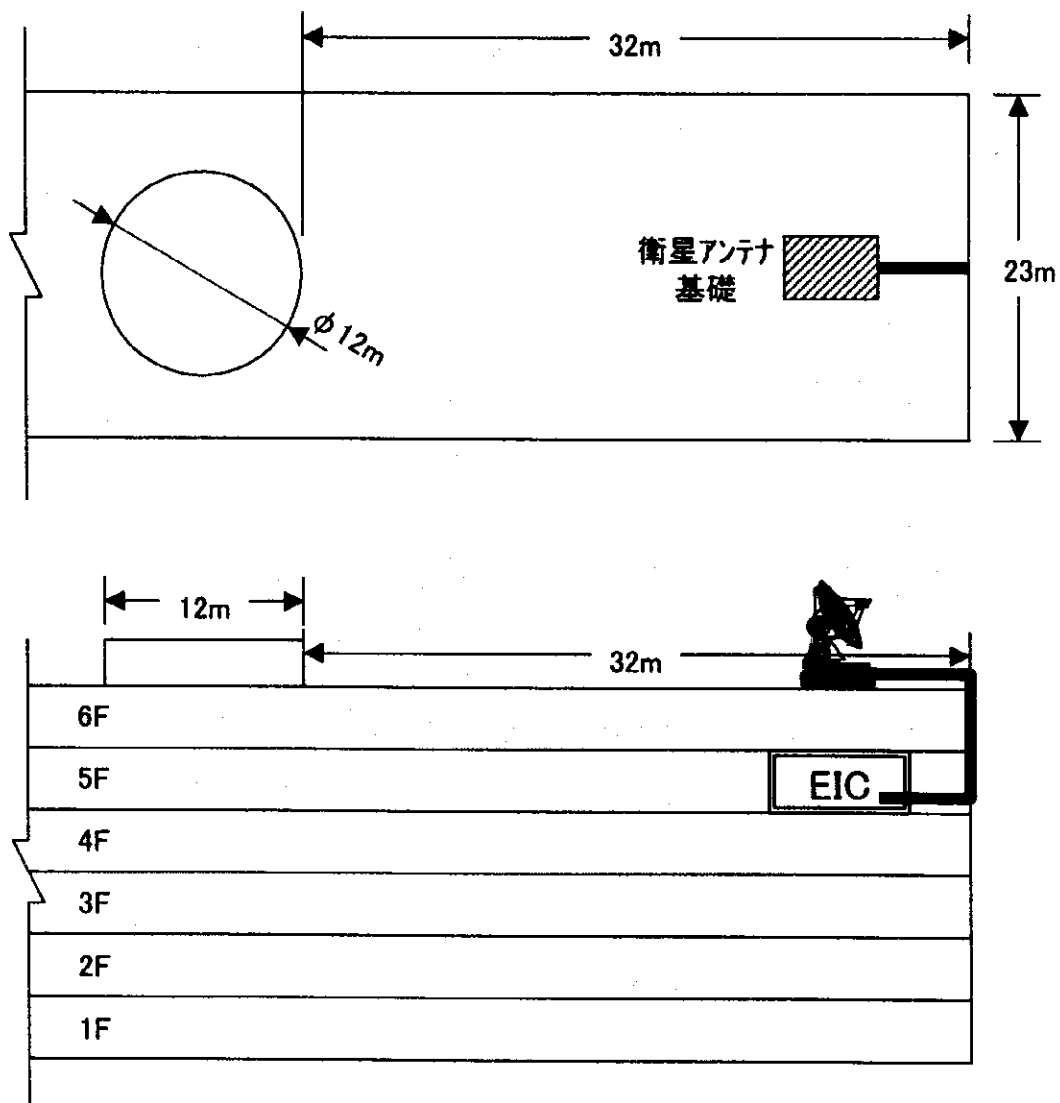

概算ケーブル長: 80m

衛星通信用アンテナ配置図

都市番号51 江西省・赣州市 No.31

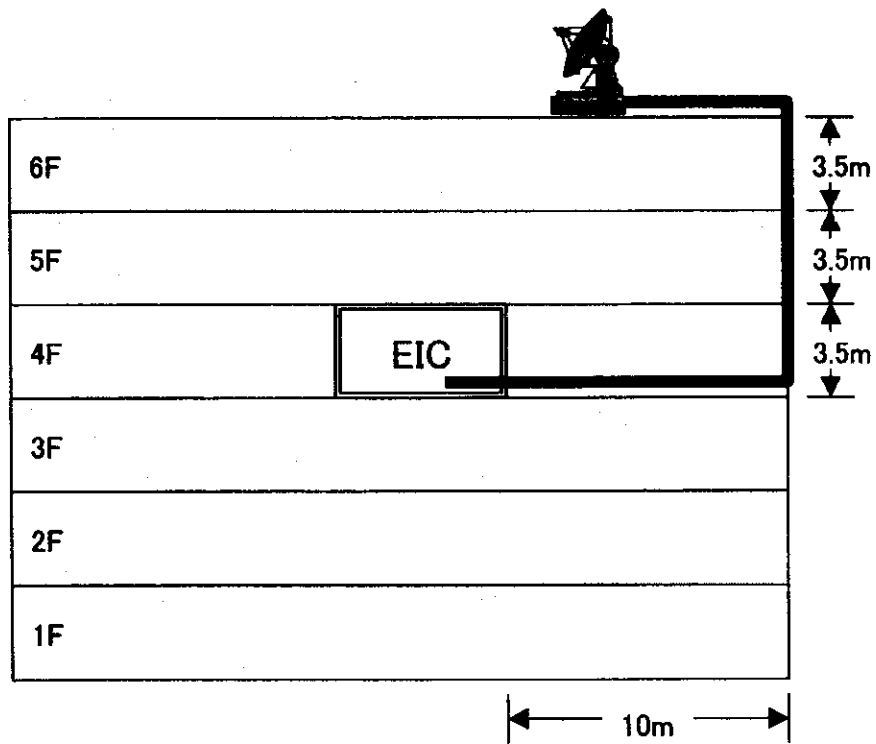
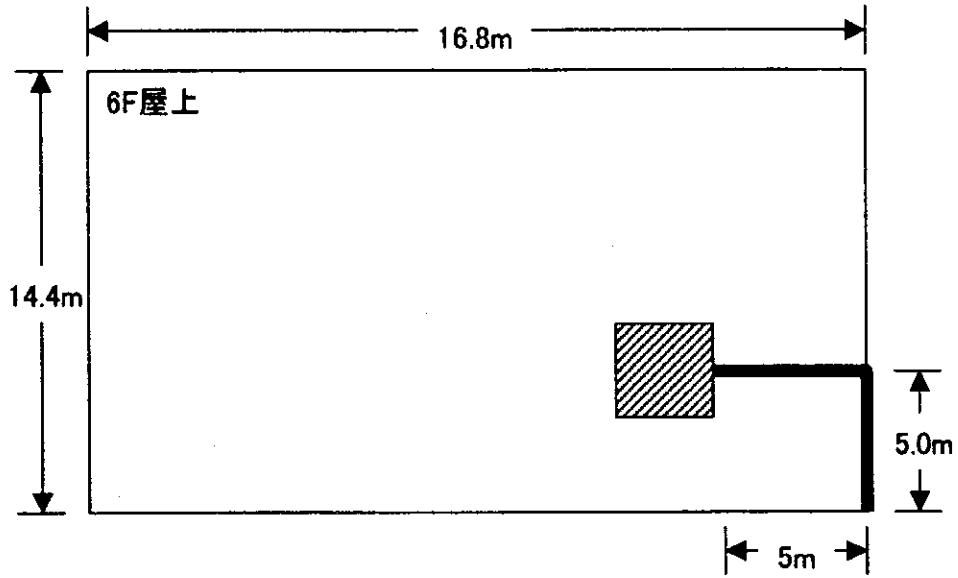

概算ケーブル長: 80m

衛星通信用アンテナ配置図

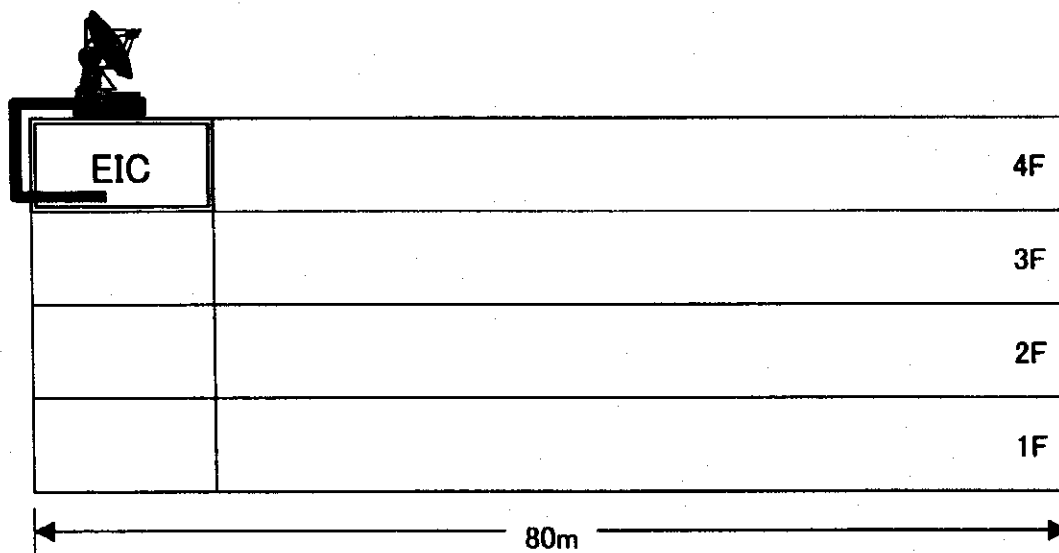
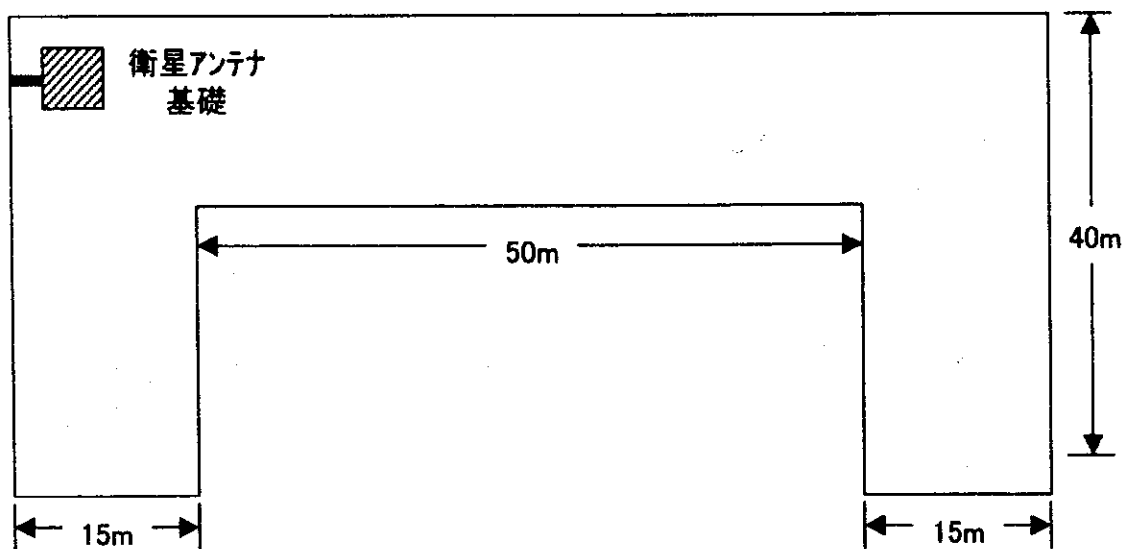

概算ケーブル長: 80m

衛星通信用アンテナ配置図

← 北

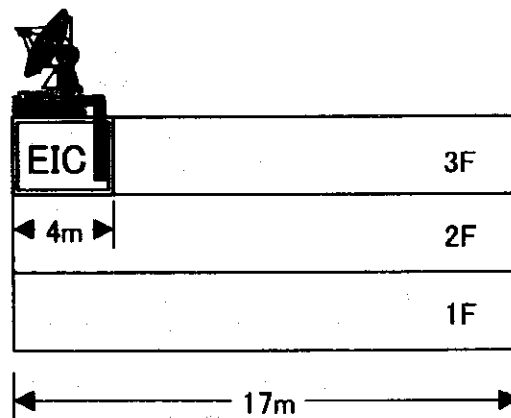
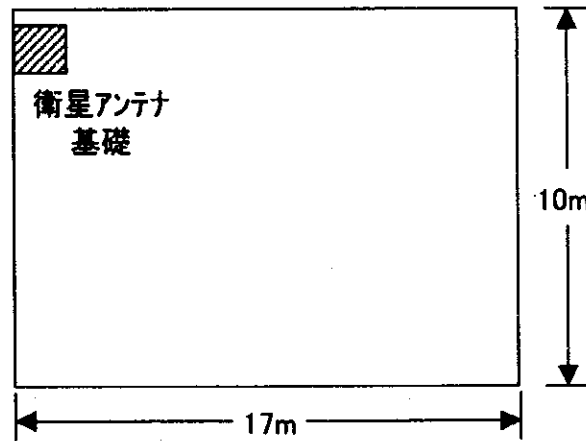

概算ケーブル長：80m

衛星通信用アンテナ配置図

都市番号55 山東省・棗庄市（第一次No.22）

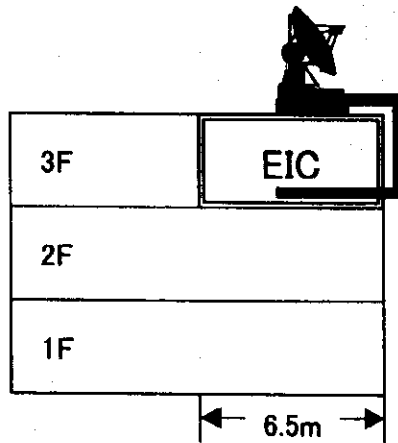
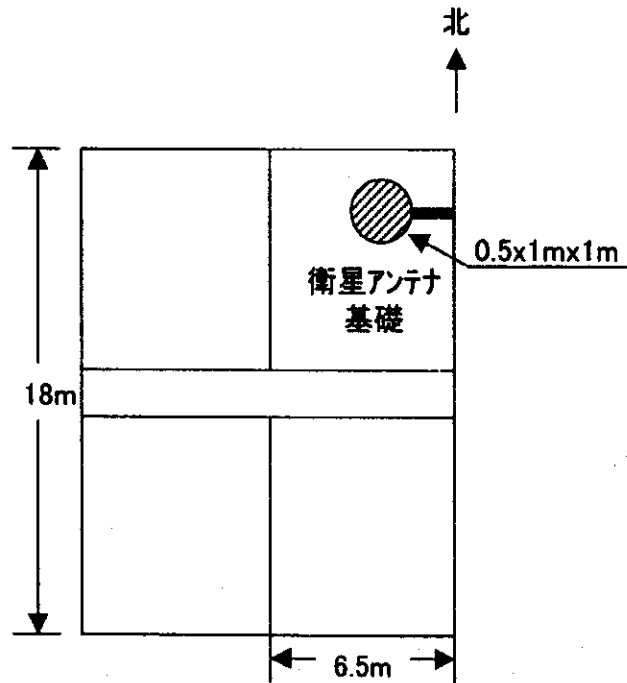

概算ケーブル長：80m

衛星通信用アンテナ配置図

都市番号56 山東省・済寧市（第一次No.23）

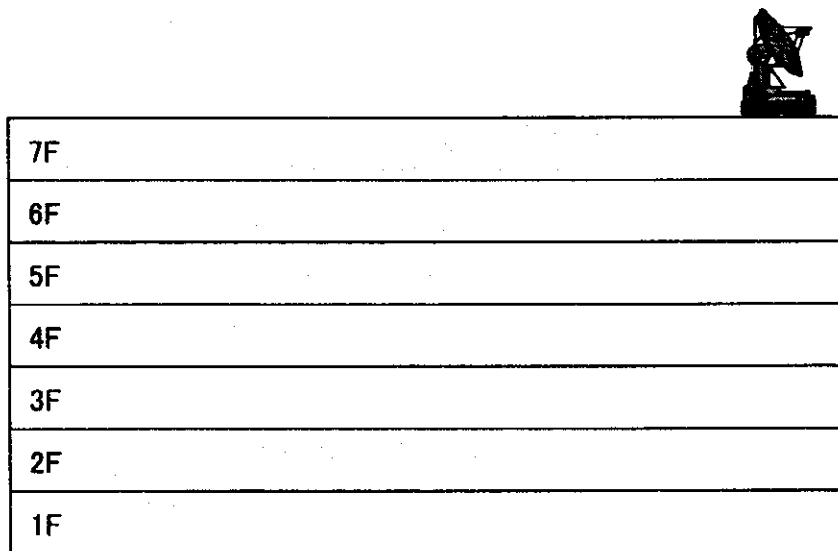
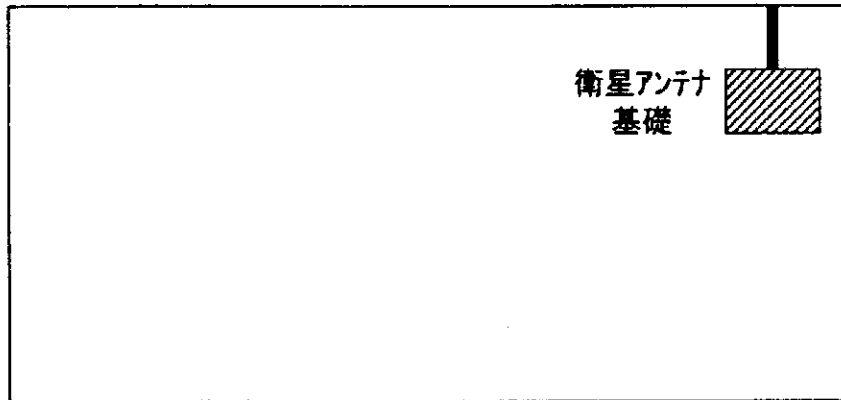

概算ケーブル長：80m

衛星通信用アンテナ配置図

都市番号58 河南省・開封市（第一次No.25）

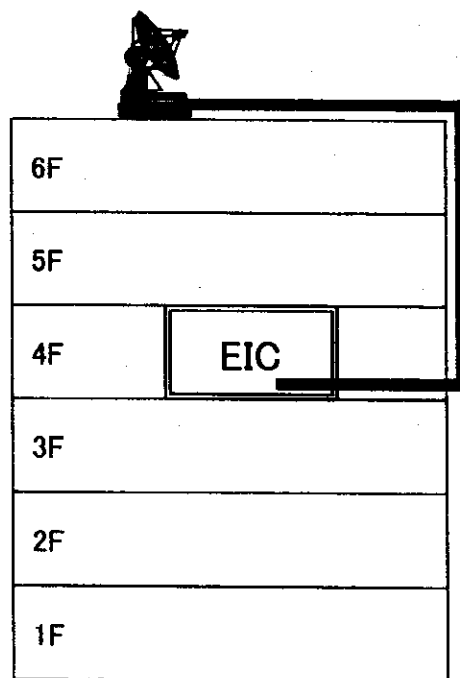
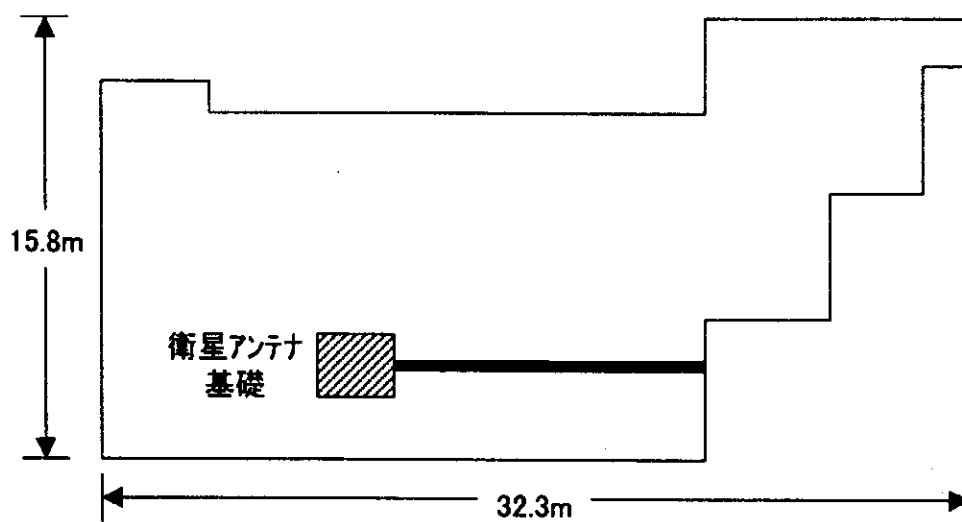

概算ケーブル長：80m

衛星通信用アンテナ配置図

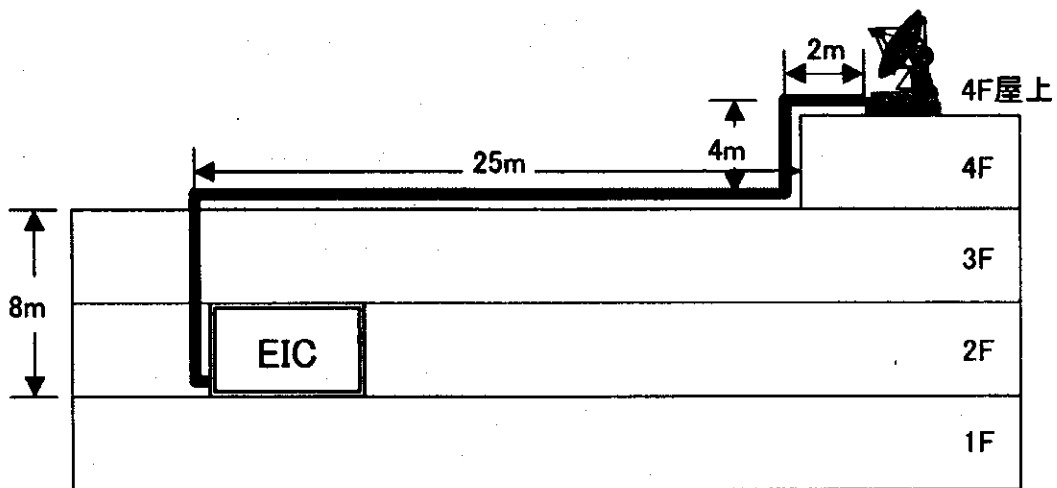
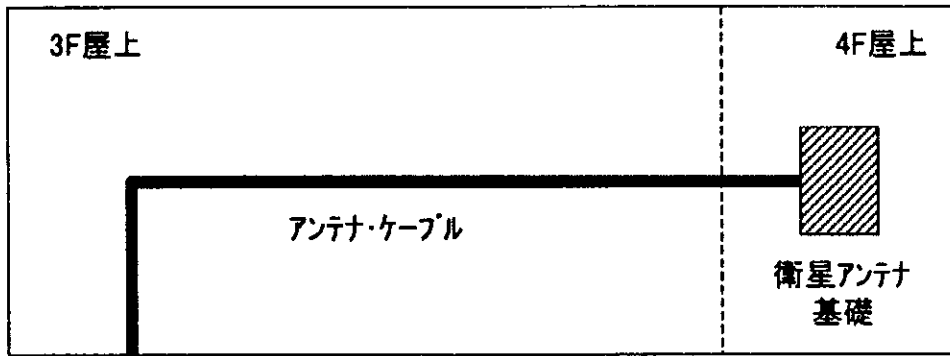

概算ケーブル長: 80m

衛星通信用アンテナ配置図

都市番号60 河南省・平頂山市（第一次No.26）

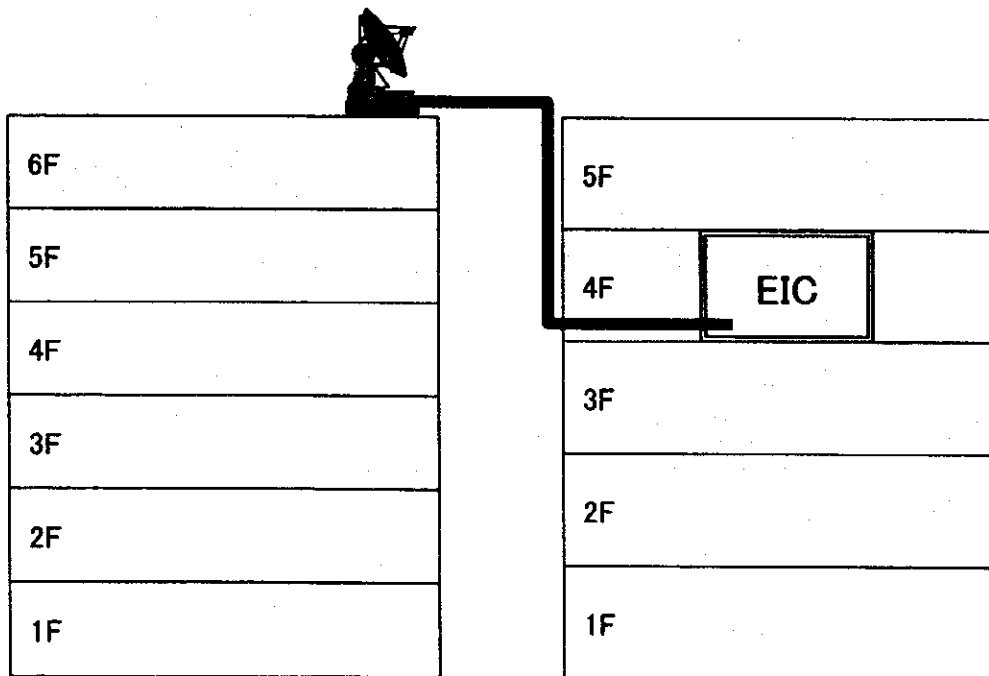

概算ケーブル長：80m

衛星通信用アンテナ配置図

北 ←

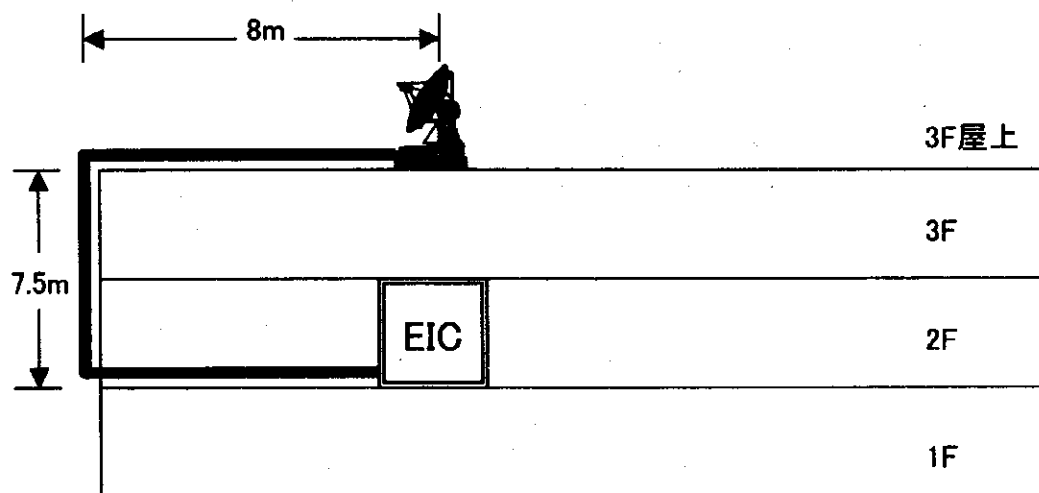
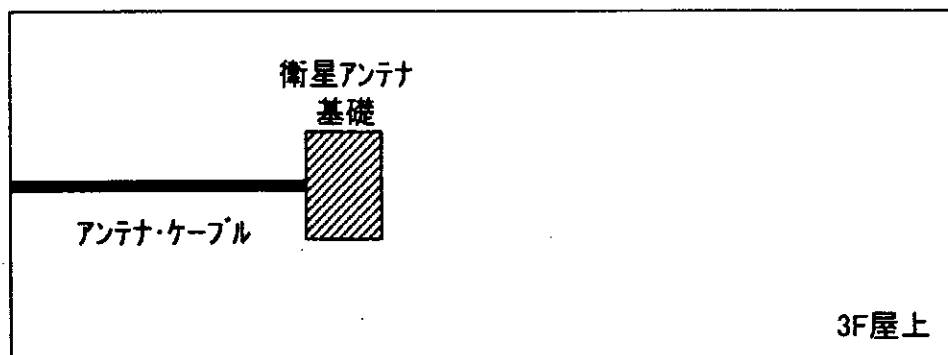

概算ケーブル長：80m

衛星通信用アンテナ配置図

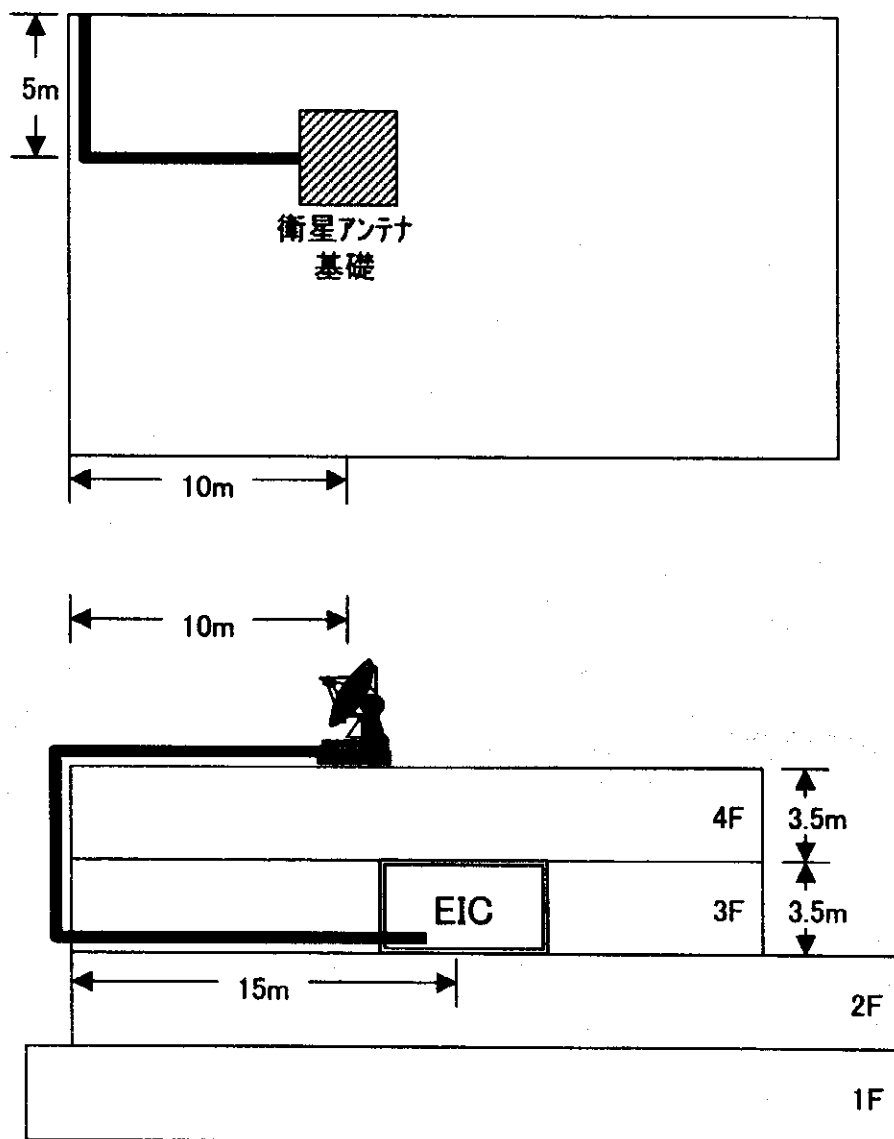

概算ケーブル長：80m

衛星通信用アンテナ配置図

都市番号63 湖北省・黄石市 No.37

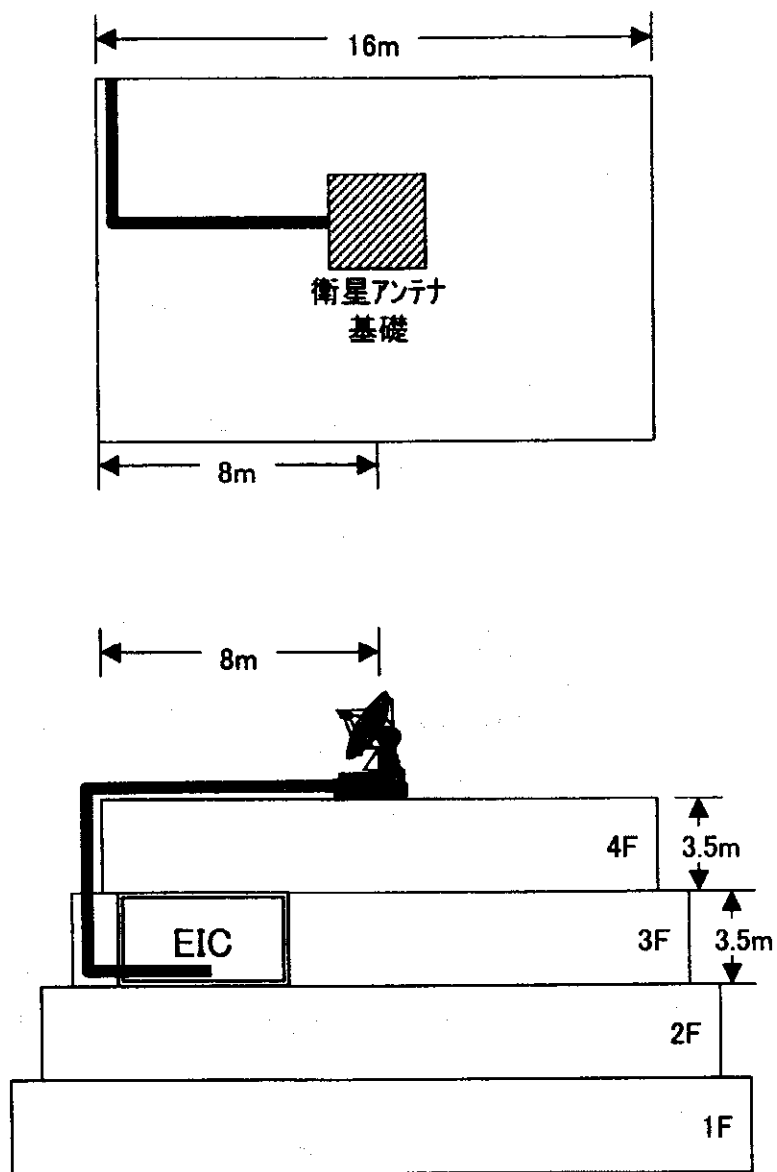

概算ケーブル長：80m

衛星通信用アンテナ配置図

北 ←

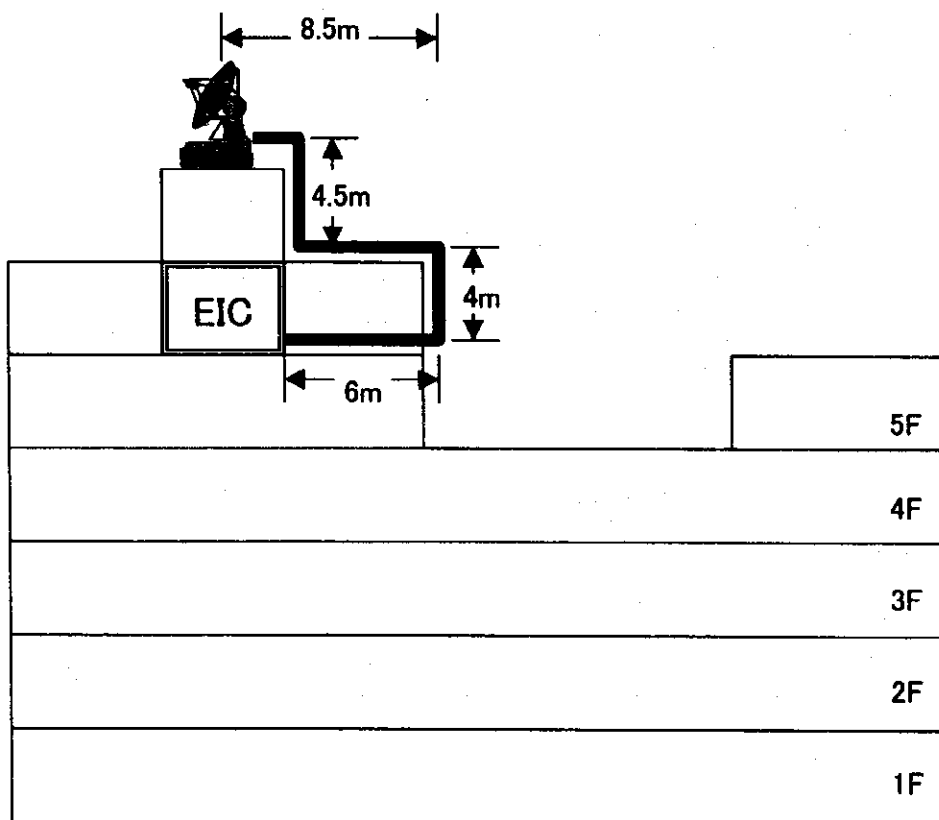
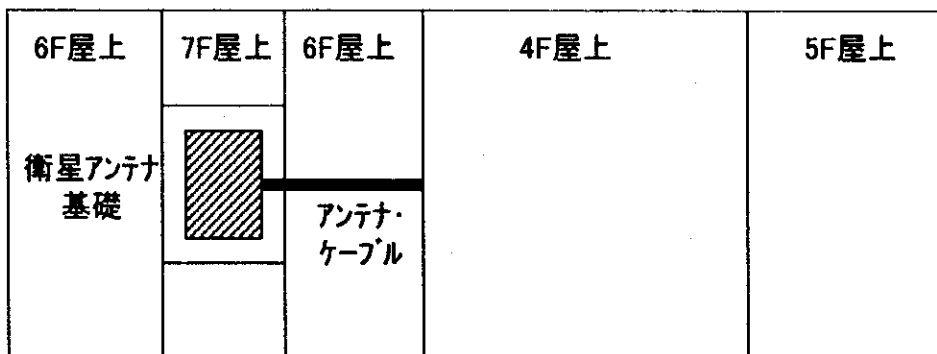

概算ケーブル長：80m

衛星通信用アンテナ配置図

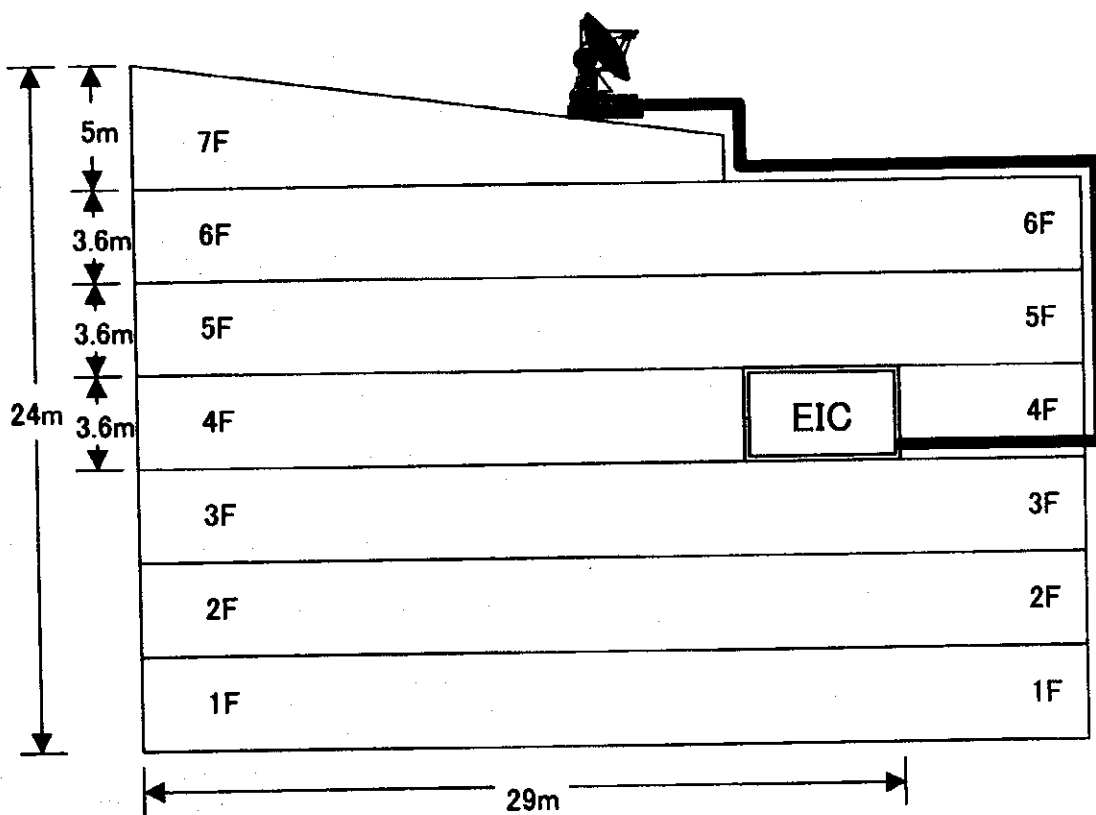
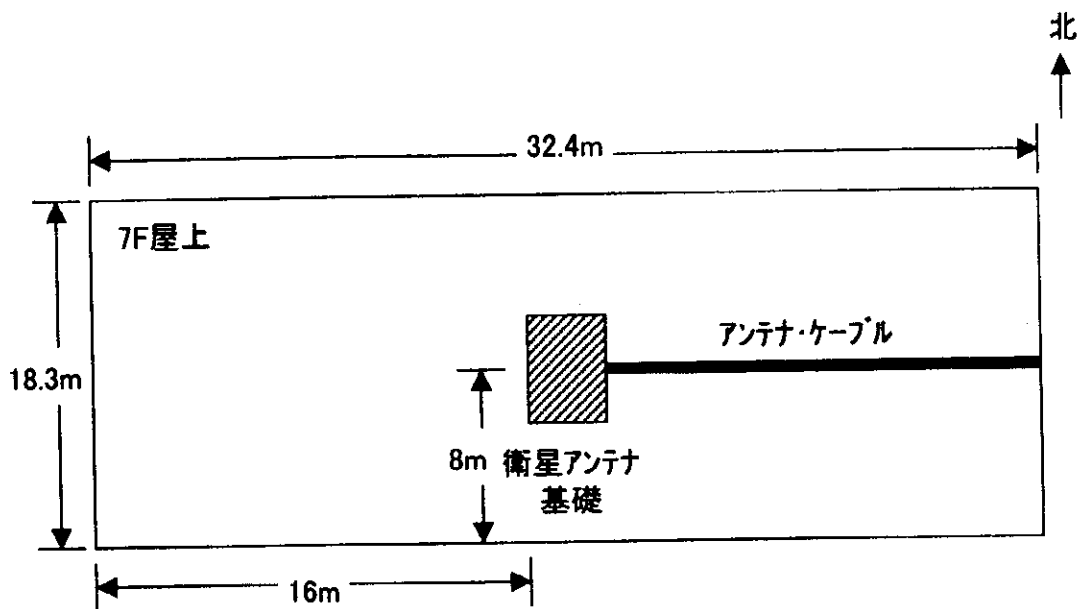

概算ケーブル長: 80m

衛星通信用アンテナ配置図

都市番号66 湖南省・長沙市 (第一次No.27)

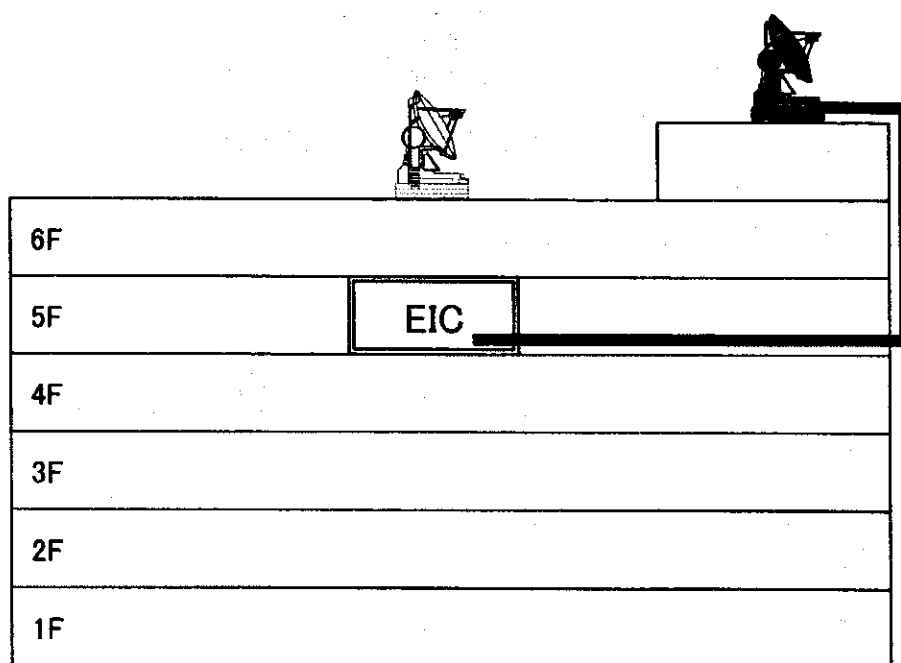

概算ケーブル長: 80m

衛星通信用アンテナ配置図

都市番号67 湖南省・衡陽市 No.40

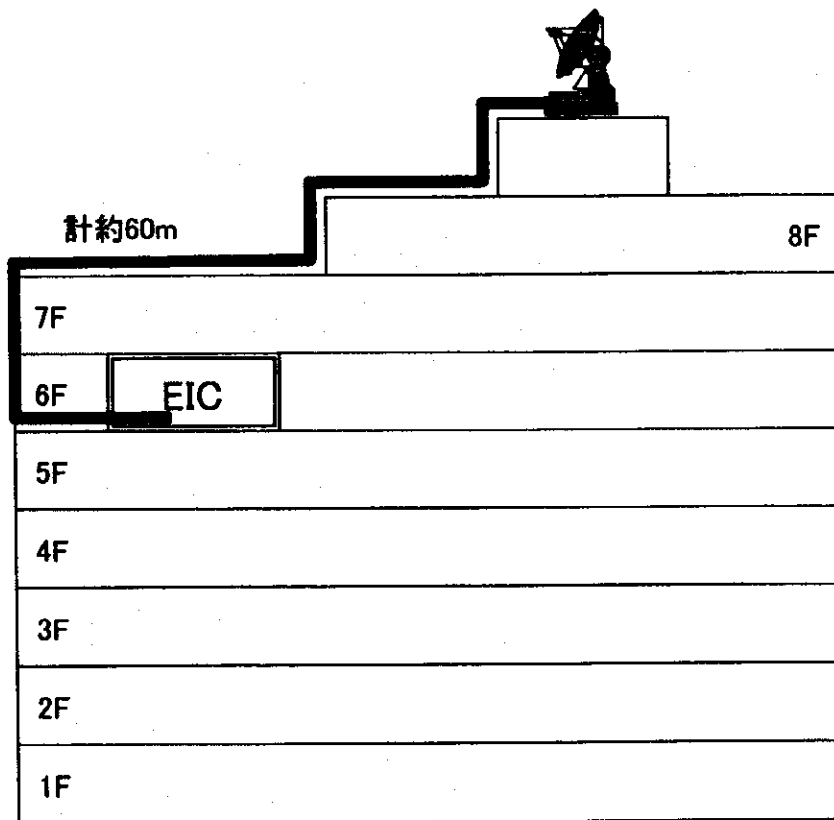
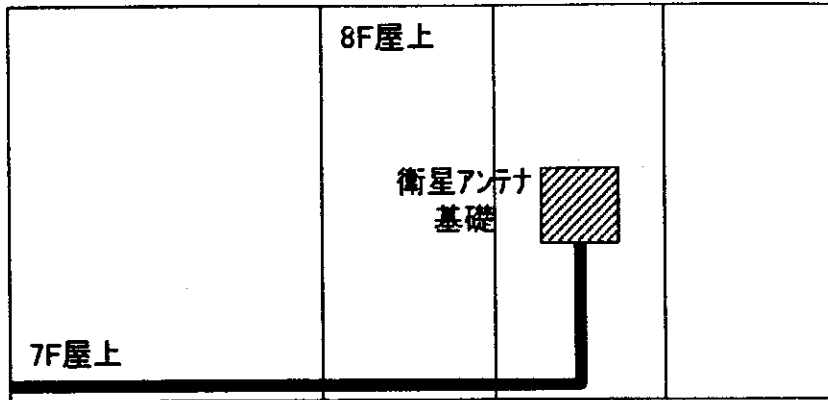

概算ケーブル長：80m

衛星通信用アンテナ配置図

都市番号68 湖南省・岳陽市 No.41

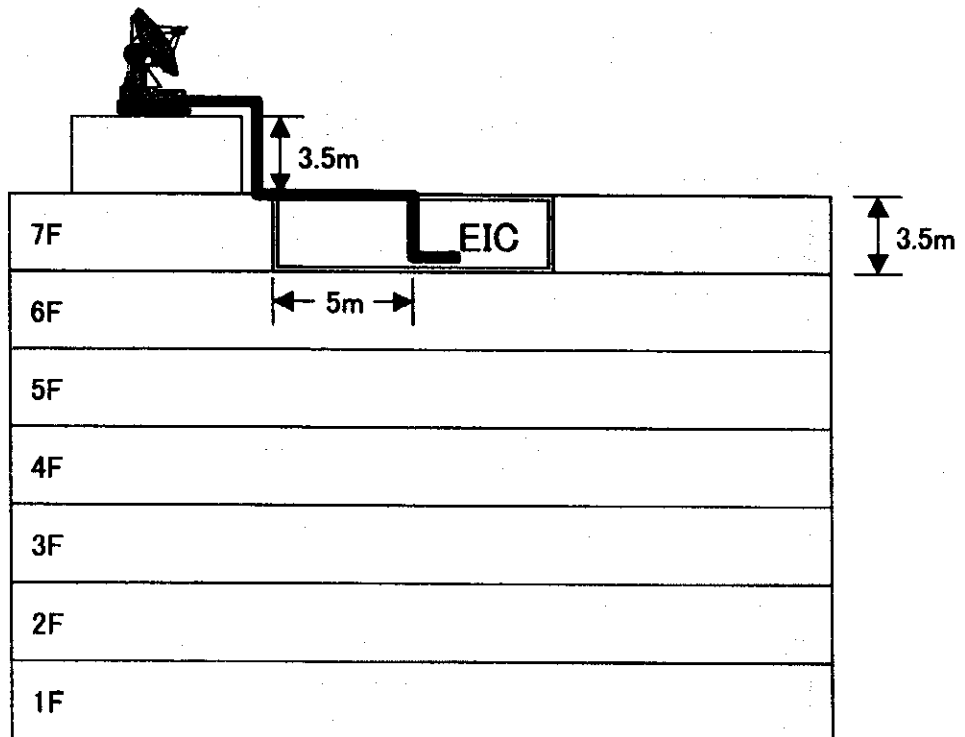
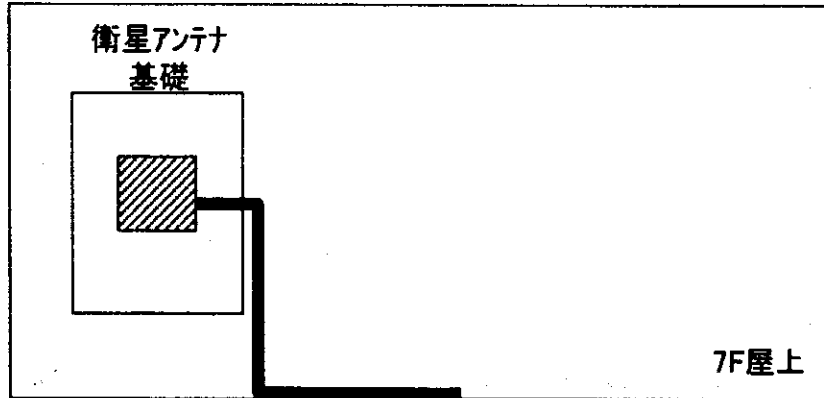

概算ケーブル長：80m

衛星通信用アンテナ配置図

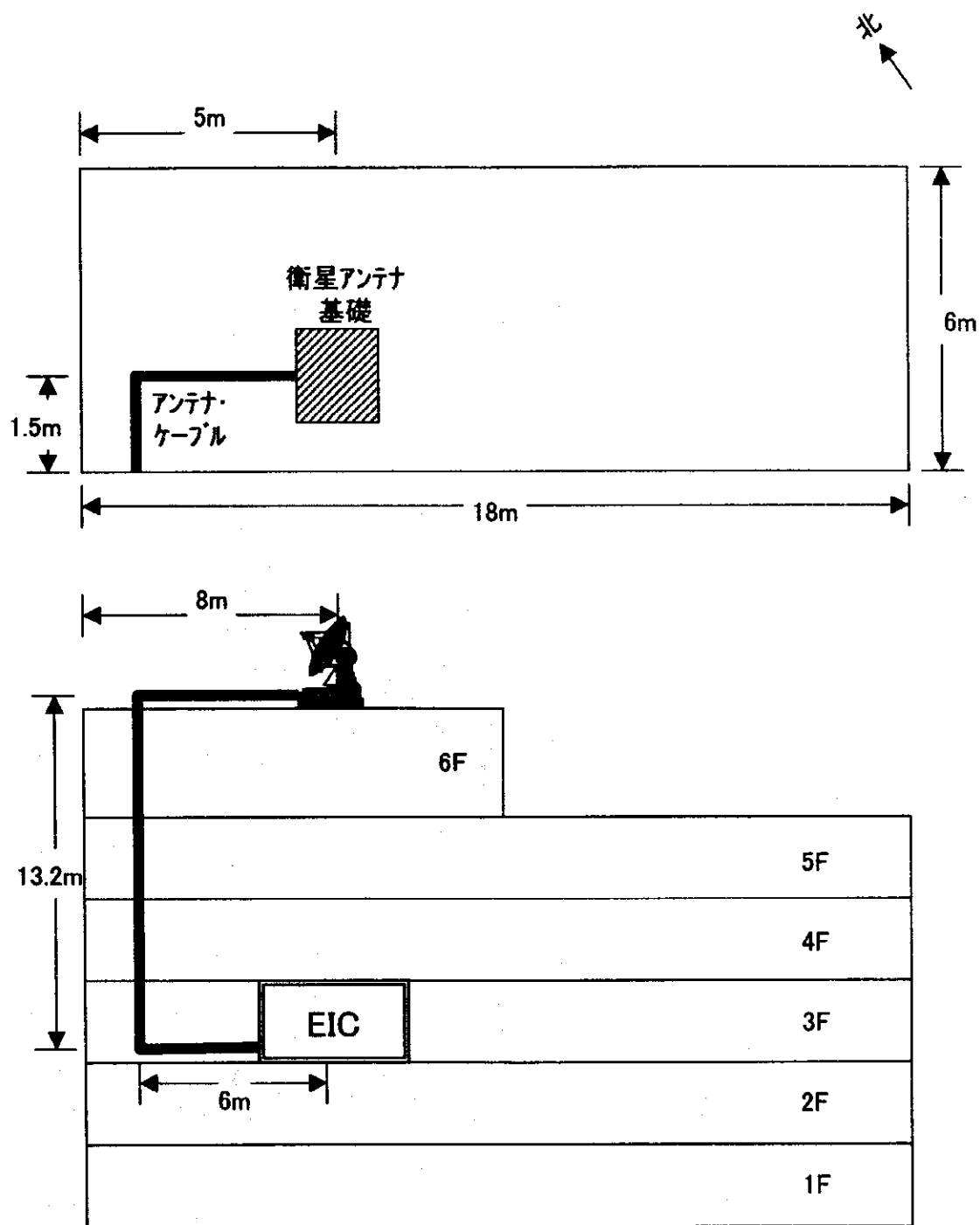

概算ケーブル長：80m

衛星通信用アンテナ配置図

都市番号72 広東省・肇慶市 No.43

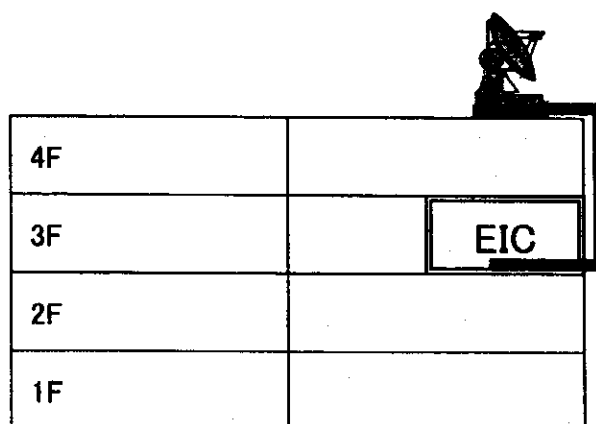
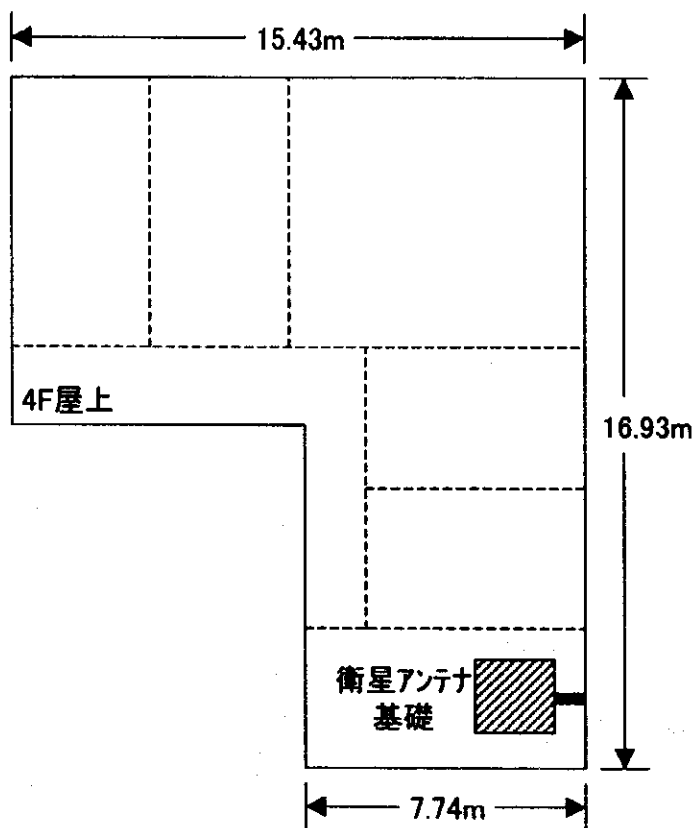

概算ケーブル長: 80m

衛星通信用アンテナ配置図

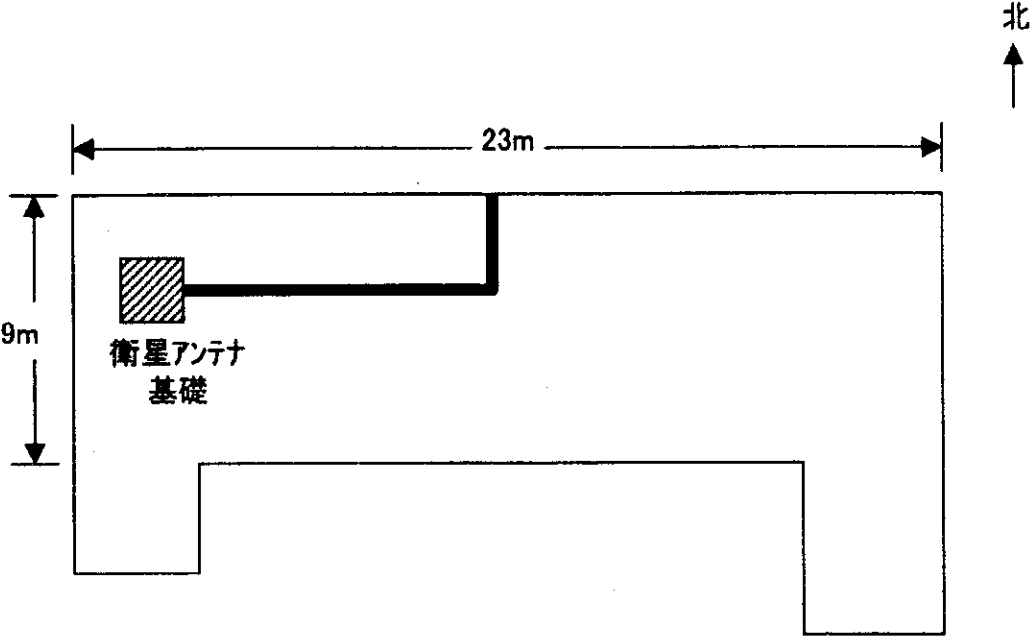

概算ケーブル長: 80m

衛星通信用アンテナ配置図

都市番号75 広西自治区・南寧市（第一次No.31）

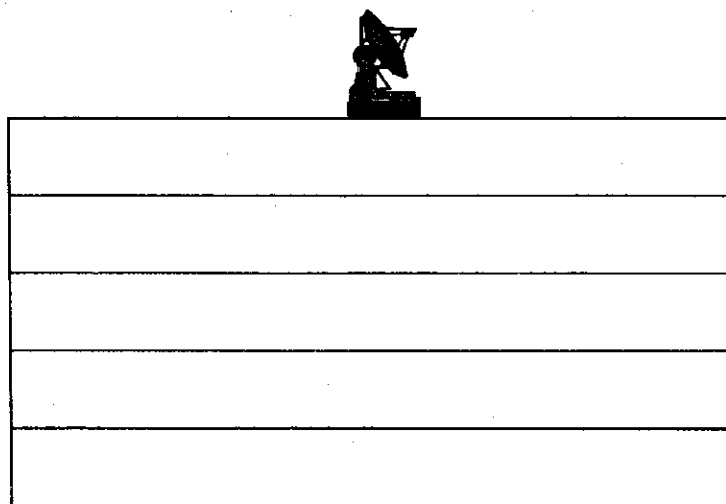
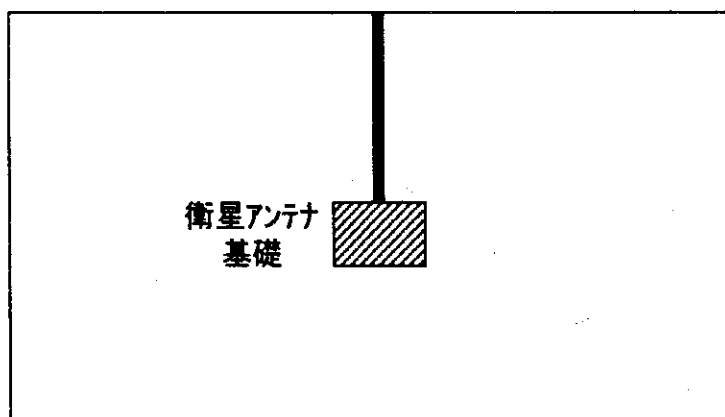

概算ケーブル長：80m

衛星通信用アンテナ配置図

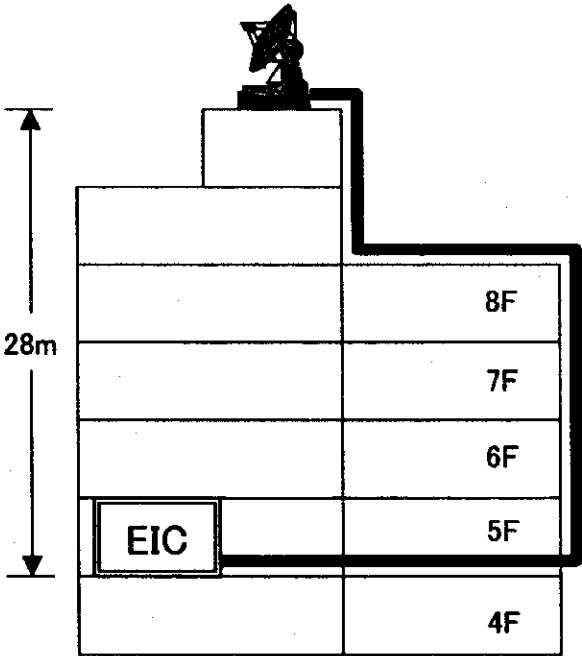
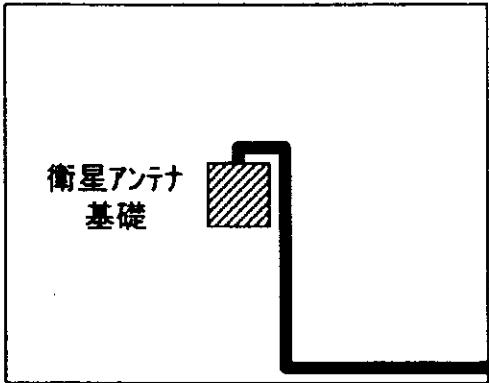

概算ケーブル長: 80m

衛星通信用アンテナ配置図

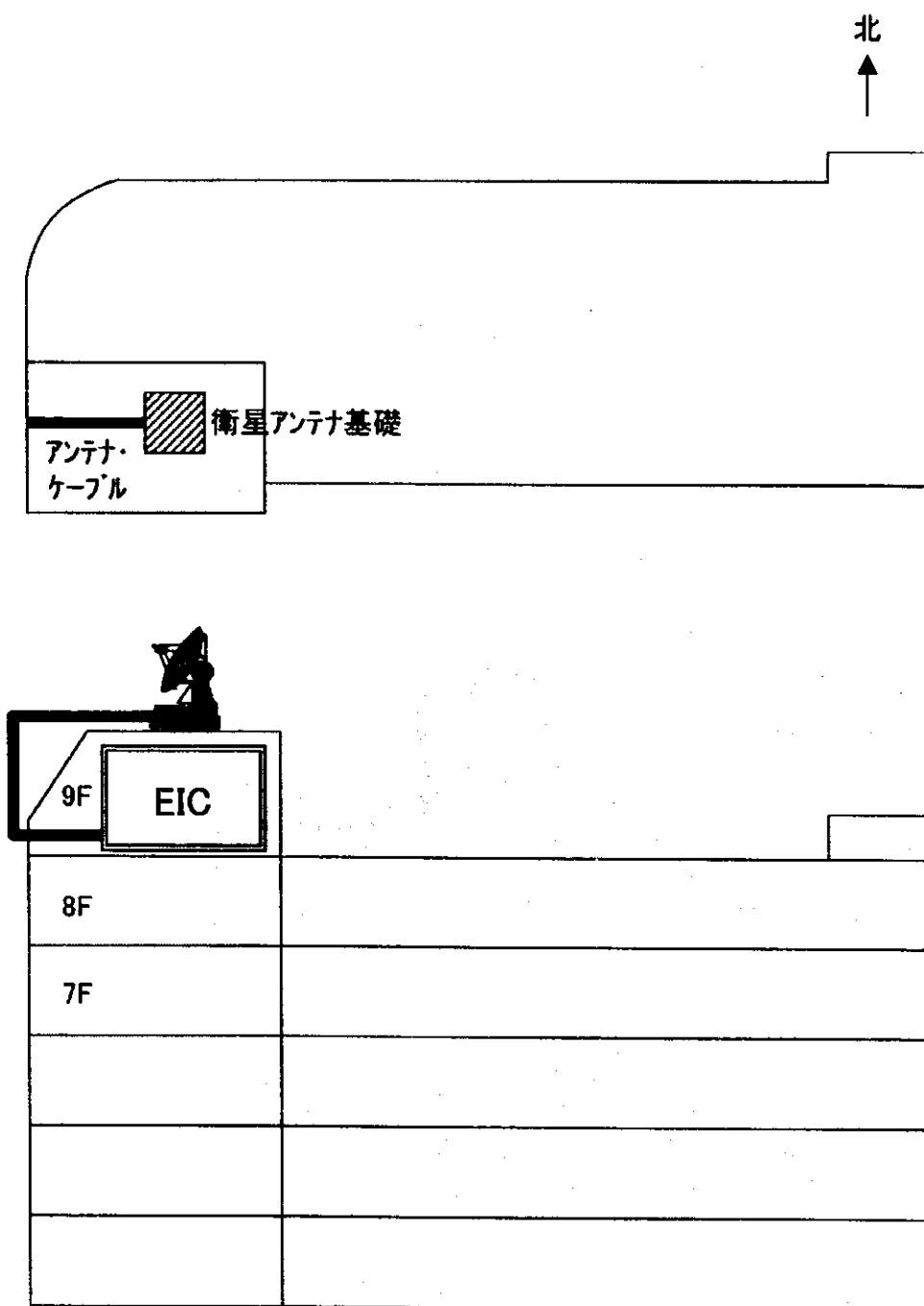

概算ケーブル長: 80m

衛星通信用アンテナ配置図

都市番号78 海南省・三亚市 (第一次No.32)

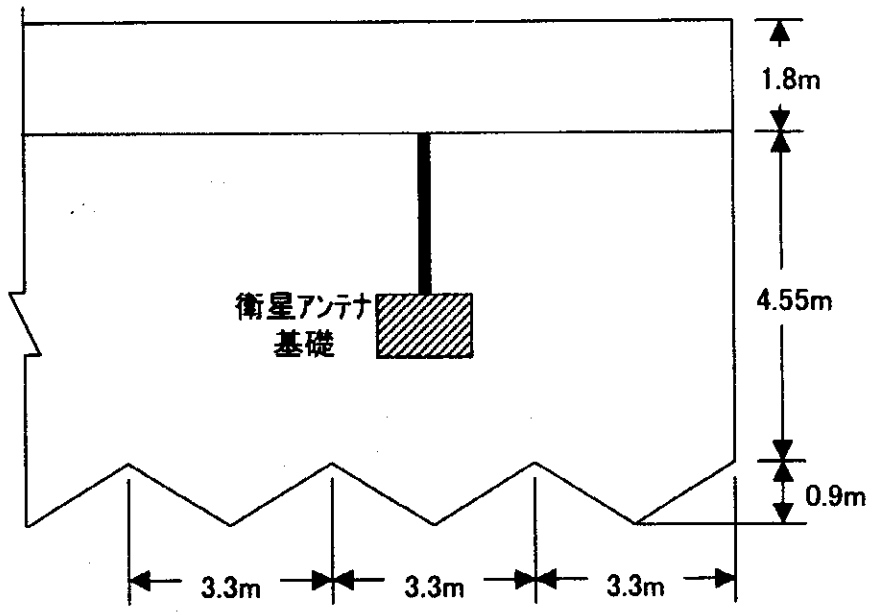

概算ケーブル長: 80m

衛星通信用アンテナ配置図

都市番号79 四川省・成都市（第一次No.33）

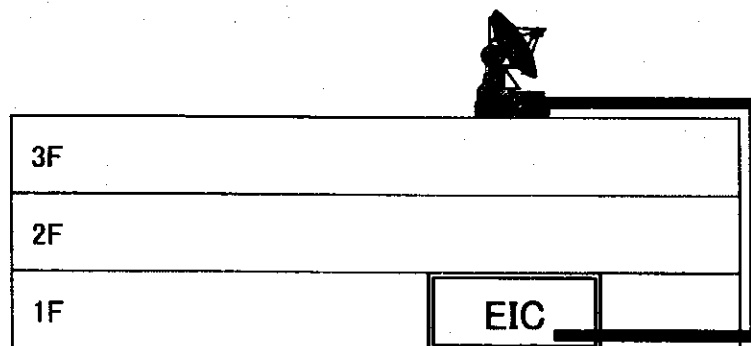
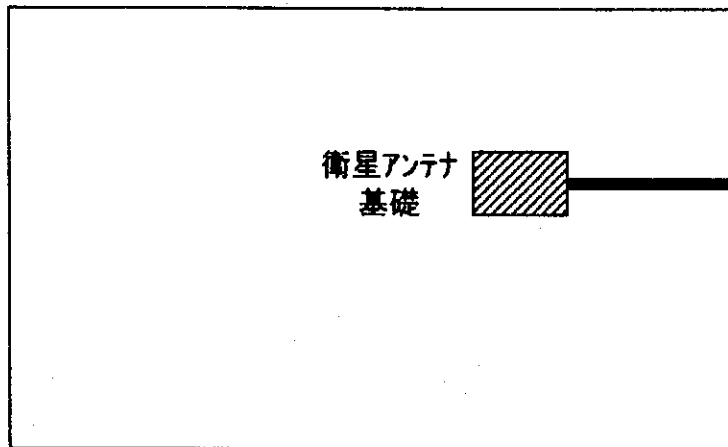

概算ケーブル長：80m

衛星通信用アンテナ配置図

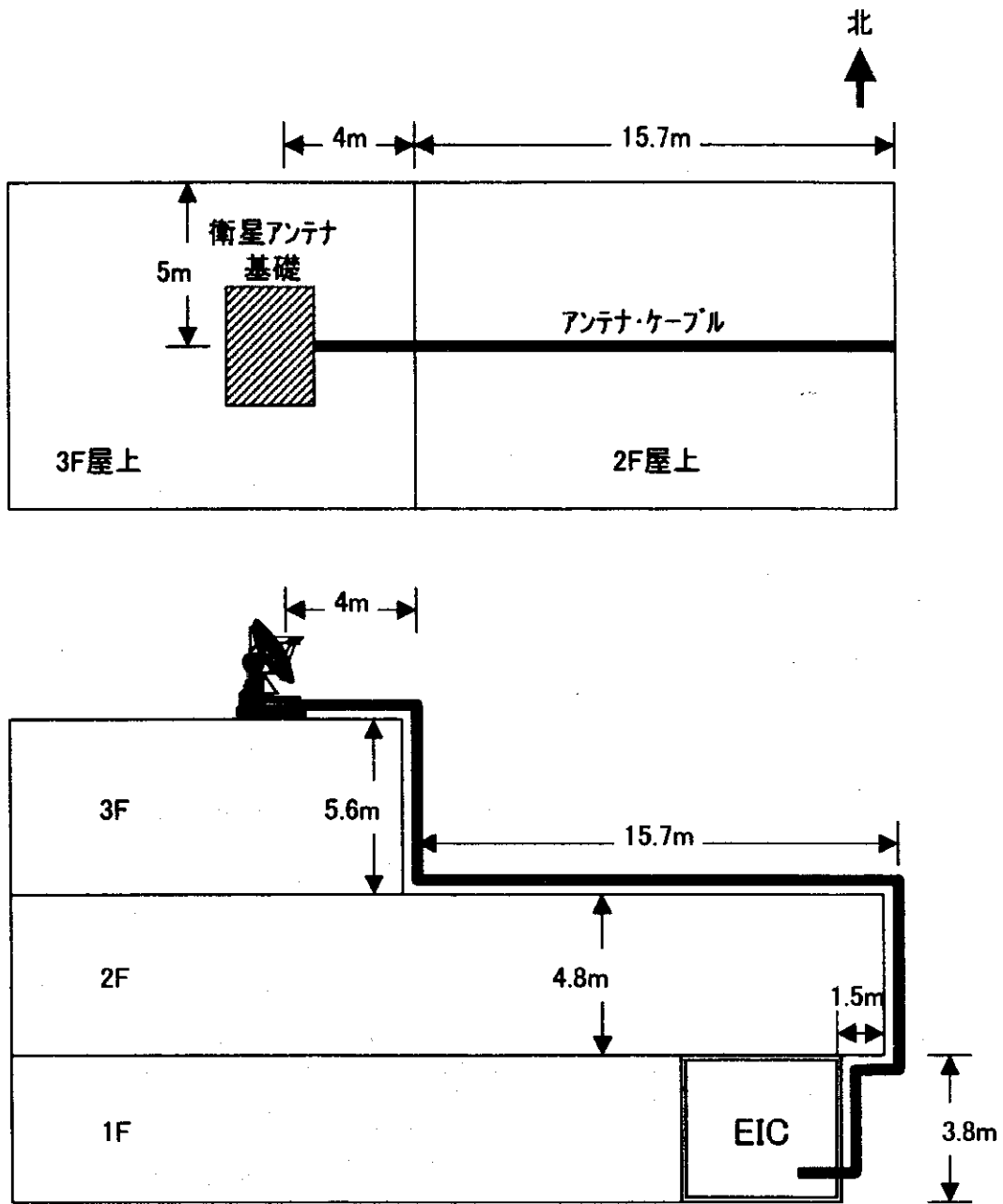

概算ケーブル長: 80m

衛星通信用アンテナ配置図

→ 北

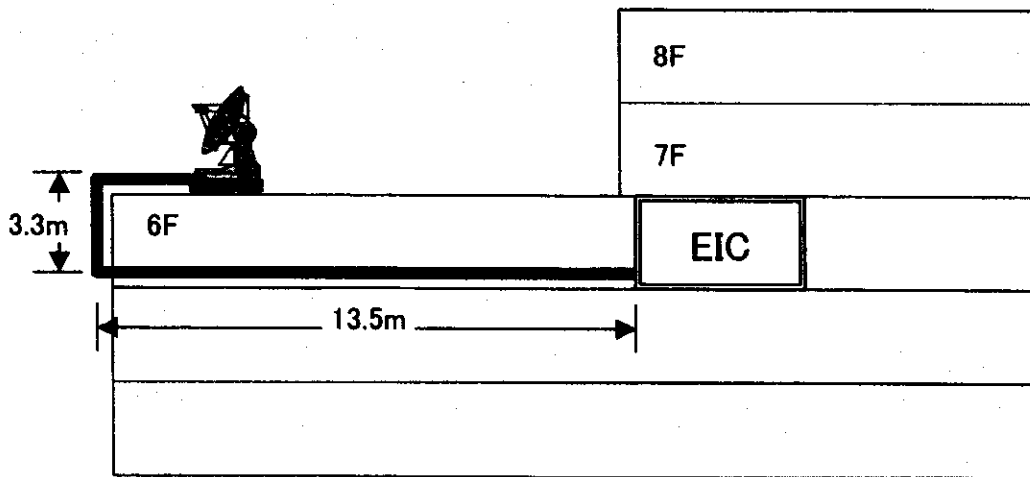
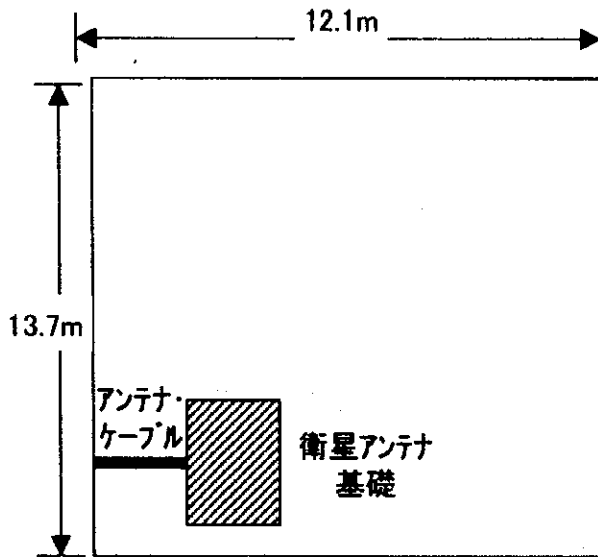

概算ケーブル長：80m

衛星通信用アンテナ配置図

都市番号82 貴州省・貴陽市（第一次No.34）

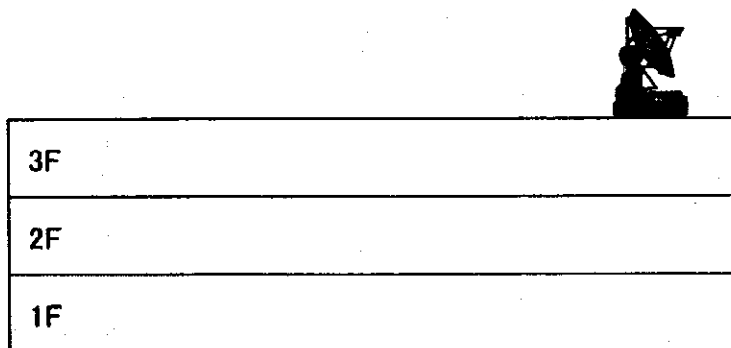
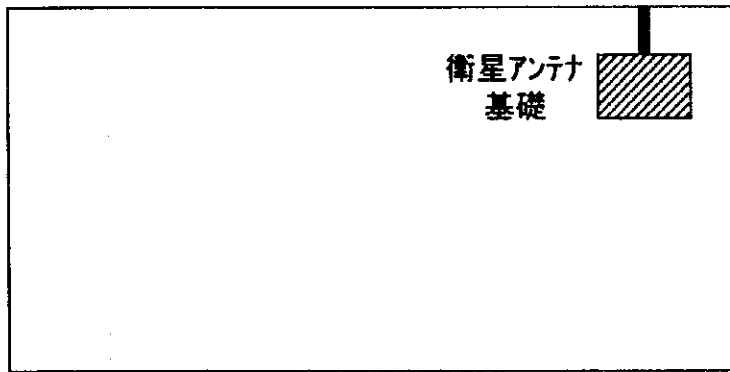

概算ケーブル長：80m

衛星通信用アンテナ配置図

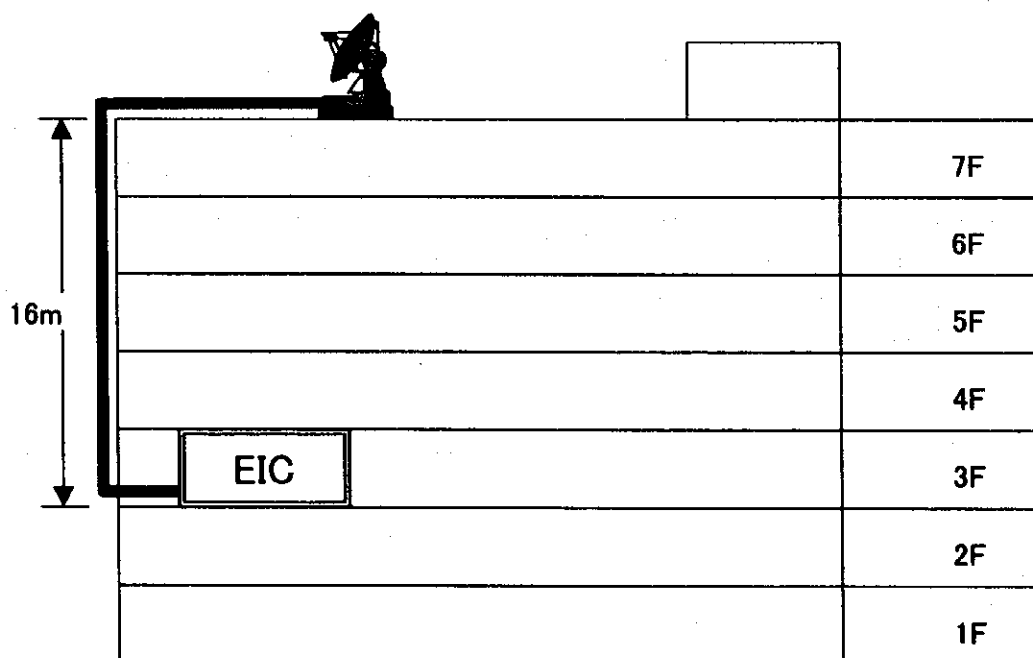
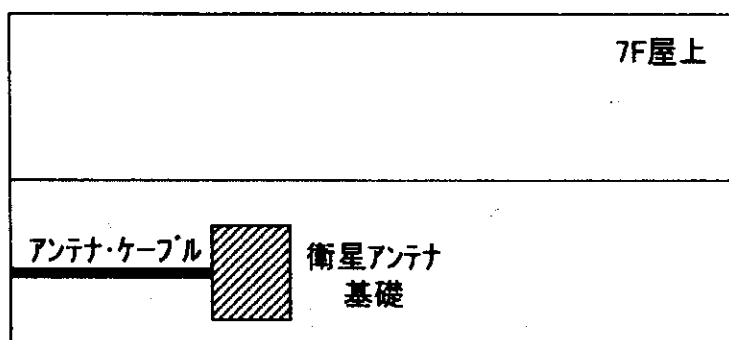

概算ケーブル長: 80m

衛星通信用アンテナ配置図

都市番号84 雲南省・昆明市（第一次No.35）

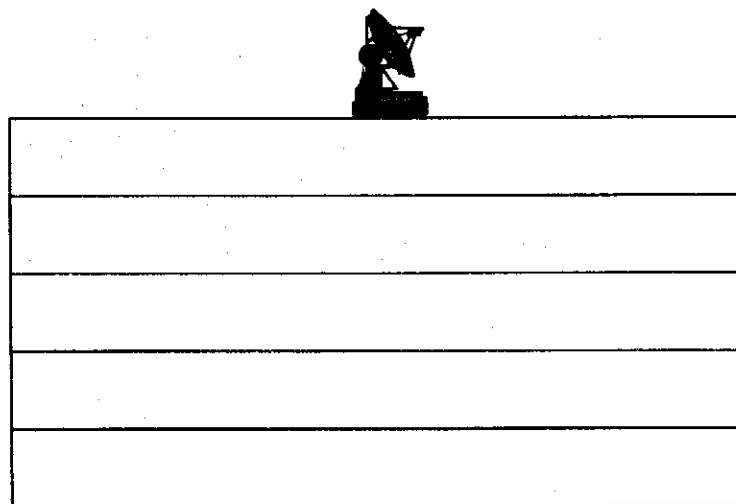
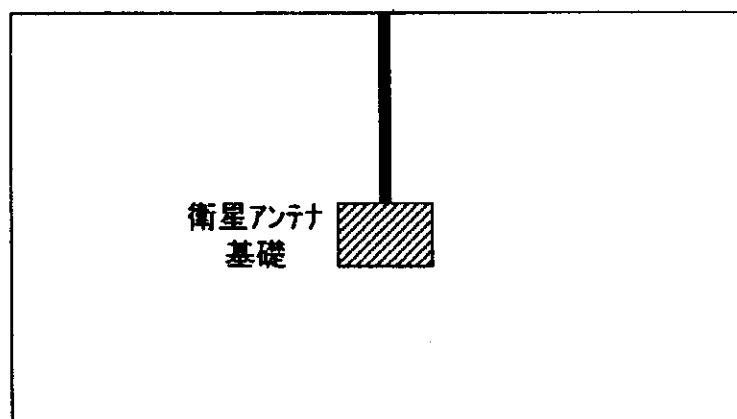

概算ケーブル長：80m

衛星通信用アンテナ配置図

→ 北

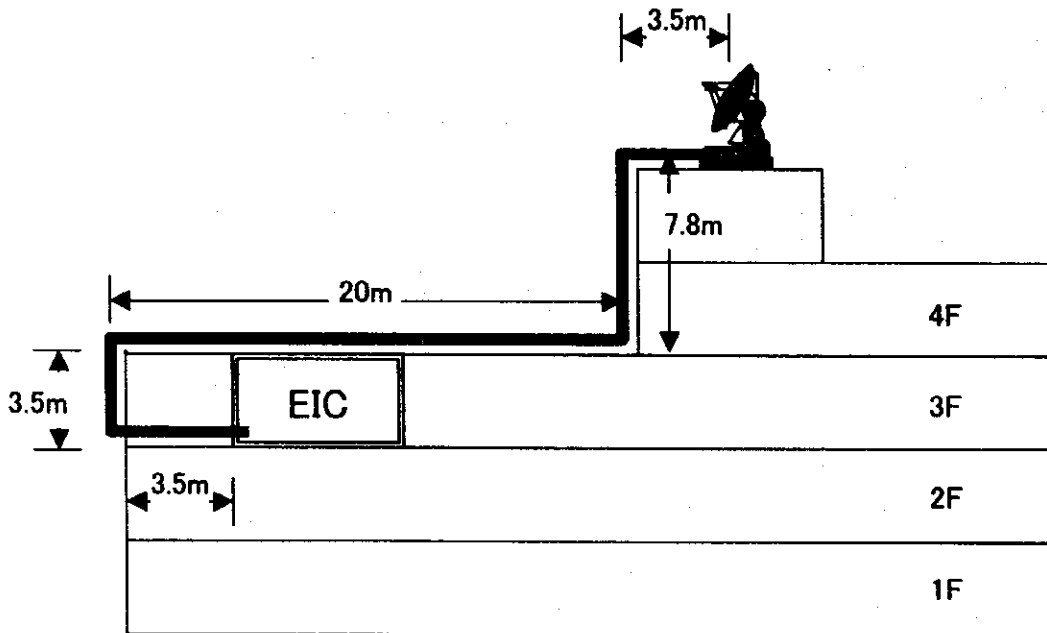
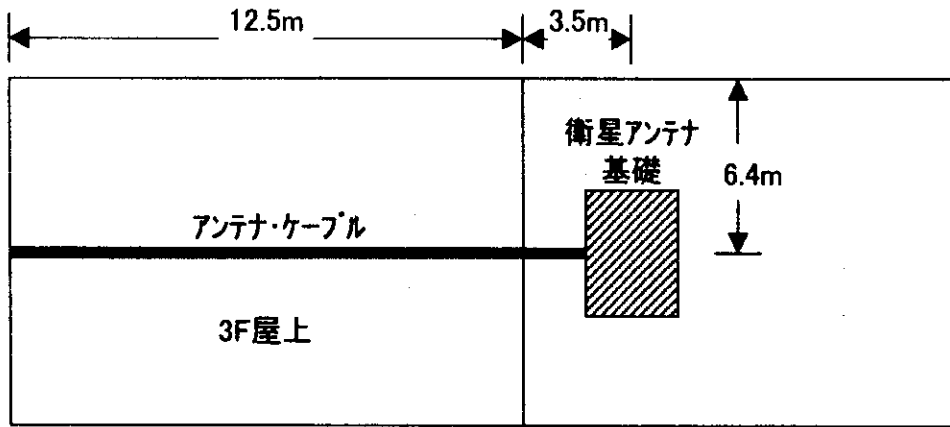

概算ケーブル長: 80m

衛星通信用アンテナ配置図

→ 北

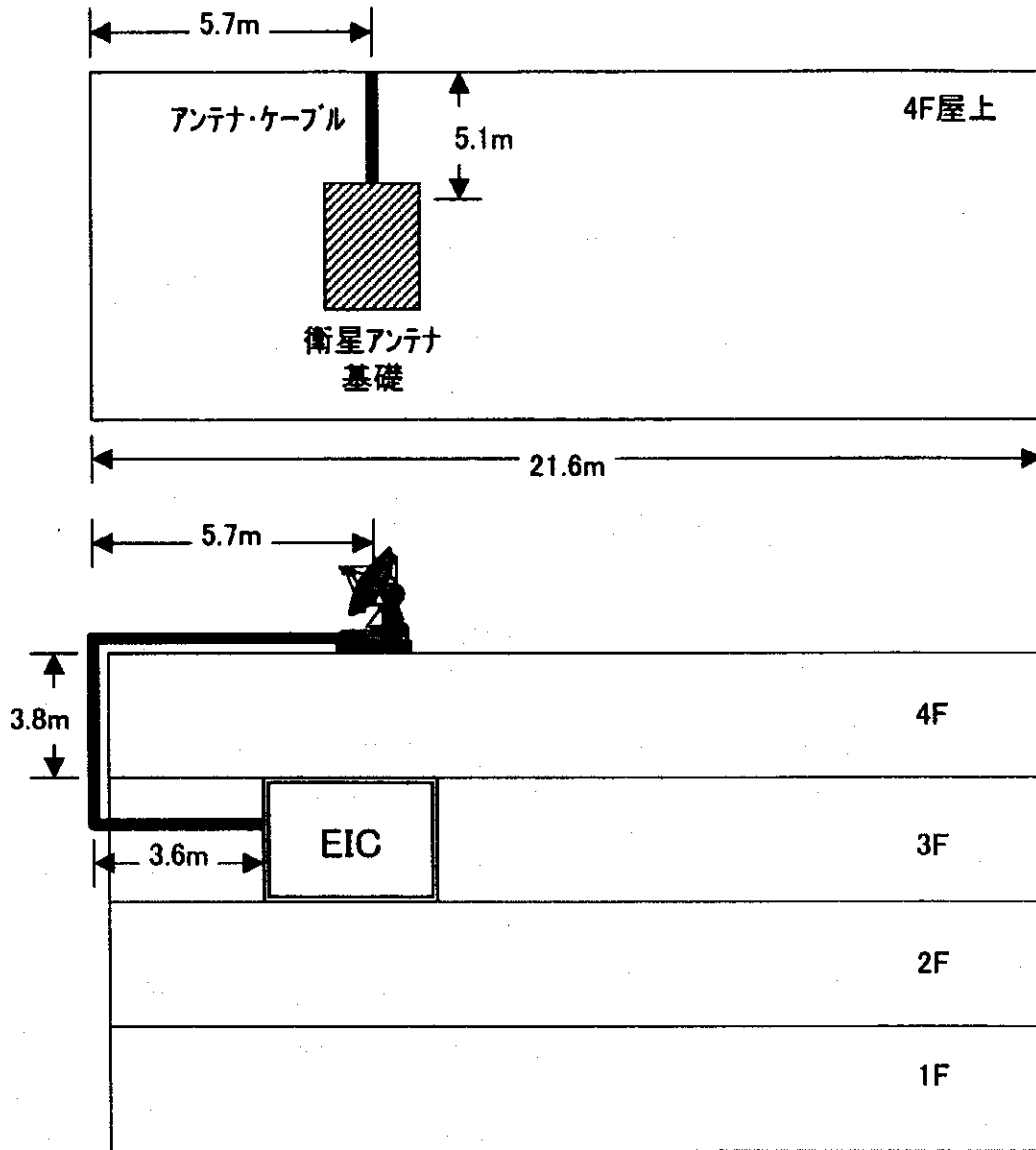

概算ケーブル長: 80m

衛星通信用アンテナ配置図

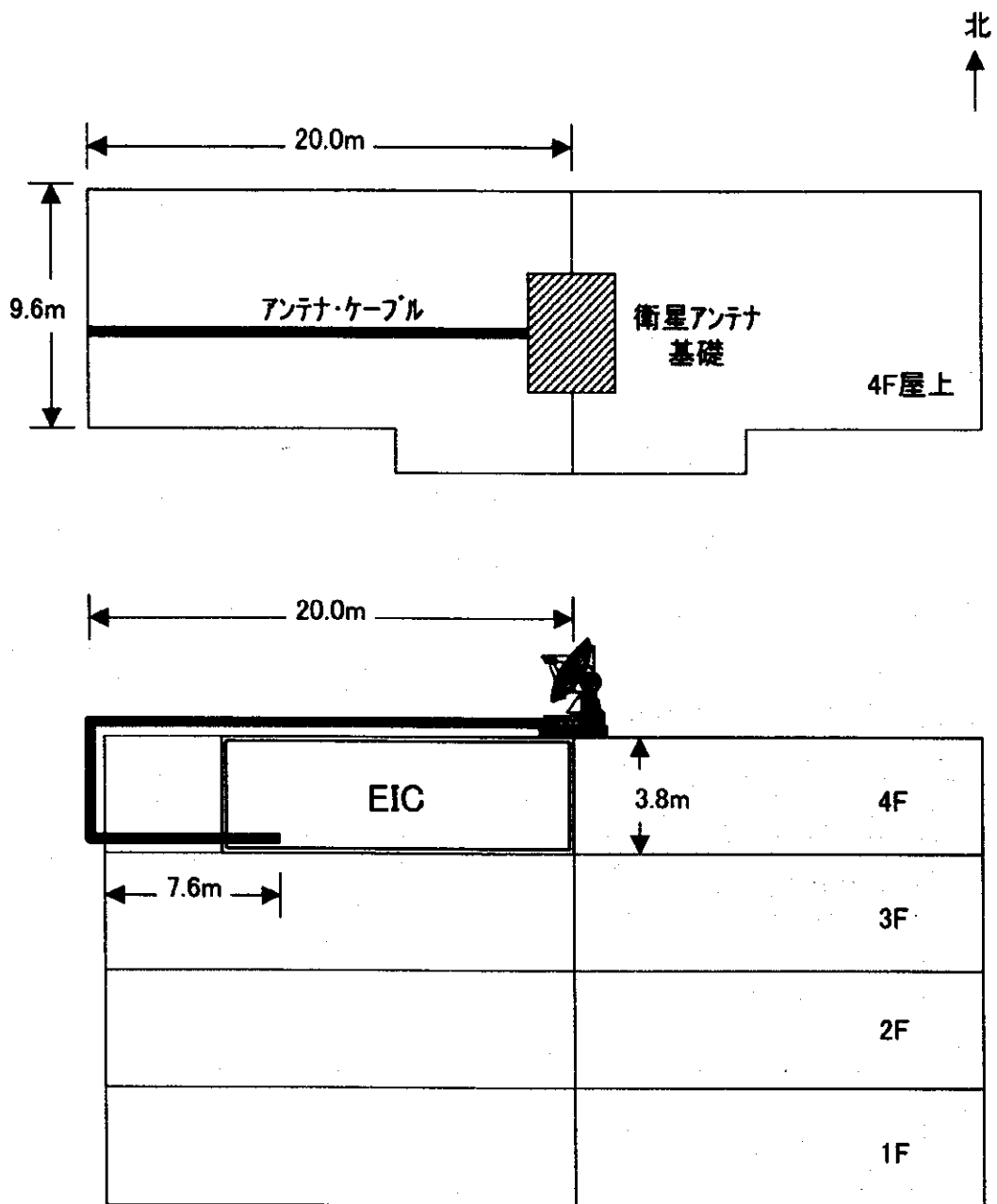

概算ケーブル長：80m

衛星通信用アンテナ配置図

都市番号88 陕西省・西安市 (第一次No.36)

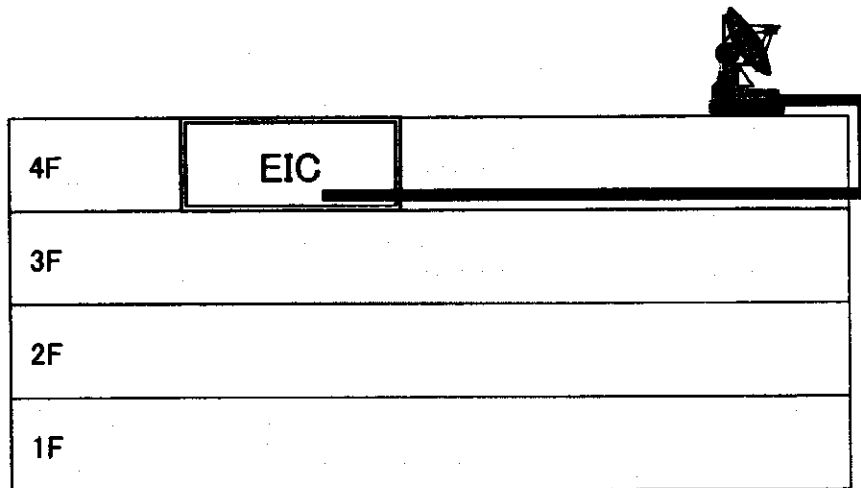
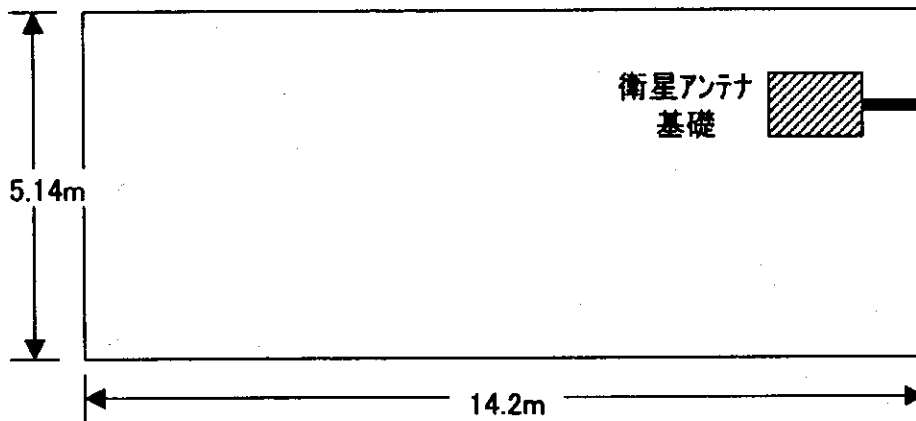

概算ケーブル長: 80m

衛星通信用アンテナ配置図

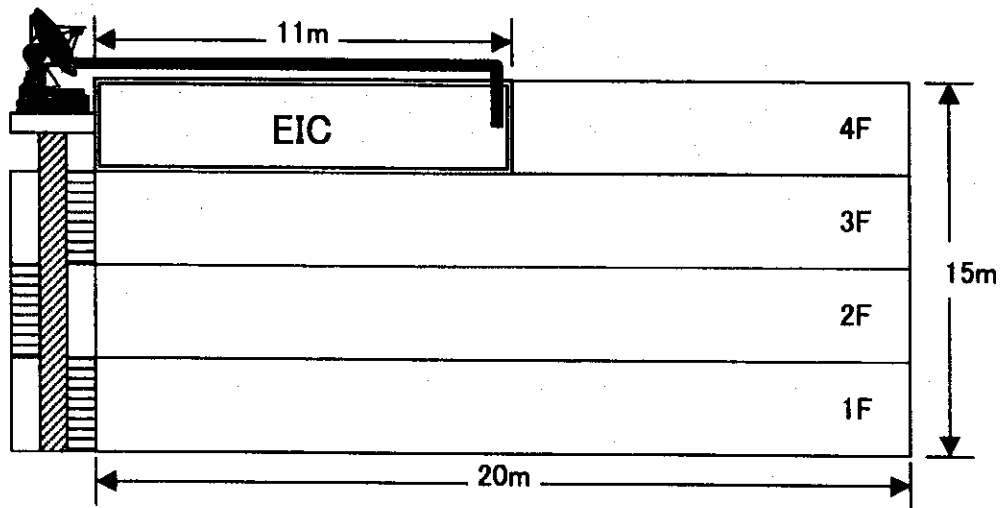
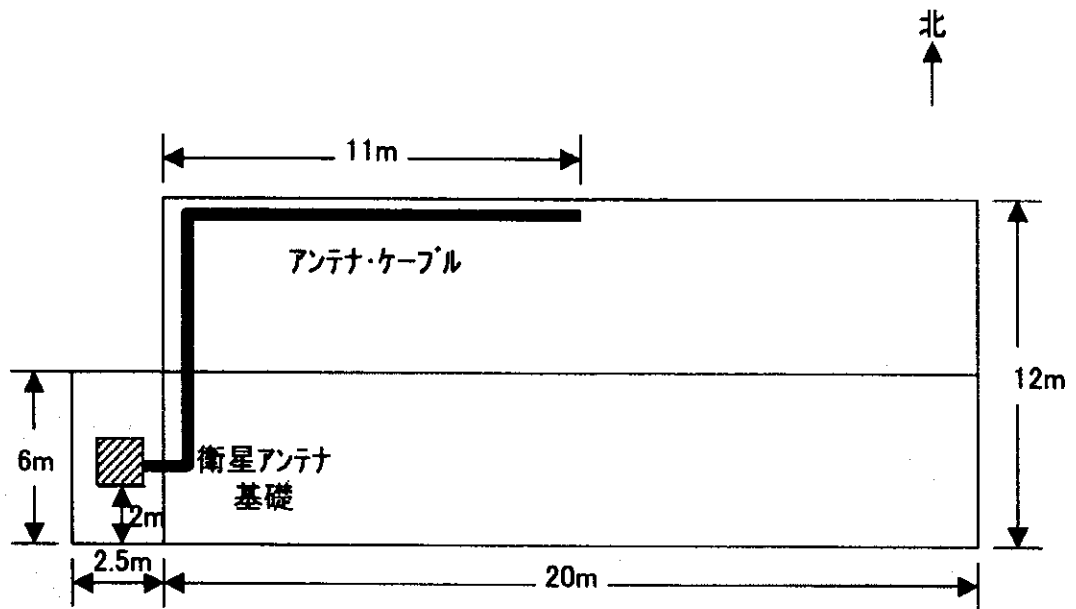

概算ケーブル長: 80m

衛星通信用アンテナ配置図

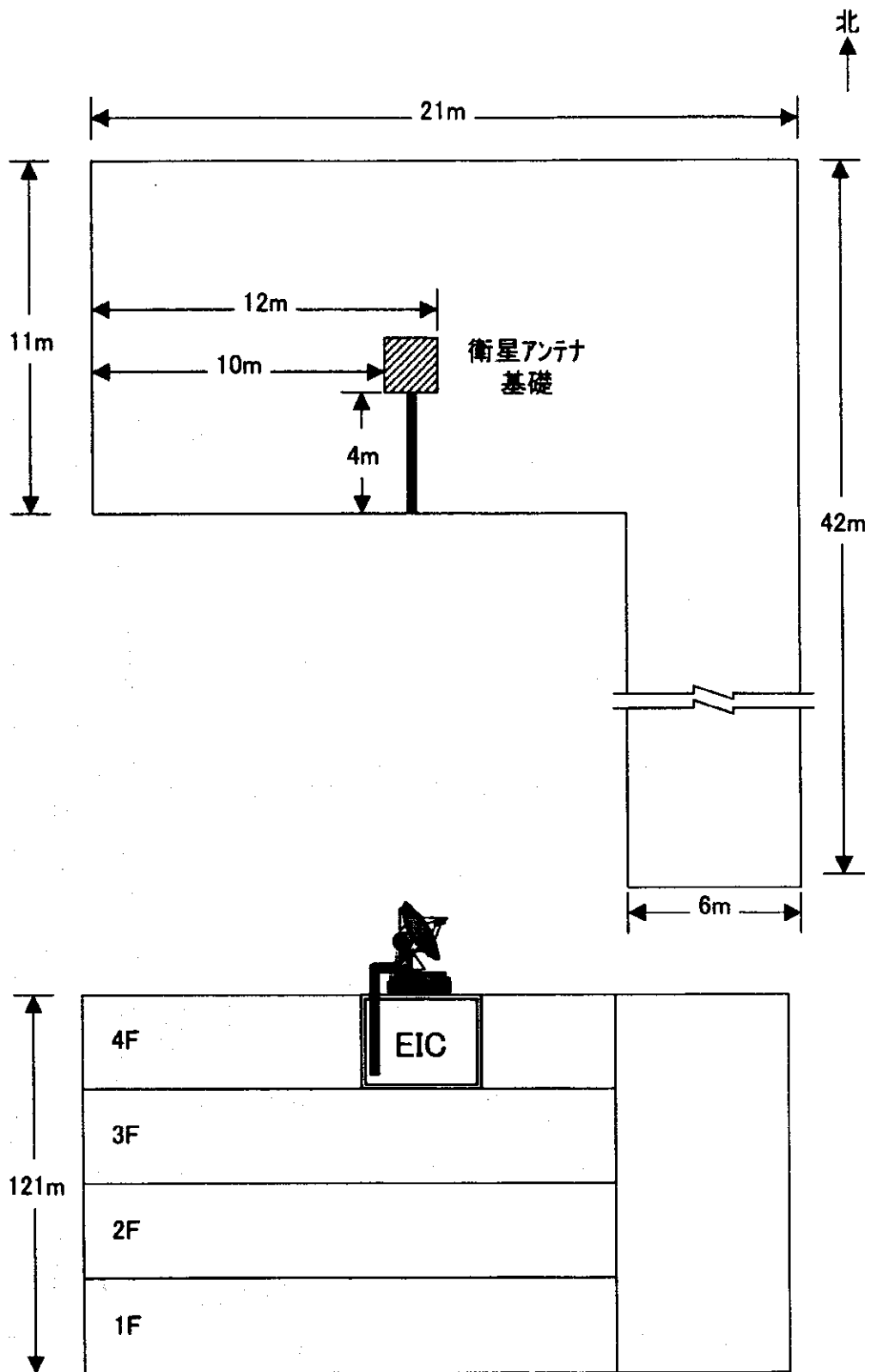

概算ケーブル長: 80m

衛星通信用アンテナ配置図

都市番号91 陕西省・漢中市 No.55

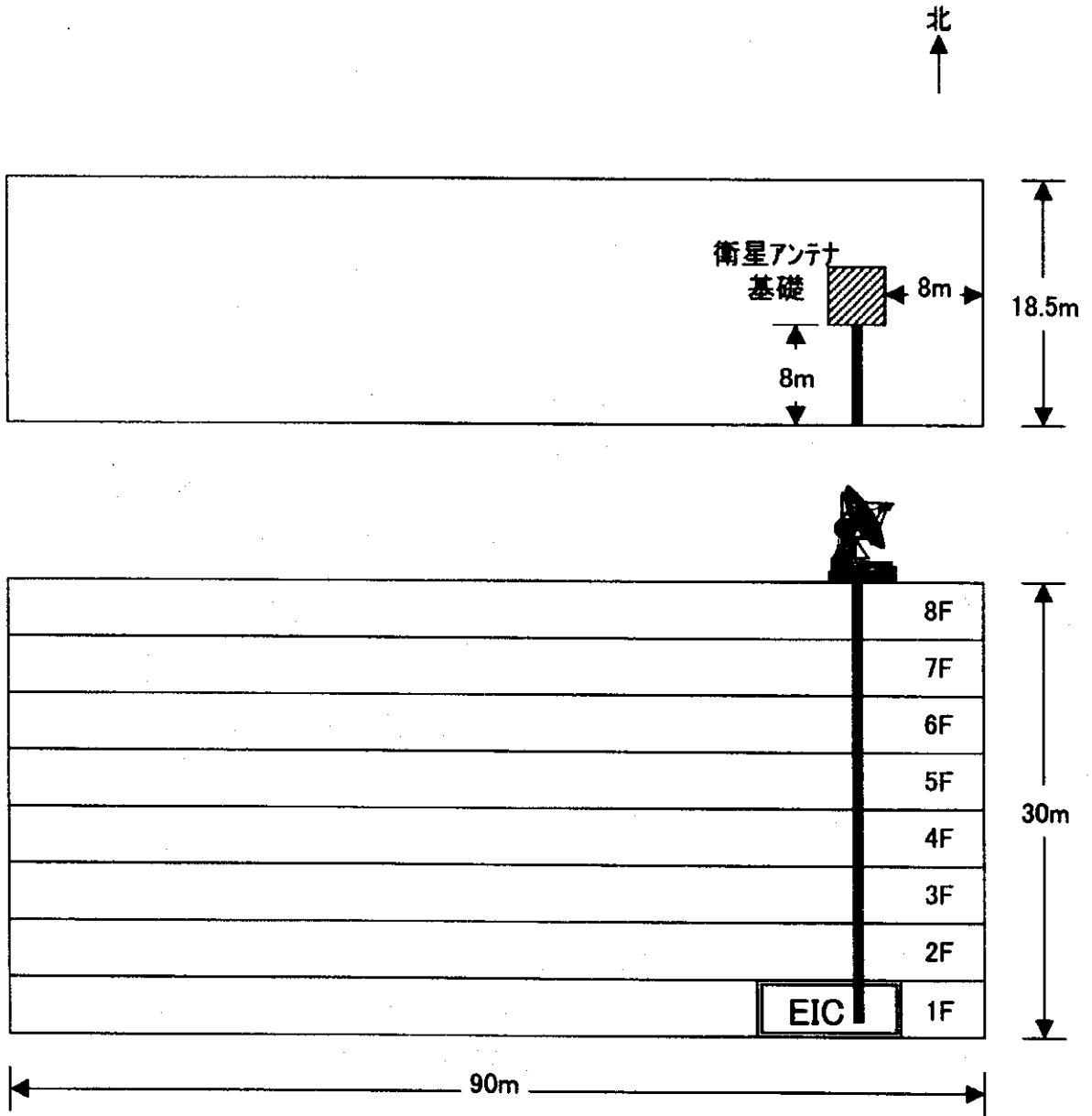

概算ケーブル長: 80m

衛星通信用アンテナ配置図

都市番号92 甘肅省・蘭州市（第一次No.37）

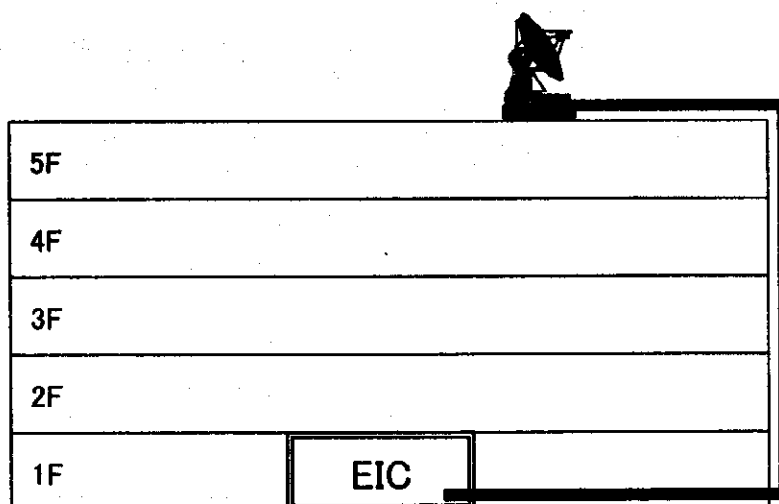
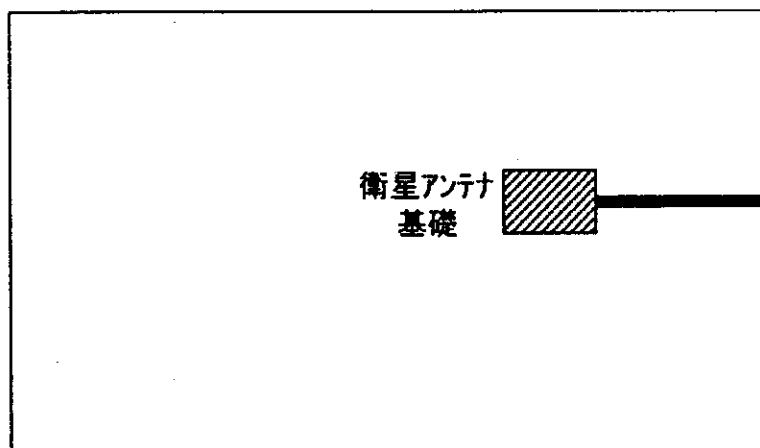

概算ケーブル長：80m

衛星通信用アンテナ配置図

→ 北

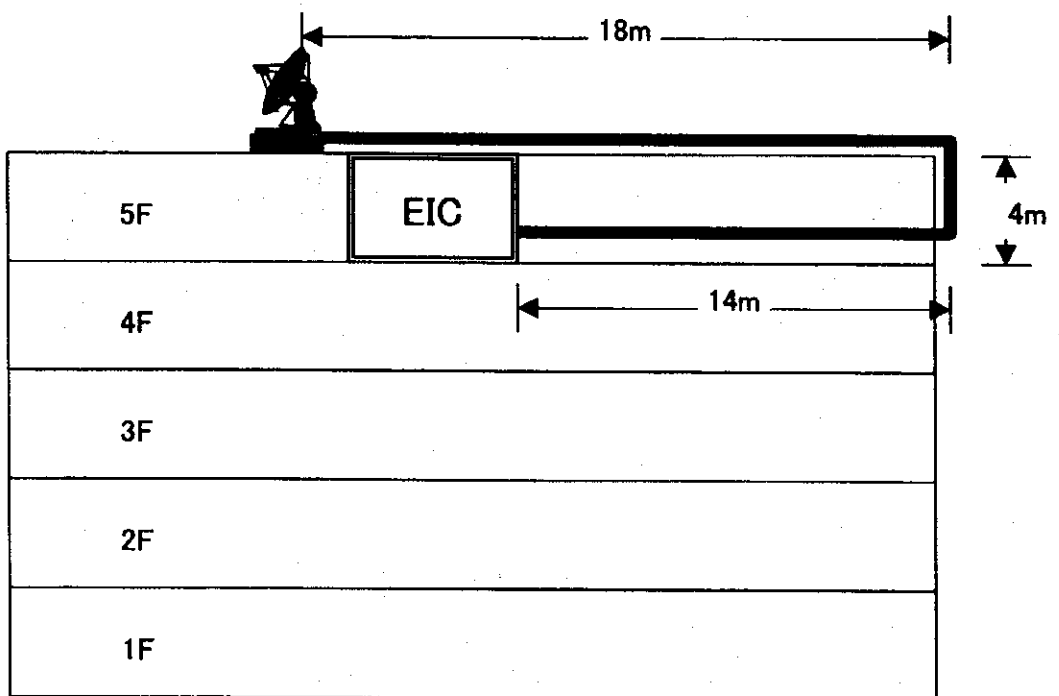
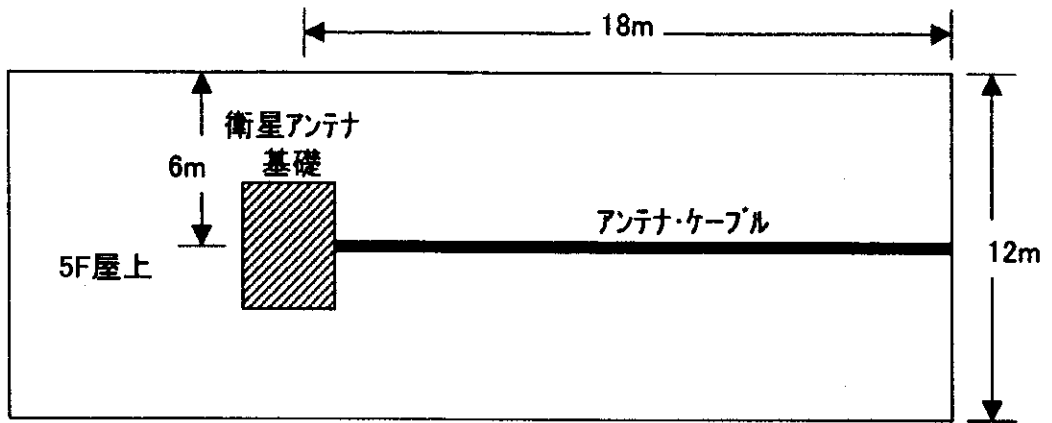

概算ケーブル長: 80m

衛星通信用アンテナ配置図

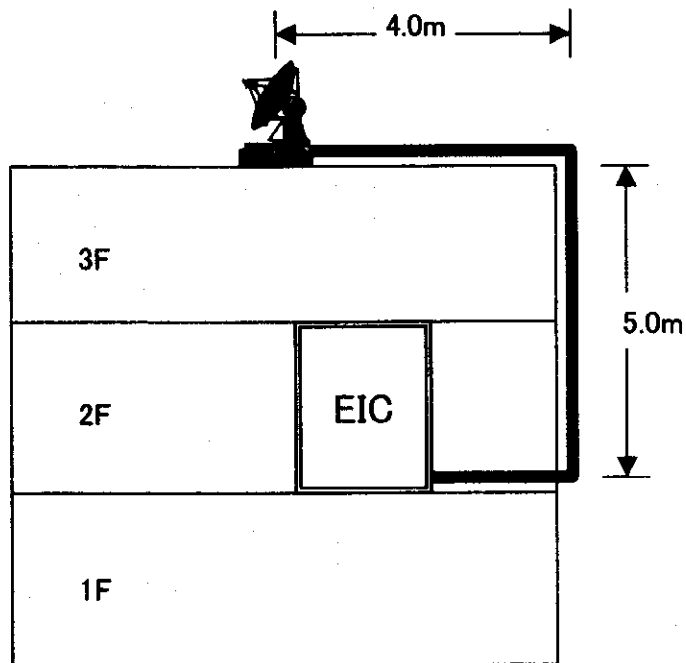
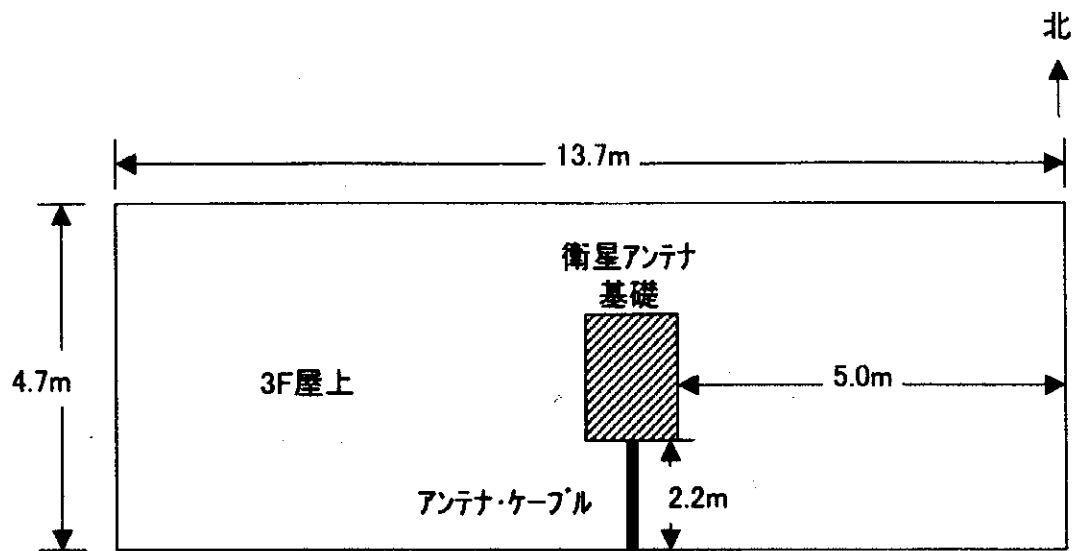

概算ケーブル長: 80m

衛星通信用アンテナ配置図

都市番号95 青海省・西寧市（第一次No.38）

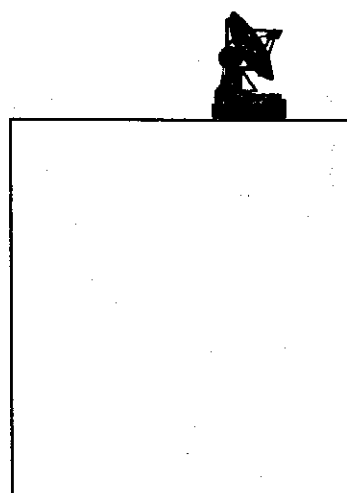
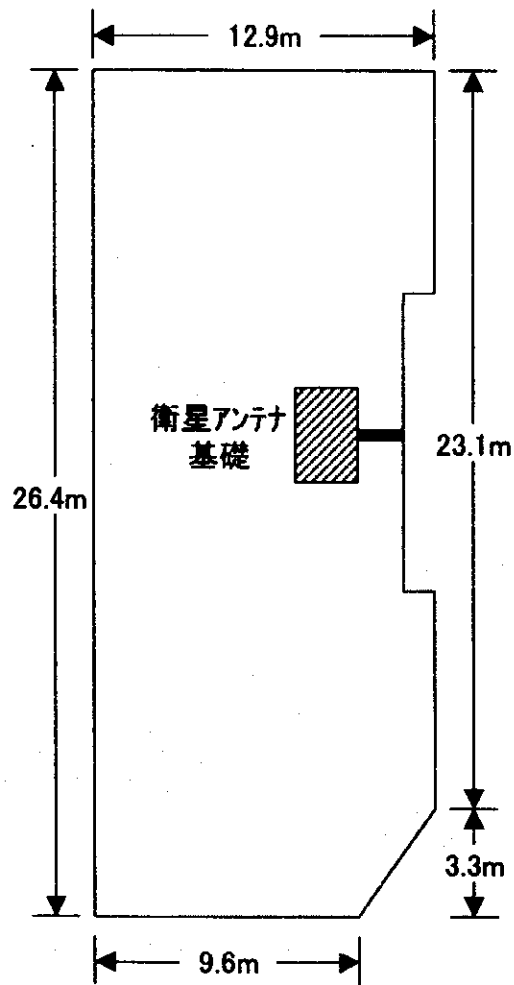

概算ケーブル長：80m

衛星通信用アンテナ配置図

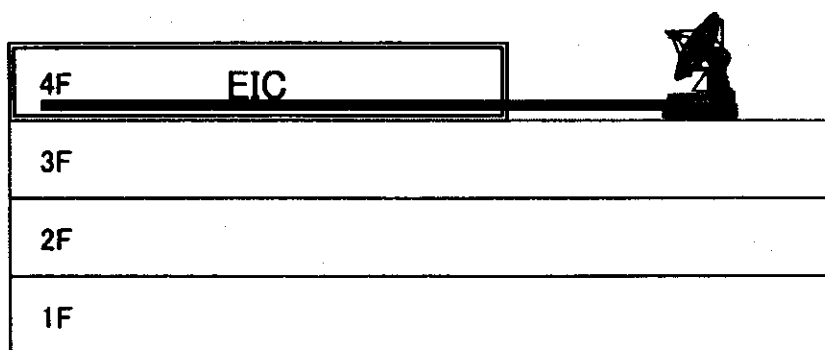
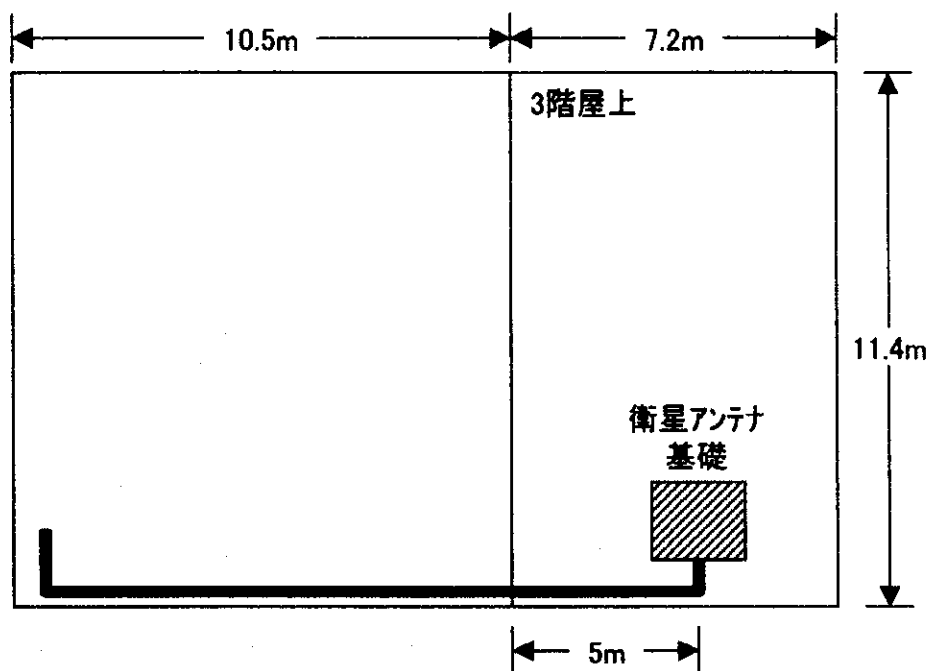

概算ケーブル長: 80m

衛星通信用アンテナ配置図

都市番号97 寧夏自治区・銀川市（第一次No.39）

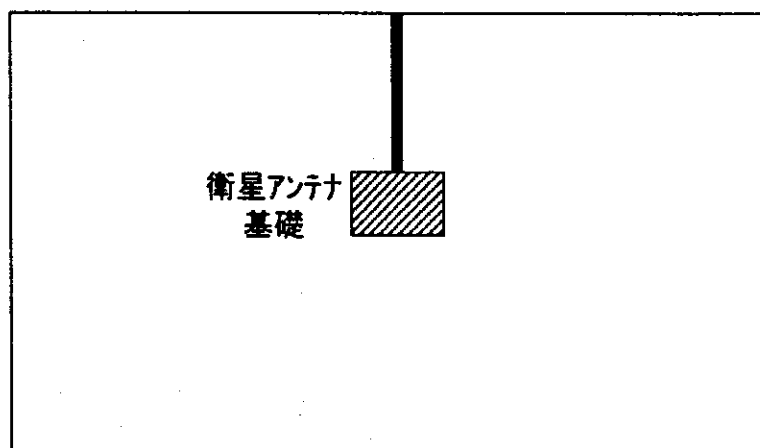

5F
4F
3F
2F
1F

概算ケーブル長：80m

衛星通信用アンテナ配置図

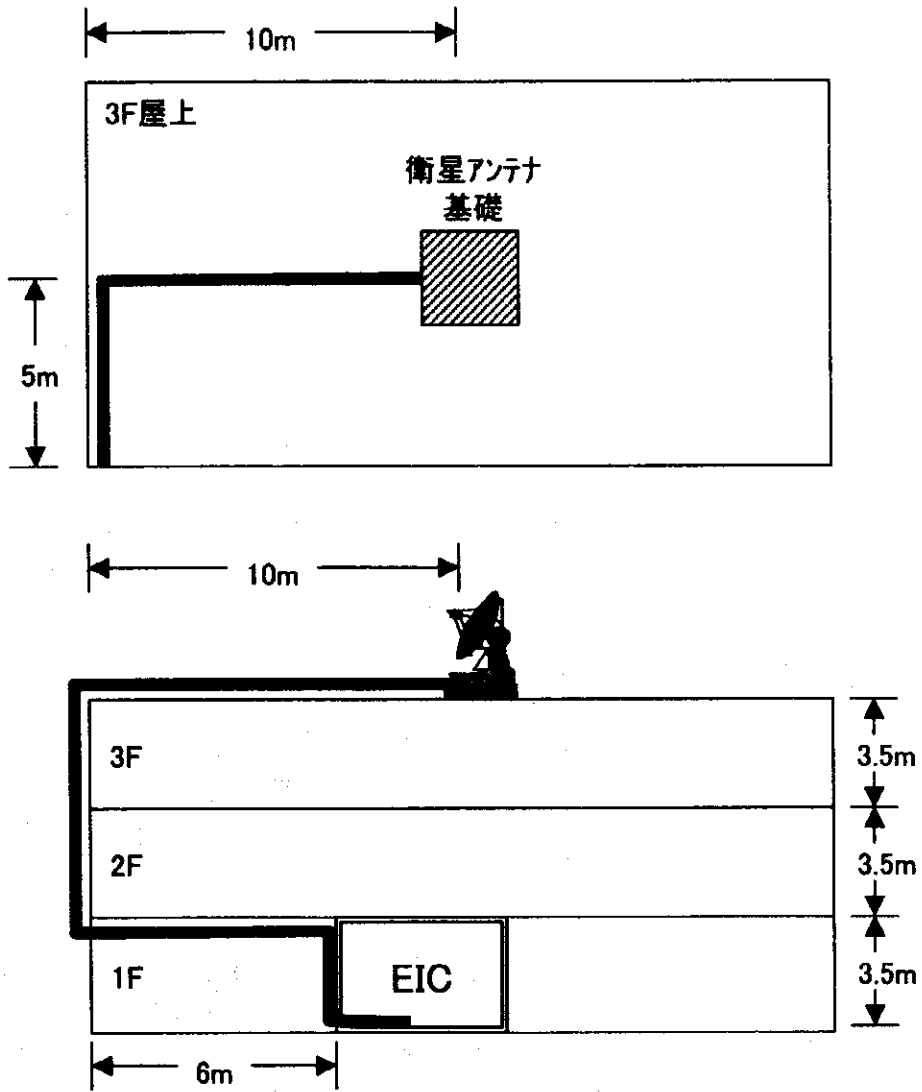

概算ケーブル長: 80m

衛星通信用アンテナ配置図

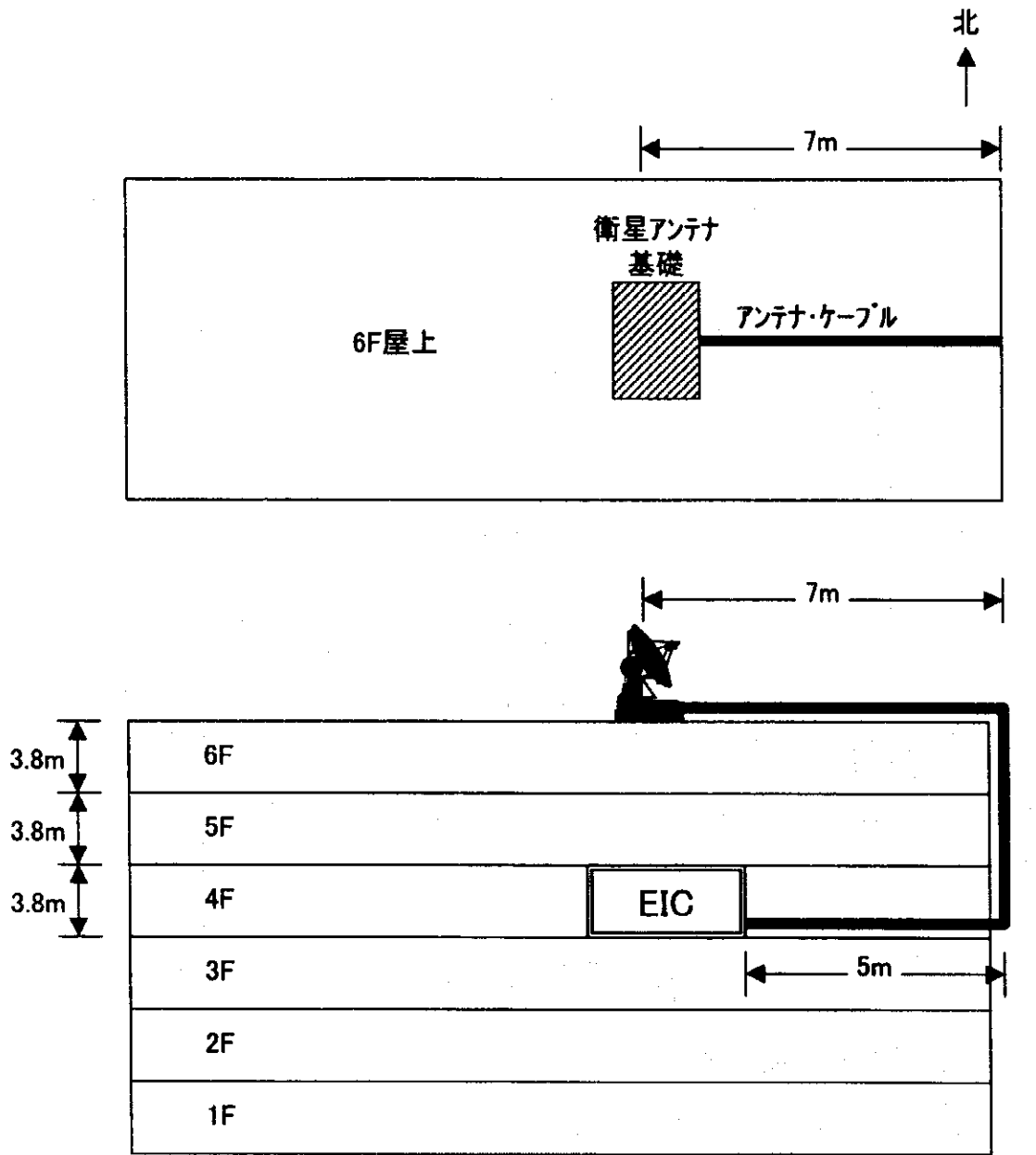

概算ケーブル長：80m

衛星通信用アンテナ配置図

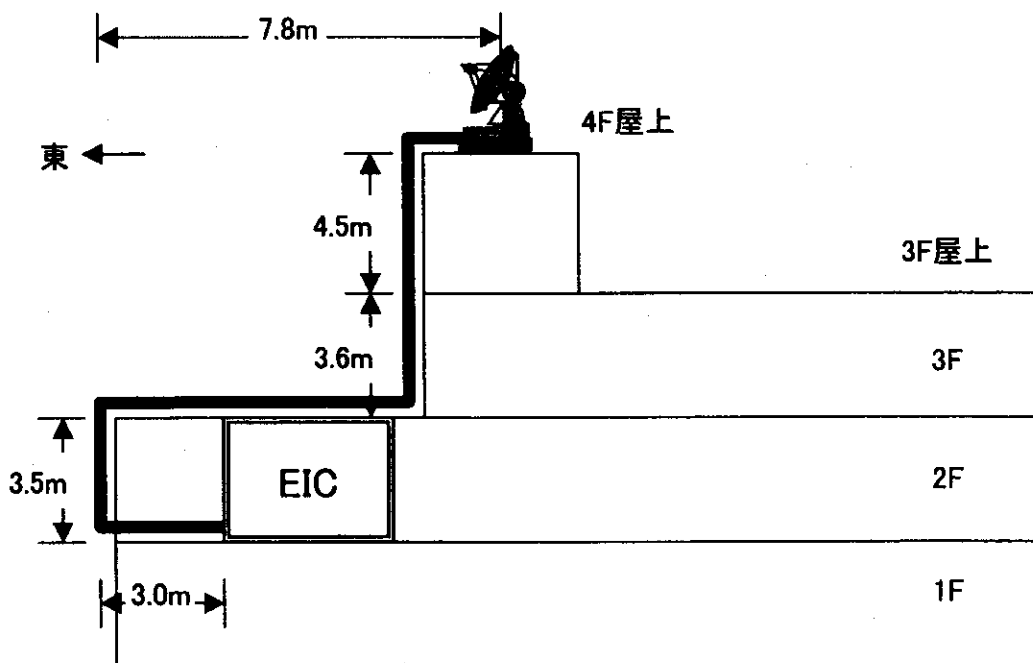
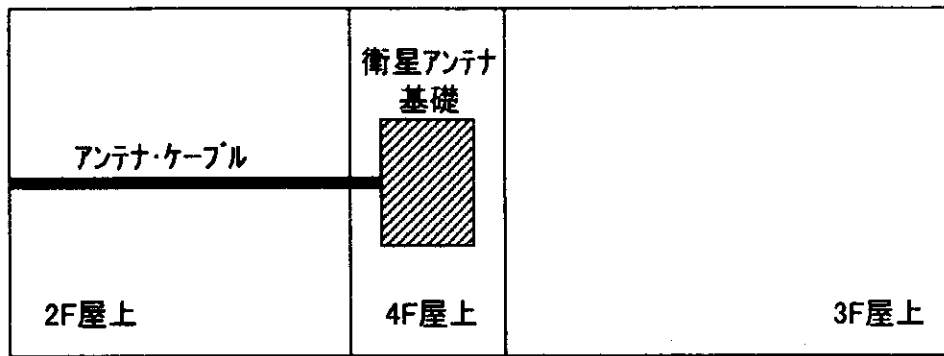

概算ケーブル長: 80m

衛星通信用アンテナ配置図

JICA