

LEGEND

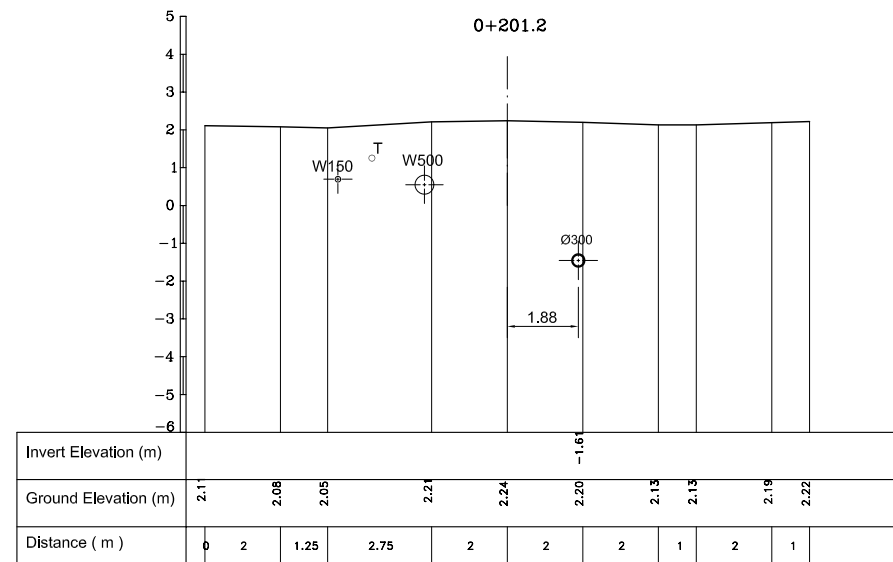
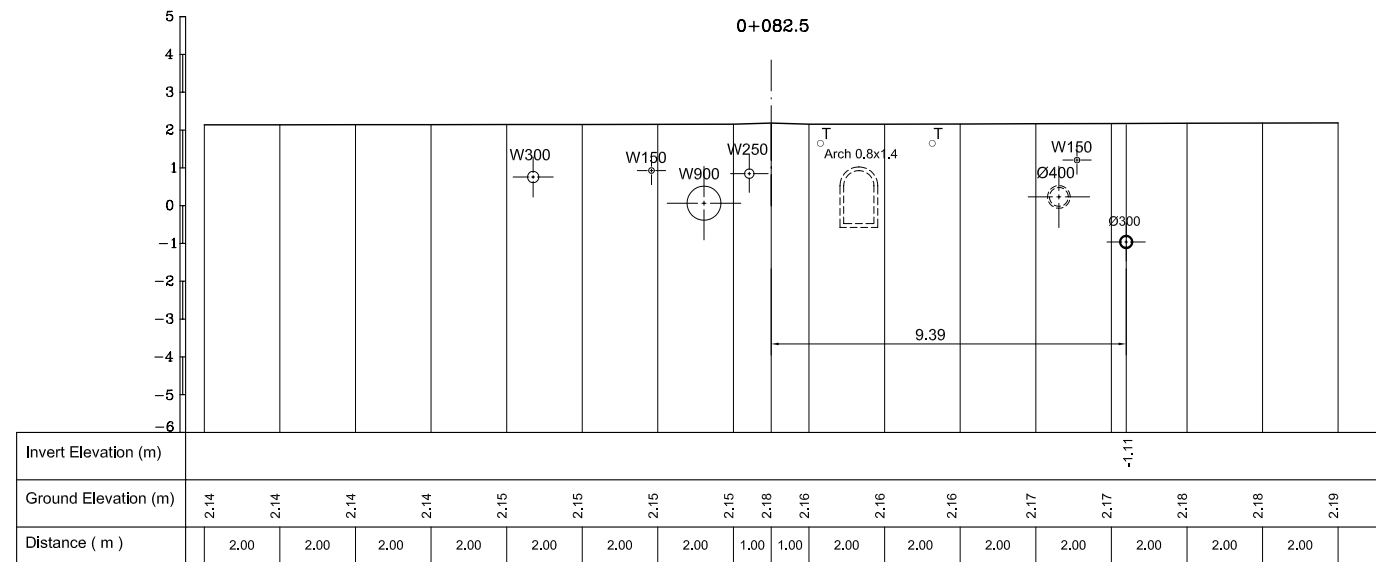
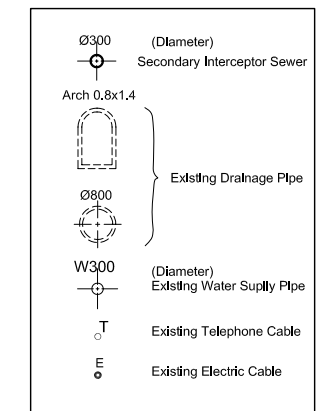

NO.	DATE	DESCRIPTIONS	BY	APRO.

REVISIONS

PROJECT MANAGEMENT UNIT FOR  
HO CHI MINH CITY  
WATER ENVIRONMENT IMPROVEMENT

THE DETAILED DESIGN ON HO CHI MINH CITY  
WATER ENVIRONMENT IMPROVEMENT PROJECT  
IN THE SOCIALIST REPUBLIC OF VIET NAM

PACKAGE C  
INTERCEPTOR SEWER CONSTRUCTION  
CROSS SECTION OF  
SECONDARY INTERCEPTOR (3)  
(PASTEUR)

SCALE : 1 : 100

JICA JAPAN INTERNATIONAL COOPERATION AGENCY (JICA)

PACIFIC CONSULTANTS INTERNATIONAL

DESIGNED: SATO NOBUYUKI  
CHECKED: KONDO MASAMI

DATE : JUNE 2001 DWG. No. PC - ISC - 260

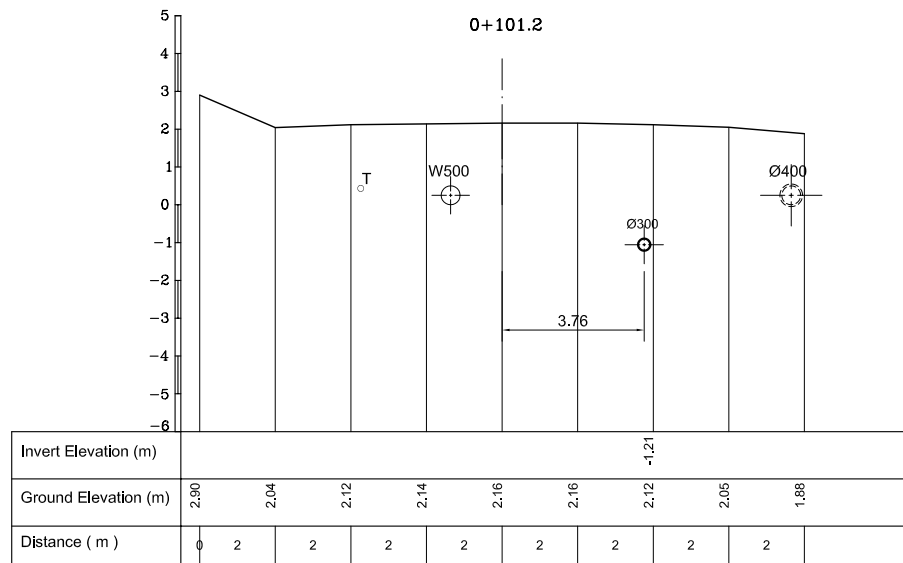

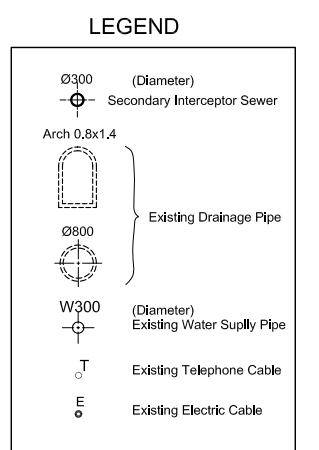
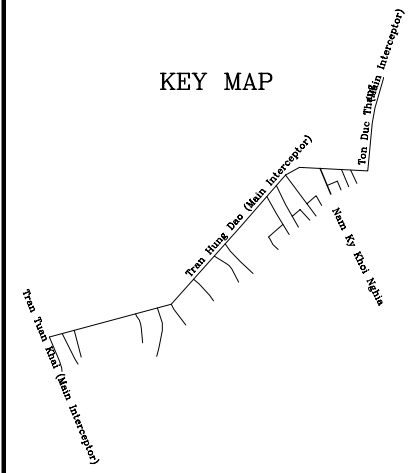
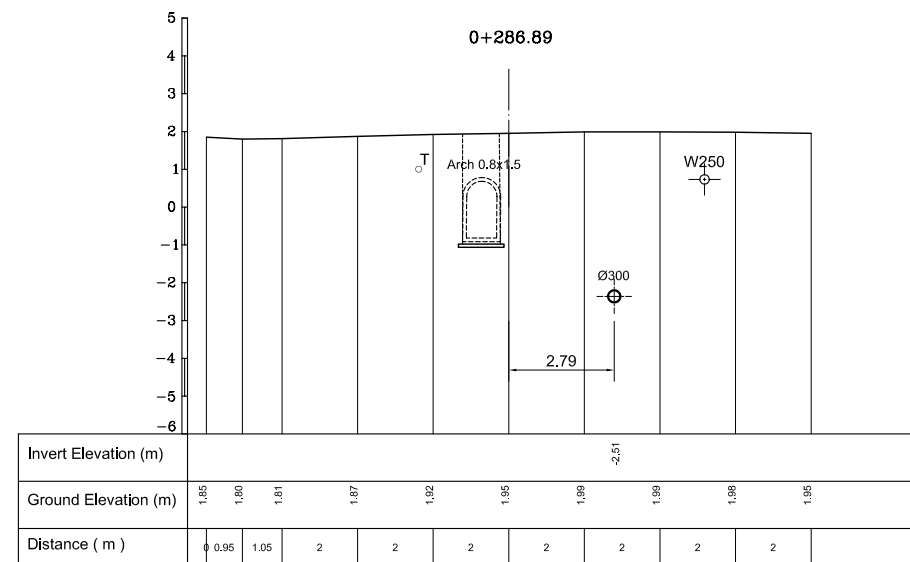
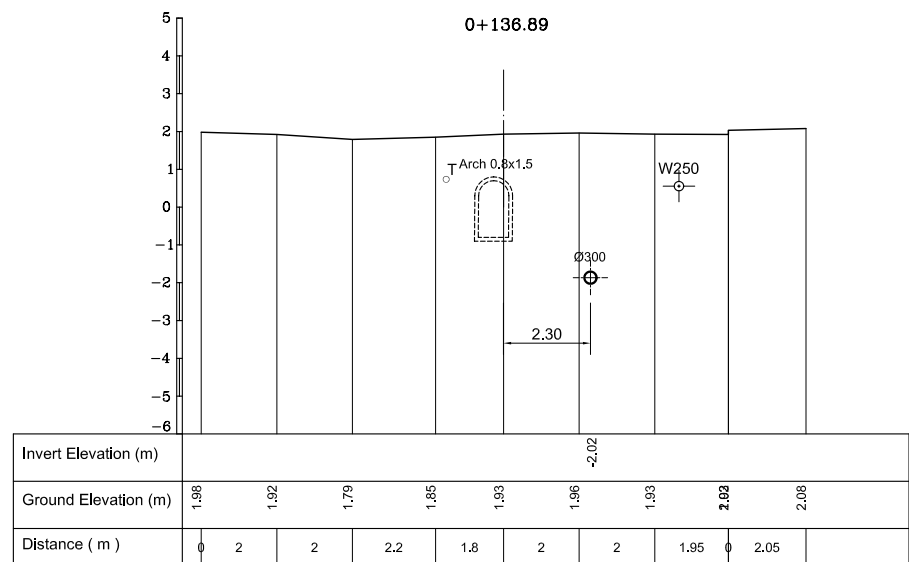
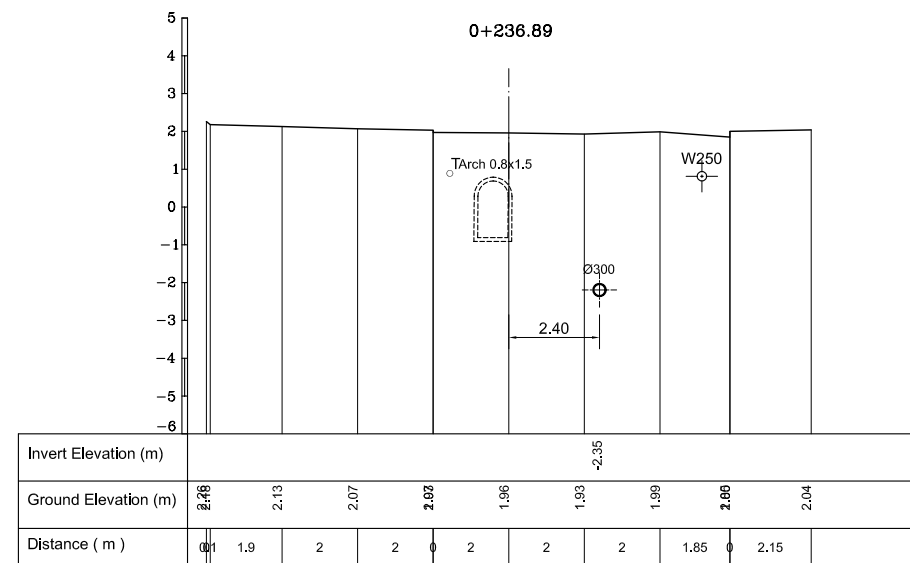
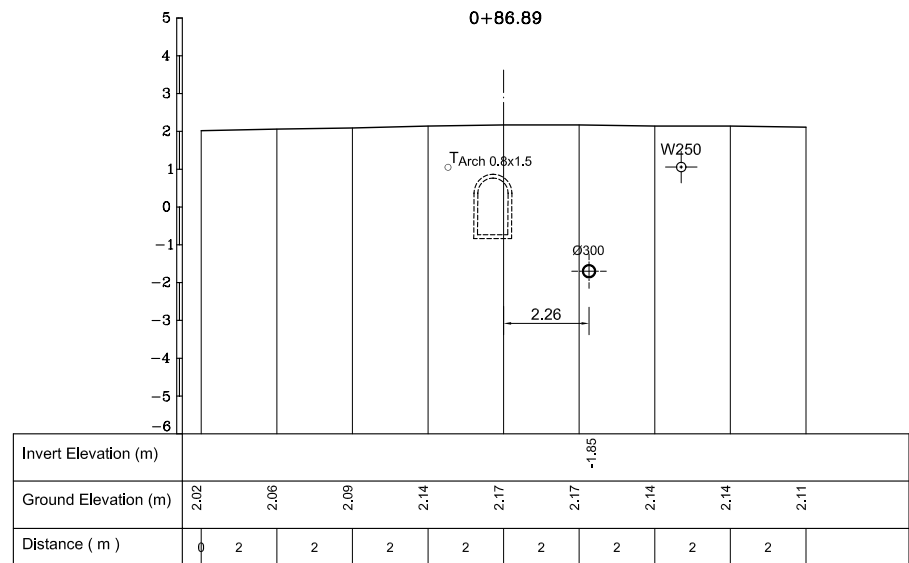
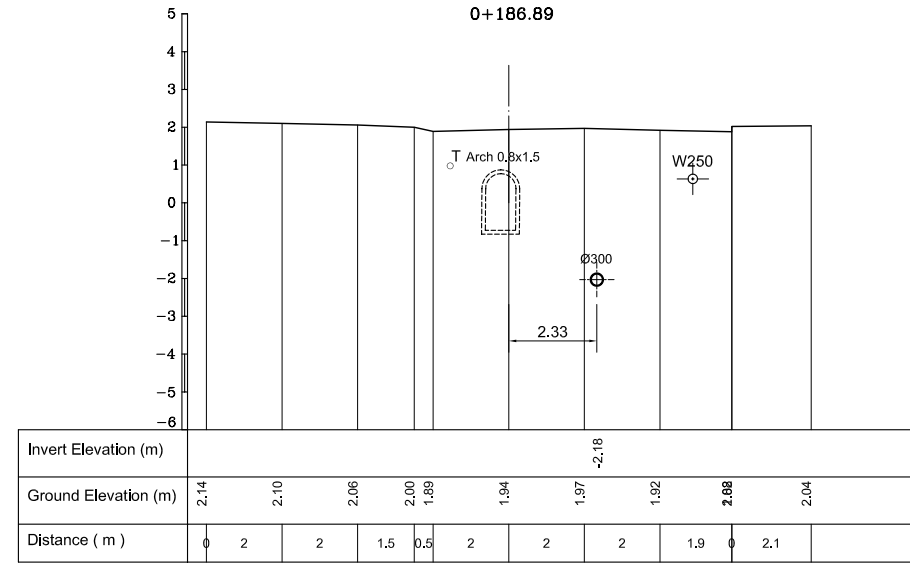
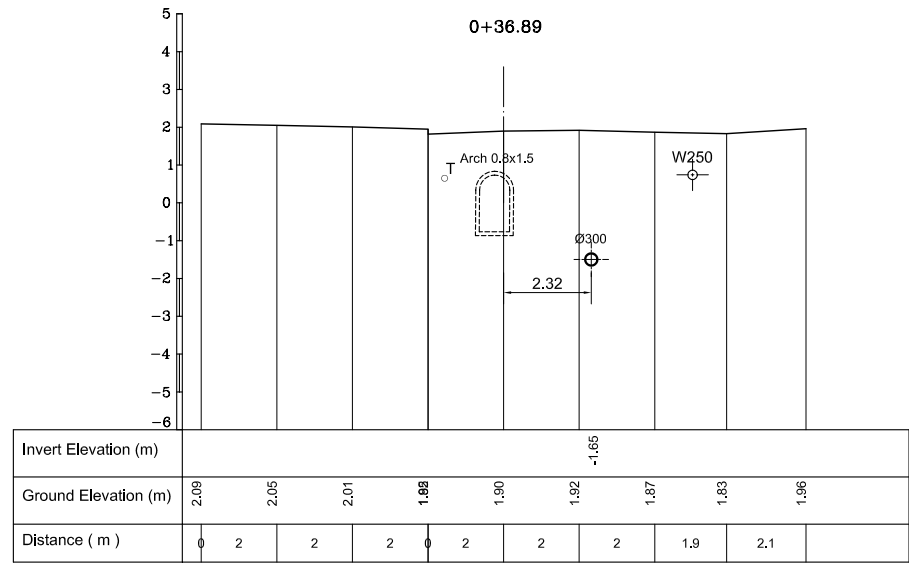

NO.	DATE	DESCRIPTIONS	BY	APRO.
-----	------	--------------	----	-------

REVISIONS

PROJECT MANAGEMENT UNIT FOR  
HO CHI MINH CITY  
WATER ENVIRONMENT IMPROVEMENT

THE DETAILED DESIGN ON HO CHI MINH CITY  
WATER ENVIRONMENT IMPROVEMENT PROJECT  
IN THE SOCIALIST REPUBLIC OF VIET NAM

PACKAGE C  
INTERCEPTOR SEWER CONSTRUCTION  
CROSS SECTION OF  
SECONDARY INTERCEPTOR (4)  
(NAM KY KHOI NGHIA)

SCALE : 1 : 100

JICA JAPAN INTERNATIONAL COOPERATION  
AGENCY ( JICA )

PACIFIC CONSULTANTS INTERNATIONAL

DESIGNED SATO NOBUYUKI	CHECKED KONDO MASAMI
---------------------------	-------------------------

DATE : JUNE 2001 DWG. No. PC - ISC - 261

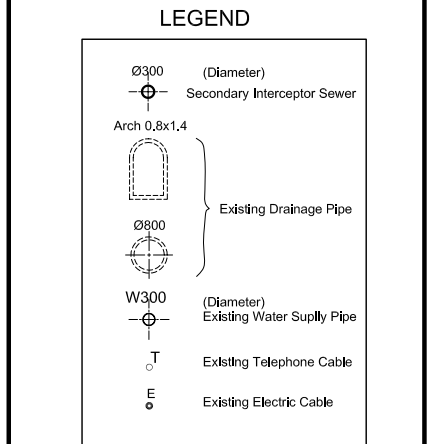
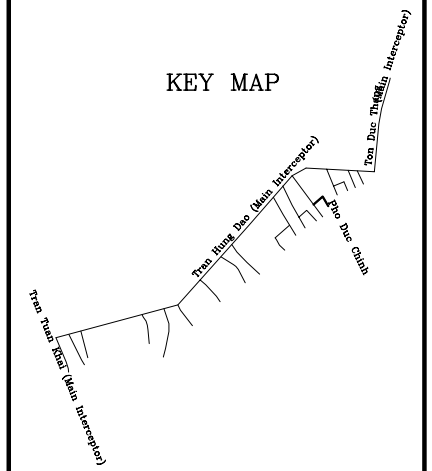
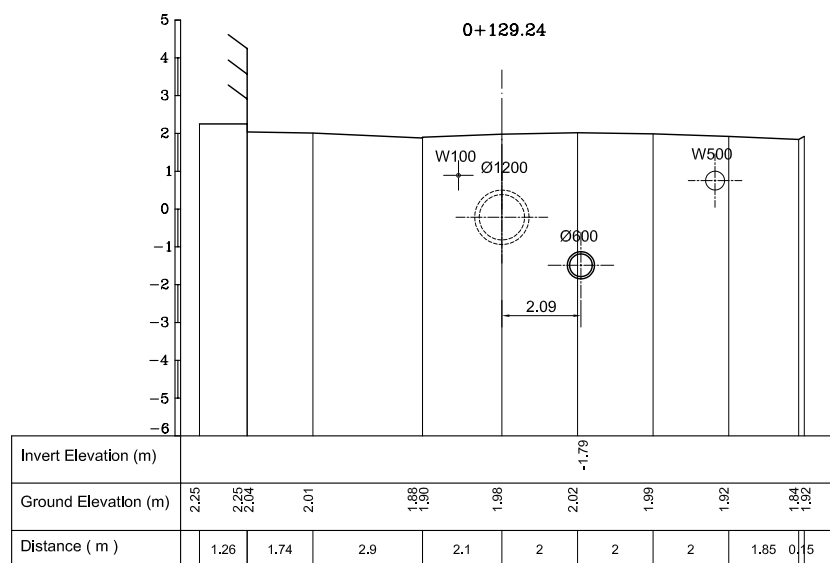
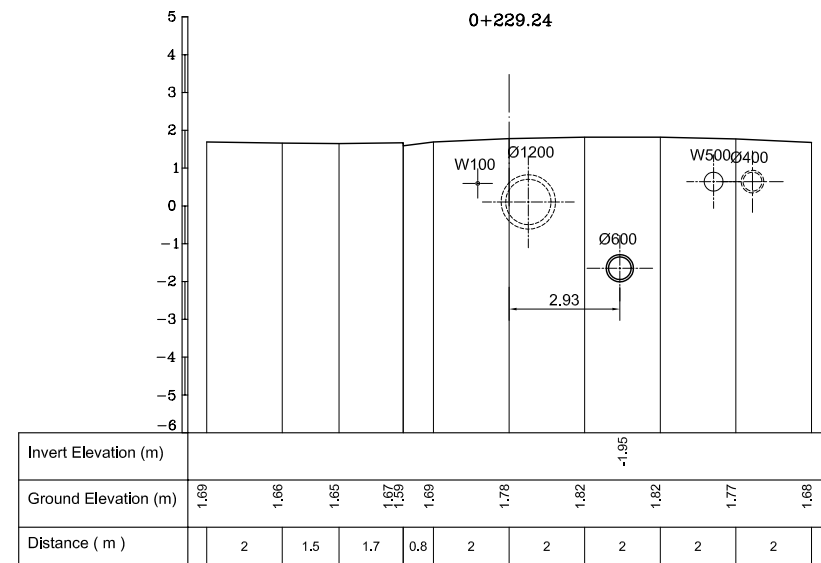
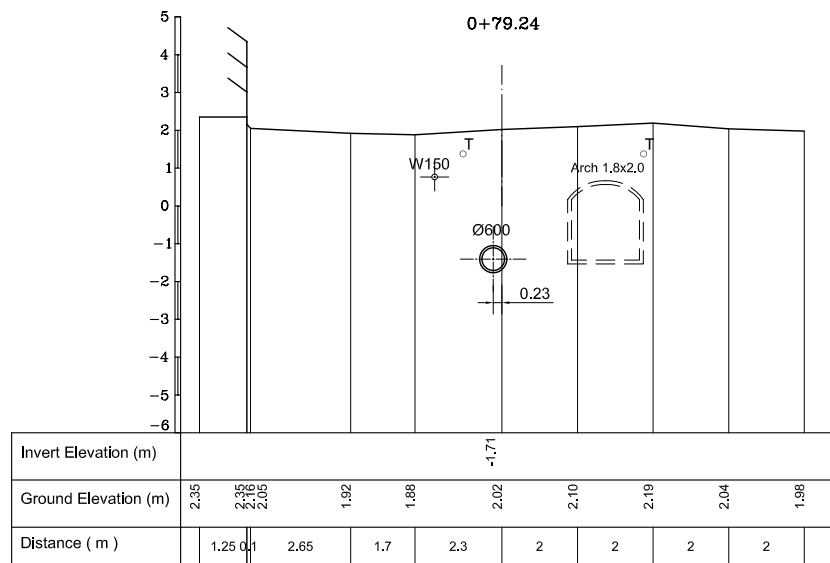
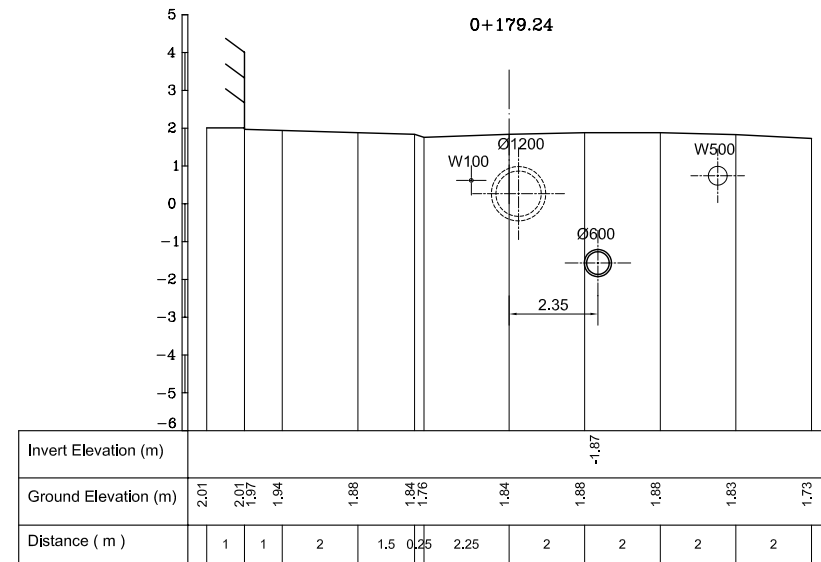
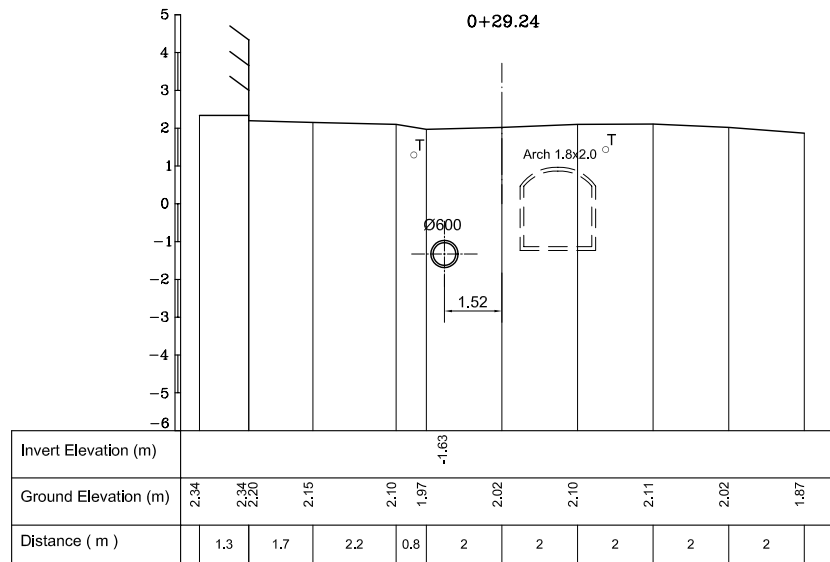

NO.	DATE	DESCRIPTIONS	BY	APRO.

REVISIONS

PROJECT MANAGEMENT UNIT FOR  
HO CHI MINH CITY  
WATER ENVIRONMENT IMPROVEMENT

THE DETAILED DESIGN ON HO CHI MINH CITY  
WATER ENVIRONMENT IMPROVEMENT PROJECT  
IN THE SOCIALIST REPUBLIC OF VIET NAM

PACKAGE C  
INTERCEPTOR SEWER CONSTRUCTION  
CROSS SECTION OF  
SECONDARY INTERCEPTOR (5)  
(PHO DUC CHINH)

SCALE : 1 : 100

JAPAN INTERNATIONAL COOPERATION AGENCY ( JICA )

PACIFIC CONSULTANTS INTERNATIONAL

DESIGNED SATO NOBUYUKI	CHECKED KONDO MASAMI
---------------------------	-------------------------

DATE : JUNE 2001      DWG. No. PC - ISC - 262

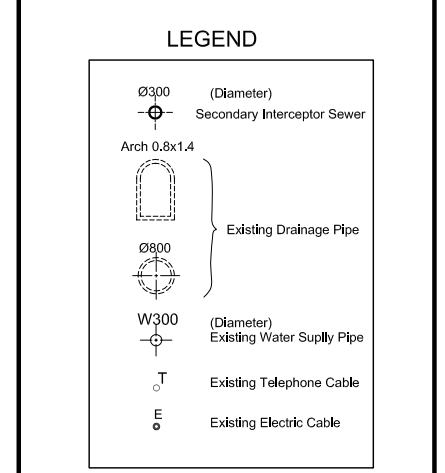
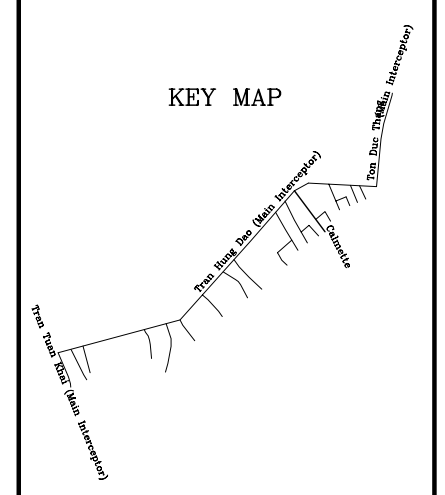
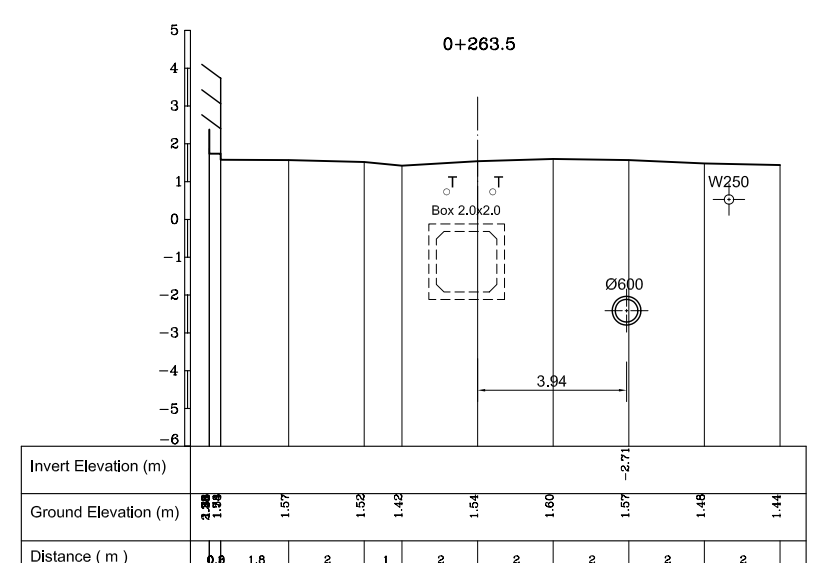
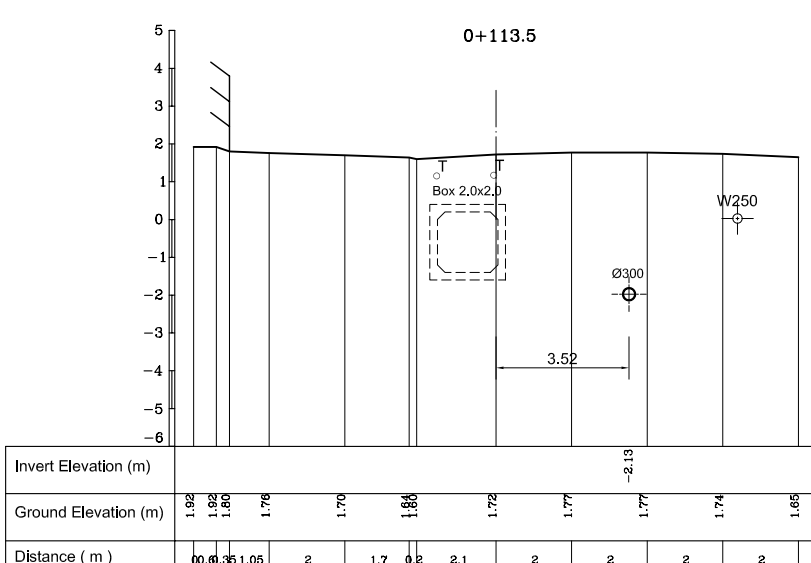
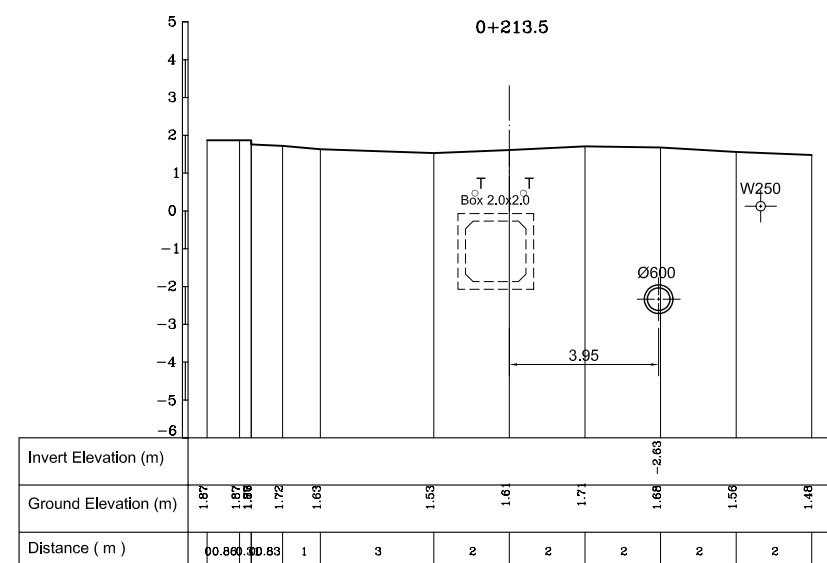
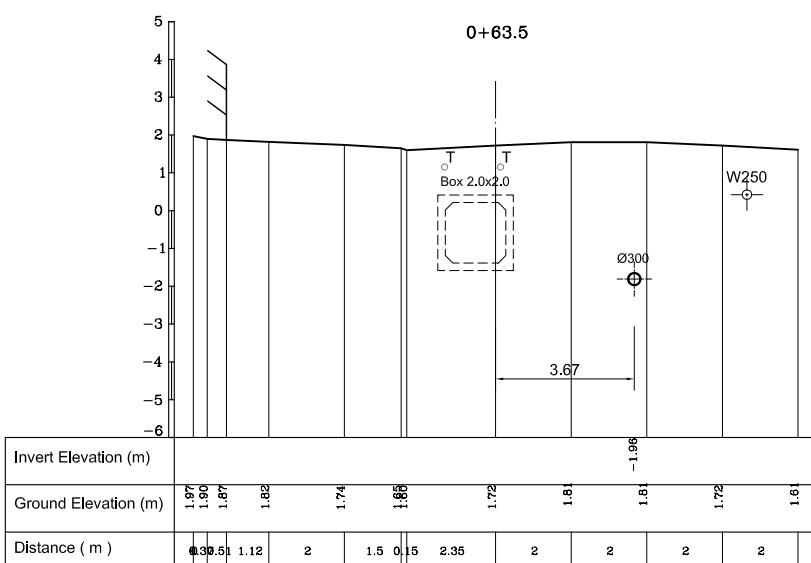
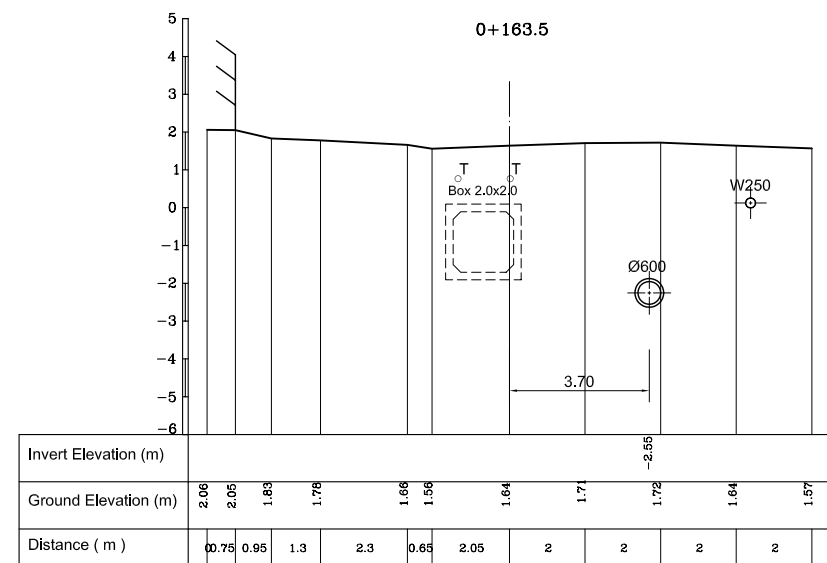
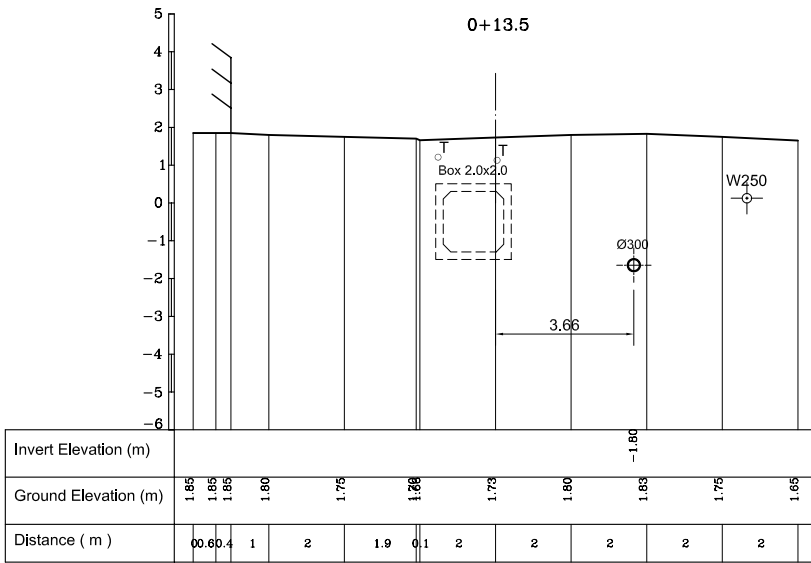

NO.	DATE	DESCRIPTIONS	BY	APRO.

REVISIONS

PROJECT MANAGEMENT UNIT FOR  
HO CHI MINH CITY  
WATER ENVIRONMENT IMPROVEMENT

THE DETAILED DESIGN ON HO CHI MINH CITY  
WATER ENVIRONMENT IMPROVEMENT PROJECT  
IN THE SOCIALIST REPUBLIC OF VIET NAM

PACKAGE C  
INTERCEPTOR SEWER CONSTRUCTION  
CROSS SECTION OF  
SECONDARY INTERCEPTOR (6)  
(CALMETTE)

SCALE : 1 : 100

JICA JAPAN INTERNATIONAL COOPERATION AGENCY ( JICA )

PACIFIC CONSULTANTS INTERNATIONAL

DESIGNED SATO NOBUYUKI	CHECKED KONDO MASAMI
---------------------------	-------------------------

DATE : JUNE 2001 DWG. No. PC - ISC - 263

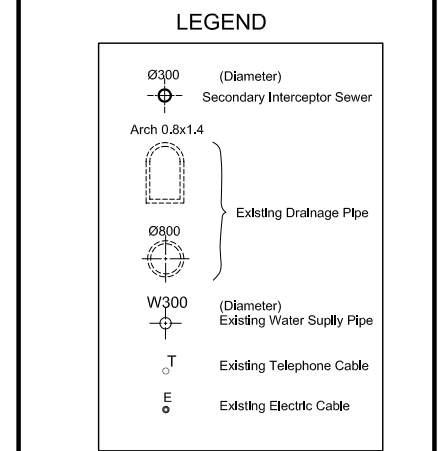
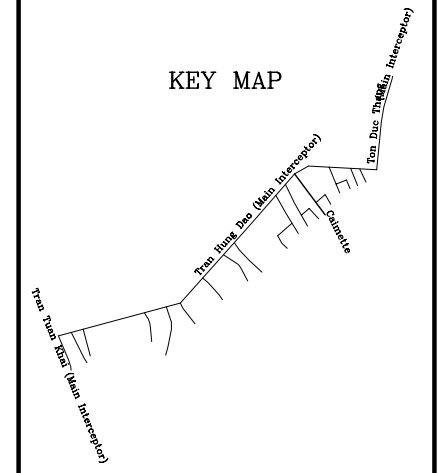
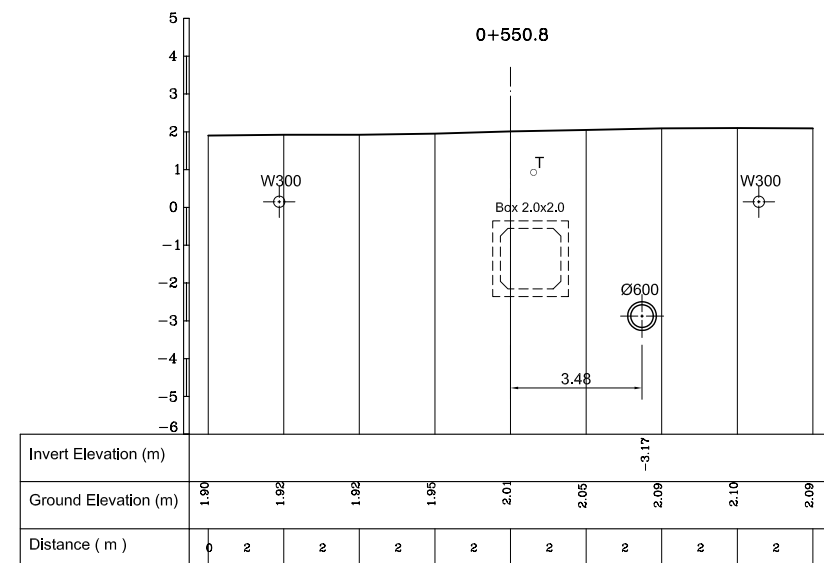
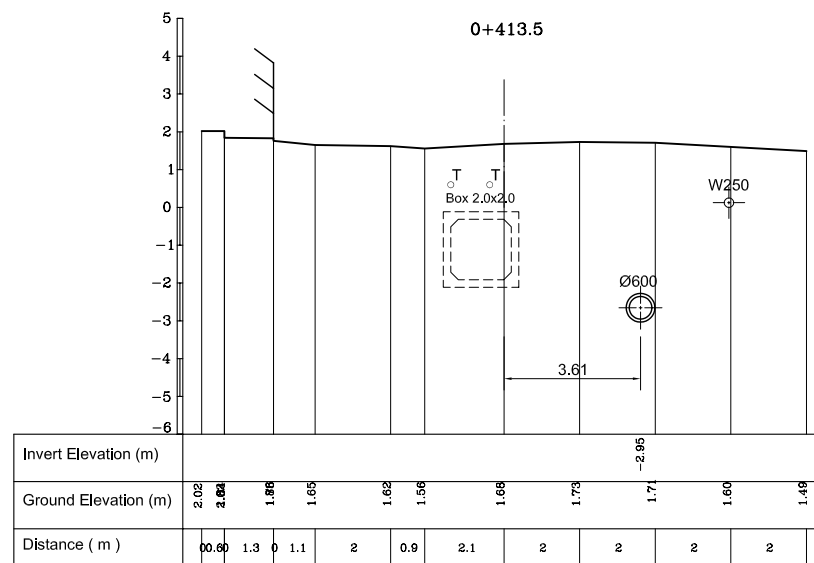
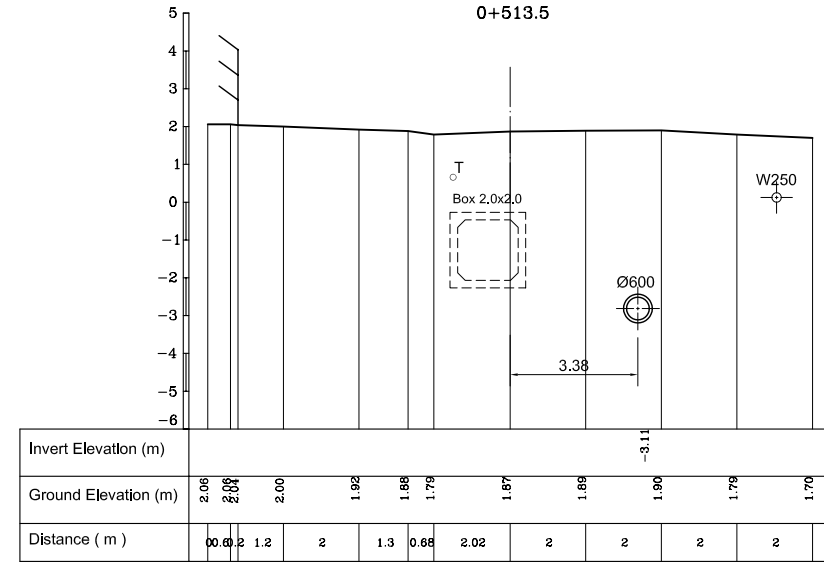
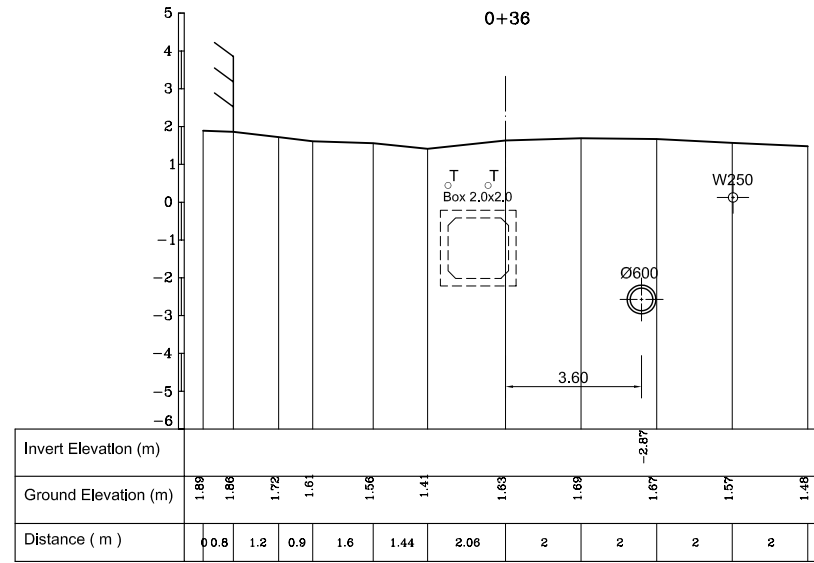
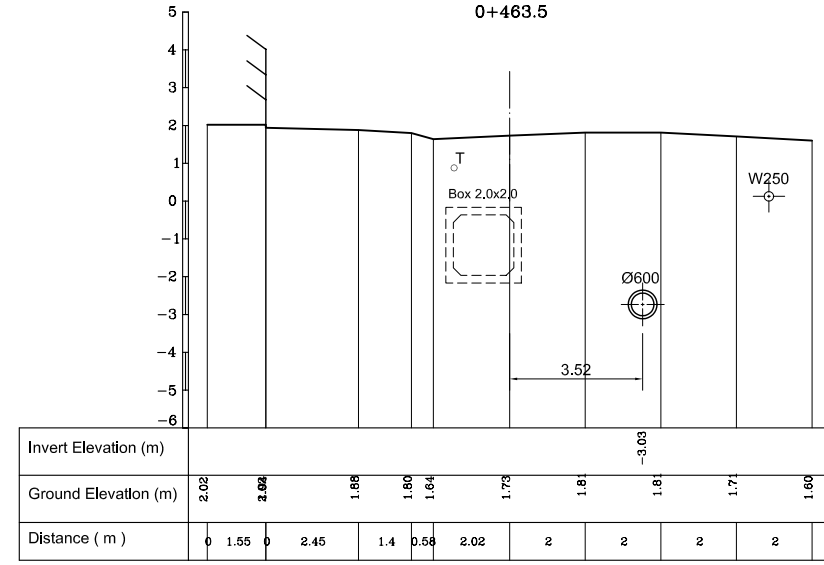
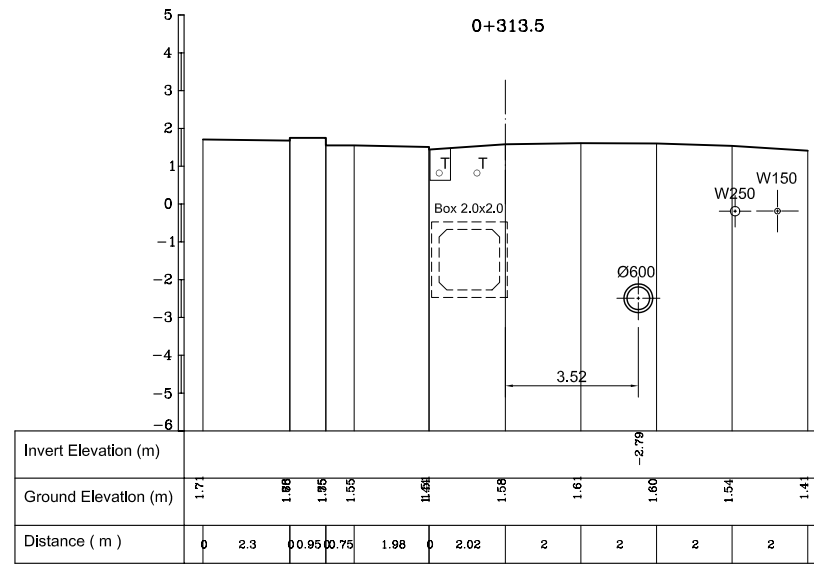

NO.	DATE	DESCRIPTIONS	BY	APRO.

REVISIONS

PROJECT MANAGEMENT UNIT FOR  
HO CHI MINH CITY  
WATER ENVIRONMENT IMPROVEMENT

THE DETAILED DESIGN ON HO CHI MINH CITY  
WATER ENVIRONMENT IMPROVEMENT PROJECT  
IN THE SOCIALIST REPUBLIC OF VIET NAM

PACKAGE C  
INTERCEPTOR SEWER CONSTRUCTION  
CROSS SECTION OF  
SECONDARY INTERCEPTOR (7)  
(CALMETTE)

SCALE : 1 : 100

JAPAN INTERNATIONAL COOPERATION AGENCY ( JICA )

PACIFIC CONSULTANTS INTERNATIONAL

DESIGNED SATO NOBUYUKI	CHECKED KONDO MASAMI
---------------------------	-------------------------

DATE : JUNE 2001      DWG. No. PC - ISC - 264

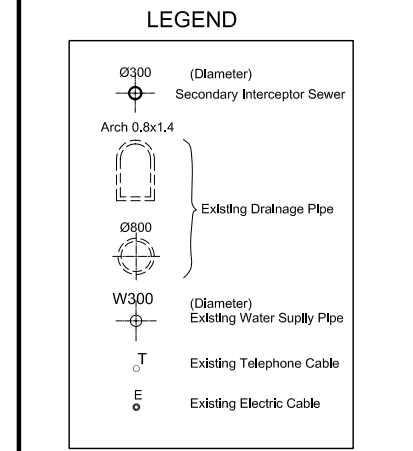
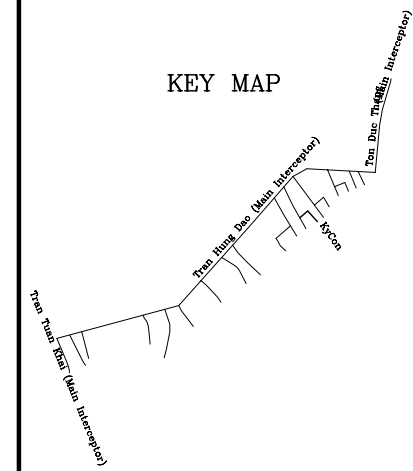
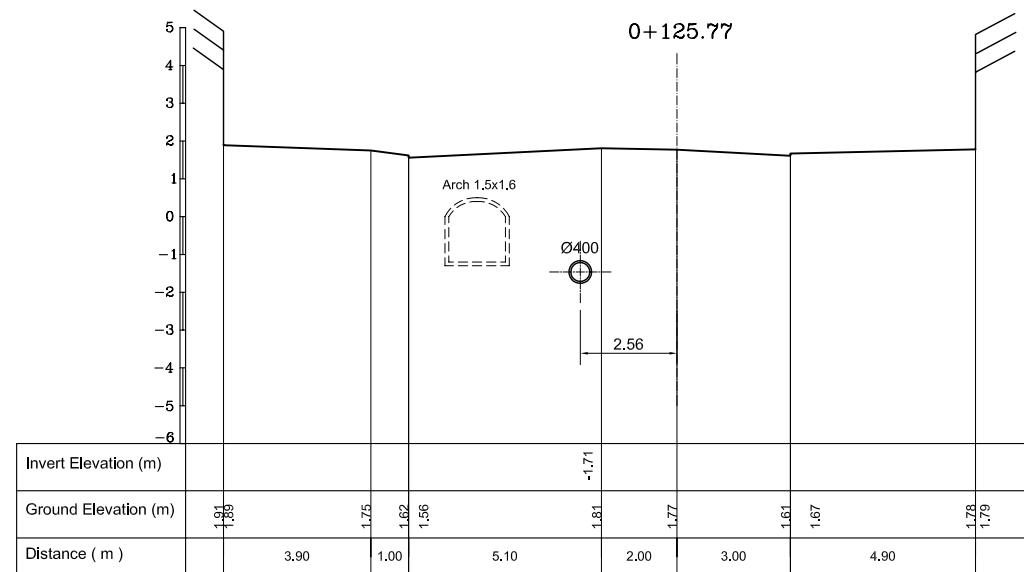
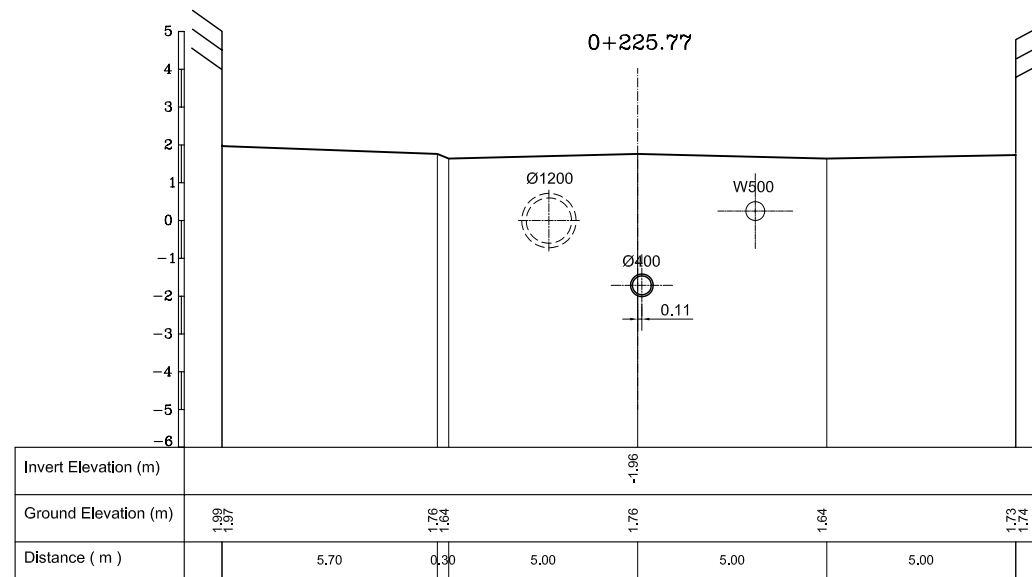
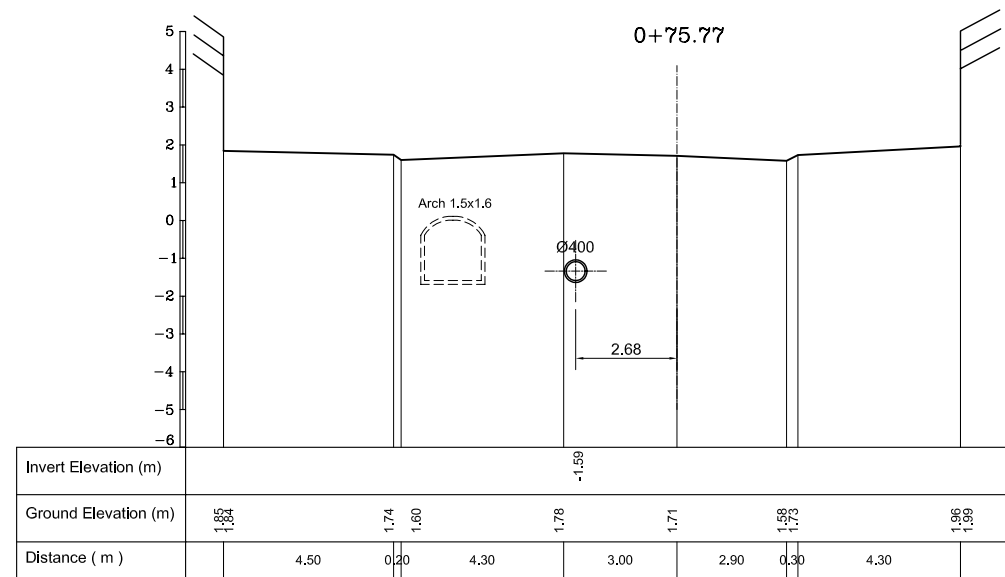
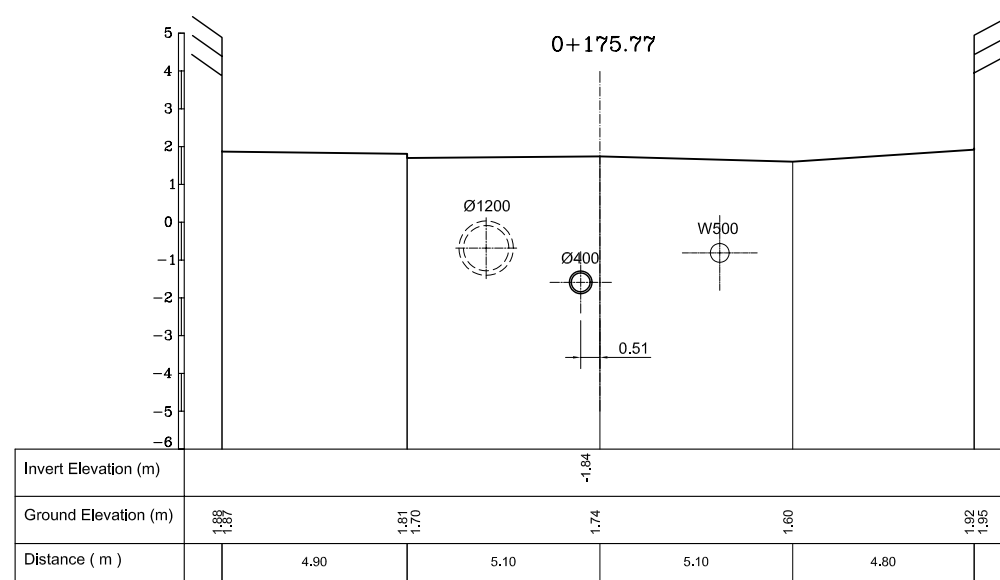
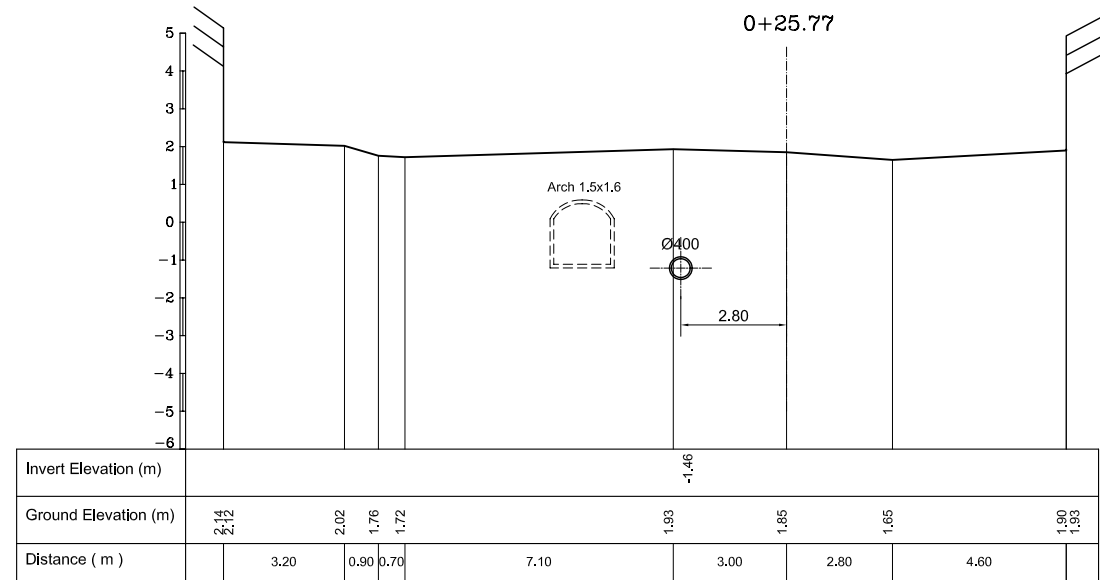

NO.	DATE	DESCRIPTIONS	BY	APRO.

REVISIONS

PROJECT MANAGEMENT UNIT FOR  
HO CHI MINH CITY  
WATER ENVIRONMENT IMPROVEMENT

THE DETAILED DESIGN ON HO CHI MINH CITY  
WATER ENVIRONMENT IMPROVEMENT PROJECT  
IN THE SOCIALIST REPUBLIC OF VIET NAM

PACKAGE C  
INTERCEPTOR SEWER CONSTRUCTION  
**CROSS SECTION OF  
SECONDARY INTERCEPTOR (8)  
(KYCON)**

SCALE : 1 : 100

JAPAN INTERNATIONAL COOPERATION AGENCY ( JICA )

PACIFIC CONSULTANTS INTERNATIONAL

DESIGNED SATO NOBUYUKI	CHECKED KONDO MASAMI
---------------------------	-------------------------

DATE : JUNE 2001      DWG. No. PC - ISC - 265

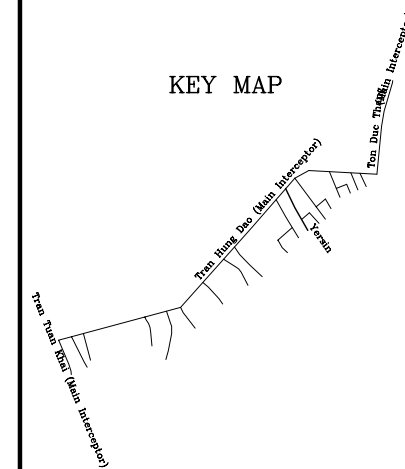
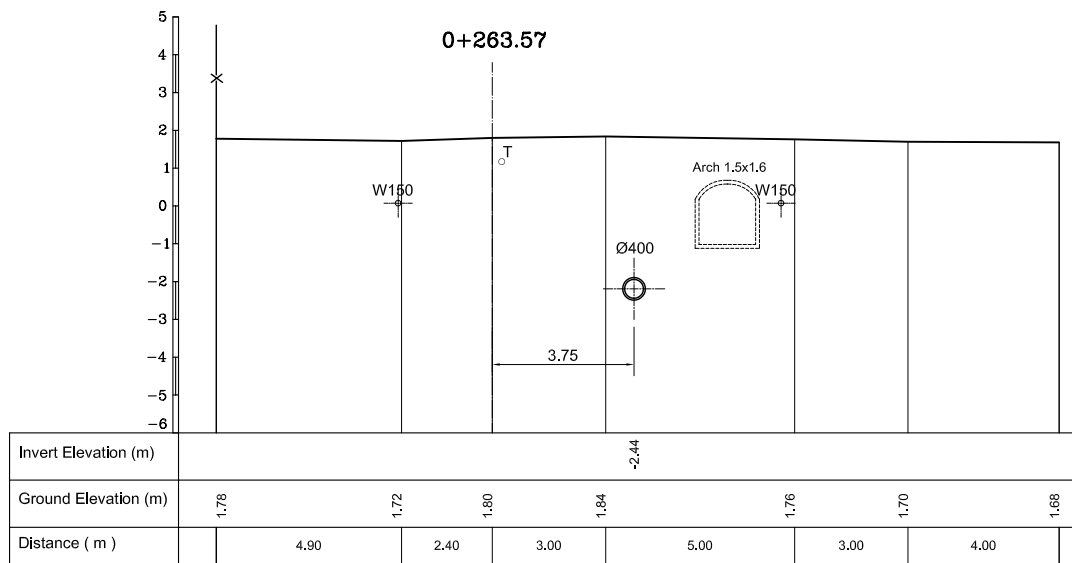
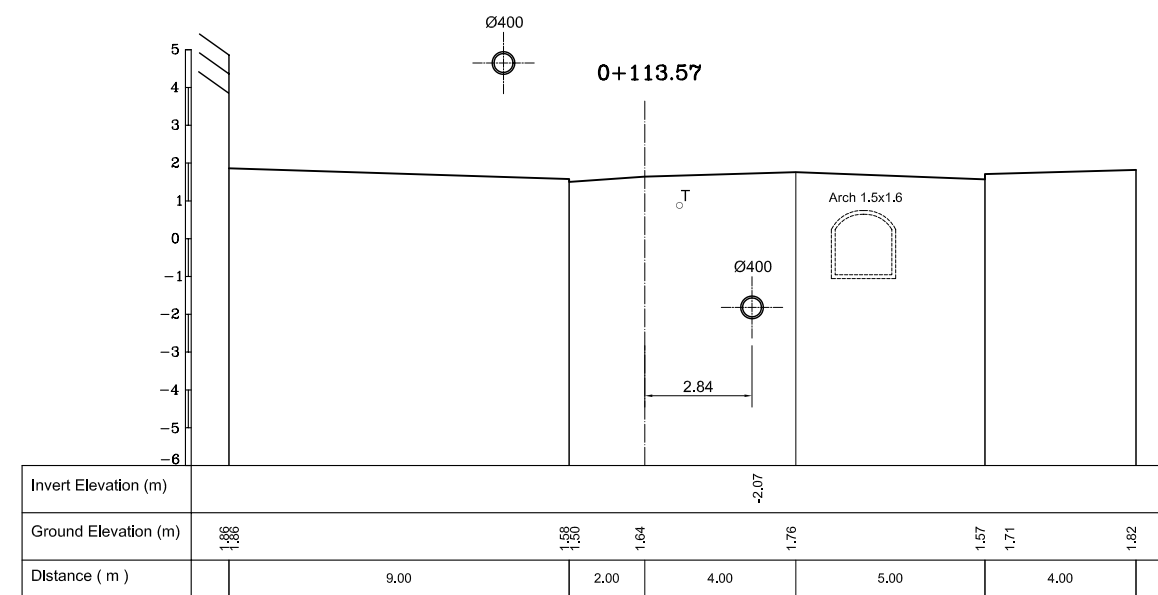
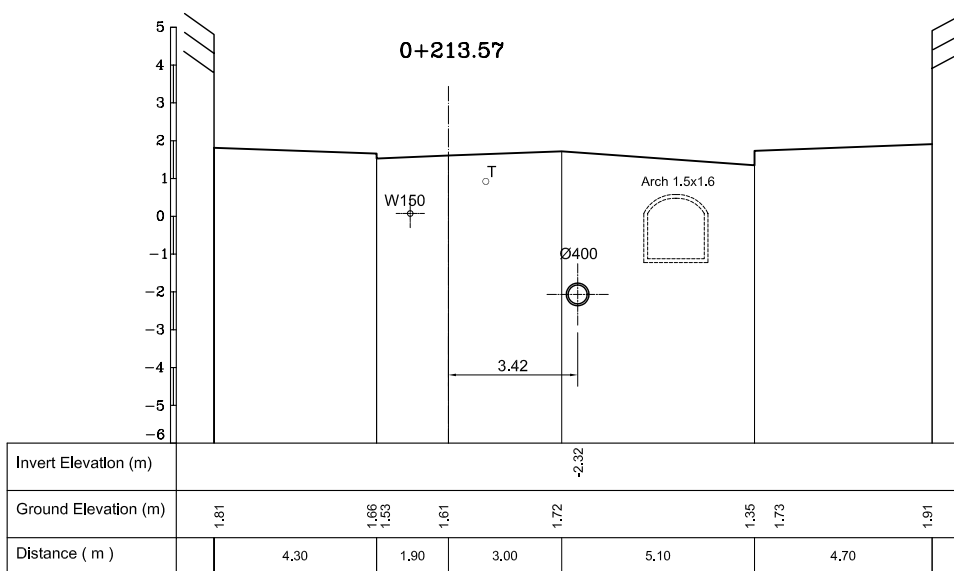
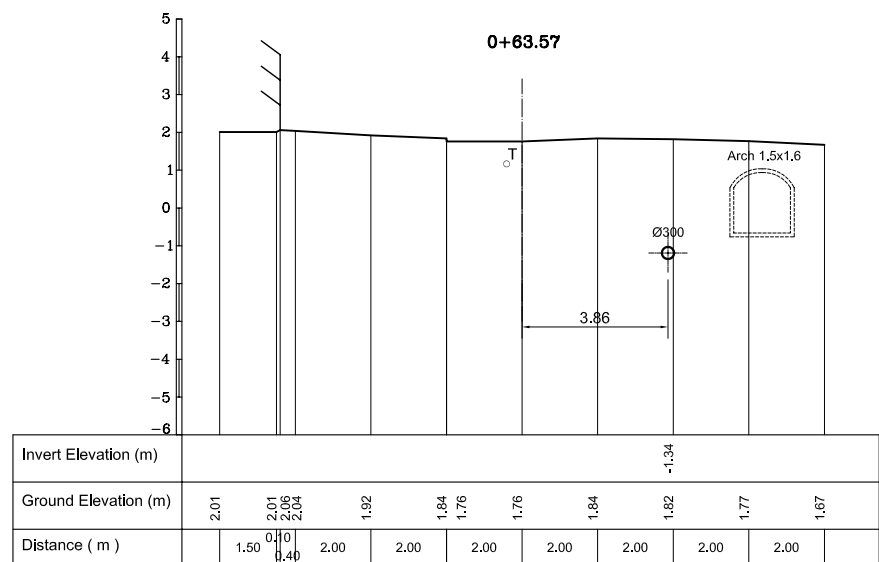
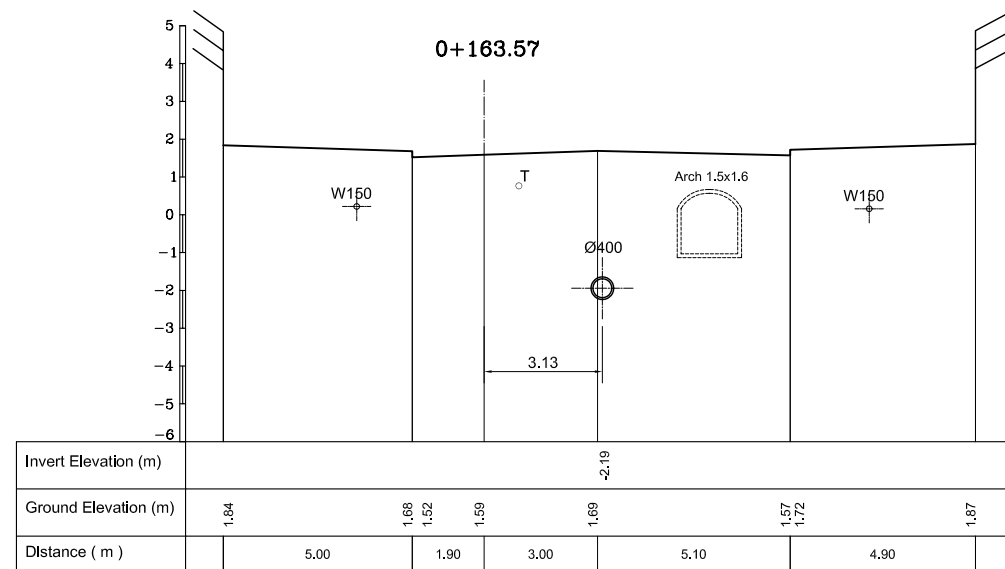
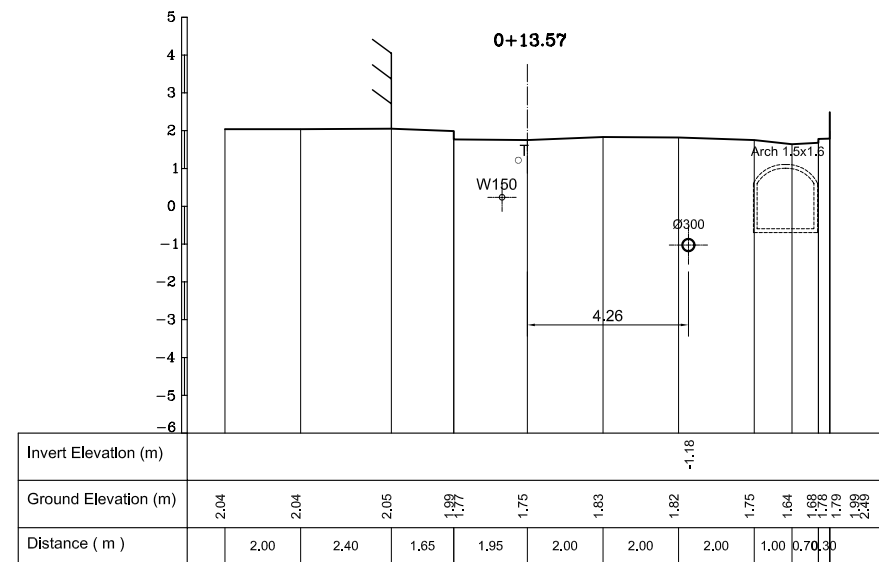

**LEGEND**

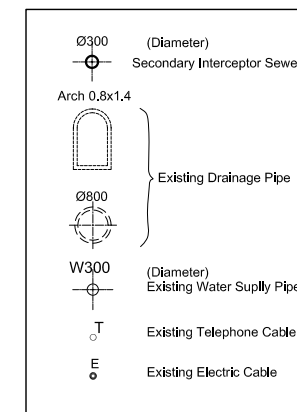

NO.	DATE	DESCRIPTIONS	BY	APRO.
-----	------	--------------	----	-------

REVISIONS

PROJECT MANAGEMENT UNIT FOR  
HO CHI MINH CITY  
WATER ENVIRONMENT IMPROVEMENT

THE DETAILED DESIGN ON HO CHI MINH CITY  
WATER ENVIRONMENT IMPROVEMENT PROJECT  
IN THE SOCIALIST REPUBLIC OF VIET NAM

PACKAGE C  
INTERCEPTOR SEWER CONSTRUCTION  
CROSS SECTION OF  
SECONDARY INTERCEPTOR (9)  
(YERSIN)

SCALE : 1 : 100

JICA JAPAN INTERNATIONAL COOPERATION AGENCY ( JICA )

PACIFIC CONSULTANTS INTERNATIONAL

DESIGNED SATO NOBUYUKI CHECKED KONDO MASAMI

DATE : JUNE 2001 DWG. No. PC - ISC - 266

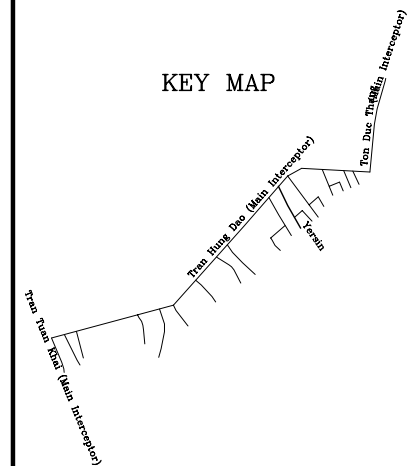
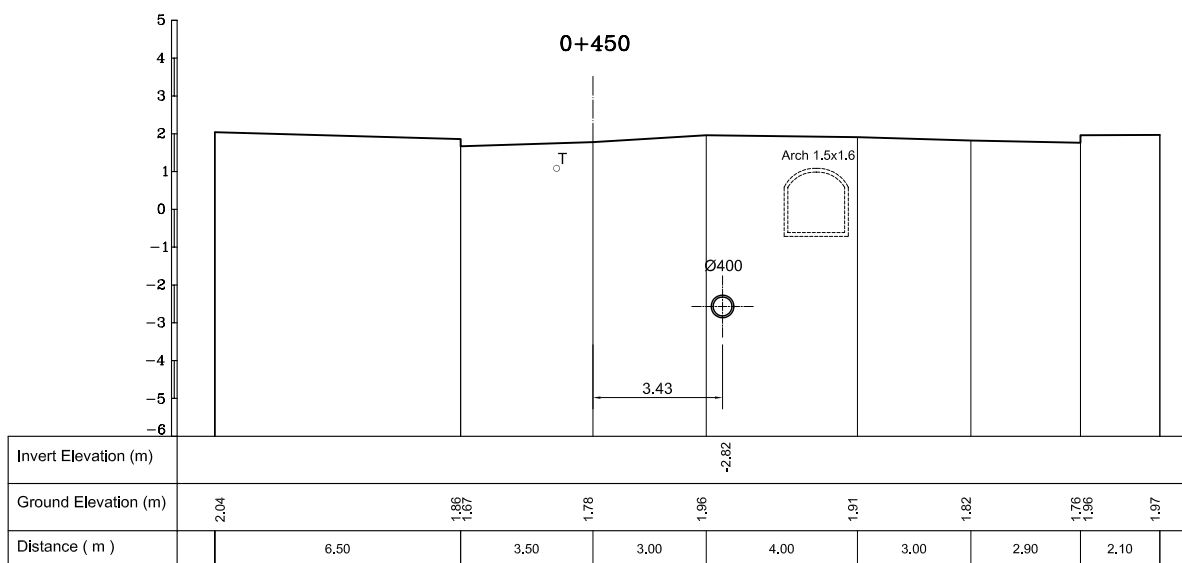
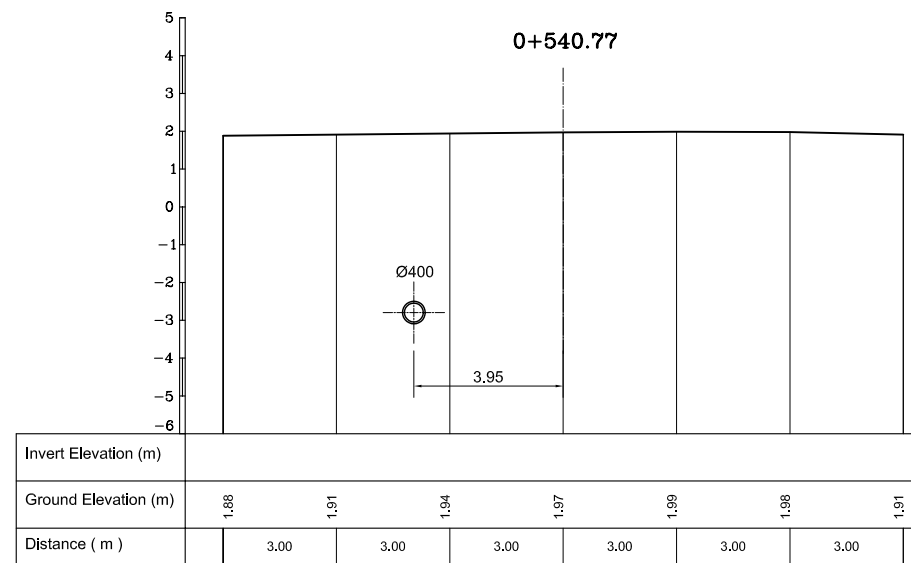
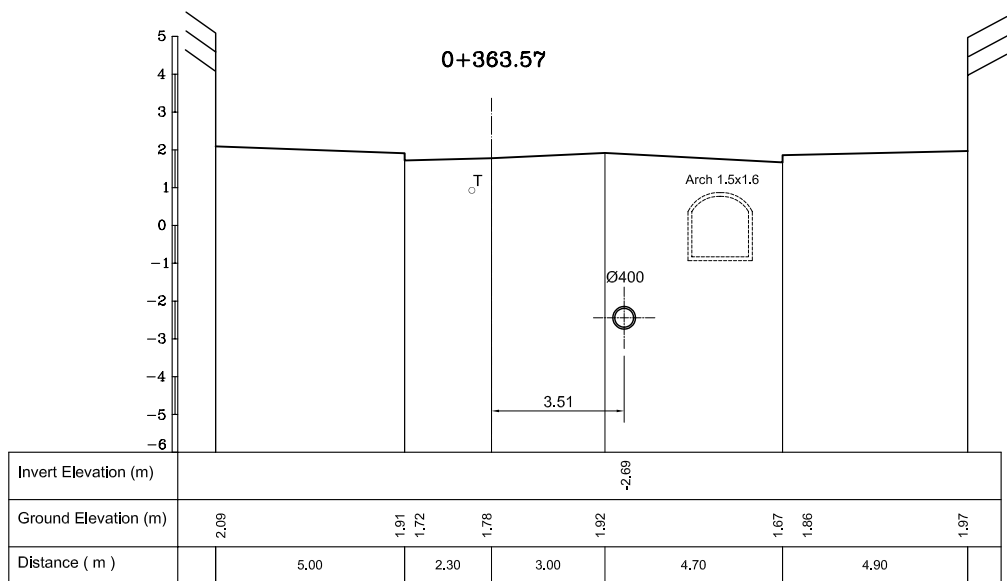
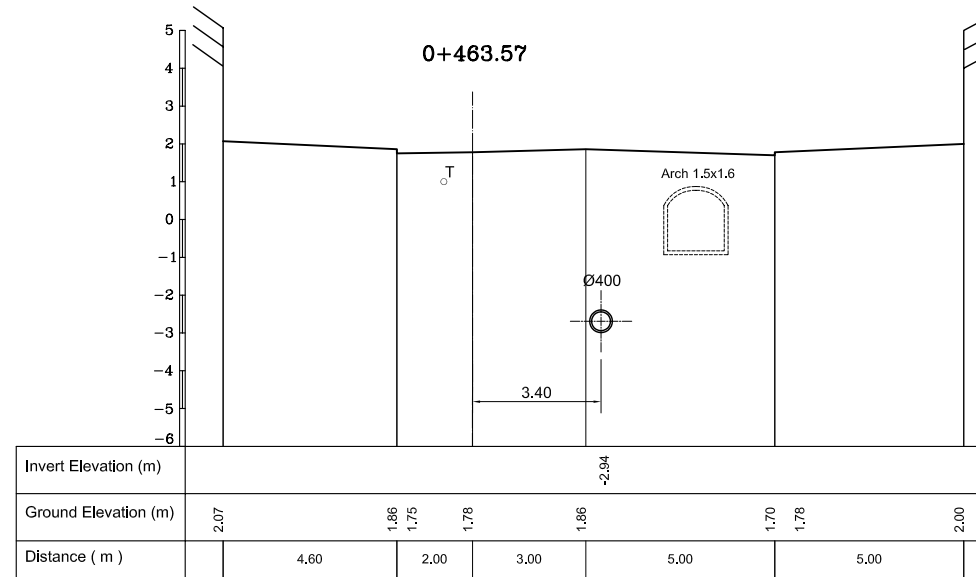
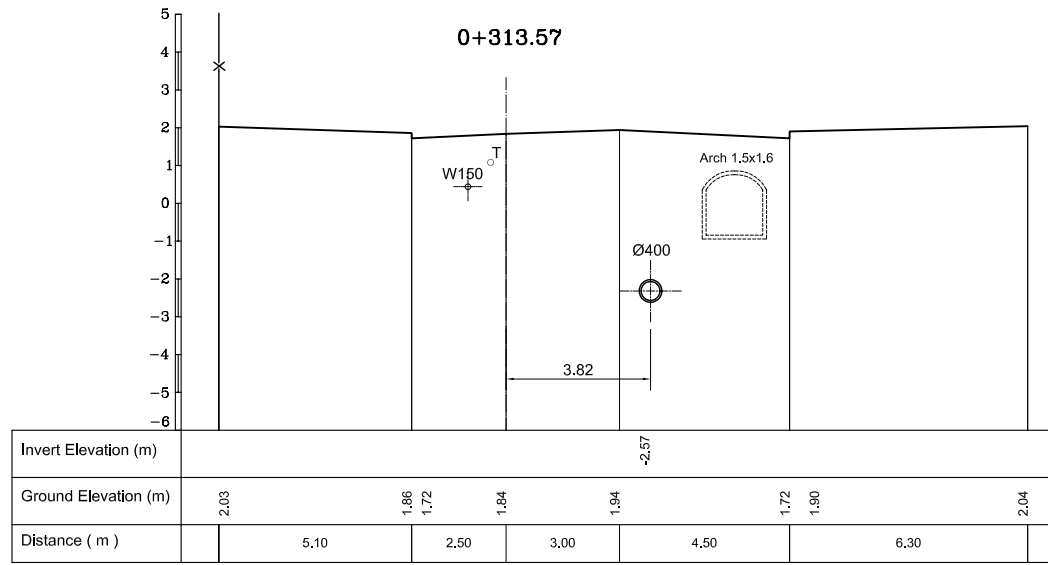

**LEGEND**

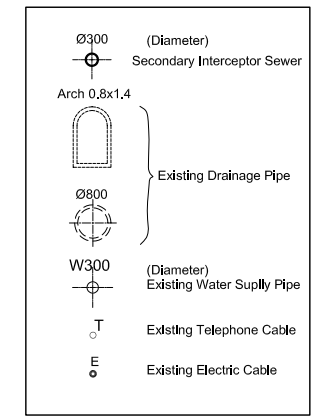

NO.	DATE	DESCRIPTIONS	BY	APRO.

REVISIONS				
PROJECT MANAGEMENT UNIT FOR HO CHI MINH CITY WATER ENVIRONMENT IMPROVEMENT				
THE DETAILED DESIGN ON HO CHI MINH CITY WATER ENVIRONMENT IMPROVEMENT PROJECT IN THE SOCIALIST REPUBLIC OF VIET NAM				
PACKAGE C INTERCEPTOR SEWER CONSTRUCTION				
CROSS SECTION OF SECONDARY INTERCEPTOR (10) (YERSIN)				
SCALE : 1 : 100				
JAPAN INTERNATIONAL COOPERATION AGENCY ( JICA )				
PACIFIC CONSULTANTS INTERNATIONAL				
DESIGNED SATO NOBUYUKI		CHECKED KONDO MASAMI		
DATE : JUNE 2001		DWG. No. PC - ISC - 267		



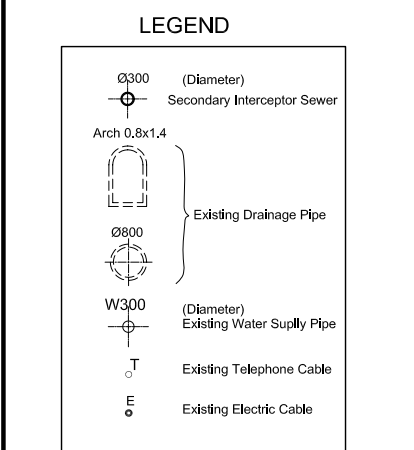
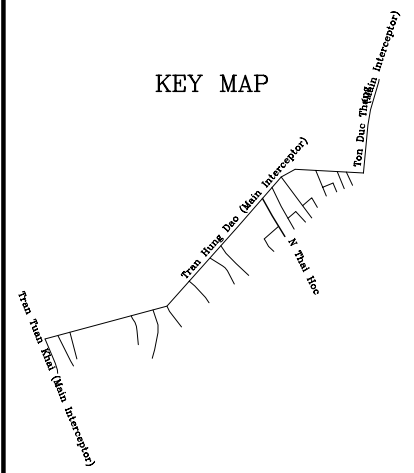
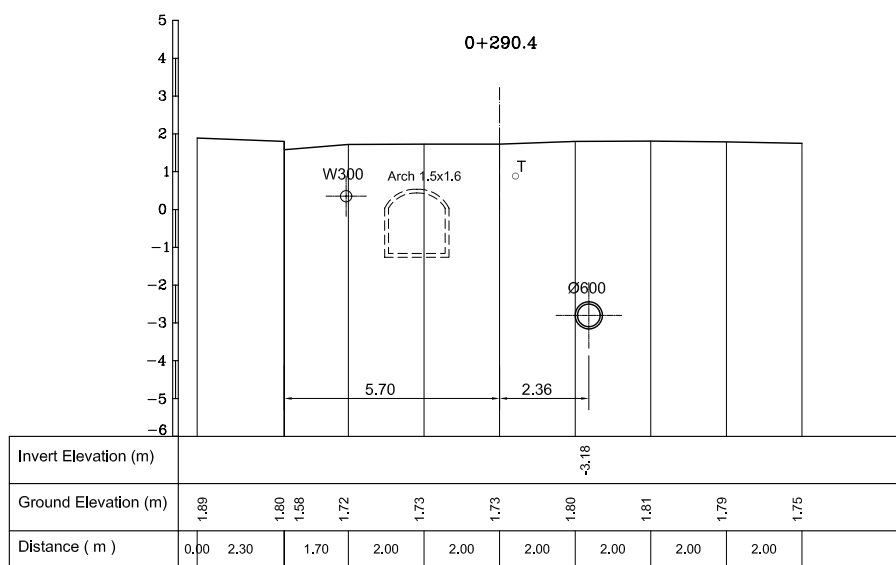
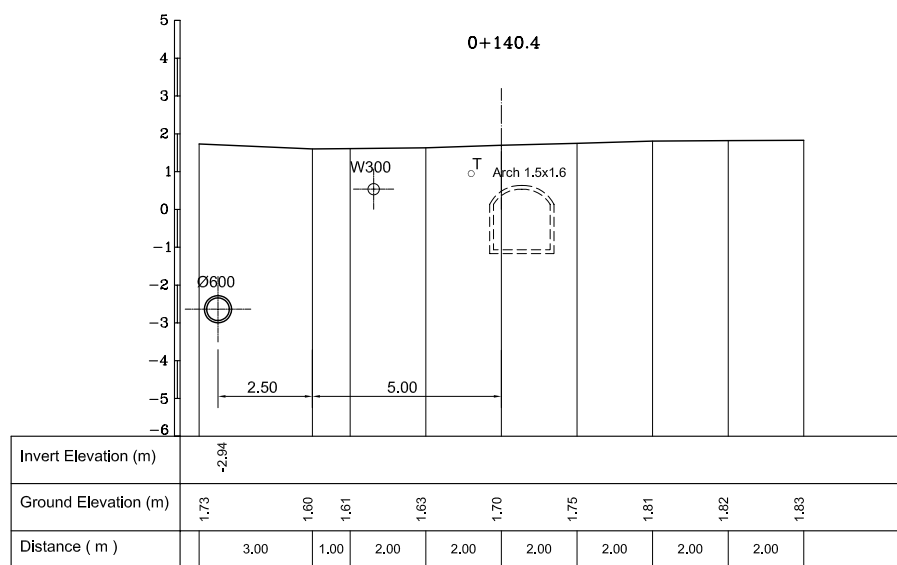
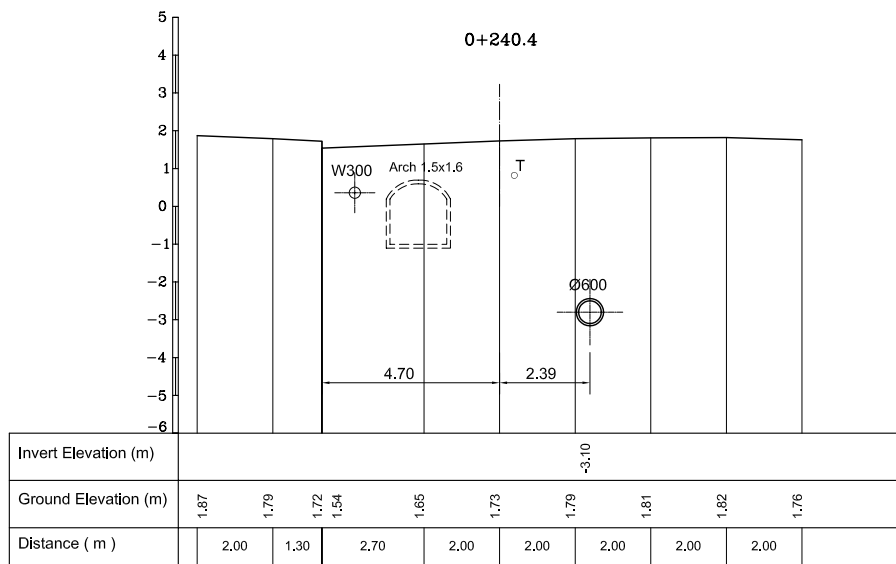
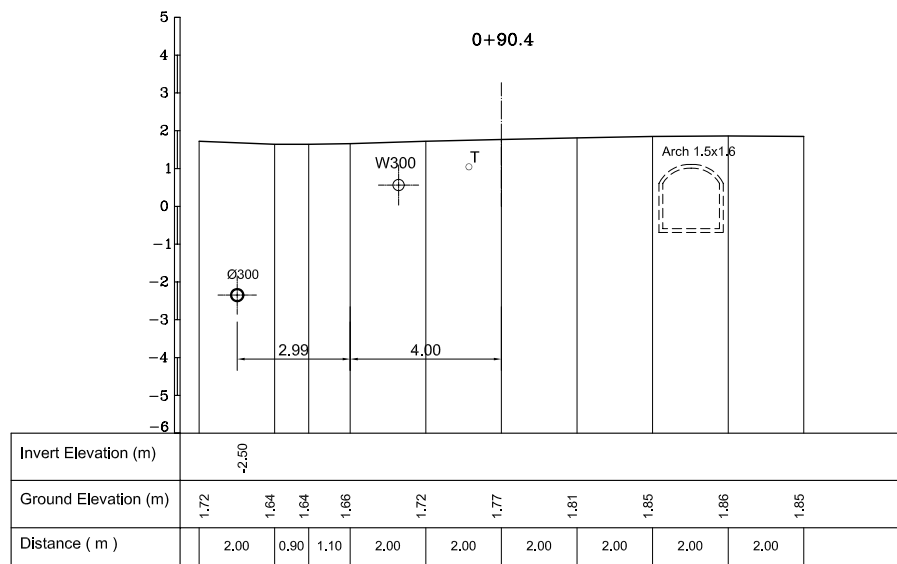
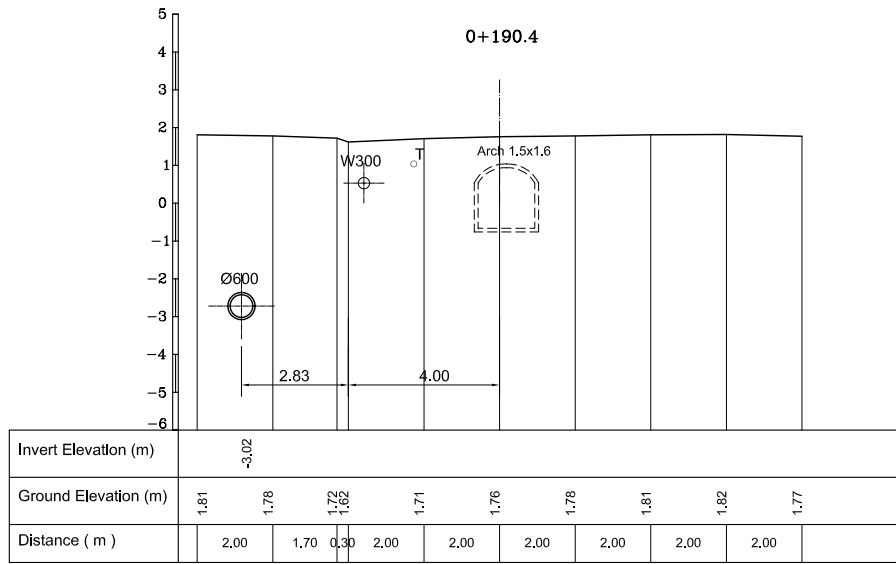
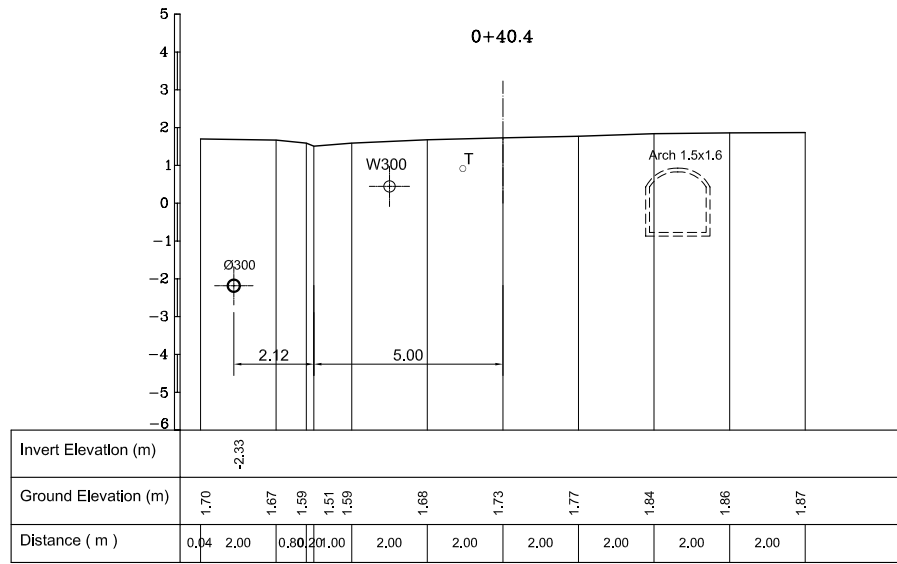

NO.	DATE	DESCRIPTIONS	BY	APRO.

REVISIONS

PROJECT MANAGEMENT UNIT FOR  
HO CHI MINH CITY  
WATER ENVIRONMENT IMPROVEMENT

THE DETAILED DESIGN ON HO CHI MINH CITY  
WATER ENVIRONMENT IMPROVEMENT PROJECT  
IN THE SOCIALIST REPUBLIC OF VIET NAM

PACKAGE C  
INTERCEPTOR SEWER CONSTRUCTION  
CROSS SECTION OF  
SECONDARY INTERCEPTOR (11)  
(NGUYEN THAI HOC)

SCALE : 1 : 100

JICA JAPAN INTERNATIONAL COOPERATION  
AGENCY ( JICA )

PACIFIC CONSULTANTS INTERNATIONAL

DESIGNED: SATO NOBUYUKI  
CHECKED: KONDO MASAMI

DATE : JUNE 2001 DWG. No. PC - ISC -268