

NO.	DATE	DESCRIPTIONS	BY	APRO.

REVISIONS

PROJECT MANAGEMENT UNIT FOR
HO CHI MINH CITY
WATER ENVIRONMENT IMPROVEMENT

THE DETAILED DESIGN ON HO CHI MINH CITY
WATER ENVIRONMENT IMPROVEMENT PROJECT
IN THE SOCIALIST REPUBLIC OF VIET NAM

PACKAGE C
INTERCEPTOR SEWER CONSTRUCTION

**CROSS SECTION
OF MAIN INTERCEPTOR (4)**

SCALE : 1 / 100

JICA JAPAN INTERNATIONAL COOPERATION AGENCY (JICA)

PACIFIC CONSULTANTS INTERNATIONAL

DESIGNED SATO NOBUYUKI	CHECKED KONDO MASAMI
---------------------------	-------------------------

DATE : JUNE 2001 DWG. No. PC - ISD - 252

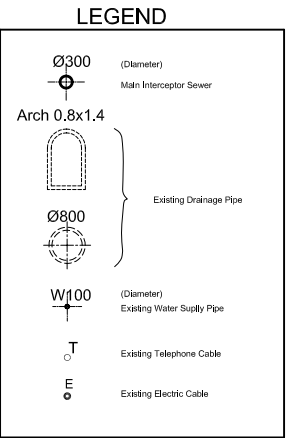
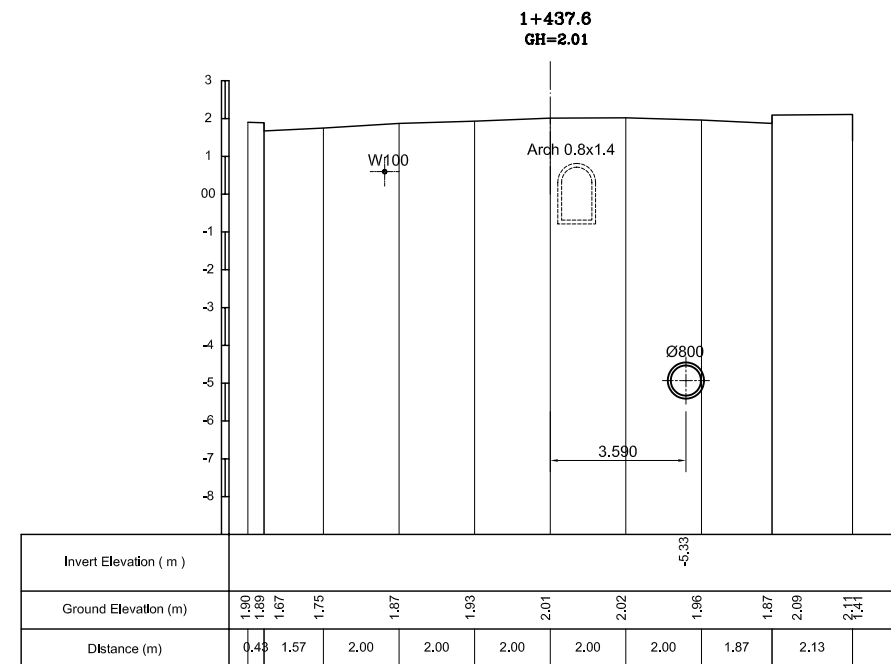
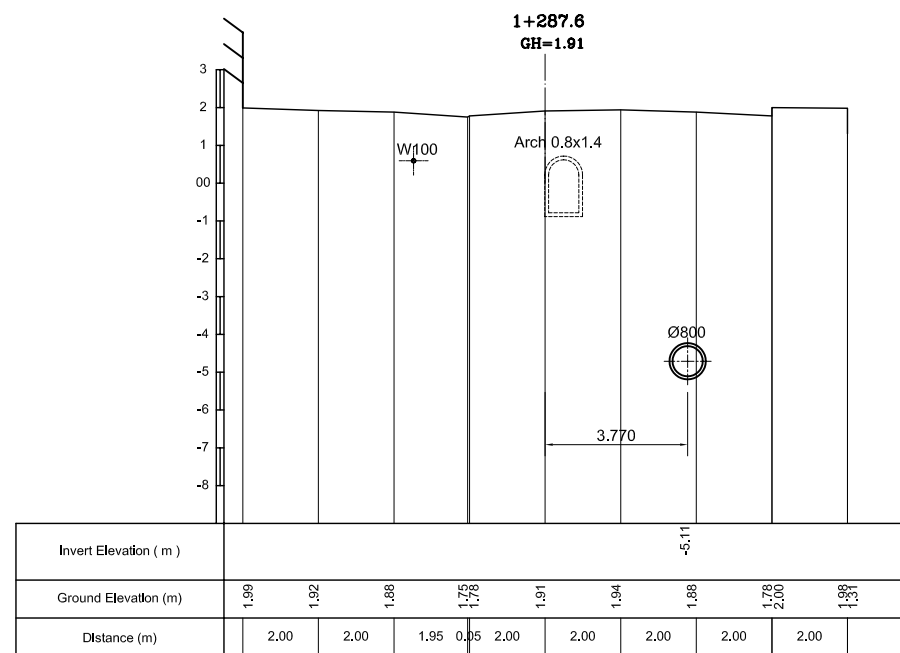
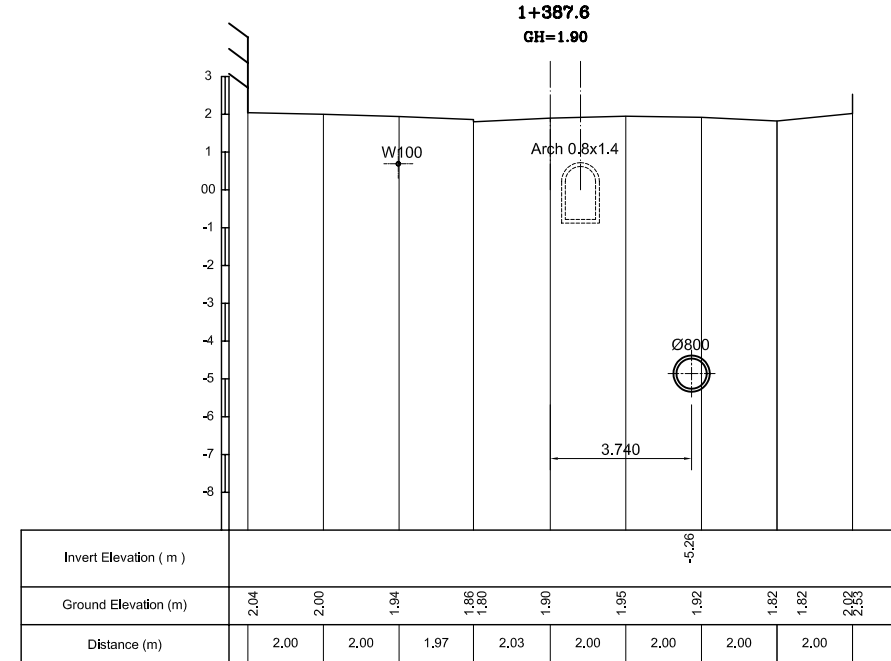
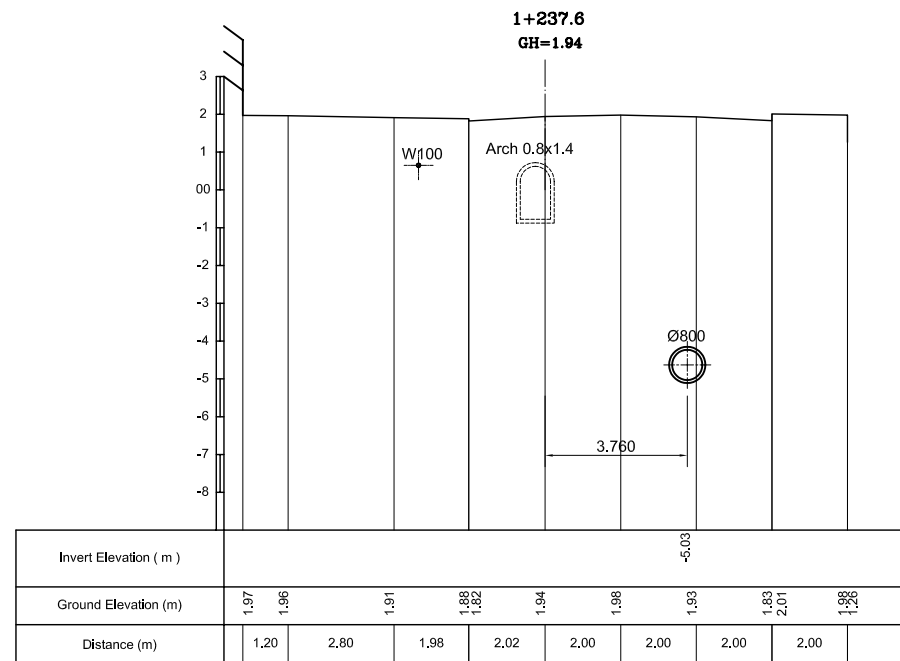
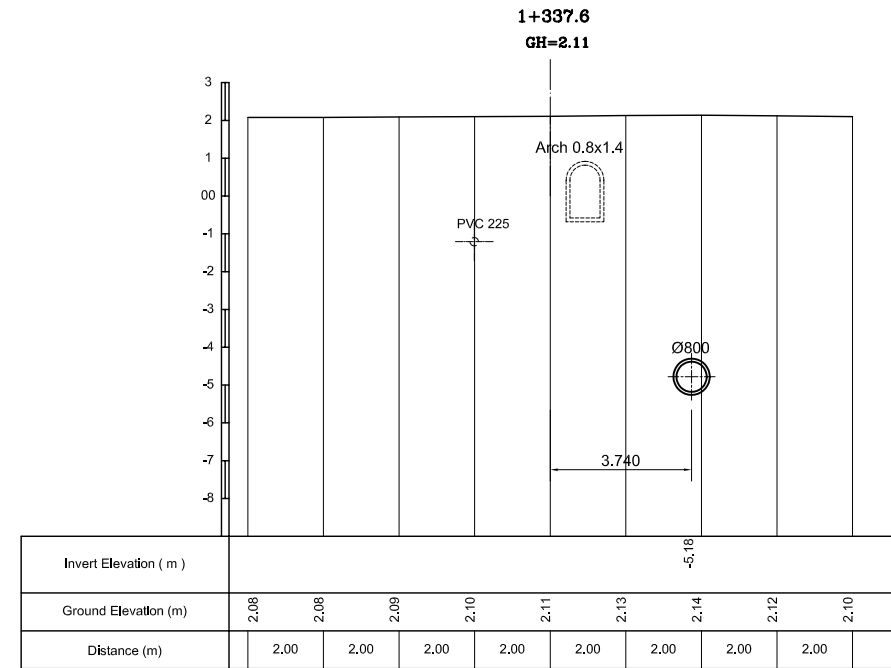
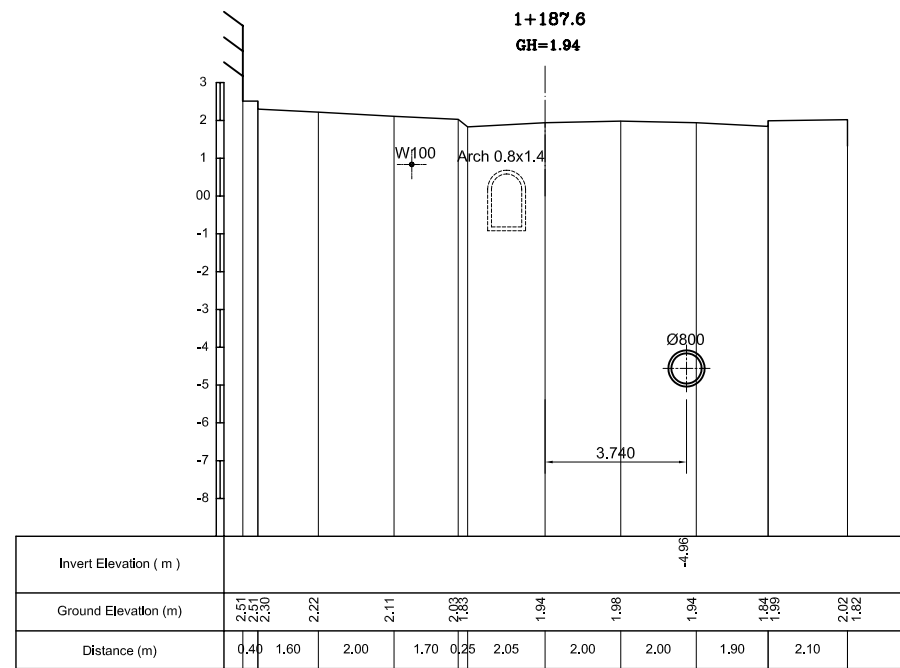

NO.	DATE	DESCRIPTIONS	BY	APRO.

REVISIONS

PROJECT MANAGEMENT UNIT FOR
HO CHI MINH CITY
WATER ENVIRONMENT IMPROVEMENT

THE DETAILED DESIGN ON HO CHI MINH CITY
WATER ENVIRONMENT IMPROVEMENT PROJECT
IN THE SOCIALIST REPUBLIC OF VIET NAM

PACKAGE C
INTERCEPTOR SEWER CONSTRUCTION

**CROSS SECTION
OF MAIN INTERCEPTOR (5)**

SCALE : 1 / 100

JICA JAPAN INTERNATIONAL COOPERATION
AGENCY (JICA)

PACIFIC CONSULTANTS INTERNATIONAL

DESIGNED SATO NOBUYUKI	CHECKED KONDO MASAMI
---------------------------	-------------------------

DATE : JUNE 2001 DWG. No. PC - ISC - 253

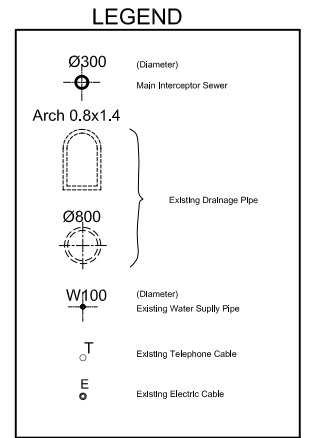
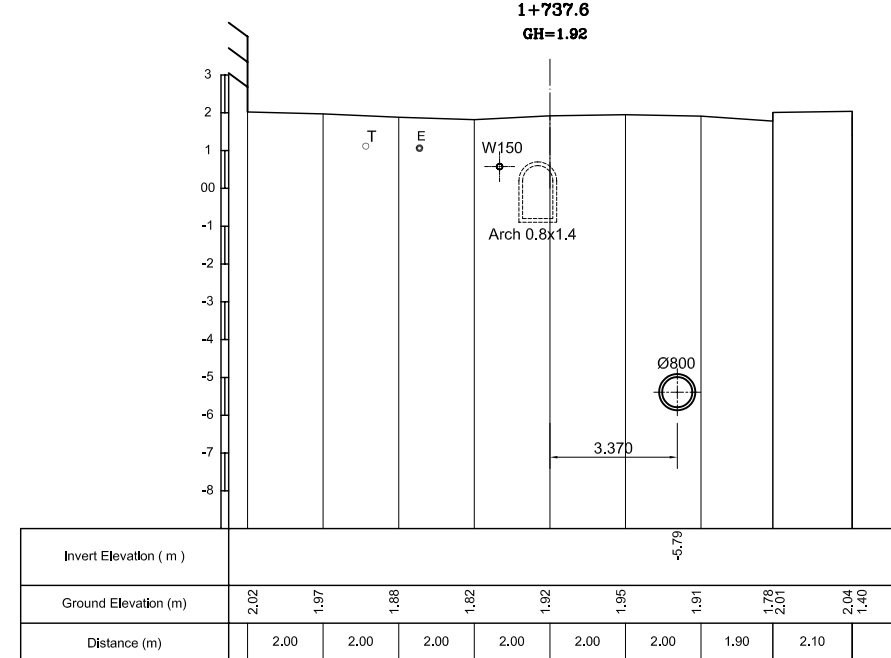
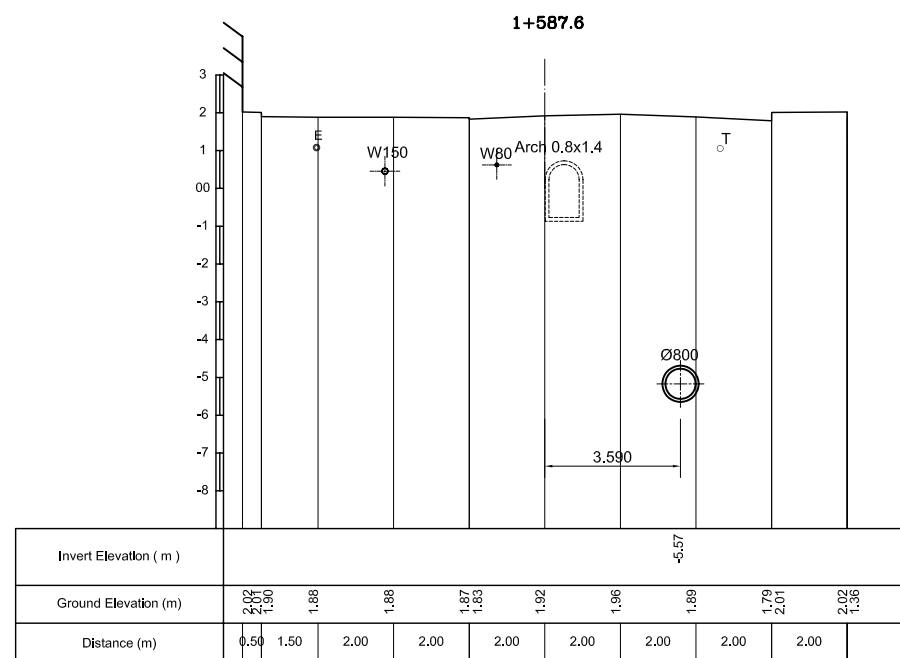
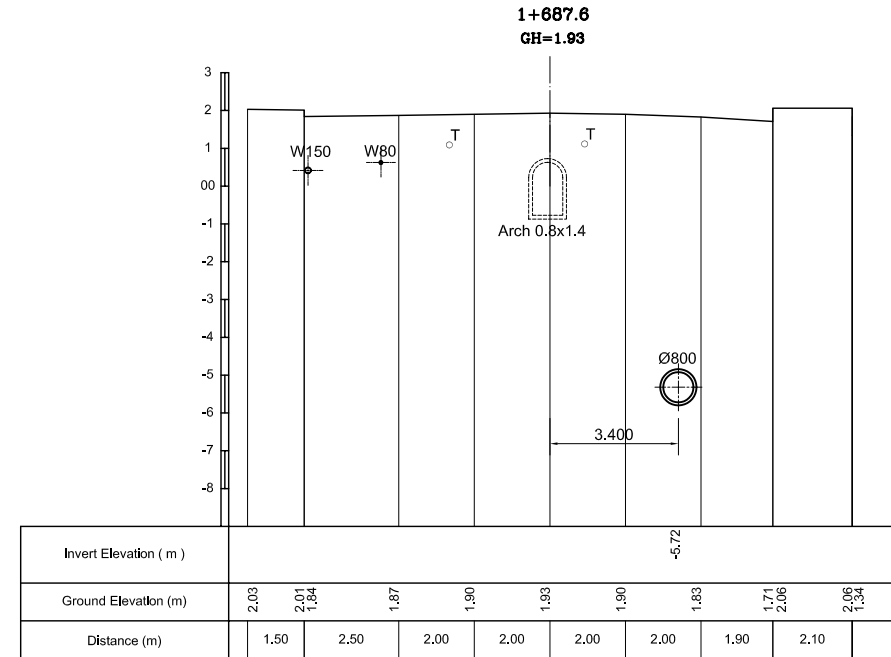
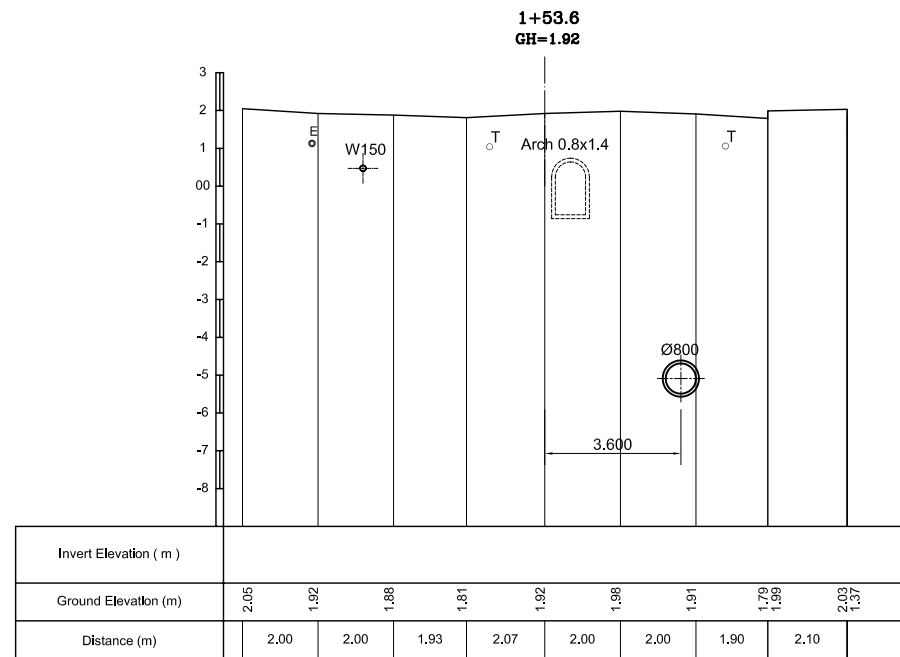
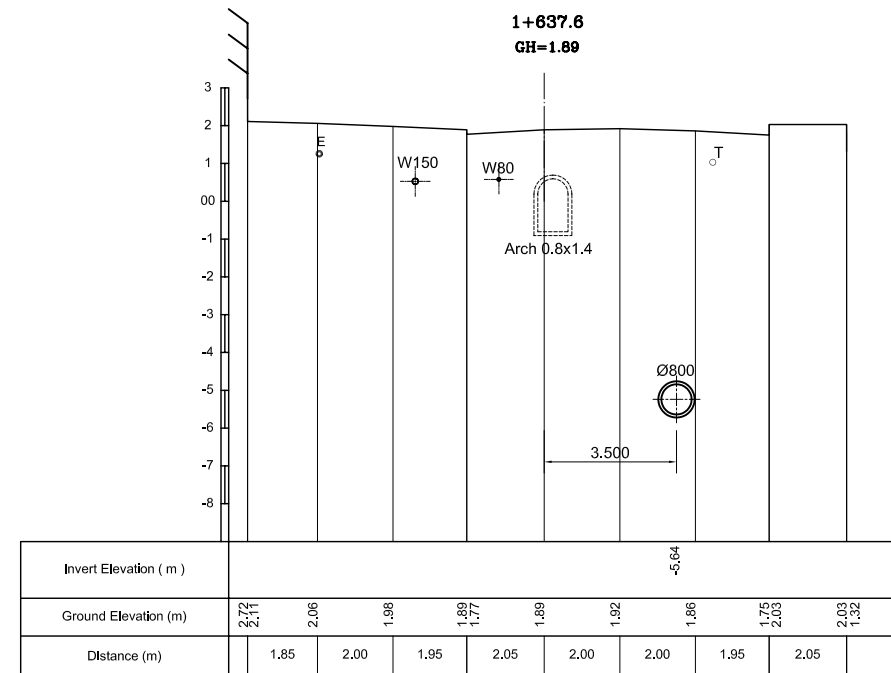
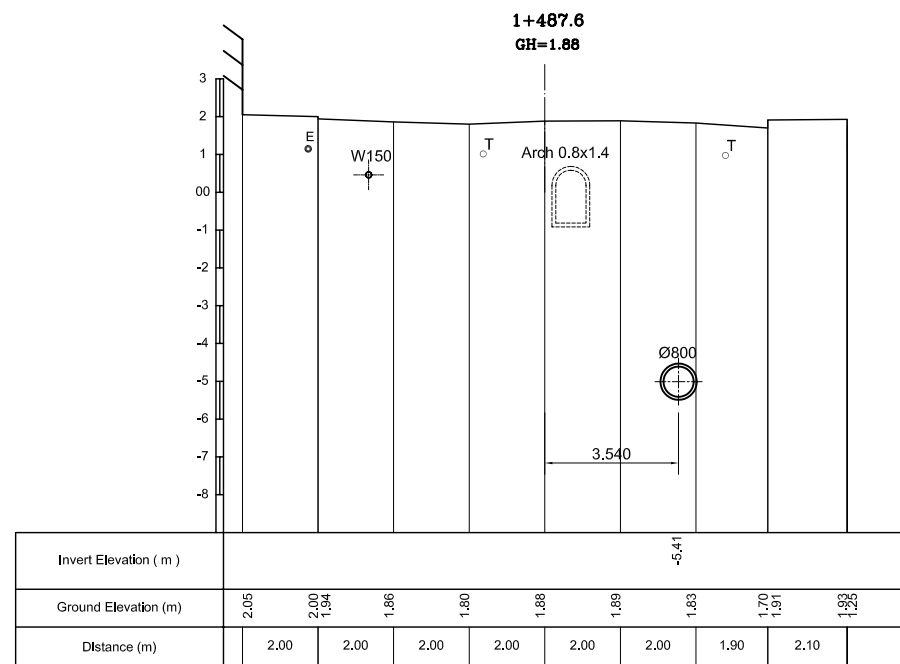

NO.	DATE	DESCRIPTIONS	BY	APRO.

REVISIONS

PROJECT MANAGEMENT UNIT FOR
HO CHI MINH CITY
WATER ENVIRONMENT IMPROVEMENT

THE DETAILED DESIGN ON HO CHI MINH CITY
WATER ENVIRONMENT IMPROVEMENT PROJECT
IN THE SOCIALIST REPUBLIC OF VIET NAM

PACKAGE C
INTERCEPTOR SEWER CONSTRUCTION

**CROSS SECTION
OF MAIN INTERCEPTOR (6)**

SCALE : 1 / 100

JICA JAPAN INTERNATIONAL COOPERATION AGENCY (JICA)

PACIFIC CONSULTANTS INTERNATIONAL

DESIGNED SATO NOBUYUKI	CHECKED KONDO MASAMI
---------------------------	-------------------------

DATE : JUNE 2001 DWG. No. PC - ISC - 254

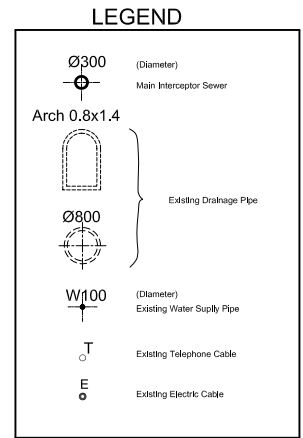
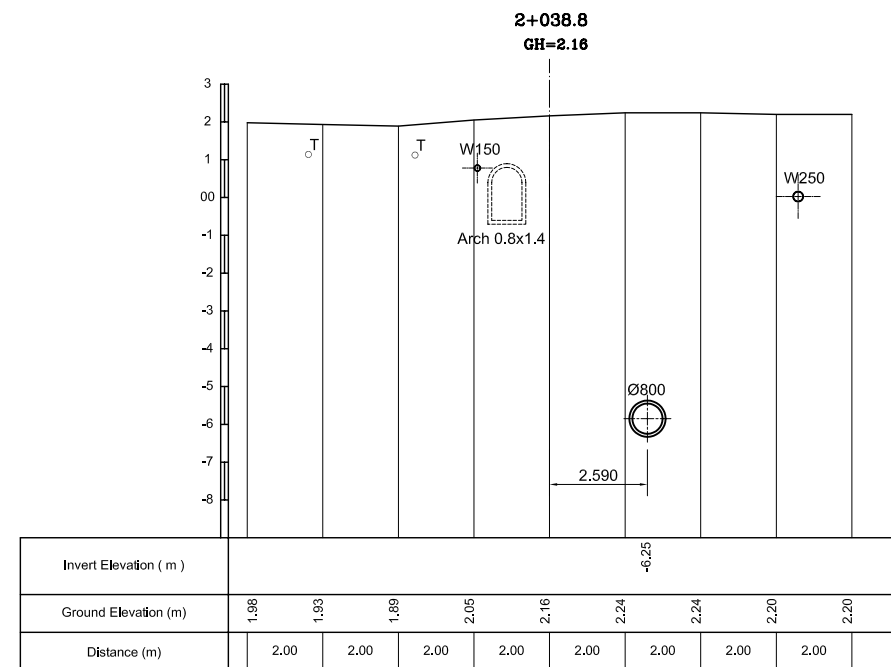
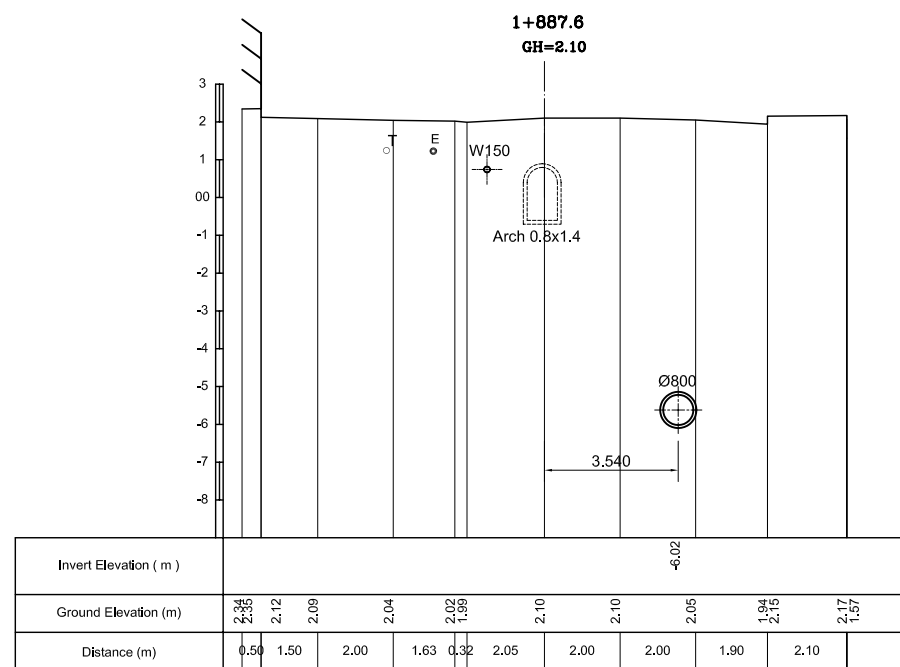
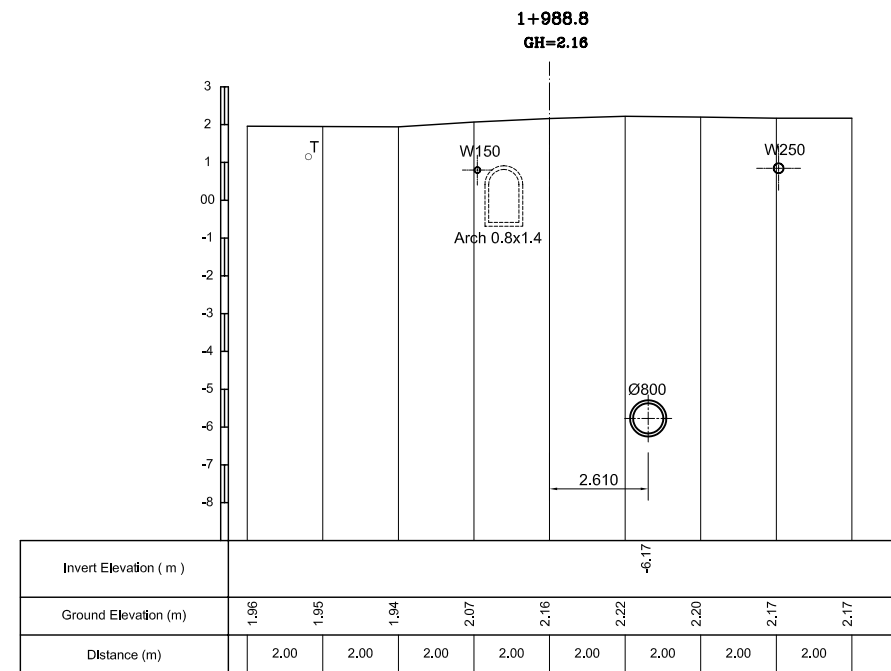
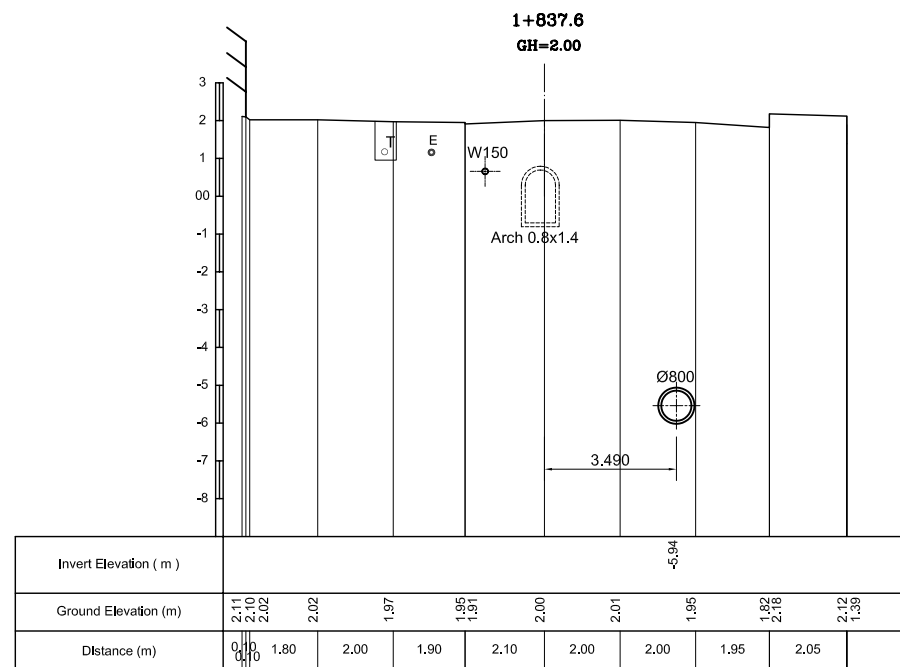
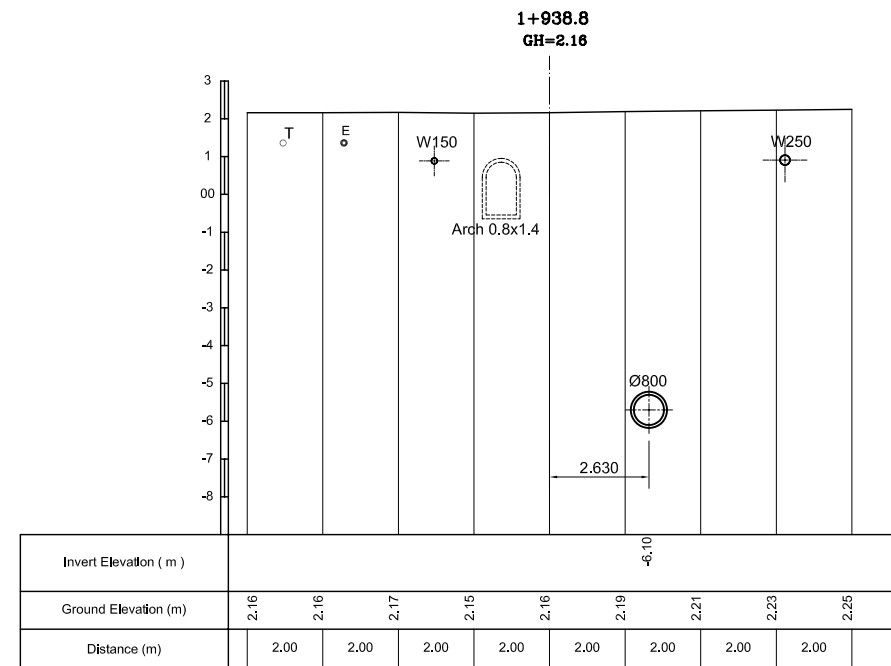
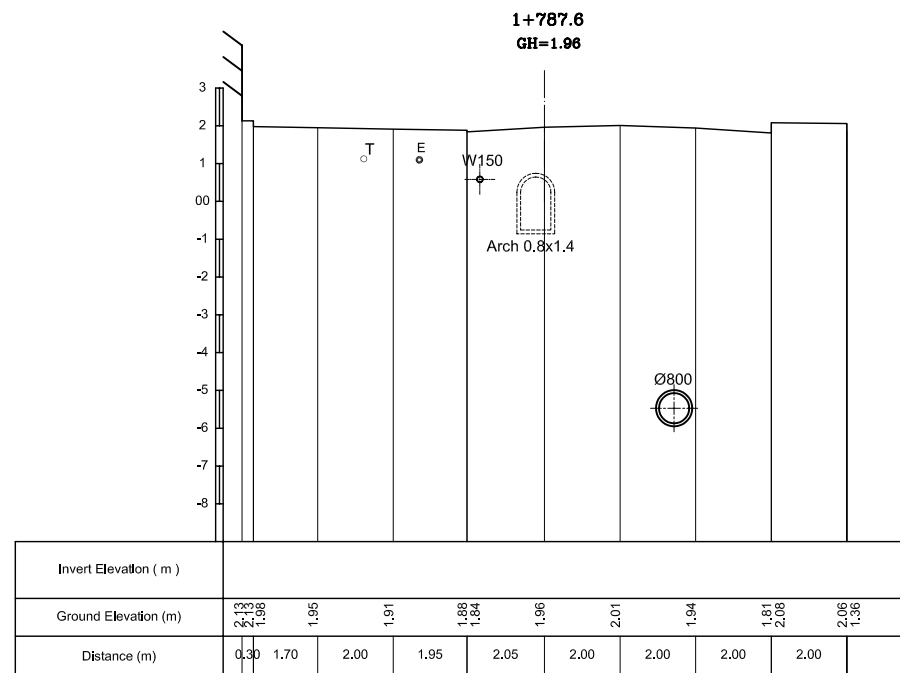

NO.	DATE	DESCRIPTIONS	BY	APRO.

REVISIONS

PROJECT MANAGEMENT UNIT FOR
HO CHI MINH CITY
WATER ENVIRONMENT IMPROVEMENT

THE DETAILED DESIGN ON HO CHI MINH CITY
WATER ENVIRONMENT IMPROVEMENT PROJECT
IN THE SOCIALIST REPUBLIC OF VIET NAM

PACKAGE C
INTERCEPTOR SEWER CONSTRUCTION

**CROSS SECTION
OF MAIN INTERCEPTOR (7)**

SCALE : 1 / 100

JICA JAPAN INTERNATIONAL COOPERATION
AGENCY (JICA)

PACIFIC CONSULTANTS INTERNATIONAL

DESIGNED SATO NOBUYUKI	CHECKED KONDO MASAMI
---------------------------	-------------------------

DATE : JUNE 2001 DWG. No. PC - ISC - 255

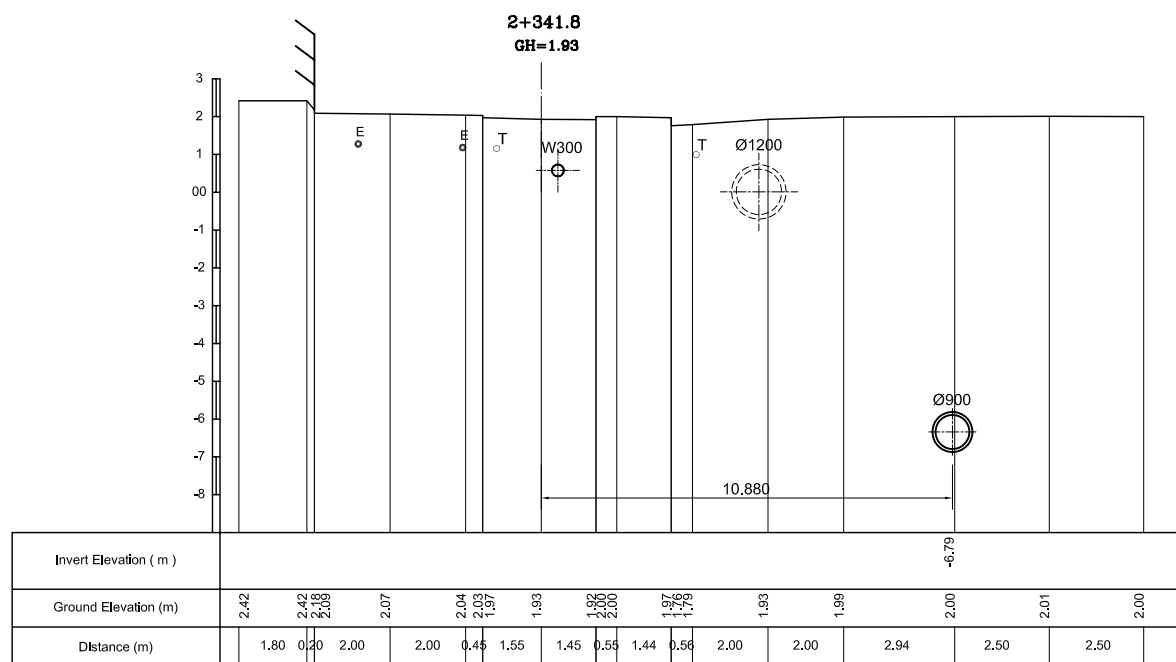
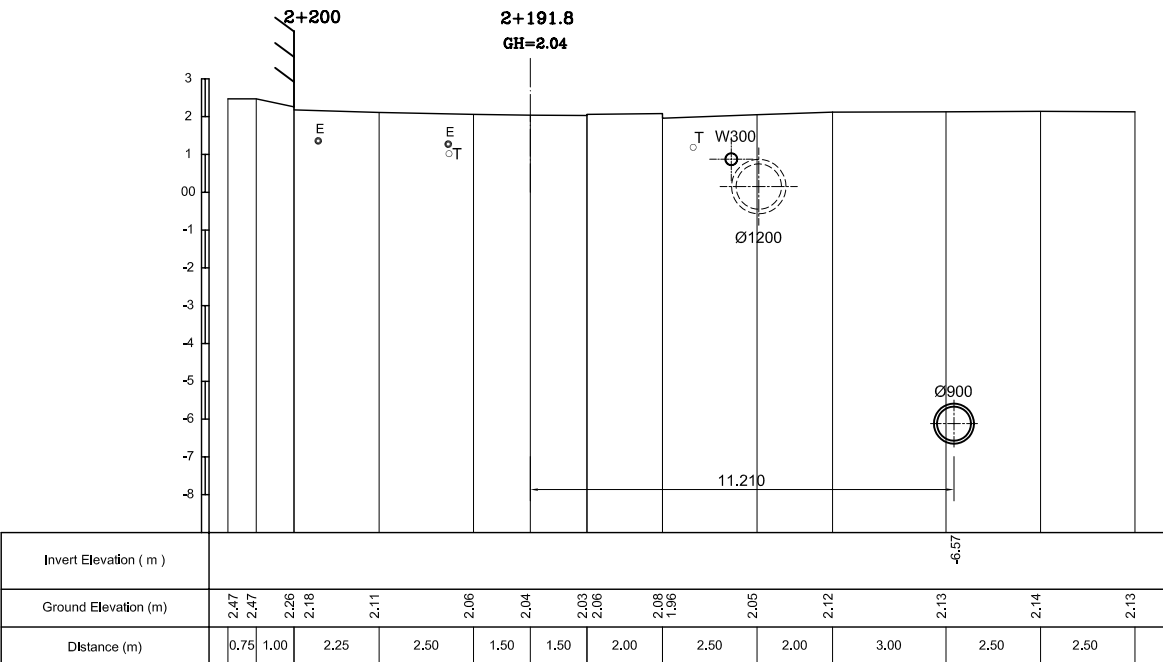
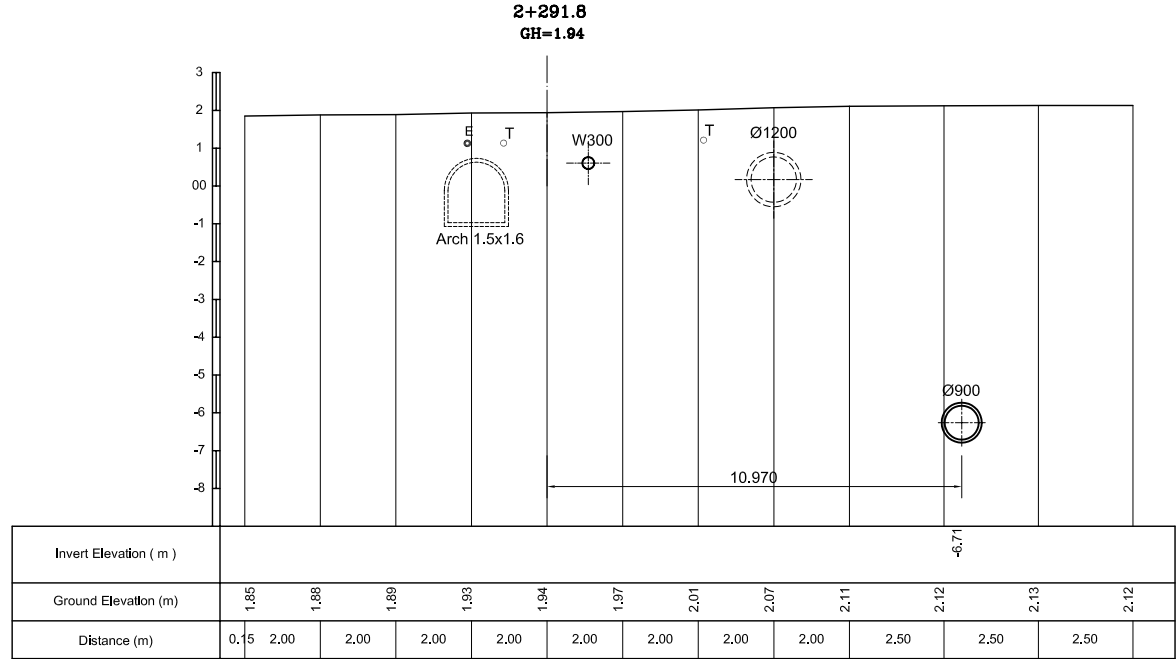
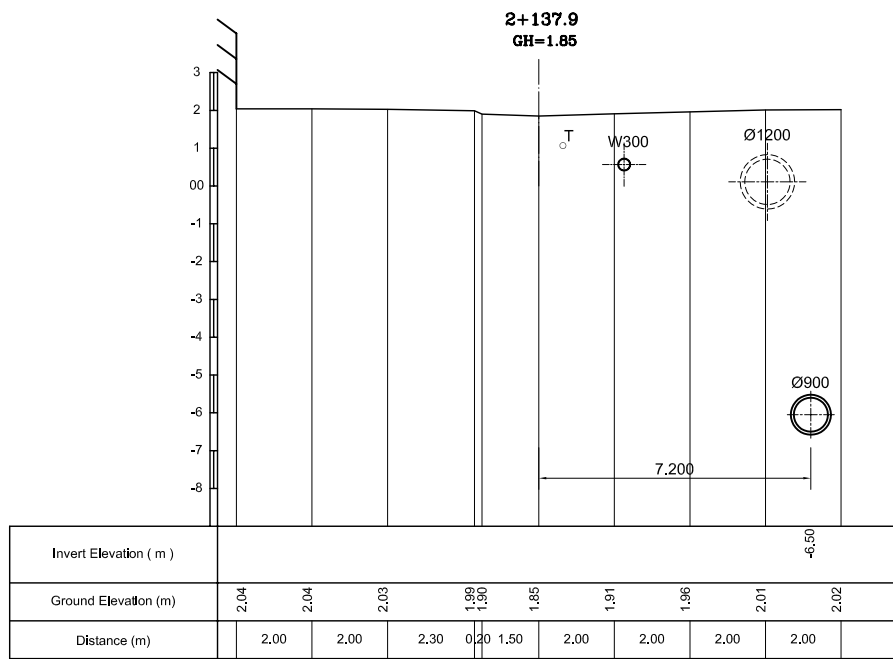
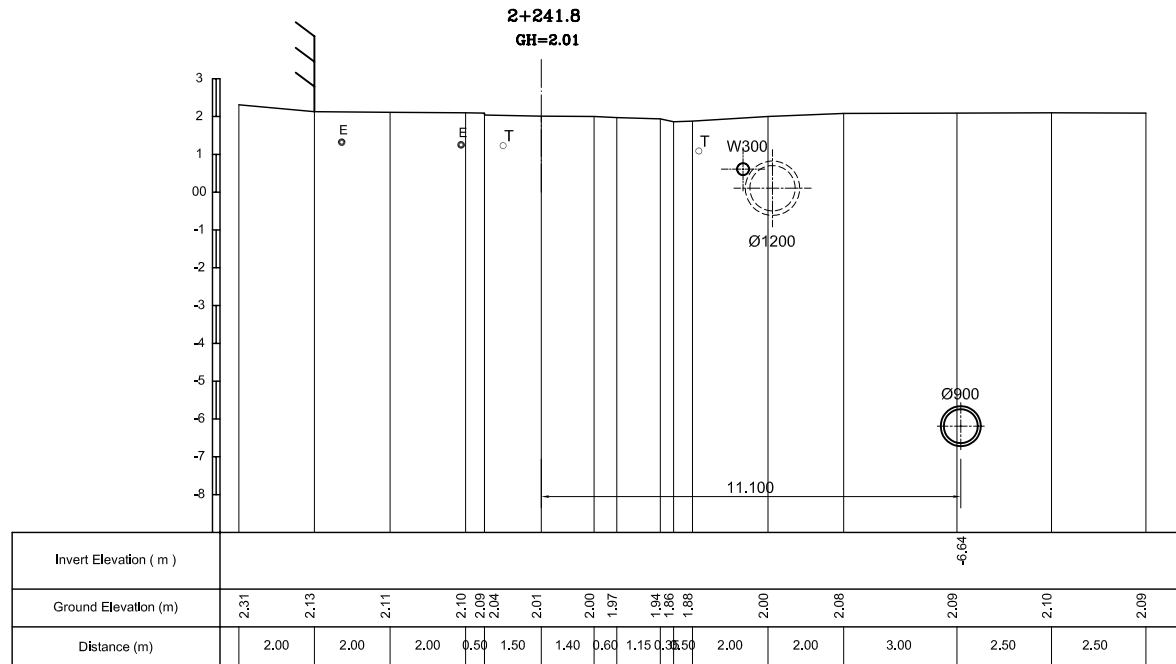
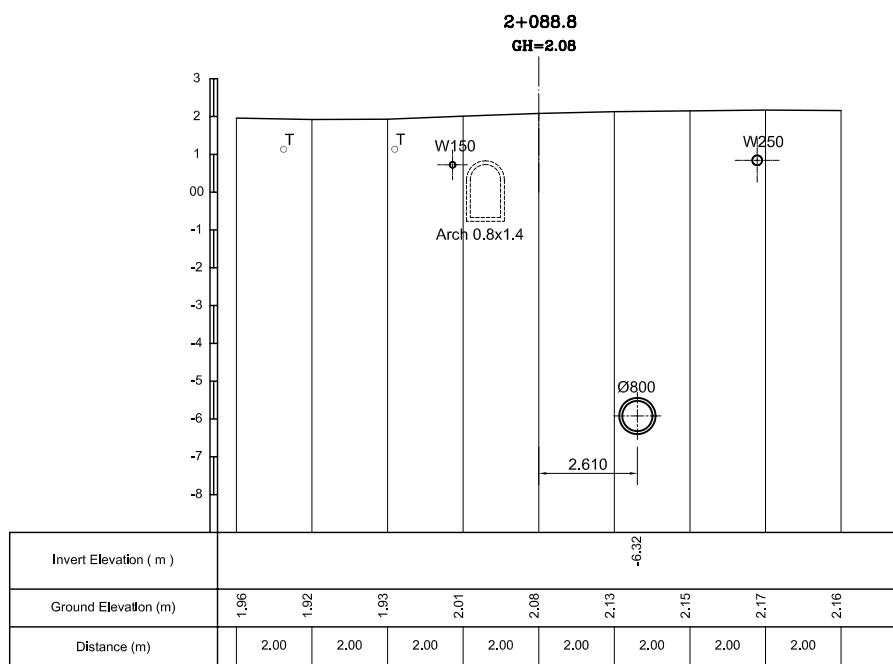

LEGEND

Ø300	(Diameter)
⊕	Main Interceptor Sewer
Arch 0.8x1.4	Existing Drainage Pipe
⊕	
Ø800	Existing Drainage Pipe
⊕	
W100	(Diameter)
⊕	Existing Water Supply Pipe
⊕	Existing Telephone Cable
⊕	Existing Electric Cable

NO.	DATE	DESCRIPTIONS	BY	APRO.

REVISIONS

PROJECT MANAGEMENT UNIT FOR
HO CHI MINH CITY
WATER ENVIRONMENT IMPROVEMENT

THE DETAILED DESIGN ON HO CHI MINH CITY
WATER ENVIRONMENT IMPROVEMENT PROJECT
IN THE SOCIALIST REPUBLIC OF VIET NAM

PACKAGE C
INTERCEPTOR SEWER CONSTRUCTION

**CROSS SECTION
OF MAIN INTERCEPTOR (8)**

SCALE : 1 / 100

JICA JAPAN INTERNATIONAL COOPERATION AGENCY (JICA)

PACIFIC CONSULTANTS INTERNATIONAL

DESIGNED SATO NOBUYUKI	CHECKED KONDO MASAMI
---------------------------	-------------------------

DATE : JUNE 2001 DWG. No. PC - ISC - 256

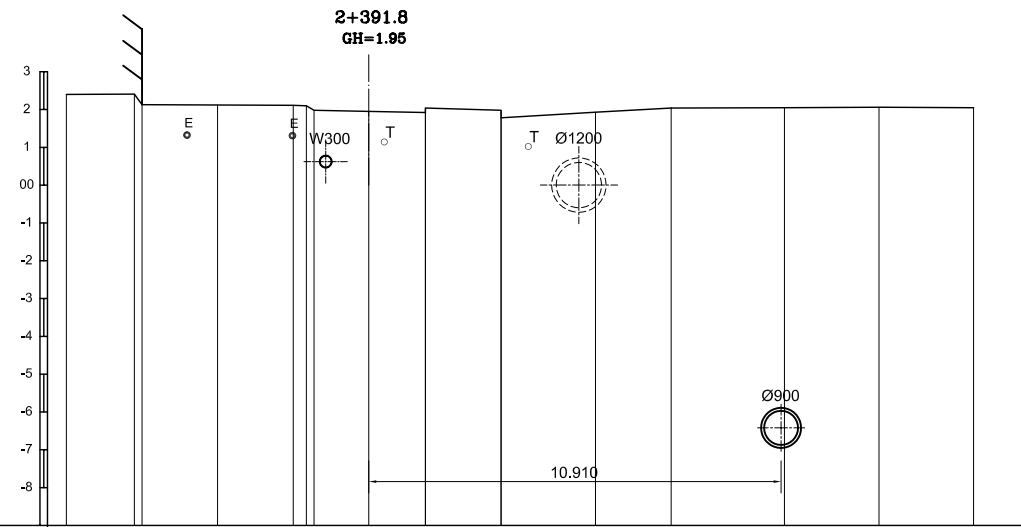

Invert Elevation (m)	-6.87															
Ground Elevation (m)	2.40	2.41	2.13	2.12	2.11	2.10	1.98	1.95	1.92	2.04	1.98	1.93	2.04	2.05	2.06	2.05
Distance (m)	1.80	0.20	2.00	2.00	0.80	1.45	1.50	2.00	2.50	2.00	3.00	2.50	2.50			

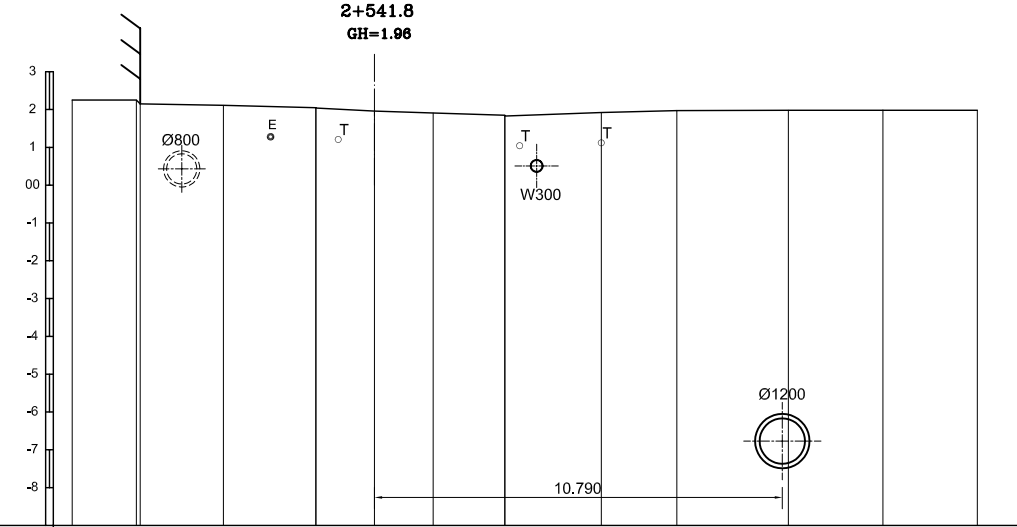

Invert Elevation (m)	-7.37														
Ground Elevation (m)	2.25	2.25	2.15	2.11	2.05	2.04	1.96	1.91	1.85	1.83	1.92	1.97	1.98	1.99	1.98
Distance (m)	1.70	0.10	2.20	2.45	1.55	1.55	1.90	2.55	2.00	2.95	2.50	2.50			

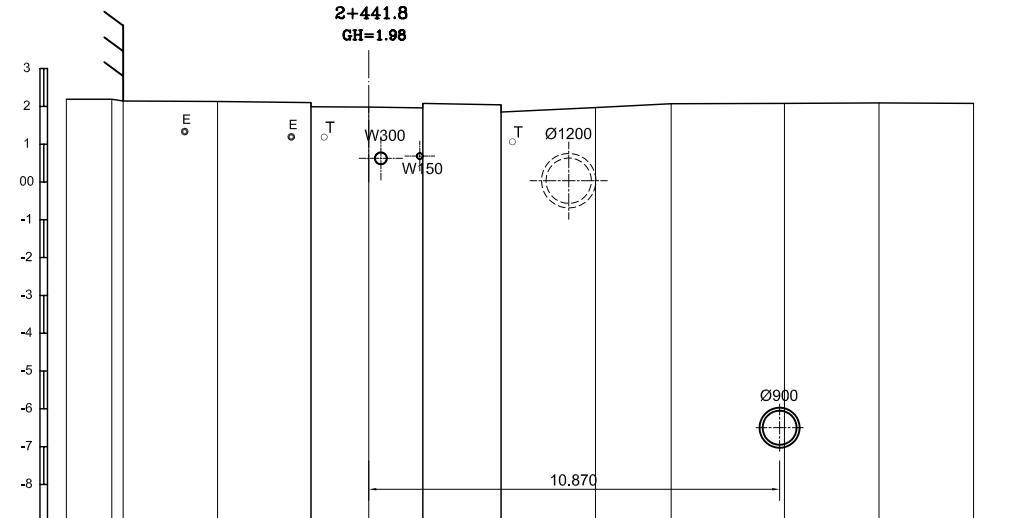

Invert Elevation (m)	-6.95														
Ground Elevation (m)	2.19	2.19	2.14	2.13	2.10	1.99	1.98	1.96	2.08	2.04	1.85	1.97	2.07	2.09	2.08
Distance (m)	1.20	0.30	2.50	2.47	1.53	1.43	2.07	2.50	2.00	3.00	2.50	2.50			

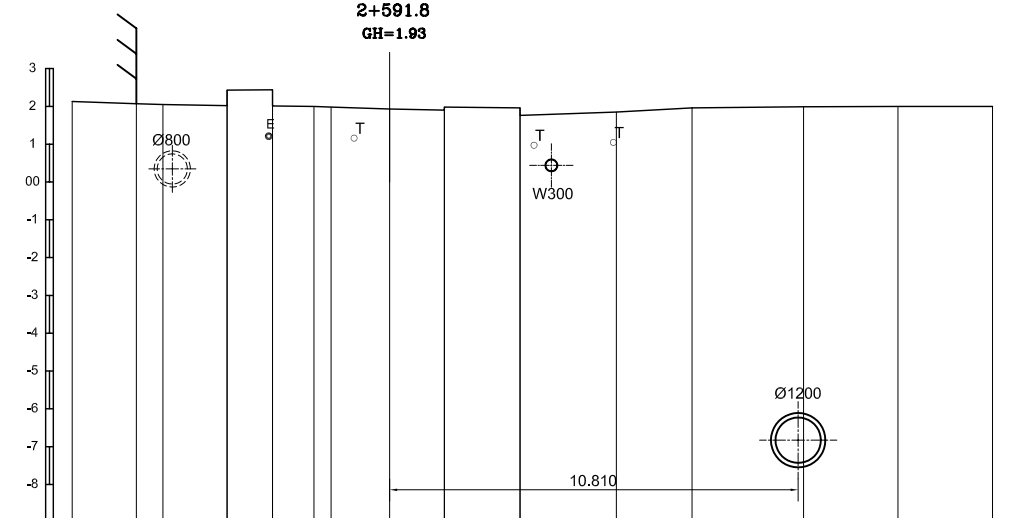

Invert Elevation (m)	-7.43														
Ground Elevation (m)	2.13	2.07	2.05	2.02	2.43	2.44	2.01	2.00	1.88	1.93	1.90	1.96	1.96	1.96	1.96
Distance (m)	1.70	0.70	1.70	1.20	1.10	0.45	1.55	1.45	2.00	2.55	2.00	2.95	2.50	2.50	

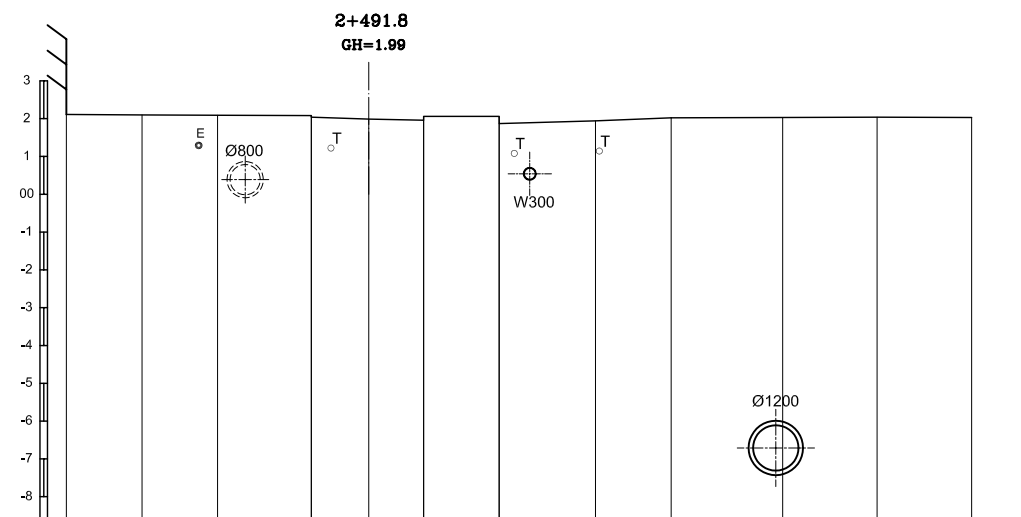

Invert Elevation (m)	-7.51														
Ground Elevation (m)	2.11	2.10	2.09	2.08	2.04	1.99	1.96	2.06	2.06	1.97	1.94	2.02	2.03	2.04	2.03
Distance (m)	2.00	2.00	2.48	1.52	1.45	2.00	2.55	2.00	2.95	2.50	2.50				

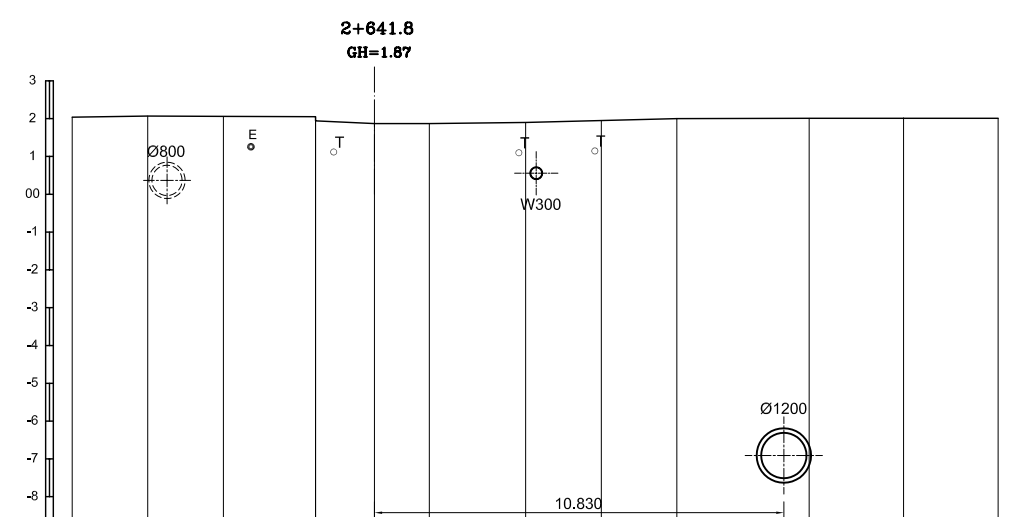

Invert Elevation (m)	-7.51												
Ground Elevation (m)	2.04	2.07	2.06	2.05	1.94	1.87	1.87	1.90	1.95	2.00	2.01	2.02	2.01
Distance (m)	2.00	2.00	2.44	1.56	1.45	2.55	2.00	2.00	3.50	2.50	2.50		

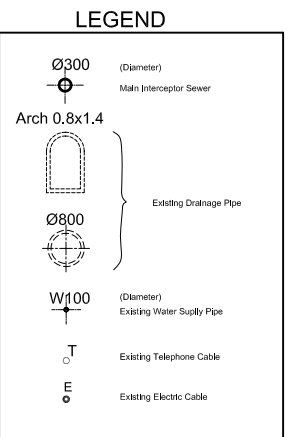

NO.	DATE	DESCRIPTIONS	BY	APRO.

REVISIONS

PROJECT MANAGEMENT UNIT FOR
HO CHI MINH CITY
WATER ENVIRONMENT IMPROVEMENT

THE DETAILED DESIGN ON HO CHI MINH CITY
WATER ENVIRONMENT IMPROVEMENT PROJECT
IN THE SOCIALIST REPUBLIC OF VIET NAM

PACKAGE C
INTERCEPTOR SEWER CONSTRUCTION

**CROSS SECTION
OF MAIN INTERCEPTOR (9)**

SCALE : 1 / 100

JICA JAPAN INTERNATIONAL COOPERATION
AGENCY (JICA)

PACIFIC CONSULTANTS INTERNATIONAL

DESIGNED: SATO NOBUYUKI
CHECKED: KONDO MASAMI

DATE : JUNE 2001 DWG. No. PC - ISC - 257

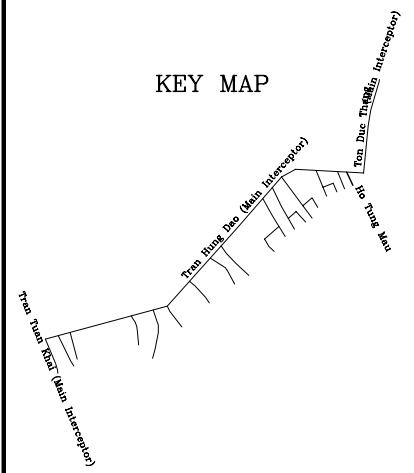
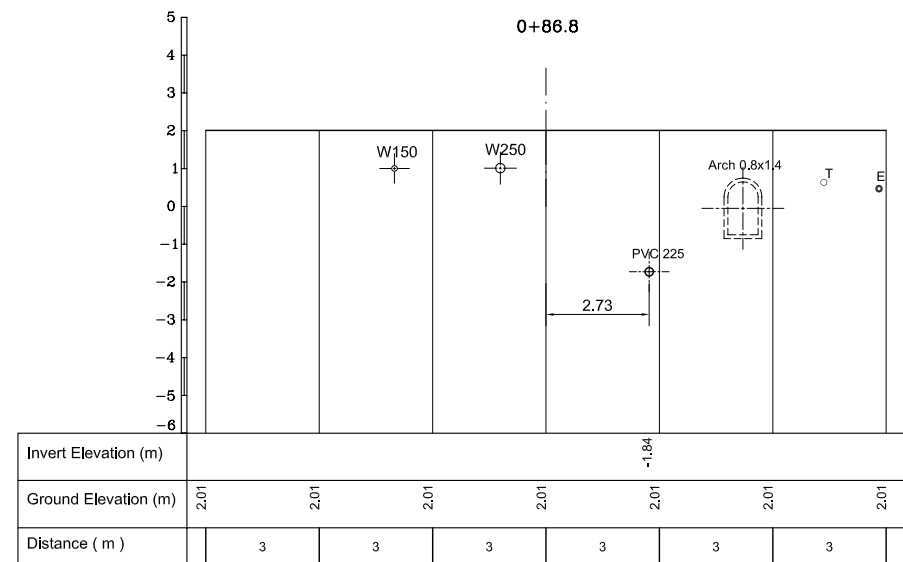
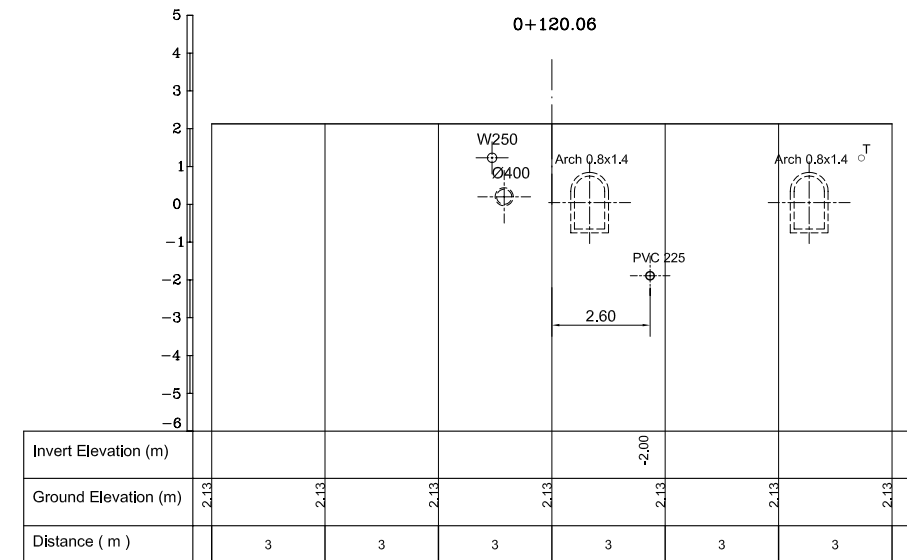
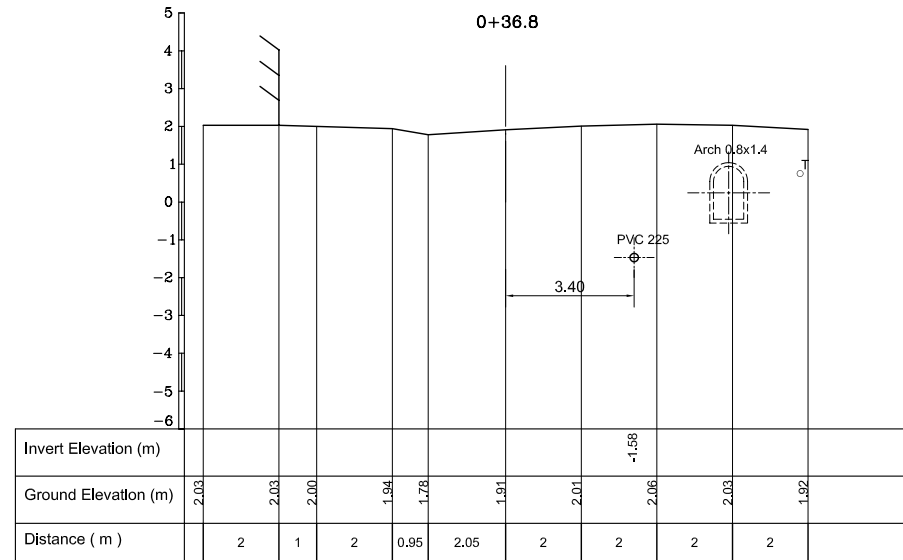

LEGEND

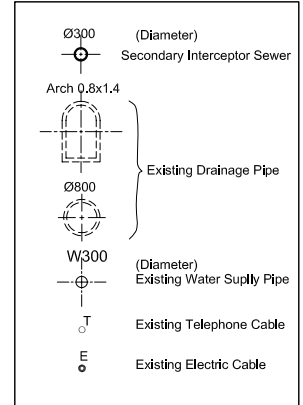

NO.	DATE	DESCRIPTIONS	BY	APRO.
-----	------	--------------	----	-------

REVISIONS

PROJECT MANAGEMENT UNIT FOR
HO CHI MINH CITY
WATER ENVIRONMENT IMPROVEMENT

THE DETAILED DESIGN ON HO CHI MINH CITY
WATER ENVIRONMENT IMPROVEMENT PROJECT
IN THE SOCIALIST REPUBLIC OF VIET NAM

PACKAGE C
INTERCEPTOR SEWER CONSTRUCTION
CROSS SECTION OF
SECONDARY INTERCEPTOR (1)
(HO TUNG MAU)

SCALE : 1 : 100

JICA JAPAN INTERNATIONAL COOPERATION
AGENCY (JICA)

PACIFIC CONSULTANTS INTERNATIONAL

DESIGNED SATO NOBUYUKI	CHECKED KONDO MASAMI
---------------------------	-------------------------

DATE : JUNE 2001 DWG. No. PC - ISC -258

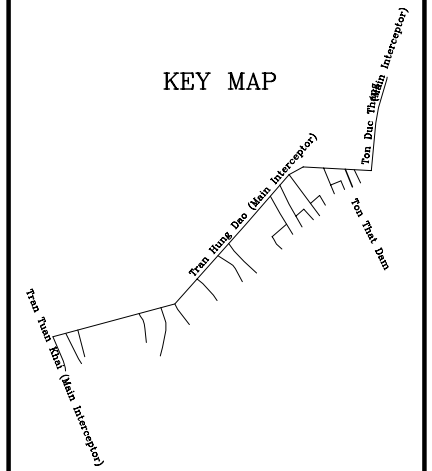
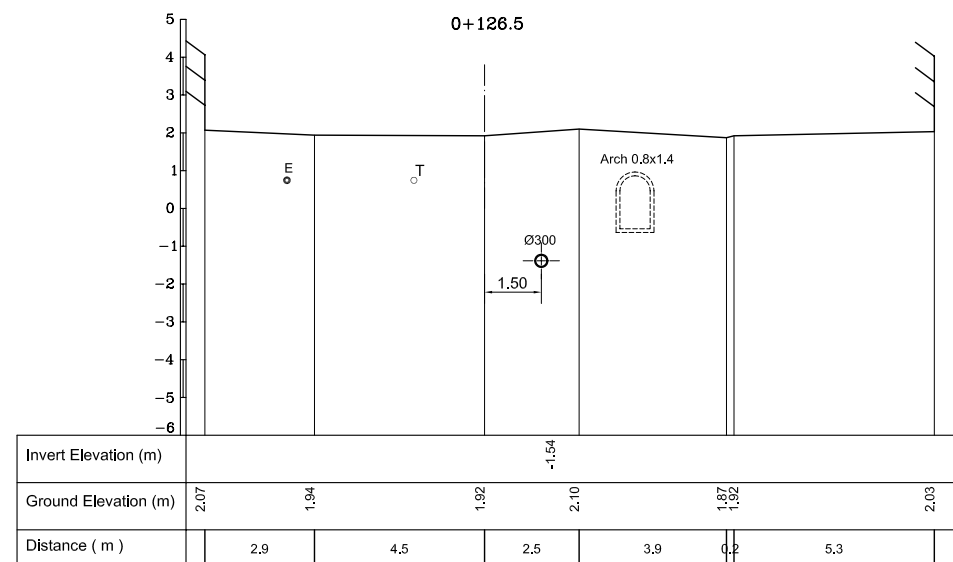
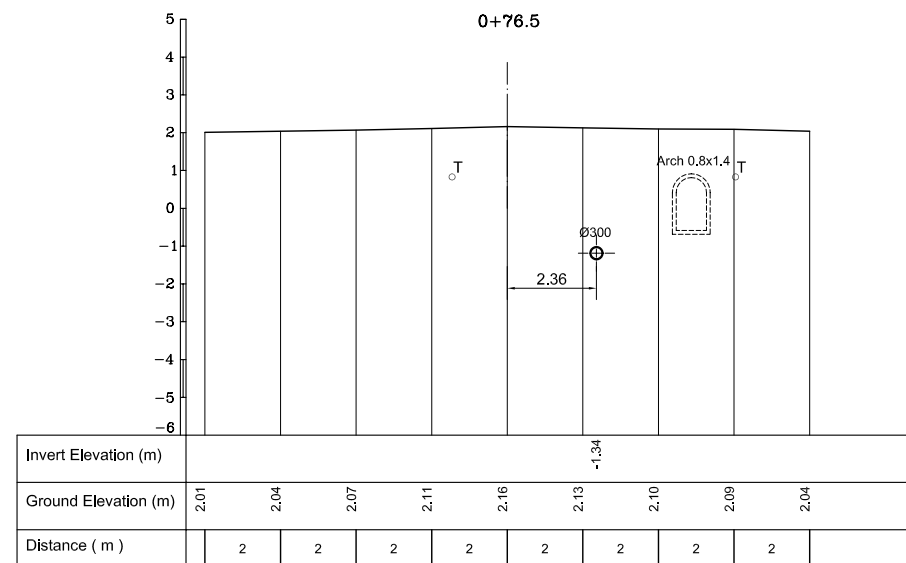
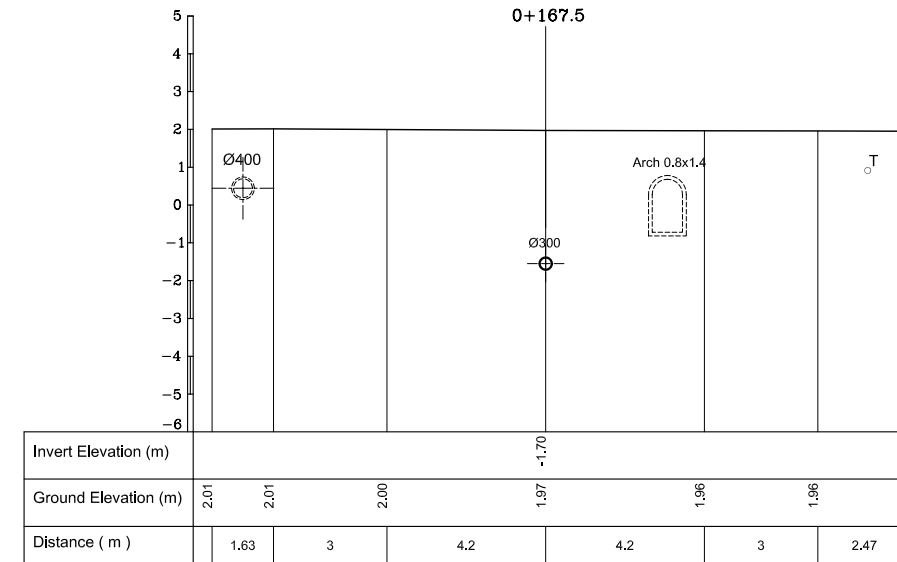
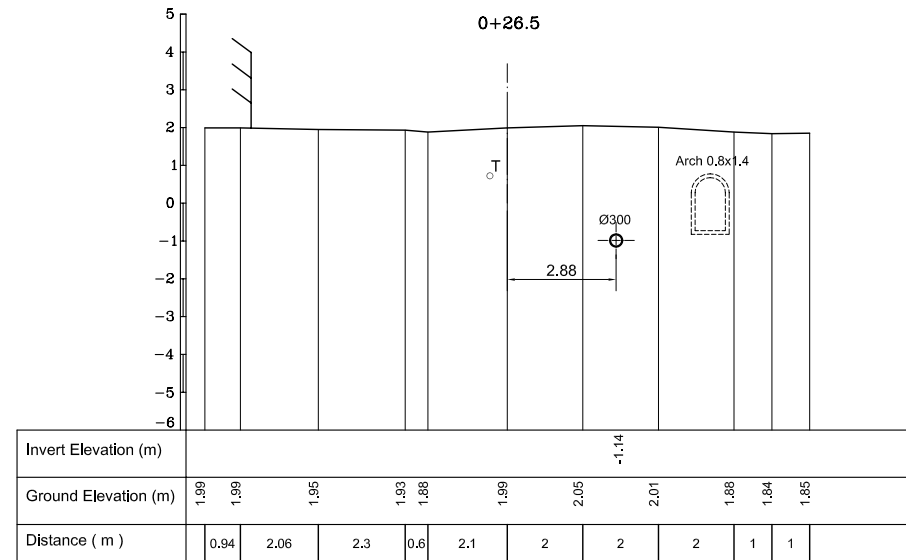

LEGEND

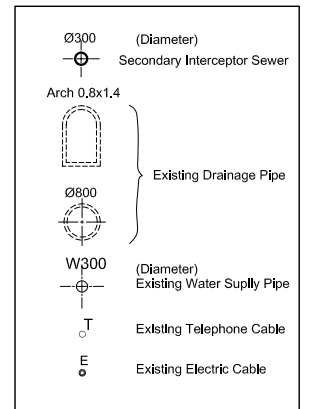

NO.	DATE	DESCRIPTIONS	BY	APRO.
-----	------	--------------	----	-------

REVISIONS

PROJECT MANAGEMENT UNIT FOR
HO CHI MINH CITY
WATER ENVIRONMENT IMPROVEMENT

THE DETAILED DESIGN ON HO CHI MINH CITY
WATER ENVIRONMENT IMPROVEMENT PROJECT
IN THE SOCIALIST REPUBLIC OF VIET NAM

PACKAGE C
INTERCEPTOR SEWER CONSTRUCTION
**CROSS SECTION OF
SECONDARY INTERCEPTOR (2)
(TON THAT DAM)**

SCALE : 1 : 100

JAPAN INTERNATIONAL COOPERATION AGENCY (JICA)

PACIFIC CONSULTANTS INTERNATIONAL

DESIGNED SATO NOBUYUKI	CHECKED KONDO MASAMI
---------------------------	-------------------------

DATE : JUNE 2001 DWG. No. PC - ISC - 259