

NO.	DATE	DESCRIPTIONS	BY	APRO.

REVISIONS

PROJECT MANAGEMENT UNIT FOR  
HO CHI MINH CITY  
WATER ENVIRONMENT IMPROVEMENT

THE DETAILED DESIGN ON HO CHI MINH CITY  
WATER ENVIRONMENT IMPROVEMENT PROJECT  
IN THE SOCIALIST REPUBLIC OF VIET NAM

CROSS SECTION SURVEY OF  
SECONDARY INTERCEPTOR SEWER ROTE (20)  
(NGUYEN VAN CU)

SCALE : 1 : 100

JICA JAPAN INTERNATIONAL COOPERATION  
AGENCY ( JICA )

PC PACIFIC CONSULTANTS INTERNATIONAL

DESIGNED CHECKED

DATE : DWG. No. PC

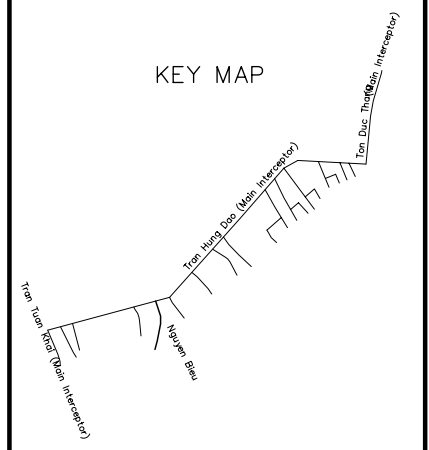
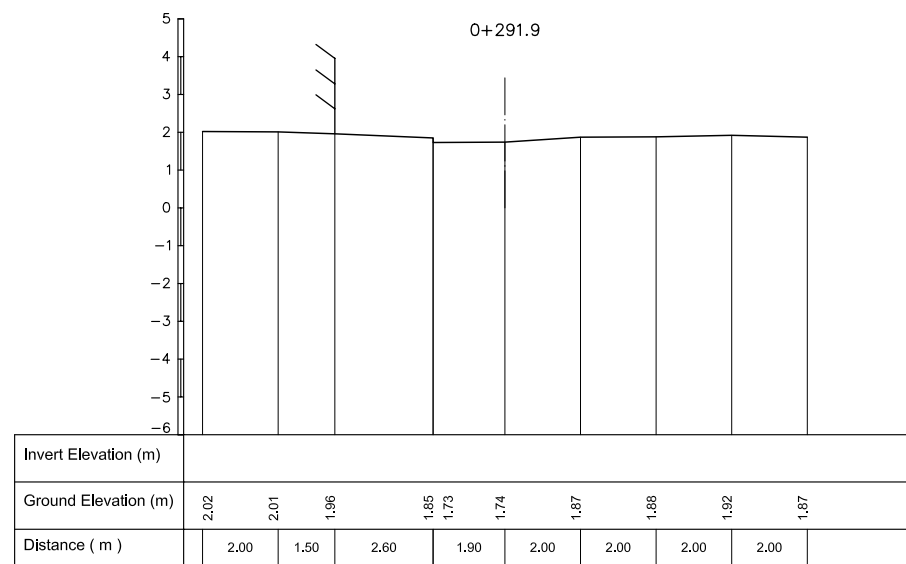
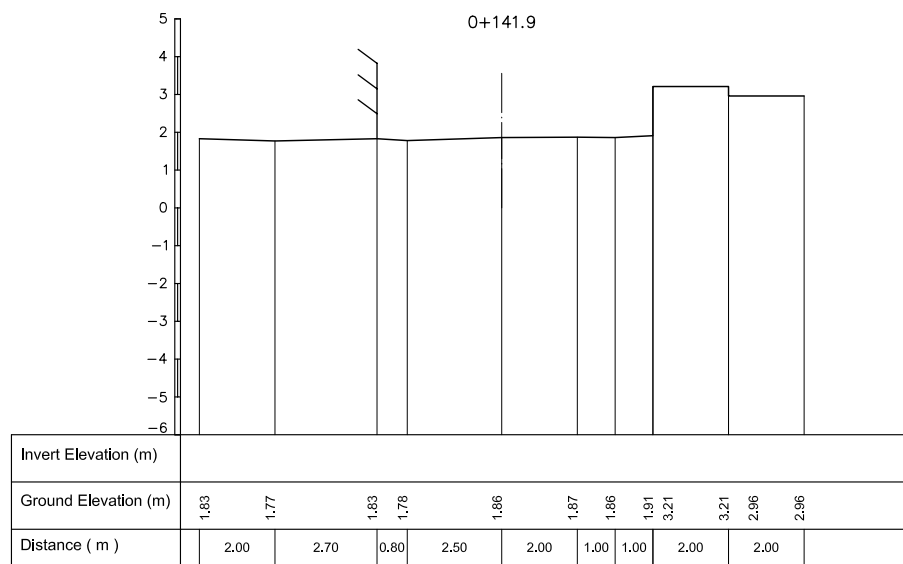
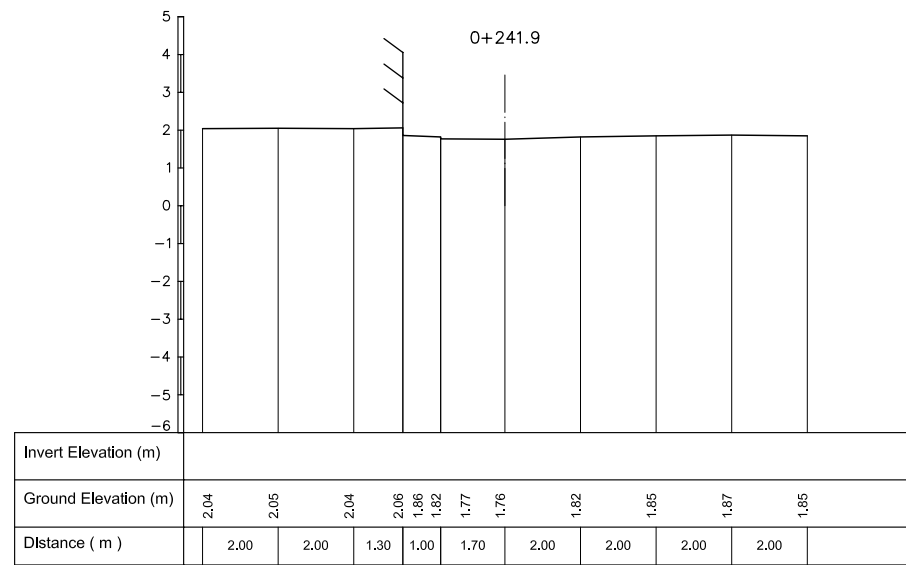
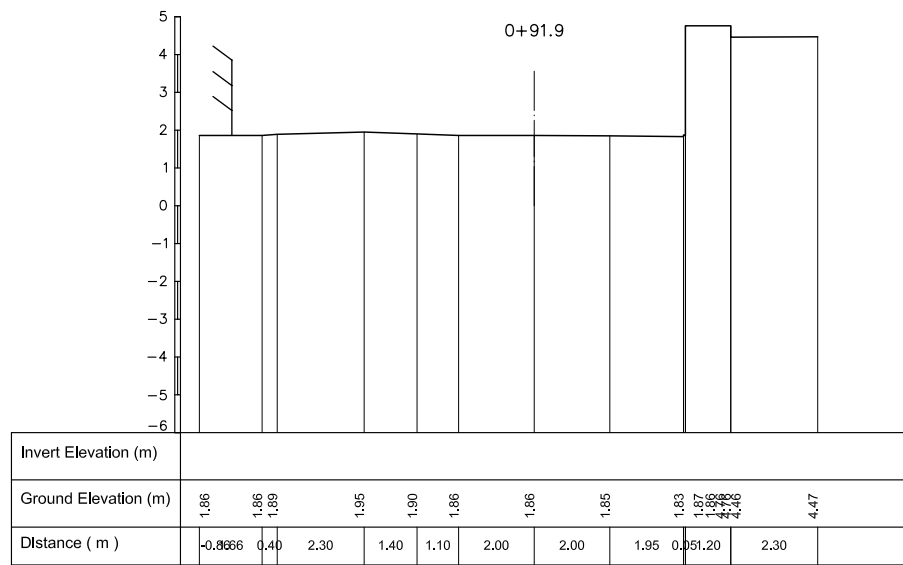
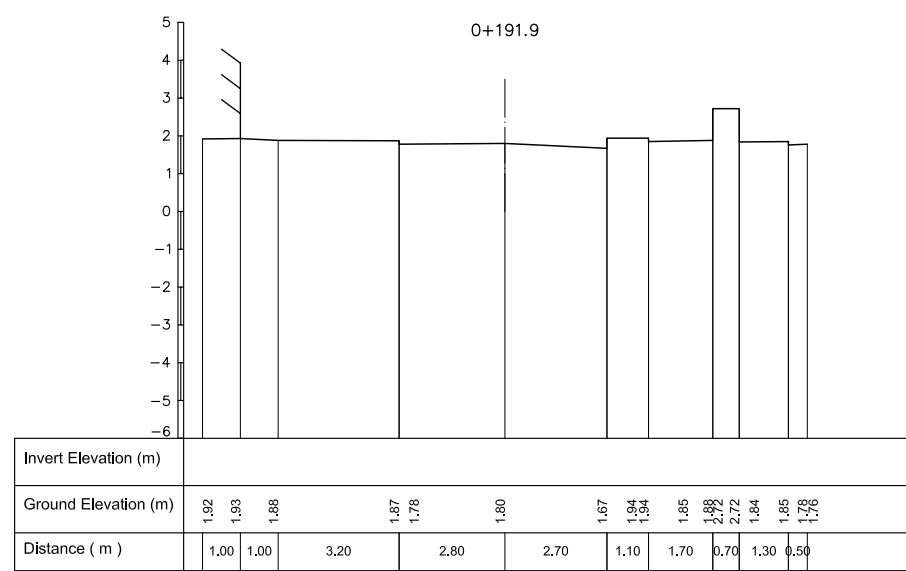
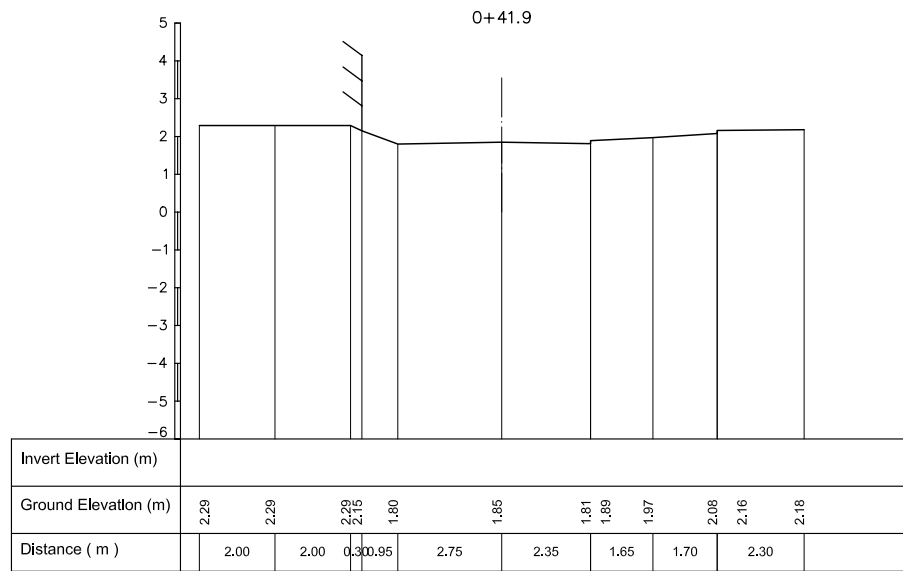

NO.	DATE	DESCRIPTIONS	BY	APRO.
-----	------	--------------	----	-------

REVISIONS

PROJECT MANAGEMENT UNIT FOR  
HO CHI MINH CITY  
WATER ENVIRONMENT IMPROVEMENT

THE DETAILED DESIGN ON HO CHI MINH CITY  
WATER ENVIRONMENT IMPROVEMENT PROJECT  
IN THE SOCIALIST REPUBLIC OF VIET NAM

CROSS SECTION SURVEY OF  
SECONDARY INTERCEPTOR SEWER ROUTE(21)  
(NGUYEN BIEU)

SCALE : 1 : 100

JAPAN INTERNATIONAL COOPERATION  
AGENCY ( JICA )

PACIFIC CONSULTANTS INTERNATIONAL

DESIGNED	CHECKED
----------	---------

DATE :	DWG. No. PC - ISD -278
--------	------------------------

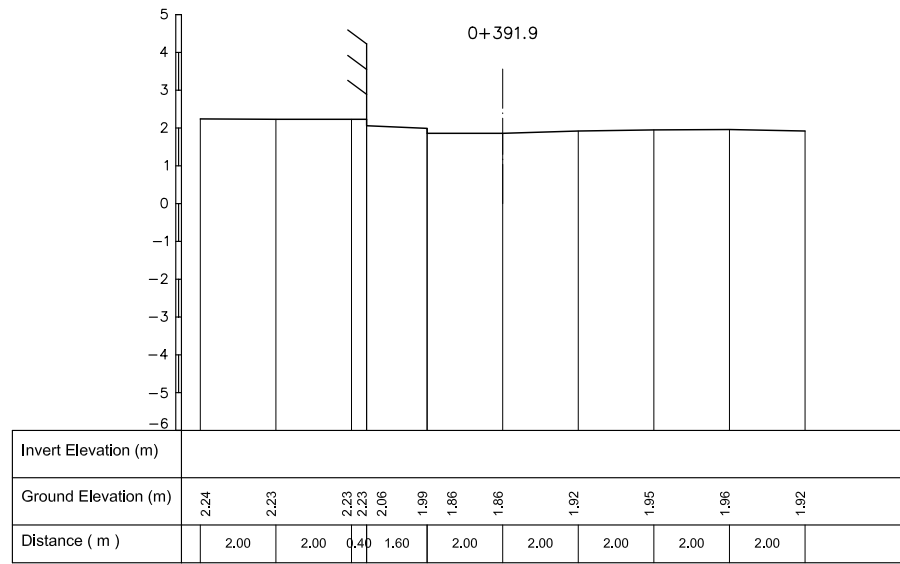
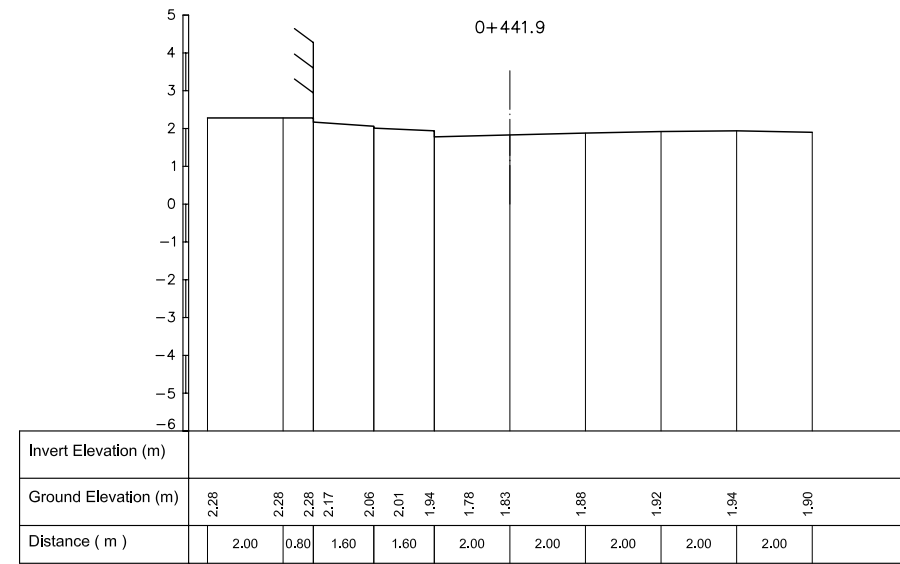
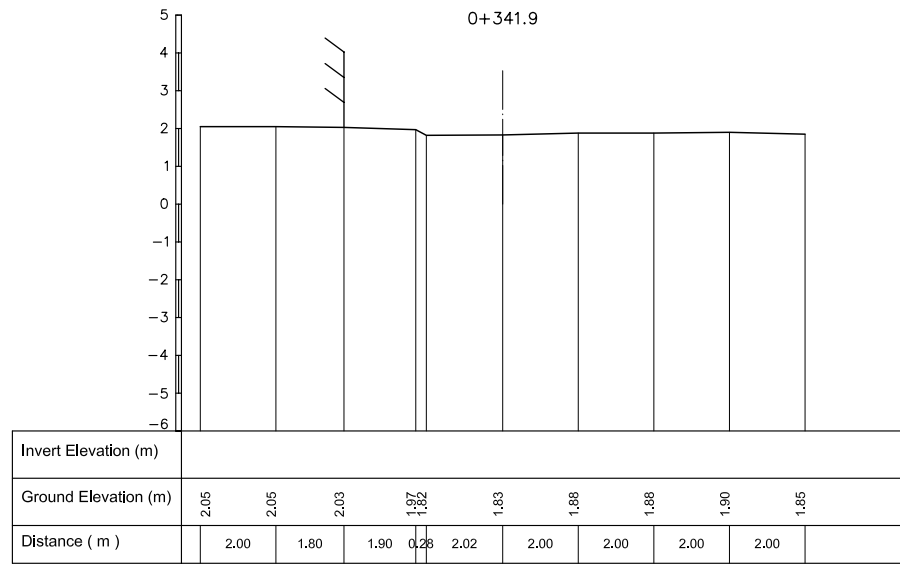

KEY MAP

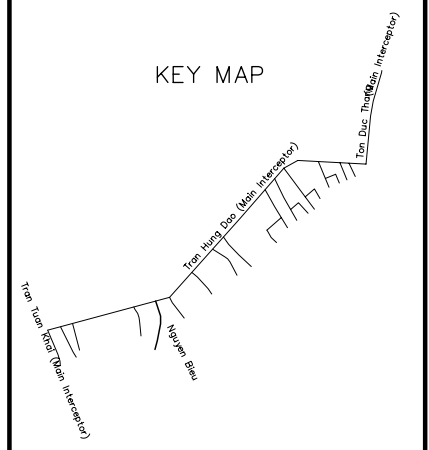

NO.	DATE	DESCRIPTIONS	BY	APRO.
-----	------	--------------	----	-------

REVISIONS

PROJECT MANAGEMENT UNIT FOR  
HO CHI MINH CITY  
WATER ENVIRONMENT IMPROVEMENT

THE DETAILED DESIGN ON HO CHI MINH CITY  
WATER ENVIRONMENT IMPROVEMENT PROJECT  
IN THE SOCIALIST REPUBLIC OF VIET NAM

CROSS SECTION SURVEY OF  
SECONDARY INTERCEPTOR SEWER ROUTE(22)  
(NGUYEN BIEU)

SCALE : 1 : 100

JICA JAPAN INTERNATIONAL COOPERATION  
AGENCY ( JICA )

PC PACIFIC CONSULTANTS INTERNATIONAL

DESIGNED CHECKED

DATE : DWG. No. PC

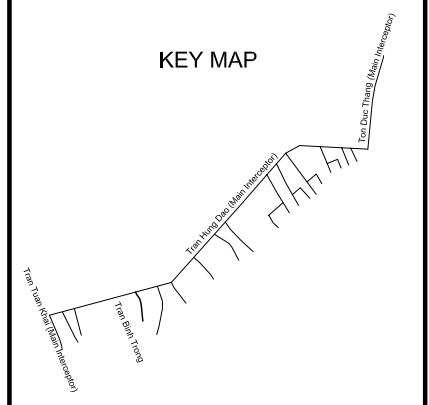
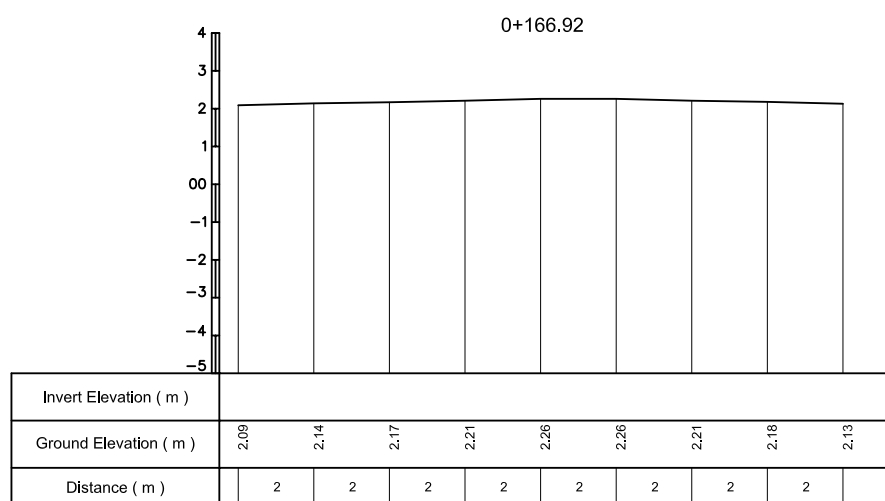
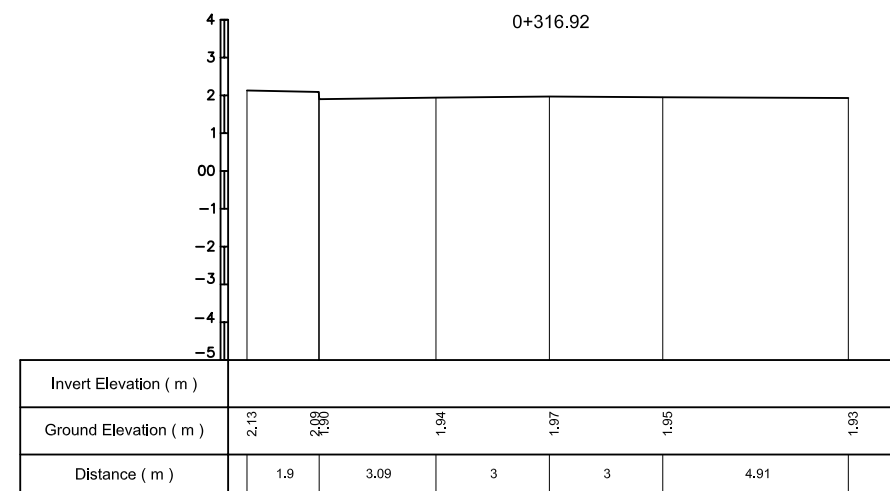
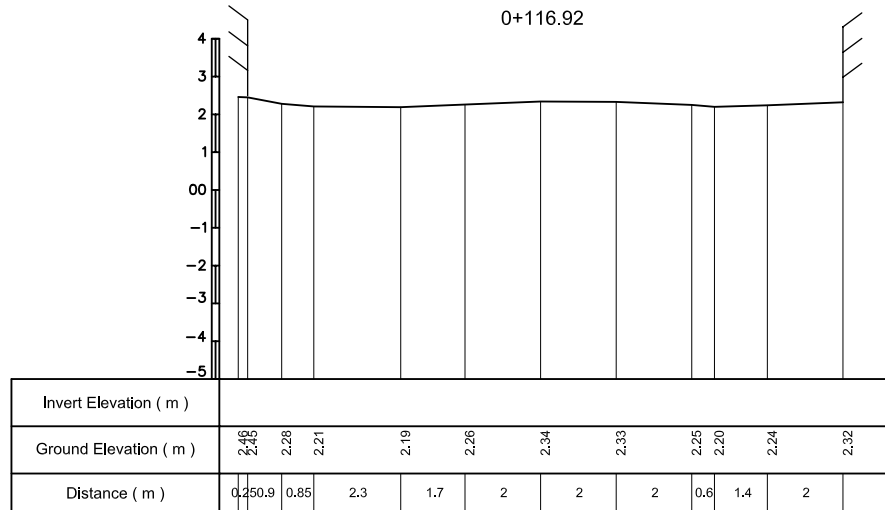
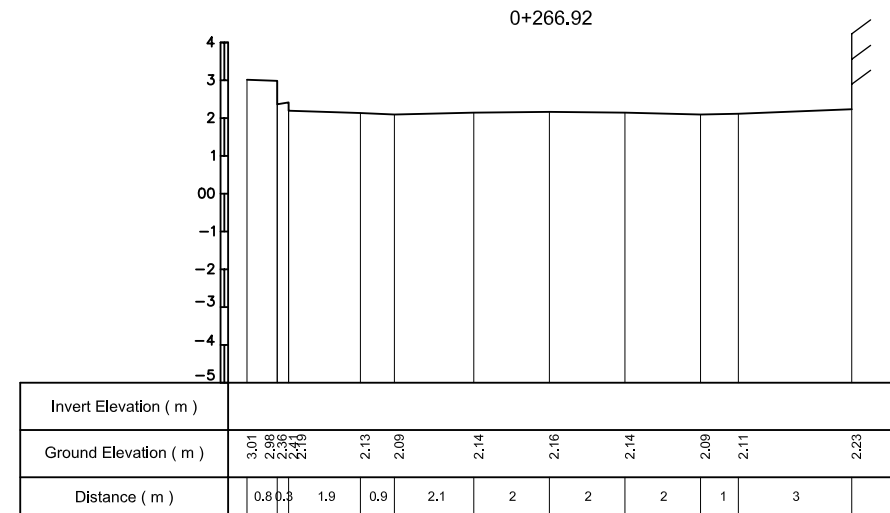
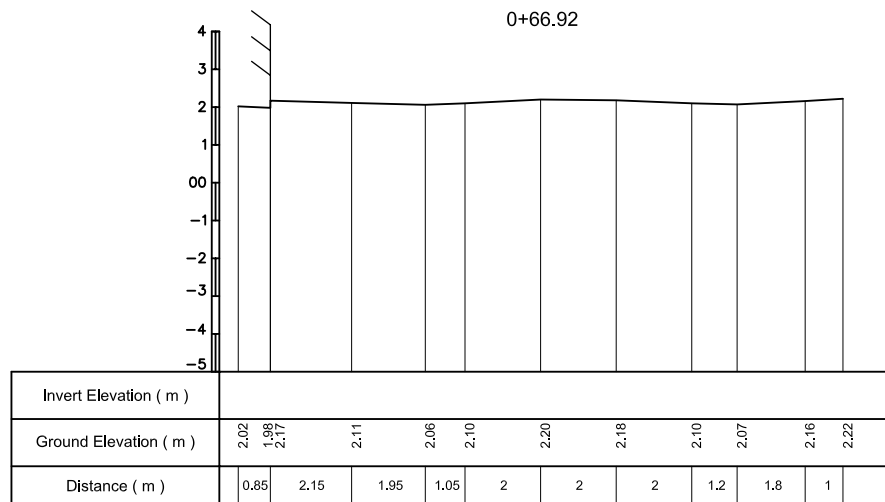
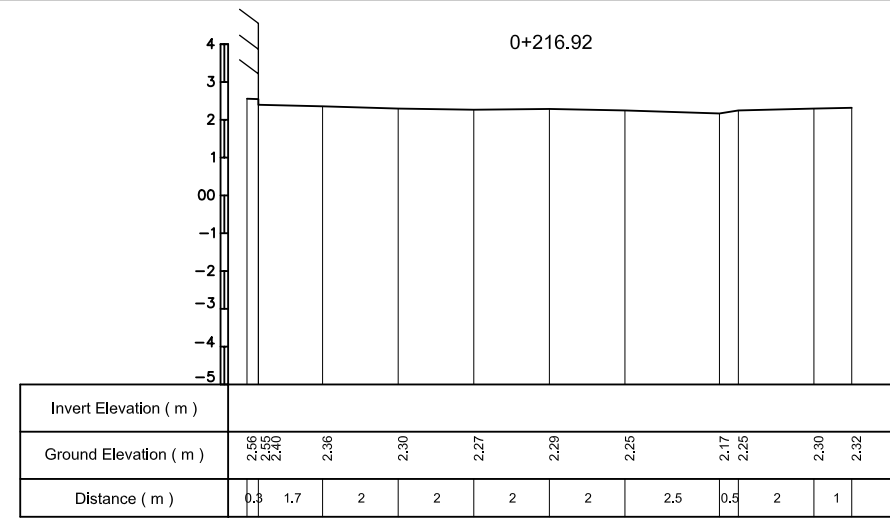
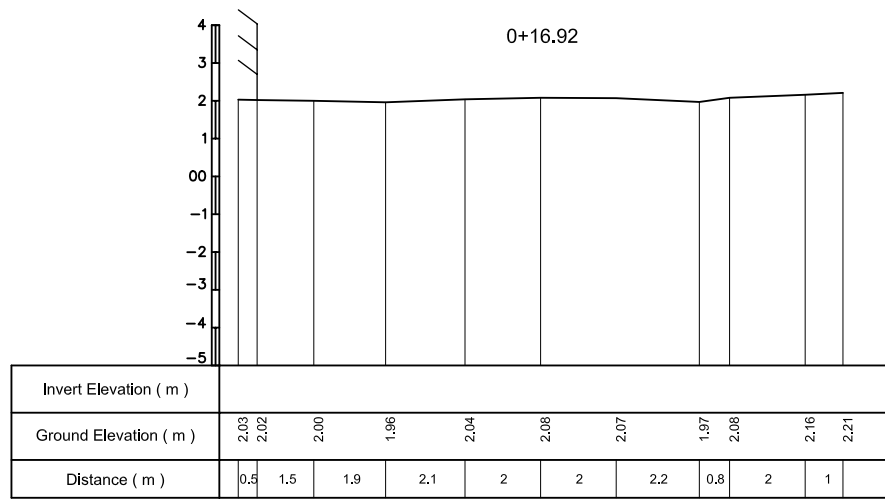

NO.	DATE	DESCRIPTIONS	BY	APRO.
-----	------	--------------	----	-------

REVISIONS

PROJECT MANAGEMENT UNIT FOR  
HO CHI MINH CITY  
WATER ENVIRONMENT IMPROVEMENT

THE DETAILED DESIGN ON HO CHI MINH CITY  
WATER ENVIRONMENT IMPROVEMENT PROJECT  
IN THE SOCIALIST REPUBLIC OF VIET NAM

CROSS SECTION SURVEY OF  
SECONDARY INTERCEPTOR SEWER ROUTE(23)  
(TRAN BINH TRONG)

SCALE : 1 : 100

JICA JAPAN INTERNATIONAL COOPERATION AGENCY ( JICA )

PC PACIFIC CONSULTANTS INTERNATIONAL

DESIGNED	CHECKED
----------	---------

DATE :	DWG. No. PC
--------	-------------

KEY MAP

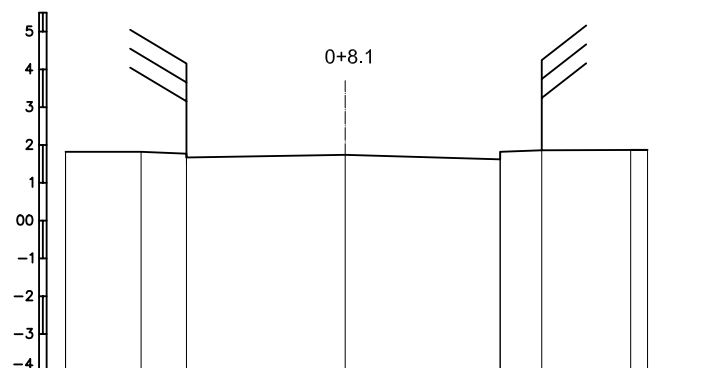
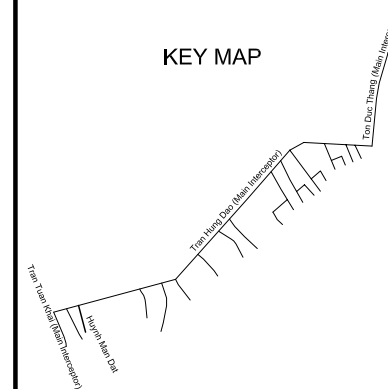

Invert Elevation ( m )								
Ground Elevation ( m )	1.82	1.82	1.77	1.74	1.62	1.86	1.87	1.87
Distance ( m )	2	1.2	4.2	4.1	1.1	2.8	0.45	

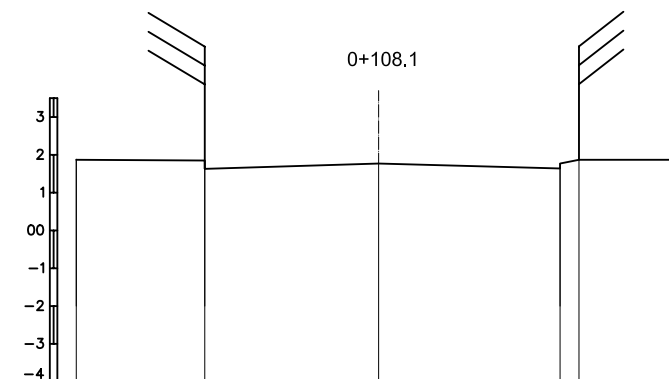

Invert Elevation ( m )						
Ground Elevation ( m )	1.87	1.85	1.63	1.77	1.64	1.87
Distance ( m )	3.4	4.6	4.8	0.5	2.7	

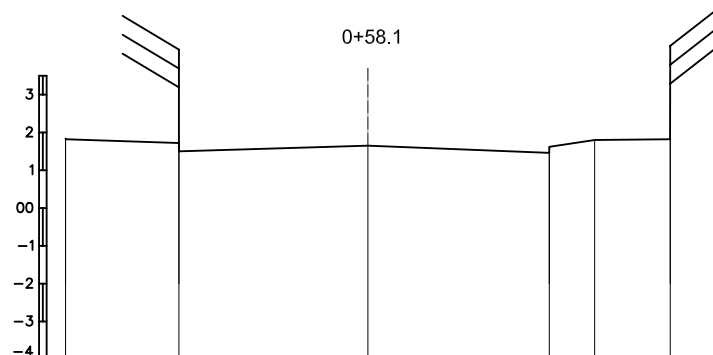

Invert Elevation ( m )						
Ground Elevation ( m )	1.82	1.72	1.50	1.65	1.45	1.80
Distance ( m )	3	5	4.8	1.2	2	

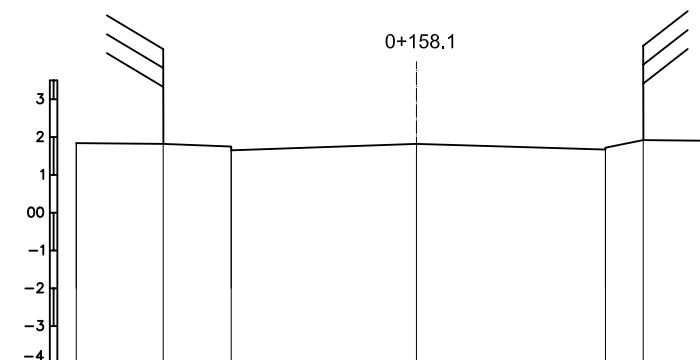

Invert Elevation ( m )						
Ground Elevation ( m )	1.90	1.82	1.75	1.65	1.82	1.87
Distance ( m )	2.3	1.8	4.9	5	1	2

NO.	DATE	DESCRIPTIONS	BY	APPRO.
-----	------	--------------	----	--------

REVISIONS

PROJECT MANAGEMENT UNIT FOR  
HO CHI MINH CITY  
WATER ENVIRONMENT IMPROVEMENT

THE DETAILED DESIGN ON HO CHI MINH CITY  
WATER ENVIRONMENT IMPROVEMENT PROJECT  
IN THE SOCIALIST REPUBLIC OF VIET NAM

CROSS SECTION SURVEY OF  
SECONDARY INTERCEPTOR SEWER ROUTE (24)  
(HUYNH MAN DAT)

SCALE : 1 : 100

JICA JAPAN INTERNATIONAL COOPERATION  
AGENCY ( JICA )

PC PACIFIC CONSULTANTS INTERNATIONAL

DESIGNED CHECKED

DATE : DWG. No. PC

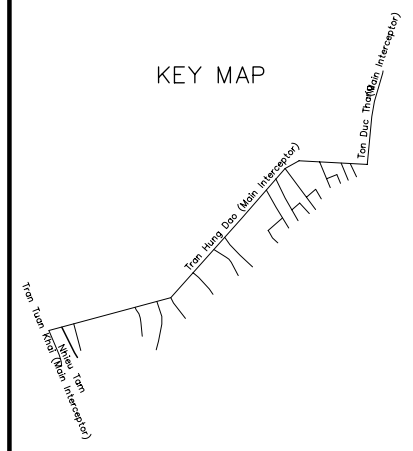
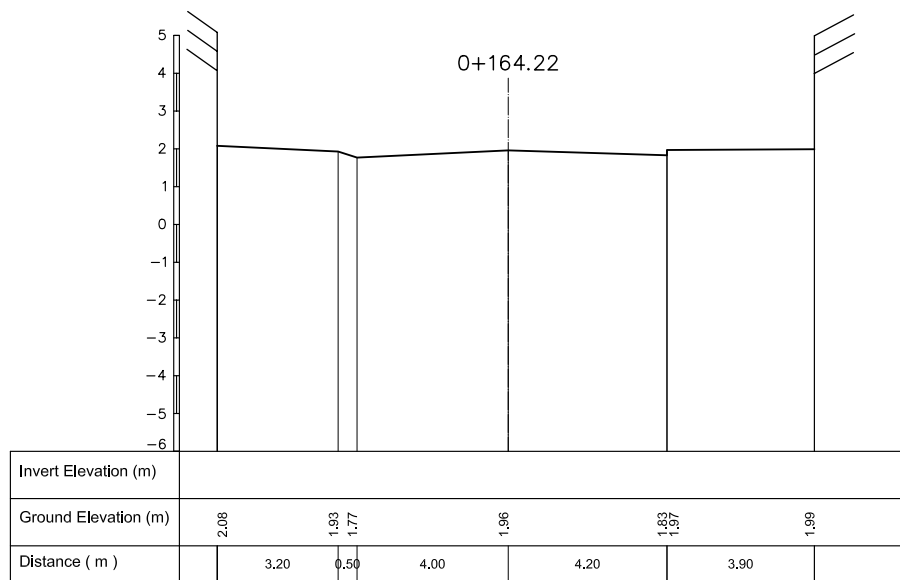
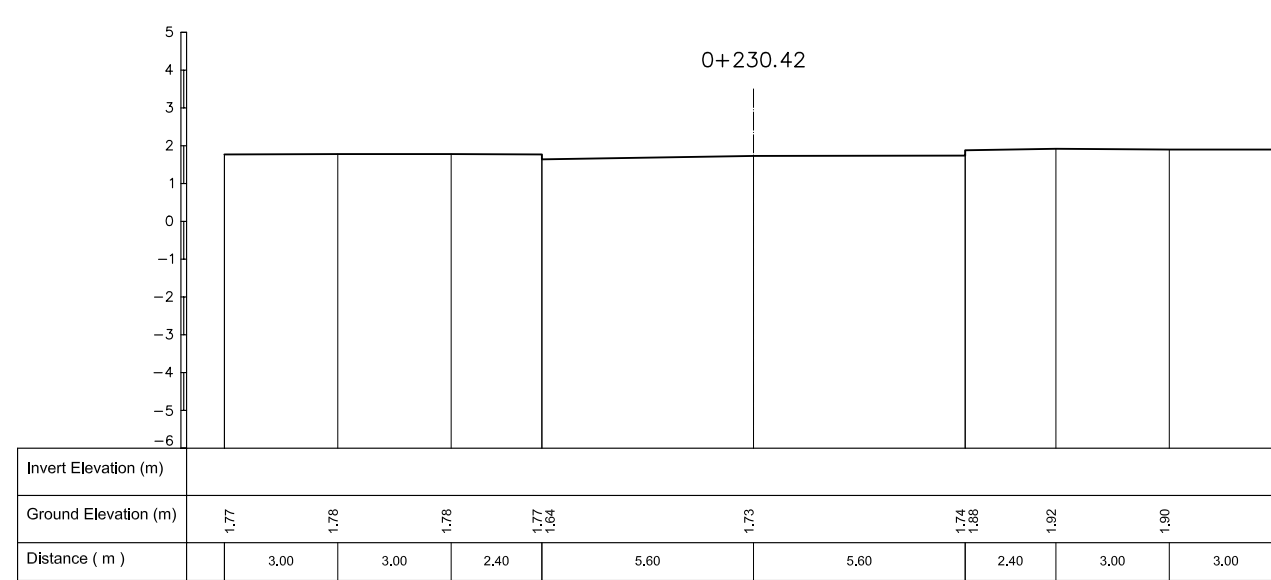
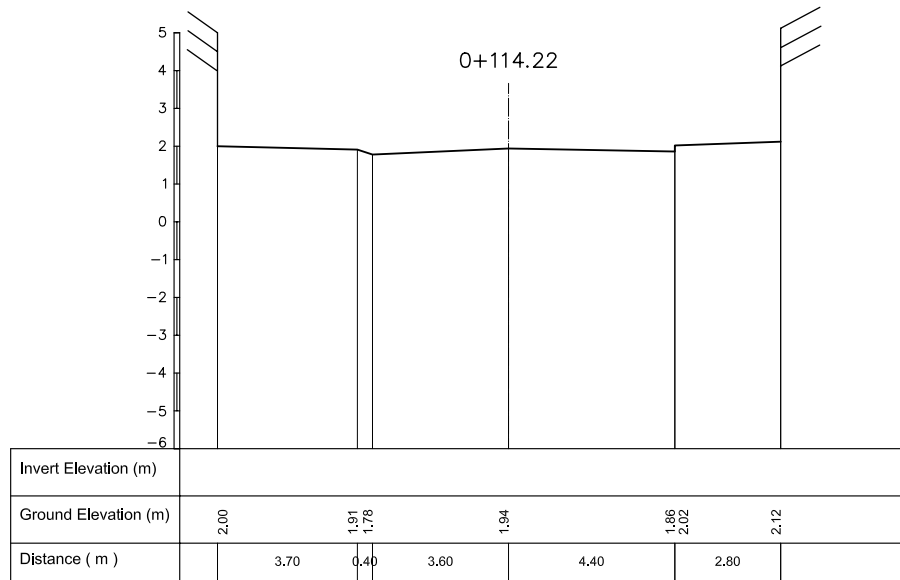
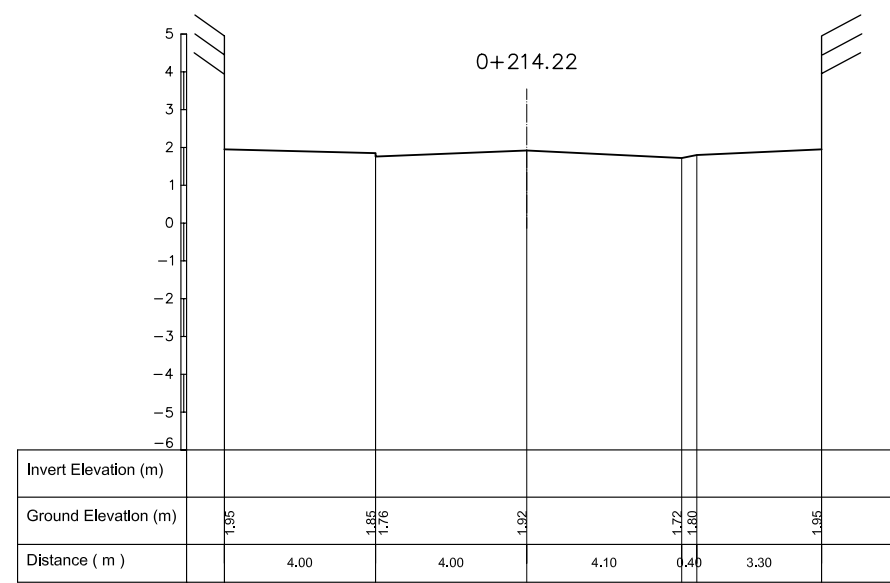
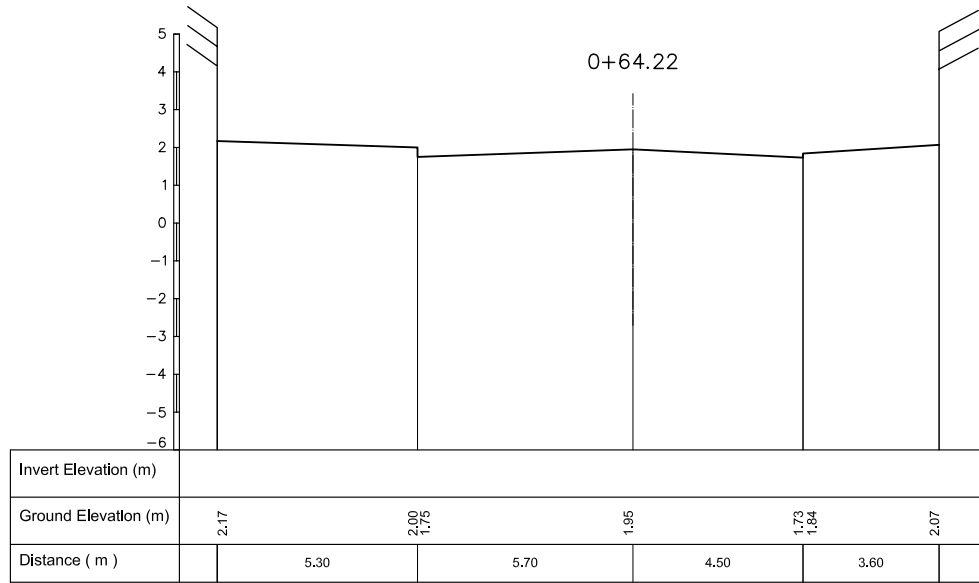

NO.	DATE	DESCRIPTIONS	BY	APPRO.
-----	------	--------------	----	--------

REVISIONS

PROJECT MANAGEMENT UNIT FOR  
HO CHI MINH CITY  
WATER ENVIRONMENT IMPROVEMENT

THE DETAILED DESIGN ON HO CHI MINH CITY  
WATER ENVIRONMENT IMPROVEMENT PROJECT  
IN THE SOCIALIST REPUBLIC OF VIET NAM

CROSS SECTION SECONDARY OF  
SECONDARY INTERCEPTOR SEWER ROUTE(25)  
(NHIEU TAM)

SCALE : 1 : 100

JICA JAPAN INTERNATIONAL COOPERATION  
AGENCY ( JICA )

PC PACIFIC CONSULTANTS INTERNATIONAL

DESIGNED CHECKED

DATE : DWG. No. PC