

1. Galvanising plant (0.5-4 inch pipes)
2. Pipe workshop
3. 0.5-4 inch pipe mill
4. Main spare parts store
5. Administration
6. Electric substation
7. Small fittings foundry (includes chemical store)
8. Galvanising plant (small fittings)
9. Covered store for waste oils
10. Product store (0.5-4 inch pipe)
11. Store for foundry raw materials
12. Product store (pipes) and scrap yard
13. Water cooling system (0.5-4 inch pipes)
14. Garage (includes car workshop)
15. Workshop
16. Transport department
17. Clinic
18. Product store (pipe fitting)
19. Large fitting foundry
20. Large fittings finishing area/workshop
21. Cooling for foundries
22. Casting foundries
23. Administration
24. Central material store
25. Main electrical substation
26. Coke store, scrap and limestone
27. Raw material store (coils)
28. Raw material store (coils)
29. Product stores (2-8 inch and spiral pipes)
30. Spiral pipe mill (6-18 and 6-60 inch)
31. 2-8 inch pipemill
32. Painting shop
33. Old spiral pipe mill (6-24 inch)
34. Raw material store (coils)
35. Fuel dispensing station
36. Oxygen plant
37. Central gas cylinder store
38. Zinc dross distillation
39. Open yard for waste dry solids (core sand, slag, etc)

EL NASR CO. FOR STEEL PIPES & FITTINGS
 LOCATION OF WASTEWATER TREATMENT PLANT
 DWG. NO. SP-80-12-00

Equipment No.	Service	Equipment	Service
T-01	Neutralization Tank	PU-08A/B	Sludge Oxidation Pump
T-02	No.1 Sedimentation Tank	PU-08A/B	No.2 Lime Pump
T-03	Neutralized S.S. Tank	PU-10A/B	Completed Pump
T-04	Slurried Oil Tank	PU-11A/B	Completed Air Pump
T-05	Equalization Tank	PU-13A/B	Sludge Feed Pump
T-06	No.2 Sedimentation Tank	PU-14A/B	Settling Air Pump
T-07	Compostory/Phosphatation	PU-14A/B	Centrifuge Feed Pump
T-08	No.3 Sedimentation Tank	PU-15A/B	Filter Air Pump
T-09	Sludge Thickener	PU-15A/B	S.S. Sludge Pump
D-01	Lime Hogger	PU-17	S.S. Sludge Pump
D-02	No.1 Lime Drum	PU-18	Equalization Sludge Pump
D-03	Lime Receiver	B-01A/B	AP Blower
D-04A/B	Multihead(2) Drum	C-01	AC Compressor
D-04A/B	Multihead(2) Drum	MZ-01	Lime Feeder
D-05A/B	No.1 Completed Drum	MZ-02	No.1 Sludge Mixer
D-06A/B	Completed Air Drum	MZ-03	No.2 Sludge Mixer
D-07	Filtered Air Drum	MZ-04	No.3 Sludge Mixer
D-08	Filtered Air Drum	MZ-05	No.4 Sludge Mixer
Z-01	Oil Separator	MZ-06	No.1 Centrifuge
Z-02	Oil Separator T.I.F. PM	MZ-07	No.2 Centrifuge
Z-03	Skimmer Oil PM	MZ-08	Oil Compressor
Z-04	Skimmer Wash	MZ-09	No.1 Lime Mixer
Z-05	Sludge PM	MZ-10	Multihead(2) Mixer
Z-06	Treated Water PM	MZ-11A/B	Multihead(2) Mixer
Z-07	Wastewater PM	MZ-12A/B	Multihead(2) Mixer
PU-01A/B	No.1 Lime Pump	MZ-13A/B	No.1 Completed Mixer
PU-02A/B	No.1 Sludge Pump	MZ-14A/B	No.2 Completed Mixer
PU-03A/B	Multihead S.S. Pump	MZ-15A/B	Completed Air Mixer
PU-04A/B	Oil Separator T.I.F. Pump	MZ-16	Phosphatation Mixer
PU-05	Completed Air Pump	MZ-17	Settling Air Mixer
PU-06A/B	Multihead(2) Pump	MZ-18	Filter Air Mixer
PU-07A/B	Multihead(2) Pump	MZ-19	Filter Air Mixer

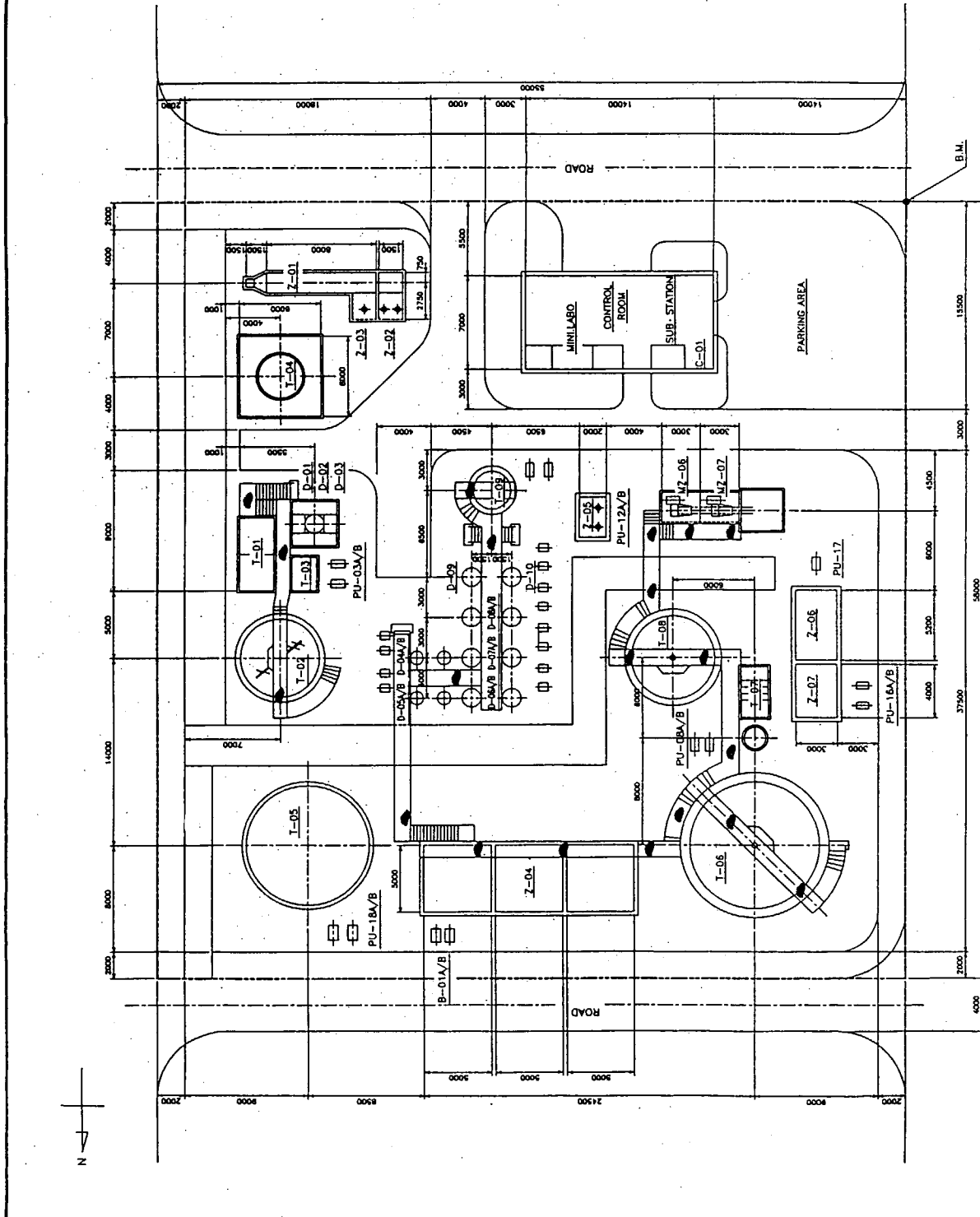

Job No.	Check	Drawn	Appr.	Scale	Rev.	Description	Drawn	Check	Appr.	Date

CLIENT: JAPAN INTERNATIONAL COOPERATION AGENCY
INDUSTRIAL DEVELOPMENT STUDY DIVISION

CONSULTANT: CHYODA DAUES & MOORE CO.
CHYODA CORPORATION

PROJECT: THE STUDY ON INDUSTRIAL WASTE WATER POLLUTION CONTROL OF THE ASAB INDUSTRIES OF EGYPT

TITLE: FOR EL MASR COPPER STEEL PIPES AND FITTINGS PLANT

ISSUED DATE: 1/7/82



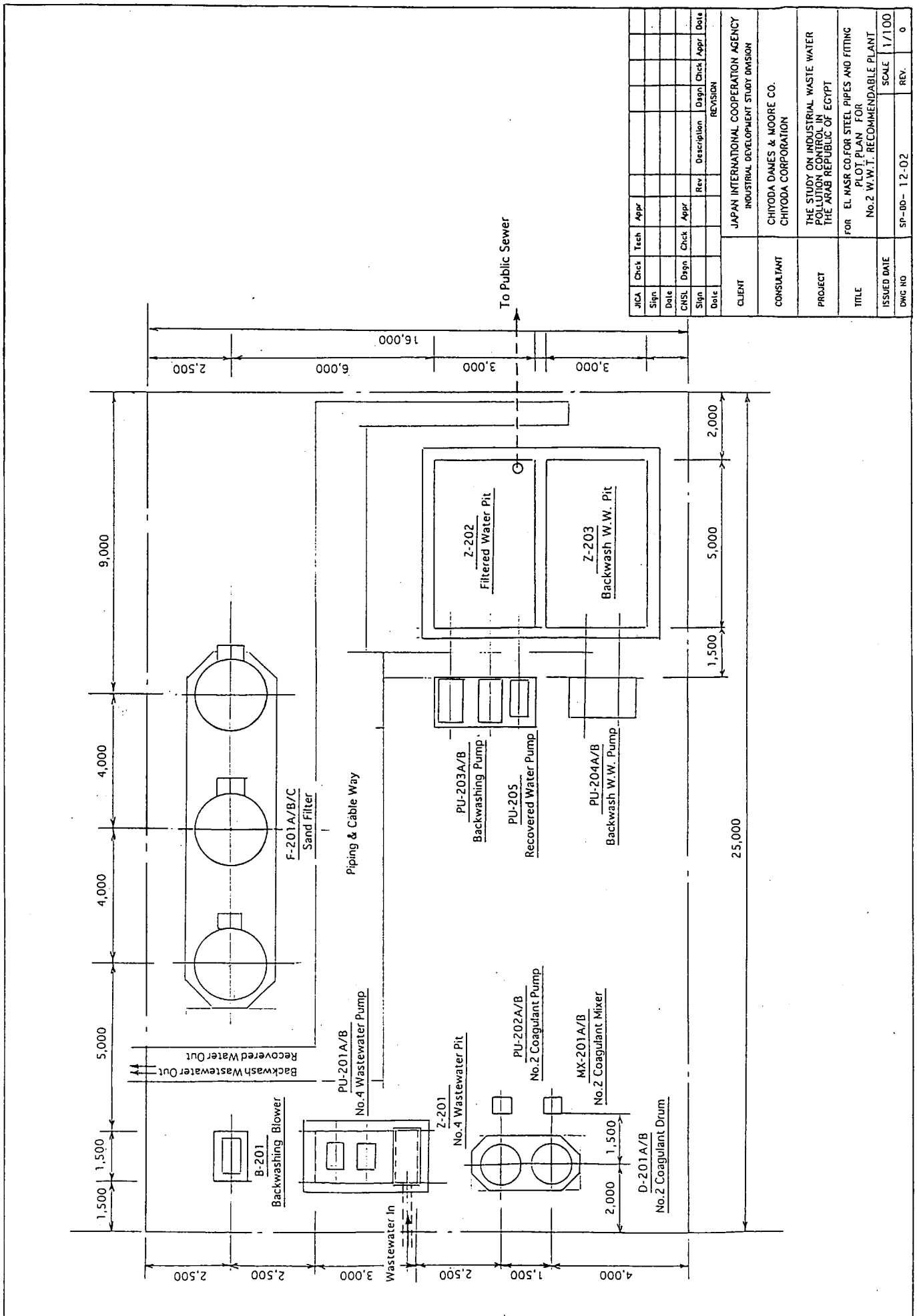







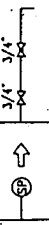







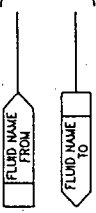
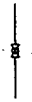

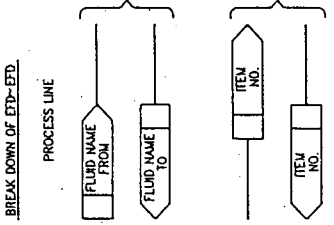



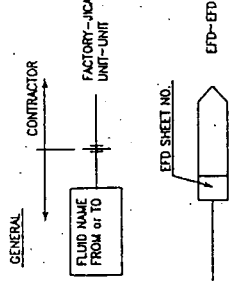
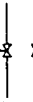

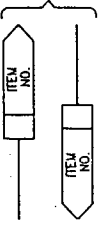



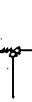

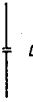

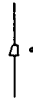

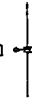







DWG NO: SP-18-13-01 REV: 0

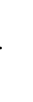
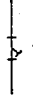
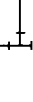

Check	Tech	Appr	Rev	Description	Drawn	Check	Appr	Date

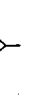
REVISION	Scale	Rev.

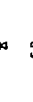
CLIENT	JAPAN INTERNATIONAL COOPERATION AGENCY INDUSTRIAL DEVELOPMENT STUDY DIVISION
CONSULTANT	CHIYODA DAMES & MOORE CO.
PROJECT	THE STUDY ON INDUSTRIAL WASTE WATER PLANT FOR THE ARAB REPUBLIC OF EGYPT
TITLE	FOR EL MASR CO. FOR STEEL PIPES AND FITTING PLOT PLAN FOR No. 2 W.W.T. RECOMMENDABLE PLANT
ISSUED DATE	
DWG NO	SP-BD- 12-02
SCALE	1/100
REV.	0

TANK	SAMPLING CONNECTION	SYMBOLS OF LINE	SYMBOLS OF EQUIPMENT	SYMBOLS OF FLUID
CONE ROOF TANK 	SAMPLING CONNECTION FOR WATER FROM PIPE LINE 	GATE VALVE 	EYE SHOWER 	<u>SERVICE</u> CAUSTIC INSTRUMENT AIR SERVICE AIR COOLING WATER SUPPLY COOLING WATER RETURN DRINKING WATER INDUSTRIAL WATER RECOVERED WATER WASTE WATER HCL CHEMICAL
OPEN TANK 	<u>SYMBOLS OF LINE</u> MAIN PROCESS LINE PROCESS LINE (& UTILITY LINE etc.) UTILITY LINE SUPPLEMENTARY LINE IMAGINARY LINE, BURIED LINE CENTER LINE BOUNDARY LINE DESIGNATES PIPING CLASS CHANGES OR APPLICABLE LOW. INCLUDED 	CHECK VALVE 	SHOWER 	<u>ABBREVIATION</u> (S) SAFETY VALVE B/L BATTERY LIMIT ATM ATMOSPHERE MFR MANUFACTURER MISC MISCELLANEOUS T.S TEMPORARY STRAINER NC NORMAL CLOSE NO NORMAL OPEN FC FAILURE CLOSE FO FAILURE OPEN BW BUTT WELD
<u>DRUMS</u> HORIZONTAL TYPE 	FLUID NAME FROM 	BALL VALVE 	SILENCER 	
VERTICAL TYPE 	BREAK DOWN OF ETD-EFD PROCESS LINE 	NEEDLE VALVE 	MAN HOLE 	
VERTICAL TYPE (OPEN) 	LINE IDENTIFICATION GENERAL FLUID NAME FROM or TO CONTRACTOR FACTORY-JICA UNIT-UNIT ETD SHEET NO. 	COCK VALVE 	HAND HOLE 	
<u>PUMP BLOWER, ETC</u> CENTRIFUGAL PUMP 	IN EACH SYSTEM ETD 	JWAY VALVE 	SIGHT GLASS 	
RECIPROCATING PUMP 		SAFETY VALVE 	LINE MIXER 	
ROOT BLOWER 		FLANGE CONNECTION 	TO ONLY SEWER 	
EJECTOR 		CONCENTRIC REDUCER 	TO RAINY SEWER 	
MIXER 		ECCENTRIC REDUCER 		
BELT CONVEYOR 		BLIND 		
BELT CONVEYOR 		SPECTACLE BLIND 		
ELECTRIC HOIST 		FLEXIBLE TUBE 		
TANK CAR 		BELLOWS EXPANSION JOINT 		
DUMP TRUCK 		SLEEVE EXPANSION JOINT 		
MOTOR DRIVEN 		HOSE CONNECTION 		
		RESTRICTION ORIFICE 		
		<u>SYMBOLS OF EQUIPMENT</u> Y-TYPE STRAINER 		
		T-TYPE STRAINER 		
		TEMPORARY STRAINER 		
		SEWER DRAIN 		
		FLOW DETECTOR 		
		SIGHT GLASS 		
		FOOT VALVE 		
		SPOOL PIECE 		

JICA Sign	Check	Tech	Apr	Rev	Description	Dsgn	Check	Apr	Date
REVISION									
CLIENT									
JAPAN INTERNATIONAL COOPERATION AGENCY INDUSTRIAL DEVELOPMENT STUDY DIVISION									
CONSULTANT									
CHIYODA DAMIES & MOORE CO. CHIYODA CORPORATION									
PROJECT									
THE STUDY ON INDUSTRIAL WASTE WATER POLLUTION CONTROL IN THE ARAB REPUBLIC OF EGYPT									
TITLE									
FOR ENGINEERING FLOW DIAGRAM LEAD SHEET(1/2)									
ISSUED DATE								SCALE	
DWG NO								REV.	
								None	
								0	

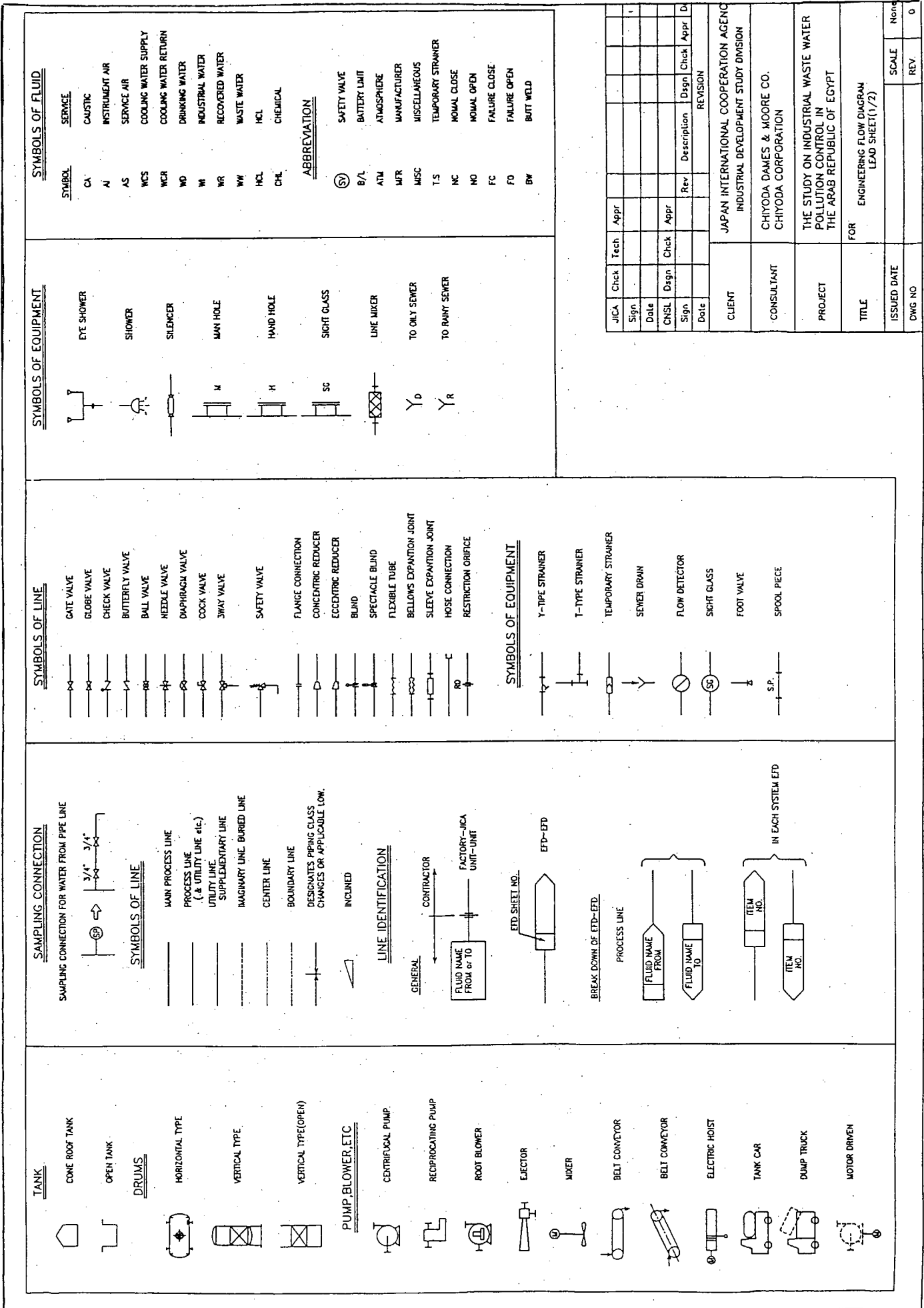

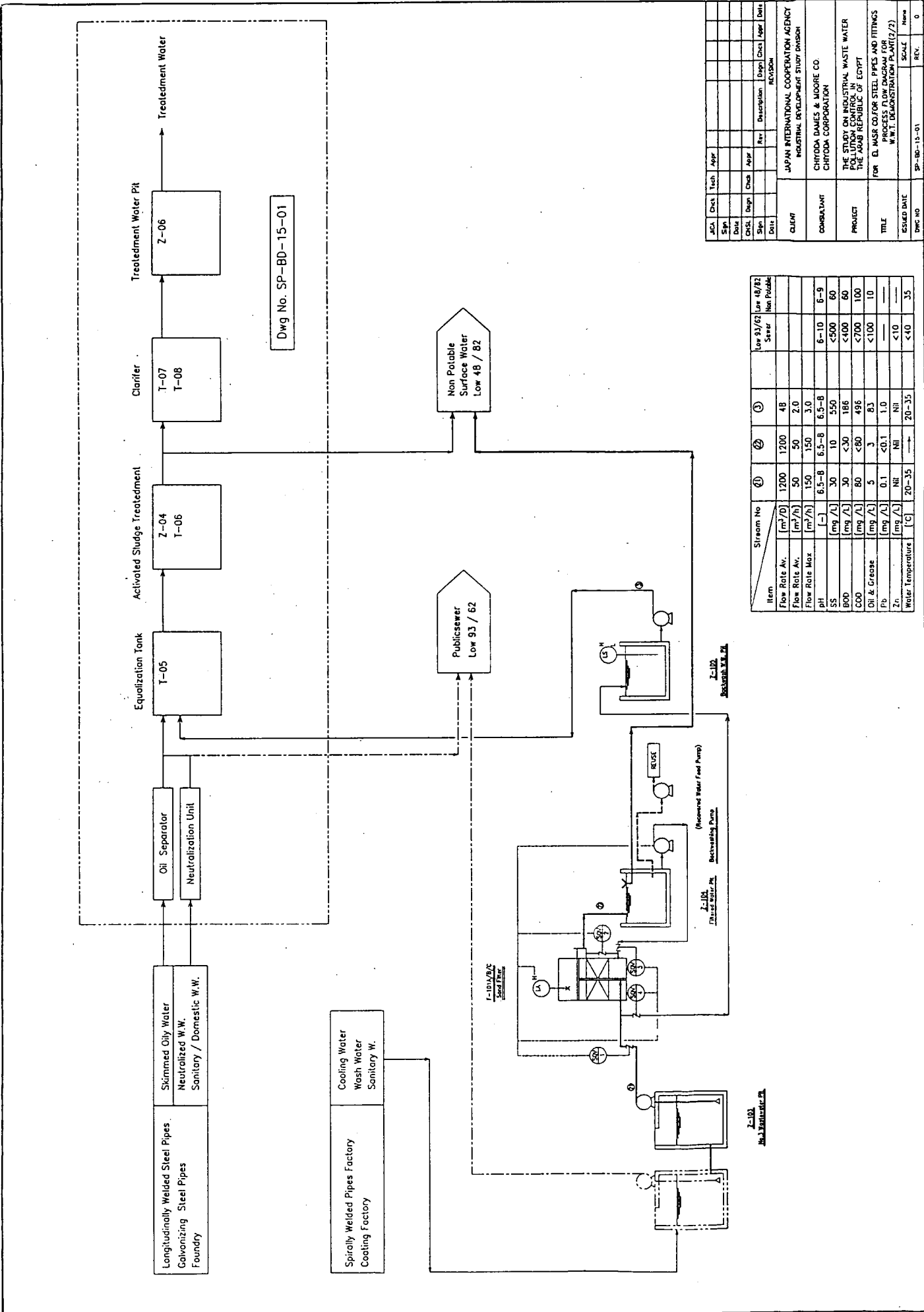

Dwg No. SP-BD-15-01

Item	Stream No	④	⑤	⑥	Low 93/82		Low 48/82
					Flow Rate	Non Potable	
Flow Rate Av.	[m ³ /D]	1200	48	2.0			
Flow Rate Av.	[m ³ /h]	50	2.0	3.0			
Flow Rate Max.	[m ³ /h]	150	150	3.0			
pH		6.5-8	6.5-8	6.5-8			
SS	[mg/L]	30	10	550		5-9	
SS	[mg/L]	<500	<500	<500		60	
BOO	[mg/L]	80	<30	186		<100	60
COO	[mg/L]	<80	<80	496		<700	100
Oil & Grease	[mg/L]	5	3	83		<100	10
Po	[mg/L]	0.1	<0.1	1.0			
Zn	[mg/L]	NH	NH	NH			
Water Temperature	[C]	20-35	20-35			<10	

No	Date	Rev	Description	REVISION			
				Drawn	Checked	Appr	Date

CLIENT: JAPAN INTERNATIONAL COOPERATION AGENCY
 INDUSTRIAL DEVELOPMENT STUDY DIVISION
 CONSULTANT: CHYODA DAMES & MOORE CO.
 CHYODA CORPORATION
 PROJECT: THE STUDY ON INDUSTRIAL WASTE WATER TREATMENT AND REUSE OF WASTEWATER AT THE JABAR REPUBLIC OF EGYPT
 TITLE: FOR EL MASR COFOR STEEL PIPES AND FITTINGS PROCESS PLANT TREATMENT PLANT (2/2)

DESIGNED DATE: SP-BD-15-01
 DRAWING NO: SCOLL
 REV: 0

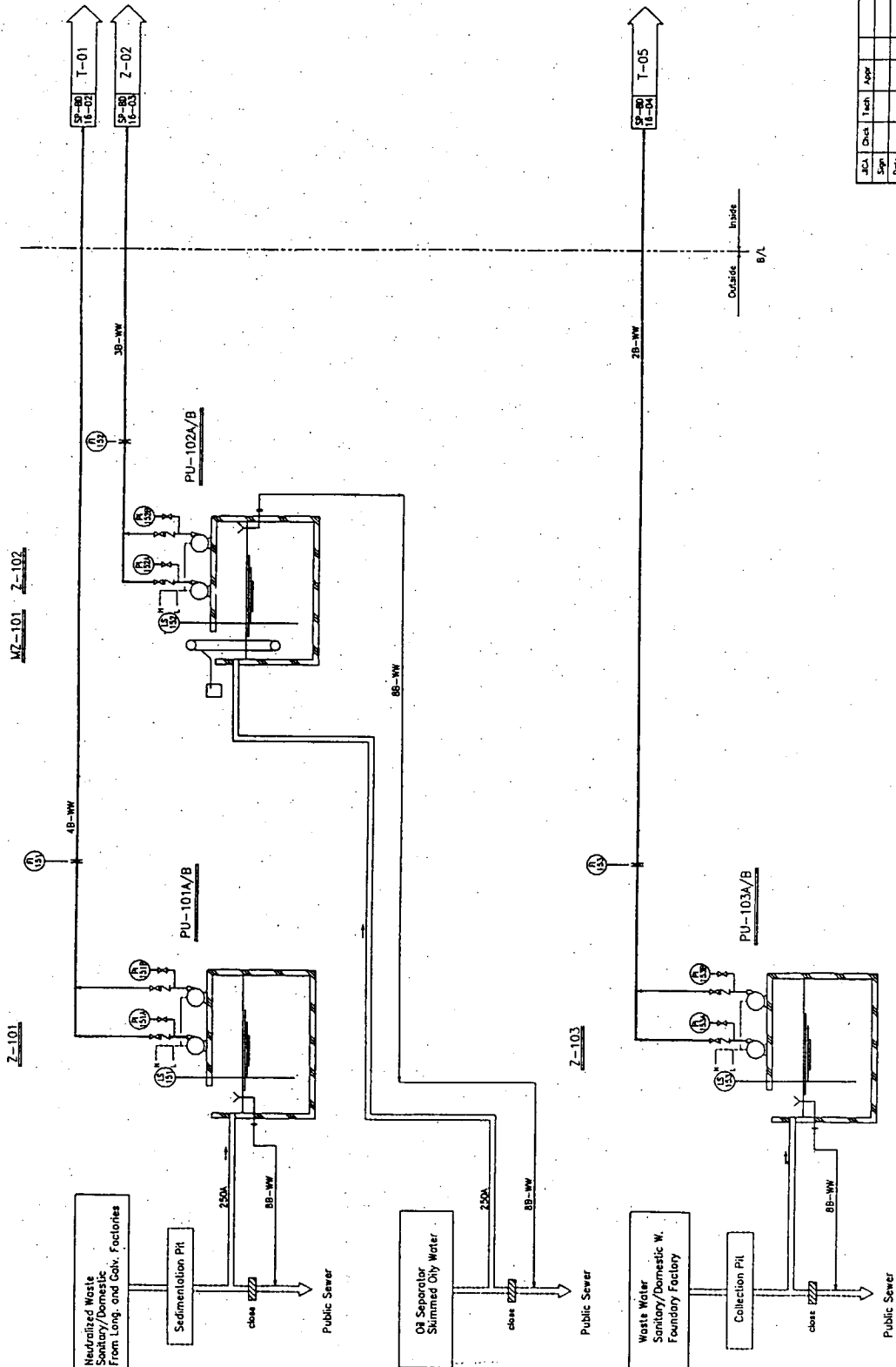

Rev.	Issued Date	Scale	Notes
SP-80 18-02			
SP-80 18-03			
SP-80 18-04			

Rev.	Description	Rev.	Check	Appr.	Date

CLIENT	JAPAN INTERNATIONAL COOPERATION AGENCY INDUSTRIAL DEVELOPMENT STUDY DIVISION
CONSULTANT	CHYODA JAMES & MOORE CO. CHYODA CORPORATION
PROJECT	THE STUDY ON INDUSTRIAL WASTE WATER POLLUTION CONTROL IN THE ARAB REPUBLIC OF EGYPT
TITLE	FOR EL MASR CO. FOR STEEL PIPES AND FITTINGS ENGINEERING FLOW DIAGRAM FOR No. 1 W.W.T. RECOVERABLE PLANT (1/3)
ISSUED DATE	
DWG NO	SP-80-18-01
SCALE	
REV.	
REV.	0

ITEM No.	Service	Size (m)	Design Press (kg-cm ²)	Design Temp (°C)	Material/Type	RC/Open Basin	RC/Open Basin	RC/Open Basin	SCS/Centrif. Vertical	SCS/Centrif. Vertical	SCS/Centrif. Vertical	MZ-01
Z-101	No. 1 Wastewater P.H.	4.0m x 5.0m x 3.5mH	3.0mW x 5.0m x 3.5mH	Full Water	Amb.	RC/Open Basin	RC/Open Basin	Amb.	SCS/Centrif. Vertical	SCS/Centrif. Vertical	Amb.	MZ-01
Z-102	No. 2 Wastewater P.H.	3.0mW x 5.0m x 3.5mH	3.0mW x 5.0m x 3.5mH	Full Water	Amb.	RC/Open Basin	RC/Open Basin	Amb.	SCS/Centrif. Vertical	SCS/Centrif. Vertical	Amb.	Belt Oil Skimmer
Z-103	No. 3 Wastewater P.H.	2.0mW x 3.0m x 3.5mH	2.0mW x 3.0m x 3.5mH	Full Water	Amb.	RC/Open Basin	RC/Open Basin	Amb.	SCS/Centrif. Vertical	SCS/Centrif. Vertical	Amb.	W-300.0.4W
PU-101A/B	No. 1 Wastewater Pump	4.0m ³ /No. 30m x 1.1W	4.0m ³ /No. 30m x 1.1W	Full Water	Amb.			Amb.			Amb.	
PU-102A/B	No. 2 Wastewater Pump	3.0m ³ /No. 25m x 1.1W	3.0m ³ /No. 25m x 1.1W	Full Water	Amb.			Amb.			Amb.	
PU-103A/B	No. 3 Wastewater Pump	2.0m ³ /No. 25m x 1.1W	2.0m ³ /No. 25m x 1.1W	Full Water	Amb.			Amb.			Amb.	

D-03 MZ-01 D-01 D-02 MX-01

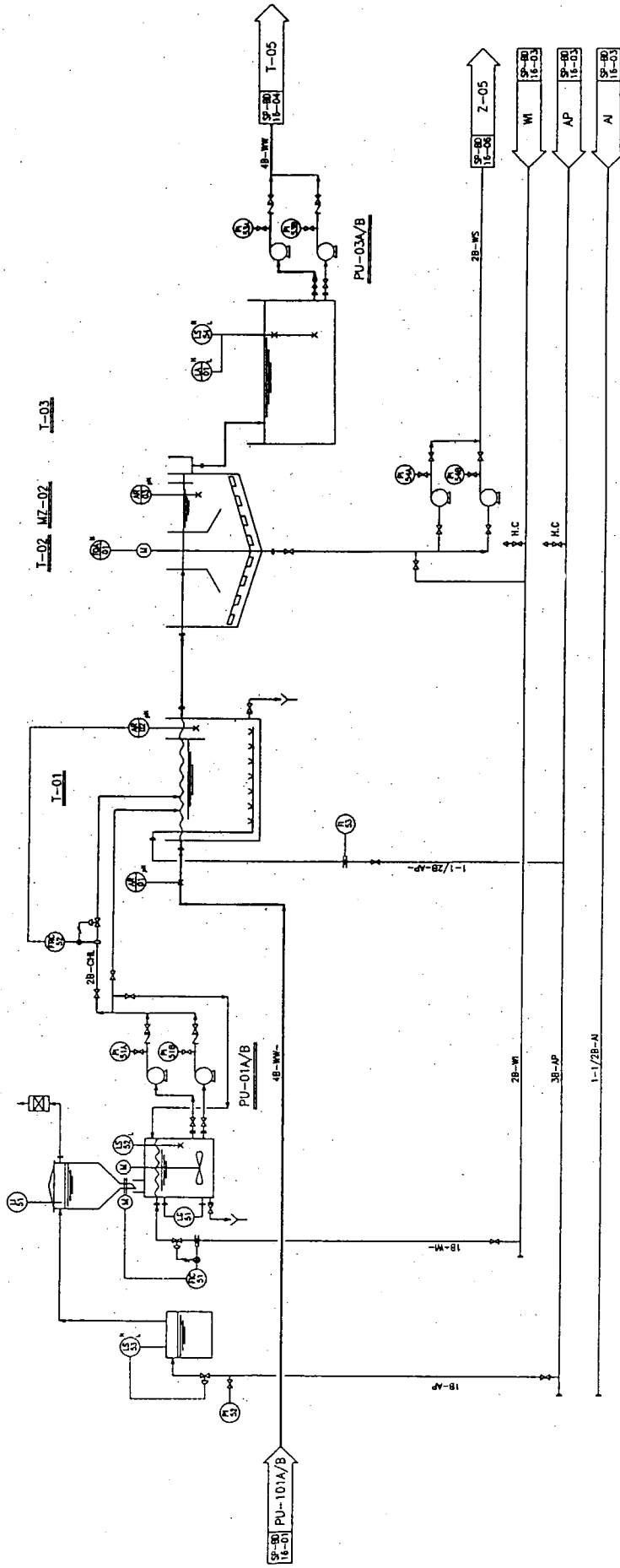

I-02 MZ-02 I-03

PU-02A/B

ITEM No.	DESCRIPTION	UNIT	QTY	MATERIAL/TYPE	INSTALLATION	REMARKS
PU-03A/B	Neutralized W.W. Pump	No. 1		Line Hogger	CS+Center Drive	CS/Centrif. Horiz.
PU-01A/B	Line Hogger	No. 1		Line Hogger	CS+Center Drive	CS/Centrif. Horiz.
PU-02A/B	Line Receiver	No. 1		Line Hogger	CS+Center Drive	CS/Centrif. Horiz.
I-02	Sedimentation Tank	No. 1		Line Hogger	CS+Center Drive	CS/Centrif. Horiz.
I-03	I-03	No. 1		Line Hogger	CS+Center Drive	CS/Centrif. Horiz.
I-01	Neutralization Tank	No. 1		Line Hogger	CS+Center Drive	CS/Centrif. Horiz.
MZ-01	Sludge Pump	No. 1		Line Hogger	CS+Center Drive	CS/Centrif. Horiz.
PU-01A/B	Lime Pump	No. 1		Line Hogger	CS+Center Drive	CS/Centrif. Horiz.
I-04	I-04	No. 1		Line Hogger	CS+Center Drive	CS/Centrif. Horiz.
PU-101A/B	Neutralized W.W. Tank	No. 1		Line Hogger	CS+Center Drive	CS/Centrif. Horiz.
PU-01A/B	Line Hogger	No. 1		Line Hogger	CS+Center Drive	CS/Centrif. Horiz.
PU-02A/B	Line Hogger	No. 1		Line Hogger	CS+Center Drive	CS/Centrif. Horiz.
PU-03A/B	Line Hogger	No. 1		Line Hogger	CS+Center Drive	CS/Centrif. Horiz.
PU-04A/B	Line Hogger	No. 1		Line Hogger	CS+Center Drive	CS/Centrif. Horiz.
PU-05A/B	Line Hogger	No. 1		Line Hogger	CS+Center Drive	CS/Centrif. Horiz.
PU-06A/B	Line Hogger	No. 1		Line Hogger	CS+Center Drive	CS/Centrif. Horiz.
PU-07A/B	Line Hogger	No. 1		Line Hogger	CS+Center Drive	CS/Centrif. Horiz.
PU-08A/B	Line Hogger	No. 1		Line Hogger	CS+Center Drive	CS/Centrif. Horiz.
PU-09A/B	Line Hogger	No. 1		Line Hogger	CS+Center Drive	CS/Centrif. Horiz.
PU-10A/B	Line Hogger	No. 1		Line Hogger	CS+Center Drive	CS/Centrif. Horiz.
PU-11A/B	Line Hogger	No. 1		Line Hogger	CS+Center Drive	CS/Centrif. Horiz.
PU-12A/B	Line Hogger	No. 1		Line Hogger	CS+Center Drive	CS/Centrif. Horiz.
PU-13A/B	Line Hogger	No. 1		Line Hogger	CS+Center Drive	CS/Centrif. Horiz.
PU-14A/B	Line Hogger	No. 1		Line Hogger	CS+Center Drive	CS/Centrif. Horiz.
PU-15A/B	Line Hogger	No. 1		Line Hogger	CS+Center Drive	CS/Centrif. Horiz.
PU-16A/B	Line Hogger	No. 1		Line Hogger	CS+Center Drive	CS/Centrif. Horiz.
PU-17A/B	Line Hogger	No. 1		Line Hogger	CS+Center Drive	CS/Centrif. Horiz.
PU-18A/B	Line Hogger	No. 1		Line Hogger	CS+Center Drive	CS/Centrif. Horiz.
PU-19A/B	Line Hogger	No. 1		Line Hogger	CS+Center Drive	CS/Centrif. Horiz.
PU-20A/B	Line Hogger	No. 1		Line Hogger	CS+Center Drive	CS/Centrif. Horiz.
PU-21A/B	Line Hogger	No. 1		Line Hogger	CS+Center Drive	CS/Centrif. Horiz.
PU-22A/B	Line Hogger	No. 1		Line Hogger	CS+Center Drive	CS/Centrif. Horiz.
PU-23A/B	Line Hogger	No. 1		Line Hogger	CS+Center Drive	CS/Centrif. Horiz.
PU-24A/B	Line Hogger	No. 1		Line Hogger	CS+Center Drive	CS/Centrif. Horiz.
PU-25A/B	Line Hogger	No. 1		Line Hogger	CS+Center Drive	CS/Centrif. Horiz.
PU-26A/B	Line Hogger	No. 1		Line Hogger	CS+Center Drive	CS/Centrif. Horiz.
PU-27A/B	Line Hogger	No. 1		Line Hogger	CS+Center Drive	CS/Centrif. Horiz.
PU-28A/B	Line Hogger	No. 1		Line Hogger	CS+Center Drive	CS/Centrif. Horiz.
PU-29A/B	Line Hogger	No. 1		Line Hogger	CS+Center Drive	CS/Centrif. Horiz.
PU-30A/B	Line Hogger	No. 1		Line Hogger	CS+Center Drive	CS/Centrif. Horiz.

Appr.	Check	Date	Appr.	Check	Date

REVISION

Rev.	Description	By	Check	Date
01				
02				
03				
04				
05				

CLIENT	JAPAN INTERNATIONAL COOPERATION AGENCY INDUSTRIAL DEVELOPMENT STUDY DIVISION
CONSULTANT	CHITODA DAMES & MOORE CO. CHITODA CORPORATION
PROJECT	THE STUDY ON INDUSTRIAL WASTE WATER POLLUTION CONTROL IN THE ARAB REPUBLIC OF EGYPT
TITLE	FOR EL MASR CO. FOR STEEL PIPES AND FITTINGS ENGINEERING FLOW DIAGRAM FOR No. 1 W.W.T. RECYCLABLE PLANT(2/3)
ISSUED DATE	SCALE
DWG NO	REV. NO
SP-80 16-03	SP-80-16-02

Z-01 Z-02 Z-03 PU-05 I-04

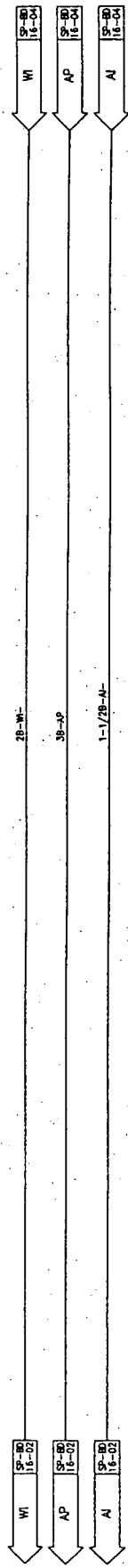
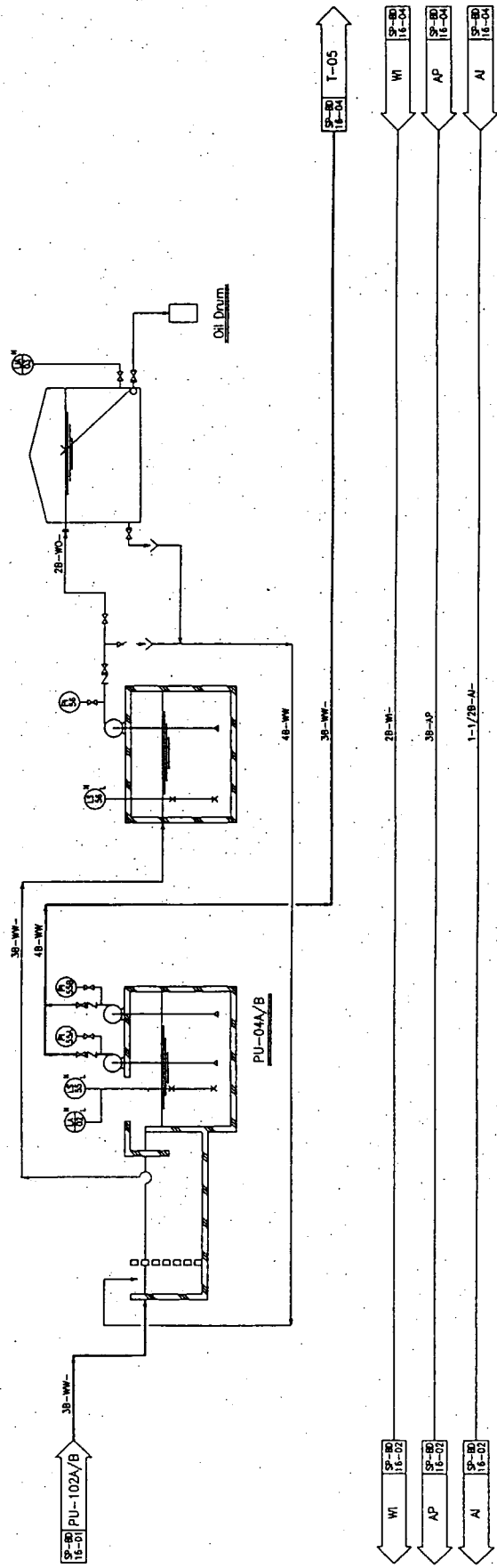

ITEM No.	Z-01	Z-02	Z-03	I-04	PU-04A/B	PU-05
SERVICE	Oil Separator	Oil Separator I.W.P/W	Skimmed Oil P/W	Skimmed Oil Tank	Oil Separator I.W.P/W	Recessed Oil Pump
SIZE (m)	1.5mWx0.8mLx1.0mD	2.4mWx2.5mLx3.0mD	1.5mWx2.0mLx3.0mD	3.1mDx6.1mH	3.6mW/1.1mLx1.5mHx5.5mW	1.5mH/1.5mLx2.2mW
DESIGN PRESSURE	Full Water	Full Water	Full Water	Full Water	Full Water	Full Water
DESIGN TEMP (°C)	Amb.	Amb.	Amb.	Amb.	Amb.	Amb.
MATERIAL/TYPE	RC/API	RC/Open Basin	RC/Closed Basin	CS/Conc Roof Tank	SCS/Concr.Ventl.	C/Concr.Ventl.

JICA	Check	Tech	Appr	Supr	Draw	Scale	Rev	Description	Drawn	Check	Appr	Date
CLIENT: JAPAN INTERNATIONAL COOPERATION AGENCY REGISTERAL DEVELOPMENT STUDY DIVISION CONSULTANT: CHYODA DAMES & MOORE CO. CHYODA CORPORATION PROJECT: THE STUDY ON INDUSTRIAL WASTE WATER TREATMENT PLANTS IN THE ARAB REPUBLIC OF EGYPT TITLE: FOR E. INGR CO. FOR STEEL PIPES AND FITTINGS DESIGN AND FABRICATION (PART 1, PART 2, PART 3) ISSUED DATE: _____ SCALE: _____ DWG NO: SP-18-11-03 REV: _____												

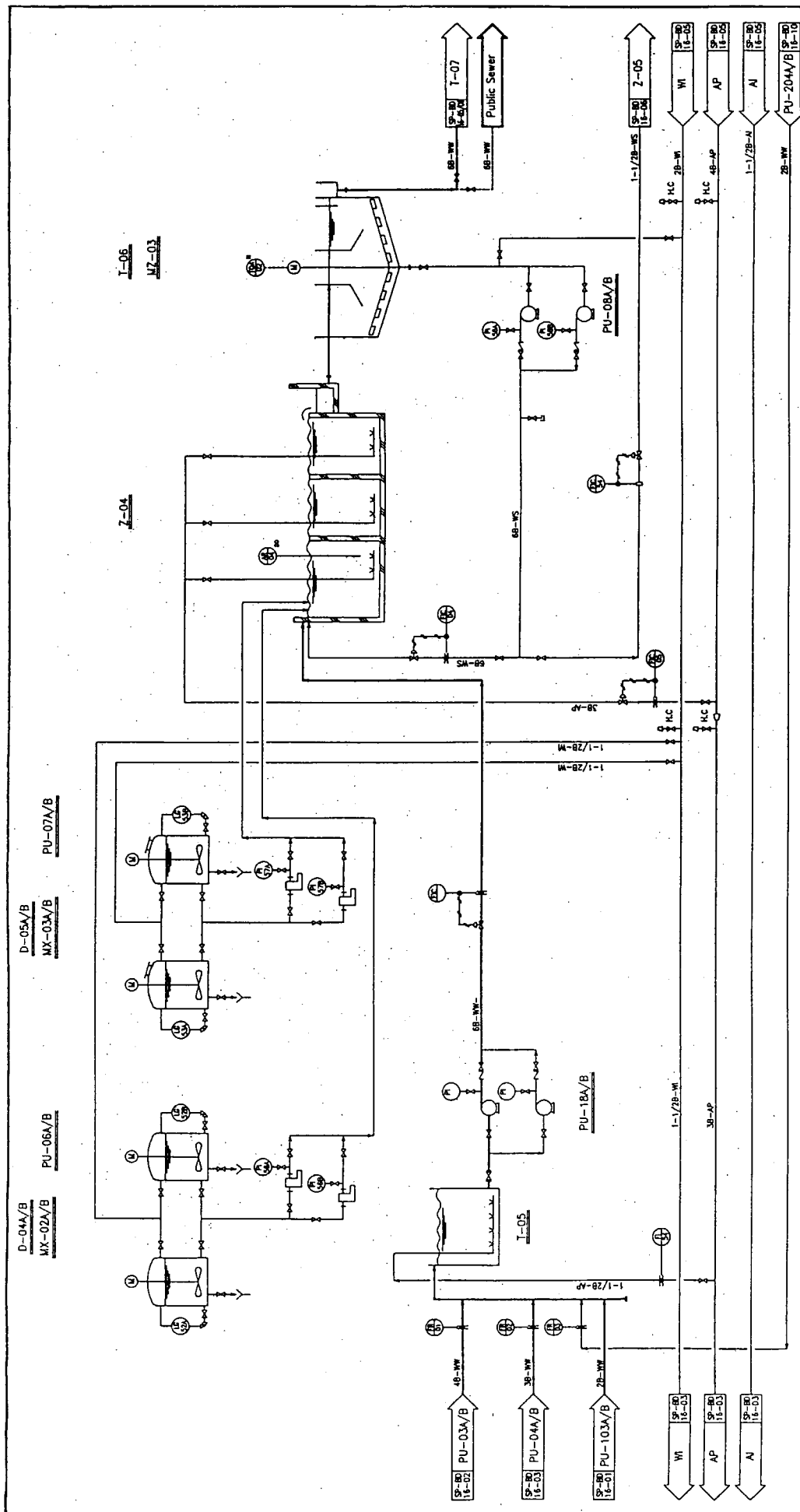

Rev	Issue	Appr	Check	Draw	Scale	Notes

CLIENT: JAPAN INTERNATIONAL COOPERATION AGENCY
INDUSTRIAL DEVELOPMENT STUDY DIVISION

CONSULTANT: CHITODA DAMES & MOORE CO.

PROJECT: THE STUDY ON INDUSTRIAL WASTE WATER POLLUTION CONTROL IN THE ARAB REPUBLIC OF EGYPT

TITLE: FOR EL. WASH. CO. FOR STEEL PIPES AND FITTINGS EXPANSION. FLOW DIAGRAM FOR NO. 1 & 2 RECYCLABLE PLANT (1/2)

ISSUED DATE: SCALE: REVISION

DWG NO: SP-80-18-04

ITEM No.	DESCRIPTION	SIZE (m)	DESIGN PRESS (kg/cm ²)	DESIGN TEMP (°C)	MATERIAL/TYPE
PU-18A/B	Equalized Water Pump	8m ³ /hr	0.2	40°C	CS/Horizontal
I-06	No.2 Sedimentation Tank	9.67m x 6.0m x 3.0m	1.0	40°C	CS/Cylindrical
I-05	Equidistribution Tank	8.71m x 7.6m x 3.0m	1.0	40°C	CS/Cylindrical
I-07	Equidistribution Tank	8.71m x 7.6m x 3.0m	1.0	40°C	CS/Cylindrical
D-05A/B	Nutrient (P) Drum	0.7m x 1.5m x 1.5m	1.0	40°C	CS/Horizontal
Z-04	Aeration Basin	5.0m x 1.5m x 4.35m	1.0	40°C	RC/Rectangular
MX-02A/B	Nutrient (N) Mixer	0.4m x 1.0m	1.0	40°C	SUS/Verti
MX-03A/B	Nutrient (P) Mixer	0.4m x 1.0m	1.0	40°C	SUS/Verti
NO-03	No.2 Sludge Rake	1.5m	1.0	40°C	CS+Epoxy/C. Driven
PU-08A/B	Nutrient (N) Pump	0.1L/min @ 0.5MPa @ 0.4kW	1.0	40°C	SCS/Double room
PU-07A/B	Nutrient (P) Pump	0.1L/min @ 0.5MPa @ 0.4kW	1.0	40°C	SCS/Double room
PU-06A/B	Sludge Circulation Pump	35m ³ /hr @ 2mH ₂ O @ 1.7kW	1.0	40°C	SCS/Vertical

D-08A/B
 D-07A/B
 D-06A/B

MX-04A/B
 MX-05A/B
 MX-06A/B

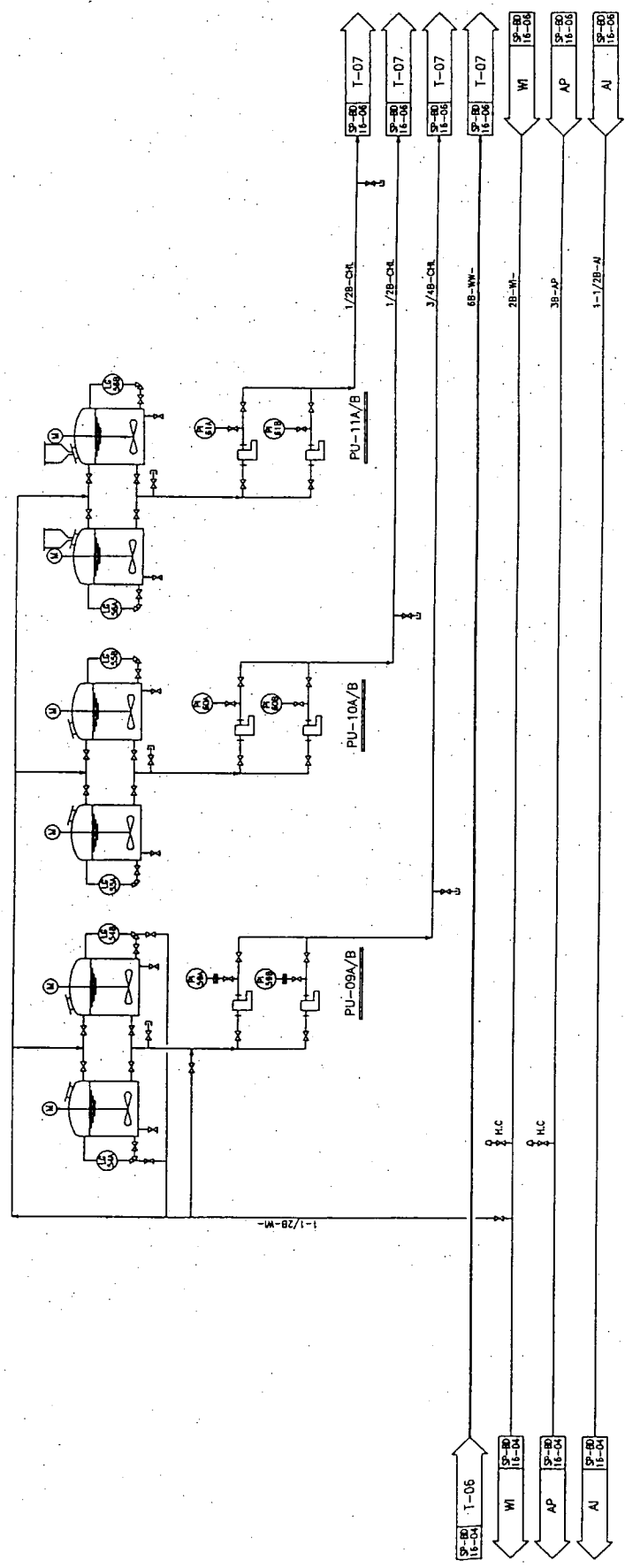

J.C.	Check	Appr.	Rev.	Rev.
Sign				
Draw				
Spec				
Rev.				

CLIENT: JAPAN INTERNATIONAL COOPERATION AGENCY
 INDUSTRIAL DEVELOPMENT STUDY DIVISION

CONSULTANT: CHYODA DAMES & MOORE CO.
 CHYODA CORPORATION

PROJECT: THE STUDY ON INDUSTRIAL WASTE WATER TREATMENT AT THE HUB REFINERY OF EGYPT

TITLE: DOWNSIDE FLOW SCHEMATIC (Part 1)
 No. 1. Part 1. REFINERY WASTE WATER

ISSUED DATE: SP-80-16-05

DWG NO: SP-80-16-05

REV: 0

ITEM No.	DESCRIPTION	UNIT	QTY	REMARKS
D-06A/B	No. 2 Line Drum 1.4mDx1.8mH Full Water	CS/Vert.	1	
D-07A/B	No. 1 Coagulant Drum 1.2mDx1.8mH Full Water	CS+HRL/Vert.	1	
D-08A/B	No. 2 Coagulant Drum 1.2mDx1.5mH Full Water	CS/Vert.	1	
MX-04A/B	No. 2 Line Mixer 1.5xW, L=1.2m	SUS/Vertical	1	
MX-05A/B	No. 1 Line Mixer 0.75xW, L=1.2m	SUS/Vertical	1	
MX-06A/B	No. 2 Line Mixer 0.75xW, L=1.0m	SUS/Vertical	1	
PU-09A/B	No. 2 Line Pump 0.8L/min @ 5.0MPa @ 0.75kW	Amb.	1	
PU-10A/B	No. 2 Line Pump 0.3L/min @ 5.0MPa @ 0.15kW	Amb.	1	
PU-11A/B	No. 2 Line Pump 0.3L/min @ 5.0MPa @ 0.15kW	Amb.	1	
H.C.	Horizontal Clarifier		1	
V.C.	Vertical Clarifier		1	
1-1/2B-W	Collection Line		1	
1-1/2B-N	Final Collection Line		1	

I-07
MX-07 MX-08

I-08
MZ-04

Z-05
Z-06

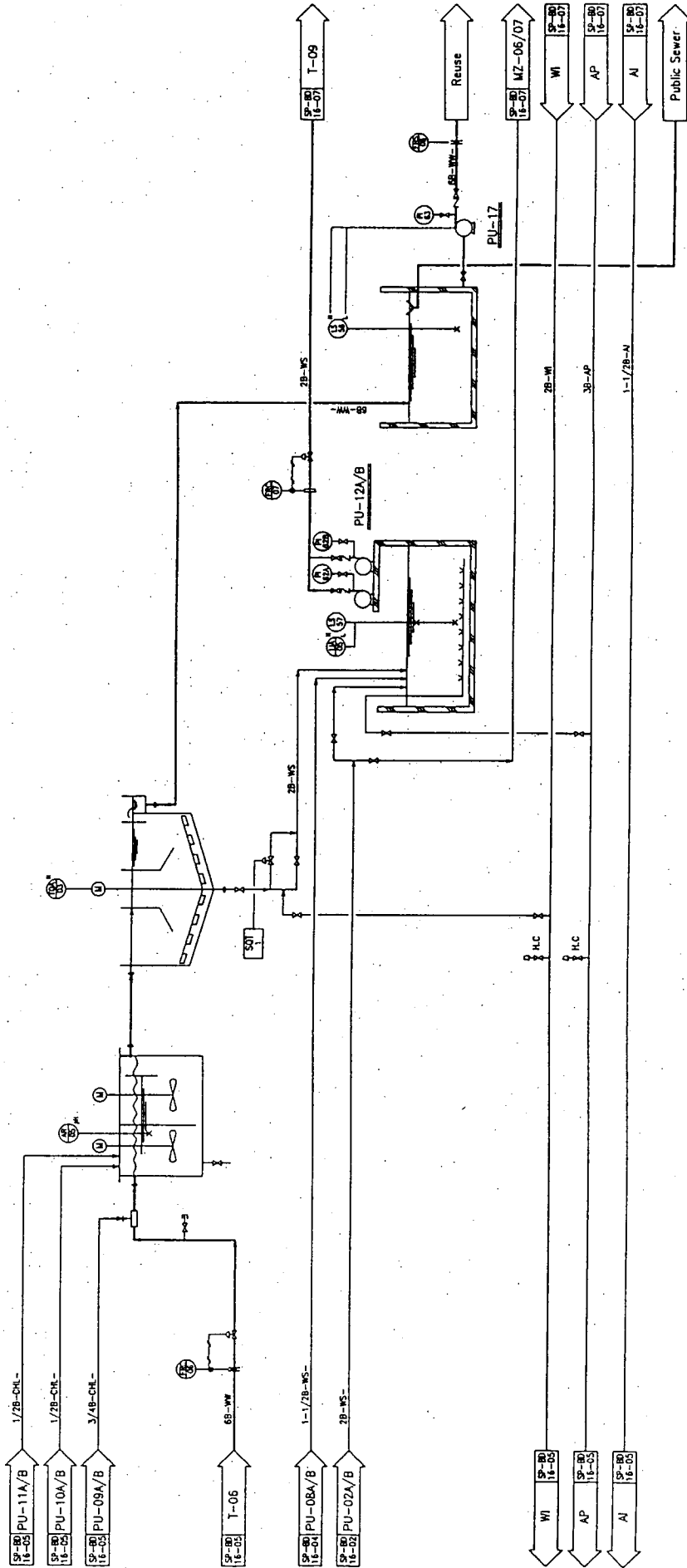

Rev.	Chg.	Test	Appr.	Rev.	Chg.	Test	Appr.

Rev.	Chg.	Test	Appr.	Rev.	Chg.	Test	Appr.

Rev.	Chg.	Test	Appr.	Rev.	Chg.	Test	Appr.

Rev.	Chg.	Test	Appr.	Rev.	Chg.	Test	Appr.

CLIENT	JAPAN INTERNATIONAL COOPERATION AGENCY INDUSTRIAL DEVELOPMENT STUDY DIVISION
CONSULTANT	CHITODA DAIKES & MOORE CO. CHITODA CORPORATION
PROJECT	THE STUDY ON INDUSTRIAL WASTE WATER POLLUTION CONTROL IN EGYPT
TITLE	FOR EL MASR CO. FOR STEEL PIPES AND FITTINGS ENGINEERING FLOW DIAGRAM FOR No. 1 W.W.T. RECYCLABLE PLANT(1/1)
ISSUED DATE	SCALE
DWG NO	REV.

ITEM No.	I-07	I-08	7-05	7-06	MX-07	MX-08	MZ-04	PU-12A/B	PU-17
DESCRIPTION	Coagulation/Flotation Tank	No. 3 Sedimentation Tank	Treated Water PH	Flocculation Mixer	Coagulation Mixer	Flocculation Mixer	No. 3 Sludge Rake	Sludge Feed Pump	T.W. Reuse Pump
SIZE (m)	1.1m x 2.8m x 4.5m	5.8m x 4.5m x 4.5m	3.0m x 5.2m x 2.5m	2.2m (L=1.5m)	2.2m (L=1.5m)	2.2m (L=1.5m)	1.5m x 5.1m	2m ³ /hr	80m ³ /hr
DESIGN PRESS (MPa)	Full Water	Full Water	Full Water	None	None	None	None	1.0	1.0
DESIGN TDUP (C)	Amb.	Amb.	Amb.	Amb.	Amb.	Amb.	Amb.	Amb.	Amb.
MATERIAL TYPE	CS+Epoxy/Rectangular	CS+Epoxy/Rectangular	RC/Open	SUS/Vertical	SUS/Vertical	SUS/Vertical	CS+Epoxy/Center Drive	SSS/Center/Vert.	SSS/Center/Vert.

Z-07

D-09
MX-09

T-09
MZ-05

D-10
MX-10

MZ-06
MZ-07

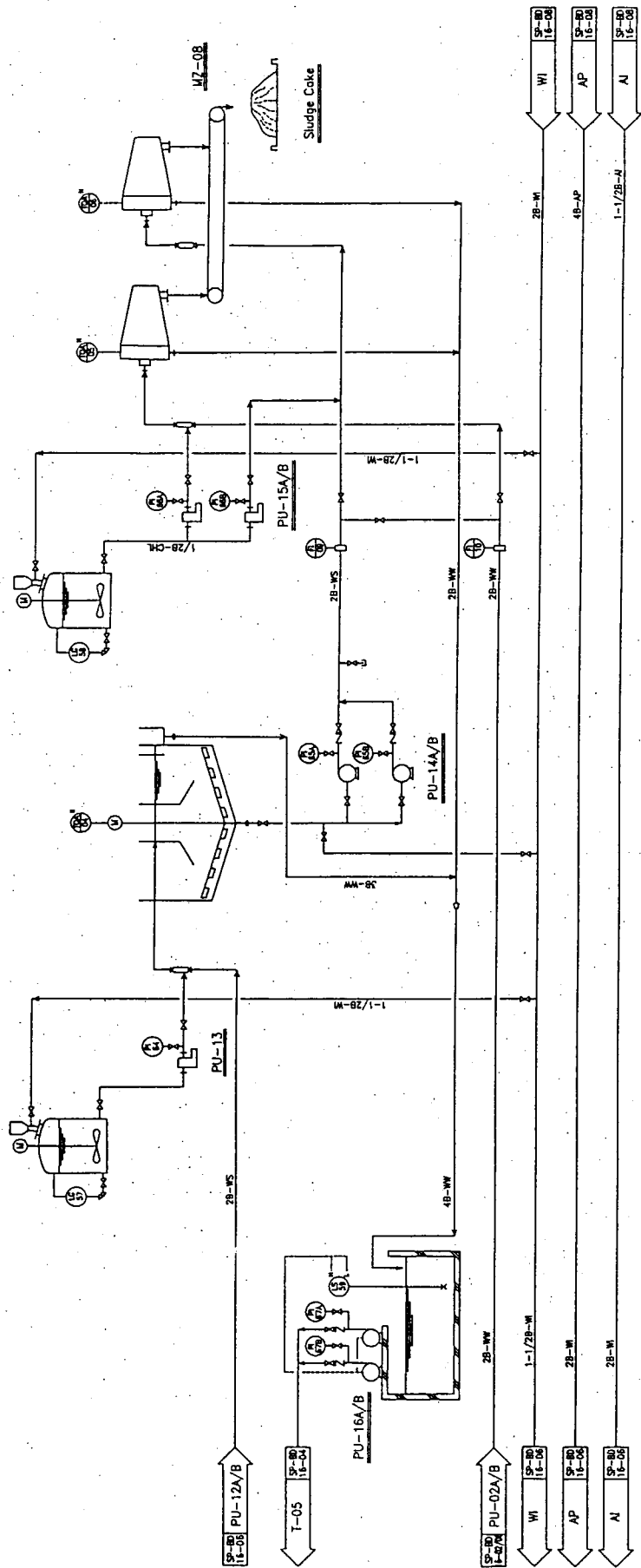

ITEM No.	DESCRIPTION	PU-12A/B	PU-13A/B	PU-14A/B	PU-15A/B	PU-16A/B	T-05	T-09
SERVICE	Settling Aid Pump	Filter Aid Pump	W.W Return Pump	W.W Return Pump	W.W Return Pump	W.W Return Pump	Wastewater PH	Wastewater PH
SIZE(m)	0.1L/m ³ @ 50000 4W	3.0L/m ³ @ 15000 3.7W	3.0L/m ³ @ 15000 3.7W	3.0L/m ³ @ 15000 3.7W	3.0L/m ³ @ 15000 3.7W	3.0L/m ³ @ 15000 3.7W	3.0m ³ @ 1.5m ³ /hr	3.0m ³ @ 1.5m ³ /hr
DESIGN PRESSURE	1.0	1.0	1.0	1.0	1.0	1.0	Full Water	Full Water
DESIGN TEMP (°C)	Amb.	Amb.	Amb.	Amb.	Amb.	Amb.	Amb.	Amb.
MATERIAL/TYPE	SCS/Plunger	SCS/Plunger	SCS/Plunger	SCS/Plunger	SCS/Plunger	SCS/Plunger	RC/Open Basin	RC/Open Basin
ITEM No.	D-09	D-09	D-10	MZ-05	MZ-06	MZ-07	MZ-08	MZ-09
SERVICE	Settling Aid Drum	Sludge Thickener	Sludge Thickener	Sludge Thickener	Sludge Thickener	Sludge Thickener	Sludge Thickener	Sludge Thickener
SIZE(m)	0.7m ³ @ 1.5m ³ /hr	3.2m ³ @ 3.0m ³ /hr	3.2m ³ @ 3.0m ³ /hr	3.2m ³ @ 3.0m ³ /hr	3.2m ³ @ 3.0m ³ /hr	3.2m ³ @ 3.0m ³ /hr	3.2m ³ @ 3.0m ³ /hr	3.2m ³ @ 3.0m ³ /hr
DESIGN PRESSURE	Full Water	Full Water	Full Water	Full Water	Full Water	Full Water	Full Water	Full Water
DESIGN TEMP (°C)	Amb.	Amb.	Amb.	Amb.	Amb.	Amb.	Amb.	Amb.
MATERIAL/TYPE	CS/Vert.	CS/Vert.	CS/Vert.	CS/Horizontal	CS/Horizontal	CS/Horizontal	CS/Horizontal	CS/Horizontal

NO.	DATE	BY	CHKD	APPD	REVISION
1					
2					
3					
4					
5					
6					
7					
8					
9					
10					

CLIENT: JAPAN INTERNATIONAL COOPERATION AGENCY
INDUSTRIAL DEVELOPMENT STUDY DIVISION

CONSULTANT: CHYODA DAMES & MOORE CO.
CHYODA CORPORATION

PROJECT: THE STUDY ON INDUSTRIAL WASTE WATER POLLUTION CONTROL IN THE ARAB REPUBLIC OF EGYPT

TITLE: ENGINEERING FLOW DIAGRAM FOR No. 1 W.W.T. RECOMMENDED PLANT(7/8)

ISSUED DATE: SP-80-14-07

DWG NO: SP-80-14-07

SCALE: REV. 0

B-01A/B

C-01

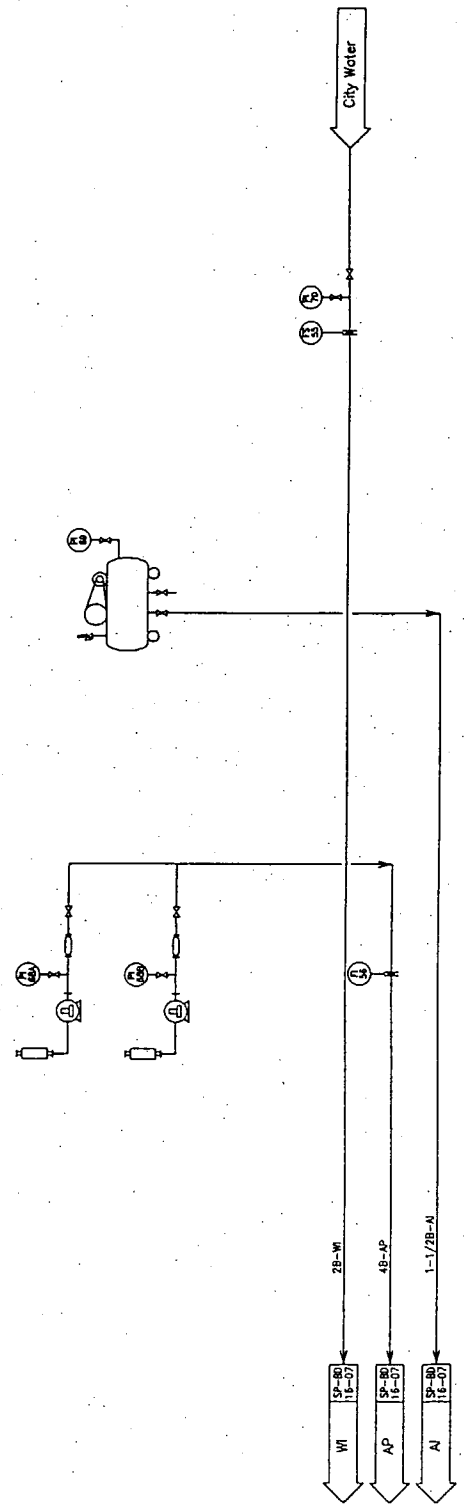

ITEM No.	B-01A/B	C-01
SERVICE	AP Boiler	AI Compressor
SIZE (m)	9.5km ² /max/7mht.15kW	0.2m ³ /min/0.7MPa/1.5kW
DESIGN PRESS (MPa)	1	1
DESIGN TEMP (°C)	200	200
MATERIAL TYPE	GI/Steel	GI/Relay

JICA	Check	Task	Appr	Date	Sign	Check	Appr	Date	Sign	Check	Appr	Date	Sign	Check	Appr	Date

CLIENT	JAPAN INTERNATIONAL COOPERATION AGENCY INDUSTRIAL DEVELOPMENT STUDY DIVISION
CONSULTANT	CHIYODA DAMES & MOORE CO. CHIYODA CORPORATION
PROJECT	THE STUDY ON INDUSTRIAL WASTE WATER PREVENTION MEASURES FOR THE ARAB REPUBLIC OF EGYPT
TITLE	FOR CI WOR CO. FOR STEEL PIPES AND FITTINGS DESIGNED FOR 1.5MPa/1.5kW (100/1.5) MATERIAL: GI/STEEL
ISSUED DATE	SP-8B-18-08
DWG NO.	SP-8B-18-08
SCALE	REV.
	0

D-201A/B
MX-201A/B

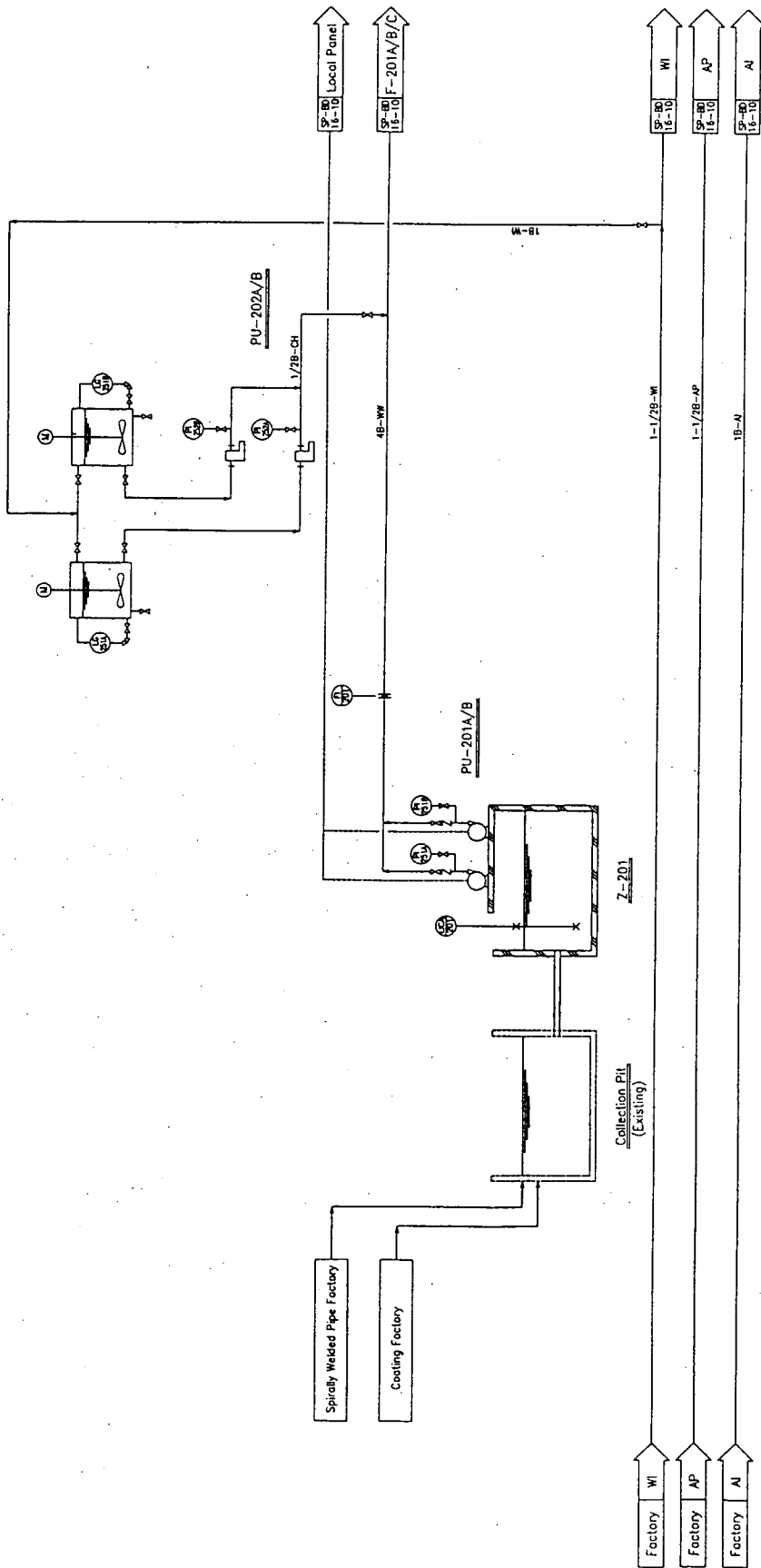

Rev	Issue	Date	By	Check	Appr	Desc

CLIENT	JAPAN INTERNATIONAL COOPERATION AGENCY INDUSTRIAL DEVELOPMENT STUDY DIVISION
CONSULTANT	CHIYODA DAMES & MOORE CO. CHIYODA CORPORATION
PROJECT	THE STUDY ON INDUSTRIAL WASTE WATER POLLUTION CONTROL IN THE ARAB REPUBLIC OF EGYPT
TITLE	FOR EL NASR CO. FOR STEEL PIPES AND FITTINGS No. 1 W.W.T. RECONSTRUCTIBLE PLANT (1/2)
ISSUED DATE	
DWG NO	SP-RD-16-09
SCALE	
REV.	0

ITEM No.	D-201A/B	MX-201A/B	PU-202A/B	Z-201	PU-201A/B
SERVICE	No. 2 Collection Drum	No. 2 Collection Mast	No. 2 Collection Pump	No. 4 Wastewater Pit	No. 4 Wastewater Pump
SIZE (m)	1.2m Dia. x 1.2m	0.35m Dia. x 1.2m	0.51 / min. dia. x 0.4m	1.5m x 3.0m x 3.5m	0.6m x 1.2m x 0.5m
DESIGN PRESS (kg/cm ²)	Full Water	Full Water	Full Water	Full Water	Full Water
DESIGN TEMP. (C)	Amb.	Amb.	Amb.	Amb.	Amb.
MATERIAL TYPE	CS+HR/Vert.	SS/Vert.	SS/Number	RC/Open Basin	SS/Chin/Vert.

F-201A/B/C

Z-202

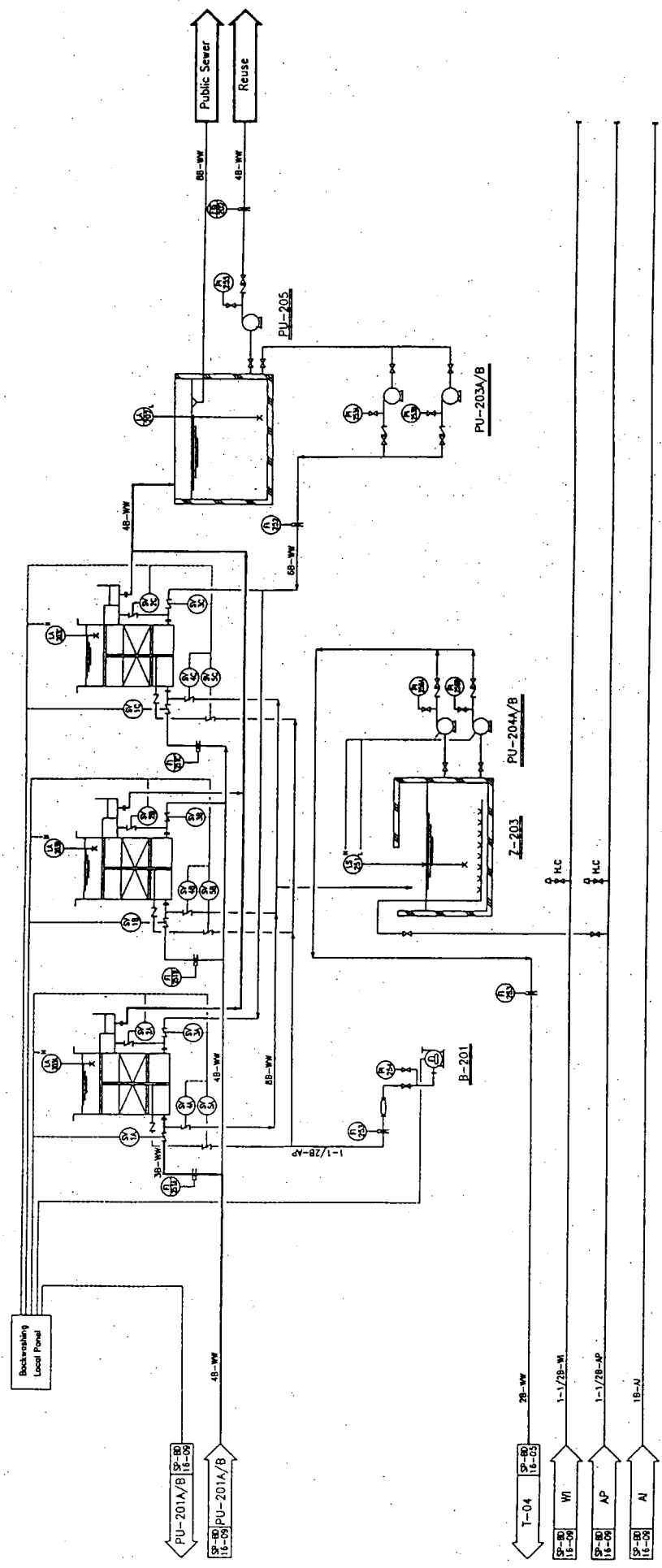

Acc	Check	Tech	Appr	Rev	Description	Begin	Check	Appr	Date

CLIENT	JAPAN INTERNATIONAL COOPERATION AGENCY INDUSTRIAL DEVELOPMENT STUDY DIVISION	
CONSULTANT	CHRYDIA DAMES & MOORE CO. CHRYDIA CORPORATION	
PROJECT	THE STUDY ON INDUSTRIAL WASTE WATER POLLUTION CONTROL IN THE ARAB REPUBLIC OF EGYPT	
TITLE	FOR C. WASH CO. FOR STEEL PIPES AND FITTINGS ENGINEERING FLOW DIAGRAM FOR No. 2 W.W.T. RECOVERABLE PLANT (Z/2)	
ISSUED DATE	SCALE	REV.
DWG NO	SP-80-14-10	0

ITEM No.	DESCRIPTION	UNIT	QTY	REMARKS
F-201A/B/C	Sand Filter	2.1mDx4.5mH	3	
Z-202	Filtered Water PH	3.0mWx5.0mLx3.0mD	1	
B-201	Backwashing Blower	3.0mWx3.0mLx3.0mD	1	
Z-203	Backwash W.W. PH	3.0mWx5.0mLx3.0mD	1	
PU-204A/B	Backwash W.W. Feed Pump	3.0mWx5.0mLx3.0mD	1	
PU-203A/B	Backwashing Pump	15.5mWx1.0mLx1.1mH	1	
PU-205	Recovered Water Pump	60mWx1.0mLx1.1mH	1	

NOTE:

- 1) Type: Cylindrical Tank
(Open Top Tank)
- 2) Materials: Carbon Steel
inside Epoxy Coating
- 3) Accessories: Stairway
Inside Ladder
Air Bubbling

Tube

Loading Data

Weight Empty: 14.5ton
Full Water: 450ton

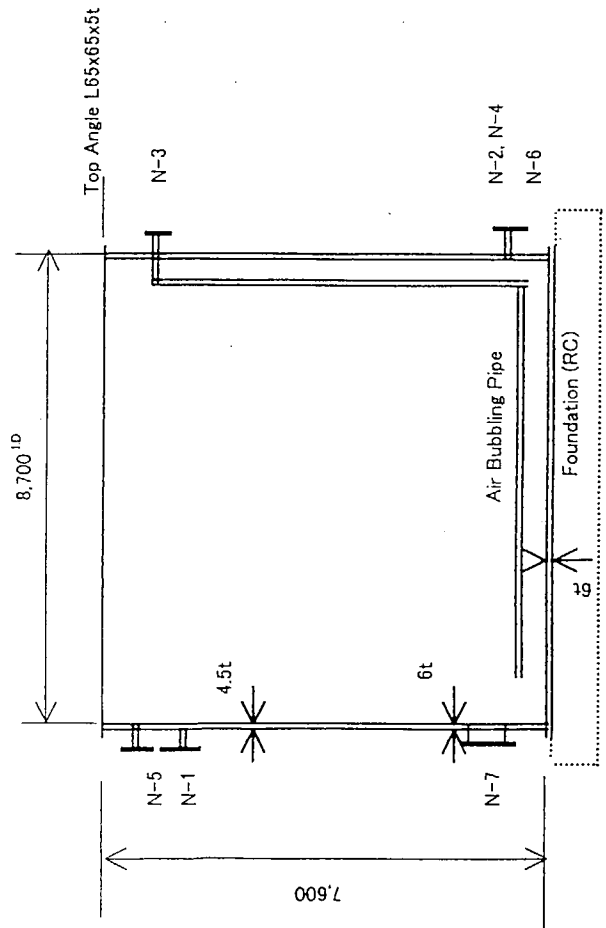
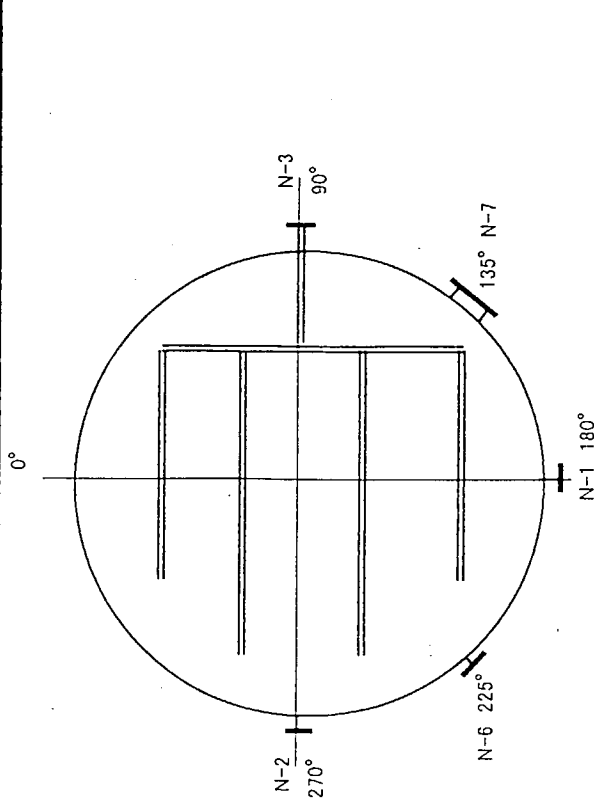

N-7	Manhole	500A	1
N-6	Level Instrument	6B	1
N-5	Over Flow	8B	1
N-4	Drain	4B	1
N-3	Bubbling Air Inlet	2B	1
N-2	Raw Water Outlet	6B	2
N-1	Raw Water inlet	6B	1
No	Name	Size	No
Note			

CLIENT: JAPAN INTERNATIONAL COOPERATION AGENCY

TYTLE: FOR: EL NASR Co. for STEEL PIPES & FITTINGS
450 m³ EQUALIZATION TANK (T-5)

DWG. NO: SP - BD - 22 - SK01 REV.0

WASTEWATER TREATMENT PLANT

NOTE:

Material: Reinforced Concrete

Accessories: Skimming Pipe

Hand rail, Inside Ladder

Option: Flight Scraper (Surface, Bottom)

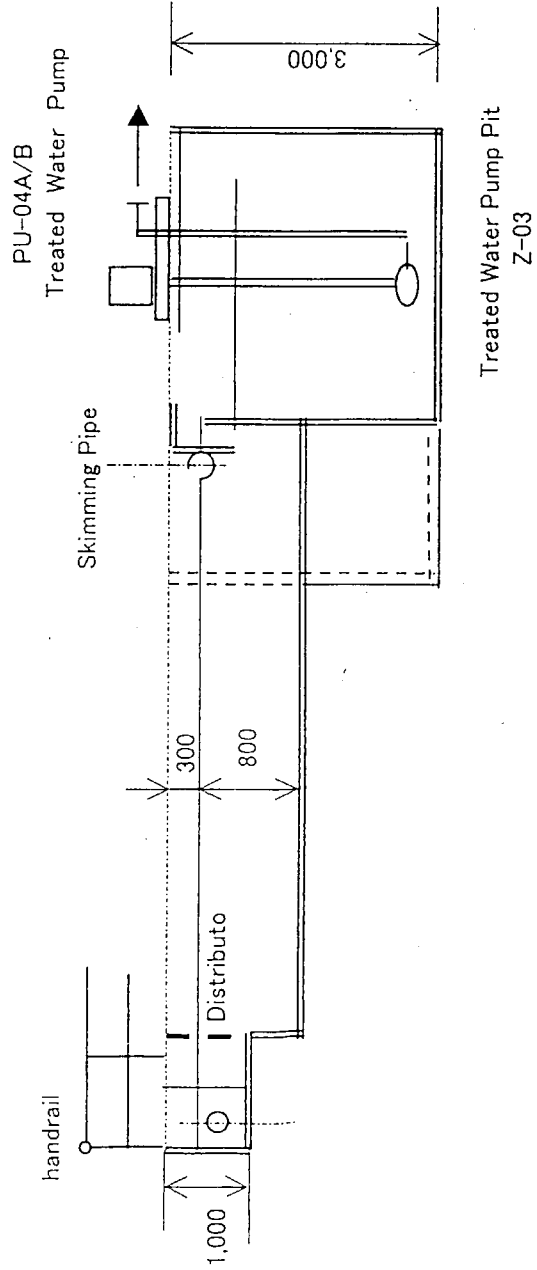
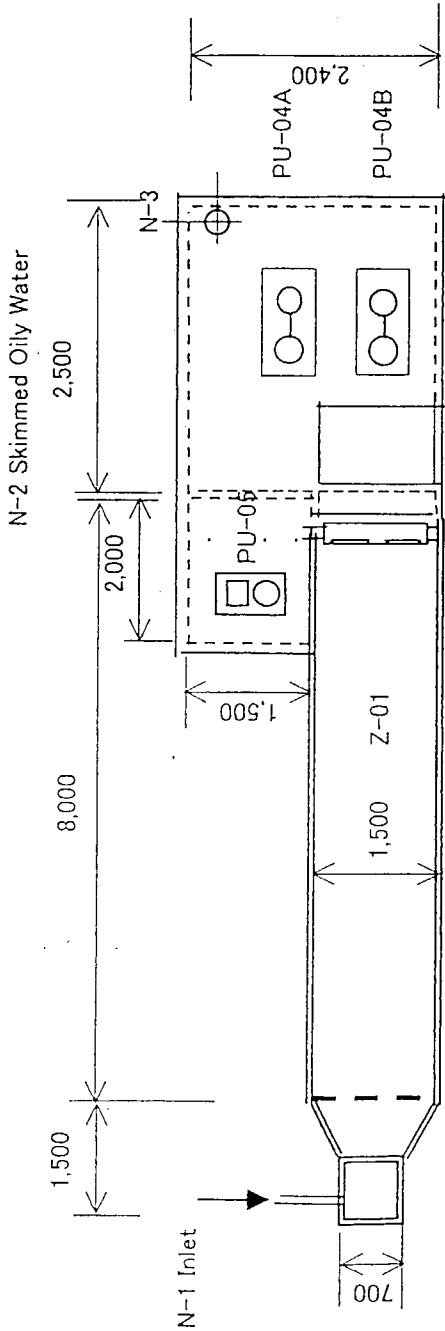

N-3	Level Instrument	6B	1
N-2	Skimmed Oily	6B	1
	Water Outlet		
N-1	Raw Water inlet	6B	1
Nozzle No	Name	Size	Note
CLIENT	JAPAN INTERNATIONAL COOPERATION AGENCY		
TYTLE	FOR: EL NASR STEEL PIPES & FITTINGS OIL SEPARATOR (Z-01/03/04) WASTEWATER TREATMENT PLANT		
DWG. NO	SP - BD - 51 - SK01		REV.0

Materials: Carbon Steel/Epoxy coating
 Accessories: Sludge Collection Rake
 Operating Stage
 Stairway

- T-02: No.1 Sedimentation Tank
 D=5,811 H=3,000
- T-06: No.2 Sedimentation Tank
 D=9,688 H=4,000
- T-08: No.3 Sedimentation Tank
 D=5,811 H=3,000

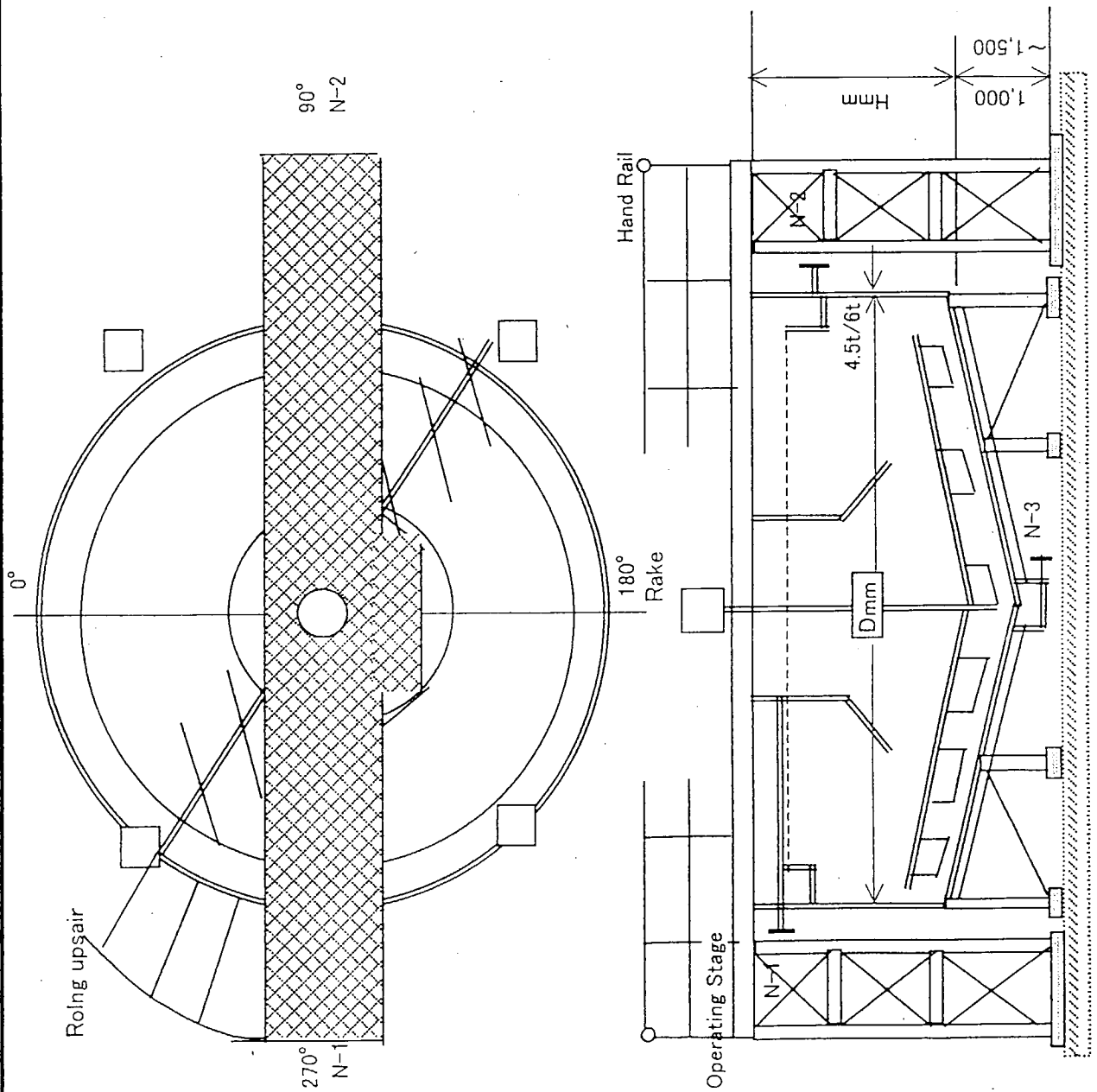

N-3	Sludge Outlet	6B	1	
N-2	Treated Water Outlet	6B	1	
N-1	Raw Water inlet	6B	1	
Nozzle No	Name	Size	No	Note
CLIENT	JAPAN INTERNATIONAL COOPERATION AGENCY			
TYTLE	FOR: EL NASR STEEL PIPES & FITTINGS OIL SEPARATOR (Z-01) WASTEWATER TREATMENT PLANT			
DWG. NO	SP - BD - 22 - SK02			REV.0

Materials: Reinforced Concrete
 Accessories: Operating Stage
 Stairway
 Air Distributing pipings

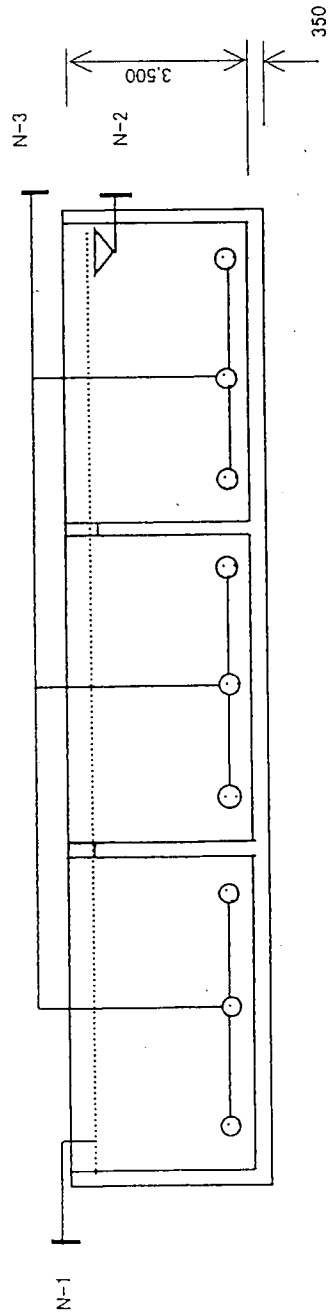
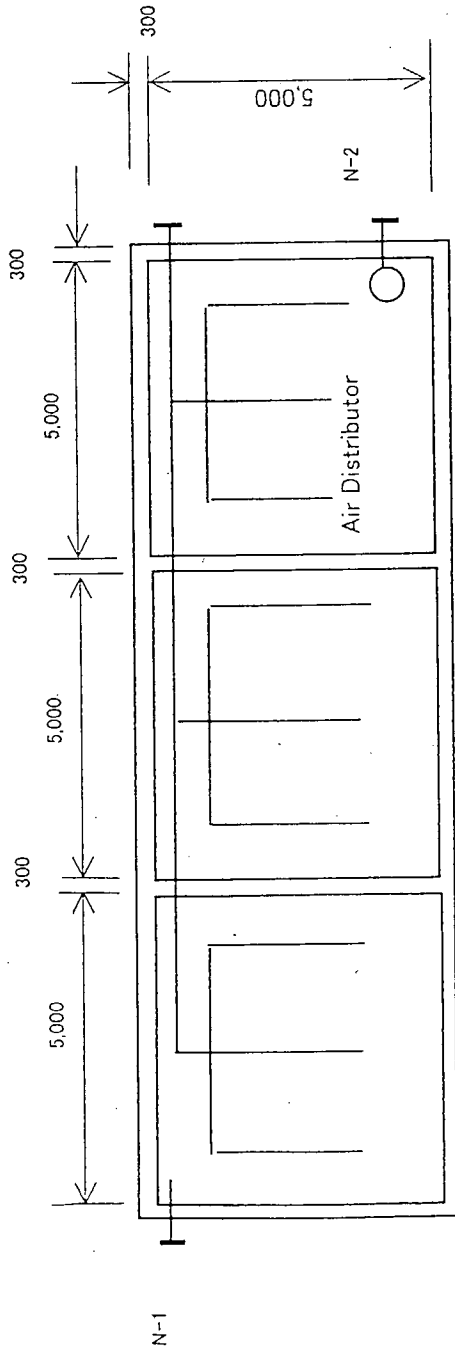

N-3	Air Inlet	3B	1
N-2	T. Water Outlet	6B	1
N-1	Inlet	6B	1
Nozzle No	Name	Size	No
Note			
CLIENT JAPAN INTERNATIONAL COOPERATION AGENCY			
FOR: EL NASR CO. FOR STEEL PIPES & FITTING			
TYTLE AERATION BASIN (Z-04)			
WASTEWATER TREATMENT PLANT			
DWG. NO	SP - BD - 51 - SK02	REV.0.	

Materials: Carbon Steel/Epoxy coating
 Accessories: Sludge Collection Rake
 Operating Stage
 Stairway

- T-02: No.1 Sedimentation Tank
 D=5,811 H=3,000
- T-06: No.2 Sedimentation Tank
 D=9,688 H=4,000
- T-08: No.3 Sedimentation Tank
 D=5,811 H=3,000

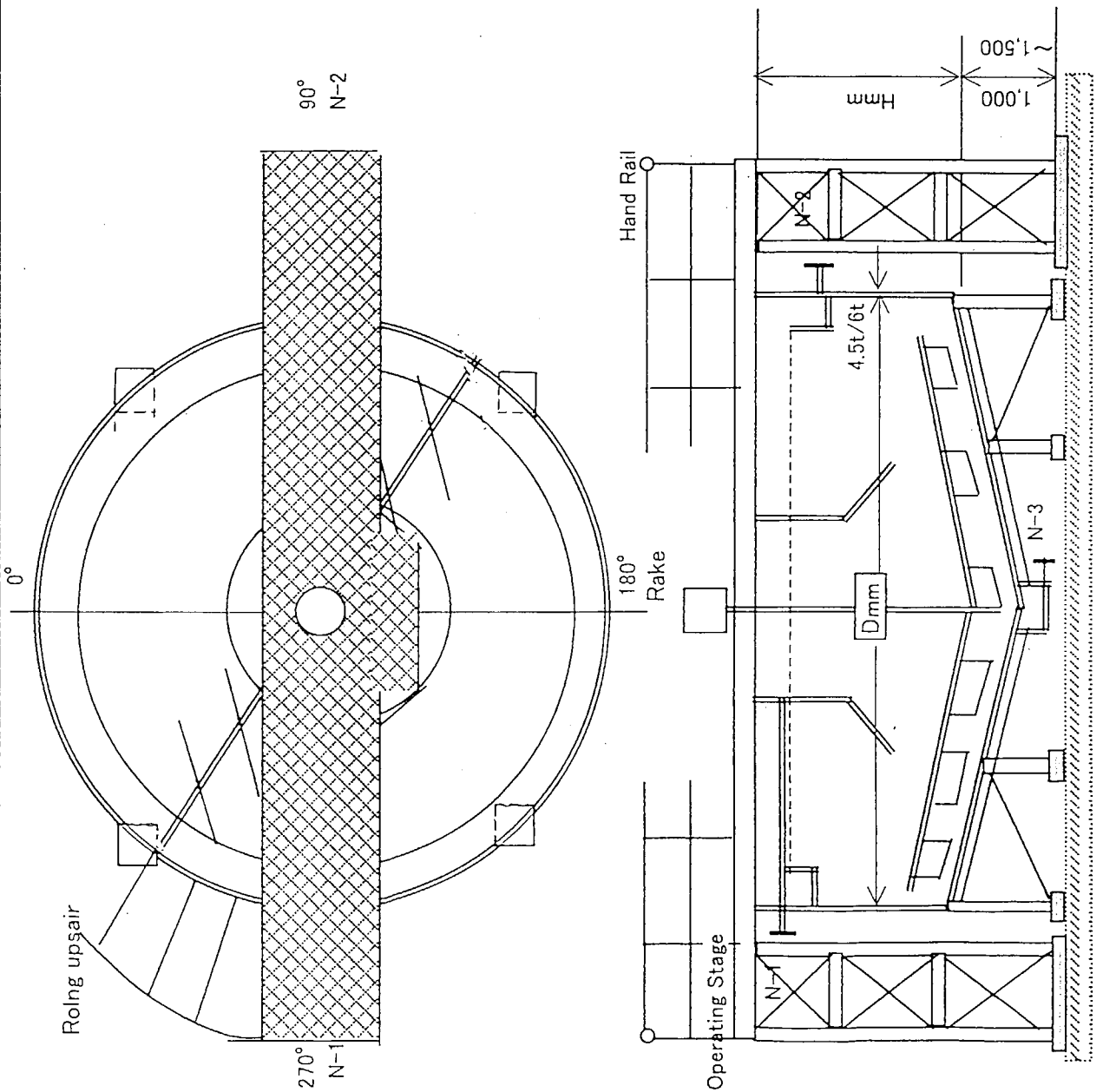

N-3	Sludge Outlet	6B	1	
N-2	Treated Water Outlet	6B	1	
N-1	Raw Water inlet	6B	1	
Nozzle No	Name	Size	No	Note
CLIENT: JAPAN INTERNATIONAL COOPERATION AGENCY				
FOR: EL NASR CO. FOR STEEL PIPES & FITTINGS				
TYTLE: SEDIMENTATION TANK (T-02/06/06)				
WASTEWATER TREATMENT PLANT				
DWG. NO	SP - BD - 22 - SK02			REV.0

Material: Carbon steel/Epoxy Coating

Filter Media: Anthracite + Sand/Gravel

Accessories: Operating Stage
Ladder

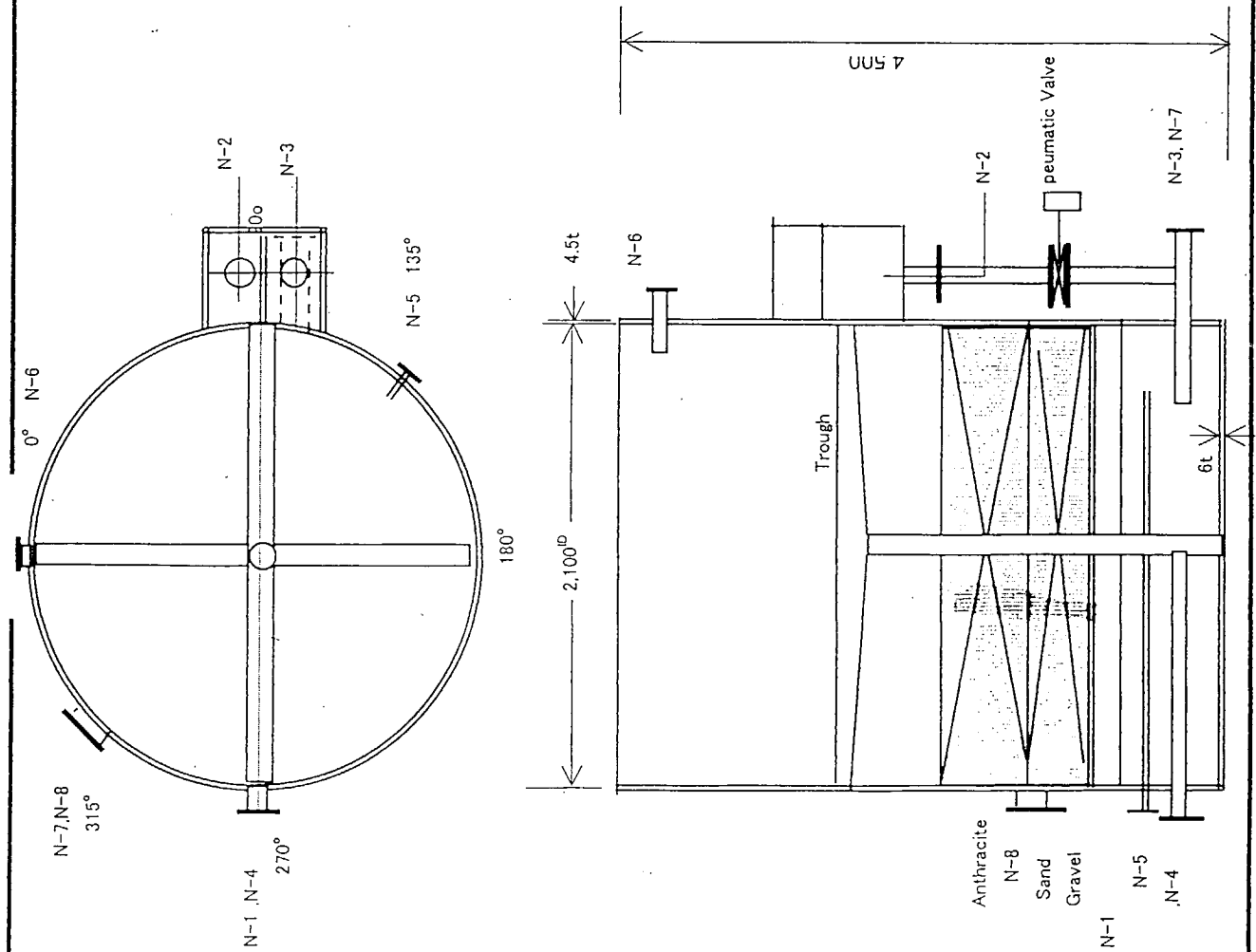

No	Name	Size	No	Note
N-8	Handhole	200A	1	
N-7	Manhole	500A	1	
N-6	Over Flow	6B	1	
N-5	Air Inlet	4B	1	
N-4	B.Water Outlet	8B	1	
N-3	B. Water Inlet	8B	1	
N-2	F.Water Outlet	4B	1	
N-1	C.Water Inlet	4B	1	

CLIENT: JAPAN INTERNATIONAL COOPERATION AGENCY
 FOR: EL NASR CO. FOR STEEL PIPES & FITTINGS
 TYTLE: SAND FILTER (F-01A/B/C)
 WASTEWATER TREATMENT PLANT
 DWG. NO: SP - BD - 22 - SK03 REV.0

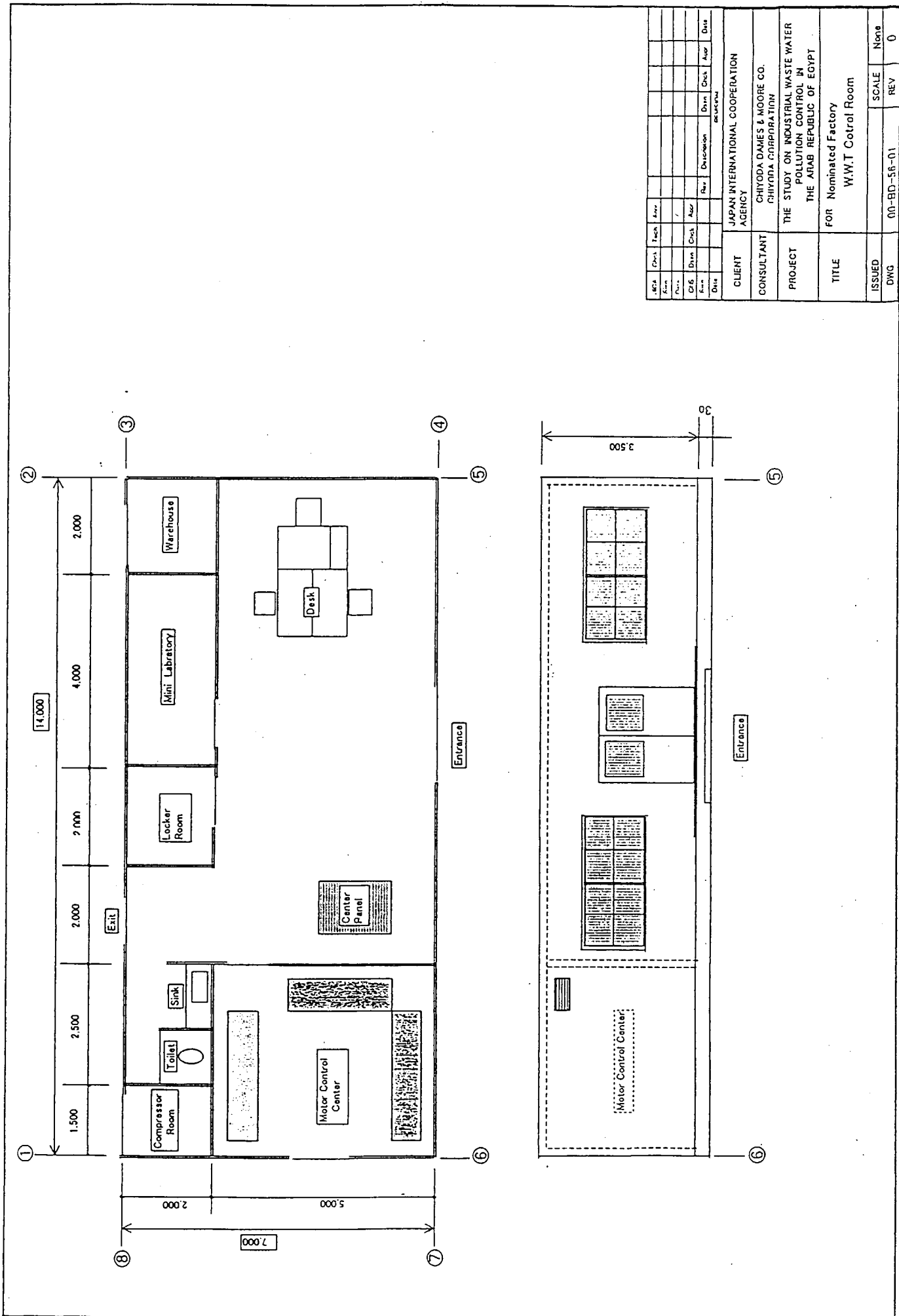

Rev.	Chk.	Appr.	Date	Rev.	Chk.	Appr.	Date

CLIENT	JAPAN INTERNATIONAL COOPERATION AGENCY
CONSULTANT	CHIYODA DAMES & MOORE CO. CHYODDA CORPORATION
PROJECT	THE STUDY ON INDUSTRIAL WASTE WATER POLLUTION CONTROL IN THE ARAB REPUBLIC OF EGYPT
TITLE	FOR Nominated Factory W.W.T Control Room
ISSUED DWG	00-BD-56-01
SCALE	None
REV	0

INDUCTION MOTOR LIST

DOC. NO.	: SP-ID-60-L1-(1/3)
CLIENT	: Japan International Cooperation Agency
PROJECT	: The Study on Industrial Waste Water Plant
PLANT	: El Nasr Co. For Steel Pipes & Fittings
WASTE W.	: Industrial W.W./Sanitary-Domestic W.W.

Motor No.	Service	No. Required	Type	Output		Speed Chrt	Revolu tion rpm	V-Φ-Hz	Time Rating	Starting		Insula tion	Enclose	Cable	Mounting	Drive	Bearing	Acc.	Location	Color Finish	Remarks
				Estimate	Final					Current	Torque										
PU-01-A/B-M	No.1 Lime Pump	2	SC	0.8		C	1500	380-3-50	G				TEFC		H	D			OD		
PU-02A/B-M	No.1 Sludge Pump	2	SC	2.2		C	1500	380-3-50	G				TEFC		H	D			OD		
PU-03A/B-M	Neutralized W.W. Pump	2	SC	5.5		C	1500	380-3-50	G				TEFC		H	D			OD		
PU-04A/B-M	Oil Separator T.W. Pump	2	SC	5.5		C	1500	380-3-50	G				TEFC		V	D			OD		
PU-05-M	Recovered Oil Pump	1	SC	1.5		C	1500	380-3-50	G				TEFC		V	D			OD		
PU-06A/B-M	Nutrient(N) Pump	2	SC	0.4		C	1500	380-3-50	G				TEFC		H	G			OD		
PU-07A/B-M	Nutrient(P) Pump	2	SC	0.4		C	1500	380-3-50	G				TEFC		H	G			OD		
PU-08A/B-M	Sludge Circulation Pump	2	SC	3.7		C	1500	380-3-50	G				TEFC		H	D			OD		
PU-09A/B-M	No.2 Lime Pump	2	SC	0.8		C	1500	380-3-50	G				TEFC		H	G			OD		
PU-10A/B-M	Coagulant Pump	2	SC	0.4		C	1500	380-3-50	G				TEFC		H	G			OD		
PU-11A/B-M	Coagulant Aid Pump	2	SC	0.4		C	1500	380-3-50	G				TEFC		H	G			OD		
PU-12A/B-M	Sludge Food Pump	2	SC	2.2		C	1500	380-3-50	G				TEFC		V	D			OD		
PU-13-M	Settling Aid Pump	1	SC	0.4		C	1500	380-3-50	G				TEFC		H	G			OD		
PU-14A/B-M	Centrifuge Feed Pump	2	SC	3.7		C	1500	380-3-50	G				TEFC		H	G			OD		
PU-15A/B-M	Filter Aid Pump	2	SC	0.8		C	1500	380-3-50	G				TEFC		H	G			OD		
PU-16A/B-M	W.W. Return Pump	2	SC	0.8		C	1500	380-3-50	G				TEFC		V	D			OD		
PU-17-M	T.W. Return Pump	1	SC	1.5		C	1500	380-3-50	G				TEFC		H	D			OD		
PU-18A/B-M	Equalized Water Pump	2	SC	5.5		C	1500	380-3-50	G				TEFC		H	D			OD		
B-01A/B-M	AP Blower	2	SC	1.5		C	1500	380-3-50	G				TEFC		H	B			OD		
C-01-M	AI Compressor	1	SC	1.5		C	1500	380-3-50	G				TEFC		B	B			ID		
MZ-01-M	Lime Feeder	1	SC	0.8		C	1500	380-3-50	G				TEFC		H	G			OD		
MZ-02-M	No.1 Sludge Rake	1	SC	1.5		C	1500	380-3-50	G				TEFC		V	G			OD		
MZ-03-M	No.2 Sludge Rake	1	SC	1.5		C	1500	380-3-50	G				TEFC		V	G			OD		
MZ-04-M	No.3 Sludge Rake	1	SC	1.5		C	1500	380-3-50	G				TEFC		V	G			OD		
MZ-05-M	No.4 Sludge Rake	1	SC	0.8		C	1500	380-3-50	G				TEFC		V	G			OD		
MZ-06-M	No.1 Centrifuge	1	SC	1.5		C	2000	380-3-50	G				TEFC		H	D			OD		
MZ-07-M	No.2 Centrifuge	1	SC	7.5		C	2000	380-3-50	G				TEFC		H	D			OD		
MZ-08-M	Belt Conveyor	1	SC	0.8		C	1500	380-3-50	G				TEFC		H	B			OD		

Notes:

1. Type : SC = Squirrel Cage, W = Wound Rotor.
2. Speed : C = Constant, M = Multi, A = Adjustable, V = Varying.
3. Revolution Direction : Direction when viewed from coupling side.
CW = Clockwise, CCW = Counter-Clockwise.
4. Voltage : Rated Voltage
5. Time Rating : C = Continuous, ST = Short Time, P = Periodic.

6. Enclosure : TEFC = Totally-Enclosed Fan-Cooled.
DR = Drip-Proof.

7. Cable (or Wire) : T = Top, B = Bottom, S = Side, H = Hub for conduit tube or flexible tube.

8. Mounting : H = Horizontal, V = Vertical

9. Drive : D = Direct, B = Belt, C = Chain, G = Gear.

10. Location : ID = Indoor, OD = Outdoor.

INDUCTION MOTOR LIST

DOC. NO.	SP-IBD-60-L1-(2/3)
CLIENT	Japan International Cooperation Agency
PROJECT	The Study on Industrial Waste Water Plant
PLANT	El Nasr Co. for Steel Pipes & Fittings
WASTE W.	Industrial W.W./Sanitary-Domestic W.W.

REV	1	2	3	MADE
BY				CKD
APVE				APVE
DATE				DATE

Motor No.	Service	No. Required	Type	Output		Speed Chrst	Revolu tion	V-φ-Hz	Time Rating	Starting Current	Torque	Insula tion	Enclose	Cable	Mounting	Drive	Bearing	Acc.	Location	Color Finish	Remarks
				Estimate	Final																
MX-01-M	Urea Tank Mixer	1	SC	1.5		C	CW	380-3-50	C				TEFC		V	G			OD		
MX-02A/B-M	Nutrient(N) Mixer	2	SC	0.4		C	CW	380-3-50	C				TEFC		H	G			OD		
MX-03A/B-M	Nutrient(P) Pump	2	SC	0.4		C	CW	380-3-50	C				TEFC		H	G			OD		
MX-04A/B-M	NO.2 Lime Mixer	2	SC	1.5		C	CW	380-3-50	C				TEFC		V	G			OD		
MX-05A/B-M	NO.1 Coagulant Mixer	2	SC	0.8		C	CW	380-3-50	C				TEFC		H	G			OD		
MX-06A/B-M	Coagulant Aid Mixer	2	SC	0.8		C	CW	380-3-50	C				TEFC		H	G			OD		
MX-07-M	Coagulation Mixer	1	SC	2.2		C	CW	380-3-50	C				TEFC		V	G			OD		
MX-08-M	Flocculation Mixer	1	SC	2.2		C	CW	380-3-50	C				TEFC		V	G			OD		
MX-09-M	Settling Aid Mixer	1	SC	0.8		C	CW	380-3-50	C				TEFC		H	G			OD		
MX-10-M	Filter Aid Mixer	1	SC	0.8		C	CW	380-3-50	C				TEFC		H	G			OD		
PU-101A/B-M	No.1 Wastewater Pump	2	SC	11		C	CW	380-3-50	C				TEFC		V	D			OD		
PU-102A/B-M	No.2 Wastewater Pump	2	SC	7.5		C	CW	380-3-50	C				TEFC		V	D			OD		
PU-103A/B-M	No.3 Wastewater Pump	2	SC	2.2		C	CW	380-3-50	C				TEFC		V	D			OD		
MZ-101-M	Belt Oil Skimmer	1	SC	0.4		C	CW	380-3-50	C				TEFC		H	G			OD		

Notes:
 1. Type : SC = Squirrel Cage, W = Wound Rotor.
 2. Speed : C = Constant, M = Multi, A = Adjustable, V = Varying.
 3. Revolution Direction : Direction when viewed from coupling side.
 CW = Clockwise, CCW = Counter-Clockwise.
 4. Voltage : Rated Voltage
 5. Time Rating : C = Continuous, ST = Short Time, P = Periodic.

6. Enclosure : TEFC = Totally-Enclosed Fan-Cooled.
 DR = Drip-Proof.
 7. Cable(or Wire) : T = Top, B = Bottom, S = Side, H = Hub for conduit tube or flexible tube.
 8. Mounting : H = Horizontal, V = Vertical
 9. Drive : D = Direct, B = Belt, C = Chain, G = Gear.
 10. Location : ID = Indoor, OD = Outdoor.

INDUCTION MOTOR LIST

DOC. NO.	SI-400-60-1.1-(3/3)
CLIENT	Japan International Cooperation Agency
PROJECT	The Study on Industrial Waste Water Plant
PLANT	El Nasr Co. for Steel Pipes & Fittings
WASTE. W.	Industrial W.W./Sanitary-Domestic W.W.

Motor No.	Service	No. Required	Type	Output		Speed Chrst	Revolu tion r.p.m	V-Φ-Hz	Time Rating	Starting Current	Starting Torque	Insula tion	Enclosa	Cable	Mounting	Drive	Bearing	Acc.	Location	Color Finish	Remarks
				Estimate	Final																
PU-201A/B-M	No.4 Wastewater Pump	2	SC	5.5		C	4 1500	380-3-50	C				TEFC		V	D			OD		
PU-202A/B-M	No.2 Coagulant Pump	2	SC	0.4		C	4 1500	380-3-50	C				TEFC		H	G			OD		
PU-203A/B-M	Backwashing Pump	2	SC	1.1		C	4 1500	380-3-50	C				TEFC		H	D			OD		
PU-204A/B-M	Backwash W.W. Pump	2	SC	1.5		C	2 3000	380-3-50	C				TEFC		H	D			OD		
PU-205A/B-M	Settling Aid Mixer	1	SC	0.8		C	4 1500	380-3-50	C				TEFC		H	D			OD		
B-201-M	Backwashing Blower	1	SC	5.5		C	4 1500	380-3-50	C				TEFC		H	G			OD		
MX-201A/B-M	No.2 Coagulant Mixer	2	SC	0.8		C	4 1500	380-3-50	C				TEFC		H	G			OD		

Notes:

1. Type : SC = Squirrel Cage, W = Wound Rotor.
2. Speed : C = Constant, M = Multi, A = Adjustable, V = Varying.
3. Revolution Direction : Direction when viewed from coupling side.
CW = Clockwise, CCW = Counter-Clockwise.
4. Voltage : Rated Voltage
5. Time Rating : C = Continuous, ST = Short Time, P = Periodic.
6. Enclosure : TEFC = Totally-Enclosed Fan-Cooled.
DR = Drip-Proof.
7. Cable (or Wire) : T = Top, B = Bottom, S = Side, H = Hub for conduit tube or flexible tube.
8. Mounting : H = Horizontal, V = Vertical
9. Drive : D = Direct, B = Belt, C = Chain, G = Gear.
10. Location : ID = Indoor, OD = Outdoor.

FROM EXISTING
SUBSTATION
30 KV 300V 300V

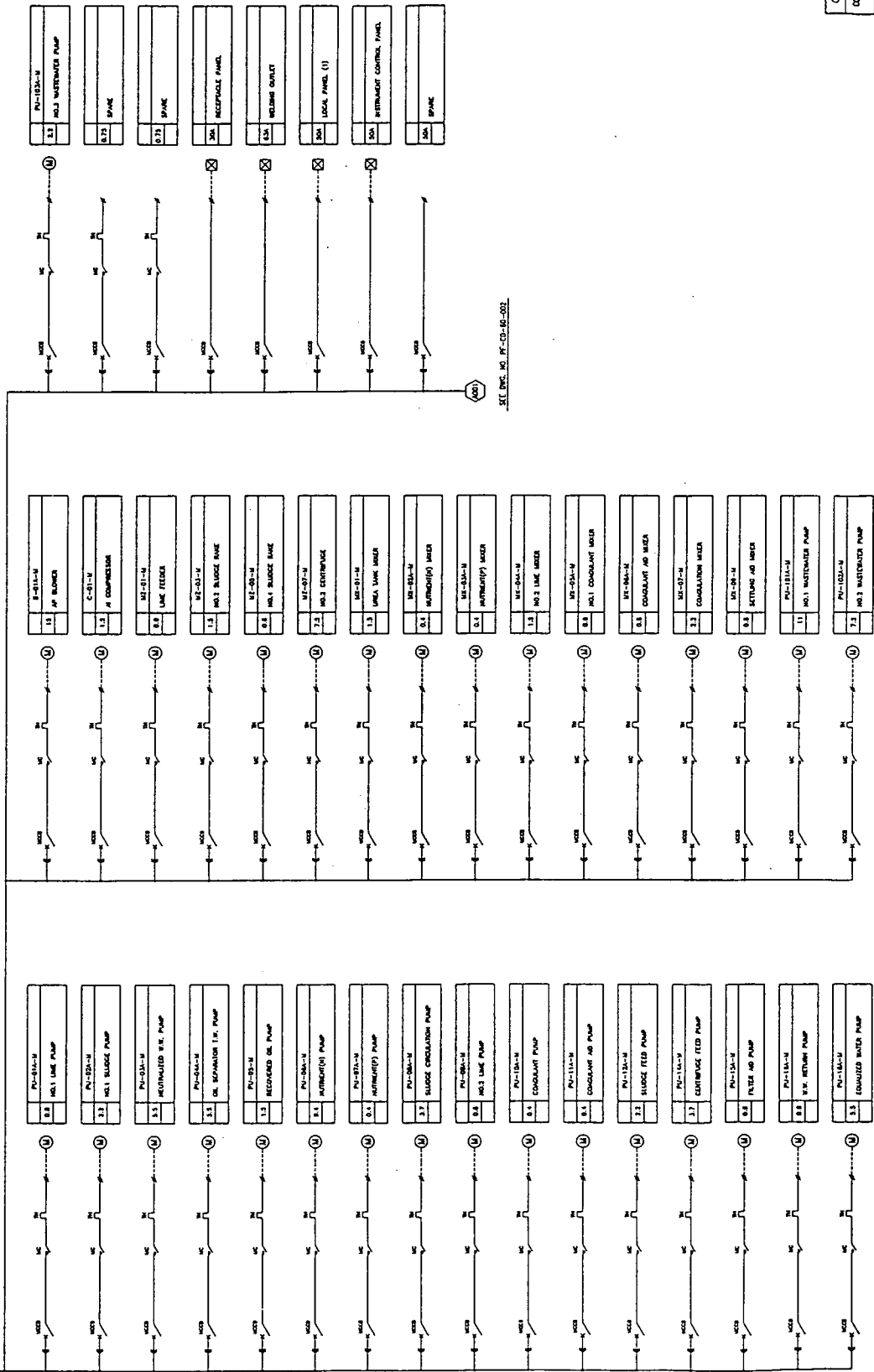

3.2	P-103-M	30KV WATER PUMP
6.7	SPARE	
6.75	SPARE	
3.6	RECEIPIBLE PANEL	
3.4	WELDING OUTLET	
3.6	LOCAL PANEL (1)	
3.6	SYSTEM CONTROL PANEL	
3.6	SPARE	

SEE DWS. NO. PF-CD-40-001

1.5	P-101-M	30KV WATER PUMP
1.5	P-102-M	30KV WATER PUMP
6.8	LINE FEEDER	
1.5	30KV SLUDGE BUNK	
6.8	30KV SLUDGE BUNK	
7.2	30KV CENTRIFUGE	
1.3	30KV LINE METER	
0.1	30KV METER	
0.1	30KV METER	
1.5	30KV LINE METER	
6.8	30KV METER	
6.8	30KV METER	
3.2	30KV METER	
6.8	30KV METER	
1.1	30KV WATER PUMP	
3.2	30KV WATER PUMP	

6.8	P-101-M	30KV WATER PUMP
3.2	P-102-M	30KV WATER PUMP
3.5	RECYCLED OIL PUMP	
3.5	30KV SEPARATOR T.R. PUMP	
1.3	RECYCLED OIL PUMP	
3.1	30KV METER	
0.1	30KV METER	
3.7	30KV CENTRIFUGE PUMP	
6.8	30KV LINE PUMP	
6.1	CONDENSATE PUMP	
6.1	CONDENSATE PUMP	
3.1	30KV METER	
3.7	30KV CENTRIFUGE PUMP	
6.8	30KV METER	
6.8	30KV METER	
3.1	30KV METER	

REV.	DATE	BY	CHKD.	APPD.

CLIENT	JAPAN INTERNATIONAL COOPERATION AGENCY CENTON DAGES AND MOORE CO. GENEVA SWITZERLAND
PROJECT	THE STUDY OF INDUSTRIAL WASTE WATER TREATMENT PLANT AT EL DOKKI, AIN HELWAN, EGYPT
TITLE	30KV MOTOR CONTROL BOARD (1/2)
SCALE	1:1
DATE	1971
NO.	3

SEE LINE NO. PF-CO-001
 IN THE 3RD SHEET

400

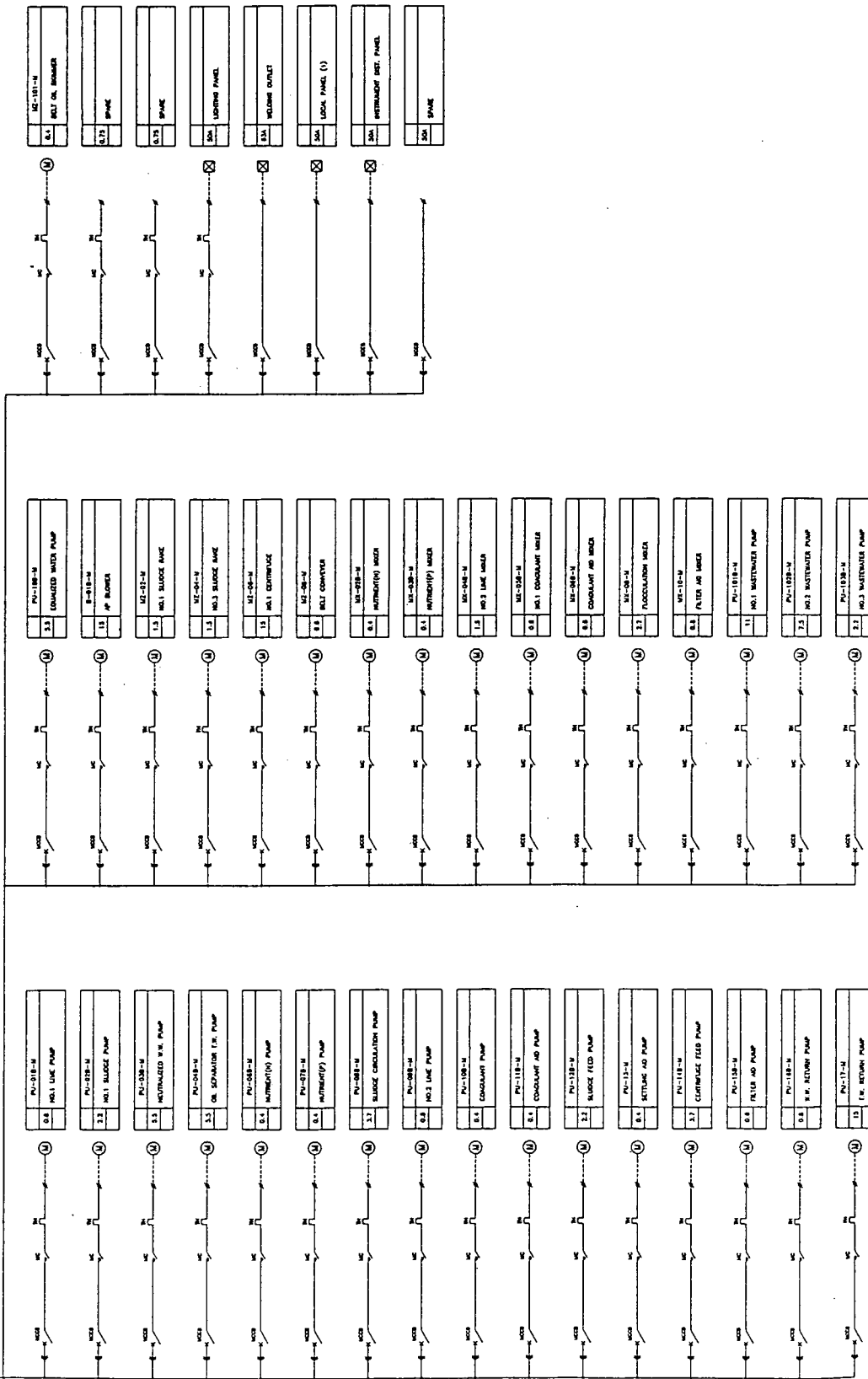

Client	JAPAN INTERNATIONAL COOPERATION AGENCY
Consultant	CHYODA DAIKES AND MOORE CO.
Project	THE STUDY ON INDUSTRIAL WASTE WATER POLLUTION CONTROL IN THE ARAB REPUBLIC OF EGYPT
Title	FOR O.M.A.S. CO. FOR STED. PETS & FITINGS NO.1 UNIT SINGLE LINE DIAGRAM 380V MOTOR CONTROL BOARD (2/2)
Issue Date	
Rev. No.	
Scale	
Sheet No.	PF-CO-001-002
Page No.	8

FROM EXISTING
SINGLELINE
ON 10 MAY 2002

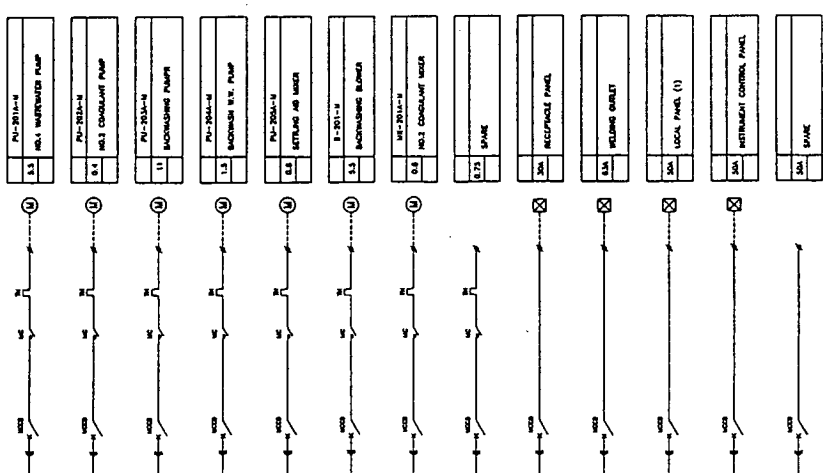
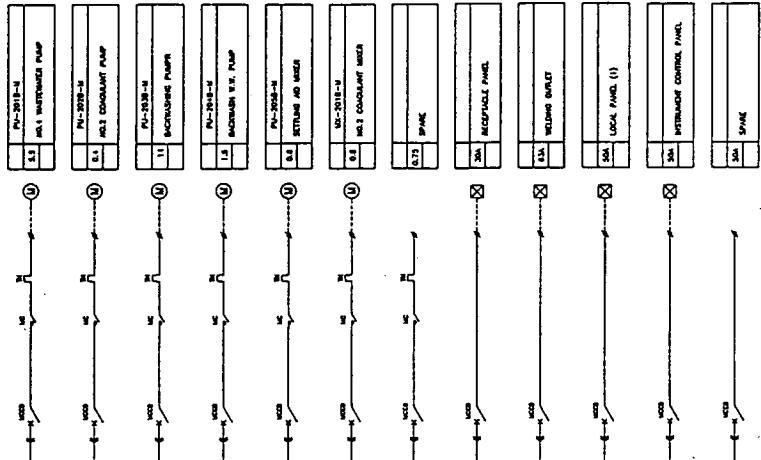

Rev No.	Description	Date	Drawn	Checked	Appr.	Scale

CLIENT	JAPAN INTERNATIONAL COOPERATION AGENCY
CONSULTANT	CHYUWA KAIKYO AND MOORE CO. CHYUWA JAPAN
PROJECT	THE STUDY ON INDUSTRIAL WASTE WATER POLLUTION CONTROL PLAN FOR THE ARAB REPUBLIC OF EGYPT
TITLE	200V MOTOR CONTROL BOARD
REVISION	100
SCALE	SCALE
REV.	REV.

ADJ.	CHK.	DES.	APP.

CONFIGURATION OF ELECTRICAL & INSTRUMENTATION SYSTEM FOR DEMONSTRATION PLANT

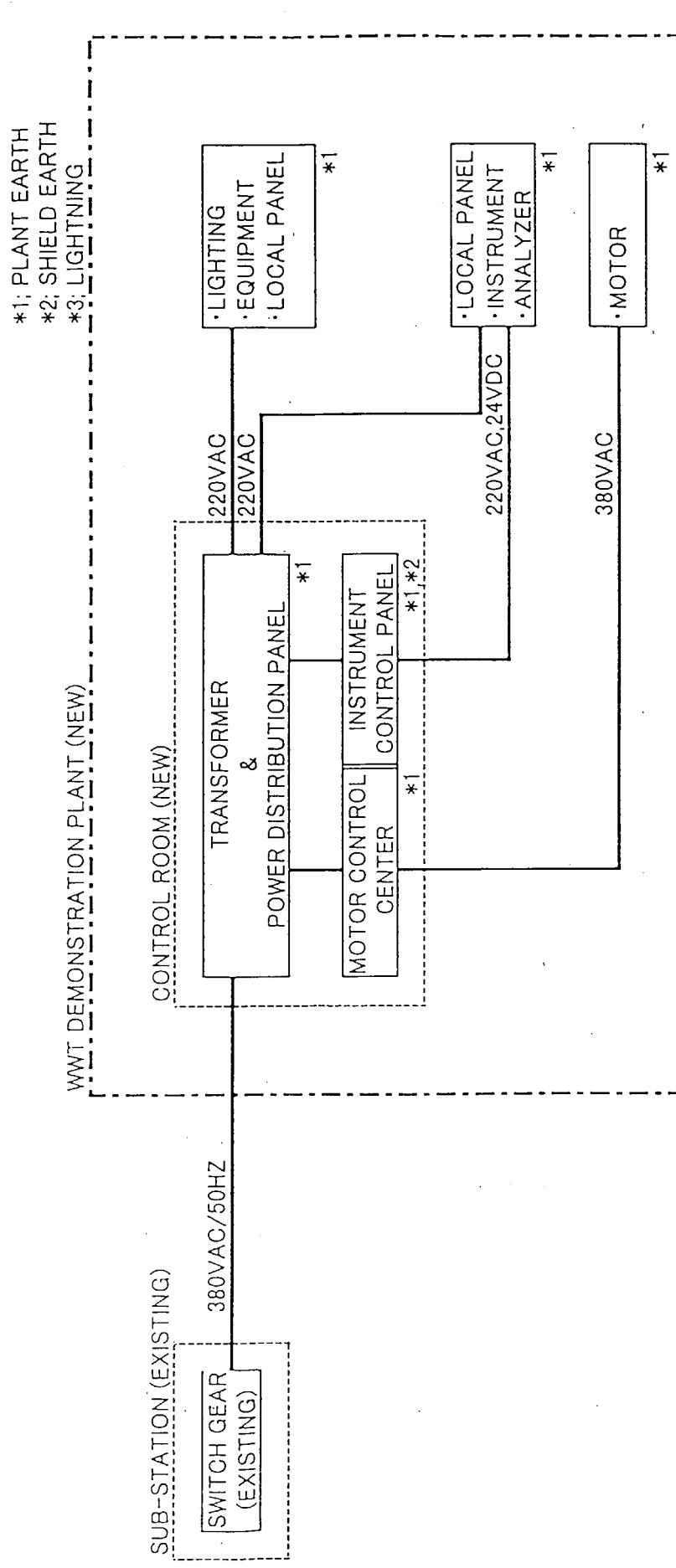

- *1: PLANT EARTH
- *2: SHIELD EARTH
- *3: LIGHTNING

*3

EQUIPMENT LIST for El Nasr Co. for Steel Pipes & Fittings

Doc. No. SP-BD-L-01-(1/6)

CLIENT : Japan International Cooperation Agency
 PROJECT : The Study on Ind. W. W. Pollution Control
 PLANT : W. W. T. Recommendation Plant
 WASTE W. : Industrial Wastewater/Sanitary W.

REV	1	2	3	MADE	
BY				CKD	
APVE				APVE	
DATE				DATE	

Equipment NO.	Service	No. Req'd	Type of Equipment	Remarks
T-01	Neutralization Tank	1	Rectangular 2.6mWx5.2mLx3.0mH	Carbon Steel/Resin Lining
T-02	No.1 Sedimentation Tank	1	Circular 5.8mIDx3.0mH	Carbon Steel/Resin Lining
T-03	Neutralized W.W. Tank	1	Rectangular 2.5mWx3.2mLx3.0mH	Carbon Steel/Resin Lining
T-04	Skimmed Oil Tank	1	Cone Roof Tank 3.4mIDx6.1mH	Carbon Steel
T-05	Equalization Tank	1	Open Top Tank 8.7mIDx7.6mH	Carbon Steel/Epoxy Coating
T-06	No.2 Sedimentation Tank	1	Circular 9.67mIDx4.0mH	Carbon Steel/Epoxy Coating
T-07	Coagulation/Flocculation Tank	1	Rectangular 1.4mWx2.8mLx6.1mH	Carbon Steel/Epoxy Coating
T-08	No.3 Sedimentation Tank	1	Circular 5.8mIDx4.5mH	Carbon Steel/Epoxy Coating
T-09	Sludge Thickener	1	Circular 3.2mIDx3.0mH	Carbon Steel/Epoxy Coating
D-01	Lime Hopper	1	Cylindrical, Vrtical 1.3mIDx1.5mH	Carbon Steel
D-02	No.1 Lime Drum	1	Cylindrical, Vertical 1.5mIDx1.5mH	Carbon Steel
D-03	Lime Receiver	1	Cylindrical, Horizontal 1.4mIDx1.5mH	Carbon Steel
D-04A/B	Nutrient(N) Drum	2	Cylindrical, Vertical 0.7mIDx1.5mH	Carbon Steel
D-05A/B	Nutrient(P) Drum	2	Cylindrical, Vertical 0.7mIDx1.5mH	C. S + H. R. Lining
D-06A/B	No.2 Lime Drum	2	Cylindrical, Vertical 1.4mIDx1.8mH	Carbon Steel
D-07A/B	No.1 Coagulant Drum	2	Cylindrical, Vertical 1.2mIDx1.8mH	C. S. +H. R. Lining

NOTE:

EQUIPMENT LIST for El Nasr Co. for Steel Pipes & Fittings

Doc. No. SP-BD-L-01-(2/6)

CLIENT : Japan International Cooperation Agency

PROJECT : The Study on Ind. W. W. Pollution Control

PLANT : W. W. T. Recommendation Plant

WASTE W. : Industrial Wastewater/Sanitary W.

REV	1	2	3	MADE	
BY				CKD	
APVE				APVE	
DATE				DATE	

Equipment NO.	Service	No. Req'd	Type of Equipment	Remarks
D-08A/B	Coagulant Aid Drum	2	Cylindrical, Vertical 1.2mIDx1.5mH	Carbon Steel
D-09	Settling Aid Drum	1	Cylindrical, Vertical 0.7mIDx1.0mH	Carbon Steel
D-10	Filtered Aid Drum	1	Cylindrical, Vertical 1.2mIDx1.5mH	Carbon Steel
D-201A/B	NO. 2 Coagulant Drum	2	Cylindrical, Vertical 1.2mIDx1.5mH	C. S. +H. R. Lining
Z-101	No. 1 Wastewater Pit	1	Open Basin/Underground 4.0mWx5.0mLx3.5mH	R. C. (out of Battery)
Z-102	No. 2 Wastewater Pit	1	Open Basin/Underground 3.0mWx5.0mLx3.0mH	R. C. (out of Battery)
Z-103	No. 3 Wastewater Pit	1	Open Basin/Underground 2.0mWx3.0mLx3.5mH	R. C. (out of Battery)
Z-01	Oil Separator	1	API Standard/underground 1.5mWx1.0mDx8.0mL	R. C.
Z-02	Oil Separator T. W. Pit	1	Open Basin/Underground 2.4mWx2.5mLx3.0mD	R. C.
Z-03	Skimmed Oil Pit	1	Closed Basin/Underground 1.5mWx2.0mLx3.0mD	R. C.
Z-04	Aeration Basin	1	Rectangular/Aboveground 5.0mWx15.0mLx3.5mH	R. C. with Air Bubbling
Z-05	Sludge Pit	1	Rectangular/Underground 2.0mWx3.0mLx3.0mD	R. C.
Z-06	Treated Water Pit	1	Rectangular/Aboveground 3.0mWx5.2mLx2.5mH	R. C.
Z-07	Wastewater Pit	1	Rectangular/Underground 3.0mWx6.0mLx3.0mH	R. C.
Z-201	No. 4 Wastewater Pit	1	Open Basin/Underground 1.5mWx3.0mLx3.5mH	R. C.
Z-202	Filtered Water Pit	1	Rectangular/Aboveground 3.0mWx5.0mLx3.0mH	R. C.

NOTE:

EQUIPMENT LIST for El Nasr Co. for Steel Pipes & Fittings

Doc. No. SP-BD-L-01-(3/6)

CLIENT : Japan International Cooperation Agency

PROJECT : The Study on Ind. W. W. Pollution Control

PLANT : W. W. T. Recommendation Plant

WASTE W. : Industrial Wasterwater/Sanitary W.

REV	1	2	3	MADE	
BY				CKD	
APVE				APVE	
DATE				DATE	

Equipment NO.	Service	No. Req'd	Type of Equipment	Remarks
Z-203	Backwash W.W. Pit	1	Rectangular/Underground 3.0mWx5.0mLx3.0mH	R. C.
PU-101A/B	No. 1 Wastewater Pump	2	Centri. Vertical , L=3.5m 48m ³ /hx30mHx11kW	SCS Outside of Battery
PU-102A/B	NO. 2 Wastewater Pump	2	Centri. Vertical , L=3m 36m ³ /hx25mHx7.5kW	SCS Outside of Battery
PU-103A/B	NO. 4 Wastewater Pump	2	Centri. Vertical , L=3m 12m ³ /hx25mHx2.2kW	SCS Outside of Battery
PU-01A/B	No. 1 Lime Pump	2	Centri. Horizontal 10L/minx0.5MPax0.75kW	CI
PU-02A/B	No. 1 Sludge Pump	2	Centri. Horizontal 4m ³ /hx30mHx2.2kW	SCS
PU-03A/B	Neutralized W. W. Pump	2	Centri. Horizontal 48m ³ /hx18mHx5.5kW	SCS
PU-04A/B	Oil Separator T. W. Pump	2	Centri. Vertical 36m ³ /hx18mHx5.5kW	SCS
PU-05	Recovered Oil Pump	1	Centri. Vertical 15m ³ /hx15mHx2.2kW	CI
PU-06A/B	Nutrient(N) Pump	2	Recipro. Plunger 0.1L/minx0.5MPax0.4kW	SCS
PU-07A/B	Nutrient(P) Pump	2	Recipro. Plunger 0.1L/minx0.5MPax0.4kW	SCS
PU-08A/B	Sludge Circulation Pump	2	Centri. Horizontal 36m ³ /hx12mHx3.7kW	SCS
PU-09A/B	No. 2 Lime Pump	2	Recipro. Diaphragm 0.6L/minx0.5MPax0.75kW	Teflon/SCS
PU-10A/B	Coagulant Pump	2	Recipro. Plunger 0.3L/minx0.5MPax0.4kW	SCS
PU-11A/B	Coagulant Aid Pump	2	Recipro. Plunger 0.3L/minx0.5MPax0.4kW	SCS
PU-12A/B	Sludge Feed Pump	2	Centri. Vertical 2m ³ /hx15mHx2.2kW	SCS

NOTE:

EQUIPMENT LIST for El Nasr Co. for Steel Pipes & Fittings

Doc. No. SP-BD-L-01-(4/6)
 CLIENT : Japan International Cooperation Agency
 PROJECT : The Study on Ind. W. W. Pollution Control
 PLANT : W. W. T. Recommendation Plant
 WASTE W. : Industrial Wastewater/Sanitary W.

REV	1	2	3	MADE	
BY				CKD	
APVE				APVE	
DATE				DATE	

Equipment NO.	Service	No. Req'd	Type of Equipment	Remarks
PU-13	Settling Aid Pump	1	Recipro. Plunger 0.1L/minx0.5MPax0.4kW	SCS
PU-14A/B	Centrifuge Feed Pump	2	Centri. Horizontal 1.5m ³ /hx15mHx3.7kW	SCS
PU-15A/B	Filter Aid Pump	2	Recipro. Plunger 3L/minx0.5MPax0.75kW	SCS
PU-16A/B	W. W. Return Pump	2	Centri. Vertical 5m ³ /hx15mHx0.75kW	SCS
PU-17	T. W. Reuse Pump	1	Centri. Horizontal 60m ³ /hx30mHx15kW	SCS
PU-18A/B	Equalized Water Pump	2	Centri. Horizontal 80m ³ /hx10mHx5.5kW	SCS
PU-201A/B	No. 4 Wastewater Pump	2	Centri. Vertical, L=3m 60m ³ /hx12mHx5.5kW	CI Coating Factory
PU-202A/B	No. 2 Coagulant Pump	2	Recipro. 0.5L/min. x0.5MPax0.4kW	SCS Coating Factory
PU-203A/B	Backwashing Pump	2	Centri. Horizontal 155m ³ /hx12mHx11kW	CI Coating Factory
PU-204A/B	Backwash W. W. Feed Pump	2	Centri. Horizontal 5m ³ /hx40mHx1.5kW	CI Coating Factory
PU-205	Recovered Water Pump	1	Centri. Horizontal, L=3m 60m ³ /hx30mHx11kW	CI Coating Factory
B-01A/B	AP Blower	2	Root 9.5Nm ³ /minx7mHx15kW	CI
B-201	Backwashing Blower	2	Root 3.0Nm ³ /minx5mHx5.5kW	CI
C-01	AI Compressor	2	Baby Compressor 0.3m ³ /minx0.7MPax1.5kW	CI, with Air Tank
MZ-101	Belt Oil Skimmer	1	Vertical 0.4kWx0.7MPax0.75kW	SUS
MZ-01	Lime Feeder	1	Disc 30kg/hx0.75kW	CS

NOTE:

EQUIPMENT LIST for El Nasr Co. for Steel Pipes & Fittings

Doc. No. SP-BD-L-01-(5/6)

CLIENT :Japan International Cooperation Agency

PROJECT :The Study on Ind. W. W. Pollution Control

PLANT :W. W. T. Recommendation Plant

WASTE W. : Industrial Wasterwater/Sanitary W.

REV	1	2	3	MADE	
BY				CKD	
APVE				APVE	
DATE				DATE	

Equipment NO.	Service	No. Req'd	Type of Equipment	Remarks
MZ-02	No.1 Sludge Rake	1	Center Driven 1.5kW	CS+Epoxy Coating
MZ-03	No.2 Sludge Rake	1	Center Driven 1.5kW	CS+Epoxy Coating
MZ-04	No.3 Sludge Rake	1	Center Driven 1.5kW	CS+Epoxy Coating
MZ-05	No.4 Sludge Rake	1	Center Driven 0.75kW	CS+Epoxy Coating
MZ-06	No.1 Centrifuge	1	Horizontal 3m ³ /hx15kWx3,000rpm	SCS
MZ-07	No.2 Centrifuge	1	Horizontal 1.5m ³ /hx7.5kWx3,000rpm	SCS
MZ-08	Belt Conveyer	1	Horizontal 20kg/minx0.75kW	CS+Rubber
MX-01	No.1 Lime Mixer	1	Vertical 1.5kW, L=1.2m	SUS
MX-02A/B	Nutrient(N) Mixer	2	Vertical 0.4kW, L=1.0m	SUS
MX-03A/B	Nutrient(P) Mixer	2	Vertical 0.4kW, L=1.0m	SUS
MX-04A/B	No.2 Lime Mixer	2	Vertical 1.5kW, L=1.2m	SUS
MX-05A/B	No.1 Coagulant Mixer	2	Vertical 0.75kW, L=1.2m	SUS
MX-06A/B	Coagulant Aid Mixer	2	Vertical 0.75kW, L=1.0m	SUS
MX-07	Coagulation Mixer	1	Vertical 2.2kW, L=1.5m	SUS
MX-08	Flocculation Mixer	1	Vertical 2.2kW, L=1.5m	SUS
MX-09	Settling Aid Mixer	1	Vertical 0.75kW, L=0.8m	SUS

NOTE:

INSTRUMENT LIST for EL. NASR Co. for STEEL PIPES and FITTINGS

Doc. No. SP-BD-L2-(1/4)

CLIENT : Japan International Cooperation Agency

PROJECT : The Study on Industrial W. W. Pollution Control

PLANT : W. W. T. DEMONSTRATION PLANT

WASTE W. : Process Water & Sanitary/Domestic Water

REV	1	2	3	MADE	
BY				CHKD	
APVE				APVE	
DATE				DATE	

Instrument NO.	Service	No. Req'd	Type of Instrument	Remarks
AR-01	pH Analyzer	1	Electrode, inline	Inlet of T-01
			pH 1-10	C. P.
AR-02	pH Analyzer	1	Electrode	Surface T-01
			pH 1-10	C. P.
AR-03	pH Analyzer	1	Electrode	Outlet T-02
			pH 1-10	C. P.
AR-04	DO Analyzer	1	Electrode	Z-04
			0-15mg/L as O ₂	C. P.
AR-05	pH Analyzer	1	Electrode	Outlet T-07
			pH 4-9	C. P.
FR-01	Flow Recorder	1	Orifice, 4B	Outlet of PU-04
			0-60m ³ /h, WW	C. P.
FR-02	Flow Recorder	1	Orifice, 3B	Outlet of PU-05
			0-45m ³ /h, WW	C. P.
FR-03	Flow Recorder	1	Orifice, 1-1/2B	Outlet of PU-204
			0-5m ³ /h, WW	C. P.
FIC-04	Flow Controller	1	Electro-magnetic, 6B	Outlet of PU-08
			0-60m ³ /h, WS	C. P.
FIC-05	Flow Controller	1	Orifice, 3B	Inlet of Z-04
			0-10Nm ³ /min, AP	C. P.
FRC-06	Flow Recorder/Controller	1	Orifice, 6B	Inlet of T-07
			0-90m ³ /h, WW	C. P.
FRC-07	Flow Recorder/Controller	1	Electro-magnetic, 2B	Outlet of PU-12
			0-5m ³ /h, WS	C. P.
FRS-08	Flow Integrated Indicator	1	Orifice, 6B	Outlet of PU-17
			0-90m ³ /h, WW	C. P.
			0-1,000,000m ³ /c	

NOTE: C. P. = Center Panel Mount

INSTRUMENT LIST for EL. NASR Co. for STEEL PIPES and FITTINGS

Doc. No. SP-BD-L2-(2/4)
 CLIENT : Japan International Cooperation Agency
 PROJECT : The Study on Industrial W. W. Pollution Control
 PLANT : W. W. T. DEMONSTRATION PLANT
 WASTE W. : Process Water & Sanitary/Domestic Water

REV	1	2	3	MADE	
BY				CHKD	
APVE				APVE	
DATE				DATE	

Instrument NO.	Service	No. Req'd	Type of Instrument	Remarks
FI-09	Flow Indicator	1	Orifice, 4B 5m ³ /h, WS	Inlet of MZ-061 Center Panel Mount
FI-10	Flow Indicator	1	Electro-magnetic, 2B 5m ³ /h, WS	Inlet of MZ-07 C.P.
FIC-51	Flow Controller	1	Orifice, 1B 3m ³ /h, WI	Inlet of D-02
FRC-52	Flow Controller	1	Electro-magnetic, 2B 1m ³ /h, 10% Lime	Inlet of T-01
FI-53	Flow Indicator	1	Orifice, 1-1/2B 5Nm ³ /min, AP	Inlet of T-01
FI-54	Flow Indicator	1	Orifice, 1-1/2B 10N/min, AP	Inlet of T-05
FS-55	Flow Integrator	1	Rotor Type for WD supply 2B,	Intake of WD
FI-56	Flow Indicator	1	Orifice, 4B 10N/min, AP	Outlet of B-01
FI-151	Flow Indicator	1	Orifice, 4B 60m ³ /h, WW	Outlet of PU-101
FI-152	Flow Indicator	1	Orifice, 3B 45m ³ /h, WW	Outlet of PU-102
FI-201	Flow Indicator	1	Orifice, 4B 90m ³ /h, WW	Outlet of PU-201 L.P.
FIS-202	Flow Integrator	1	Orifice, WW 90m ³ /h, WW	Outlet of PU-205 L.P.
FI-251A-C	Flow Inficator	3	Orifice, WW 50m ³ /h, 3B	Inlet of F-201ABC
FI-252	Flow Indicator	1	Orifice, WW 180m ³ /h, 8B	Outlet of PU-203
FI-253	Flow Indicator	1	Orifice, WW 5m ³ /h, WS	Outlet of PU-204

NOTE: C.P.=Center Panel Mount
 L.P.=Local Panel Mount

INSTRUMENT LIST for EL. NASR Co. for STEEL PIPES and FITTINGS

Doc. No. SP-BD-L2-(3/4)
 CLIENT : Japan International Cooperation Agency
 PROJECT : The Study on Industrial W. W. Pollution Control
 PLANT : W. W. T. DEMONSTRATION PLANT
 WASTE W. : Process Water & Sanitary/Domestic Water

REV	1	2	3	MADE	
BY				CHKD	
APVE				APVE	
DATE				DATE	

Instrument NO.	Service	No. Req'd	Type of Instrument	Remarks
LA-01	Level Alarm	1	Float	T-03
			H-L	C. P.
LA-02	Level Alarm	1	Float	Z-02
			H-L	C. P.
LIA-03	Level Indicator/Alarm	1	Displacer	T-04
			H-Alarm	C. P.
LIA-04	Level Indicator/Alarm	1	Displacer	T-05
			H-Alarm	C. P.
LIA-05	Level Indicator/Alarm	1	Displacer	Z-05
			H-L Alarm	C. P.
LICA-201	Level Controller/Alarm	1	Float	Z-201
			H-L Alarm	L. P.
LA-202	Level Alarm	1	Float	Z-202
			L-Alarm	L. P.
LA-203ABC	Level Alarm	3	Electrode	F-201ABC
			H-Alarm	L. P.
LI-51	Level Indicator	1	Lime Pouder	D-01
LS-52	Level Switch	1	Lime 10% Milk	D-02
LS-53	Level Switch	1	Lime Pouder	D-03
LS-54	Level Switch	1	Float, WW, H-L	T-03
LS-55	Level Switch	1	Float, WW, H-L	Z-02
LS-56	Level Switch	1	Float, WW, H-L	Z-03
LS-57	Level Switch	1	Float, WW, H-L	Z-05
LS-58	Level Switch	1	Float, WW, H-L	Z-06
LS-59	Level Switch	1	Float, WW, H-L	Z-07
LS-151	Level Switch	1	Float, WW, H-L	Z-101
LS-152	Level Switch	1	Float, WW, H-L	Z-102
LS-251	Level Switch	1	Float, WW, H-L	Z-203

NOTE: C. P. =Center Panel Mount
 L. P. =Local Panel Mount

INSTRUMENT LIST for EL. NASR Co. for STEEL PIPES and FITTINGS

Doc. No. SP-BD-L2-(4/4)

CLIENT : Japan International Cooperation Agency

PROJECT : The Study on Industrial W. W. Pollution Control

PLANT : W. W. T. DEMONSTRATION PLANT

WASTE W. : Process Water & Sanitary/Domestic Water

REV	1	2	3	MADE	
BY				CHKD	
APVE				APVE	
DATE				DATE	

Instrument NO.	Service	No. Req'd	Type of Instrument	Remarks
LG-51	Level Gage	1	Tubular, L=1.5m	D-03
LG-52AB	Level Gage	2	Tubular, L=1.5m	D-04AB
LG-53AB	Level Gage	2	Tubular, L=1.5m	D-05AB
LG-54AB	Level Gage	2	Tubular, L=1.8m	D-06AB
LG-55AB	Level Gage	2	Tubular, L=1.8m	D-07AB
LG-56AB	Level Gage	2	Tubular, L=1.8m	D-08AB
LG-57	Level Gage	1	Tubular, L=1.0m	D-09
LG-58	Level Gage	1	Tubular, L=1.5m	D-10
LG-251AB	Level Gage	2	Tubular, L=1.5m	D-201AB
TQA-1	Torque Alarm	1	Limit Switch, kg-m	T-02
TQA-2	Torque Alarm	1	Limit Switch, kg-m	T-06
TQA-3	Torque Alarm	1	Limit Switch, kg-m	T-08
TQA-4	Torque Alarm	1	Limit Switch, kg-m	T-09
TQA-5	Torque Alarm	1	Limit Switch, kg-m	MZ-06
TQA-6	Torque Alarm	1	Limit Switch, kg-m	MZ-07
PI	For Lime milk and Sludge Pumps		Diaphragm Type	
PI	Others		Buldon Tube Type	

NOTE: C. P. =Center Panel Mount
L. P. =Local Panel Mount

Overall Schedule for Implementation of Demonstration Plant (Preliminary)

Dec. 11, 1998

Phase 1 Study

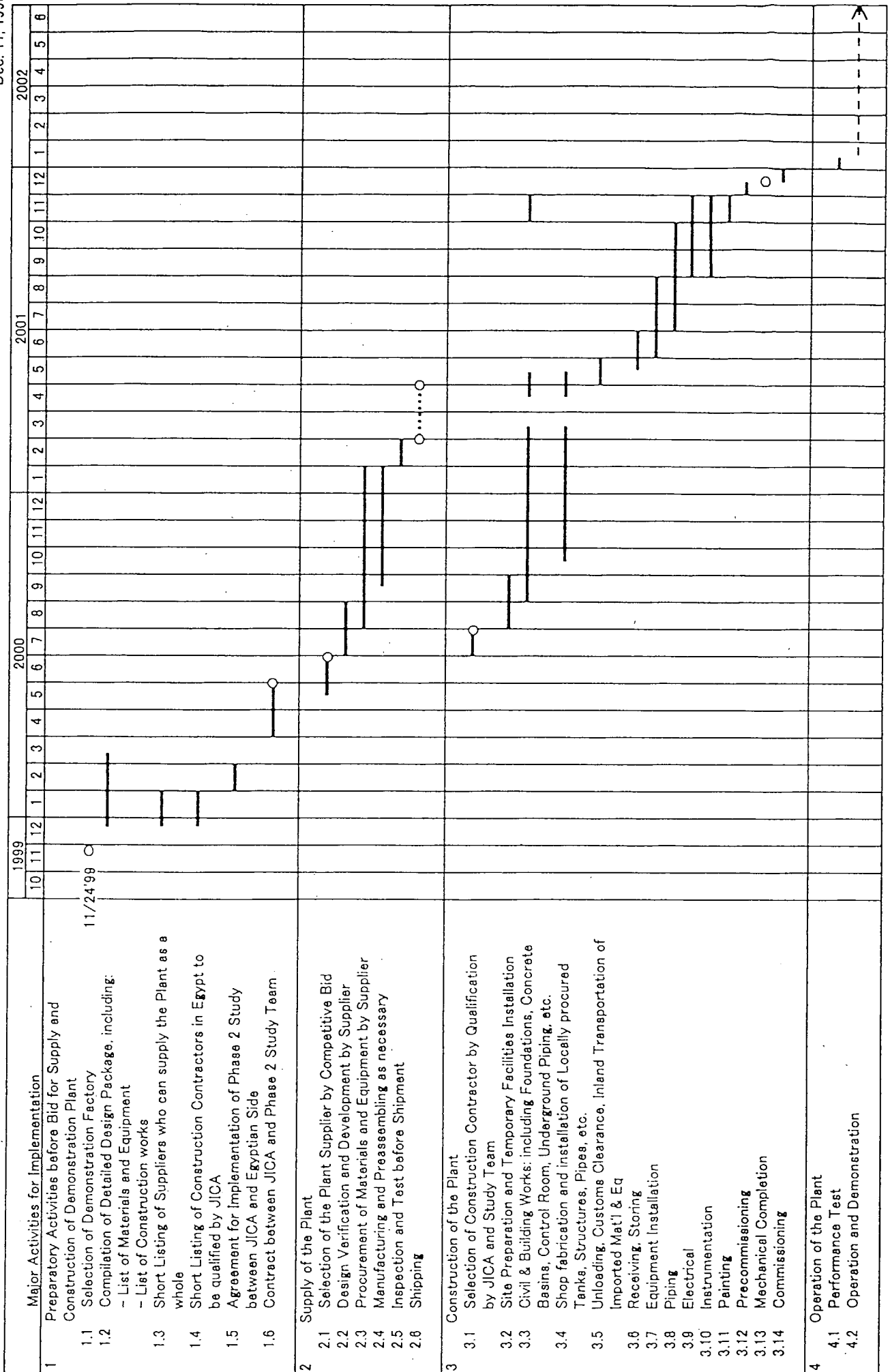

ESTIMATION COST FOR EL NASR CO. for STEEL PIPES FITTINGS

		Yen Portion [¥1000]	LE Portion [LE]	Total
1	Direct Cost			
	1.1. Equipment & Materials			
	(1)Machinery	98,100		
	(2)Piping Materials	10,500		
	(3)Electrical Equipment & Materials	26,000		
	(4)Instrument & Materials	34,000		
	(5)Mini. Labo. Analyzer & Others	4,700		
	1. 1 Sub-total	173,300	0	
	1.2. Field Work Cost			
	(1) Steel Tank & Drum		967,000	
	(2) Equipment Installation		142,000	
	(3) Piping		842,000	
	(4) Civil Work (Foundation, Pit, Pave)		1,494,000	
	(5) Building, Shelter, Steel Structure		541,000	
	(6) Lining, Coating, Painting		537,000	
	(7) Electrical, Instrumentation		498,000	
	(8) Commissioning/ Test		50,000	
	1. 2 Sub-Toatal	0	5,071,000	
2	Indirect Cost			
	(1) Export Packing, Ocean Transport	18,100		
	(2) Import Duty, Inland Transport*1		1,407,353	
	(3) Temporary Facilities*2		304,260	
	(4) Sub-contractor Expense*3		1,267,750	
	(5) Insurance, Social Tax*4		369,354	
	(6) Supervisor Expense	10,000		
	2. Sub-Total	28,100	3,348,717	
3	(1 + 2) Total	201,400	8,419,717	
	(1 + 2) Total [¥1000]	201,400	286,270	487,670
	[LE]	5,923,529	8,419,717	14,343,246

Note: Above cost includes outside battery except utilities supply.

*1: $\{(1.1\text{Sub-total}) + 2(1)\} \times 25\%$

*2: $(1.2) \times 6\%$

*3: $(1.2) \times 25\%$

*4: $\{[(1.1)+(1.2)]+[2(1)+2(2)+2(3)+2(4)]\} \times 2.7\%$

Unit Cost for Estimation of W.W.T. Demonstration Plant (Reference)

Factory Name: El Nasr Co. for Steel Pipes and Fittings.

Design Case: Basic Design

1. Major Equipment

<u>Equipment Name</u>	<u>Unit Cost [x10³Yen]</u>	<u>Note</u>
(1) Acid water pumps	1,500	Material: SCS
(2) Filter	3,000	3 sets
(3) Sludge Rake	6,000	1 set
(4) Centrifuge	10,000	1 sets
(5) Motor Control Center	16,500	
(7) Center Control Panel	3,000	1 set

2. Field Work

<u>Work Item</u>	<u>unit</u>	<u>unit Cost[LE]</u>	<u>Note</u>
(1) Site Preparation	[m ²]	8	
(2) Civil (Earth Work)	[m ³]	34	
(3) RC Work	[m ³]	1,500	Foundation, Water Basin
(3) Storage Tank	[ton]	3,430	Equalization Tank, Chemical tank Neutralization Tanks
(4) Structural Steel	[ton]	2,000	Pipe rack, Operating Stage
(5) Equipment Installation	[ton]	400	Pumps, Clarifier rakes, Dehydrator
(6) Piping	[ton]	3,970	Except valves
	[in-m]	30	Except valves
(7) Painting	[m ²]	50	
(8) Local Building	[m ²]	2,600	W.W.T Control Room
(9) Electrical	[cable-m]	3	

Running Cost-EL NASR CO. FOR STEEL PIPES & FITTINGS

Items	Treating Capacity (m ³ /h)	Feeding Ratio (mg/L)	Consump. (kg/h)	Unit Cost (LE/kg)	Cost-1 (LE/h)	Cost-2 (LE/day)	Cost-3 (LE/year)	Unit Cost (LE/m ³)	Remarks
1 Chemical Cost									
1) Alum =Al ₂ (SO ₄) ₂ · 18H ₂ O (Clarifier)	77	30	2.31	0.3	0.69	17	5,489		
* 2) Lime = Ca(OH) ₂ (Neutralization)	30	1000	30	0.1	3.00	72	23,760		
3) Polymer-A (Clarifier)	77	0.3	0.02	27	0.62	15	4,940		
4) Polymer-A (Thickener)	2.34	100	0.23	27	6.32	152	50,039		
5) Polymer-B (No.1 Centrifuge)	60	1%	0.6	27	16.20	130	42,768		
Polymer-B (No.2 Centrifuge)	75	1%	0.75	28	21.00	168	55,440		
5) CO(NH ₂) ₂	77	110	8.47	0.6	5.08	122	40,249		
* 6) H ₃ PO ₄	77	30	2.31	0.6	1.39	33	10,977		
7) NaOCl	77	4	2.31	0.385	0.89	21	7,044		
Sub-Total	77	—	—	—	55.19	729	240,705	0.717	
2 Filter Media									
* 1) Anthracite (3 Sets)	Loading 10.5 m ³	Loss 20 %/year	Loss/h 2.1	1	2.10	50	16,632	0.027	
* 2) Sand (3 Sets)	4.2 m ³	10 %/year	0.5	0.3	0.15	4	1,188	0.005	
* 3) Activated Carbon (1 Set)	0 m ³	14 days	0.0	14.7	0.00	0	0	0	
Sub-Total	—	—	—	—	2.25	54	17,820	0.029	
3 Power Consumption									
			kWh/d	LE/kWh					
			2,120	0.12	10.60	254.40	83,952	0.138	
			m ³ /day	m ³					
4 Industrial Water or Potable Water									
			50	0.7	1.46	35.00	11,550	0.019	
			Person/d	LE/P/year					
5 Operator	4 Person*3 Shift+1s		16	10,000	20.20	484.85	160,000	0.262	
6 Maintenance Fee									
(Plant Cost * 3 %/year)					44.56	1069.52	352,940	0.579	
400,000,000*0.03/34=352,940 LE									
Total Operation Cost	—	—	—	—	134.27	2,627.17	866,967	1.74	

* Unit cost is not fixed yet

Power Consumption

Tag No.	kW	Operation	Consump.
PU-01	0.75	24	18.00
PU-02	2.2	24	52.80
PU-03	5.5	24	132.00
PU-04	5.5	24	132.00
PU-05	2.2	2	4.40
PU-06	0.4	24	9.60
PU-07	0.4	24	9.60
PU-08	3.7	24	88.80
PU-09	0.75	24	18.00
PU-10	0.4	24	9.60
PU-11	0.4	24	9.60
PU-12	2.2	24	52.80
PU-13	0.4	24	9.60
PU-14	3.7	8	29.60
PU-15	0.75	8	6.00
PU-16	0.75	24	18.00
PU-17	15	24	360.00
PU-18	5.5	12	66.00
PU-101	11	24	264.00
PU-102	7.5	24	180.00
PU-103	2.2	24	52.80
PU-201	5.5	24	132.00
PU-202	0.4	24	9.60
PU-203	11	1	11.00
PU-204	1.5	24	36.00
B-01	15	24	360.00
B-201	5.5	1	5.50
C-01	0.75	12	9.00
MZ-01	0.75	24	18.00
MZ-02	1.5	24	36.00
MZ-03	1.5	24	36.00
MZ-04	1.5	24	36.00
MZ-05	0.75	24	18.00
MZ-06	15	9	135.00
MZ-07	7.5	7	52.50

MZ-08	0.75	9	6.75
MZ-101	0.75	24	18.00
MX-01	1.5	24	36.00
MX-02	0.4	2	0.80
MX-03	0.4	2	0.80
MX-04	1.5	24	36.00
MX-05	0.75	2	1.50
MX-06	0.75	2	1.50
MX-07	2.2	24	52.80
MX-08	2.2	24	52.80
MX-09	0.75	2	1.50
MX-10	0.75	8	6.00
MX-201	0.75	24	18.00
Total	--	--	2,650.25 kWh/d
Actual Consumption		0.8	2120.2 kWh/d

Client: JAPAN INTERNATIONAL COOPERATION AGENCY (JICA)
Project Name: THE STUDY ON INDUSTRIAL WASTE WATER POLLUTION CONTROL
IN THE ARAB REPUBLIC OF EGYPT

Factory Name: EL NASR CO. FOR STEEL PIPES AND FITTINGS

BASIC DESIGN

Document Title:

STUDY REPORT

FOR

W.W.T. RECOMMENDABLE PLANT

Issued Date

September 2000

Consultant:

JICA STUDY TEAM

CHIYODA DAMES AND MOORE CO.

CHIYODA CORPORATION

1. Purpose

The Study Report aims to explain about the important design concepts that studied through the basic design of Waste Water Treatment (W.W.T.) Recommendable Plant in El Nasr Co. for Steel Pipes and Fittings (hereinafter NSP) that is developed and revised the conceptual design submitted in November 1999.

2. Demonstration Plant and Recommendable Plant

2.1 Demonstration Plant

(1) Selection of the Companies

- The basic design is proceeded to 3 Companies including El Nasr Co. for Steel Pipes and Fittings (NSP) nominated as Demonstration Plant on 5th October 1999 meeting.
- The Factories are selected based on the following criteria (M/M on June 2, 1999):
 - (a) Factories that are in need of improvement in their anti-pollution measures;
 - (b) Factories that are typical so that the recommended wastewater treatment systems can be expected to be diffused to other factories in Egypt;
 - (c) Factories that are interested in designing or upgrading the wastewater management;
 - (d) Factories that are financially able (either self-financing or from other financial resources) to adopt the recommendations on the appropriate waste water treatment system;
 - (e) Factories which similar projects by other donors are not under way.
- One factory that is satisfactory to the stipulated conditions will be selected as Demonstration Plant Factory by JICA and Egyptian Side.

(2) Waste Water Treatment Systems

The appropriate industrial waste water treatment systems ("the Systems") for Demonstration Plant may include in-process systems and the Systems will be prepared based on the following conditions:

- The Systems are of adequate technical level so that they will be to be adopted and spread widely in the Arab Republic of Egypt;
- The waste water treatment plants, constructed on the basis of the Systems, will be easily maintained locally and be operated at a low cost;
- The Systems will not necessarily treat whole waste water discharged from the factories.

2.2 Recommendable Plant

The conceptual design of the Demonstration Plant submitted on November 1999, Egyptian side suggested to JICA Study Team as follows;

- (1) All wastewater generated in the Company (Factories Complex) should be treated.
 - The demonstration plant has been designed to treat a part of wastewater in the Factories (approx. 40%).
- (2) The target of treated water should be applied to the realistic wastewater discharge regulation in Egyptian Law.
 - In the conceptual design, the target of treated water of the demonstration plant has been the most stringent discharge regulation (Law 48/82 Underground Reservoir & Nile Branches/Canals).

But, NSP is applied to Law 93/62 Discharge to Sewer System at present.

The Team agreed basically with the Egyptian comments. As a result, in the basic design of the System, the recommendable plant for wastewater treatment (W.W.T.) is prepared instead of the Demonstration Plant for NPS Factory considering the above comments. But, the target of treated water is adopted Law 48/82 Non Potable Surface Water (Industrial) considering enforcement of regulation in future.

3. Basic Design

The basic design was proceeded based on the conceptual design and 2nd supplemental wastewater survey result, then modified based on the following comments by the Egyptian Side:

- (1) The W.W.T plant should be designed so as to treat all wastewaters from NSP Factory.
- (2) The target of treated water quality should not be applied to Law 48/82 regulation, because the treated water of NSP Factory is discharged to the public sewer.

But, in the basic design, Law 48/82 Non Potable Surface Water (Industrial) is applied considering to enforce the more stringent regulation in the future.

The following design drawings and documents were prepared:

- 1) Process Flow Diagram (PFD)
- 2) Engineering Flow Diagram (EFD)
- 3) Layout
- 4) Skeleton Drawings of Major Equipment
- 5) Single Line Diagram for Motor Control Board

- 6) Equipment List, Instrument List, Motor List
- 7) Plant Construction Cost, Running Cost

4. Existing Wastewater System

The existing wastewater sewer system of NSP Factory is shown on the attached drawing-1.

- (1) NSP Factory locates at two areas both side of the public road.
Wastewaters in the main factory are discharged to the public sewer A and B.
- (2) Wastewaters in another factory (Spiral welded pipes, Coating factory) are discharged to the public sewer C, in which the wastewater of Military Factory flows from upstream.

5. Design Conditions

5.1 Wastewater to be treated

· The following wastewaters were selected and studied as the wastewater to be treated by Demonstration Plant in the Factory:

- (1) RW-1: Outlet of Sedimentation Pit A
(Neutralized wastewater and Sanitary/Domestic wastewater from Long Welded Pipes Factory)
 - (2) RW-2: Skimmed Oily Water from Cooling Water Oil Separator
- And the following wastewaters are added for the recommendable plant design:
- (3) RW-4: Outlet of Sedimentation Pit B
(Wastewater from Foundry Factory including sanitary /domestic wastewater)
 - (4) RW-4: Outlet of Collection Pit
(Wastewater from Spiral long welded pipes Factory and Coating Factory)

5.2 Flow rate and Qualities of Wastewater

Wastewater flow rate and qualities are shown on the following Table-1:

Table 1 Flow rate and Water Qualities

	RW-1	RW-2	RW-3	RW-4
FlowRate Max [m ³ /h]	50	40	10	150
Av. [m ³ /h]	40	30	5	50
pH [-]	2 - 7	7 - 8	6.5 - 8	6.5 - 8
BOD [mg/L]	100	100	30	30
COD [mg/L]	200	200	80	80
SS [mg/L]	250	200	30	30
Oil &Grease [mg/L]	5	1000	5	5
TDS [mg/L]	5800	400	390	390
Water Temp [°C]	25 - 35	25 - 35	25 - 30	25 - 35

[Discussion]

- (1) The wastewater to be treated by the Demonstration Plant is selected RW-1 (Outlet of Neutralization Unit) and RW-2 (Skimmed oily Water of Oil Separator), because pH of RW-1 and Oil & Grease of RW-2 do not meet the regulation.
- (2) RW-3 and RW-4 will be treated by the Recommendable Plant to improve the disposed wastewater qualities to the Public Sewer.

5.2 Target of Treated Water

Table 2 Target of Treated Water Qualities

	Target	Law 93/62 Discharge to Sewer System		Law 48/82 Non Potable Surface Water(Industrial)
		as modified by Decree 9/89	as modified by Decree 44/2000	
pH [-]	6.5 – 8.5	6 - 10	6 – 9.5	6 - 9
BOD [mg/L]	30	< 400	600	< 60
COD [mg/L]	50	< 700	1100	< 100
SS [mg/L]	30	< 500	800	60
Oil & Grease [mg/L]	1	< 100	100	10
TDS [mg/L]	-----	2000		2000
Zinc [mg/L]	0.1	< 10		n/a
Water Temp [°C]	35	< 40	43	35

Note. n/a= not applicable

[Discussion]

- (1) The wastewater from NSP is discharged to the Public Sewer. The regulation of wastewater to the public sewer is too mild, water quality items over the regulation may be [pH] [Oil & Grease] .
- (2) But, the recommendable plant will be applied to the regulation disposal to non-potable canal/drainage considering to be strengthened the regulation.

6. System Design

6.1 Treating System

The following two treating systems are recommended;

- (1) Main Wastewater Treating System (No.1 W.W.T.)

No.1 W.W.T. will be installed in the main Factory.

- (2) No.2 Wastewater Treating System (No.2 W.W.T.)

No.2 W.W.T will be installed in the Coating Factory separately, because

- 1) Wastewater from Spiral Welded Pipe Factory and Coating Factory (RW-4) is discharged to Sewer C. But, Sewer C is contaminated wastewater from Military Factory on the way to the End of Pipe at the main Factory.
- 2) Before contamination, Wastewater (RW-4) will be treated in the Coating Factory.
- 3) Treated water will be disposed to the Public Sewer through the Sewer C, and only backwashed wastewater will be sent to No.1 W.W.T.

· Main Factories

RW-1, RW-3

RW-2

· Spiral W.P. Factory
Coating Factory

(Military Factory)

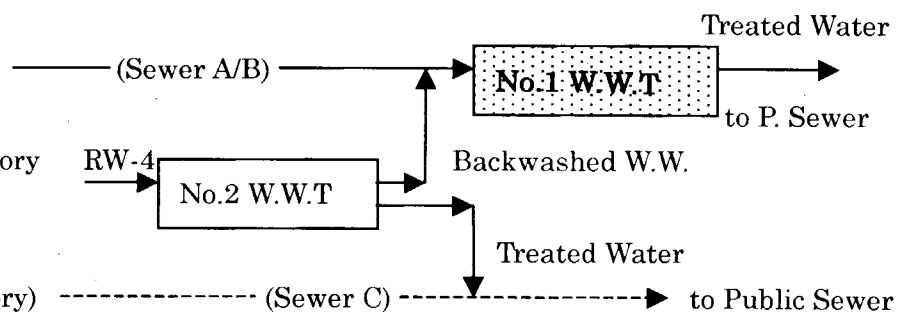

Fig.-1 Wastewater Flow Scheme

6.3 Collection of Wastewater

- (1) RW-1

No.1 Wastewater Pit with 2 sets of pumps is provided beside Sedimentation Pit of Sewer A.

- (2) RW-2

No.2 Wastewater Pit with 2 sets of pumps is provided beside the existing Oil Separator.

In this case, it is recommended to install a belt oil skimmer in the pit to remove floating /accumulating oil in the pit.

But, it may be possible to feed to the new Oil Separator in No.1 W.W.T. directly using the outlet height of the existing oil separator.

(3) RW-3

No.4 Wastewater Pit with 2 sets of pumps is provided beside Sedimentation Pit of Sewer B.

(4) RW-4

No.4 Wastewater Pit is provided beside the Collection Pit in the corner of Coating Factory. It may be possible to use the existing collection pit instead of No.4 Wastewater Pit.

6.3 Treating Unit

Wastewater treatment system consists of the following treating units;

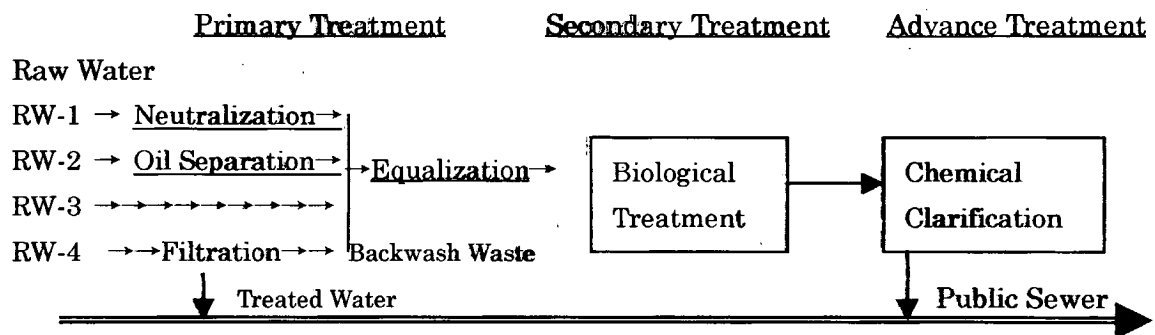

Fig.-2 Wastewater Treating System Flow

(1) Primary treatment

(1-1) Neutralization Unit for RW-1

1) Purpose

The existing Neutralization Unit is old and operated manually, so that it is not always operated under adequate condition.

- (a) Neutralization = pH control (pH 7~8)
- (b) Removal of dissolved Fe = less than 0.1mg/L
- (c) Removal of Zn = Less than 0.1mg/L

Therefore additional New Neutralization Unit is provided as primary treatment in No.1 W.W.T.

2) Specification, Design Base

- (a) The neutralization unit consists of Neutralization Tank, No.1 Sedimentation Tank, Neutralized W.W. Tank and Lime injection unit.
- (b) These tanks are made of carbon steel with resin lining. Carbon steel is easier to fabricate at shop and field, and more inexpensive than other materials such as stainless steel, reinforced concrete, FRP and titan. etc.
- (c) The volume of neutralization tank is 30-minute retention time of average

- flow rate to neutralize wastewater completely.
- (d) Air from a blower is blown to the bottom of neutralization tank to accelerate neutralization and oxidation.
 - (e) Lime $\text{Ca}(\text{OH})_2$ is used as an alkali agent that is used at the existing neutralization plant. Lime is more effective as alkali, inexpensive and safer to handle than other alkali agents such as caustic soda (NaOH), sodium carbonate (Na_2CO_3), caustic lime (CaO), etc.
 - (f) lime injection unit consists of Lime Drums with mixers and chemical pumps.

(1-2) Oil Separator for RW-2

1) Purpose

- (a) In general, skimmed oil in an oil separator is recovered and reused. But the skimmed oily water in the existing Oil Separator is disposed to the Public Sewer directly. That is not only to load to the Public Sewage Treatment Plant but also to lose much valuable oil. So that, a gravity type of oil separator is provided as primary treatment in No.1 W.W.T.
- (b) Skimmed oily water from the oil separator is separated oil and wastewater in a tank by gravity.
- (c) Floated oil is recovered and may be reused as fuel or renewal oil.

2) Specification, Design Base

- (a) Oil separator is designed based on the API (American Petroleum Institute) manual. That more simple, inexpensive, easier to operate than PPI (Parallel Plate Interceptor) and CPI (Corrugated Plate Interceptor).
- (b) The basin is made of reinforced concrete.
- (c) Diameter of oil globe to be removed: 150μ
Oil contents: approx. 30 mg/L (expected by experience)
- (d) A CRT (Cone Roof Tank) of carbon steel is provided to separate oil and water from skimmed oily water

(1-3) Sand Filter for RW-4

1) Purpose

- (a) RW-4 is not so polluted, therefore sand filter is applied to remove suspended solids in wastewater.
- (b) Coagulant (alum) is injected in the inlet of filters in order to increase clearness of filtered water and to backwash filter media easily.
- (c) Filtered water is disposed to the Sewer C, or may be reused in the Factories.
- (d) Backwashed wastewater is sent to No.1 W.W.T. via Backwashed Wastewater

Pit.

2) Specification, Design Base

- (a) Type: A gravity type of rapid sand filter
- (b) Shape: Vertical cylindrical
- (c) Materials: Carbon steel with epoxy coating
- (d) Filter Media:
 - Upper Layer: Anthracite (Dia. 1.2 – 1.5mm) x 0.7 – 1.0m thickness
 - Lower Layer: Sand (Dia. 0.5 – 0.7mm) x 0.4 – 0.6m thickness
- (e) Required No.: 3 sets (2 filters are running normally and one (1) is stand-by.)
- (f) Filtration Rate: $180 - 240 \text{ m}^3/\text{m}^2/\text{day} = 7.5 - 10 \text{ m}^3/\text{m}^2/\text{hour}$
Filter for wastewater is designed in general.
- (g) Filter (media) is backwashed by water and air automatically, periodically.
 - Operation Period: Filtration 18 – 24 hours/cycle
Backwashing 15 – 20min./cycle
 - Backwashing: Air Bubbling + Water

3) Backwashed Wastewater

Table-3 Flow rate and Quality of Backwashed Wastewater

	Influent to Filter RW-4	Backwashed W.W. RW-4'
Flow Rate [m ³ /h]	Max. 160 Ave. 50	2.0
pH [-]	6.5 - 8	6.5 - 8
SS [mg/L]	30	550
BOD [mg/L]	30	186
COD [mg/L]	80	496
Oil & Grease [mg/L]	5	83

(1-4) Equalization Tank for RWs

1) Purpose

- (a) Pre-treated water of RW-1, RW-2, and RW-3, filter backwashed wastewater of RW-4 are fed to Equalization Tank with an air bubbling device. But, these wastewaters are not continuous flow, not constant water qualities.
- (b) To treat wastewaters satisfactorily, stably, wastewaters are stored in the Equalization Tank and equalized in quality and quantity using air bubbling.

2) Specification, Design Base

- (a) Shape: Open top tank of circular and vertical type, installed above ground.
- (b) Materials: Carbon steel with resin lining on the inner surface.
- (c) Volume: equal to 4 – 6 hour-retention time of maximum flow rate in general.

(d) Attachment: Air bubbling devices (blower, air distributing pipes)

(2) Secondary Treatment: Activated Sludge Treatment

1) Purpose

- (a) As secondary treatment, biological treatment is applied to remove organic matters in the equalized wastewater.
- (b) In case of wastewater contained various metals, chemical clarifier is utilized before biological treatment, but it may not be necessary to provide it.
- (c) In the aeration basin, BOD, COD of wastewater are reduced by means of oxidizing and decomposing organic matters by micro aerobic bacteria.
- (d) Slurry consisting bacteria group is separated supernatant (treated water) and sludge at the sedimentation tank.

2) Specification, Design Base

(a) Biological treatment unit consists of Aeration Basin and Sedimentation Tank, Chemical injection devices as an auxiliary.

(b) Aeration basin:

- Shape: Rectangular, above ground
- Materials: Reinforced concrete with corrosion proof
- Operating Conditions in general:
 - Retention Time: 4–6 hours of average flow rate
 - Dissolved oxygen; 2 mg/L as O
 - Contents Ratio: BOD: N(nitrogen)as T-N: P(phosphorus)as T-P
= 100: 5: 1
- Oxygen supplies; air bubbling device by a blower
- Nutrient injection devices; Chemical drums, mixers and pumps
 - Nutrient $\text{CO}(\text{NH}_2)_2$ as N
 - H_3PO_4 as P

(c) Sedimentation Tank:

- Shape: Circular, Vertical, above ground
- Materials: Carbon steel with epoxy coating
- Operating Conditions in general
 - Surface load: $24 \text{ m}^3/\text{m}^2/\text{day} = 1.0 \text{ m}^3/\text{m}^2/\text{hour}$
- Attachment: Steel structure bridge hanging a sludge collecting rake.

(d) The following water qualities are expected as treated water of activated sludge treatment;

- BOD 20 mg/L
- COD 30 mg/L
- SS 30 mg/L

3) Reason to select Activated Sludge Treatment

(a) High organic matters (BOD, COD) are contained in wastewater.

Therefore, it is required to remove these organic matters under the discharge regulation (Law 48/82)

(b) In order to remove organic matters, biological treatment (aerobic, anaerobic), activated carbon adsorption are applicable. Aerobic biological treatment may be most effective considering concentration of BOD, COD and economic point of view.

(c) As aerobic biological treatment, there are various type of activated sludge treatment, fixed sludge treatment, trickling filter and oxidation ditch.

(d) In this basic design, the activated sludge treatment is applied considering to be most basic, standard, applicable widely and inexpensive.

(e) Fixed sludge treatment is used generally for industrial wastewater treatment recently.

But, it does not use because that structure, packing media and design conditions of fixed sludge treating plants are deferent based on know-how of each maker.

(3) Advantage Treatment: Chemical Clarifier

1) Purpose

(a) Chemical Clarifier is provided to remove suspended solids (carry-over) in the treated water of the Biological Treating Unit as advantage treatment.

(b) Treated water is discharged to the public sewer. And sludge from the bottom of sedimentation tank is sent to the sludge treating unit.

(c) But, it is not always necessary to provide it as long as the biological-treating unit is operated satisfactorily.

2) Specification, Design Base

(a) Chemical clarifier unit consists of coagulation and flocculation tank, clarifier and chemical injection device as auxiliary.

(b) Coagulation, flocculation tank

- Shape: Circular, vertical, above ground
- Materials: Carbon steel with epoxy coating
- Volume: 30 min.-retention time of average flow rate

It is required for floc formation and floc growth acceleration completely.

- Attachment: Vertical mixer and flocculator

(c) Clarifier

- Shape: Circular, vertical, above ground
- Materials: Carbon steel with epoxy coating

- Surface Load: $3 \text{ m}^3/\text{m}^2/\text{h}$ (as experimental value)
 - Attachment: Steel structural bridge hanging a sludge collecting rake
- (d) Chemical Injection Unit
- The following chemicals are used as coagulant:

Coagulant	Alum= $\text{Al}_2(\text{SO}_4)_3 \cdot 18\text{H}_2\text{O}$
Coagulation Aid	Polymer (Cation or Anion)
 - The unit consists of chemical drums with mixers and reciprocating pumps.
- (e) SS contents in treated water is expected less than 20 mg/L.

(4) Sludge Treatment

1) Purpose

- (a) Sludge is generated from the following treating units;
- Neutralization Unit: No.1 Sedimentation Tank bottom
 - Biological Treating Unit: No.2 Sedimentation Tank bottom
 - Chemical Clarifier: No.3 Sedimentation Tank bottom
- (b) Solids content in sludge is approx. 0.5 ~ 2.0% that is almost all water. Therefore, sludge is thickened in the Thickener, and then dehydrated by centrifuges.
- (c) The sludge cake should be disposed to the specified landfill under management. Supernatant of thickener and filtrate of centrifuge are sent back to the equalization tank to re-treat.

2) Specification, Design Base

- (a) The sludge treating unit consists of a sludge thickener, centrifuges and chemical injection unit.
- (b) Sludge Thickener:
- Shape: Open top tank, circular and vertical type, above ground
 - Materials: Carbon steel with epoxy coating on the inner surface
 - Surface load: $12 \text{ m}^3/\text{m}^2/\text{day} = 0.5 \text{ m}^3/\text{m}^2/\text{hour}$ (as experimental value)
 - Expected SS contents: 2 – 5 %
- (d) Dehydrator
- Type: Horizontal, screw decanter type of centrifuge
 - Materials: Stainless steel
 - Expected SS content of Sludge Cake: 15 – 20 % (85 – 80% of water content)
 - Centrifuges are installed in a shelter.
- (d) Chemical Injection Unit
- Polymer (Cation or Anion) is used for coagulant aid for dehydration.
 - The unit consists of chemical drums with mixers and reciprocating pumps.

(5) Electrical, Instrumental Design

1) Electrical Design

- (a) Primary power cables (380V-AC x 3 phase x 50 HZ) will be laid between the switch gear at the existing electric substation and a receiving/distributing board, transformer at the new electric substation in the W.W.T. control room.
- (b) Secondary power cables (380V-AC) will be laid between MCC (Motor Control Center) at the new substation in the W.W.T. control room and each motors of equipment.
- (c) Lighting cables (220V-AC) will be laid between a transformer, distribution board and each lighting implements.
- (d) Earthwork is required for steel equipment, piping and structure adequately.
- (e) NSP is requested to design and construct primary power supplying work between the existing substation and the receiving board at the new substation in the W.W.T. control room.

2) Instrumental Design

- (a) The center instrument panel will be installed at the W.W.T. control room. Indicators, recorders, alarms and sequence timers, etc. will be mounted on the board, and W.W.T. system will be designed so as to operated automatically by the control panel.
- (b) Control cables (220V-AC, 24V-DC) will be laid between a transformer, center panel and each instruments at field.
- (c) Electric implements and instruments should be applied to tropical and dust proof type.
- (d) Control valves will be operated pneumatically by compressed air.

6. Technical Provision for Basic Design

6.1 Location of Plant

- (1) Major equipment of wastewater treatment plant shall be installed outdoors.
- (2) Arrangement of equipment, piping and instrumentation shall be determined in consideration of easy operation and of a sufficient access for maintenance.
- (3) The area of wastewater treatment plant shall be classified as a non-hazardous area.

6.2 Special Requirement

- (1) The plants shall be designed so as to operate for 330 days a year continuously.
- (2) The plants shall be operated automatically by the control panel in the control room.

(3) The control room shall be built in the W.W.T. area, and it shall consist of a control panel room, MCC (motor control center) room, mini-laboratory, toilet, locker room, warehouse, etc.

But, a control room for No.2 W.W.T. are not provided assuming that the existing buildings can be utilized.

(4) One spare pump shall be provided for each continuous running pump.

(5) Each chemical drum shall be designed to be seven (7) days stock at normal operation basically.

7. Discussion

7.1 Disposal to Public Sewer

At present, whole wastewater from NSP is disposed to the Public Sewer; therefore Law 84/92 of disposal to public sewer is applied (Refer to Table 2).

Public Sewage Treatment Plant aims to treat sanitary/domestic wastewater from residential area mainly. In this point of view, industrial wastewater contaminated metals; mineral oil etc. is unfavorable to the Public Sewage Plant consisting of biological treatment.

Comparing to the disposal regulation, it may be not always necessary to provide the new wastewater treating plant unless pH control and oil removal is maintained completely by the existing treating units. But, it may be very difficult, so that it is recommended to provide the new neutralization unit and oil separator, as minimum.

Table 3 Regulation of Disposal to Public Sewer

	Law 93/62 (EGYPT)		Law of Sewage JAPAN
	as modified by Decree 9/89	as modified by Decree 44/2000	
pH [-]	6 - 10	6 - 9.5	5 - 9
BOD [mg/L]	< 400	600	< 300 / 600
COD [mg/L]	< 700	1100	None
SS [mg/L]	< 500	800	< 300 / 600
Oil & Grease [mg/L]	< 100	100	<5 mineral <30 animal & plants
Total N [mg/L]	<100 as NH ₃		< 240
Total P [mg/L]	< 30 as PO ₄	25	< 32
TDS [mg/L]	< 2,000		None
Water Temp. [°C]	< 400	43	< 45

Major differences between Egyptian Regulation and Japanese are as follows;

- (1) Japanese regulation does not specify COD and TDS.
- (2) Concerning to Oil & Grease, Japanese Regulation is more stringent than Egypt, because oil especially mineral oil is harmful to bacteria using in the biological-treating unit.

7.2 Total Dissolved Solids (TDS)

TDS is regulated in Wastewater Discharge Regulation in Egypt. Acid rinsing wastewater from Long Welded Pipes Factory in NSP contains high level of HCl. Therefore, wastewater after neutralized is very high contents of TDS, such as 3,000~6,000 mg/L.

Neutralized wastewater may be diluted by other wastewater, but it may not always meet the regulation of TDS.

The countermeasures of remove TDS are applied to desalination such as RO (reverse osmosis), ion exchange resin/membrane, evaporator, etc., that are not only economical in investment and running cost but also generation of condensed waste liquid as residue.

7.3 Save water consumption

In case of reuse treated water in the factories, it should be studied to be used satisfactorily in water qualities, especially TDS.

The most important countermeasure is always to save the consumption of city water in the Factory.

8. Performance Guarantee

The basic design of W.W.T. of NSP Factory is designed on our survey data during limited short period and given data by NSP. This basic design procedure may be useful for W.W.T. design.

But, it is recommended that the existing production plants including utility supply system should be improved in wastewater discharge points of view in addition to the existing W.W.T. As a result, if new W.W.T. will be designed and constructed by yourself after some improvements, it is required to verify and settle the design conditions based on supplemental wastewater survey, then the detail design should be proceeded to be satisfied of the specified performance of the plant.

This recommendable basic design is only for reference. Therefore, the Study Team can not guarantee the plant performance if anybody will construct the new plant based on this basic design package in the future.

Client: JAPAN INTERNATIONAL COOPERATION AGENCY (JICA)
Project Name: THE STUDY ON INDUSTRIAL WASTE WATER POLLUTION CONTROL
IN THE ARAB REPUBLIC OF EGYPT
Factory Name: EL NASR CO. FOR STEEL PIPES AND FITTINGS

BASIC DESIGN

Document Title: CALCULATION SHEET
FOR
W.W.T. RECOMMENDABLE PLANT

Issued Date September 2000

Consultant: JICA STUDY TEAM
CHIYODA DAMES AND MOORE CO.
CHIYODA CORPORATION

1. Object

This design calculation sheet is applied to the study of W.W.T. Recommendation Plant planning for [El Nasr Co. for Steel Pipes and Fittings] .

2. Wastewater to be treated

- (1) RW-1: [Neutralization Unit Outlet] + [Sanitary / Domestic of Foundry]
- (2) RW-2: Skimmed Oily Water of C.W. Oil Separator
- (3) RW-3: Wastewater in the Collection Pit from Foundry Factory
- (4) RW-4: Wastewater in the Collection Pit from Spiral Pipe / Coating Factories

3. Design Conditions

- (1) The existing facilities of wastewater sources should be maintained, repaired, as original or revised design basis.
- (2) Waste management system in the Factory should be organized, and operated adequately under the responsible managers.
- (3) Suitable routine works, periodical maintainances should be conducted in the whole company.
- (4) Quality and quantity of RW-3 are assumptivel data as same as RW-4, because there was no flow during water sampling.
- (5) Calculation result figures may be changed in the layout planning stage.

4. Contents of Wastewater Treating Facility

- (1) Pre-treatment : Neutralization Unit, Oil Separator, Equalization Tank
- (2) Primary Treatment: Chemical Clarifier, Sand Filter
- (3) Secondary Treatment: Activated Sludge Treatment

5. Design Basis

5.1 Quality and Quantity of Influent Wastewater: Shown on Table-1.

5.2 Quality and Quantity of Treated Water

The following regulations are applied to Basic Design.

- (1) Existing Plant: Law93/62 Discharge to Sewer System
- (2) Recommendation Plant: Law48/82 Non Potable Surface Water (Industrial)

Table-1 Design Basis of Wastewater Quality and Quantity

	Raw Water 1	Raw Water 2	Raw Water 4	Raw Water 3	Law48/82
Flow Rate Av. [m ³ /h]	40	30	50	5	
Flow Rate Max [m ³ /h]	50	40	150	10	
p H [-]	2 ~ 7	7 ~ 8	6.5 ~ 8	6.5 ~ 8	6 ~ 9
S S [mg/L]	250	200	30	30	60
B O D [mg/L]	100	100	30	30	60
C O D [mg/L]	200	200	80	80	100
Oil & Grease [mg/L]	5	1,000	5	5	10
T D S [mg/L]	5,800	400	390	390	2,000
Water Temp. [°C]	25 ~ 35	25 ~ 35	25 ~ 30	25 ~ 35	35

6. Unit Design

6.1. Wastewater Collection (Out of Battery)

6.1.1 No.1 Waste Water Pit

(1) Purpose

Raw water 1 is taken from the outlet of Sedimentation Pit and is stored to pump up to the new Neutralization Unit.

(2) Design Conditions

1) Wastewater: Outlet of the Sedimentation Pit

2) Flow Rate(Q) $40 \text{ m}^3/\text{h} = 0.67 \text{ m}^3/\text{min}$

3) Retention Time: 30 min.

4) Shape, Materials, No. : Rectangular, RC(Semi-Underground), 1 set

(3) Sizing

(3-1) No.1 Wastewater Pit (Z-101)

1) Req'd Vol. 20 m^3

2) Effective Height 1 m (take)

3) Cross Sectional Area $A_c = Q/Ah = 20 \text{ m}^2$

Take: $4,000^W \times 5,000^L \times 1,500^H$ *

* Actual height is based on the depth of buried pipe.

(3-2) No.1 Wastewater Pump (PU-101AB)

1) Capacity Allowance 20% Design Flow Rate $48 \text{ m}^3/\text{h}$

2) Required Total Head 15 m (take)

3) efficiency of pump 0.6

4) Motor Allowance 0.3

5) Motor Power $4.24 \text{ kW} \rightarrow 5.5 \text{ kW}$ PU-101AB=48m³/hx0.15MPax5.5kW

6.1.2 No.2 Waste Water Pit

(1) Purpose

Raw water 2 is taken from the outlet of Oil Separator and is stored to pump up to the new Oil Separator.

(2) Design Conditions

1) Wastewater: : Outlet pipe of the Oil Separator

2) Flow Rate(Q) $30 \text{ m}^3/\text{h} = 0.5 \text{ m}^3/\text{min}$

3) Retention Time: 30 min.

4) Shape, Materials, No. : Rectangular, RC(Semi-Underground), 1 set

(3) Sizing

(3-1) No.2 Wastewater Pit (Z-102)

1) Required Vol. $A_v = 15 \text{ m}^3$

2) Effective H of Pit $A_h = 1 \text{ m (take)}$

3) Cross Section Area $A_c = Q/Ah = 15 \text{ m}^2$

Take: $3,000^W \times 5,000^L \times 1,500^H$ *

* Actual height is based on the depth of buried pipe.

(3-2) No.2 Wastewater Pump (PU-102AB)

1) Capacity Allowance 20% Design Flow Rate $36 \text{ m}^3/\text{h}$

2) Required Total Head	15	m (take)	
3) efficiency of pump	0.6		
4) Motor Allowance	0.3		
5) Motor Power	3.18	kW →	3.7 kW

PU-102AB=36m³/hx0.15MPax3.7kW

6.2 Pre-treatment

6.2.1 Neutralization Unit

(1) Purpose

To neutralize Wastewater which is not neutralized by the existing Neutralization Unit completely.

(2) Design Conditions

1) Wastewater: Neutralization Unit Outlet and Sanitary/Domestic Wastewater from Foundry.

2) Flow Rate: Neutralization Unit	30	m ³ /h	0.5	m ³ /min
Sanitary/Domestic W.	10	m ³ /h	0.17	m ³ /min
Total	40	m ³ /h	0.67	m ³ /min

(3) Sizing

(3-1) Neutralization Tank (T-01)

1) Reaction Time	1	h
2) Reactor Vol.	40	m ³
3) Reactor effct. Height	3	m (take)
4) Reactor Area	13.33	m ²
5) Length =	2	width
		W= 2.58

Width x Length = 2.6m x 5.2m

T-01=2.6m x 5.2m x 3.5mH

(3-2) No.1 Sedimentation Tank (T-02)/No.1 Sludge Pump (PU-02)

1) Settling velocity	36	m ³ /m ² /d	1.5	m ³ /m ² /h
2) Tank Surface Area	26.67	m ²		
3) Diameter of Tank:	5.83	m →	5.8	m (Standard)
4) Retention Time	2	h (take)		
5) Tank Vol.	80	m ³		
6) Height(linear)	3.03	m →	3	m
7) Sludge/Treated Water	2.5	%	(based on settling test)	
8) Sludge generation rate	1	m ³ /h=	20	kg/h as SS content
				20 kg/m ³
9) Sludge Storage Height	1	m (take)		
10) Sludge Storage Vol.	28.26	m ³		
11) Sludge Retention Time	28.26	h		T-02=5.8mID x 3.0mH(linear)
12) Sludge Draw-off Period	8	hours/d		
13) Pump Capacity	3	m ³ /h		PU-02=4m ³ /hx20mHx

(3-3) Lime Feeder (MZ-01)/No.1 Lime Pump (PU-01AB)

1) Lime Requirement	1	g-Lime/L-W.W.		
	30	kg/h		
2) Lime Milk Conc.	5	% →	0.05	kg/L
				MZ-01= 30kg/h
3) Lime Milk Feed Rate	600	L/h →	10	L/min
				PU-01AB=10L/minx0.5MPax0.75kW

(3-4) Lime Hopper (D-01)

1) Required Lime

1 day
720 kg/d

2) Density

0.5 kg/L

3) Allowance

30%

4) Hopper Vol.

1872 L → 2,000 L

5) Hopper Height

1.5 m (take)

Hopper Cross Section Area

1.33 m²

Hopper Diameter

1.30 m → 1.3 m

D-01=1.3m^{I.D.} x 1.5m^H

(3-5) No.1 Lime Drum (D-02)

1) Lime Conc.

10% 100 kg/m³

2) Preparation Period

8 h

3) Required Lime

240 kg

4) Drum Vol.

2.4 m³

5) Drum Height (Take)

1.5 m

Diameter

1.43 m → 1.45 m

D-02=1.45m^{I.D.} x 1.5m^H

(3-6) Neutralized W.W. Tank (T-03)

1) Retention Time

30 min

2) Required Vol.

20 m³

3) Effective H of Pit

2.5 m (take)

4) Cross Section Area

Ac= Q/Ah= 8 m²

Take: 2.5m^W x 3.2m^L x 3.0m^H

(3-7) Neutralized W.W. Pump (PU-03AB)

1) Capacity=

48 m³/h, Head= 18 mH (take)

2) Motor Power=

5.09 kW → 5.5 kW PU-03=48m³/hx18mHx5.5kW

6.2.2 Oil Separator

(1) Object

To remove floatable oil from the skimmed oily water of existing Oil Separator

(2) Design Conditions

1) Wastewater: Wastewater from PU-02AB

2) Flow Rate: Qm 30 m³/h = 0.5 m³/min

3) Design Base: API Standard

4) Wastewater

(a) Water Temp. 30 °C

(b) Specific gravity of Water: Sw 0.995

(c) Absolute viscosity: μ 0.0076 poise

(e) Maximum allowable horizontal velocity : VH=15Vt, not exceed 3f/min.

5) Oil globules in wastewater

(a) Oil globules to be remove: 150 μ = 0.015 cm

(b) Specific gravity of Oil: So 0.9

(c) Rate of rise in wastewater: Vt 0.30 f/min = 0.09 m/min

(d) Maximum allowable VH: 4.52 f/min > 3f/min

2 f/min (take) 0.61 m/min

6) Design Factors

(a) For turbulence with: VH/Vt 6.64

(b) Turbulence and Short-circuit Factor: 1.43 (Fig. 5-3 of Manual)

(3) Sizing

(3-1) Oil Separator (Z-01)

1) Minimum Cross-section Area: $Ac=Qm/VH$

0.83 m²

2) Width:

1.2 m (take)

1.5 m

3) Depth (effct.):

0.69 m →

0.8 m

4) Length:

7.60 m →

8 m

API Separator: 1.5m^w x 0.8m^d x 8.0m^L (1channel)

(3-2) Oil Separator T.W. Pit (Z-02)

1) Retention Time

30 min

2) Required Vol.

15 m³

3) Effective H of Pit

2.5 m (take)

4) Cross Section Area

$Ac=Q/Ah=$ 6 m²

Take: 2.4m^w x 2.5m^L x 3.0m^H

(3-3) Skimmed Oil Pit (Z-03)

1) Design Conditions

Oil Contents in Wastewater 1 L/m³

Oil Contents in Skimmed Water 10%

2) Quantity of Skimmed Oily Wat

7.2 m³/d

3) Retention Time

1 day

4) Required Vol.

7.2 m³

5) Effective H of Pit

2.5 m (take)

6) Cross Section Area

$Ac=Q/Ah=$ 2.88 m²

Take: 1.5m^w x 2.0m^L x 3.0m^H

(3-4) Skimmed Oil Tank (T-04)

1) Retention Time

7 days

2) Required Vol.

50.4 m³

3) Height 6 m (take)

Required Area

8.4 m²

4) Diameter of Tank:

3.27 m →

3.4 m (Standard)

T-03=3.4m^D x 6.0m^H

(3-5) Oil Separator T.W. Pump (PU-4)

1) Capacity=

36 m³/h,

Head=

18 mH (take)

2) Motor Power=

3.81 kW →

5.5 kW

PU-04=36m³/hx18mHx5.5kW

(3-6) Recovered Oil Pump (PU-05)

1) Design Conditions

Working Hour= 1 h/day

1) Capacity=

7.2 m³/h →

10 m³/h

Head= 15 mH (take)

2) Motor Power=

1.06 kW →

1.5 kW

PU-05=10m³/hx15mHx1.5kW

6.3 Equakization Tank

(1) Object

To equalize quality and quantity of 2 wastewaters.

(2) Design Conditions

- 1) Quantity and Quality of Wastewater: Shown on Table-2
- 2) Shape: Open Top Tank, Materials: CS /Epoxy Coating , Required No.: 1 set
- 3) Retention Time: h
- 4) Others: Air bubbling device

Table-2 Quantity and Quality of Wastewater

	RW -1	RW -2	BackWash W.W.	RW -3	Equalized W.
Flow Rate [m ³ /h]	40	30	2	5	77
pH [-]	6 ~7.5	7 ~8	6.5 ~8	6.5 ~8	6.5 ~8
SS [mg/L]	250	200	550	30	224
BOD [mg/L]	100	100	186	30	98
COD [mg/L]	200	200	496	80	200
Oil&Grease [mg/L]	5	30	83	5	17

(3) Sizing

A. Equalization Tank

- 1) Required Vol.: m³
- 2) Height: H= m (take)
- 3) Section Area: A= m² D= m → m (Standard)
 Take: $8.71\text{m}^{\text{ID}} \times 7.6\text{m}^{\text{H}}$

B. Air Bubbling Device

- 1) Required Air (design base): Nm³/m²/h
- 2) Required Air Quantity: Nm³/h = Nm³/min (take)

6.4 Biological Treating Unit (Activated Sludge Treatment)

(1) Purpose

To remove Organic Substances (BOD, COD) by aerobic micro bacterias.

(2) Design Conditions

- 1) Wastewater: Equalized Wastewater
- 2) Treating Method: Activated Sludge Treatment
- 3) Capacity: m³/h
- 4) Water Quality:

Table-4 Water Quality

	Inlet	Outlet	Law93/62 Sewer System	Law48/82 Non Potable
p H [-]	6.5~8	6.5~8	6 ~10	6~9
S S [mg/L]	224	30	< 500	60
B O D [mg/L]	98	30	< 400	60
C O D [mg/L]	200	50	< 700	100
Oil & Grease [mg/L]	17	5	< 100	10
Water Temp. [°C]	20~35	20~35	< 40	35

5) Shape, Materials, Req'd No.

- (a) Aeration Basin: Rectangular/Above ground, RC, 1 set

(b) Sedimentation Basin: Circular/Above ground, CS+Epoxy coating, 1 set
 6) Chemicals

N and P are injected in case of lack of nutrient.

(3) Sizing

(3-1) Aeration Basin(Z-04)

- 1) BOD Loading $0.5 \text{ kg-BOD/m}^3/\text{day}$ (take)
- 2) Vol. of Basin $V_{as} = 250.18 \text{ m}^3$
- 3) Height of Basin $H_{as} = 3.5 \text{ m}$ (take) $A_{as} = 71.48 \text{ m}^2$
 $L = 3 \text{ m}$ (take) $W = 4.88 \text{ m} \rightarrow 5 \text{ m}$
 $L = 15 \text{ m}$

Take: $5.0 \text{ m}^W \times 15.0 \text{ m}^L \times 3.5 \text{ m}^H$

- 4) BOD Removal : $R_{BOD} = 125.09 \text{ kg/day}$
- 5) MLSS : $C_a = 2,000 \text{ mg/L}$

(3-2) No.2 Sedimentation Basin(T-06)

- 1) Surface Loading $L_{as} = 1 \text{ m}^3/\text{m}^2/\text{h}$ (take) = $24 \text{ m}^3/\text{m}^2/\text{day}$
- 2) Surface Area $A_{ss} = 77 \text{ m}^2$
- 3) Height of Basin $H_{ss} = 3 \text{ m}$ (take)
- 4) Vol. of Basin $V_{ss} = 231 \text{ m}^3$ $T_{ss} = 3 \text{ h}$
- 5) Diameter of Basin: $D_{ss} = 9.90 \text{ m} \rightarrow 10 \text{ m}$
 Take: $10 \text{ m}^D \times 4.0 \text{ m}^H$ $\text{Act. Surf. Loading} = 0.98 \text{ m}^3/\text{m}^2/\text{h}$

(3-3) Surplus Sludge

- 1) BOD \rightarrow SS Conversion Rate 0.4 (take)
- 2) Sludge from Act. Sludge T. $W_{ss} = 2.08 \text{ kg/h}$ from BOD
 $W_{ss} = 14.94 \text{ kg/h}$ from SS
 Total $W_{ss} = 17.02 \text{ kg/h}$
- SS content 8 kg/m^3 (take) $2.13 \text{ m}^3/\text{h} = 51.07 \text{ m}^3/\text{d}$

(3-4) Air Requirement for Aeration

- 1) Oxygen Demand: $W_{O_2} = a \cdot R_{BOD} + b \cdot S_a = 95.07 \text{ kg/day}$
 $a = \text{BOD Factor} = 0.55 \text{ kg-O}_2/\text{kg-O}_2$
 $b = \text{MLVSS Factor} = 0.07$
 $S_a = 0.75 \cdot \text{MLSS} \cdot \text{Vol. of Basin} / 1,000 = 375.26$
 $R_{BOD} = \text{BOD Removal} = 125.09 \text{ kg/day}$
- 2) Required Air : $Q_{air} = (W_{O_2} \cdot 3.57 \text{ m}^3/\text{kg-O}_2 \cdot 1.3) / (0.08 \cdot 24 \cdot 60)$
 $= 3.54 \text{ Nm}^3/\text{min} \rightarrow 3.6 \text{ Nm}^3/\text{min}$
 : Misceraneous Purpose $1 \text{ Nm}^3/\text{min}$
- 3) Blower(B-01) $Q_{ta} = 9.12 \text{ Nm}^3/\text{min}$
 Take: $9.5 \text{ Nm}^3/\text{min} \times 7 \text{ mH} \times 15 \text{ kW}$

(3-5) Sludge Circulation Pump(PU-08)

- 1) Return Sludge Ratio $R_s = C_a / (C_r - C_a) = 33.33 \%$
- 2) Pump Capacity $33.4 \text{ m}^3/\text{h}$ $\text{PU-08} = 36 \text{ m}^3/\text{h} \times 12 \text{ mH} \times 3.7 \text{ kW}$

(3-6) Nutrient as N $\text{CO}(\text{NH}_2)_2$ Injection Unit

- 1) Dosage : BOD : N = 100 : 5
 : BOD : $\text{CO}(\text{NH}_2)_2 = 100 : 11$

- 2) Concentration : 12.5 wt %
 3) Specific gravity: 1.069
 4) Injection rate : $Q_{CO} = 4.3$ L/h (PU-06)
 5) Storage Vol. : $V_{CO} = 0.7$ m³ (7days)
 6) Dimension : Take: 0.9m^{1D} x 1.2m^H (D-04)
- (3-7) Nutrient as P H₃PO₄ Injection Unit
- 1) Dosage : BOD : P = 100 : 1
 : BOD : H₃PO₄ = 100 : 3
 2) Conc. : 12.5 wt %
 3) Specific gravity: 1.189
 4) Injection rate : $Q_{ph} = 1.1$ L/h (PU-07)
 5) Storage Vol. : $V_{ph} = 0.2$ m³ (7days)
 6) Dimension : Take: 0.9m^{1D} x 1.2m^H (D-05)

6.4 Chemical Clarifier

(1) Purpose

To remove Suspended Solids(SS), slice of oil and color. Clarifier is not necessary, because A.S.Treated Water meets to the Regulation.

(2) Design Conditions

- 1) Wastewater: W.W. after equalized in T-04.
 2) Capacity: 77 m³/h
 3) Water Quality of Inlet and outlet of Clarifier: Shown on Table-3.
 4) Chemicals: (a) Coagulant= Al₂(SO₄)₃
 (b) pH Controller=Ca(OH)₂
 (c) Coagulant Aid=Polymer

Table-3 Water Quality

	A. S T. Water	Out let of Clarifier	Law93/62 Sewer System	Law48/82 Non Potable
Flow Rate [m ³ /h]	77	77		
pH [-]	6.5 ~8	7 ~8	6 ~10	6 ~9
SS [mg/L]	30	20	< 500	60
BOD [mg/L]	30	25	< 400	60
COD [mg/L]	50	45	< 700	100
Oil&Grease [mg/L]	3	2	< 100	10

(3) Sizing

(3-1) Treated Water Pit(Z-06)

- 1) Retention Time: 30 min
 2) Req'd Vol. of Pit 38.5 m³
 3) Dimension H= 2.5 m (take) A= 15.40 m²
 W= 3 m L= 5.13 m Z-06=3.0mWx5.2mLx3mH

(3-2) Coagulation Part(T-07)

- 1) Rapid Mixing Time 3 min (take)
 2) Reruired Vol. $V_{f1} = 3.85$ m³

3) Shape=Cylindrical, Vertical, Materials=CS/Epoxy Coating

Required No. 1 Set

4) Demension: Hfl= 2 m (take) Req'd Area 1.93 m²
D= 1.57 m → 1.60 m
Take: 1.5m^{ID} × 2.0m^H

(3-3) Flocculation (+T-07)

1) Slow Mixing Time 20 min (take)

2) Required Vol. Vfl= 25.67 m³

3) Shape=Rectangular, Vertical, Materials=CS/Epoxy Coating

Required No. 1 Set

4) Demension: Hfl= 3 m (take) Req'd Area 8.56 m²
L= 2 W (take) W= 2.07 m, L= 4.14 m
T-07= 2.1m^W × 4.2m^L × 3.0m^H

(3-4) No.3 Sedimentation Basin(T-08)

1) Surface Load Ls= 3 m³/m²/h (take)

2) Req'd Area As= 25.67 m²

3) Shape=Circular, Materials=CS/Epoxy Coating, Req'd No. 1 Set

4) Retention Time Ts= 1 h (take) = 60 min

5) Req'd Vol. Vs= 77 m³ H= 3.00 m

6) Dimensions D= 5.72 m → 5.8 m (Standard)

Take: 5.8m^{ID} × 4.5m^H (linear=3.0m)

<Act. Surface Load = 2.92 m³/m²/h >

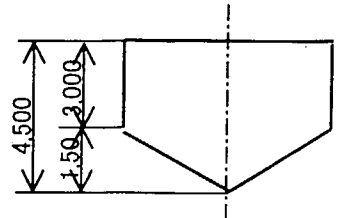

(3-5) Sludge Draw-off

1) SS Removal 2.31 kg/h = 55.44 kg/d

2) Concentration of SS in Draw-off Sludge 0.75 % (take) = 10 kg/m³

3) Sludge Draw-off 0.23 m³/h 0.30 %

(3-6) Coagulant Al₂(SO₄)₃ · 18H₂O Injection Unit

1) Dosing Rate: 30 mg/L, Max. 50 mg/L

2) Concentration: 20 wt % = 222.4 g/L

3) Specific Gravity: 1.112

4) Injection Rate: Q_{p0}= 10.4 L/h = 0.17 L/min (PU-10)

5) Drum Vol. : V_{p0}= 1.7 m³ (for 7days)

Height: H_{p0}= 1.5 m (take) A_{p0}= 1.16 m²

Diameter D_{p0}= 1.2 m

Take: 1.2m^{ID} × 1.5m^H × 2 sets (D-07)

(3-7) pH Controller: Ca(OH)₂ Injection Unit

1) Dosing Rate: 20 mg/L, Max. 50 mg/L

2) Concentration: 10 wt % = 100 g/L

3) Specific Gravity: 1

4) Injection Rate: Q_{p0}= 15.4 L/h = 0.26 L/min (PU-09)

5) Drum Vol. : V_{p0}= 2.6 m³ (for 7days)

Height: H_{p0}= 1.5 m (take) A_{p0}= 1.72 m²

Diameter D_{p0}= 1.5 m

Take: $1.4m^D \times 1.5m^H \times 2$ sets (D-06)

(3-8) Coagulant Aid: Polymer Injection Unit

- 1) Dosing Rate: 0.3 mg/L, Max. 0.5 mg/L
- 2) Concentration: 0.5 wt % = 5 g/L
- 3) Specific Gravity: 1
- 4) Injection Rate: $Q_{p0} = 7.7$ L/h = 0.13 L/min (PU-11)
- 5) Drum Vol. : $V_{p0} = 1.3$ m³ (for 7days)
- Height: $H_{p0} = 1.2$ m (take) $A_{p0} = 1.08$ m²
- Diameter $D_{p0} = 1.2$ m

Take: $1.2m^D \times 1.5m^H \times 2$ sets (D-08)

6.5 Sand Filter Unit

(1) Purpose

To remove overflow floc(SS) from RW-3, and reuse for Cooling Water

(2) Design Conditions

- 1) Wastewater: Wastewater in Collection Pit in Spiral Weldeing Factory.
- 2) Capacity: 50 m³/h = 25 m³/h \times 3 sets (1 stand-by)
- 3) Water Quality

Table-5 Water Quality

	Inlet	Outlet	Law93/62	Law48/82
pH [-]	6.5~8	6.5~8	6 ~ 10	6~9
SS [mg/L]	30	10	< 500	60
BOD [mg/L]	30	< 30	< 400	60
COD [mg/L]	80	< 80	< 700	100
Oil & Grease [mg/L]	5	2	< 100	10
Water Temp. [°C]	20~35	20~35	< 40	35

4) Shape: Cylindrical/Vertical/Gravity Type,

Materials: Carbon Steel + Epoxy coating, Req'd No.: 3 sets (1 stand-by)

- 5) Filter Media: Anthracite + Sand/Gravel
- 6) Backwashing: Air(Blower) + Water (Pump)

(3) Sizing

(3-1) No.3 Wastewater Pit(Z-201)

- 1) Retention Time: 15 min(take)
- 2) Existing Collection Pit: $3m \times 5m \times 3mD = 45$ m³
- 3) Required Vol.: 12.5 m³ Net Retention Time = 69 min
- 4) Dimension: Depth = 3 m(take) Area = 4.17 m²
 $L = 2$ W $W = 1.44$ m $Z-103 = 1.5m \times 3.0m \times 3.5mD$

(3-2) Sand Filter(F-01ABC)

- 1) Filter Velocity $V_f = 180$ m/day = 7.5 m/h (take)
- 2) Filter Area/Diameter $A_f = 3.33$ m² $D_f = 2.06$ m
- 3) Height: $H_f =$ Upper of Trough 1 m
 <Linear part> Trough 0.3 m
 Trough-Anthracite 0.7 m

Anthracite	0.7	m
Sand+Gravel	0.8	m
Support+Under	0.7	m
Allowance	0.3	m
Total Height	4.5	m

Take: $2.1 \text{ m}^{\text{D}} \times 4.5 \text{ m}^{\text{H}} \rightarrow 3.46 \text{ m}^2(\text{net})$

(3-3) Filtered Water Pit (Z-202)

- 1) Vol. of Pit $V_{fb} = 45 \text{ min (take)} \rightarrow 37.5 \text{ m}^3$
- 2) Depth of Pit $H_{fb} = 2.5 \text{ m (take)}$ Surface Area 15 m^2
- 3) $L = 2 \text{ W (take)}$ $W = 2.74 \text{ m}$ $L = 5.48 \text{ m}$

Take: $3.0 \text{ m}^{\text{W}} \times 5.0 \text{ m}^{\text{L}} \times 3.0 \text{ m}^{\text{H}}$

(3-4) Backwashing Pump (PU-203)

- 1) Backwashing Velocity $U_{bw} = 40 \text{ m/h (take)}$
- 2) Backwashing Flow rate $Q_{bw} = 138.47 \text{ m}^3/\text{h}$
- 3) Backwashing Time $T_{bw} = 10 \text{ min (take)}$
- 4) Backwashing Water $V_{bw} = 23.08 \text{ m}^3/\text{h/Cycle}$
- 5) Backwashing Pump $Q_p = 152.32 \text{ m}^3/\text{h}$ $H_p = 12 \text{ mH (take)}$
 $P = 9.93 \text{ kW} \rightarrow 11 \text{ kW}$ $\text{PU-203} = 155 \text{ m}^3/\text{h} \times 12 \text{ mH} \times 11 \text{ kW}$

(3-5) Backwashing W.W. Pit (Z-203)

- 1) Vol. of Pit $V_{fb} = 1.5 \text{ Backwashing water} \rightarrow 34.62 \text{ m}^3$
- 2) Depth of Pit $H_{fb} = 2.5 \text{ m (take)}$ Surface Area 13.85 m^2
- 3) $L = 2 \text{ W (take)}$ $W = 2.63 \text{ m}$ $L = 5.26 \text{ m}$

Take: $3 \text{ m}^{\text{W}} \times 5.0 \text{ m}^{\text{L}} \times 3.0 \text{ m}^{\text{H}}$

(3-6) Backwash Blower (B-201)

- 1) Backwash Air Rate $20 \text{ Nm}^3/\text{m}^2/\text{h}$
- 2) Req'd Air $1.4 \text{ m}^3/\text{min} \rightarrow \text{Blower} = 1.5 \text{ Nm}^3/\text{min} \times 5 \text{ mH} \times 3.7 \text{ kW}$

(3-7) Backwash wastewater Feed

- 1) Max. Backwashing W.W. $34.62 \text{ m}^3/\text{C}$ Av. Backwashing W.W. $23.08 \text{ m}^3/\text{C}$
- 2) Treating Time: 23 h/d Backwash 2 times/d
- 3) Av. Flow Rate: $2.01 \text{ m}^3/\text{h}$ Max. Flow Rate $3.01 \text{ m}^3/\text{h}$
- 4) SS to be removed: 24 kg/d SS Contents: 0.52 kg/m^3
 SS contents in WW RW-3 $30 \text{ mg/L} \rightarrow 550 \text{ mg/L}$
- 5) BOD removal 10% BOD to be removed $3.6 \text{ kg/d} = 0.16 \text{ kg/m}^3$
 BOD contents in WW RW-3 $30 \text{ mg/L} \rightarrow 186 \text{ mg/L}$
- 6) COD removal 10% BOD to be removed $9.6 \text{ kg/d} = 0.416 \text{ kg/m}^3$
 COD Contents in WW RW-3 $80 \text{ mg/L} \rightarrow 496 \text{ mg/L}$
- 7) Oil to be removed 3.6 kg/d Oil Contents 0.078 kg/m^3
 Oil Contents in WW $5 \text{ mg/L} \rightarrow 83 \text{ mg/L}$

6.5 Sludge Treating Unit

(1) Purpose

To reduce sludge volume by thickening and dewatering

(2) Design Conditions

- 1) Sludge: (a) Neutralization sludge (direct No.1 Centrifuge)
- (b) Activated surplus sludge
- (c) Clarifier Sludge (only design)

2) Thickener=continuous operation
Centrifuge=6h/day operation

(3) Sizing

(3-1) Sludge Thickener(T-09)

1) Surface Load $L_{ss} = \frac{60}{2.5} \text{ kg/m}^2/\text{d} = 2.5 \text{ kg/m}^2/\text{h}$
 Draw-off Sludge Conc. 40 kg/m^3
 SS Contents of Overflow $300 \text{ mg/L} = 0.3 \text{ kg/m}^3$

2) Sludge Rate (In)

(a) Act. Sludge Treat. $L_{ac} = 17.02 \text{ kg/h} = 2.13 \text{ m}^3/\text{h}$
 (b) Clarifier $L_{cl} = 2.31 \text{ kg/h} = 0.23 \text{ m}^3/\text{h}$
 Total $L_{to} = 19.33 \text{ kg/h} = 2.36 \text{ m}^3/\text{h}$ SS Conc. av = 8.20 kg/m^3

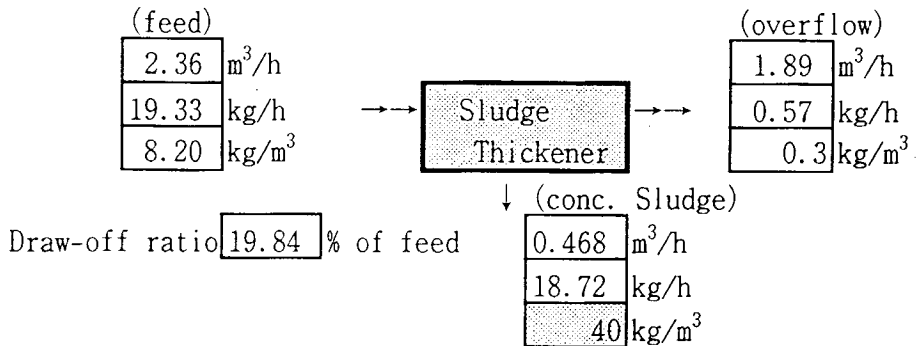

3) Req'd Surface Area $A_{th} = 7.73 \text{ m}^2$ $D_f = 3.14 \text{ m}$
 4) Thickener Height
 Water Retention 4 h (take) , $H_c = 1.22 \text{ m}$
 Sludge Retention 18 h (take) , $H_s = 1.09 \text{ m}$
 Take: $3.2 \text{ m}^{ID} \times 2.5 \text{ m}^H$

(3-2) Polymer Injection Unit for Thickener

1) Dosage 300 mg/L
 2) Concentration $0.1 \text{ wt \%} = 1 \text{ g/L}$ (D-09)
 3) Specific gravity 1
 4) Req'd Polymer $0.71 \text{ g/h} = 0.71 \text{ L/h}$ (PU-13)
 5) Req'd Vol. $V_{p0} = 0.04 \text{ m}^3$ (7 days)
 6) Demension : Take: $0.4 \text{ m}^{ID} \times 1.0 \text{ m}^H \times 2 \text{ sets}$

(3-3) NO.1 Centrifuge

1) Sludge Feed Rate: (Sludge generation/day) / 8 h Operation
 $1.00 \text{ m}^3/\text{h} = 20 \text{ kg/h}$ Centrifuge Cap. = $1.5 \text{ m}^3/\text{h}$
 2) Solid content of Cake $20 \text{ \%} = 200 \text{ kg/m}^3$
 Solid content of Water $500 \text{ mg/L} = 0.5 \text{ kg/m}^3$

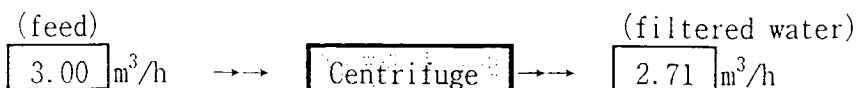

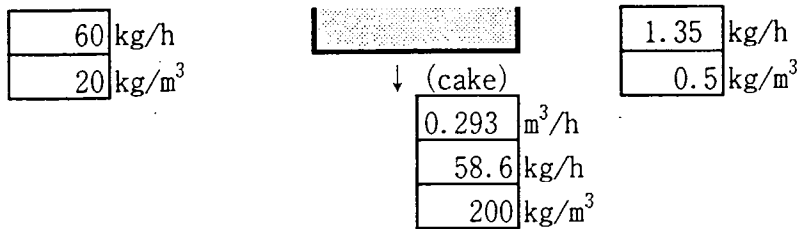

3) Sludge cake ratio

9.77

 % of Feed Sludge

4) Generation of Cake

2.34

 m³/d

(3-4) NO.2 Centrifuge

1) Sludge Feed Rate: (Sludge generation/day)/

6

 h Operation

0.47

 m³/h =

18.72

 kg/h Centrifuge Cap. = 2.0 m³/h

2) Solid content of Cake

20

 % =

200

 kg/m³

Solid content of Water

500

 mg/L

0.5

 kg/m³

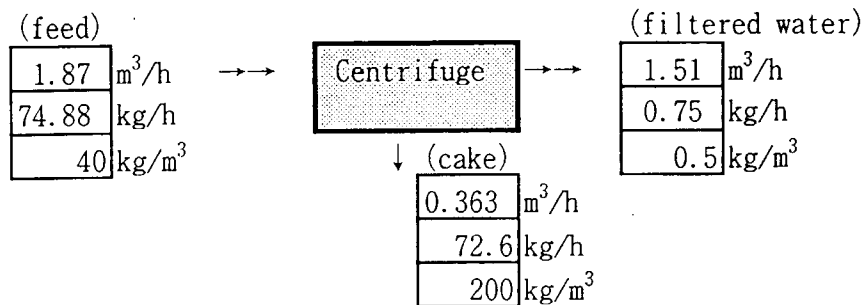

3) Sludge cake ratio

19.39

 % of Feed Sludge

4) Generation of Cake

2.18

 m³/d

(3-5) Polymer Injection Unit for Centrifuge

1) Dosage

1

 % as Dry SS =

0.60

 kg/h

2) Concentration

1

 wt % =

10

 g/L

3) Specific gravity

1

4) Injection rate Q_{po} =

60

 L/h =

1.00

 L/min (PU-15)

5) Req'd Vol. V_{po} =

1.08

 m³ (for 3days)

6) Drum Dimension H_{po} =

1.50

 m (take) A_{po} =

0.72

 m²

D_{po} =

0.96

 m

: Take: 1.2m¹⁰x1.8m¹¹, 1 set (D-10)

6.6 Sterilization

(1) Purpose

To sterilize treated water including sanitary wastewater

(2) Design Condition

1) Wastewater: Filtered water

2) Disinfectant: NaClO Conc

12

 wt% Sp. Gra

1.0155

3) Dosage

4

 mg/L (Max. 6mg/L)

4) Contact Time

15

 min

(3) Sizing

- 1) Injection Rate $\boxed{1.64}$ L/h
- 2) Req'd Drum Vol. $\boxed{0.28}$ m³ (for 7days)
- 3) Drum Dimension: Take: 0.6m^{ID}x1.0m^H
- 4) Sterilization Basin Vol. $\boxed{12.5}$ m³
- 5) Basin Dimension H= $\boxed{2.5}$ m (take) A= $\boxed{5}$ m²
- Take: 2.0m^Wx3.5m^Lx2.5m^H