

NOTES :

- * FOR EXACT HEIGHTS AND DIMENSIONS OF BENCHES SEE TYPICAL ROAD CROSS-SECTION .
- * SLOPE H : V .

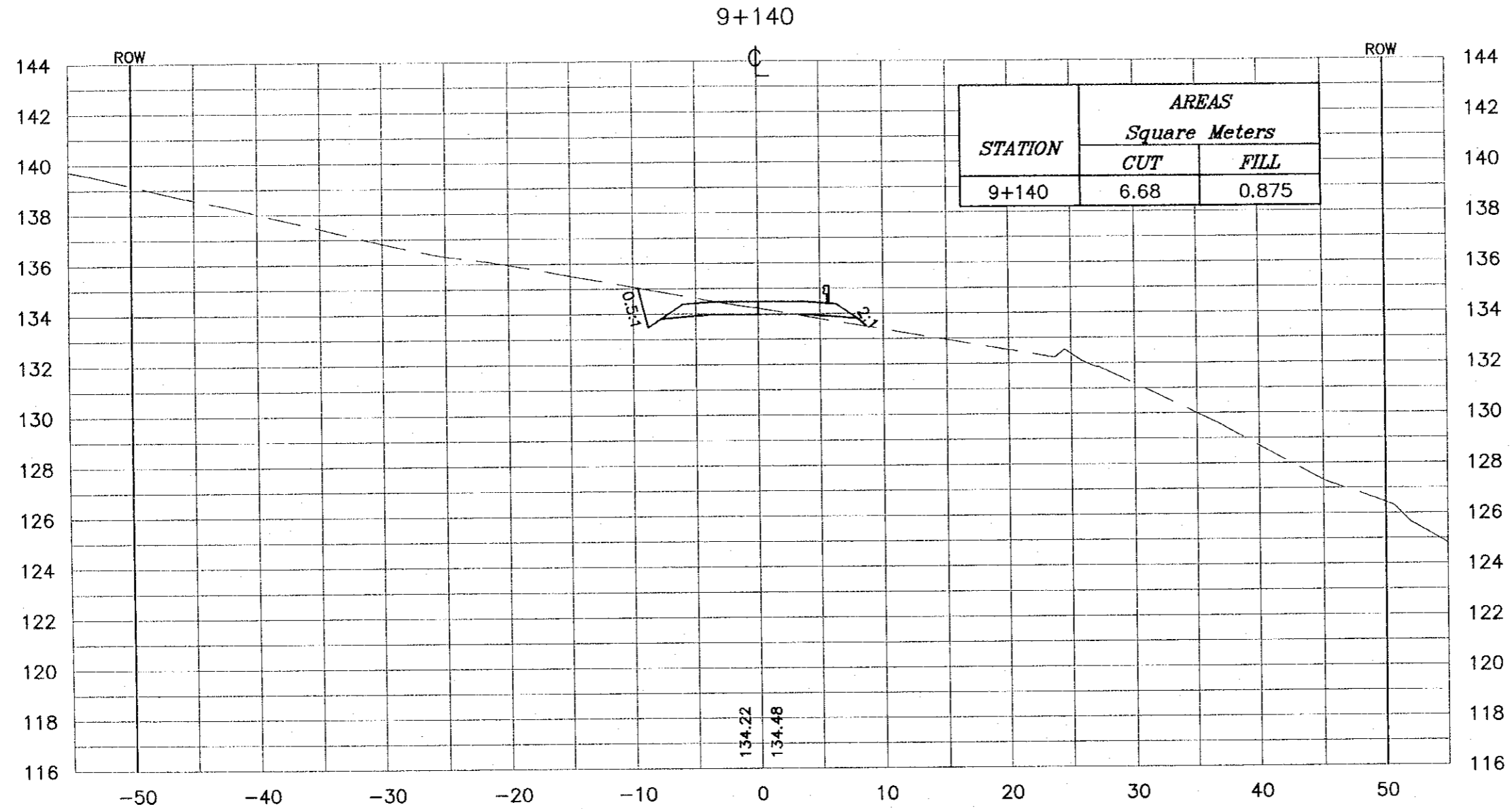

Project:
Tourism Sector Development Project
in the Hashemite Kingdom of Jordan

Executing Agency:
The Ministry of Tourism and Antiquities
The Ministry of Planning

SUB-PROJECT:
Dead Sea Parkway

Note:
This detailed design has been executed by a team of consultants as shown below in accordance with the agreement between Japan International Cooperation Agency (JICA) and JICA Study Team. The copyright of this drawing rests with JICA.

Designed by:
Japan International Cooperation Agency (JICA)

JICA Study Team:
Joint Venture of
Pacific Consultants International and
Yamashita Sekkei Inc.

Subcontracted Local Consultant:
 consolidated consultants
Engineering & Environment
Tel: 4612377 - Fax: 4612380 - Amman - JORDAN

Drawing Title:
CROSS-SECTION
9+140

Scale: H: 1:400 V: 1:200 **Drawing No.:** 372

NOTES :

- * FOR EXACT HEIGHTS AND DIMENSIONS OF BENCHES SEE TYPICAL ROAD CROSS-SECTION .
- * SLOPE H : V .

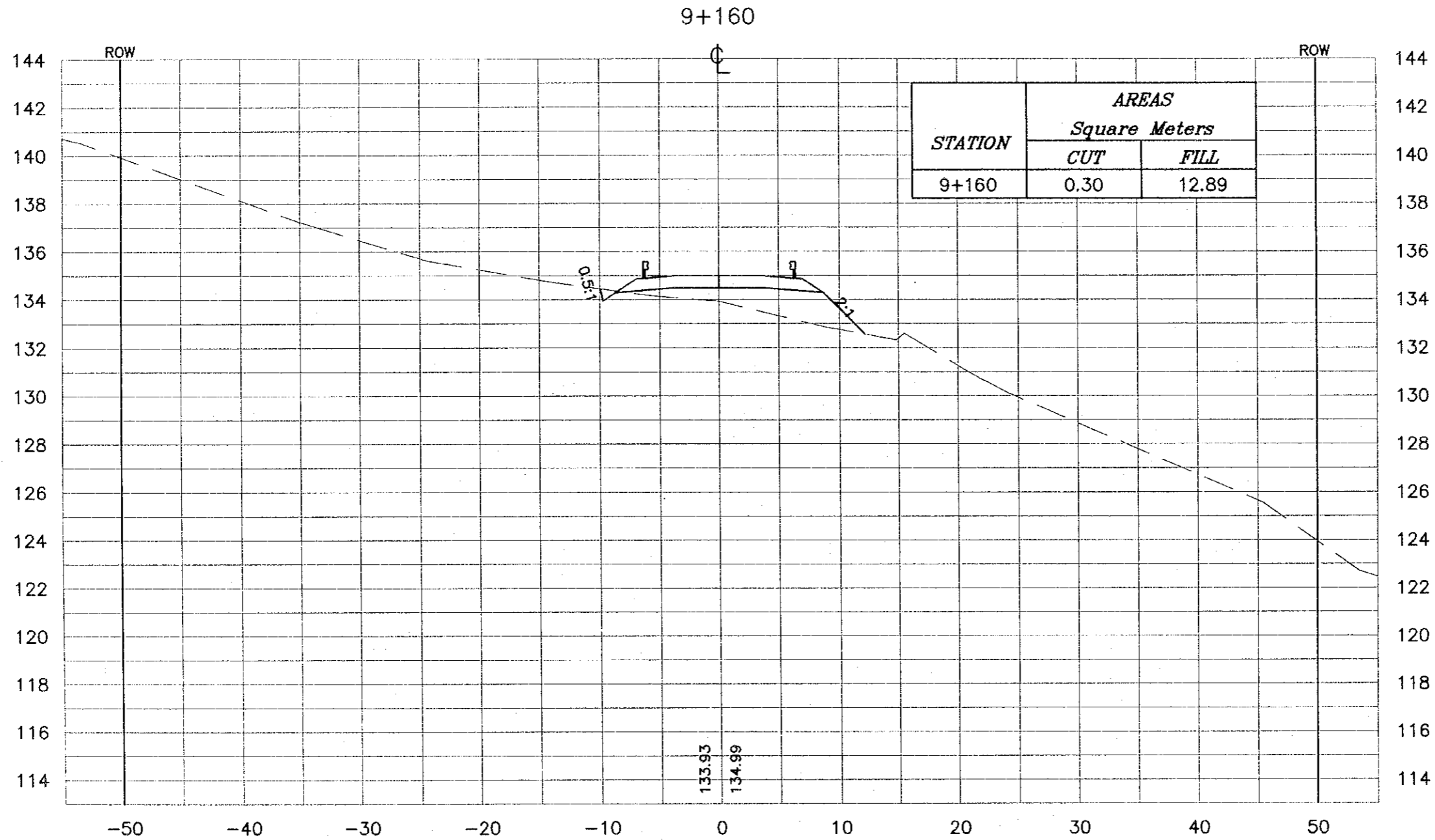

Project:
Tourism Sector Development Project
in the Hashemite Kingdom of Jordan

Executing Agency:
The Ministry of Tourism and Antiquities
The Ministry of Planning

SUB-PROJECT:
Dead Sea Parkway

Note:
This detailed design has been executed by a team of consultants as shown below in accordance with the agreement between Japan International Cooperation Agency (JICA) and JICA Study Team. The copyright of this drawing rests with JICA.

Designed by:
Japan International Cooperation Agency (JICA)

JICA Study Team:
Joint Venture of Pacific Consultants International and Yamashita Sekkei Inc.

Subcontracted Local Consultant:

consolidated consultants
engineering & environment
Tel: 952277 - Fax: 451200 - AMMAN - JORDAN

Drawing Title:
CROSS-SECTION
9+160

Scale: 1:400 **Drawing No.:** 373
V 1:200

NOTES :

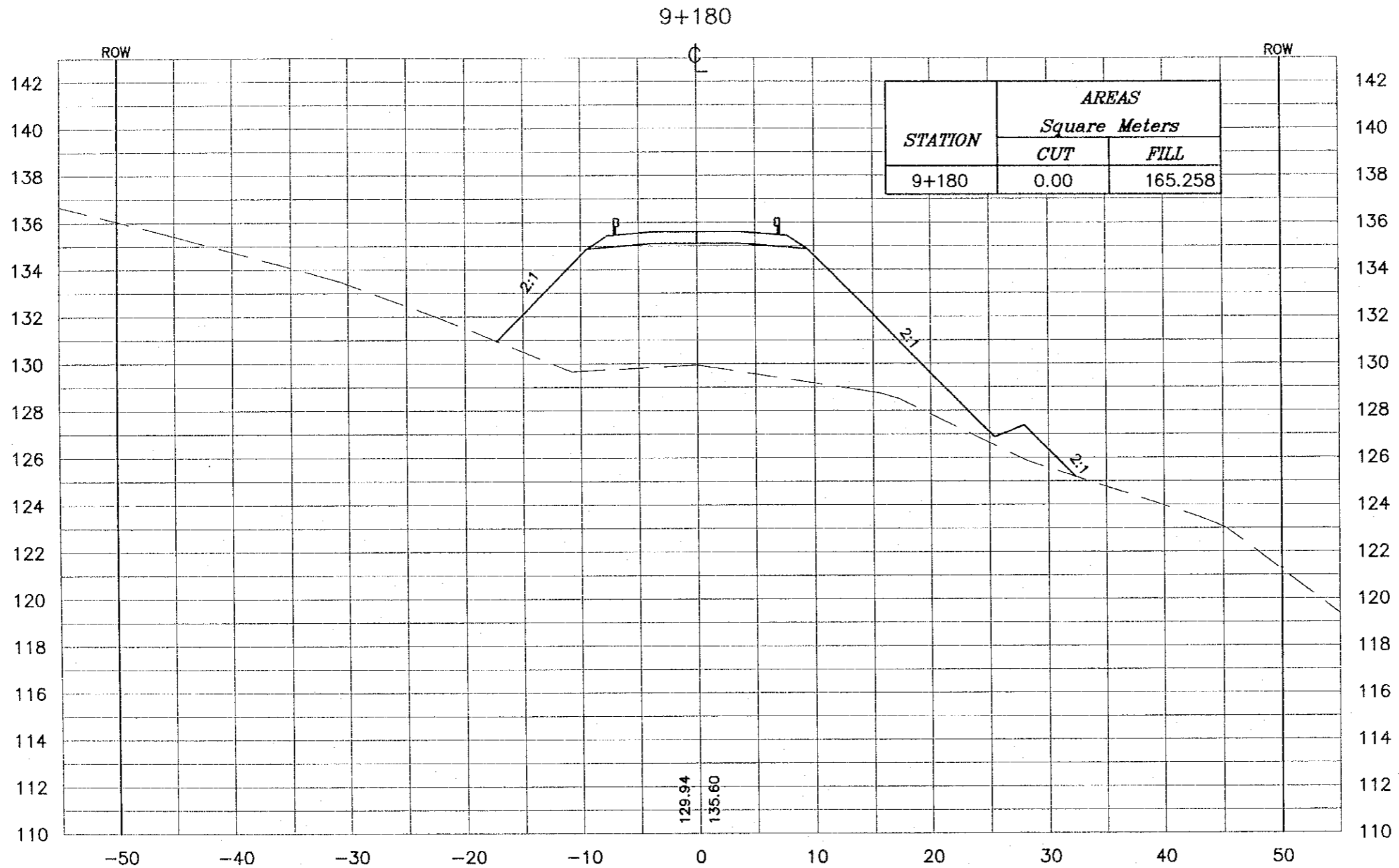
- * FOR EXACT HEIGHTS AND DIMENSIONS OF BENCHES SEE TYPICAL ROAD CROSS-SECTION .
- * SLOPE H : V .



Project:
Tourism Sector Development Project
in the Hashemite Kingdom of Jordan

Executing Agency:
The Ministry of Tourism and Antiquities
The Ministry of Planning

SUB-PROJECT:
Dead Sea Parkway

Note:
This detailed design has been executed by a team of consultants as shown below in accordance with the agreement between Japan International Cooperation Agency (JICA) and JICA Study Team. The copyright of this drawing rests with JICA.

Designed by:
Japan International Cooperation Agency (JICA)

JICA Study Team:
Joint Venture of
Pacific Consultants International and
Yamashita Sekkel Inc.

Subcontracted Local Consultant:
 consolidated consultants
engineering & environment
Tel: 412377 - Fax: 412380 - Jordan - JORDAN

Drawing Title:
CROSS-SECTION
9+180

Scale: H 1:400 V 1:200 **Drawing No.:** 374

NOTES :

- * FOR EXACT HEIGHTS AND DIMENSIONS OF BENCHES SEE TYPICAL ROAD CROSS-SECTION .
- * SLOPE H : V .

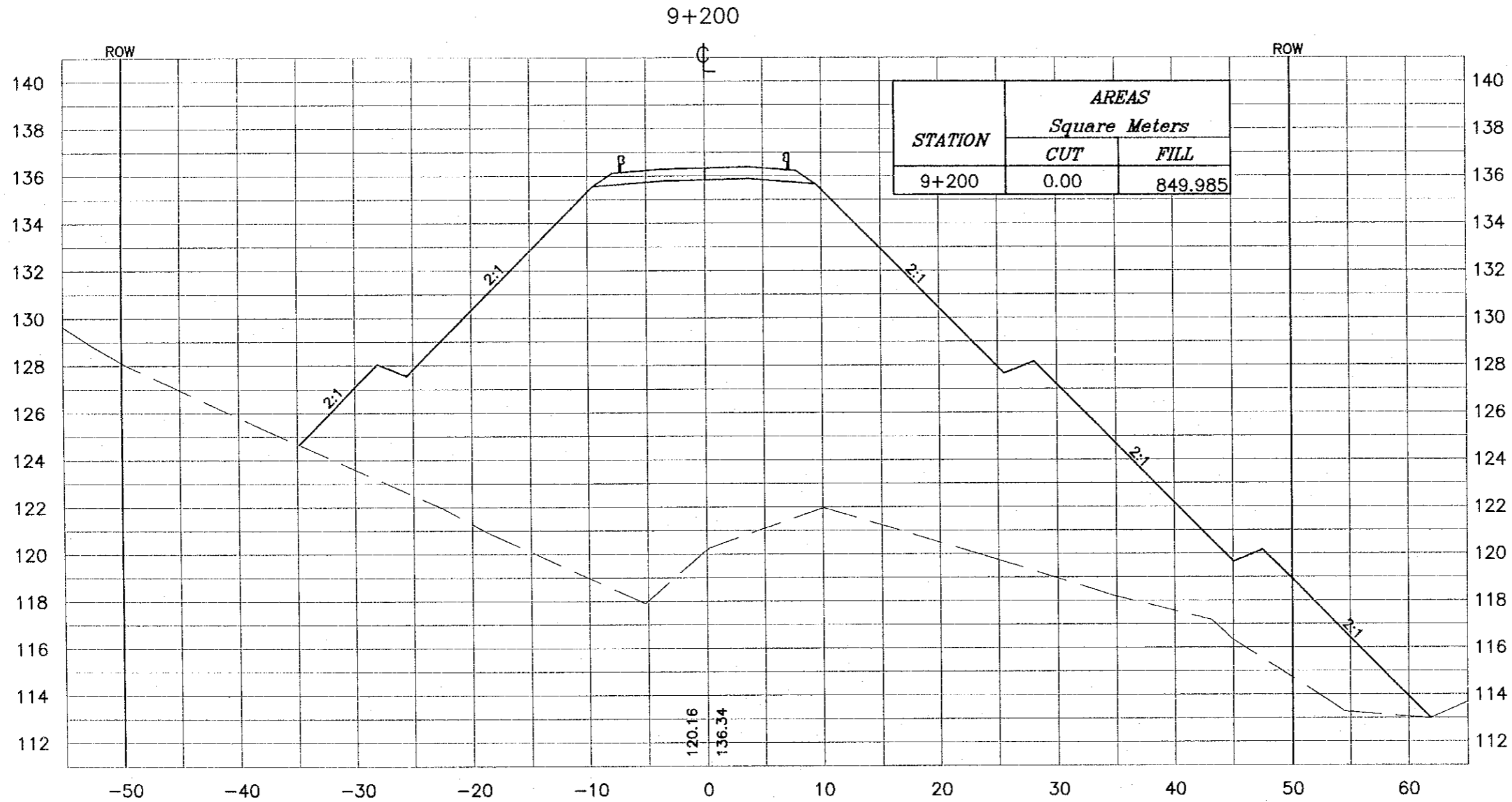

Project:
Tourism Sector Development Project
in the Hashemite Kingdom of Jordan

Executing Agency:
The Ministry of Tourism and Antiquities
The Ministry of Planning

SUB-PROJECT:
Dead Sea Parkway

Note:
This detailed design has been executed by a team of consultants as shown below in accordance with the agreement between Japan International Cooperation Agency (JICA) and JICA Study Team. The copyright of this drawing rests with JICA.

Designed by:
Japan International Cooperation Agency (JICA)

JICA Study Team:
Joint Venture of Pacific Consultants International and Yamashita Sekkei Inc.

Subcontracted Local Consultant:
 consolidated consultants
Engineering & Environment
Tel: 9612377 - Fax: 9612380 - JAMA - 20094

Drawing Title:
CROSS-SECTION
9+200

Scale: H 1:400 V 1:200 **Drawing No.:** 375

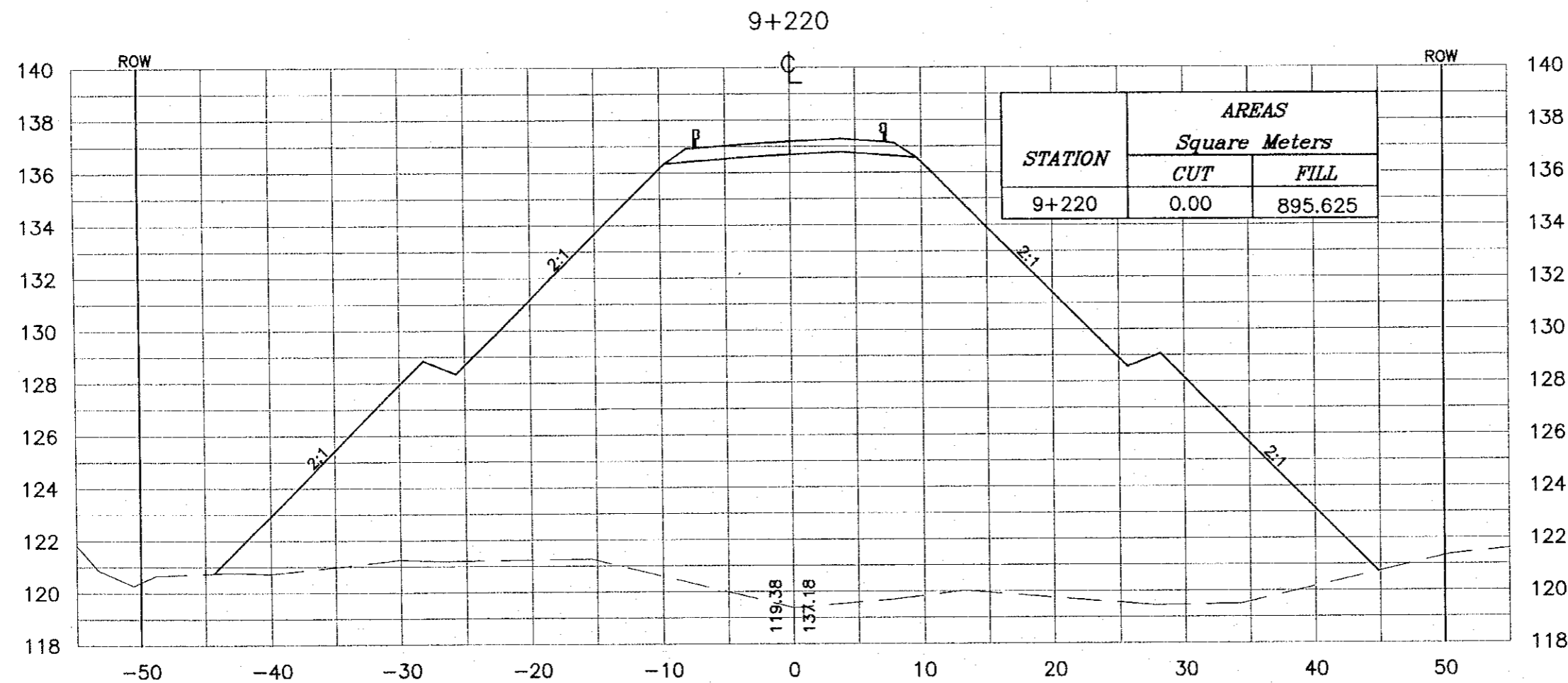
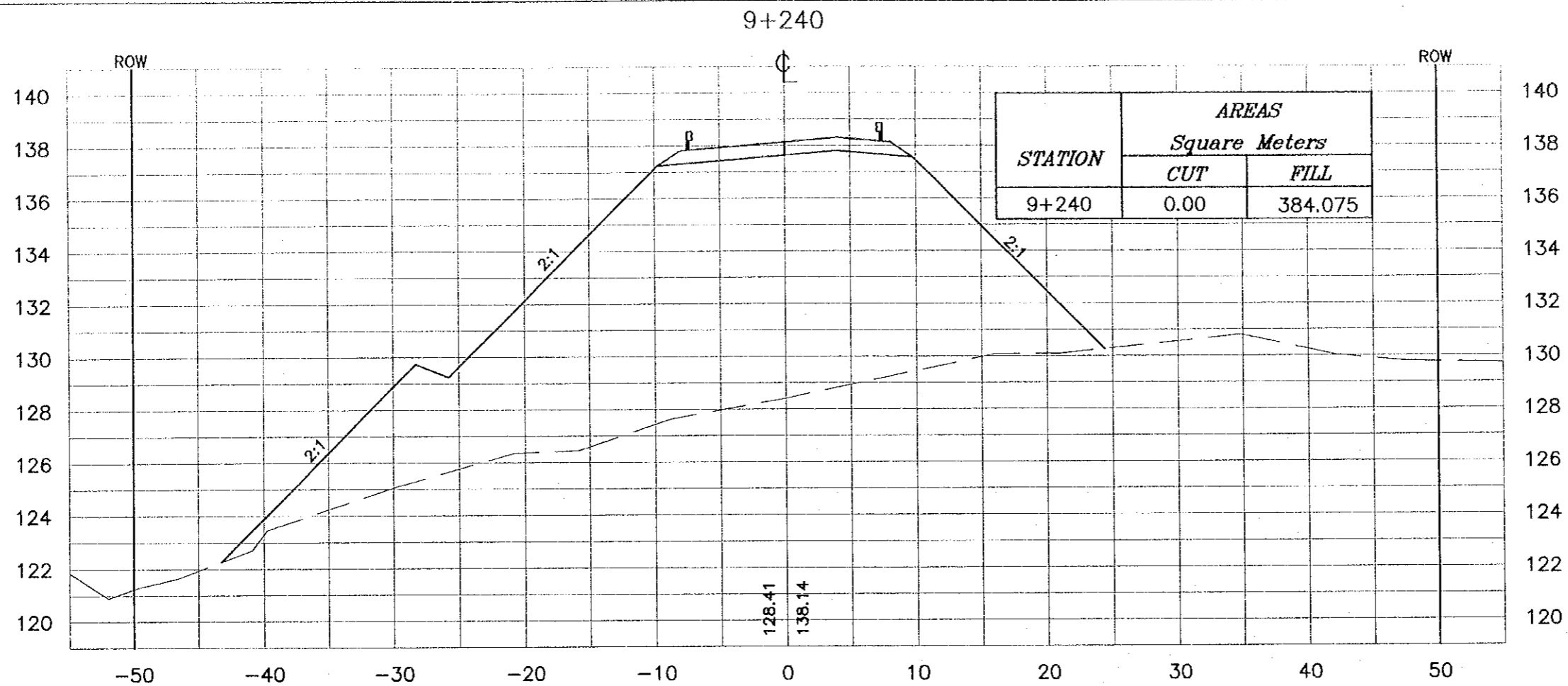

NOTES :

- * FOR EXACT HEIGHTS AND DIMENSIONS OF BENCHES SEE TYPICAL ROAD CROSS-SECTION .
- * SLOPE H : V .

Project:
Tourism Sector Development Project
in the Hashemite Kingdom of Jordan

Executing Agency:
The Ministry of Tourism and Antiquities
The Ministry of Planning

SUB-PROJECT:
Dead Sea Parkway

Note:
This detailed design has been executed by a team of consultants as shown below in accordance with the agreement between Japan International Cooperation Agency (JICA) and JICA Study Team. The copyright of this drawing rests with JICA.

Designed by:
Japan International Cooperation Agency (JICA)

JICA Study Team:
Joint Venture of Pacific Consultants International and Yamasita Sekkel Inc.

Subcontracted Local Consultant:
 consolidated consultants
engineering & environment
Tel: 9612377 - Fax: 9612380 - AMMAN - JORDAN

Drawing Title:
CROSS-SECTION
9+220/9+240

Scale: H 1:400 V 1:200 **Drawing No.:** 376

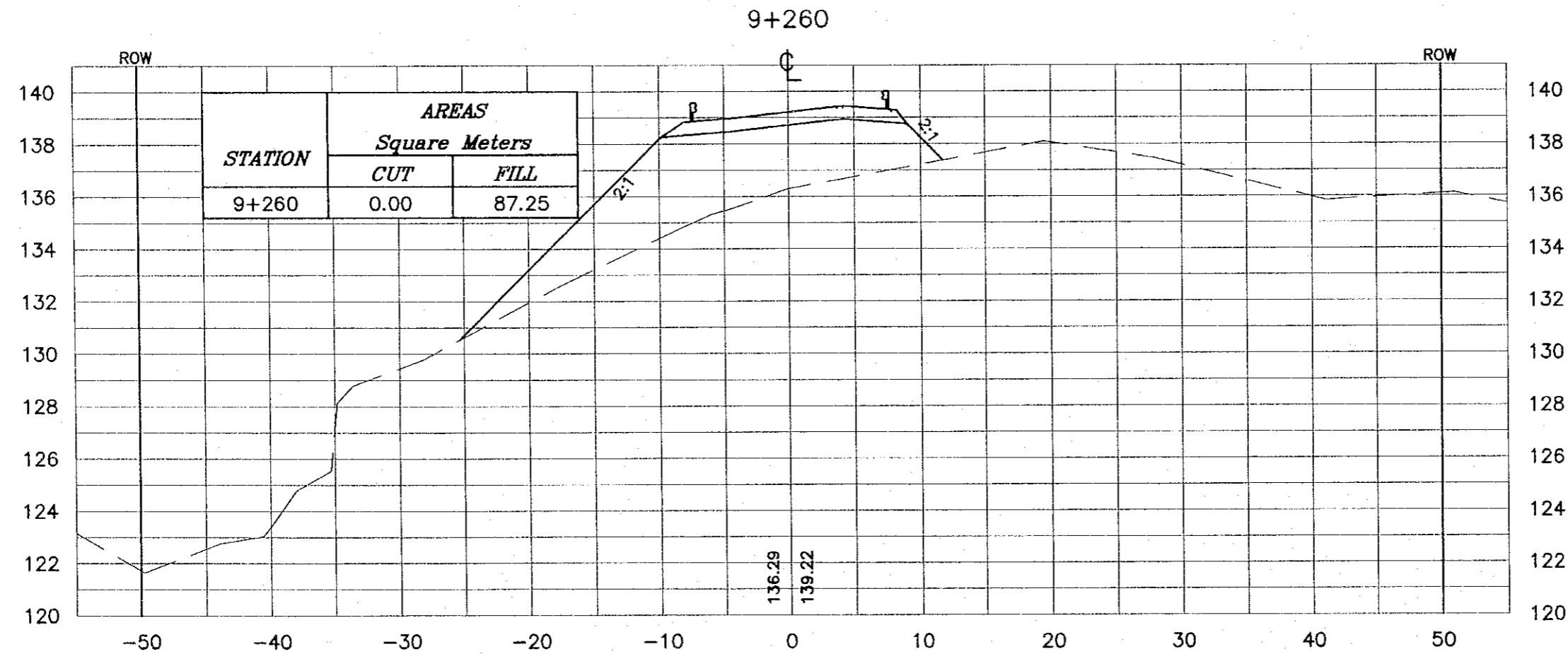
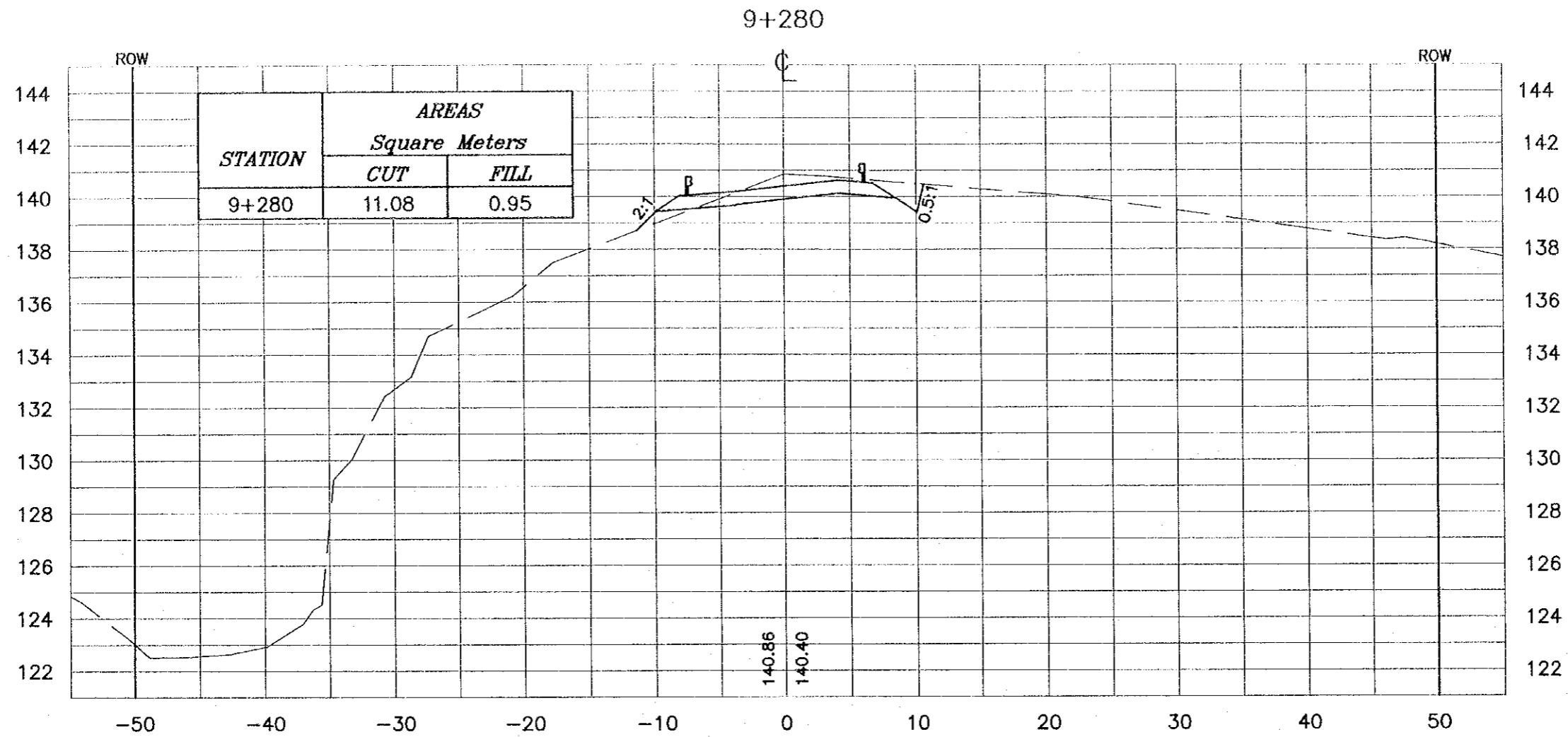

NOTES :

- * FOR EXACT HEIGHTS AND DIMENSIONS OF BENCHES SEE TYPICAL ROAD CROSS-SECTION .
- * SLOPE H : V .

Project:
Tourism Sector Development Project
in the Hashemite Kingdom of Jordan

Executing Agency:
The Ministry of Tourism and Antiquities
The Ministry of Planning

SUB-PROJECT:
Dead Sea Parkway

Note:
This detailed design has been executed by a team of consultants as shown below in accordance with the agreement between Japan International Cooperation Agency (JICA) and JICA Study Team. The copyright of this drawing rests with JICA.

Designed by:
Japan International Cooperation Agency (JICA)

JICA Study Team:
Joint Venture of Pacific Consultants International and Yamaoka Sekitai Inc.

Subcontracted Local Consultant:
 consolidated consultants
engineering & environment
Tel: 9613377 - Fax: 9613386 - AMMAN - JORDAN

Drawing Title:
CROSS-SECTION
9+260/9+280

Scale:
H 1:400
V 1:200

Drawing No.: 377

NOTES :

- * FOR EXACT HEIGHTS AND DIMENSIONS OF BENCHES SEE TYPICAL ROAD CROSS-SECTION .
- * SLOPE H : V .

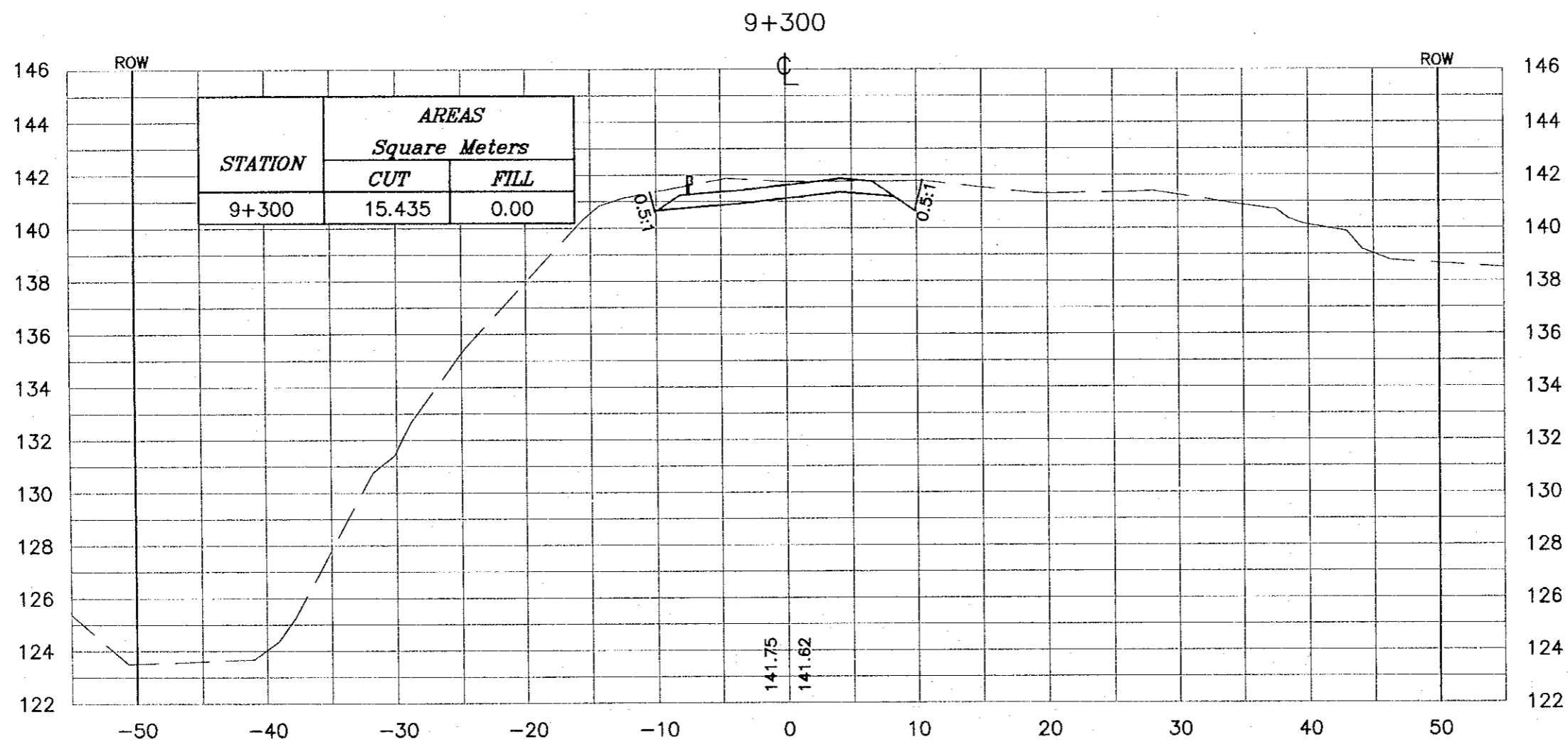

Project:
Tourism Sector Development Project
in the Hashemite Kingdom of Jordan

Executing Agency:
The Ministry of Tourism and Antiquities
The Ministry of Planning

SUB-PROJECT:
Dead Sea Parkway

Note:
This detailed design has been executed by a team of consultants as shown below in accordance with the agreement between Japan International Cooperation Agency (JICA) and JICA Study Team. The copyright of this drawing rests with JICA.

Designed by:
Japan International Cooperation Agency (JICA)
JICA Study Team:
Joint Venture of Pacific Consultants International and Yamashita Sekitai Inc.

Subcontracted Local Consultant:
 consolidated consultants
engineering & environment
Tel: 9622777 - Fax: 9622800 - AMMAN - JORDAN

Drawing Title:
CROSS-SECTION
9+300

Scale: H 1:400 V 1:200 **Drawing No.:** 378

NOTES :

- * FOR EXACT HEIGHTS AND DIMENSIONS OF BENCHES SEE TYPICAL ROAD CROSS-SECTION .
- * SLOPE H : V .

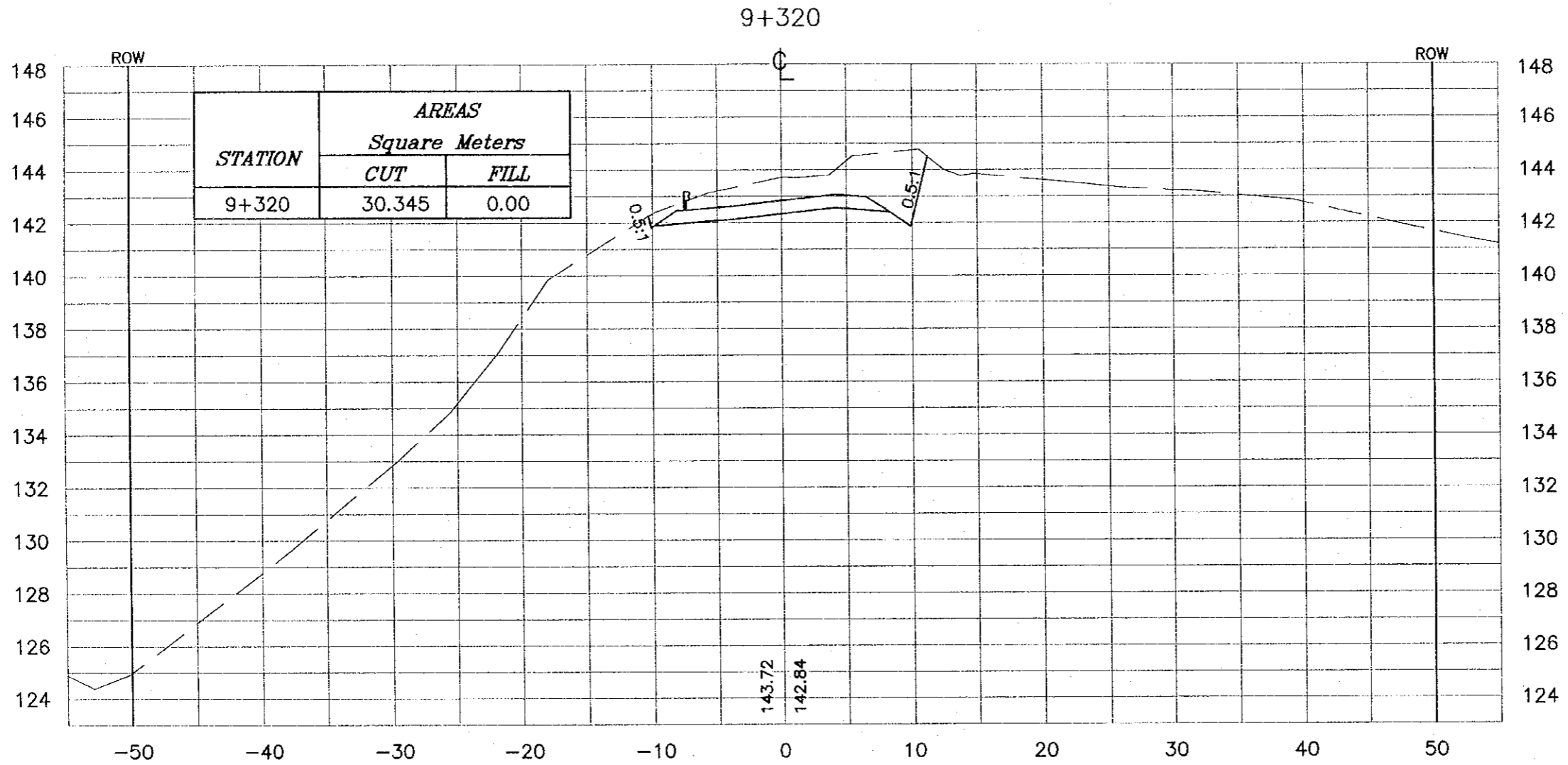

Project:
Tourism Sector Development Project
In the Hashemite Kingdom of Jordan

Executing Agency:
The Ministry of Tourism and Antiquities
The Ministry of Planning

SUB-PROJECT:
Dead Sea Parkway

Note:
This detailed design has been executed by a team of consultants as shown below in accordance with the agreement between Japan International Cooperation Agency (JICA) and JICA Study Team. The copyright of this drawing rests with JICA.

Designed by:
Japan International Cooperation Agency (JICA)

JICA Study Team:
Joint Venture of
Pacific Consultants International and
Yamashita Sekkel Inc.

Subcontracted Local Consultant:
 consolidated consultants
engineering & environment
Tel: 9612377 - Fax: 9612390 - AMMAN - JORDAN

Drawing Title:
CROSS-SECTION
9+320

Scale: 1:400 **Drawing No.:** 379
V 1:200

NOTES :

- * FOR EXACT HEIGHTS AND DIMENSIONS OF BENCHES SEE TYPICAL ROAD CROSS-SECTION .
- * SLOPE H : V .

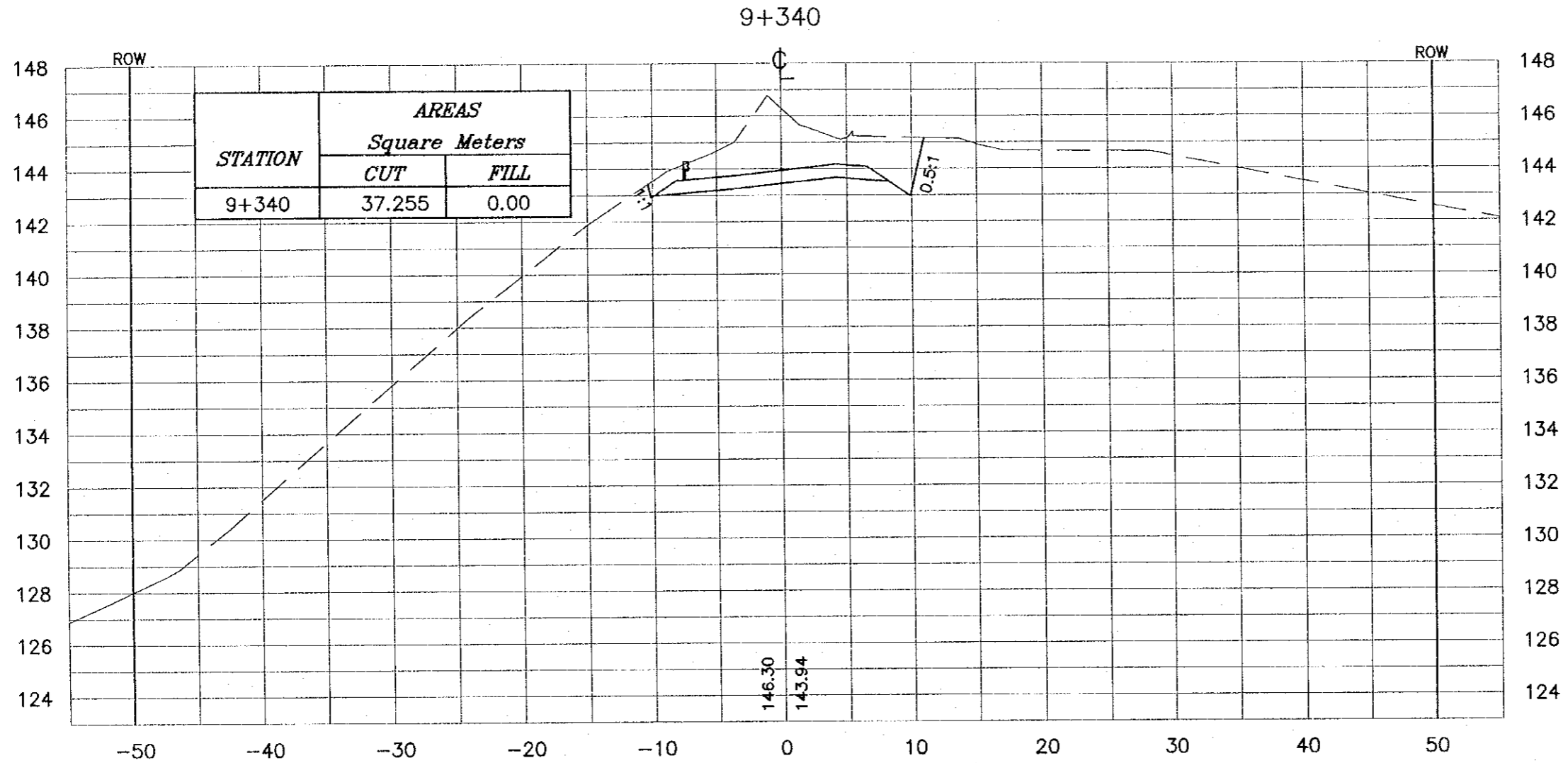

Project:
Tourism Sector Development Project
in the Hashemite Kingdom of Jordan

Executing Agency:
The Ministry of Tourism and Antiquities
The Ministry of Planning

SUB-PROJECT:
Dead Sea Parkway

Note:
This detailed design has been executed by a team of consultants as shown below in accordance with the agreement between Japan International Cooperation Agency (JICA) and JICA Study Team. The copyright of this drawing rests with JICA.

Designed by:
Japan International Cooperation Agency (JICA)

JICA Study Team:
Joint Venture of
Pacific Consultants International and
Yamashita Sekkei Inc.

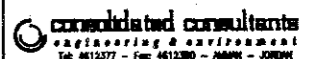
Subcontracted Local Consultant:

consolidated consultants
engineering & environment
Tel: 4112777 - Fax: 4112390 - JORDAN

Drawing Title:
CROSS-SECTION
9+340

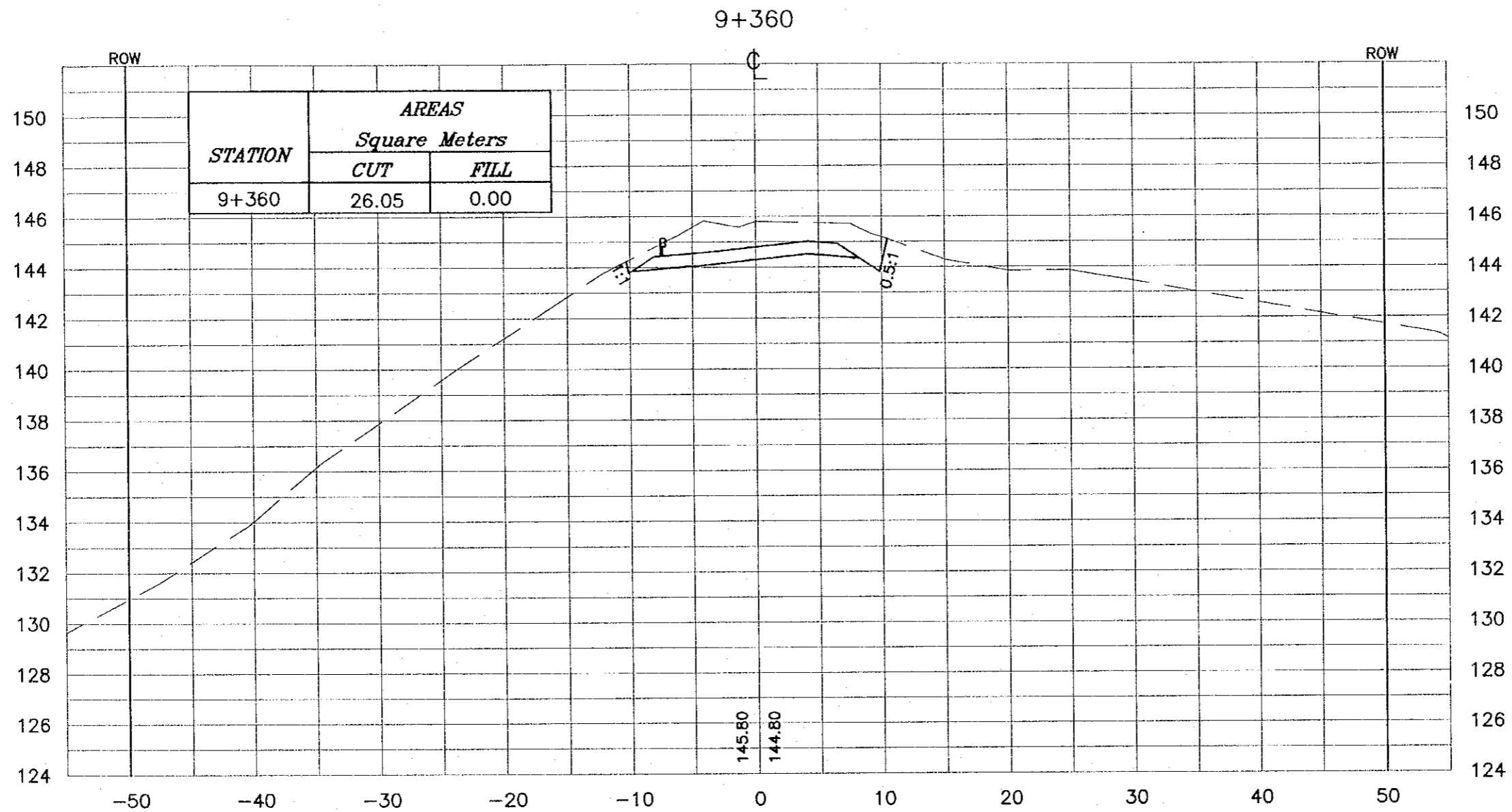
Scale: H: 1:400 V: 1:200 **Drawing No.:** 380



NOTES :

- * FOR EXACT HEIGHTS AND DIMENSIONS OF BENCHES SEE TYPICAL ROAD CROSS-SECTION .
- * SLOPE H : V .

Project:
Tourism Sector Development Project
in the Hashemite Kingdom of Jordan

Executing Agency:
The Ministry of Tourism and Antiquities
The Ministry of Planning

SUB-PROJECT:
Dead Sea Parkway

Note:
This detailed design has been executed by a team of consultants as shown below in accordance with the agreement between Japan International Cooperation Agency (JICA) and JICA Study Team. The copyright of this drawing rests with JICA.

Designed by:
Japan International Cooperation Agency (JICA)

JICA Study Team:
Joint Venture of
Pacific Consultants International and
Yamashita Sekkel Inc.

Subcontracted Local Consultant:
 consolidated consultants
engineering & environment
Tel: 4612377 - Fax: 4612380 - Amman - Jordan

Drawing Title:
CROSS-SECTION
9+360

Scale: H: 1:400 V: 1:200 **Drawing No.:** 381

NOTES :

- * FOR EXACT HEIGHTS AND DIMENSIONS OF BENCHES SEE TYPICAL ROAD CROSS-SECTION .
- * SLOPE H : V .

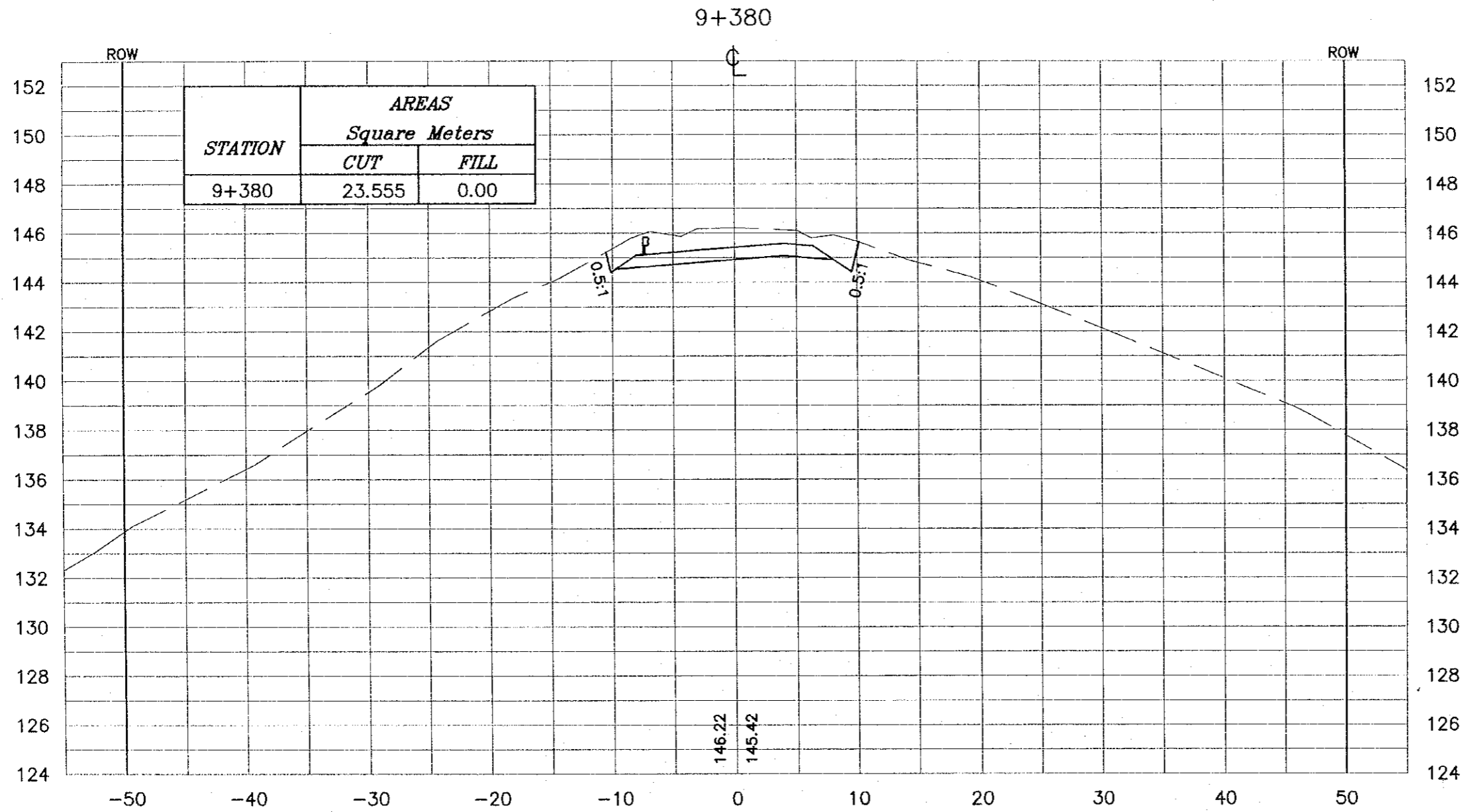

Project:
Tourism Sector Development Project
in the Hashemite Kingdom of Jordan

Executing Agency:
The Ministry of Tourism and Antiquities
The Ministry of Planning

SUB-PROJECT:
Dead Sea Parkway

Note:
This detailed design has been executed by a team of consultants as shown below in accordance with the agreement between Japan International Cooperation Agency (JICA) and JICA Study Team.
The copyright of this drawing rests with JICA.

Designed by:
Japan International Cooperation Agency (JICA)

JICA Study Team:
Joint Venture of
Pacifica Consultants International and
Yamashita Sekkei Inc.

Subcontracted Local Consultant:
 consolidated consultants
engineering & environment
Tel: 992277 - Fax: 992380 - AMMAN - JORDAN

Drawing Title:
CROSS-SECTION
9+380

Scale: H 1:400 **Drawing No.:** 382
V 1:200

NOTES :

- * FOR EXACT HEIGHTS AND DIMENSIONS OF BENCHES SEE TYPICAL ROAD CROSS-SECTION .
- * SLOPE H : V .

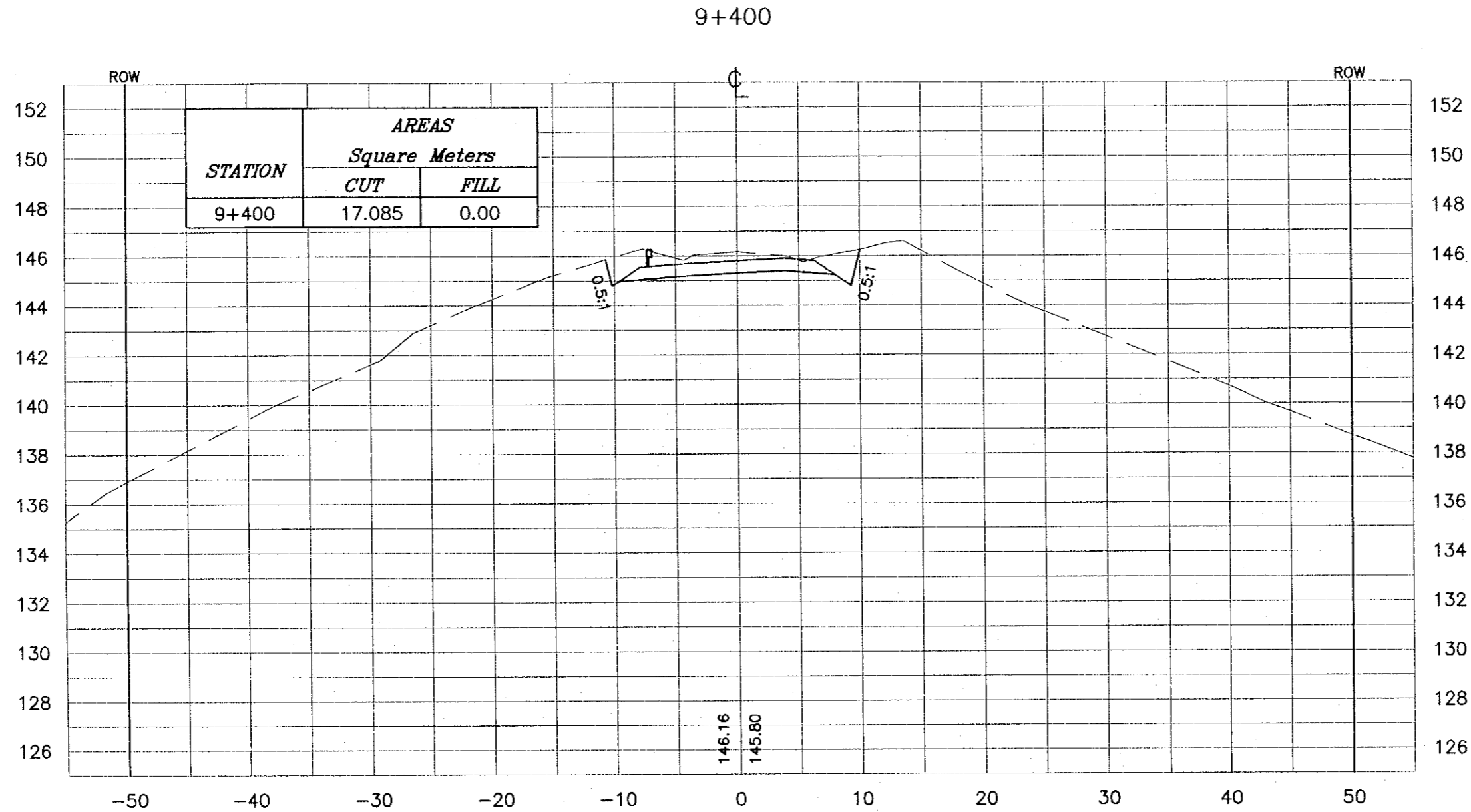

Project:
Tourism Sector Development Project
in the Hashemite Kingdom of Jordan

Executing Agency:
The Ministry of Tourism and Antiquities
The Ministry of Planning

SUB-PROJECT:
Dead Sea Parkway

Note:
This detailed design has been executed by
a team of consultants as shown below in
accordance with the agreement between
Japan International Cooperation Agency
(JICA) and JICA Study Team.
The copyright of this drawing rests with JICA.

Designed by:
Japan International Cooperation
Agency (JICA)

JICA Study Team:
Joint Venture of
Pacific Consultants International and
Yamashita Seikel Inc.

Subcontracted Local Consultant:
consolidated consultants
ENGINEERING & ENVIRONMENT
Tel: 0112377 - Fax: 0112380 - 10000 - 20000

Drawing Title:
CROSS-SECTION
9+400

Scale: H 1:400 Drawing No.: 383
V 1:200

NOTES :

- * FOR EXACT HEIGHTS AND DIMENSIONS OF BENCHES SEE TYPICAL ROAD CROSS-SECTION .
- * SLOPE H : V .

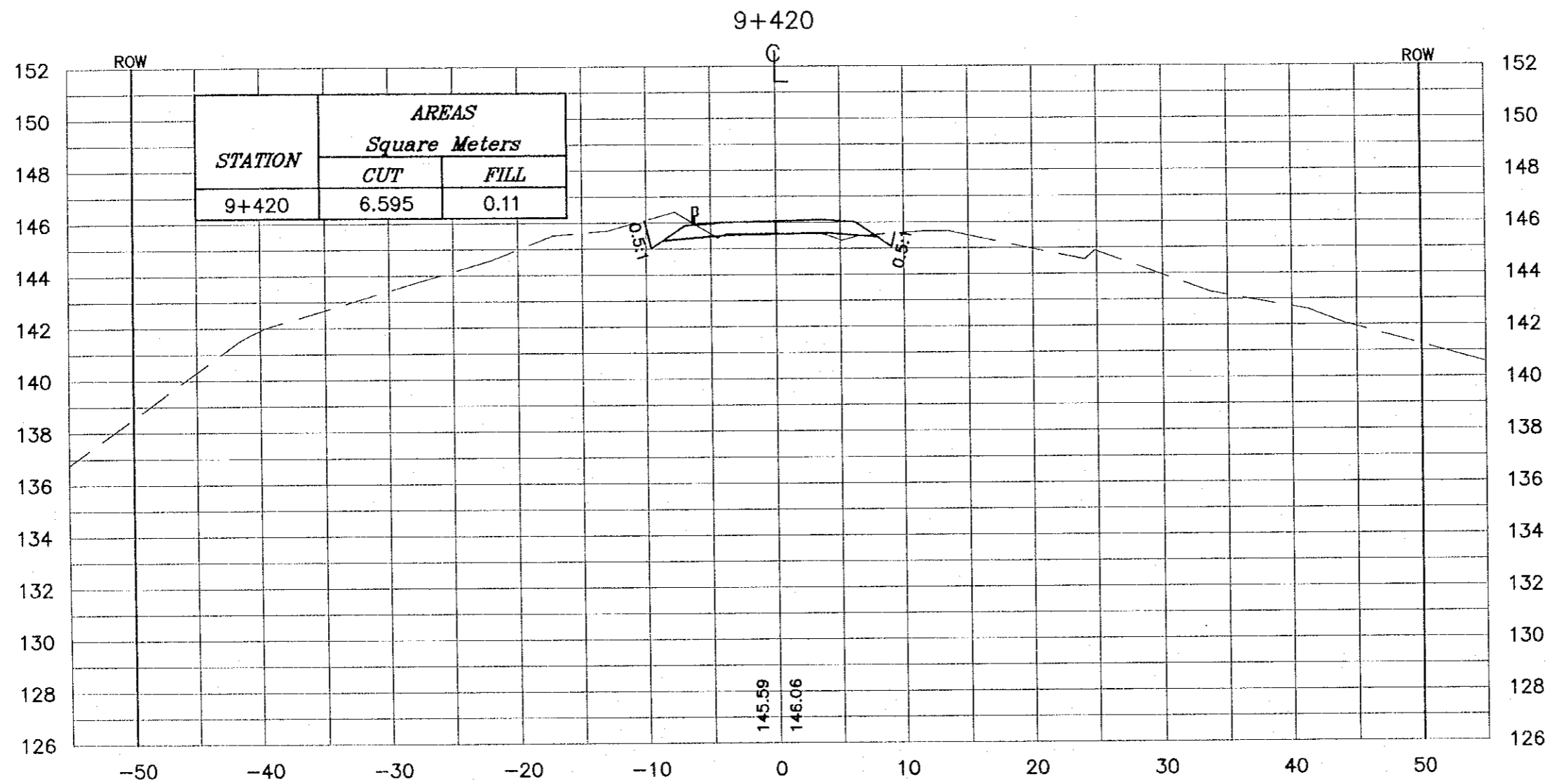

Project:
Tourism Sector Development Project
in the Hashemite Kingdom of Jordan

Executing Agency:
The Ministry of Tourism and Antiquities
The Ministry of Planning

SUB-PROJECT:
Dead Sea Parkway

Note:
This detailed design has been executed by a team of consultants as shown below in accordance with the agreement between Japan International Cooperation Agency (JICA) and JICA Study Team. The copyright of this drawing rests with JICA.

Designed by:
Japan International Cooperation Agency (JICA)

JICA Study Team:
Joint Venture of
Pacific Consultants International and
Yamashita Sekitri Inc.

Subcontracted Local Consultant:

consolidated consultants
Engineering & Environment
Tel: 952577 - Fax: 952589 - 952591 - 200001

Drawing Title:
CROSS-SECTION
9+420

Scale: H 1:400 V 1:200 **Drawing No.:** 384

NOTES :
 * FOR EXACT HEIGHTS AND DIMENSIONS OF BENCHES SEE TYPICAL ROAD CROSS-SECTION .
 * SLOPE H : V .

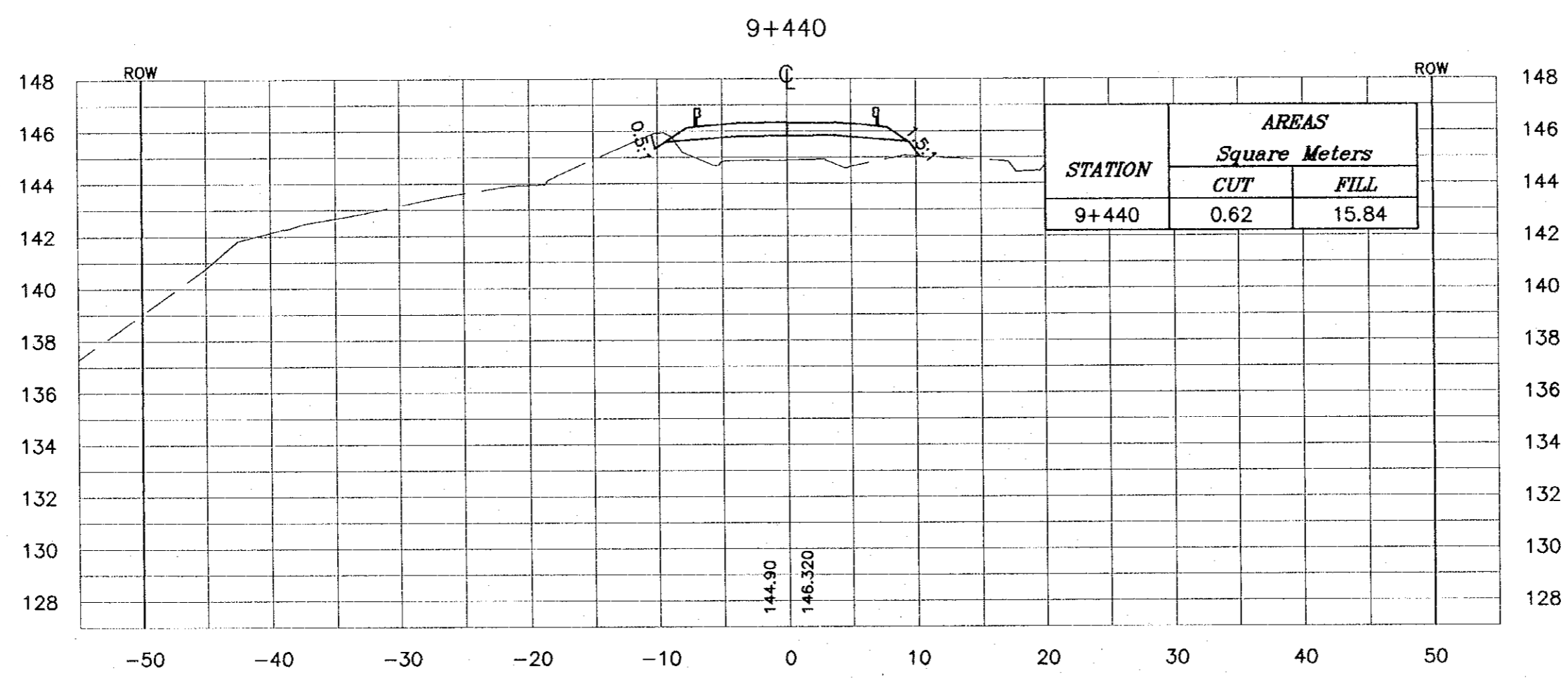

Project:
 Tourism Sector Development Project
 in the Hashemite Kingdom of Jordan

Executing Agency:
 The Ministry of Tourism and Antiquities
 The Ministry of Planning

SUB-PROJECT:
 Dead Sea Parkway

Note:
 This detailed design has been executed by a team of consultants as shown below in accordance with the agreement between Japan International Cooperation Agency (JICA) and JICA Study Team. The copyright of this drawing rests with JICA.

Designed by:
 Japan International Cooperation Agency (JICA)

JICA Study Team:
 Joint Venture of Pacific Consultants International and Yamashita Seikoku Inc.

Subcontracted Local Consultant:

 consolidated consultants
 Engineering & Environment
 Tel: 482377 - Fax: 481236 - AMMAN - JORDAN

Drawing Title:
 CROSS-SECTION
 9+440

Scale:
 H 1:400
 V 1:200

Drawing No.: 385

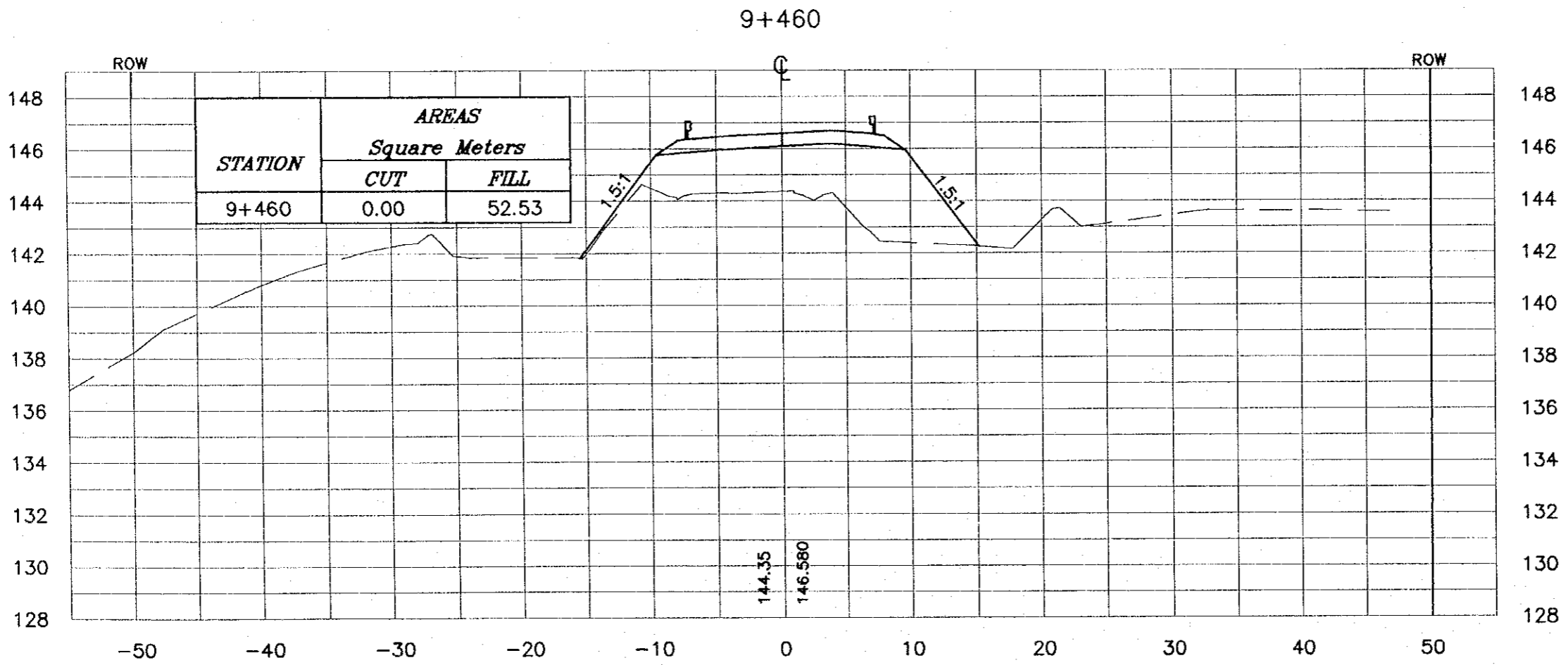
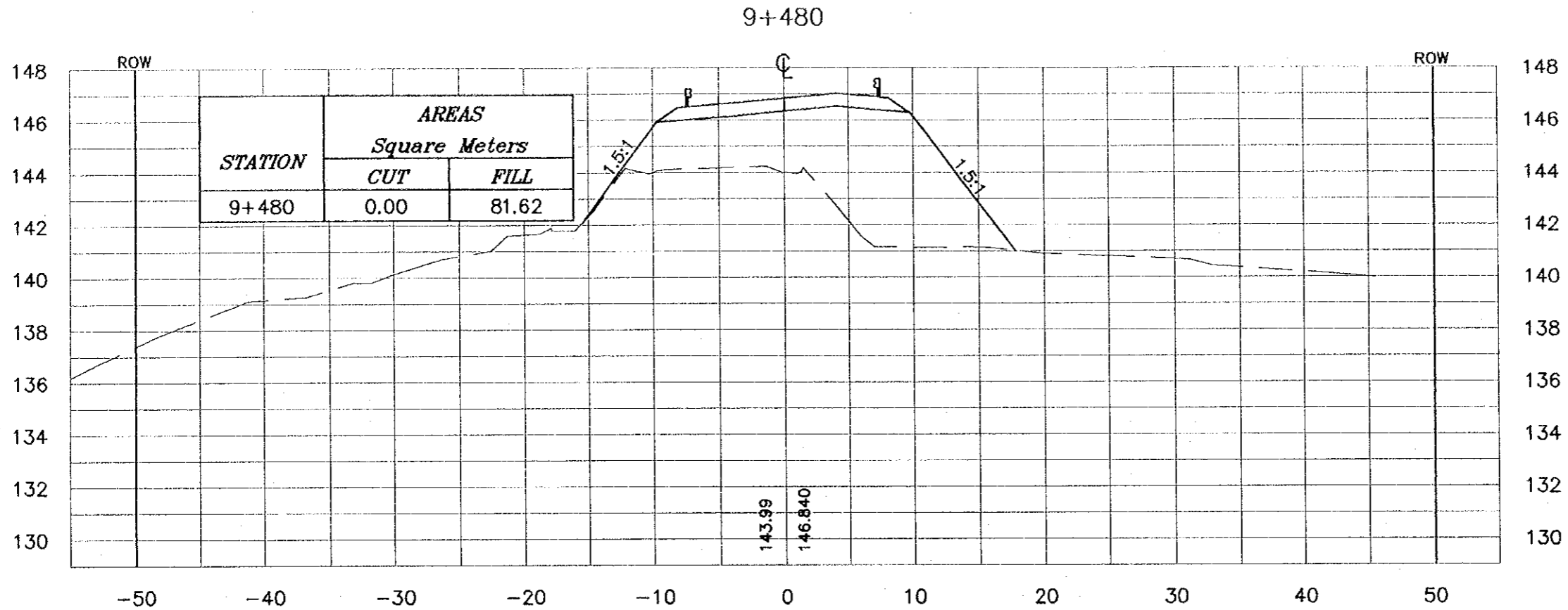

NOTES :

- * FOR EXACT HEIGHTS AND DIMENSIONS OF BENCHES SEE TYPICAL ROAD CROSS-SECTION .
- * SLOPE H : V .

Project:
Tourism Sector Development Project
in the Hashemite Kingdom of Jordan

Executing Agency:
The Ministry of Tourism and Antiquities
The Ministry of Planning

SUB-PROJECT:
Dead Sea Parkway

Note:
This detailed design has been executed by a team of consultants as shown below in accordance with the agreement between Japan International Cooperation Agency (JICA) and JICA Study Team. The copyright of this drawing rests with JICA.

Designed by:
Japan International Cooperation Agency (JICA)

JICA Study Team:
Joint Venture of
Pacific Consultants International and
Yamashita Sekkei Inc.

Subcontracted Local Consultant:
 consolidated consultants
Engineering & Environment
Tel: 4912177 - Fax: 4912288 - 499888 - 20028

Drawing Title:
CROSS-SECTION
(9+460-9+480)

Scale: H: 1:400 V: 1:200 **Drawing No.:** 386

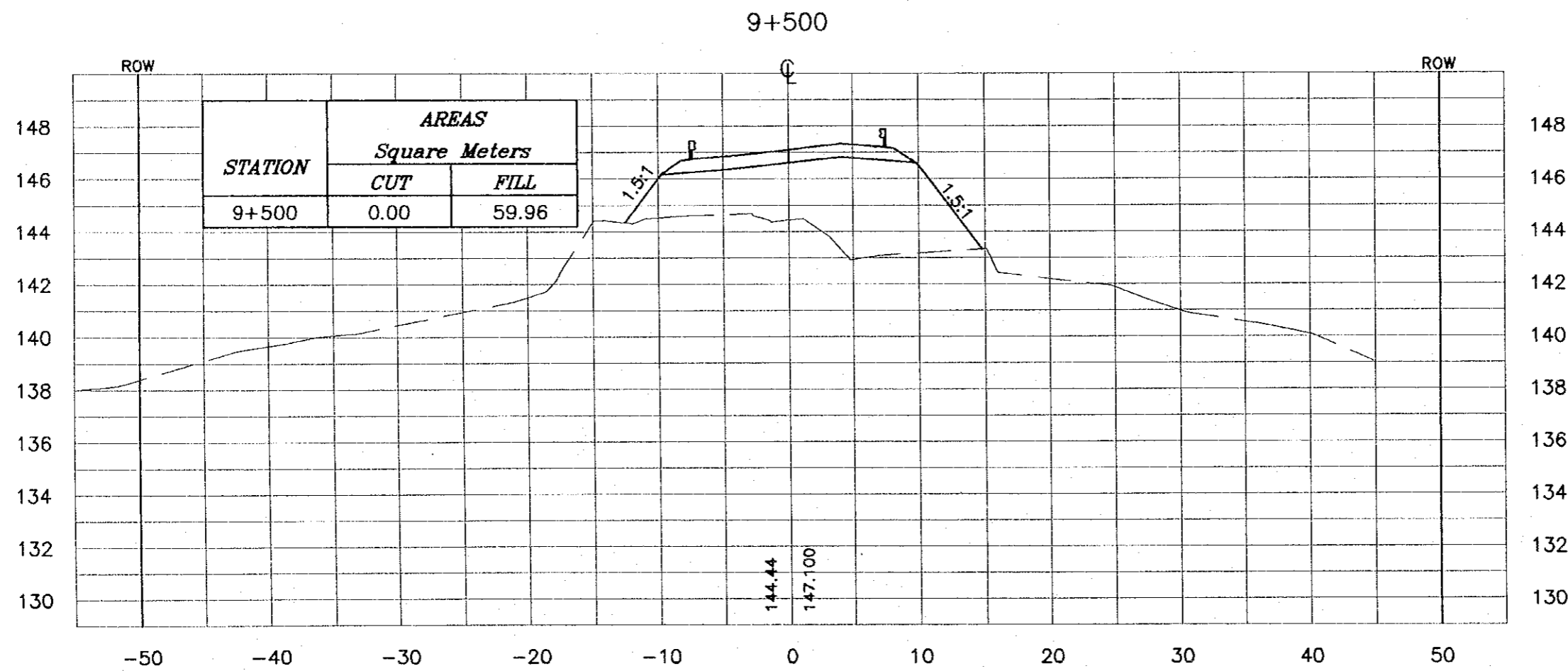
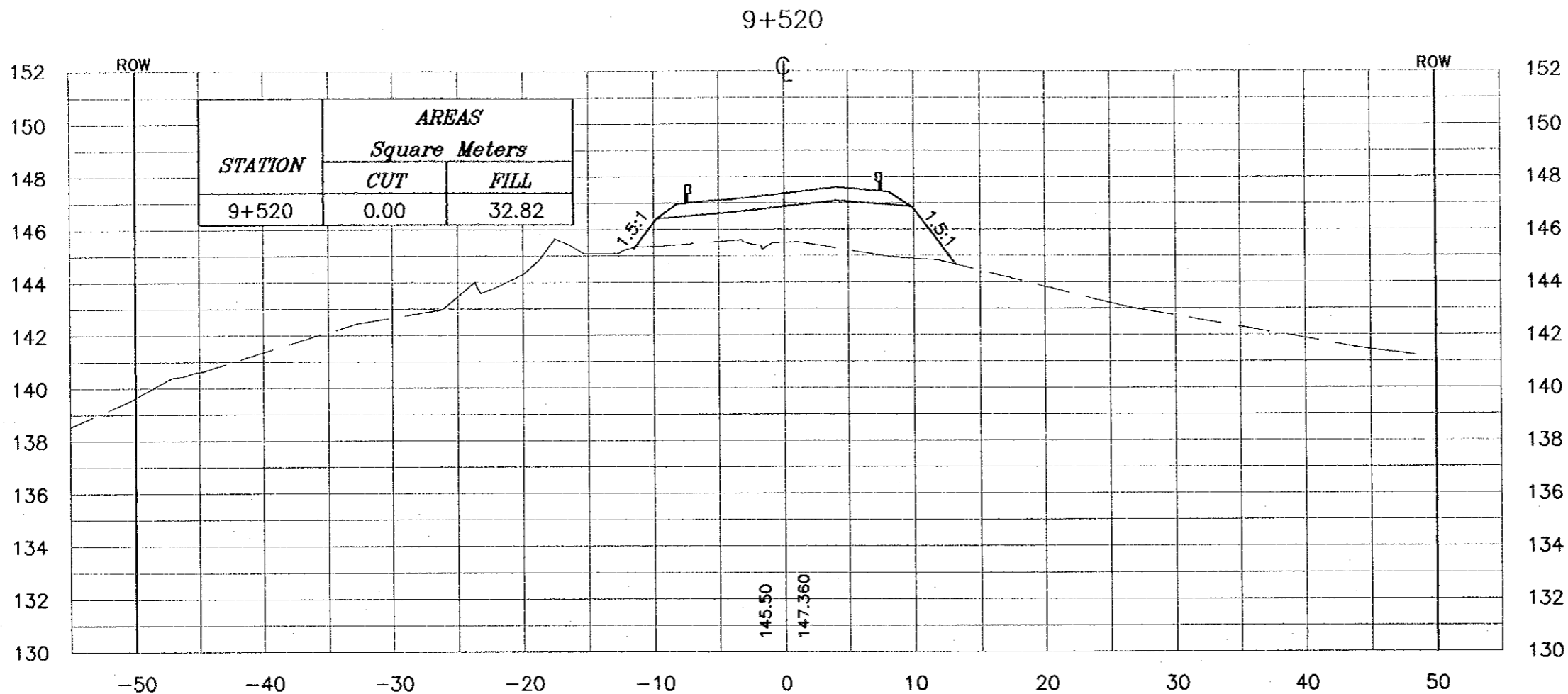

NOTES :

- * FOR EXACT HEIGHTS AND DIMENSIONS OF BENCHES SEE TYPICAL ROAD CROSS-SECTION .
- * SLOPE H : V .

Project:
Tourism Sector Development Project
in the Hashemite Kingdom of Jordan

Executing Agency:
The Ministry of Tourism and Antiquities
The Ministry of Planning

SUB-PROJECT:
Dead Sea Parkway

Note:
This detailed design has been executed by a team of consultants as shown below in accordance with the agreement between Japan International Cooperation Agency (JICA) and JICA Study Team. The copyright of this drawing rests with JICA.

Designed by:
Japan International Cooperation Agency (JICA)

JICA Study Team:
Joint Venture of
Pacific Consultants International and
Yamashita Sekkei Inc.

Subcontracted Local Consultant:
 consolidated consultants
engineering & environment
Tel: 4612377 - Fax: 4612388 - JORDAN - JORDAN

Drawing Title:
CROSS-SECTION
(9+500-9+520)

Scale: H 1:400 V 1:200 **Drawing No.:** 387

NOTES :

- * FOR EXACT HEIGHTS AND DIMENSIONS OF BENCHES SEE TYPICAL ROAD CROSS-SECTION .
- * SLOPE H : V .

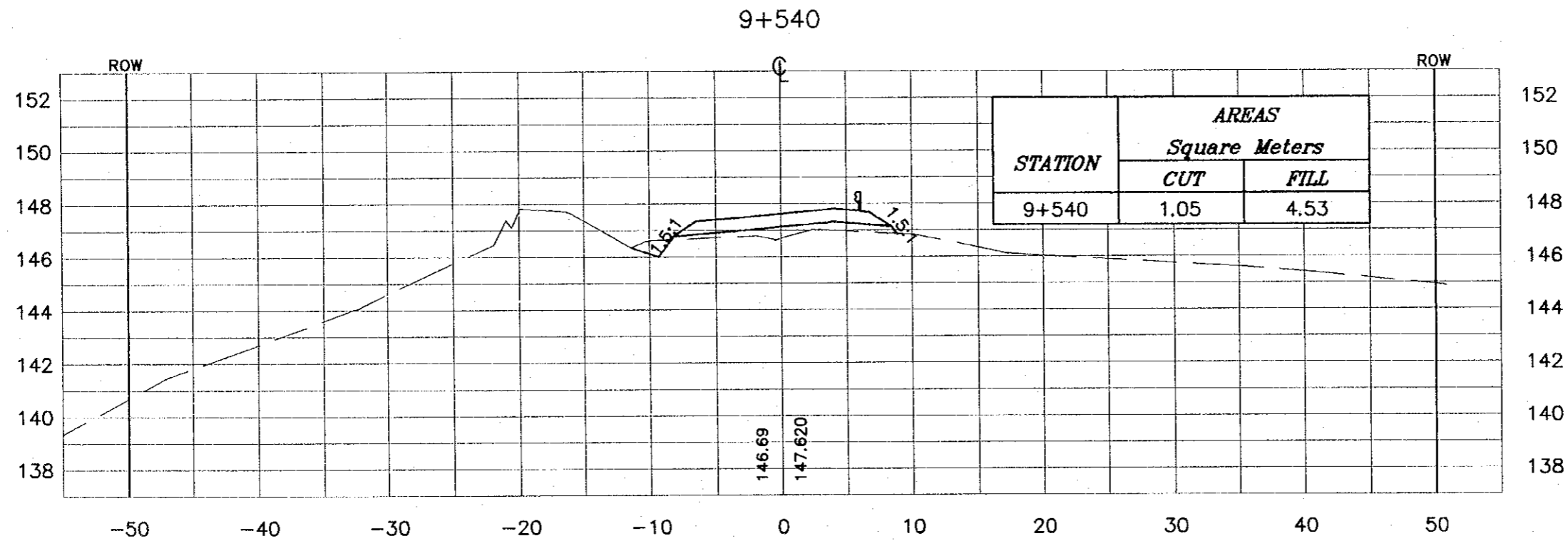

Project:
Tourism Sector Development Project
in the Hashemite Kingdom of Jordan

Executing Agency:
The Ministry of Tourism and Antiquities
The Ministry of Planning

SUB-PROJECT:
Dead Sea Parkway

Note:
This detailed design has been executed by a team of consultants as shown below in accordance with the agreement between Japan International Cooperation Agency (JICA) and JICA Study Team. The copyright of this drawing rests with JICA.

Designed by:
Japan International Cooperation Agency (JICA)

JICA Study Team:
Jakti Venture of Pacific Consultants International and Yamashita Sekkei Inc.

Subcontracted Local Consultant:
 consolidated consultants
Engineering & Environment
Tel: 4612377 - Fax: 4612380 - Amman - JORDAN

Drawing Title:
CROSS-SECTION
9+540

Scale: H 1:400 V 1:200 **Drawing No.:** 388

NOTES :

- * FOR EXACT HEIGHTS AND DIMENSIONS OF BENCHES SEE TYPICAL ROAD CROSS-SECTION .
- * SLOPE H : V .

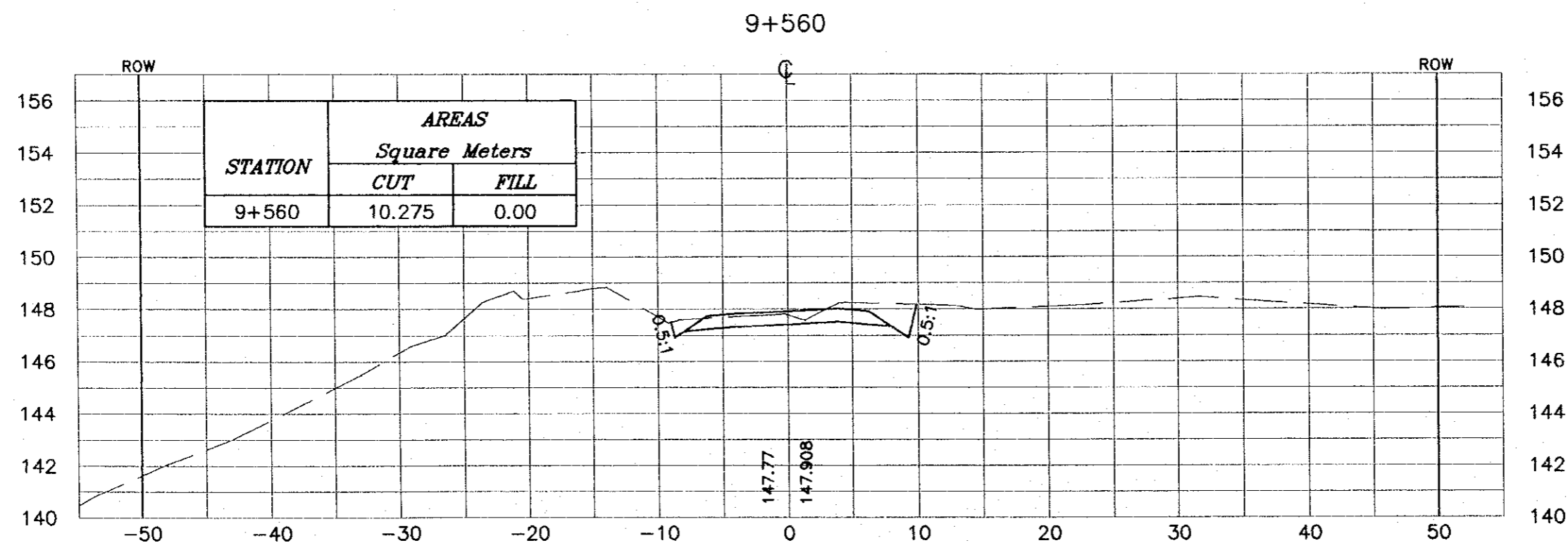
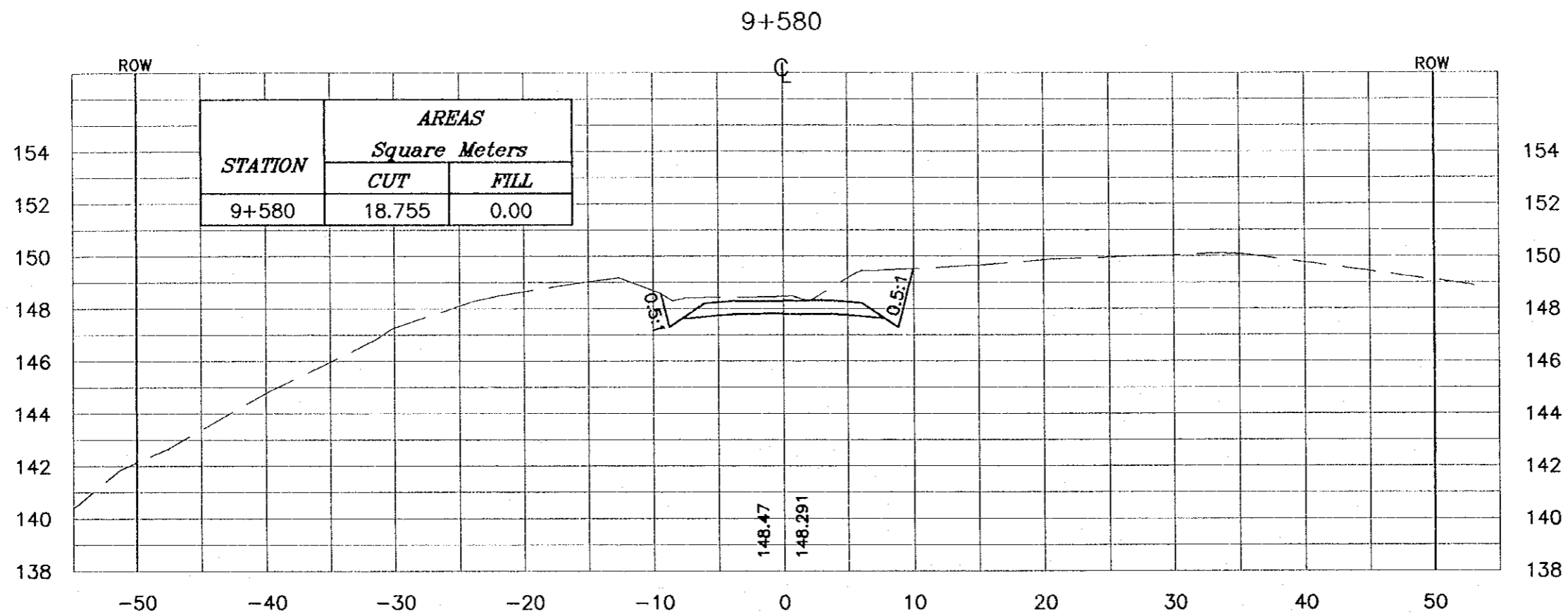

Project:
Tourism Sector Development Project
in the Hashemite Kingdom of Jordan

Executing Agency:
The Ministry of Tourism and Antiquities
The Ministry of Planning

SUB-PROJECT:
Dead Sea Parkway

Note:
This detailed design has been executed by a team of consultants as shown below in accordance with the agreement between Japan International Cooperation Agency (JICA) and JICA Study Team. The copyright of this drawing rests with JICA.

Designed by:
Japan International Cooperation Agency (JICA)

JICA Study Team:
Joint Venture of Pacific Consultants International and Yamashita Sekkei Inc.

Subcontracted Local Consultant:
 consolidated consultants
engineering & environment
Tel: 962277 - Fax: 962266 - Amman - Jordan

Drawing Title:
CROSS-SECTION
(9+560-9+580)

Scales: H: 1:400 Drawing No.: 389
V: 1:200

NOTES :

- * FOR EXACT HEIGHTS AND DIMENSIONS OF BENCHES SEE TYPICAL ROAD CROSS-SECTION .
- * SLOPE H : V .

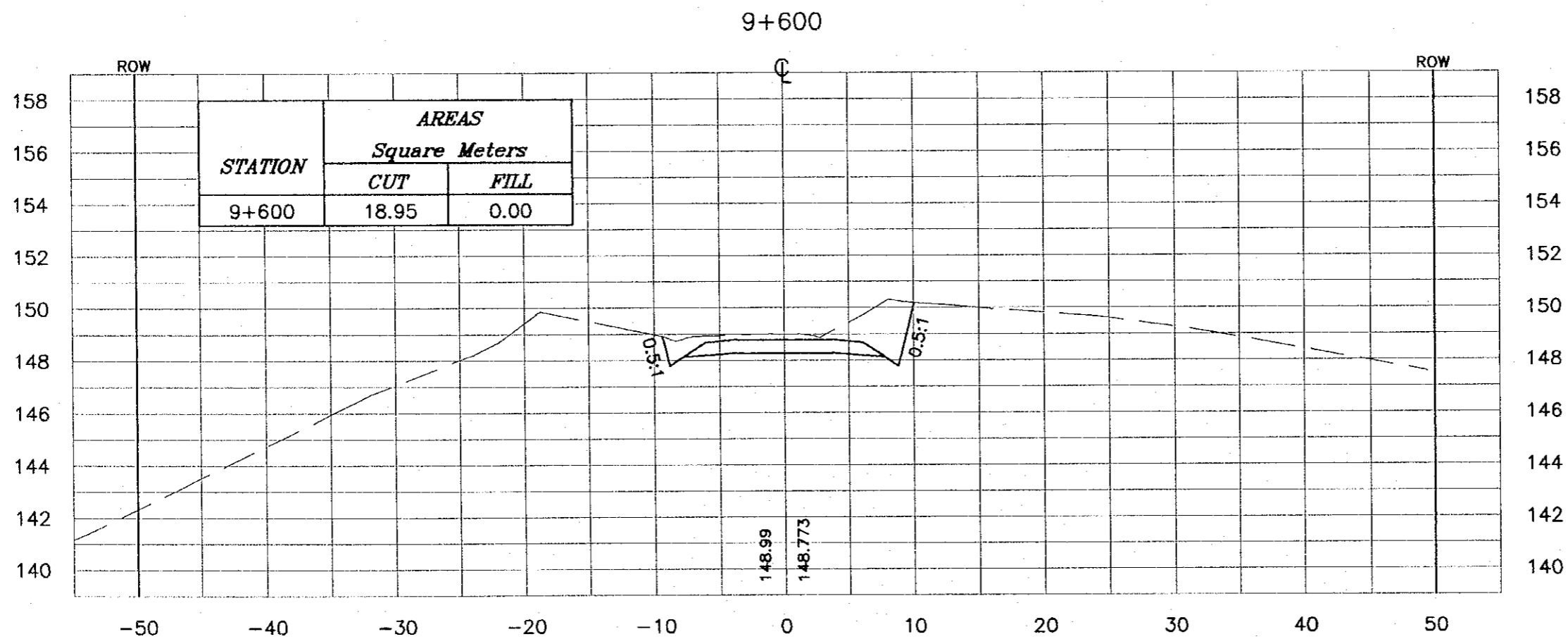
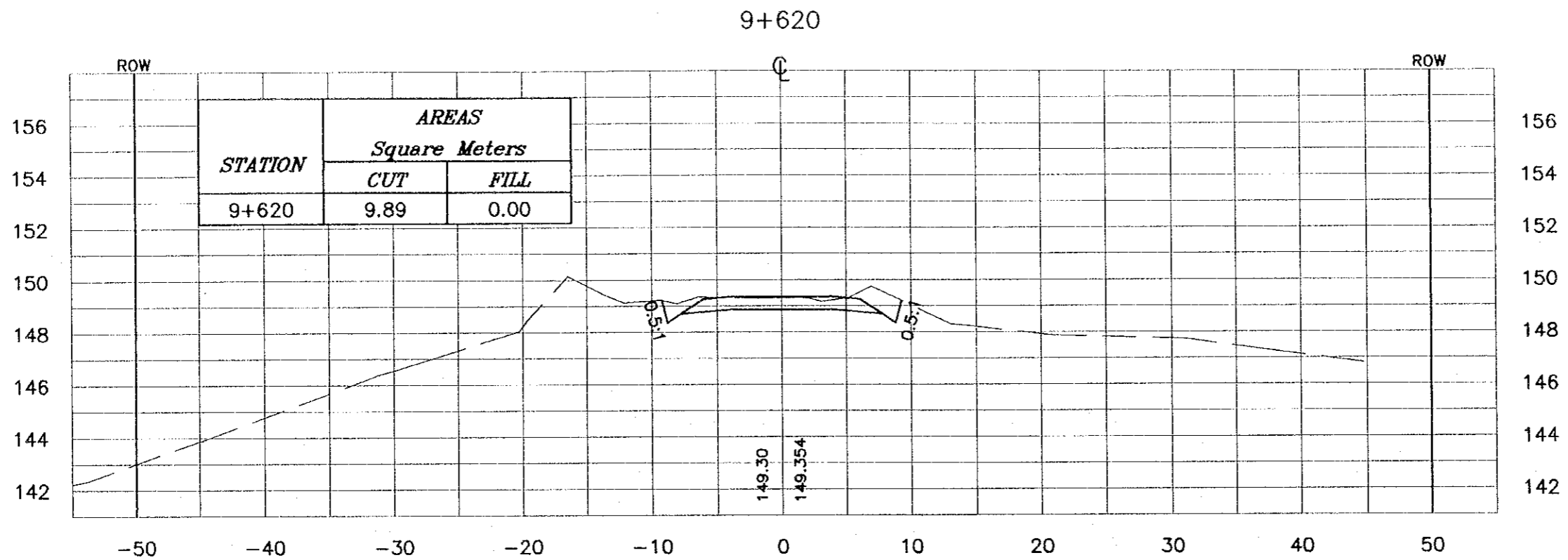

Project:
Tourism Sector Development Project
in the Hashemite Kingdom of Jordan

Executing Agency:
The Ministry of Tourism and Antiquities
The Ministry of Planning

SUB-PROJECT:
Dead Sea Parkway

Note:
This detailed design has been executed by
a team of consultants as shown below in
accordance with the agreement between
Japan International Cooperation Agency
(JICA) and JICA Study Team.
The copyright of this drawing rests with JICA.

Designed by:
Japan International Cooperation
Agency (JICA)

JICA Study Team:
Joint Venture of
Pacific Consultants International and
Yamashita Sekkel Inc.

Subcontracted Local Consultant:
consolidated consultants
engineering & environmental
Tel: 4612377 - Fax: 4612399 - JARJAL - 200201

Drawing Title:
CROSS-SECTION
(9+600-9+620)

Scale: H 1:400 V 1:200 Drawing No.: 390

NOTES :

* FOR EXACT HEIGHTS AND DIMENSIONS OF BENCHES SEE TYPICAL ROAD CROSS-SECTION .

* SLOPE H : V .

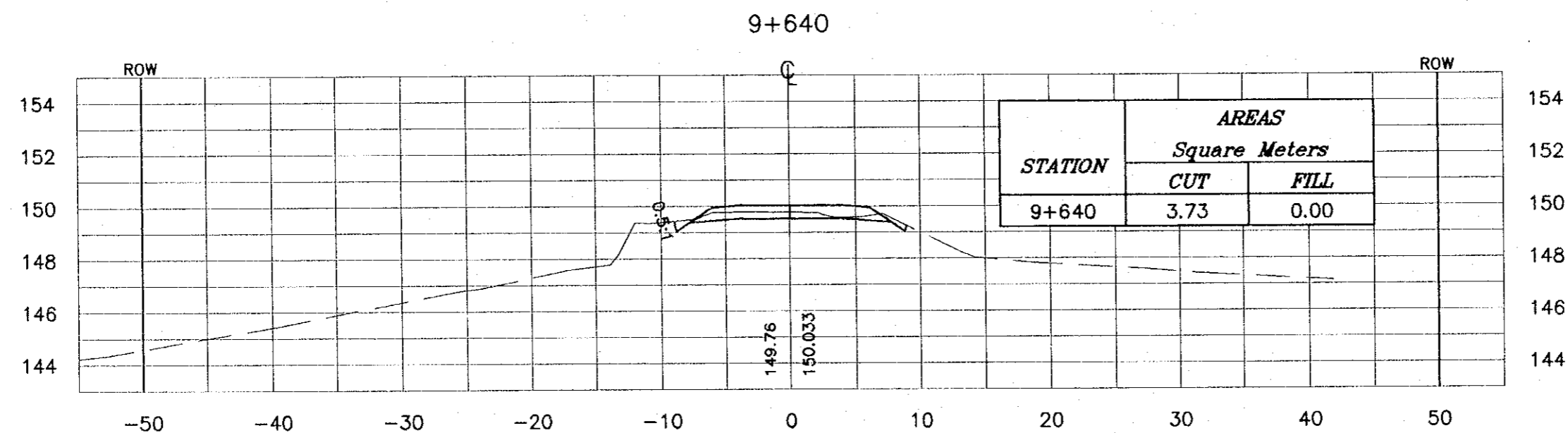
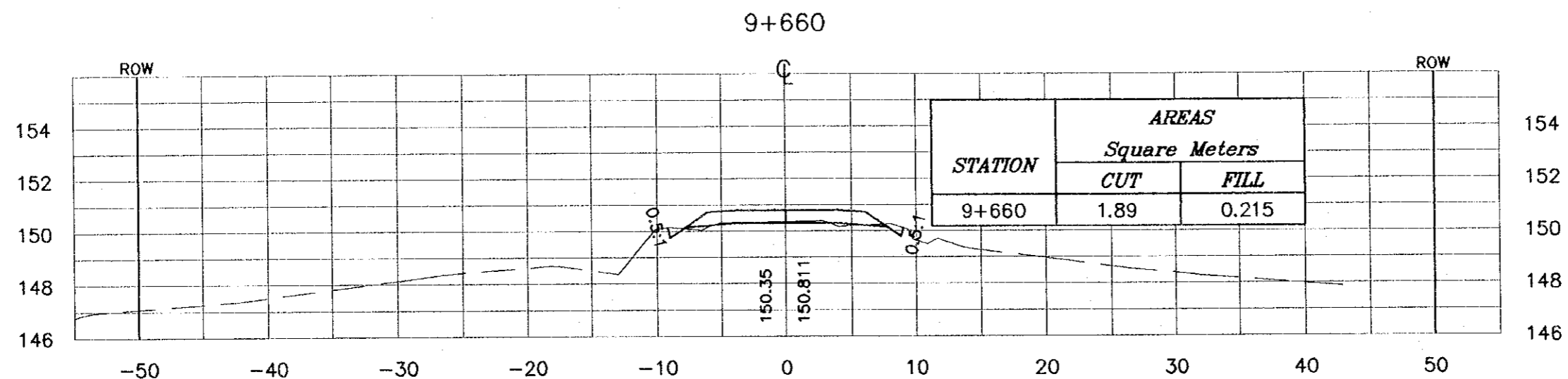

Project:
Tourism Sector Development Project
in the Hashemite Kingdom of Jordan

Executing Agency:
The Ministry of Tourism and Antiquities
The Ministry of Planning

SUB-PROJECT:
Dead Sea Parkway

Note:
This detailed design has been executed by a team of consultants as shown below in accordance with the agreement between Japan International Cooperation Agency (JICA) and JICA Study Team. The copyright of this drawing rests with JICA.

Designed by:
Japan International Cooperation Agency (JICA)

JICA Study Team:
Joint Venture of
Pacific Consultants International and
Yamashita Sekkei Inc.

Subcontracted Local Consultant:



Drawing Title:
CROSS-SECTION
(9+640-9+660)

Scale: H 1:400 V 1:200 **Drawing No.:** 391

NOTES :

- * FOR EXACT HEIGHTS AND DIMENSIONS OF BENCHES SEE TYPICAL ROAD CROSS-SECTION .
- * SLOPE H : V .

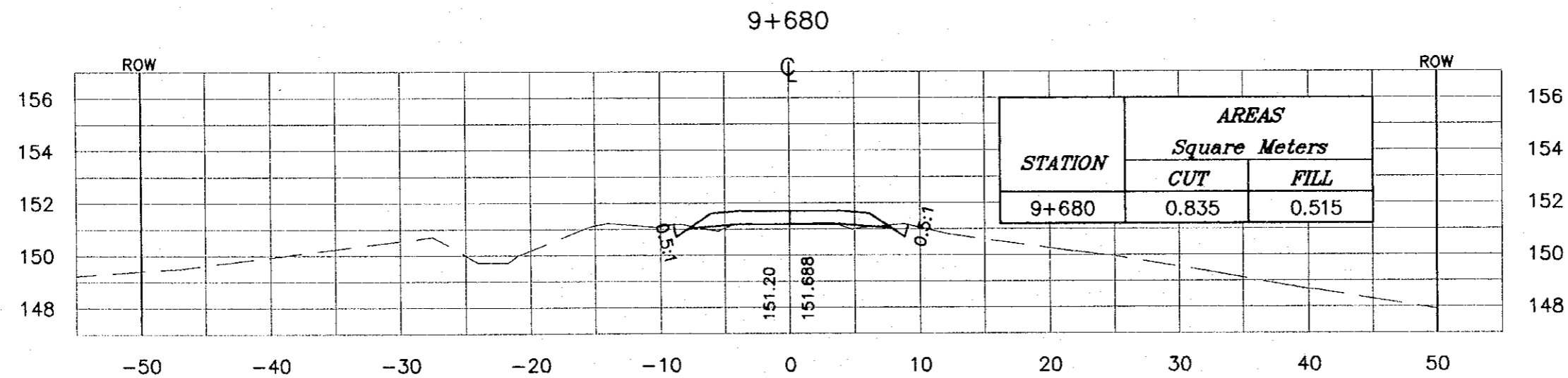
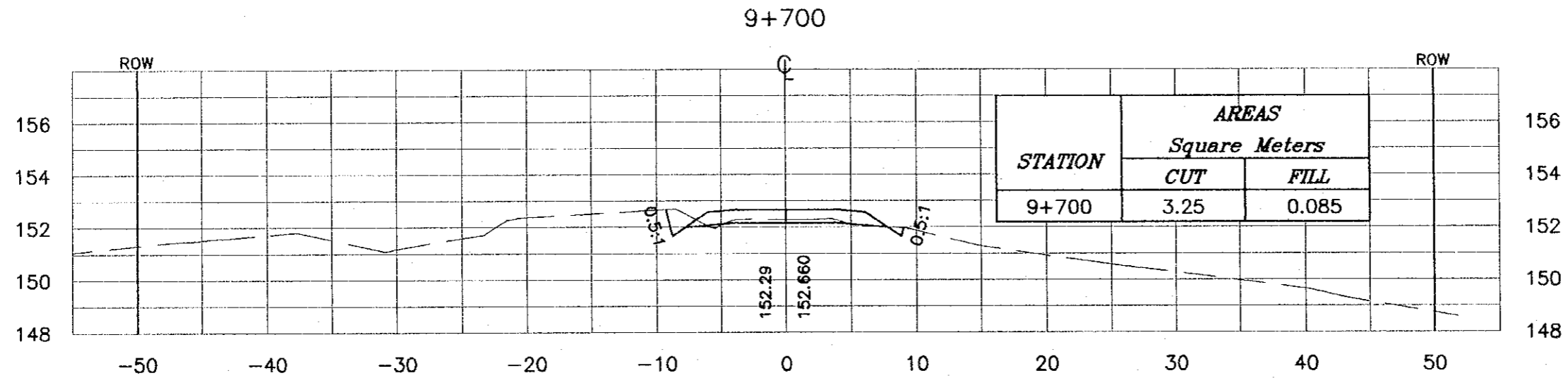

Project:
Tourism Sector Development Project
in the Hashemite Kingdom of Jordan

Executing Agency:
The Ministry of Tourism and Antiquities
The Ministry of Planning

SUB-PROJECT:
Dead Sea Parkway

Note:
This detailed design has been executed by a team of consultants as shown below in accordance with the agreement between Japan International Cooperation Agency (JICA) and JICA Study Team. The copyright of this drawing rests with JICA.

Designed by:
Japan International Cooperation Agency (JICA)

JICA Study Team:
Joint Venture of
Pacific Consultants International and
Yamashita Sekkei Inc.

Subcontracted Local Consultant:
 consolidated consultants
Engineering & Environment
Tel: 4112371 - Fax: 4112380 - JORDAN - AMMAN

Drawing Title:
CROSS-SECTION
(9+680-9+700)

Scale: H: 1:400 V: 1:200 **Drawing No.:** 392

NOTES :

- * FOR EXACT HEIGHTS AND DIMENSIONS OF BENCHES SEE TYPICAL ROAD CROSS-SECTION .
- * SLOPE H : V .

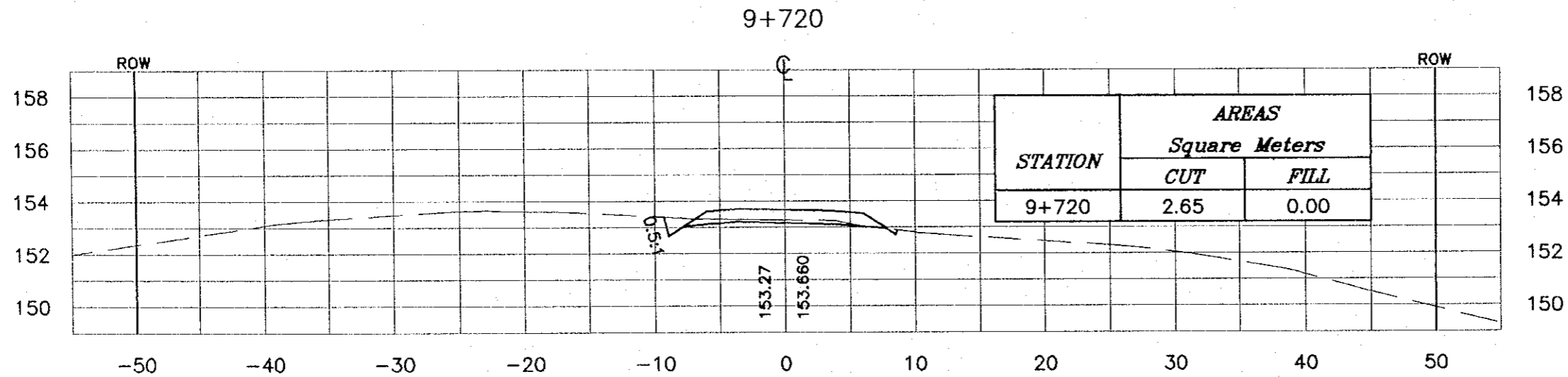
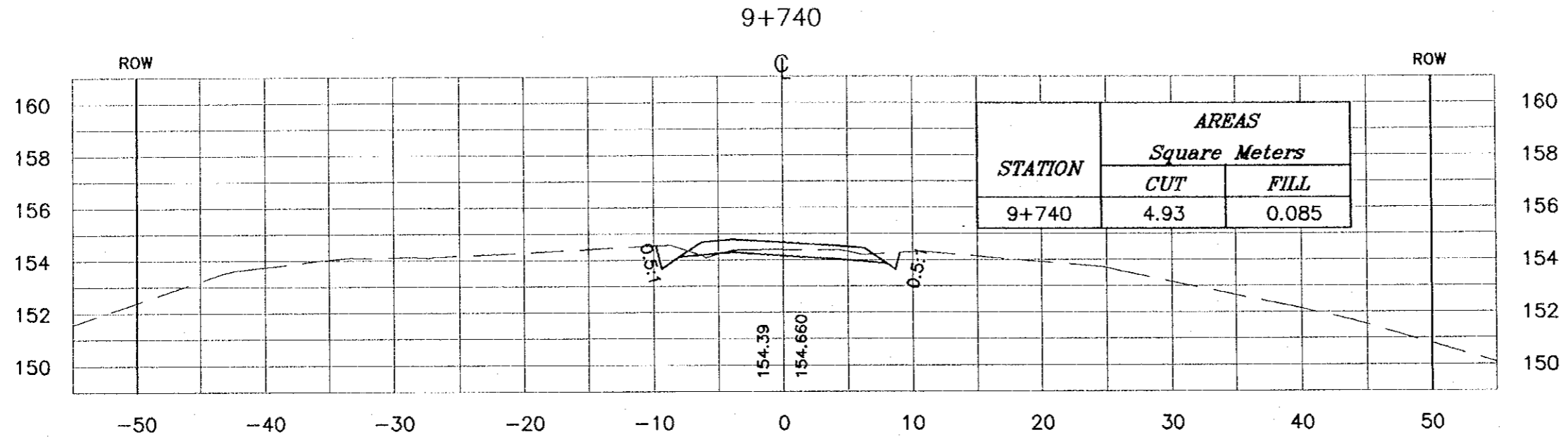

Project:
Tourism Sector Development Project
in the Hashemite Kingdom of Jordan

Executing Agency:
The Ministry of Tourism and Antiquities
The Ministry of Planning

SUB-PROJECT:
Dead Sea Parkway

Note:
This detailed design has been executed by
a team of consultants as shown below in
accordance with the agreement between
Japan International Cooperation Agency
(JICA) and JICA Study Team.
The copyright of this drawing rests with JICA.

Designed by:
Japan International Cooperation
Agency (JICA)

JICA Study Team:
Joint Venture of
Pacific Consultants International and
Yamashita Sekkei Inc.

Subcontracted Local Consultant:
 consolidated consultants
engineering & environment
Tel: 952377 - Fax: 952388 - 98994 - 20004

Drawing Title:
CROSS-SECTION
(9+720-9+740)

Scale: 1:400 **Drawing No.:** 393
V 1:200

NOTES :

- * FOR EXACT HEIGHTS AND DIMENSIONS OF BENCHES SEE TYPICAL ROAD CROSS-SECTION .
- * SLOPE H : V .

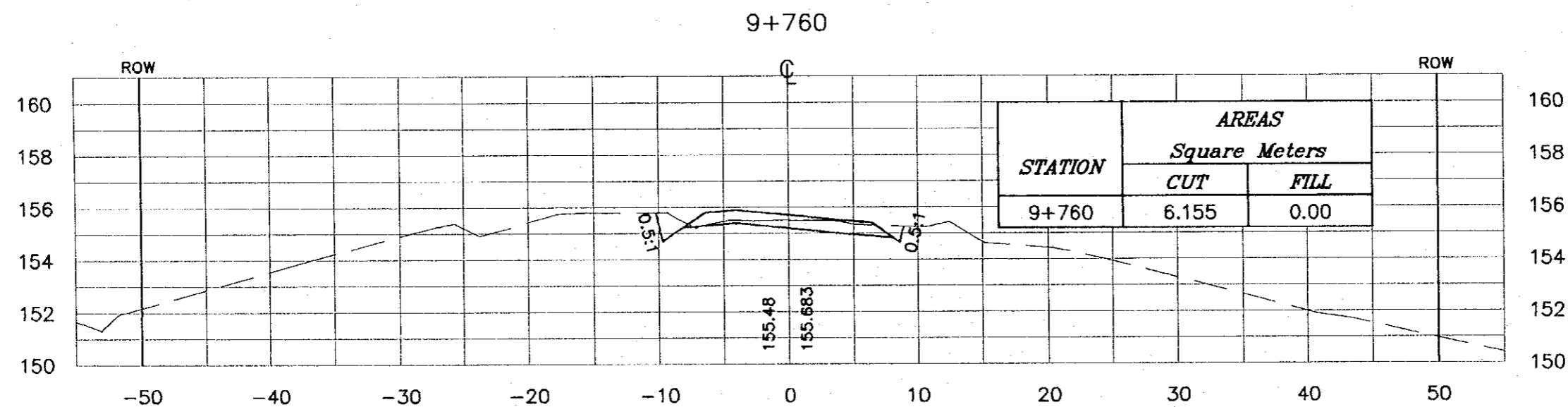
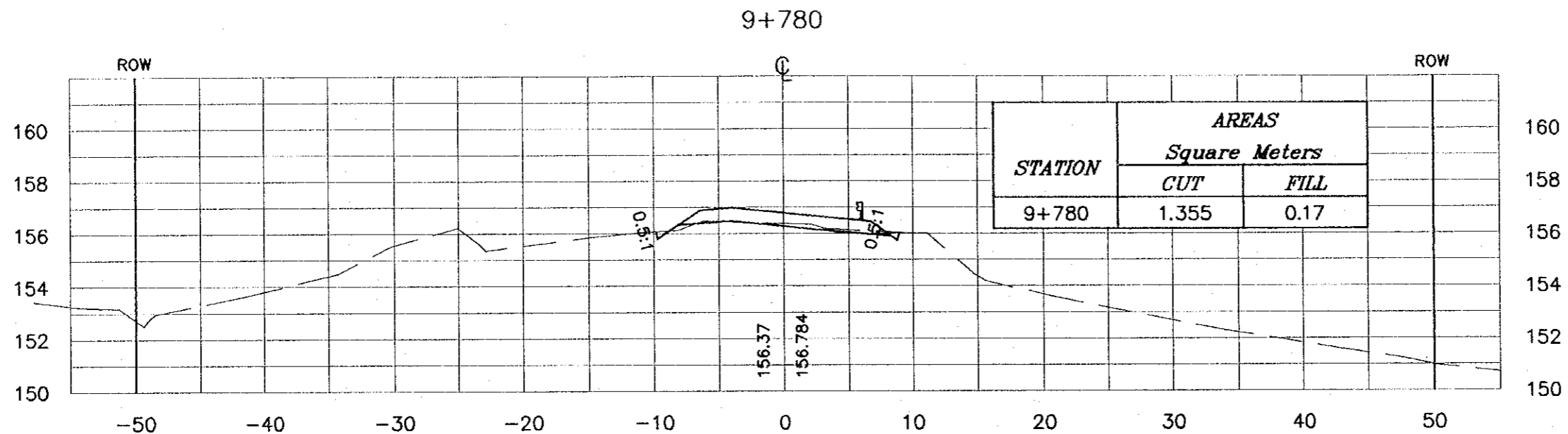

Project:
Tourism Sector Development Project
in the Hashemite Kingdom of Jordan

Executing Agency:
The Ministry of Tourism and Antiquities
The Ministry of Planning

SUB-PROJECT:
Dead Sea Parkway

Note:
This detailed design has been executed by a team of consultants as shown below in accordance with the agreement between Japan International Cooperation Agency (JICA) and JICA Study Team. The copyright of this drawing rests with JICA.

Designed by:
Japan International Cooperation Agency (JICA)

JICA Study Team:
Joint Venture of Pacific Consultants International and Yamashita Sekkei Inc.

Subcontracted Local Consultant:
 consolidated consultants
Engineering & Environment
Tel: 412577 - Fax: 412588 - AMMAN - JORDAN

Drawing Title:
CROSS-SECTION
(9+760-9+780)

Scale: H 1:400 V 1:200 **Drawing No.:** 394

NOTES :

- * FOR EXACT HEIGHTS AND DIMENSIONS OF BENCHES SEE TYPICAL ROAD CROSS-SECTION .
- * SLOPE H : V .

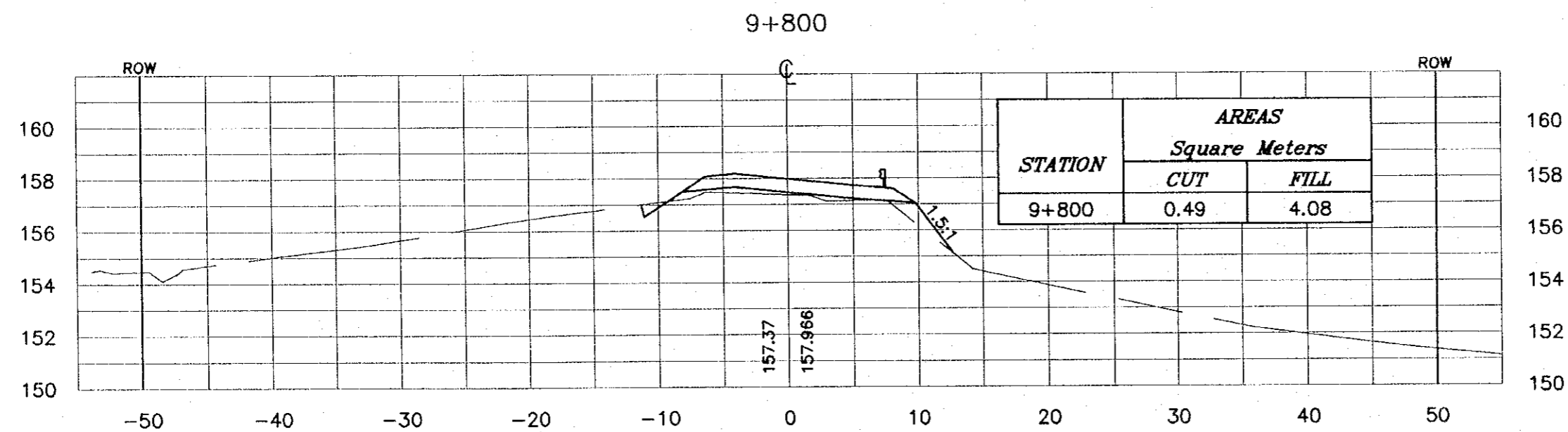
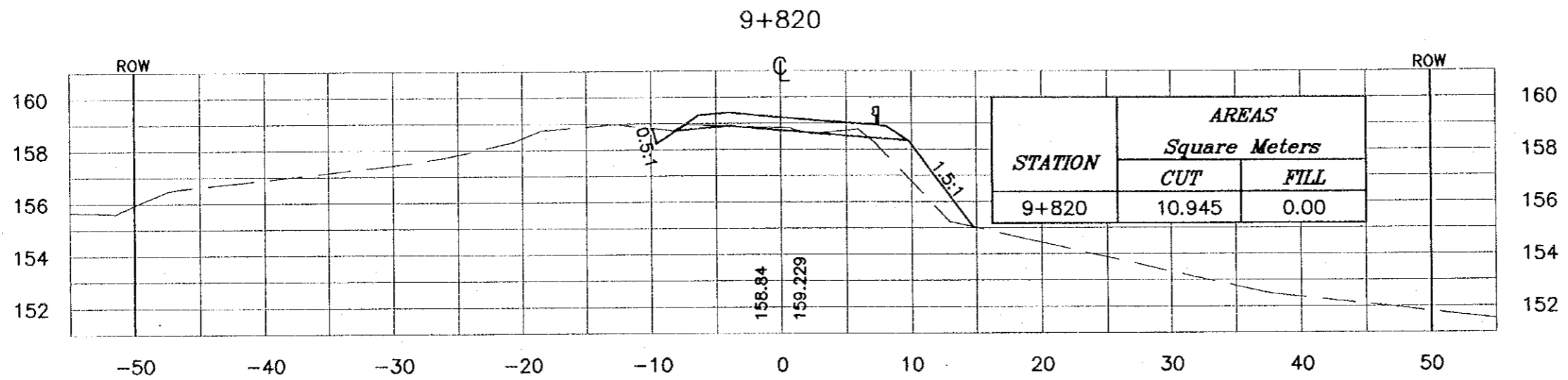

Project:
Tourism Sector Development Project
in the Hashemite Kingdom of Jordan

Executing Agency:
The Ministry of Tourism and Antiquities
The Ministry of Planning

SUB-PROJECT:
Dead Sea Parkway

Note:
This detailed design has been executed by a team of consultants as shown below in accordance with the agreement between Japan International Cooperation Agency (JICA) and JICA Study Team. The copyright of this drawing rests with JICA.

Designed by:
Japan International Cooperation Agency (JICA)

JICA Study Team:
Joint Venture of Pacific Consultants International and Yamashita Sekkel Inc.

Subcontracted Local Consultant:
 consolidated consultants
engineering & environment
Tel: 492377 - Fax: 491338 - AMM - JORDAN

Drawing Title:
CROSS-SECTION
(9+800-9+820)

Scale: H 1:400 V 1:200 **Drawing No.:** 395

NOTES :

- * FOR EXACT HEIGHTS AND DIMENSIONS OF BENCHES SEE TYPICAL ROAD CROSS-SECTION .
- * SLOPE H : V .

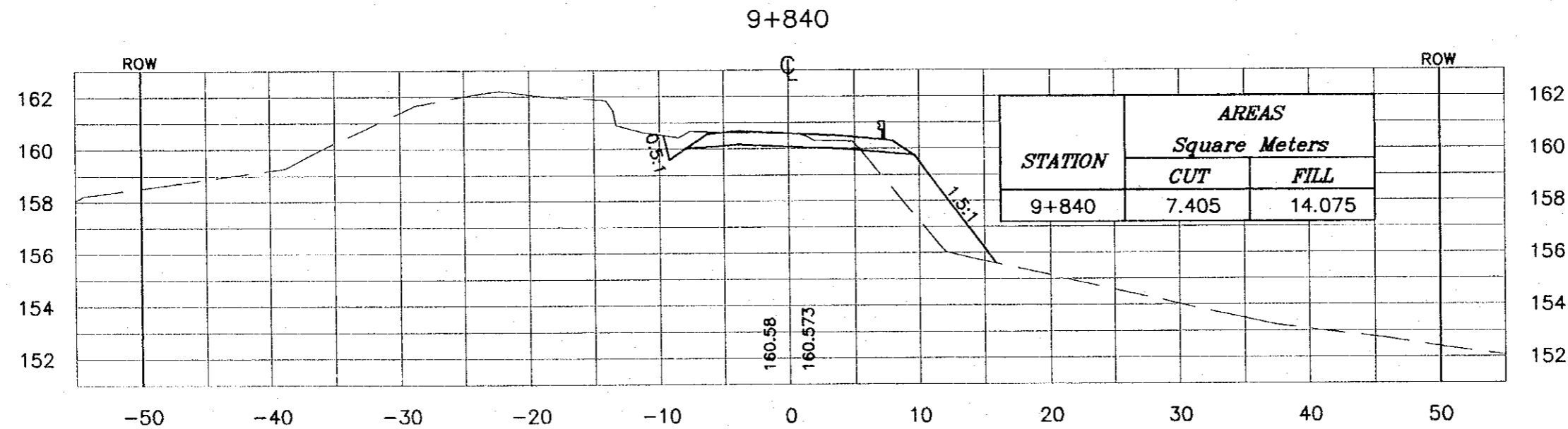
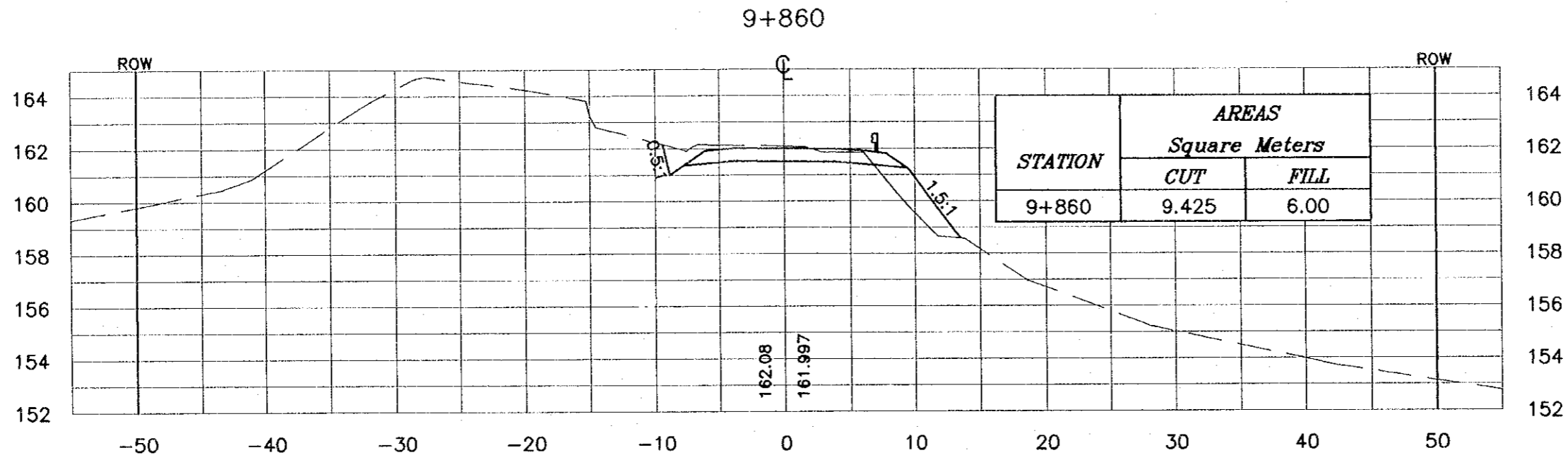

Project:
Tourism Sector Development Project
in the Hashemite Kingdom of Jordan

Executing Agency:
The Ministry of Tourism and Antiquities
The Ministry of Planning

SUB-PROJECT:
Dead Sea Parkway

Note:
This detailed design has been executed by
a team of consultants as shown below in
accordance with the agreement between
Japan International Cooperation Agency
(JICA) and JICA Study Team.
The copyright of this drawing rests with JICA.

Designed by:
Japan International Cooperation
Agency (JICA)

JICA Study Team:
Joint Venture of
Pacific Consultants International and
Yamashita Sekkei Inc.

Subcontracted Local Consultant:

consolidated consultants
Engineering & Environment
Tel: 011277 - Fax: 011280 - JORDAN

Drawing Title:
CROSS-SECTION
(9+840-9+860)

Scale: H 1:400 Drawing No.: 396
V 1:200

NOTES :

- * FOR EXACT HEIGHTS AND DIMENSIONS OF BENCHES SEE TYPICAL ROAD CROSS-SECTION .
- * SLOPE H : V .

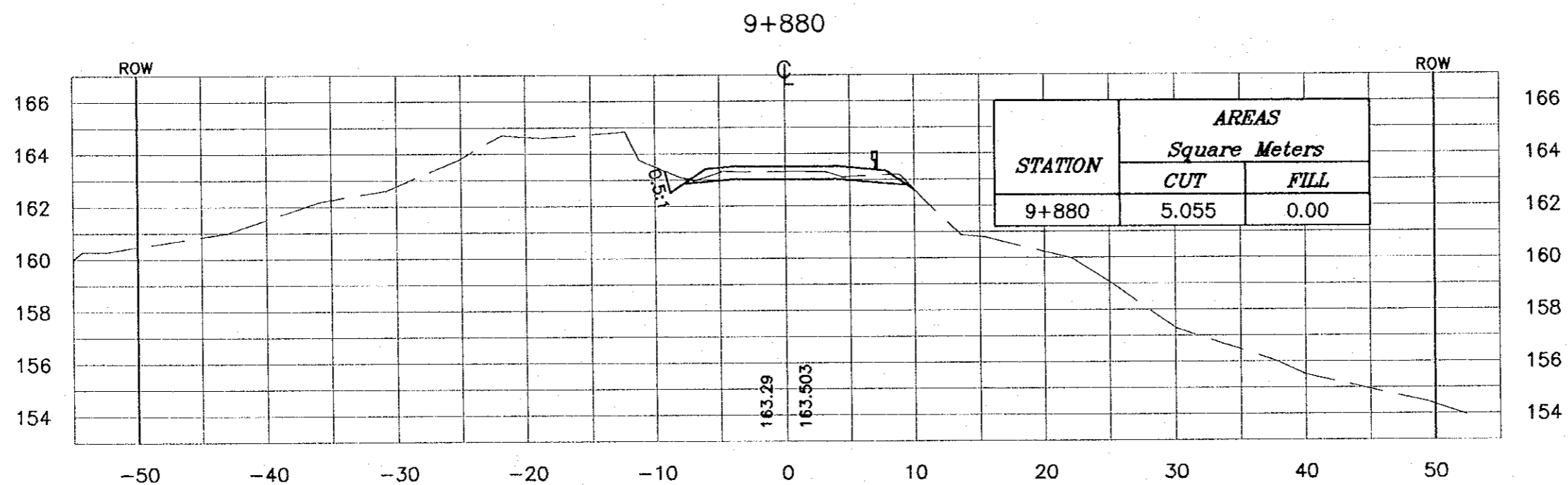
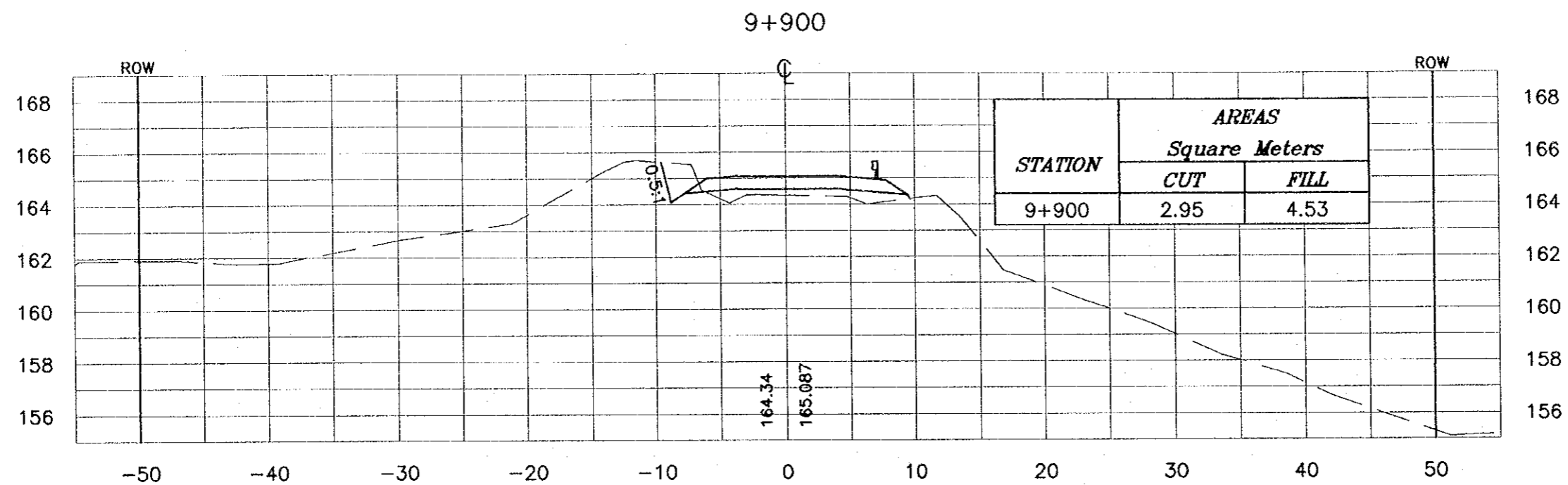

Project:
Tourism Sector Development Project
in the Hashemite Kingdom of Jordan

Executing Agency:
The Ministry of Tourism and Antiquities
The Ministry of Planning

SUB-PROJECT:
Dead Sea Parkway

Note:
This detailed design has been executed by a team of consultants as shown below in accordance with the agreement between Japan International Cooperation Agency (JICA) and JICA Study Team. The copyright of this drawing rests with JICA.

Designed by:
Japan International Cooperation Agency (JICA)

JICA Study Team:
Joint Venture of Pacific Consultants International and Yamashita Sekkei Inc.

Subcontracted Local Consultant:
 consolidated consultants
engineering & environment
Tel: 461277 - Fax: 461286 - AMMAN - JORDAN

Drawing Title:
CROSS-SECTION
(9+880-9+900)

Scale: 1:400 **Drawing No.:** 397
V 1:200

NOTES :

- * FOR EXACT HEIGHTS AND DIMENSIONS OF BENCHES SEE TYPICAL ROAD CROSS-SECTION .
- * SLOPE H : V .

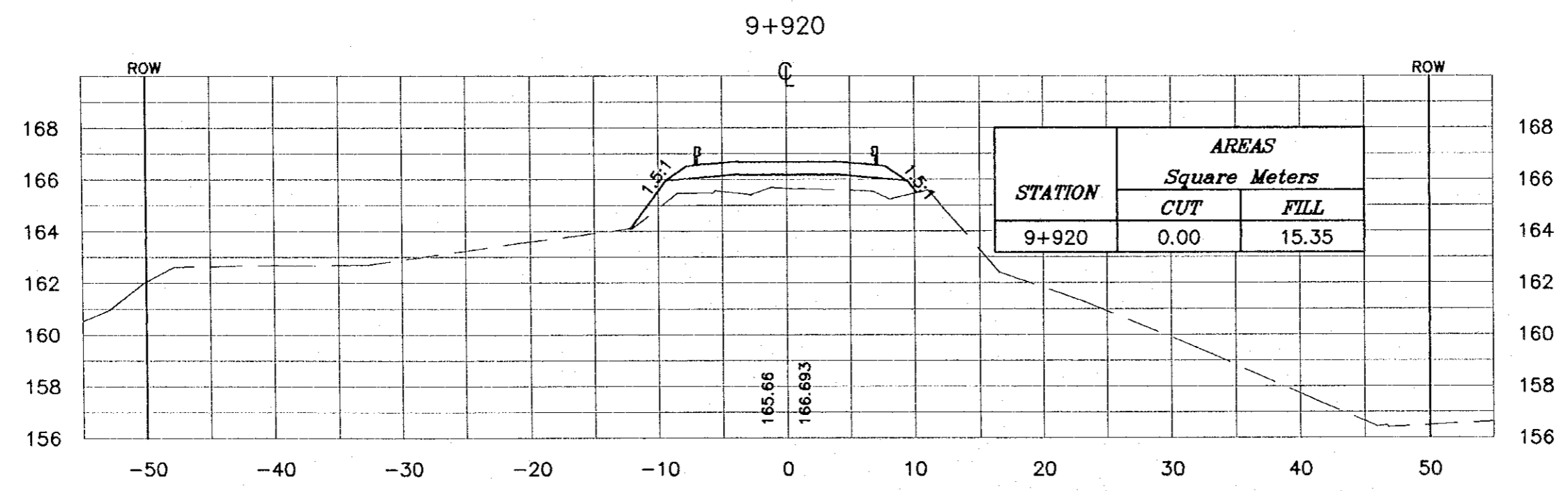
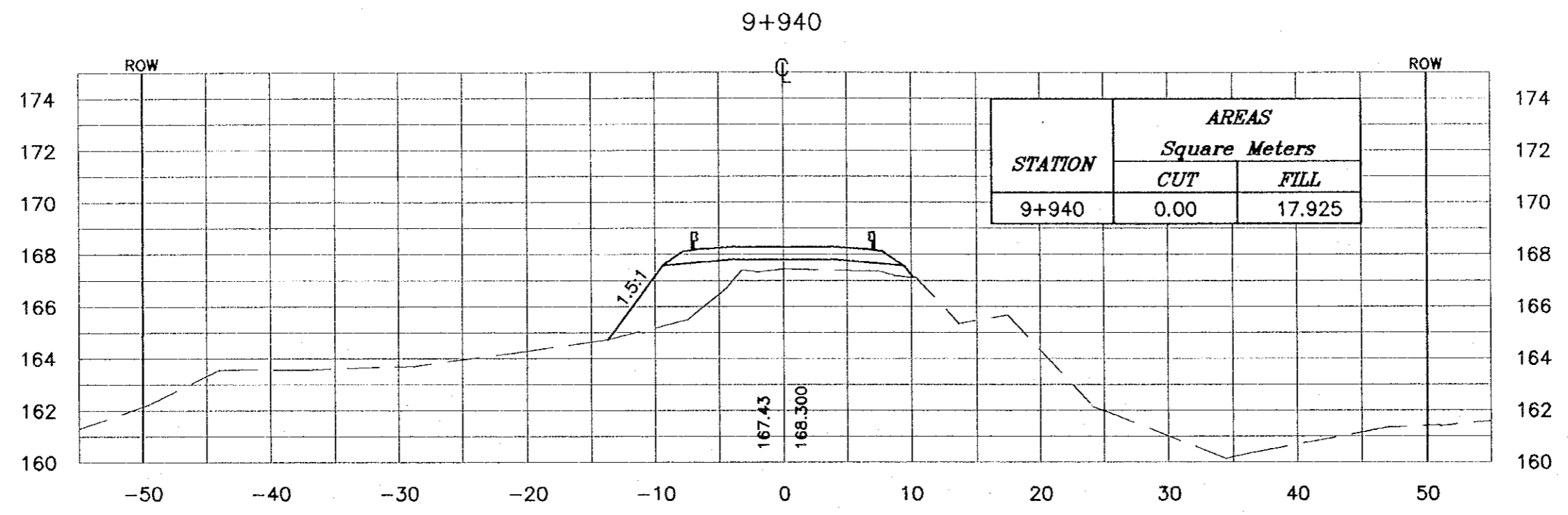

Project:
Tourism Sector Development Project
in the Hashemite Kingdom of Jordan

Executing Agency:
The Ministry of Tourism and Antiquities
The Ministry of Planning

SUB-PROJECT:
Dead Sea Parkway

Note:
This detailed design has been executed by a team of consultants as shown below in accordance with the agreement between Japan International Cooperation Agency (JICA) and JICA Study Team. The copyright of this drawing rests with JICA.

Designed by:
Japan International Cooperation Agency (JICA)

JICA Study Team:
Joint Venture of
Pacific Consultants International and
Yamashita Seki Co. Inc.

Subcontracted Local Consultant:

Tel: 4612777 - Fax: 4612380 - AMMAN - JORDAN

Drawing Title:
CROSS-SECTION
(9+920--9940)

Scale: H 1:400 V 1:200 **Drawing No.:** 398

NOTES :

- * FOR EXACT HEIGHTS AND DIMENSIONS OF BENCHES SEE TYPICAL ROAD CROSS-SECTION .
- * SLOPE H : V .

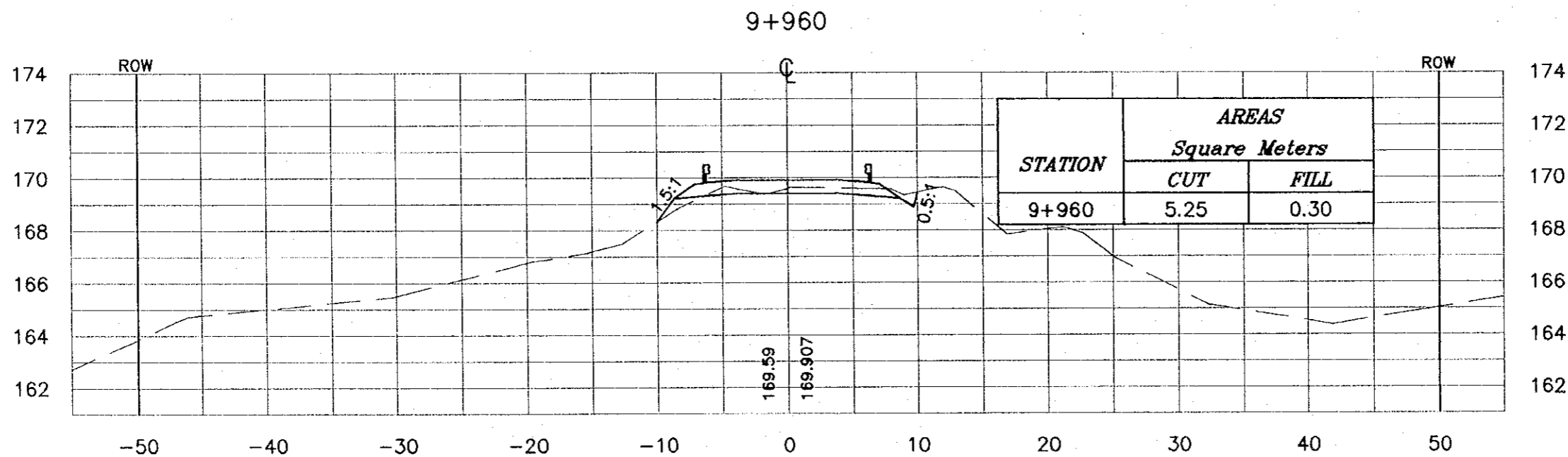
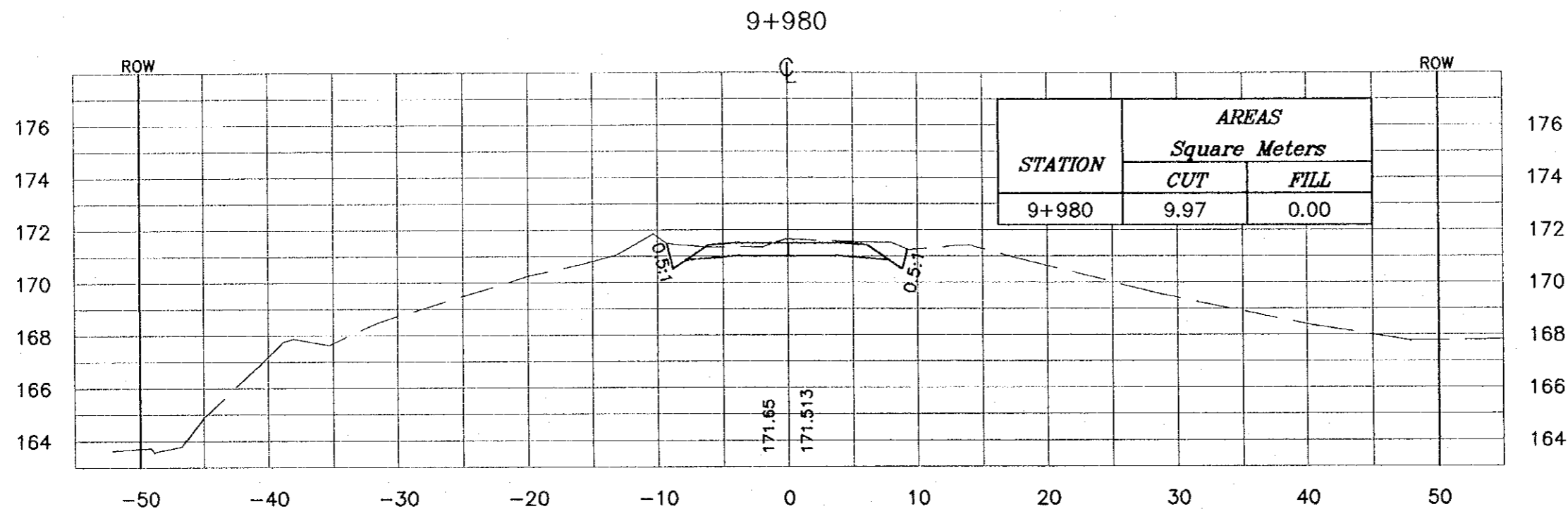

Project:
Tourism Sector Development Project
in the Hashemite Kingdom of Jordan

Executing Agency:
The Ministry of Tourism and Antiquities
The Ministry of Planning

SUB-PROJECT:
Dead Sea Parkway

Note:
This detailed design has been executed by
a team of consultants as shown below in
accordance with the agreement between
Japan International Cooperation Agency
(JICA) and JICA Study Team.
The copyright of this drawing rests with JICA.

Designed by:
Japan International Cooperation
Agency (JICA)

JICA Study Team:
Joint Venture of
Pacific Consultants International and
Yamashita Sekitel Inc.

Subcontracted Local Consultant:

consolidated consultants
engineering & environment
Tel: 962377 - Fax: 962380 - AMMAN - JORDAN

Drawing Title:
CROSS-SECTION
(9+9609+980)

Scale: H 1:400 V 1:200 Drawing No.: 399

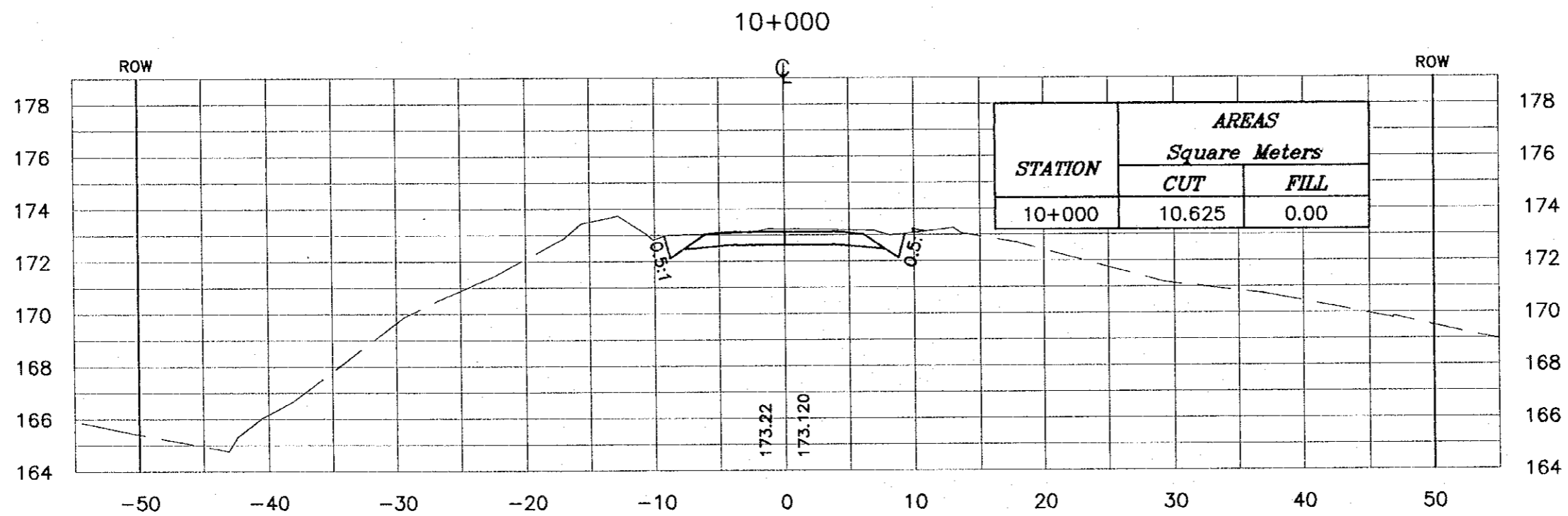
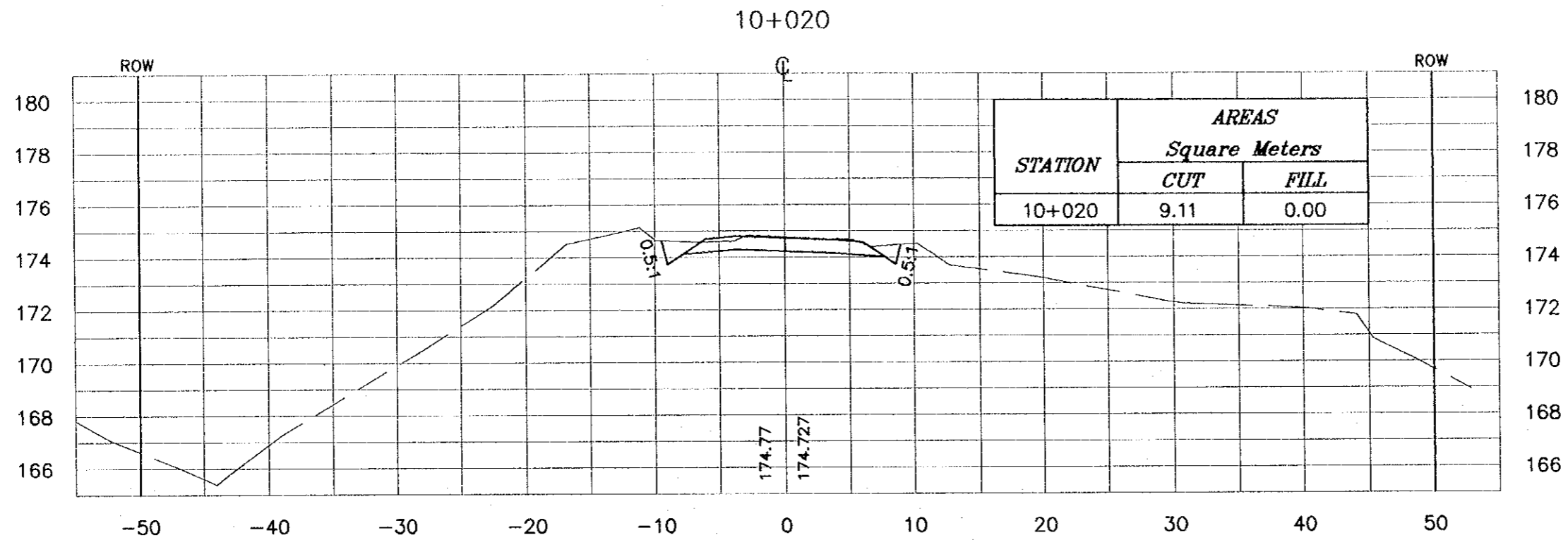

NOTES :

- * FOR EXACT HEIGHTS AND DIMENSIONS OF BENCHES SEE TYPICAL ROAD CROSS-SECTION .
- * SLOPE H : V .

Project:
Tourism Sector Development Project
in the Hashemite Kingdom of Jordan

Executing Agency:
The Ministry of Tourism and Antiquities
The Ministry of Planning

SUB-PROJECT:
Dead Sea Parkway

Note:
This detailed design has been executed by a team of consultants as shown below in accordance with the agreement between Japan International Cooperation Agency (JICA) and JICA Study Team. The copyright of this drawing rests with JICA.

Designed by:
Japan International Cooperation Agency (JICA)

JICA Study Team:
Joint Venture of
Pacific Consultants International and
Yamashita Seikei Inc.

Subcontracted Local Consultant:

Tel: 461277 - Fax: 461280 - JMS-01 - 2206

Drawing Title:
CROSS-SECTION
(10+000-10+020)

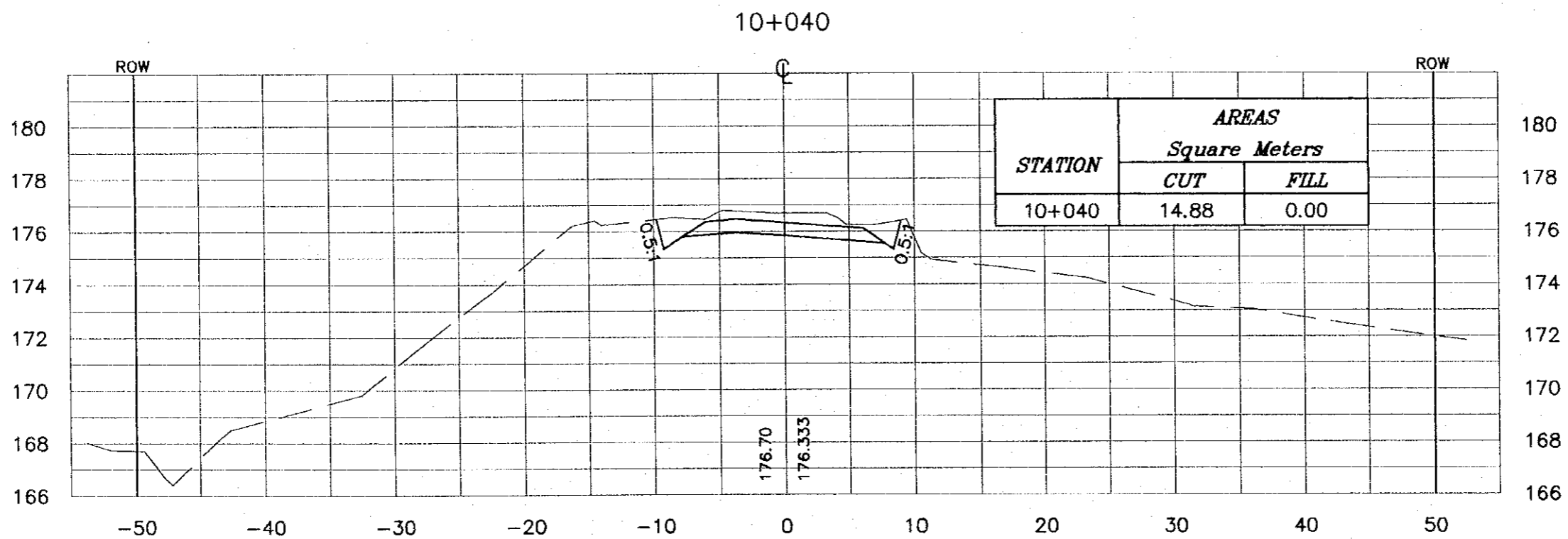
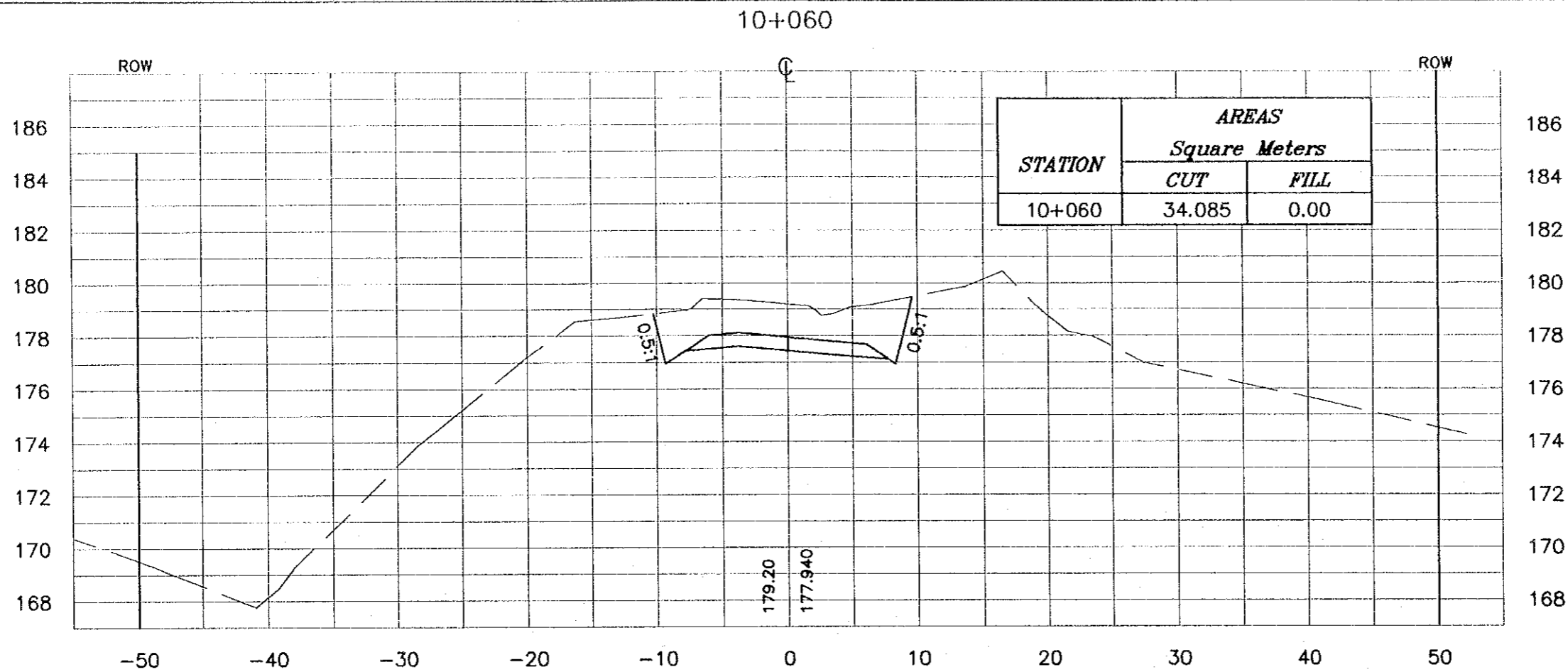
Scale: H 1:400 V 1:200 Drawing No.: 400



NOTES :

- * FOR EXACT HEIGHTS AND DIMENSIONS OF BENCHES SEE TYPICAL ROAD CROSS-SECTION .
- * SLOPE H : V .

Project:
Tourism Sector Development Project
in the Hashemite Kingdom of Jordan

Executing Agency:
The Ministry of Tourism and Antiquities
The Ministry of Planning

SUB-PROJECT:
Dead Sea Parkway

Note:
This detailed design has been executed by a team of consultants as shown below in accordance with the agreement between Japan International Cooperation Agency (JICA) and JICA Study Team. The copyright of this drawing rests with JICA.

Designed by:
Japan International Cooperation Agency (JICA)

JICA Study Team:
Joint Venture of
Pacific Consultants International and
Yamashita Sekkei Inc.

Subcontracted Local Consultant:
 consolidated consultants
engineering & environment
Tel. 4612377 - Fax: 4612380 - Amman - JORDAN

Drawing Title:
CROSS-SECTION
(10+040-10+060)

Scale: H: 1:400 **Drawing No.:** 401
V: 1:200

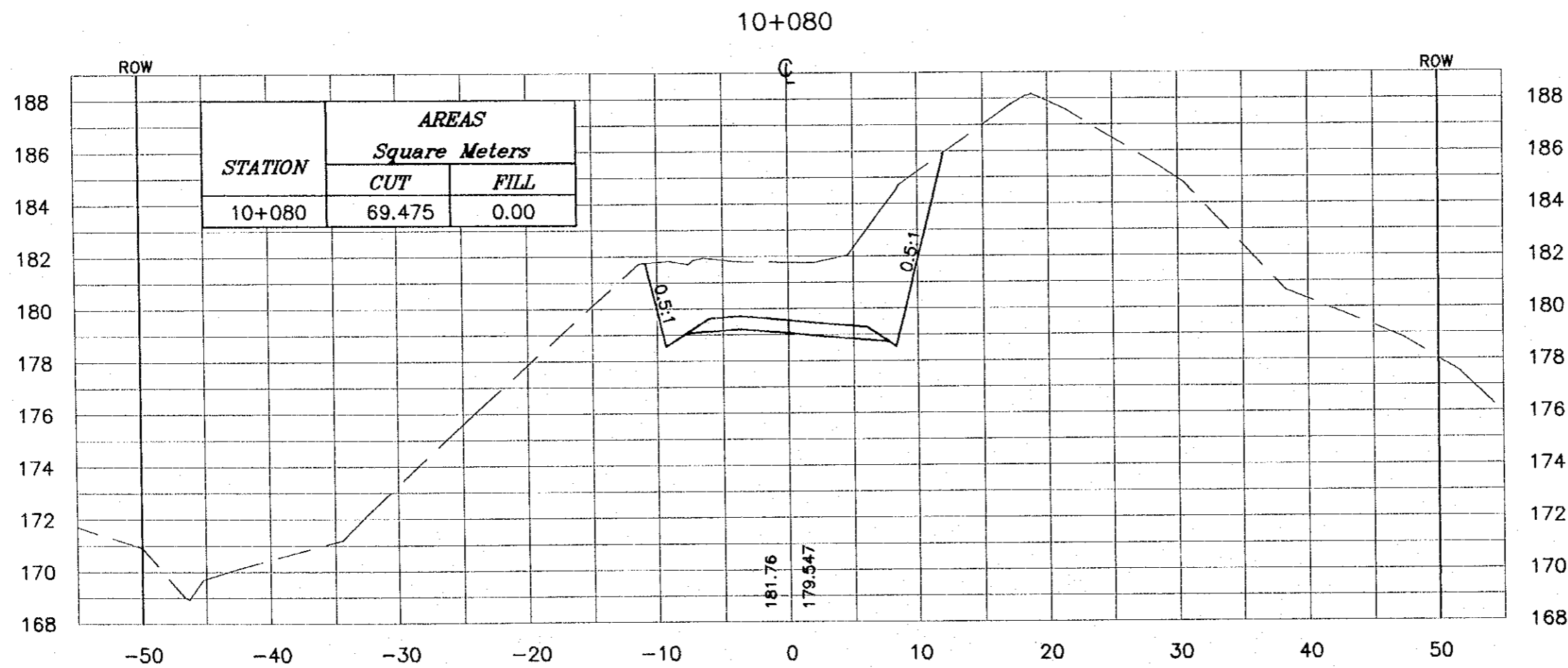
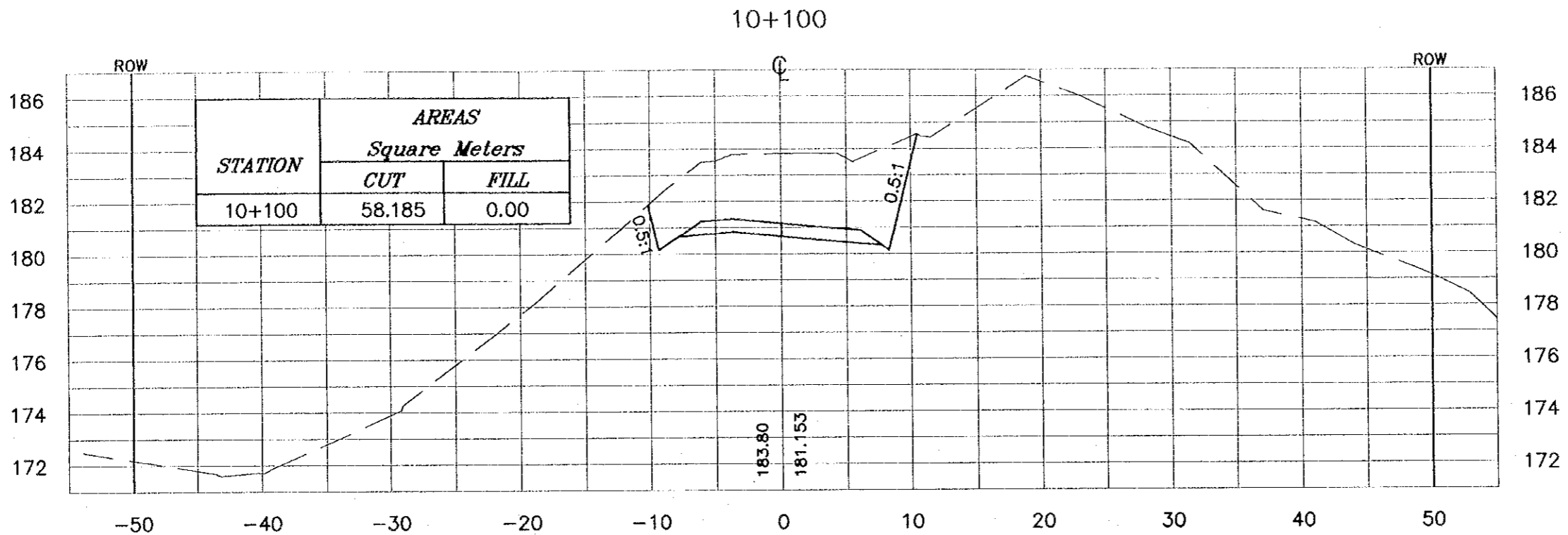

NOTES :

- * FOR EXACT HEIGHTS AND DIMENSIONS OF BENCHES SEE TYPICAL ROAD CROSS-SECTION .
- * SLOPE H : V .

Project:
Tourism Sector Development Project
in the Hashemite Kingdom of Jordan

Executing Agency:
The Ministry of Tourism and Antiquities
The Ministry of Planning

SUB-PROJECT:
Dead Sea Parkway

Note:
This detailed design has been executed by a team of consultants as shown below in accordance with the agreement between Japan International Cooperation Agency (JICA) and JICA Study Team. The copyright of this drawing rests with JICA.

Designed by:
Japan International Cooperation Agency (JICA)

JICA Study Team:
Joint Venture of Pacific Consultants International and Yamashita Sekkei inc.

Subcontracted Local Consultant:
 consolidated consultants
Engineering & Environment
Tel: 412377 - Fax: 412380 - AMMAN - JORDAN

Drawing Title:
CROSS-SECTION
(10+080-10+100)

Scale: 1:400 **Drawing No.:** 402
V 1:200

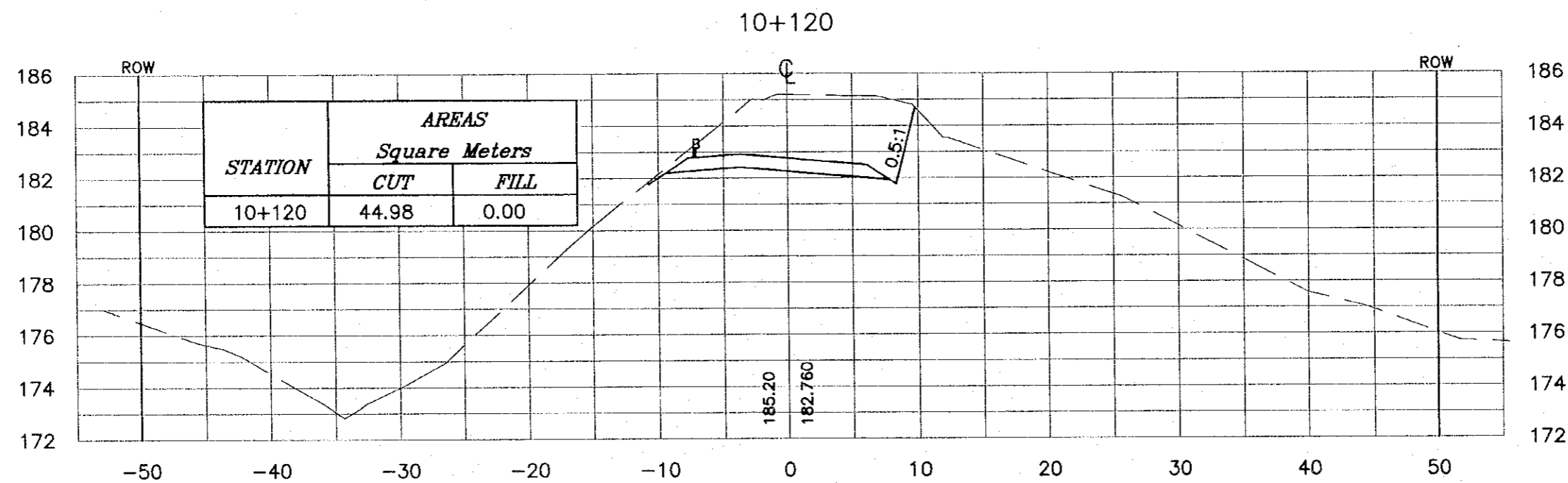
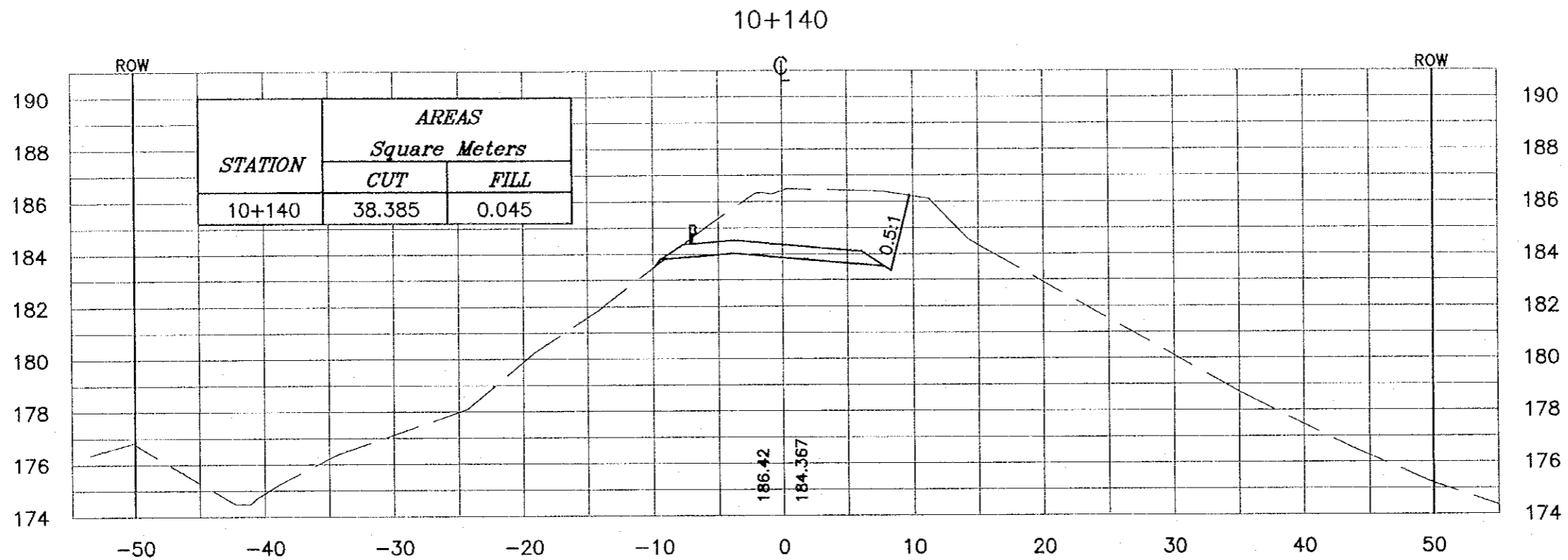

NOTES :

- * FOR EXACT HEIGHTS AND DIMENSIONS OF BENCHES SEE TYPICAL ROAD CROSS-SECTION .
- * SLOPE H : V .

Project:
Tourism Sector Development Project
in the Hashemite Kingdom of Jordan

Executing Agency:
The Ministry of Tourism and Antiquities
The Ministry of Planning

SUB-PROJECT:
Dead Sea Parkway

Note:
This detailed design has been executed by a team of consultants as shown below in accordance with the agreement between Japan International Cooperation Agency (JICA) and JICA Study Team. The copyright of this drawing rests with JICA.

Designed by:
Japan International Cooperation Agency (JICA)

JICA Study Team:
Joint Venture of
Pacific Consultants International and
Yamashita Sekkei Inc.

Subcontracted Local Consultant:
 consolidated consultants
Engineering & Environment
Tel: 4612377 - Fax: 4612380 - JORDAN - JICA

Drawing Title:
CROSS-SECTION
(10+120-10+140)

Scale: H 1:400 V 1:200 **Drawing No.:** 403

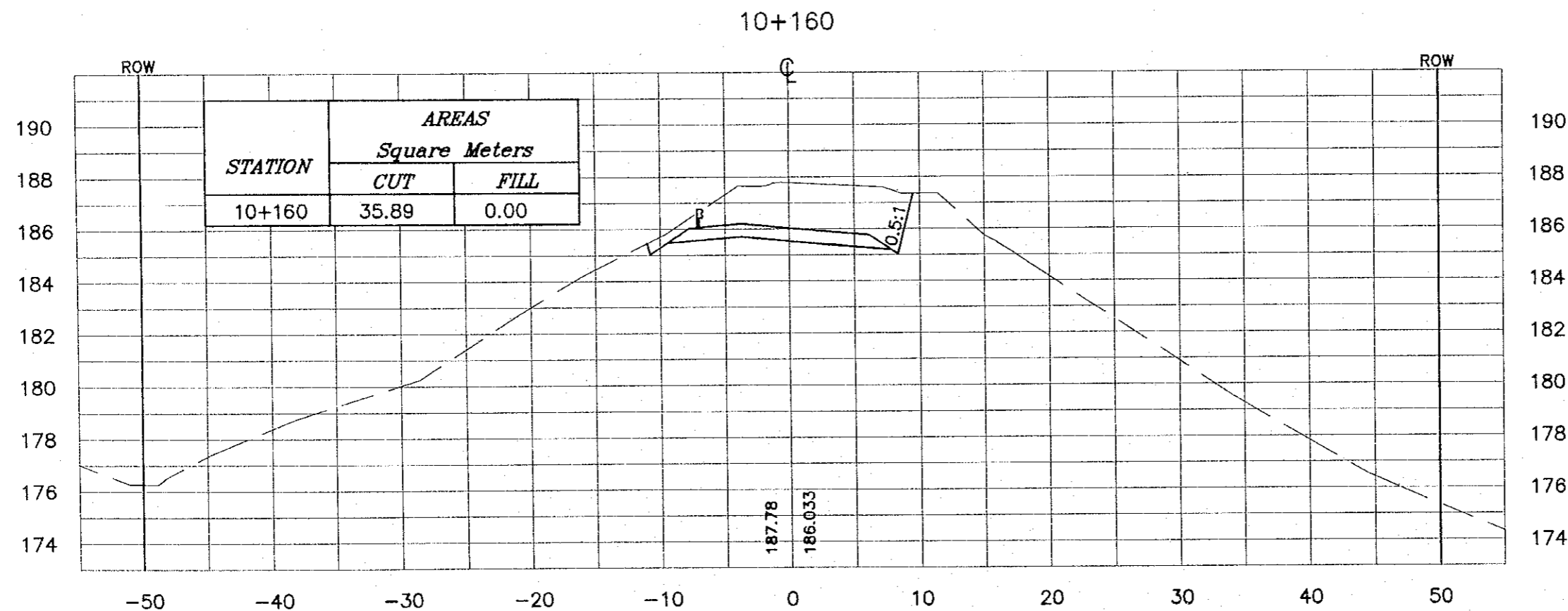
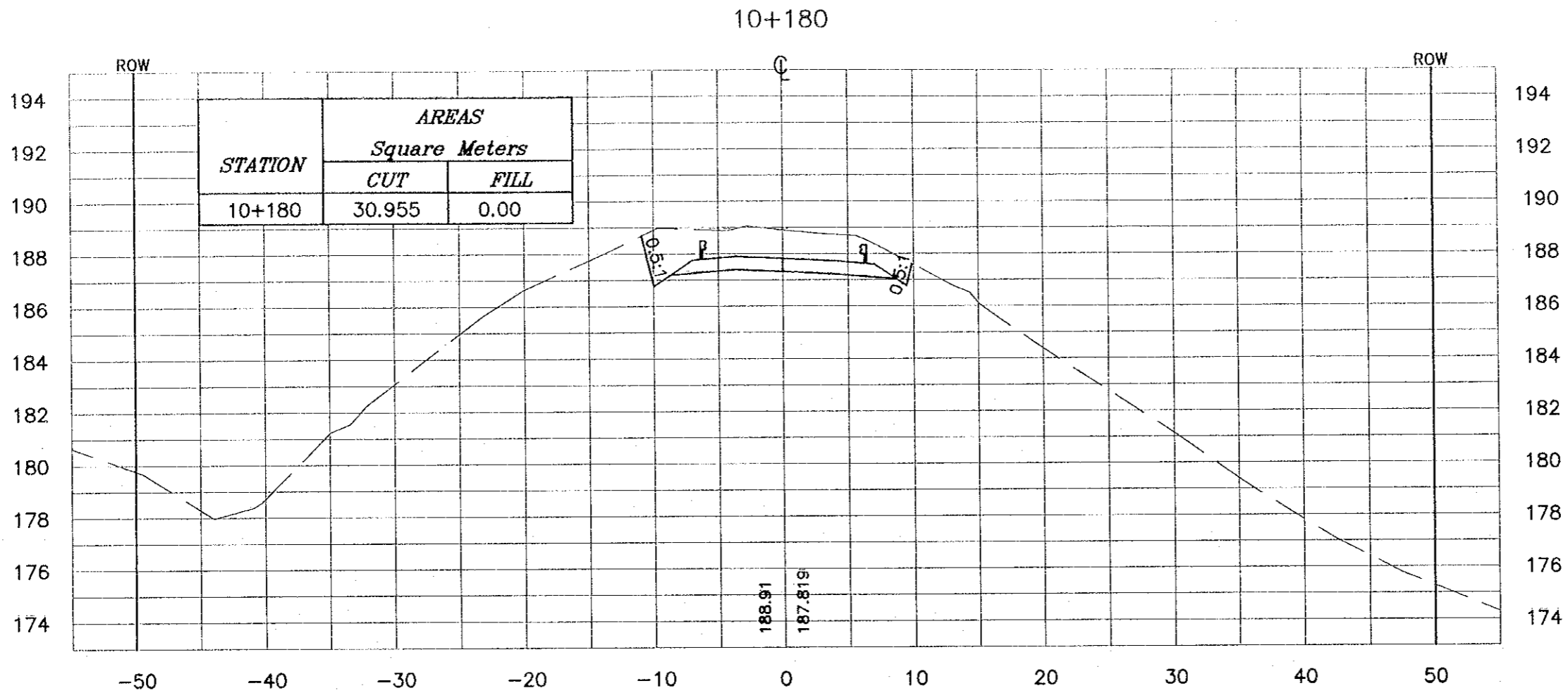

NOTES :

- * FOR EXACT HEIGHTS AND DIMENSIONS OF BENCHES SEE TYPICAL ROAD CROSS-SECTION .
- * SLOPE H : V .

Project:
Tourism Sector Development Project
in the Hashemite Kingdom of Jordan

Executing Agency:
The Ministry of Tourism and Antiquities
The Ministry of Planning

SUB-PROJECT:
Dead Sea Parkway

Note:
This detailed design has been executed by a team of consultants as shown below in accordance with the agreement between Japan International Cooperation Agency (JICA) and JICA Study Team. The copyright of this drawing rests with JICA.

Designed by:
Japan International Cooperation Agency (JICA)

JICA Study Team:
Joint Venture of
Pacific Consultants International and
Yamashita Seikoku Inc.

Subcontracted Local Consultant:
 consolidated consultants
Engineering & Environment
Tel: 962277 - Fax: 962280 - JORDAN

Drawing Title:
CROSS-SECTION
(10+160-10+180)

Scale: H 1:400 V 1:200 **Drawing No.:** 404

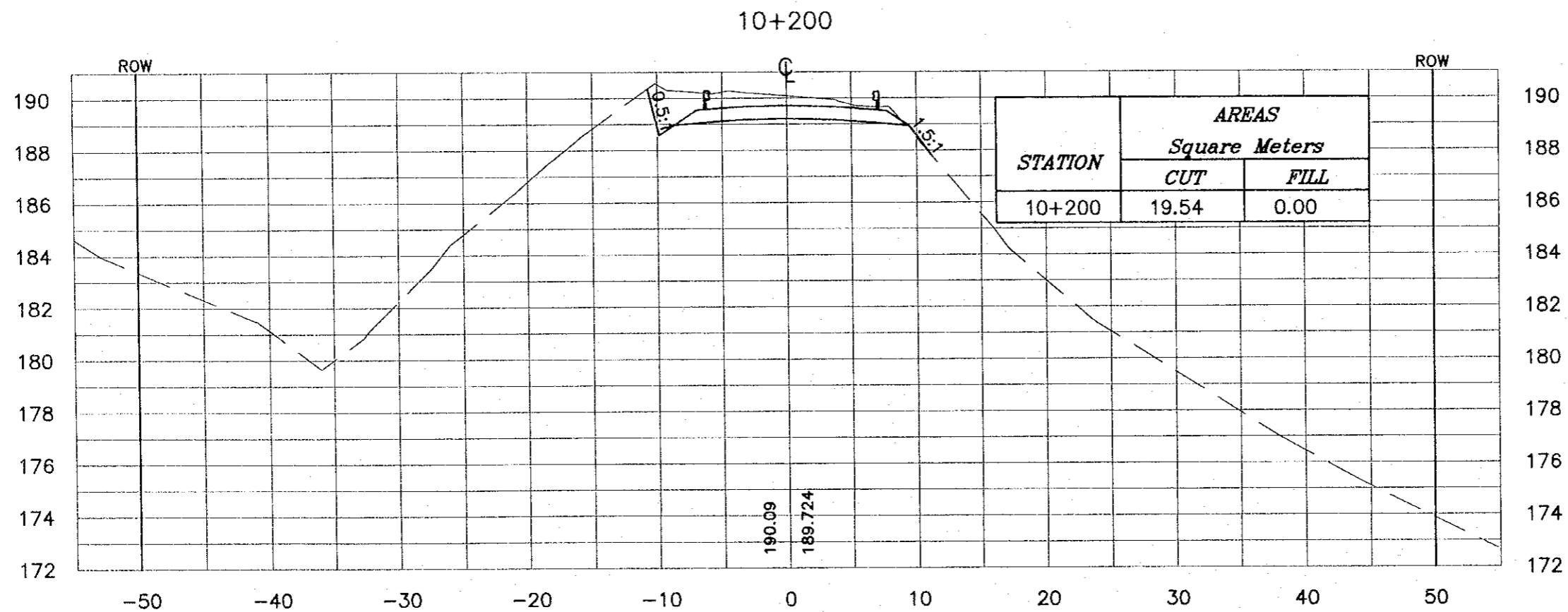
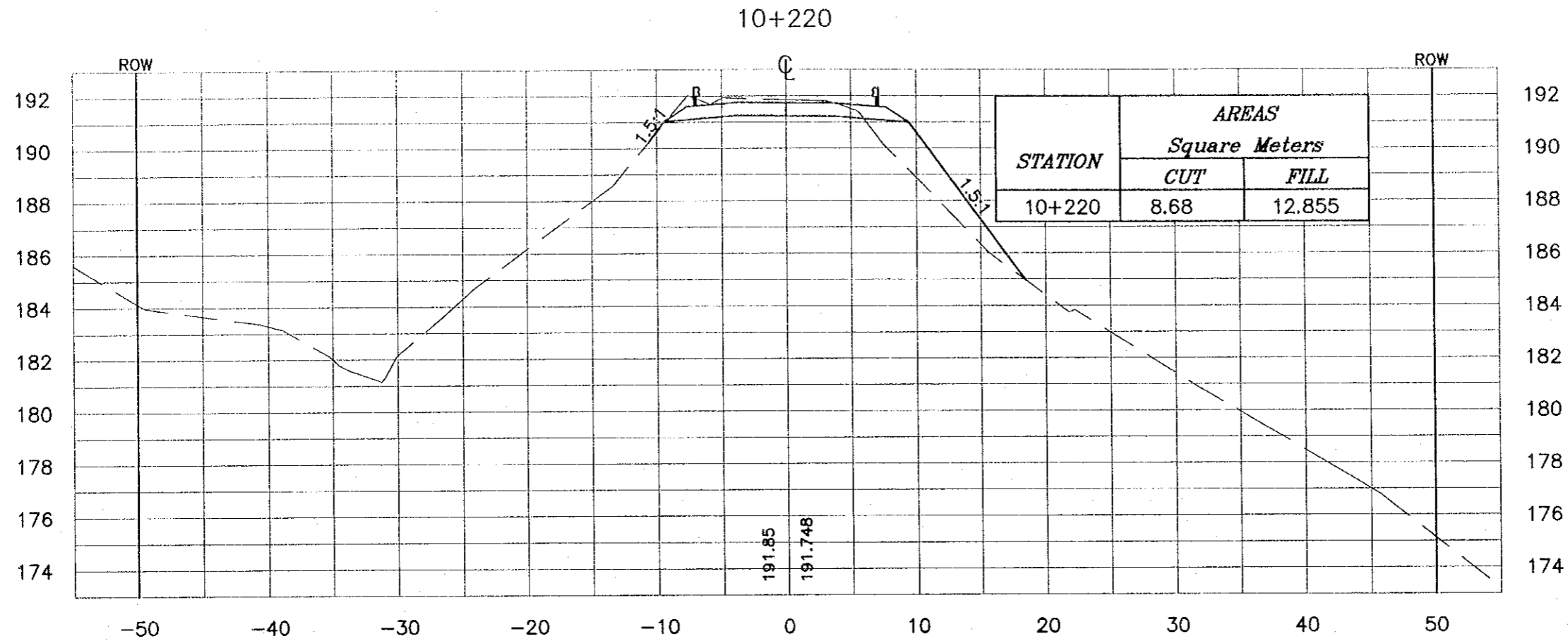

NOTES :

- * FOR EXACT HEIGHTS AND DIMENSIONS OF BENCHES SEE TYPICAL ROAD CROSS-SECTION .
- * SLOPE H : V .

Project:
Tourism Sector Development Project
in the Hashemite Kingdom of Jordan

Executing Agency:
The Ministry of Tourism and Antiquities
The Ministry of Planning

SUB-PROJECT:
Dead Sea Parkway

Note:
This detailed design has been executed by a team of consultants as shown below in accordance with the agreement between Japan International Cooperation Agency (JICA) and JICA Study Team. The copyright of this drawing rests with JICA.

Designed by:
Japan International Cooperation Agency (JICA)

JICA Study Team:
Joint Venture of Pacific Consultants International and Yamaoka Seisaku Inc.

Subcontracted Local Consultant:
 consolidated consultants
Engineering & Construction
Tel: 412377 - Fax: 412380 - AMM - JORDAN

Drawing Title:
CROSS-SECTION
(10+200-10+220)

Scale: H 1:400 V 1:200 Drawing No.: 405

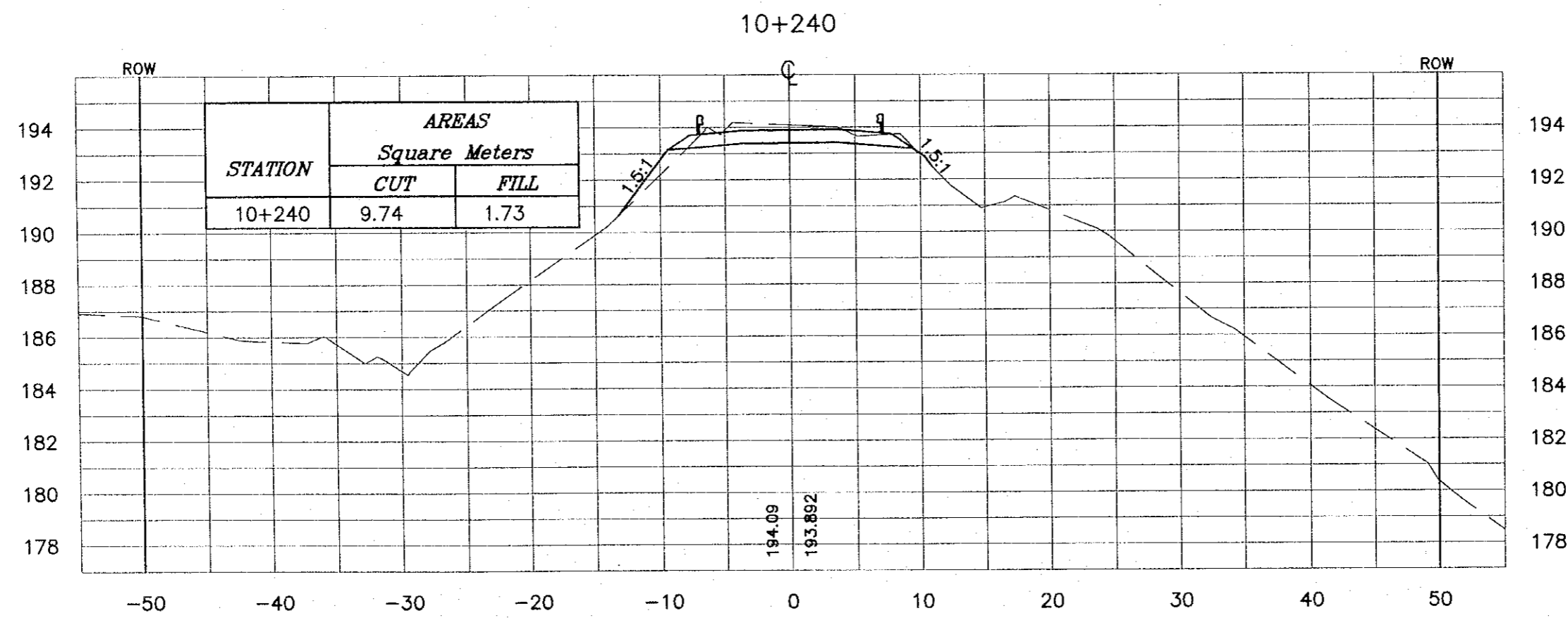
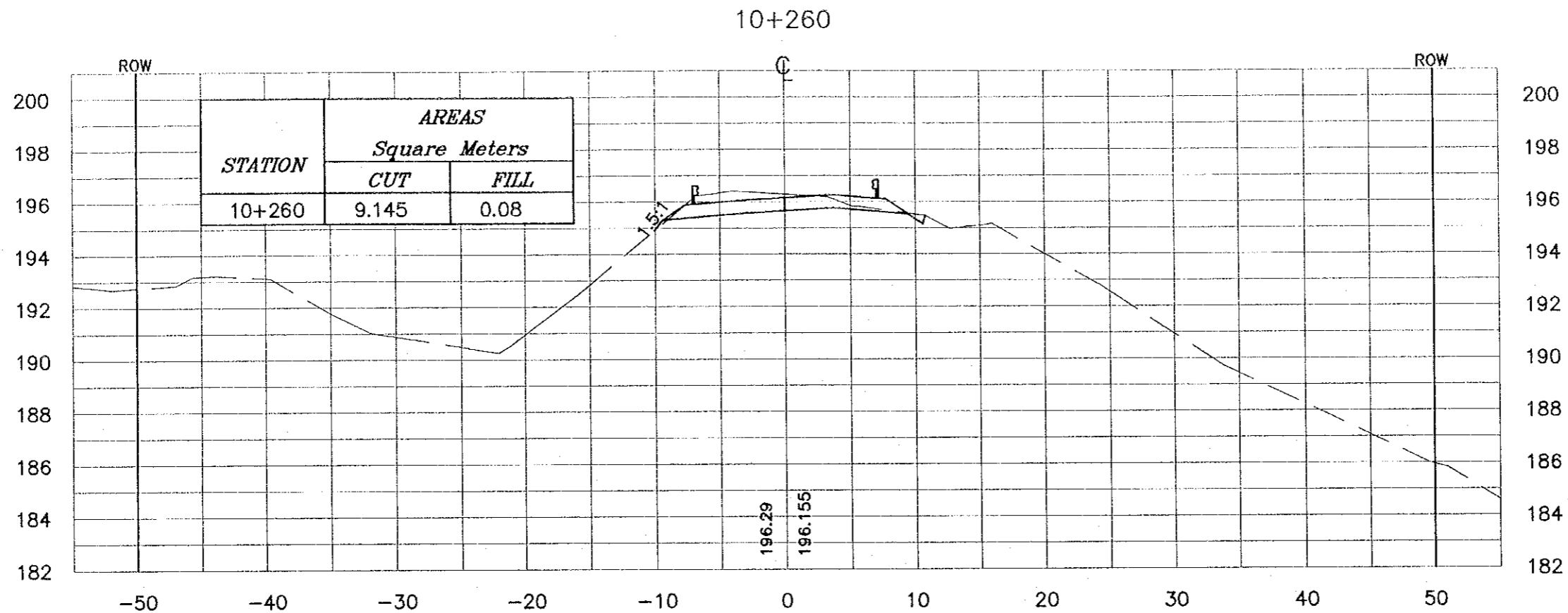

NOTES :

- * FOR EXACT HEIGHTS AND DIMENSIONS OF BENCHES SEE TYPICAL ROAD CROSS-SECTION .
- * SLOPE H : V .

Project:
Tourism Sector Development Project
in the Hashemite Kingdom of Jordan

Executing Agency:
The Ministry of Tourism and Antiquities
The Ministry of Planning

SUB-PROJECT:
Dead Sea Parkway

Note:
This detailed design has been executed by a team of consultants as shown below in accordance with the agreement between Japan International Cooperation Agency (JICA) and JICA Study Team. The copyright of this drawing rests with JICA.

Designed by:
Japan International Cooperation Agency (JICA)

JICA Study Team:
Joint Venture of Pacific Consultants International and Yamaoka Sekkei Inc.

Subcontracted Local Consultant:
 consolidated consultants
Engineering & Environment
Tel: 4612777 - Fax: 4612200 - AMMAN - JORDAN

Drawing Title:
CROSS-SECTION
(10+240-10+260)

Scale: H 1:400 V 1:200 **Drawing No.:** 406

NOTES :

- * FOR EXACT HEIGHTS AND DIMENSIONS OF BENCHES SEE TYPICAL ROAD CROSS-SECTION .
- * SLOPE H : V .

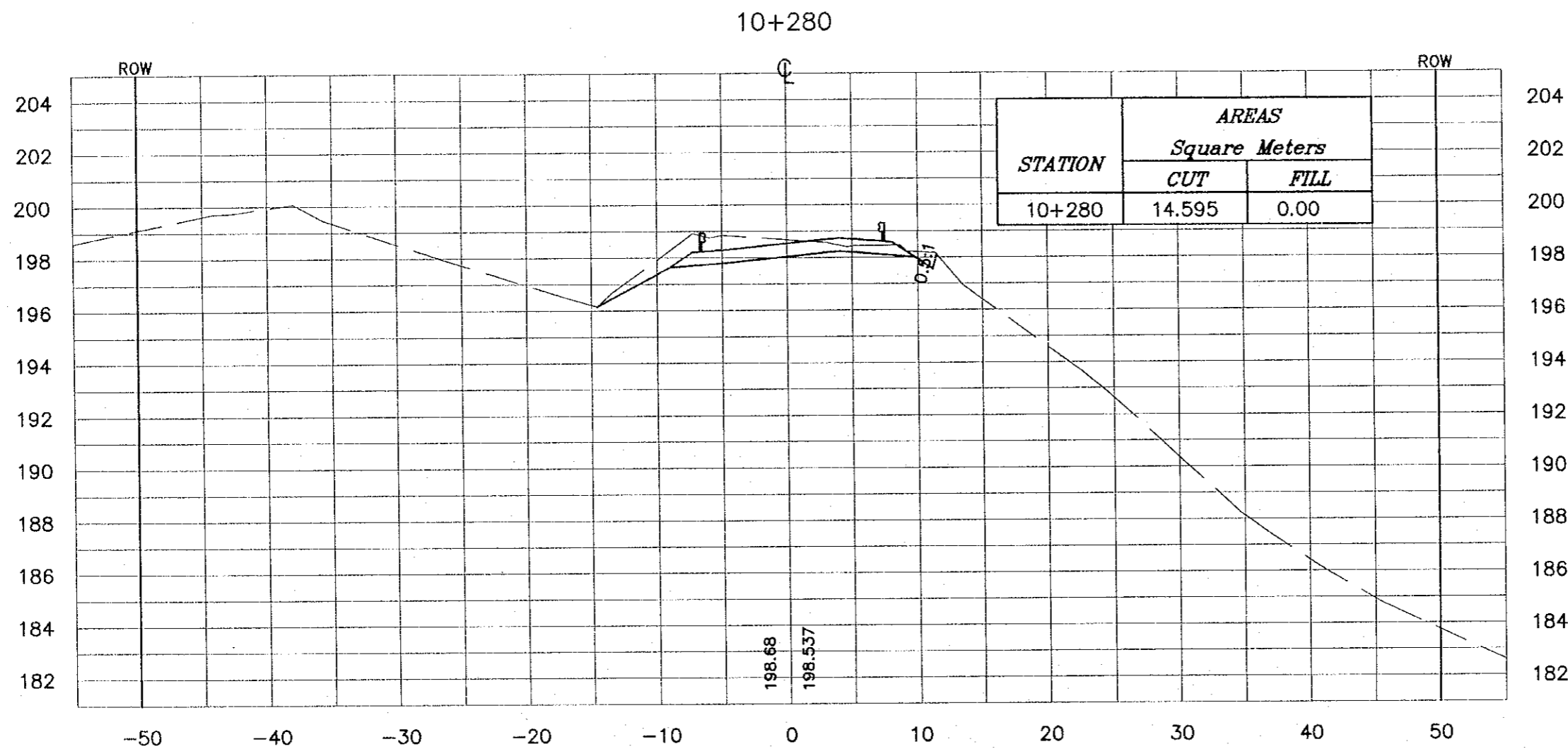

Project:
Tourism Sector Development Project
In the Hashemite Kingdom of Jordan

Executing Agency:
The Ministry of Tourism and Antiquities
The Ministry of Planning

SUB-PROJECT:
Dead Sea Parkway

Note:
This detailed design has been executed by a team of consultants as shown below in accordance with the agreement between Japan International Cooperation Agency (JICA) and JICA Study Team.
The copyright of this drawing rests with JICA.

Designed by:
Japan International Cooperation Agency (JICA)

JICA Study Team:
Joint Venture of
Pacific Consultants International and
Yamashita Seiki & Co. Inc.

Subcontracted Local Consultant:
 consolidated consultants
engineering & environment
Tel: 9952277 - Fax: 9952300 - AMMAN - JORDAN

Drawing Title:
CROSS-SECTION
10+280

Scale: H 1:400 V 1:200 **Drawing No.:** 407

NOTES :

- * FOR EXACT HEIGHTS AND DIMENSIONS OF BENCHES SEE TYPICAL ROAD CROSS-SECTION .
- * SLOPE H : V .

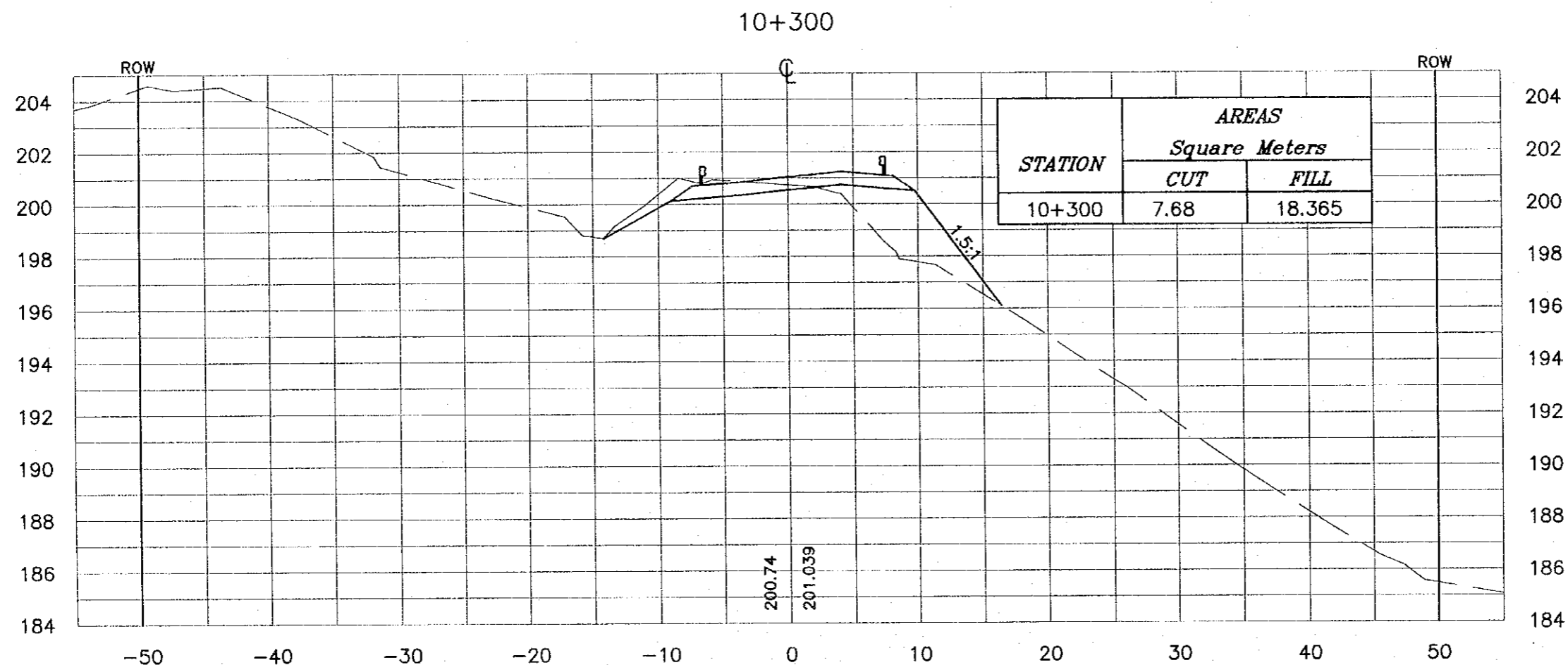

Project:
Tourism Sector Development Project
in the Hashemite Kingdom of Jordan

Executing Agency:
The Ministry of Tourism and Antiquities
The Ministry of Planning

SUB-PROJECT:
Dead Sea Parkway

Note:
This detailed design has been executed by a team of consultants as shown below in accordance with the agreement between Japan International Cooperation Agency (JICA) and JICA Study Team. The copyright of this drawing rests with JICA.

Designed by:
Japan International Cooperation Agency (JICA)

JICA Study Team:
Joint Venture of
Pacific Consultants International and
Yamashita Sekkel Inc.

Subcontracted Local Consultant:

consolidated consultants
engineering & environment
Tel: 9912377 - Fax: 9912368 - AMMAN - JORDAN

Drawing Title:
CROSS-SECTION
10+300

Scale: H 1:400 V 1:200 **Drawing No.:** 408