



JAPAN INTERNATIONAL COOPERATION AGENCY

THE GOVERNMENT OF THE HASHEMITE KINGDOM OF JORDAN
THE MINISTRY OF TOURISM AND ANTIQUITIES, THE MINISTRY OF PLANNING

DRAFT
TENDER DOCUMENTS FOR CONSTRUCTION
OF
DEAD SEA PARKWAY SUB-PROJECT
THE TOURISM SECTOR DEVELOPMENT PROJECT

VOLUME IV
DRAWINGS
(4) CROSS SECTIONS

JICA LIBRARY



J 1160587 (0)

Pacific Consultants International
Yamashita Sekkei Inc.

August 2000

SSF

JR

00-153

JAPAN INTERNATIONAL COOPERATION AGENCY

THE GOVERNMENT OF THE HASHEMITE KINGDOM OF JORDAN
THE MINISTRY OF TOURISM AND ANTIQUITIES, THE MINISTRY OF PLANNING

DRAFT
TENDER DOCUMENTS FOR CONSTRUCTION
OF
DEAD SEA PARKWAY SUB-PROJECT
THE TOURISM SECTOR DEVELOPMENT PROJECT

VOLUME IV
DRAWINGS
(4) CROSS SECTIONS

Pacific Consultants International
Yamashita Sekkei Inc.

August 2000



1160587 (0)



THE HASHEMITE KINGDOM OF JORDAN

MINISTRY OF TOURISM AND ANTIQUITIES
TOURISM SECTOR DEVELOPMENT PROJECT

DEAD SEA PARKWAY SUB-PROJECT

AUGUST, 2000

CROSS SECTIONS
(3 OF 3)

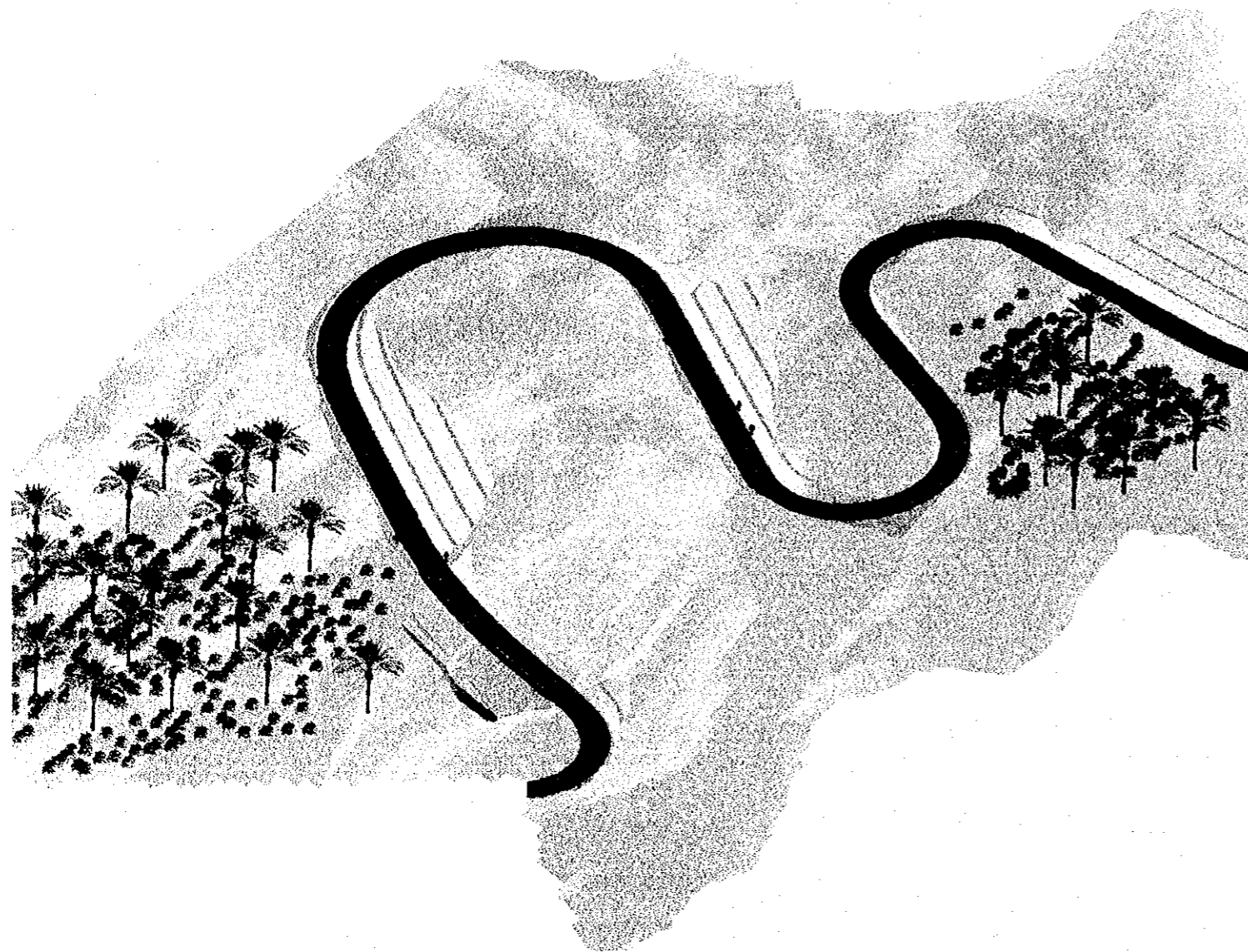

PRIME CONSULTANT

THE JAPAN INTERNATIONAL CORPORATION AGENCY (JICA)
DETAILED DESIGN STUDY TEAM

JOINT VENTURE

PACIFIC CONSULTANTS INTERNATIONAL,
YAMASHITA SEKKEI, INC.

LOCAL CONSULTANT



consolidated consultants
engineering & environment
Tel: 4612377 - Fax: 4612380 - AMMAN - JORDAN

NOTES :

- * FOR EXACT HEIGHTS AND DIMENSIONS OF BENCHES SEE TYPICAL ROAD CROSS-SECTION .
- * SLOPE H : V .

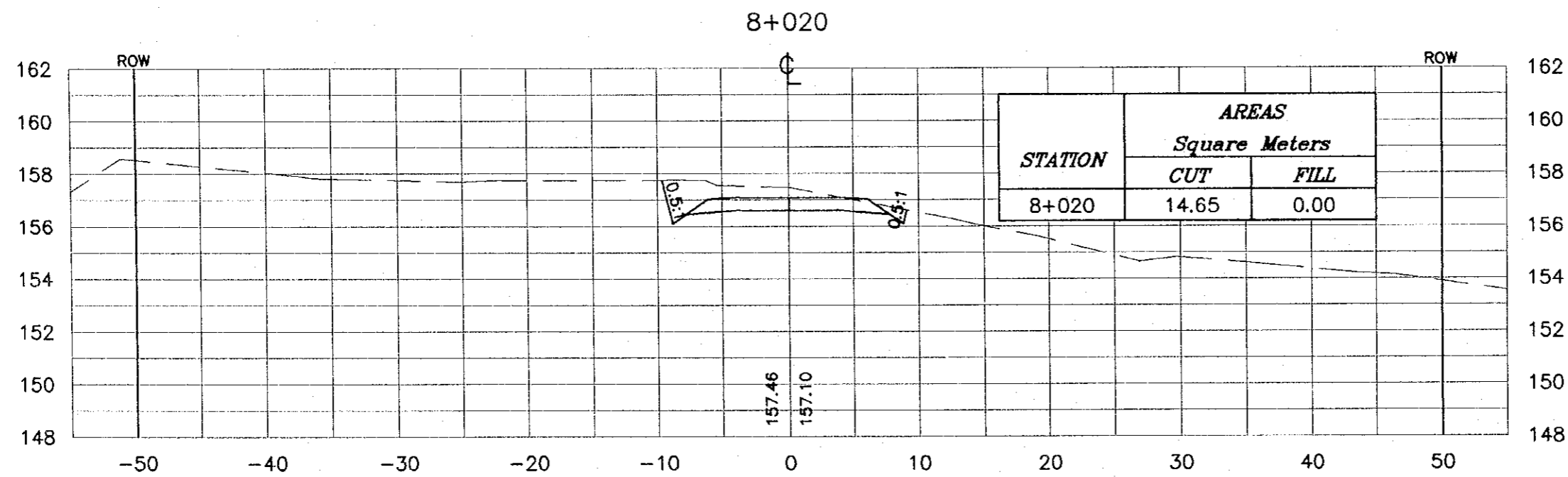
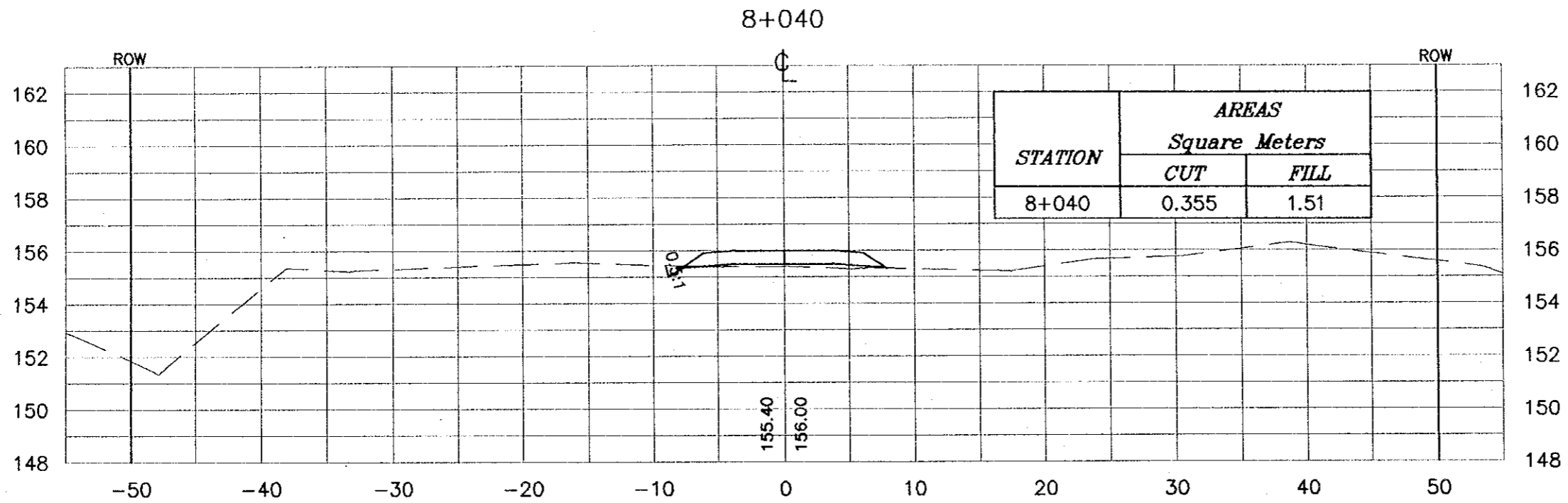

Project:
Tourism Sector Development Project
in the Hashemite Kingdom of Jordan

Executing Agency:
The Ministry of Tourism and Antiquities
The Ministry of Planning

SUB-PROJECT:
Dead Sea Parkway

Note:
This detailed design has been executed by a team of consultants as shown below in accordance with the agreement between Japan International Cooperation Agency (JICA) and JICA Study Team. The copyright of this drawing rests with JICA.

Designed by:
Japan International Cooperation Agency (JICA)

JICA Study Team:
Joint Venture of
Pacific Consultants International and
Yamashita Seikoku Inc.

Subcontracted Local Consultant:
 consolidated consultants
engineering & environment
Tel: 4612377 - Fax: 4612380 - AMMAN - JORDAN

Drawing Title:
CROSS-SECTION
8+020/8+040

Scale: H 1:400
V 1:200

Drawing No.: 341

NOTES :
 * FOR EXACT HEIGHTS AND DIMENSIONS OF BENCHES SEE TYPICAL ROAD CROSS-SECTION .
 * SLOPE H : V .

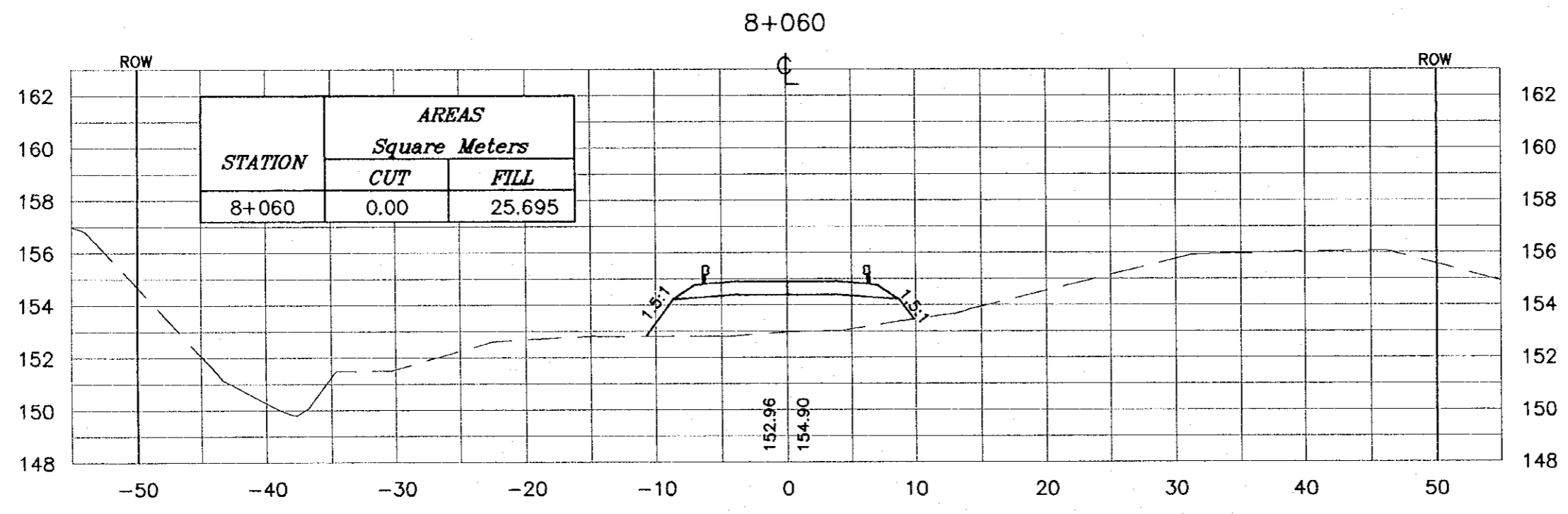
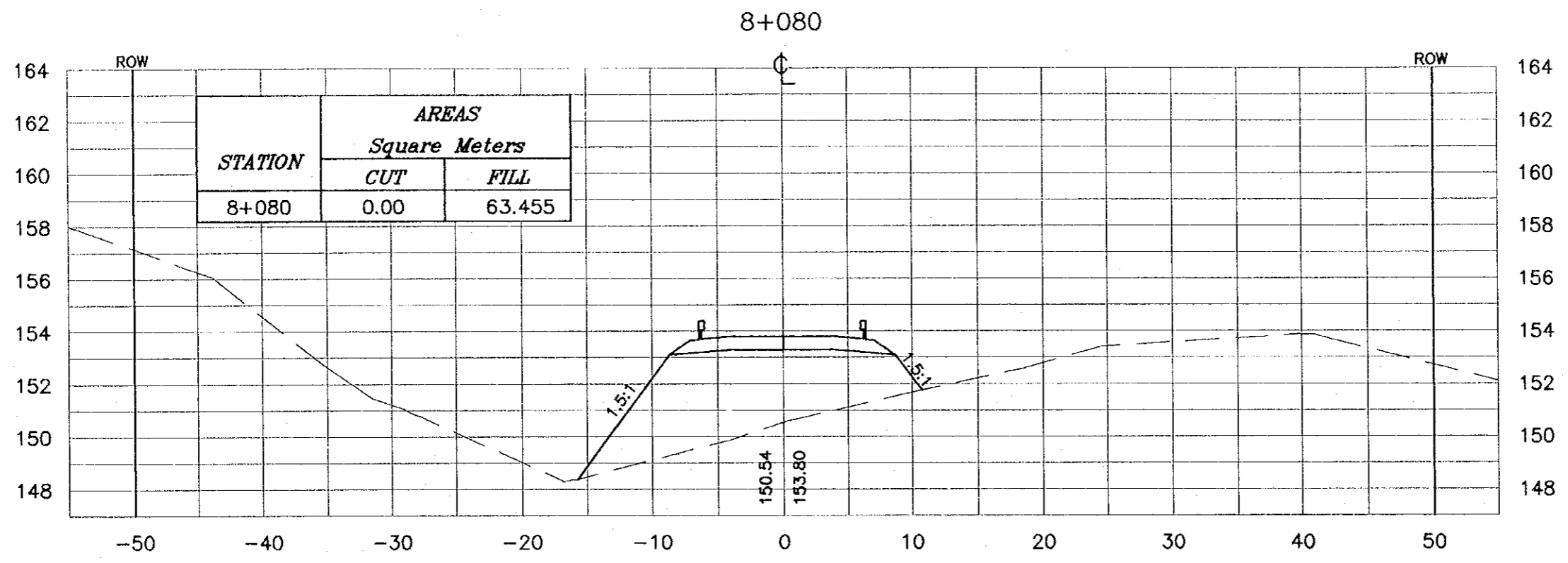

Project:
 Tourism Sector Development Project
 in the Hashemite Kingdom of Jordan

Executing Agency:
 The Ministry of Tourism and Antiquities
 The Ministry of Planning

SUB-PROJECT:
 Dead Sea Parkway

Note:
 This detailed design has been executed by a team of consultants as shown below in accordance with the agreement between Japan International Cooperation Agency (JICA) and JICA Study Team. The copyright of this drawing rests with JICA.

Designed by:
 Japan International Cooperation Agency (JICA)

JICA Study Team:
 Joint Venture of Pacific Consultants International and Yamazaki Sekkei Inc.

Subcontracted Local Consultant:
consolidated consultants
 engineering & environment
 Tel: 4812377 - Fax: 4812380 - Amman - JORDAN

Drawing Title:
 CROSS-SECTION
 8+060/8+080

Scale: H 1:400 V 1:200 **Drawing No.:** 342

NOTES :
 * FOR EXACT HEIGHTS AND DIMENSIONS OF BENCHES SEE TYPICAL ROAD CROSS-SECTION .
 * SLOPE H : V .

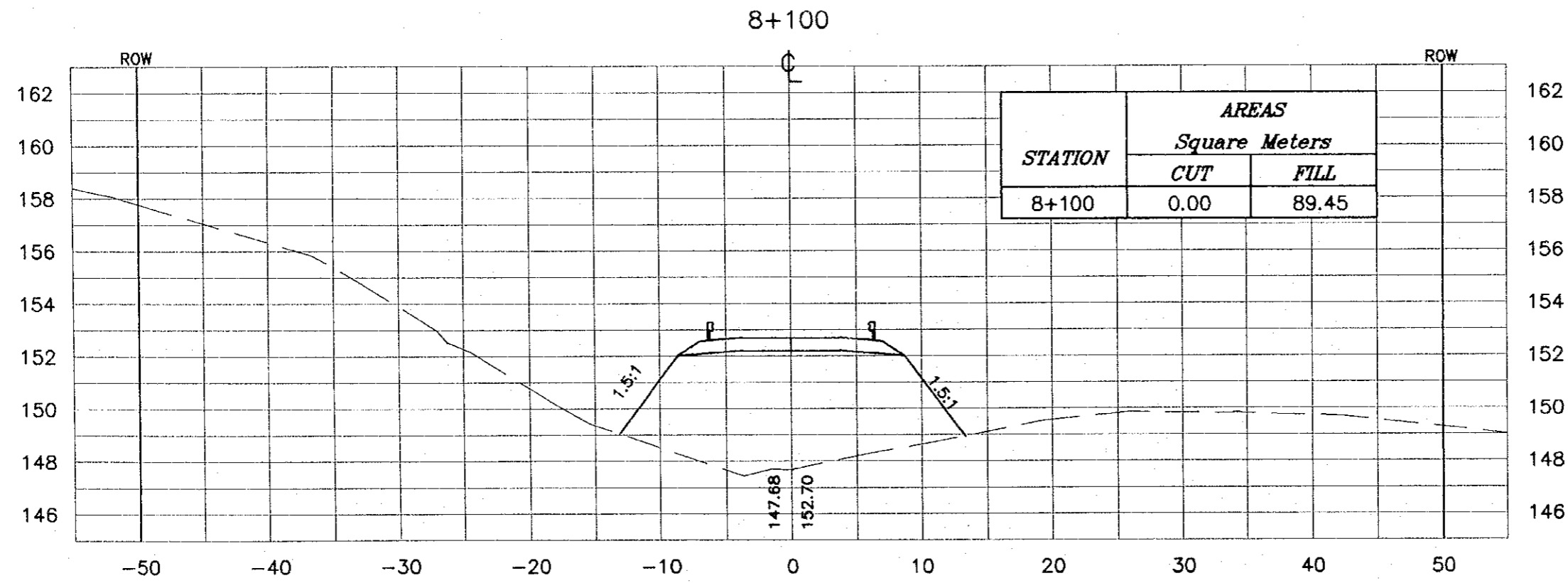
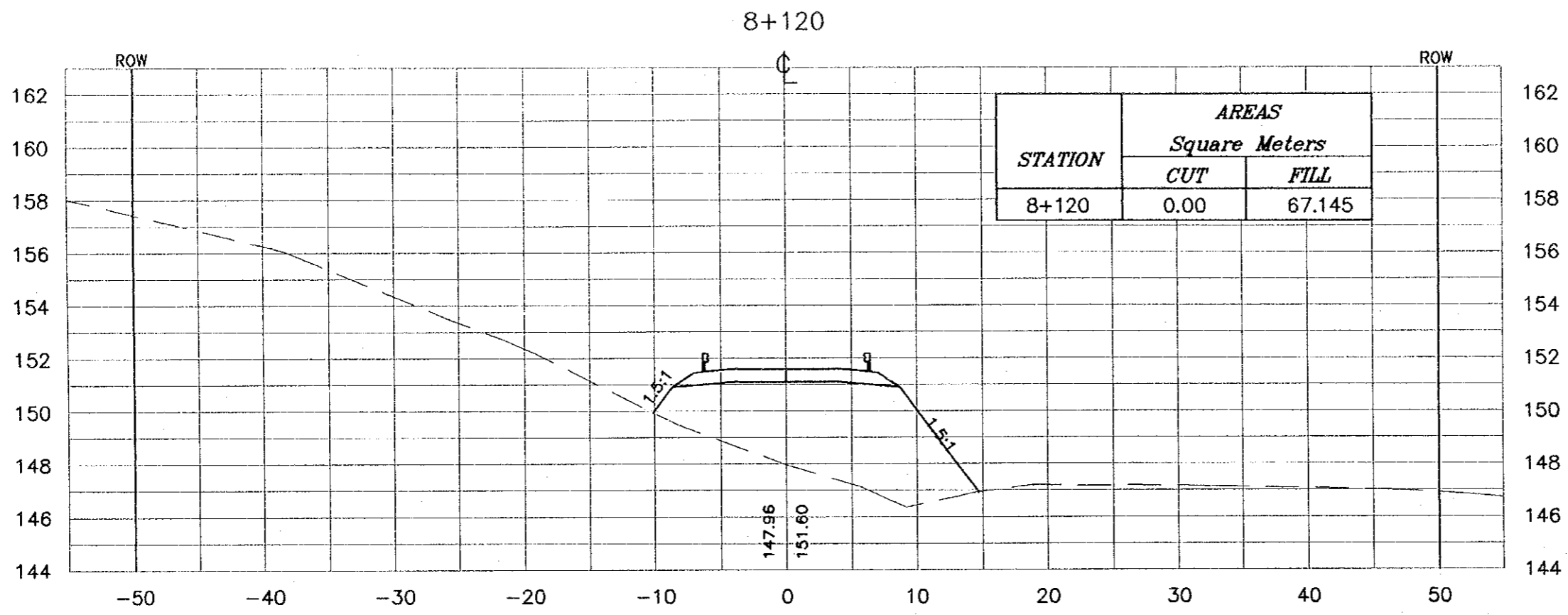

Project:
 Tourism Sector Development Project
 in the Hashemite Kingdom of Jordan

Executing Agency:
 The Ministry of Tourism and Antiquities
 The Ministry of Planning

SUB-PROJECT:
 Dead Sea Parkway

Note:
 This detailed design has been executed by a team of consultants as shown below in accordance with the agreement between Japan International Cooperation Agency (JICA) and JICA Study Team. The copyright of this drawing rests with JICA.

Designed by:
 Japan International Cooperation Agency (JICA)

JICA Study Team:
 Joint Venture of Pacific Consultants International and Yamashita Sekkei Inc.

Subcontracted Local Consultant:
consolidated consultants
 engineering & environment
 Tel: 4612377 - Fax: 4612360 - Amman - JORDAN

Drawing Title:
 CROSS-SECTION
 8+100/8+120

Scale: H 1:400 V 1:200 **Drawing No.:** 343

NOTES :

* FOR EXACT HEIGHTS AND DIMENSIONS OF BENCHES SEE TYPICAL ROAD CROSS-SECTION .

* SLOPE H : V .

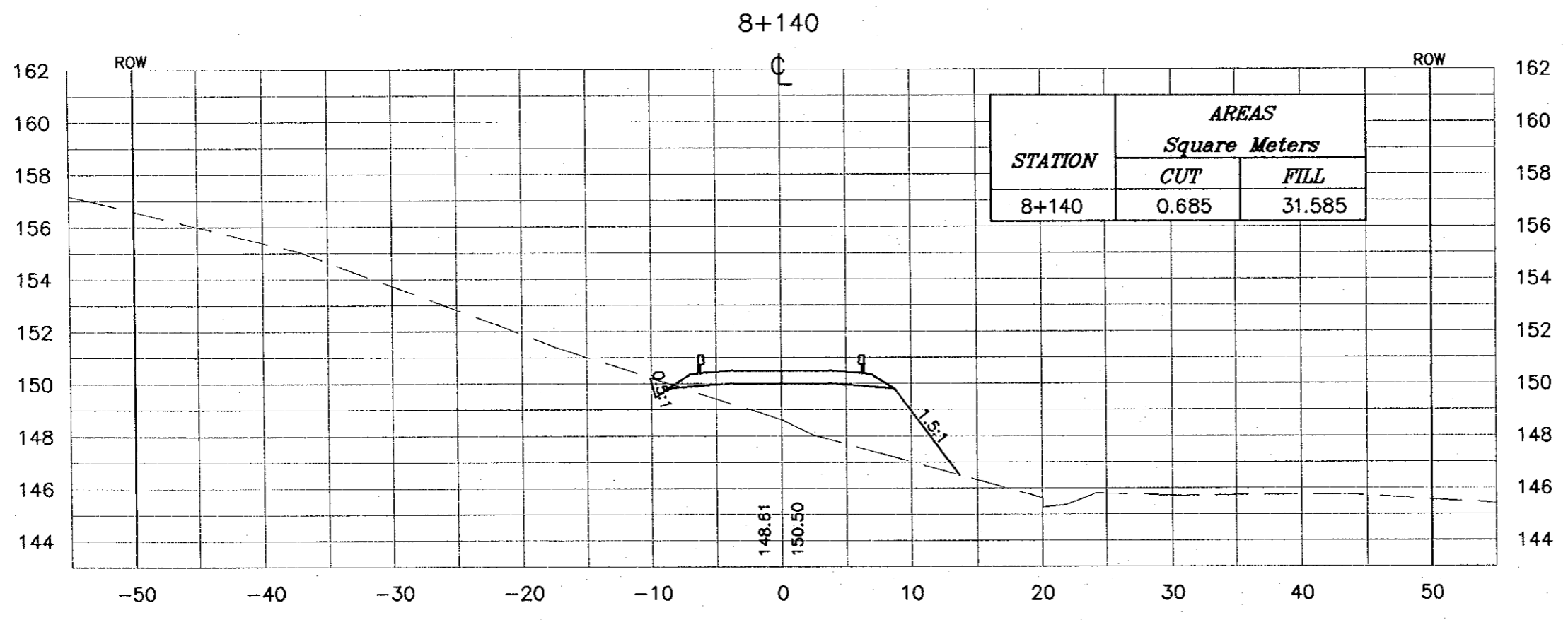
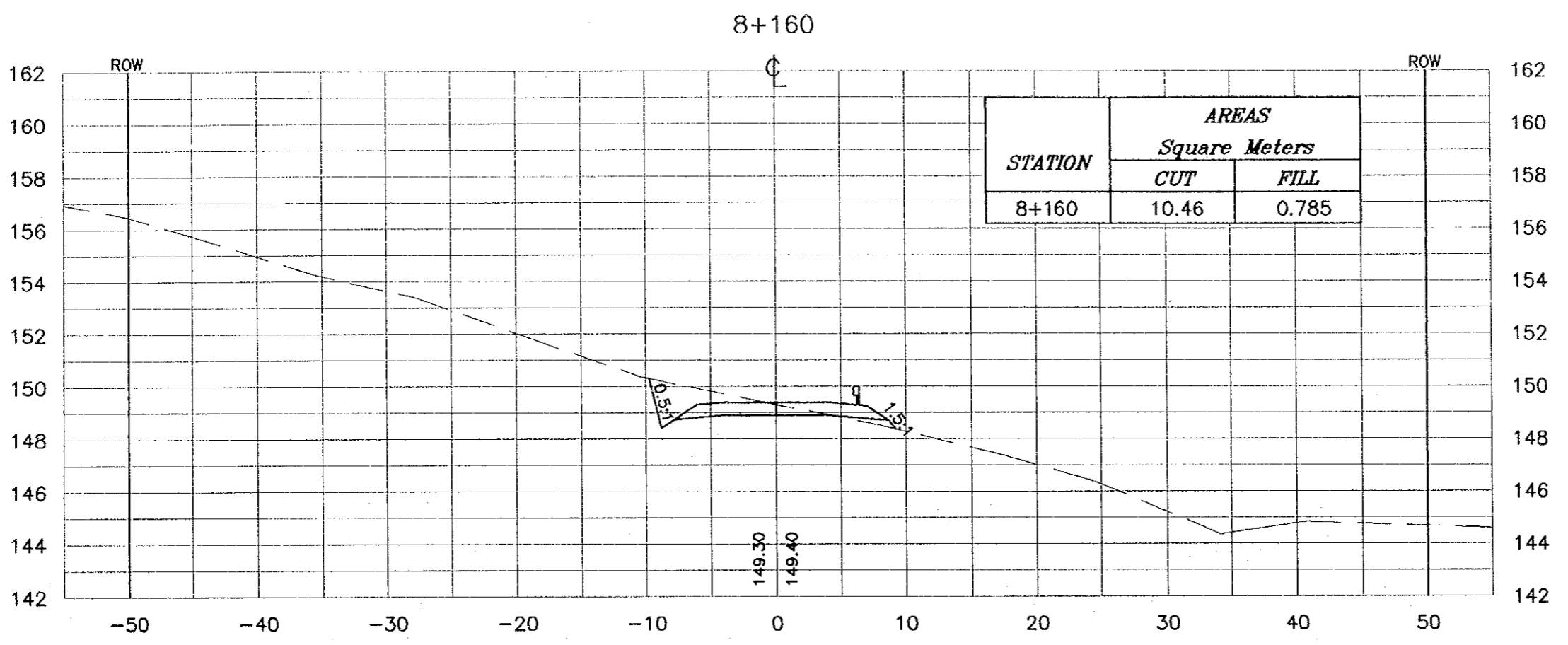

Project:
Tourism Sector Development Project
in the Hashemite Kingdom of Jordan

Executing Agency:
The Ministry of Tourism and Antiquities
The Ministry of Planning

SUB-PROJECT:
Dead Sea Parkway

Note:
This detailed design has been executed by
a team of consultants as shown below in
accordance with the agreement between
Japan International Cooperation Agency
(JICA) and JICA Study Team.
The copyright of this drawing rests with JICA.

Designed by:
Japan International Cooperation
Agency (JICA)

JICA Study Team:
Joint Venture of
Pacific Consultants International and
Yamashita Sekkel Inc.

Subcontracted Local Consultant:
 consolidated consultants
engineering & environment
Tel. 9612377 - Fax 9612388 - AMMAN - JORDAN

Drawing Title:
CROSS-SECTION
8+140/8+160

Scale: H 1:400 V 1:200 Drawing No.: 344

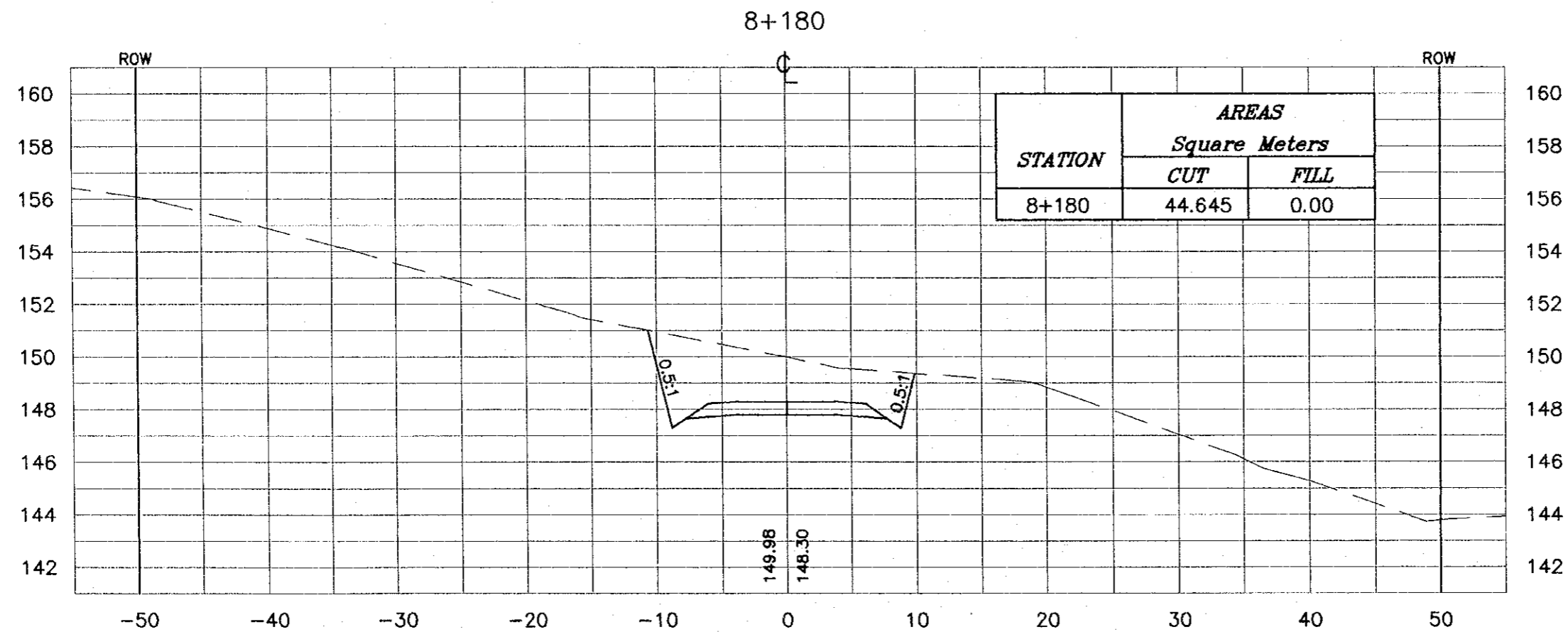
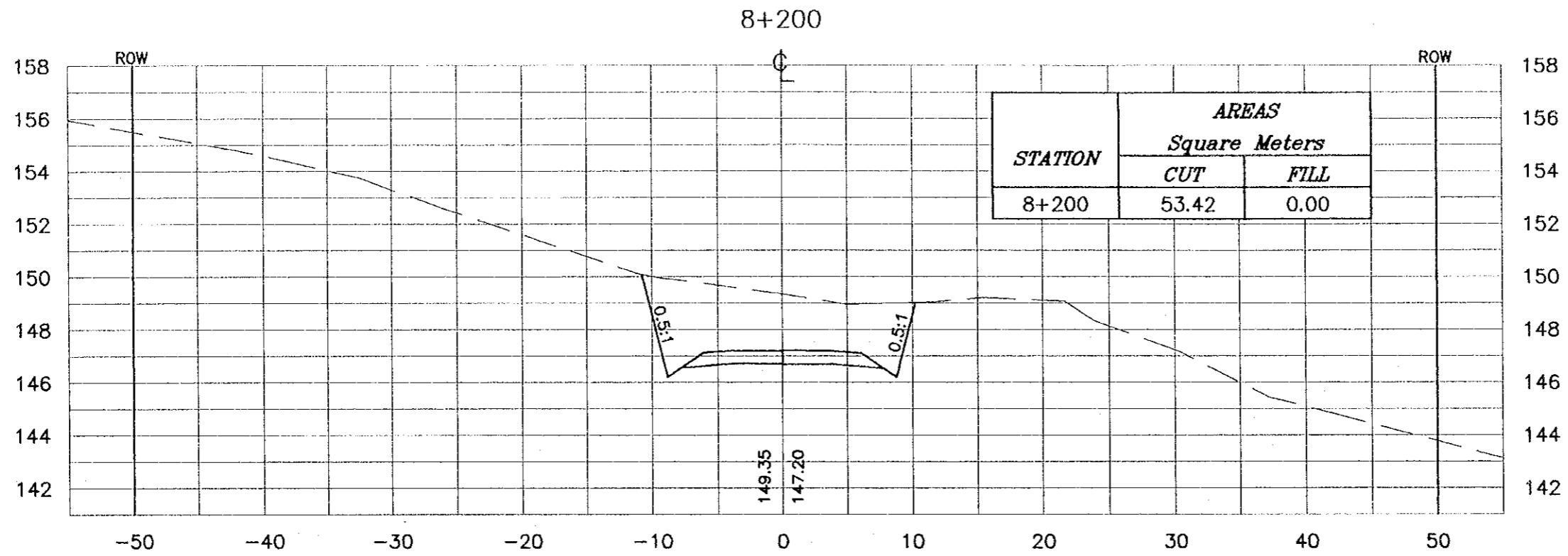

NOTES :

- * FOR EXACT HEIGHTS AND DIMENSIONS OF BENCHES SEE TYPICAL ROAD CROSS-SECTION .
- * SLOPE H : V .

Project:
Tourism Sector Development Project
in the Hashemite Kingdom of Jordan

Executing Agency:
The Ministry of Tourism and Antiquities
The Ministry of Planning

SUB-PROJECT:
Dead Sea Parkway

Note:
This detailed design has been executed by a team of consultants as shown below in accordance with the agreement between Japan International Cooperation Agency (JICA) and JICA Study Team.
The copyright of this drawing rests with JICA.

Designed by:
Japan International Cooperation Agency (JICA)

JICA Study Team:
Joint Venture of
Pacific Consultants International and
Yamashita Sekkei Inc.

Subcontracted Local Consultant:
 consolidated consultants
engineering & environment
Tel: 4612377 - Fax: 4612388 - AMMAN - JORDAN

Drawing Title:
CROSS-SECTION
8+180/8+200

Scale: H 1:400 V 1:200 Drawing No.: 345

NOTES :

- * FOR EXACT HEIGHTS AND DIMENSIONS OF BENCHES SEE TYPICAL ROAD CROSS-SECTION .
- * SLOPE H : V .

Project:
Tourism Sector Development Project
in the Hashemite Kingdom of Jordan

Escorting Agency:
The Ministry of Tourism and Antiquities
The Ministry of Planning

SUB-PROJECT:
Dead Sea Parkway

Note:
This detailed design has been executed by a team of consultants as shown below in accordance with the agreement between Japan International Cooperation Agency (JICA) and JICA Study Team. The copyright of this drawing rests with JICA.

Designed by:
Japan International Cooperation Agency (JICA)

JICA Study Team:
Joint Venture of Pacific Consultants International and Yamashita Sekkei Inc.

Subcontracted Local Consultant:
consolidated consultants
engineering & environment
Tel: 9612377 - Fax: 9612380 - AMMAN - JORDAN

Drawing Title:
CROSS-SECTION
8+220/8+240/8+260

Scale: H 1:400 V 1:200 Drawing No.: 346

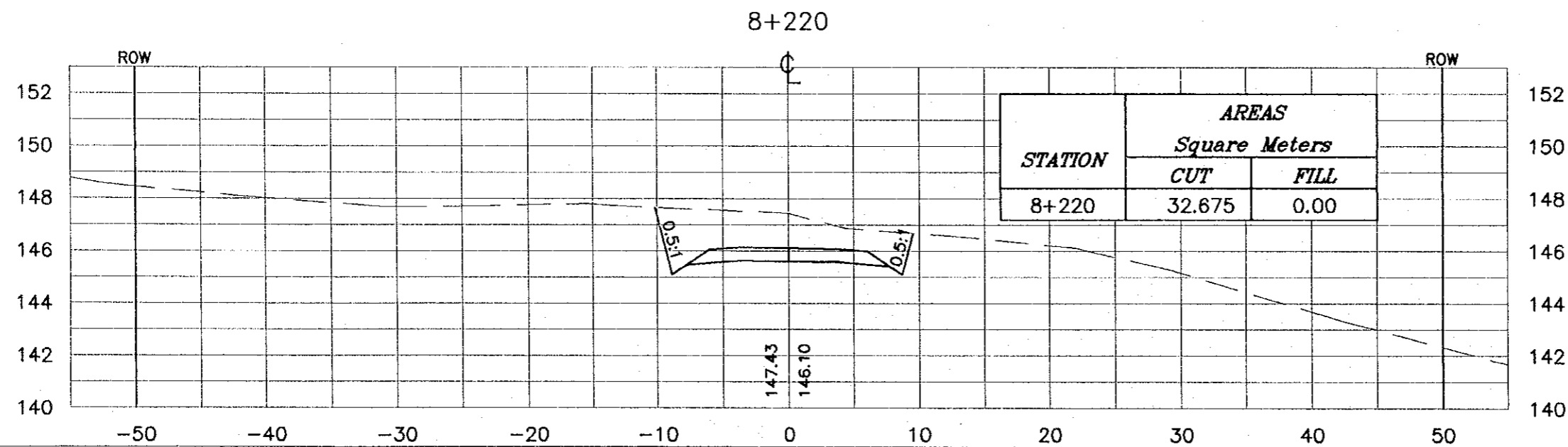
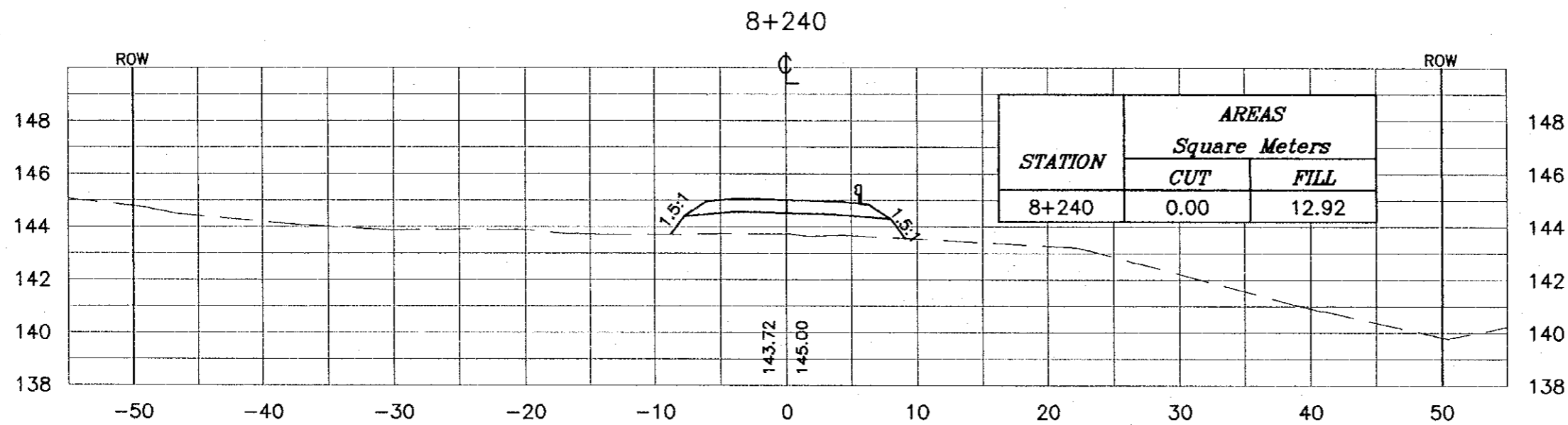
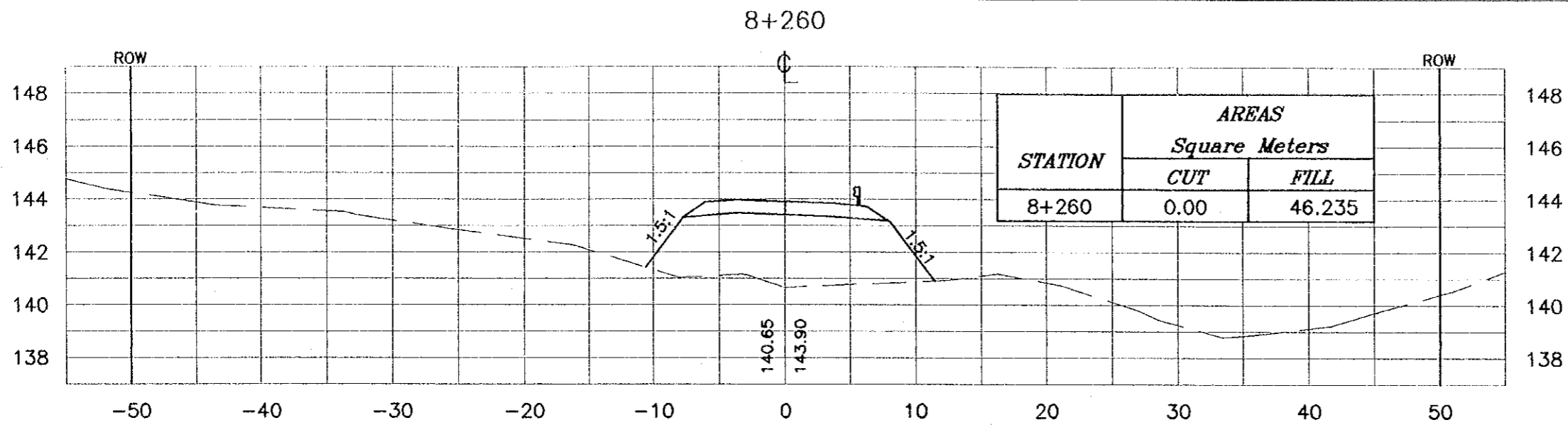

NOTES :

- * FOR EXACT HEIGHTS AND DIMENSIONS OF BENCHES SEE TYPICAL ROAD CROSS-SECTION .
- * SLOPE H : V .

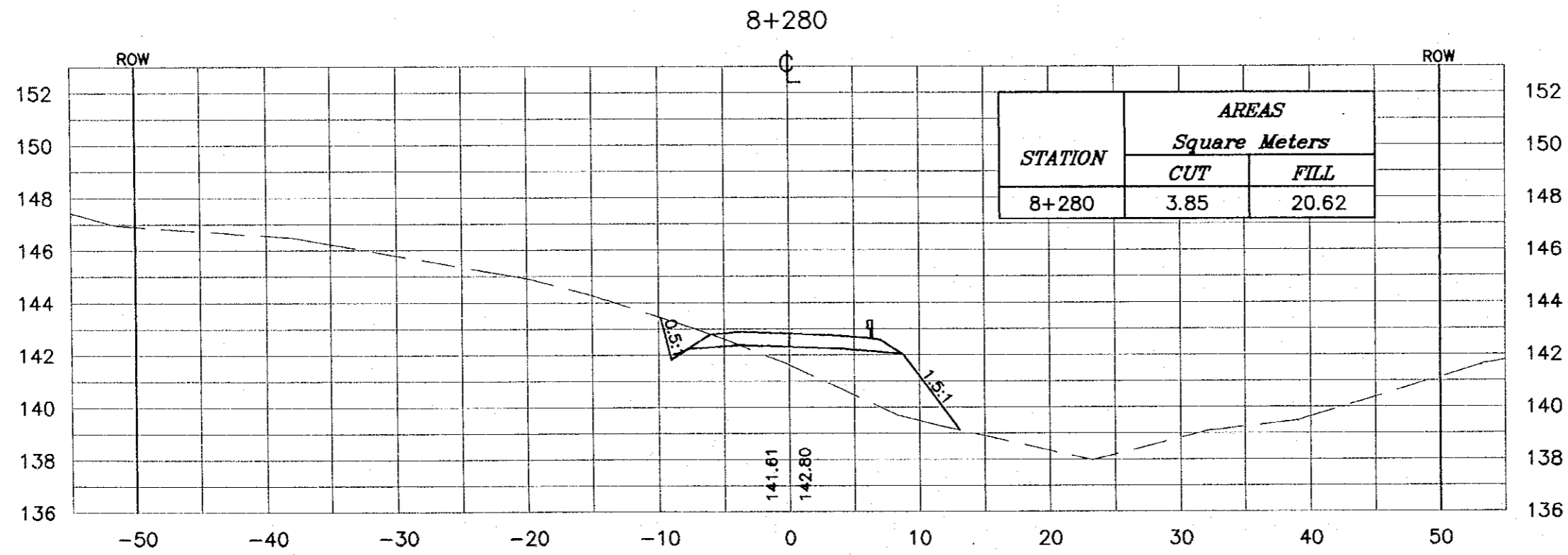
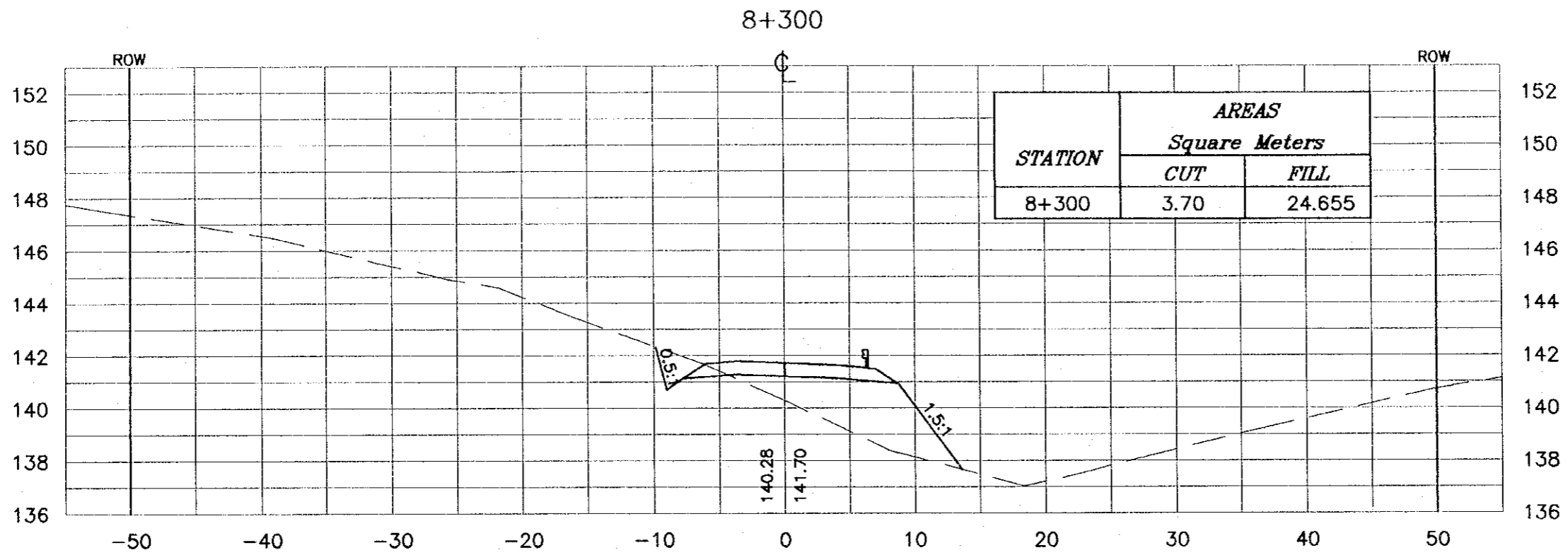

Project:
Tourism Sector Development Project
in the Hashemite Kingdom of Jordan

Executing Agency:
The Ministry of Tourism and Antiquities
The Ministry of Planning

SUB-PROJECT:
Dead Sea Parkway

Note:
This detailed design has been executed by a team of consultants as shown below in accordance with the agreement between Japan International Cooperation Agency (JICA) and JICA Study Team. The copyright of this drawing rests with JICA.

Designed by:
Japan International Cooperation Agency (JICA)

JICA Study Team:
Joint Venture of Pacific Consultants International and Yamashita Sekkei Inc.

Subcontracted Local Consultant:
 consolidated consultants
engineering & environment
Tel: 4912377 - Fax: 4912388 - AMMAN - JORDAN

Drawing Title:
CROSS-SECTION
8+280/8+300

Scale: H 1:400 V 1:200 **Drawing No.:** 347

NOTES :

- * FOR EXACT HEIGHTS AND DIMENSIONS OF BENCHES SEE TYPICAL ROAD CROSS-SECTION .
- * SLOPE H : V .

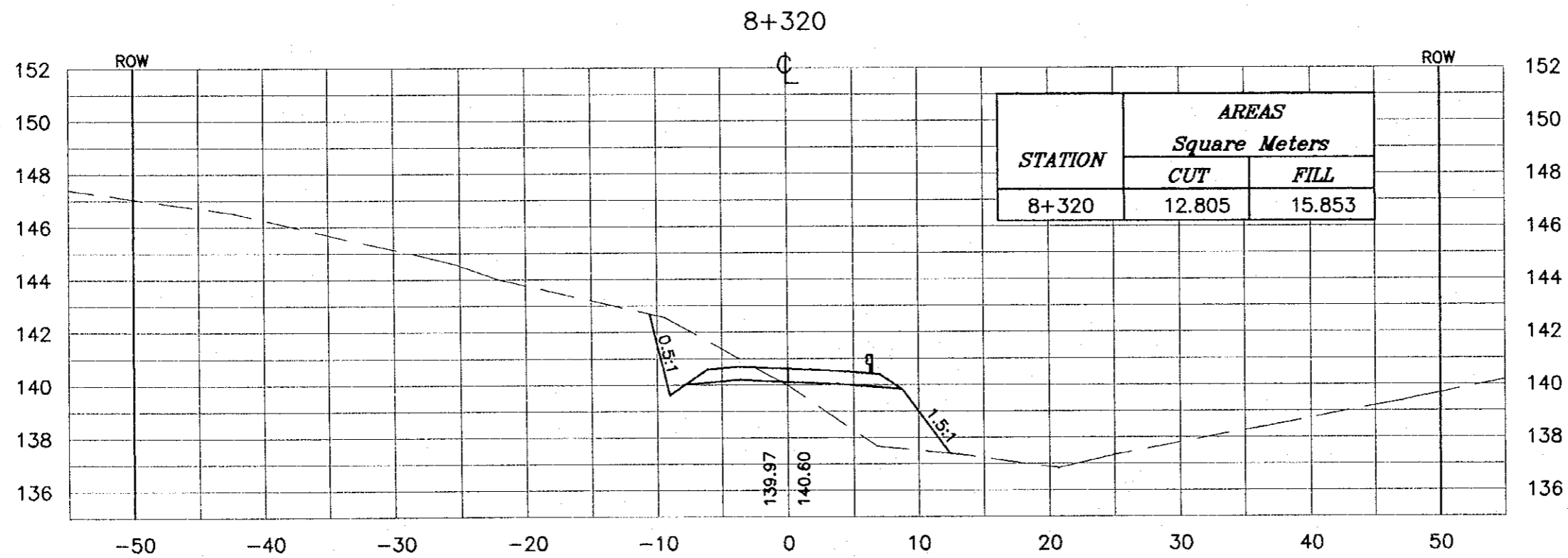
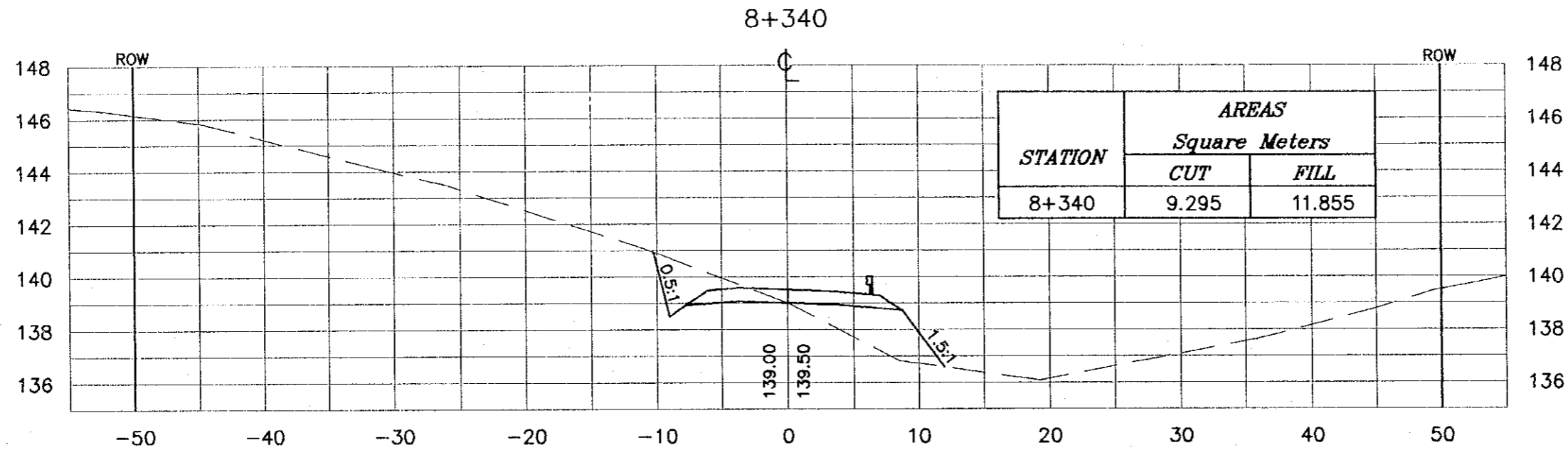

Project:
Tourism Sector Development Project
in the Hashemite Kingdom of Jordan

Executing Agency:
The Ministry of Tourism and Antiquities
The Ministry of Planning

SUB-PROJECT:
Dead Sea Parkway

Note:
This detailed design has been executed by a team of consultants as shown below in accordance with the agreement between Japan International Cooperation Agency (JICA) and JICA Study Team. The copyright of this drawing rests with JICA.

Designed by:
Japan International Cooperation Agency (JICA)

JICA Study Team:
Joint Venture of
Pacific Consultants International and
Yamashita Sekkel Inc.

Subcontracted Local Consultant:
 consolidated consultants
engineering & architecture
Tel: 4612377 - Fax: 4612360 - AMMAN - JORDAN

Drawing Title:
CROSS-SECTION
8+320/8+340

Scale: H 1:400 V 1:200 **Drawing No.:** 348

NOTES :

- * FOR EXACT HEIGHTS AND DIMENSIONS OF BENCHES SEE TYPICAL ROAD CROSS-SECTION .
- * SLOPE H : V .

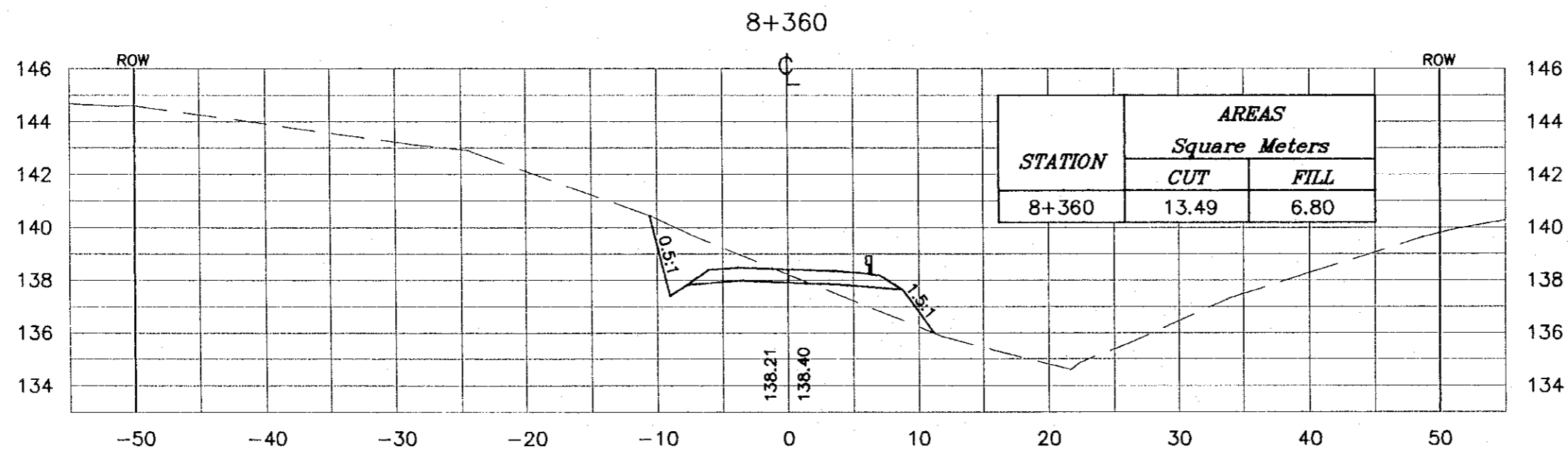
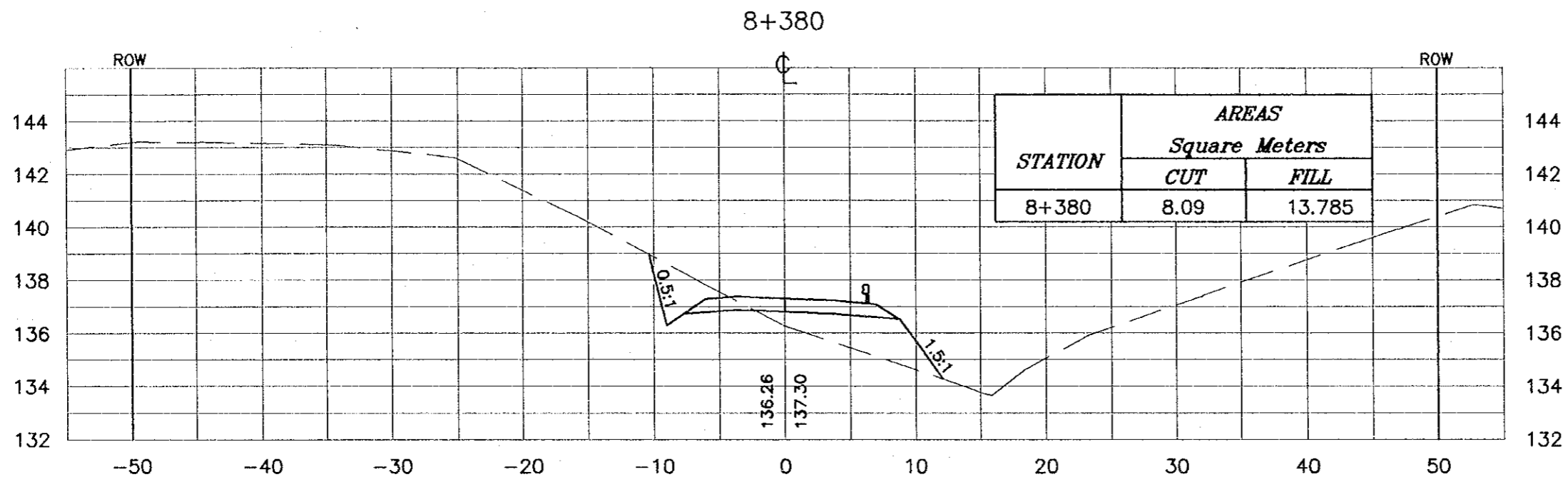

Project:
Tourism Sector Development Project
in the Hashemite Kingdom of Jordan

Executing Agency:
The Ministry of Tourism and Antiquities
The Ministry of Planning

SUB-PROJECT:
Dead Sea Parkway

Note:
This detailed design has been executed by a team of consultants as shown below in accordance with the agreement between Japan International Cooperation Agency (JICA) and JICA Study Team. The copyright of this drawing rests with JICA.

Designed by:
Japan International Cooperation Agency (JICA)

JICA Study Team:
Joint Venture of
Pacific Consultants International and
Yamashita Sekkei Inc.

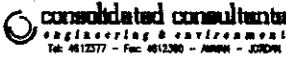
Subcontracted Local Consultant:

Tel: 411277 - Fax: 411390 - Jeddah - JSDR

Drawing Title:
CROSS-SECTION
8+360/8+380

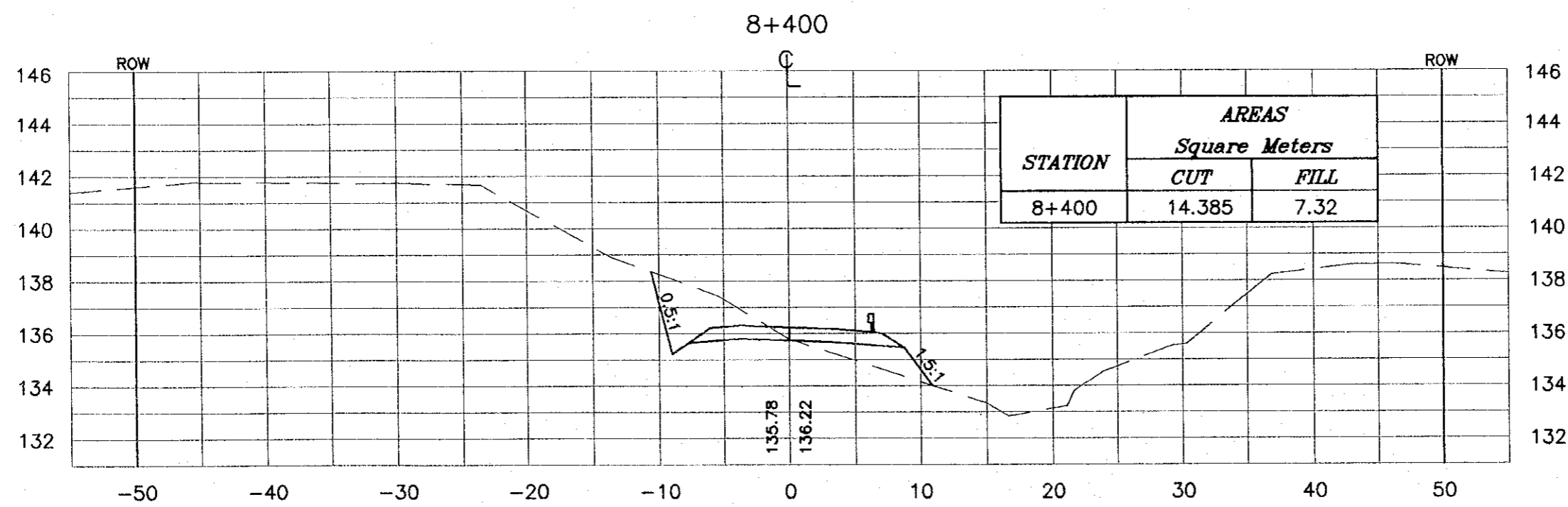
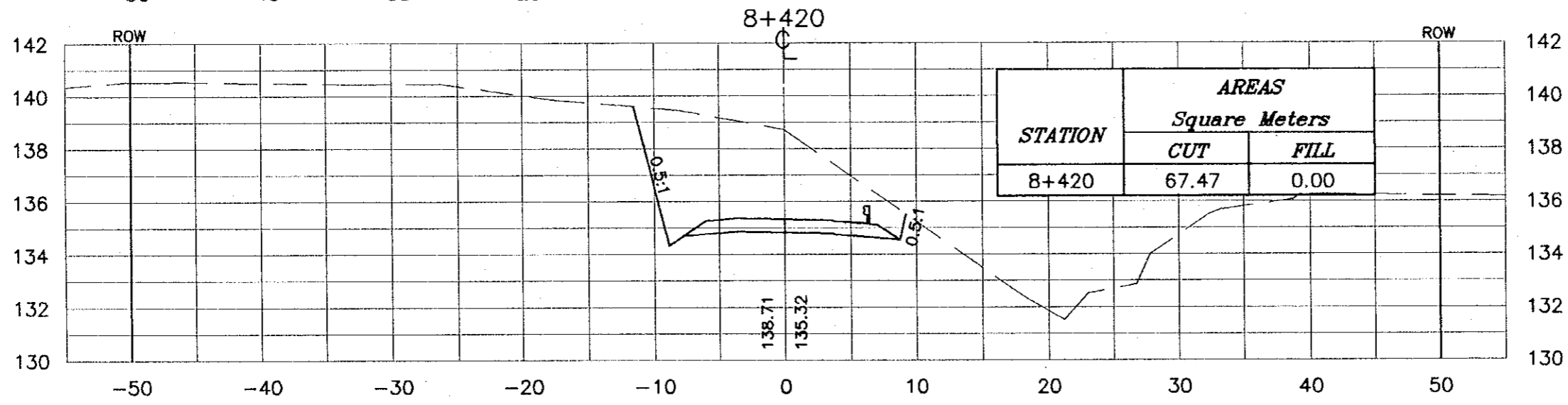
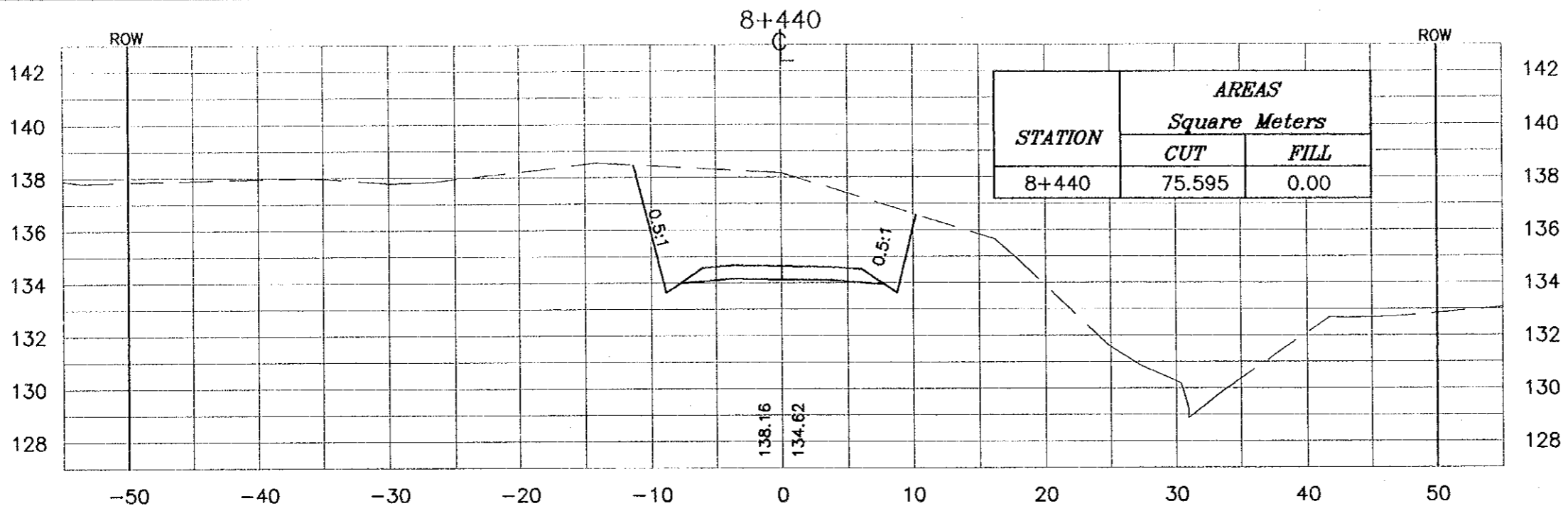
Scale: H 1:400 V 1:200 Drawing No.: 349



NOTES :
 * FOR EXACT HEIGHTS AND DIMENSIONS OF BENCHES SEE TYPICAL ROAD CROSS-SECTION .
 * SLOPE H : V .

Project:
 Tourism Sector Development Project
 in the Hashemite Kingdom of Jordan

Executing Agency:
 The Ministry of Tourism and Antiquities
 The Ministry of Planning

SUB-PROJECT:
 Dead Sea Parkway

Note:
 This detailed design has been executed by a team of consultants as shown below in accordance with the agreement between Japan International Cooperation Agency (JICA) and JICA Study Team. The copyright of this drawing rests with JICA.

Designed by:
 Japan International Cooperation Agency (JICA)

JICA Study Team:
 Joint Venture of
 Pacific Consultants International and
 Yamashita Sekkei Inc.

Subcontracted Local Consultant:

 consolidated consultants
 engineering & environment
 Tel: 9612577 - Fax: 9612309 - 96996 - 20000

Drawing Title:
 CROSS-SECTION
 8+400/8+420/8+440

Scale: H 1:400 V 1:200 **Drawing No.:** 350

NOTES :

- * FOR EXACT HEIGHTS AND DIMENSIONS OF BENCHES SEE TYPICAL ROAD CROSS-SECTION .
- * SLOPE H : V .

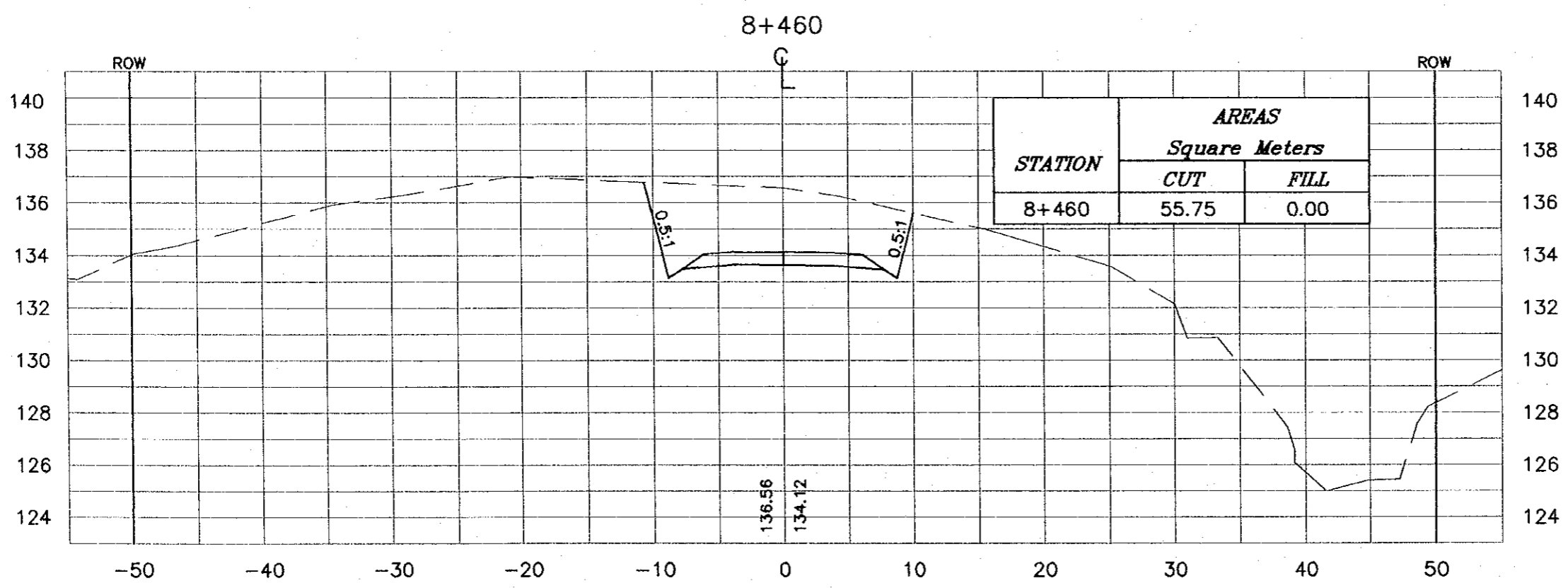
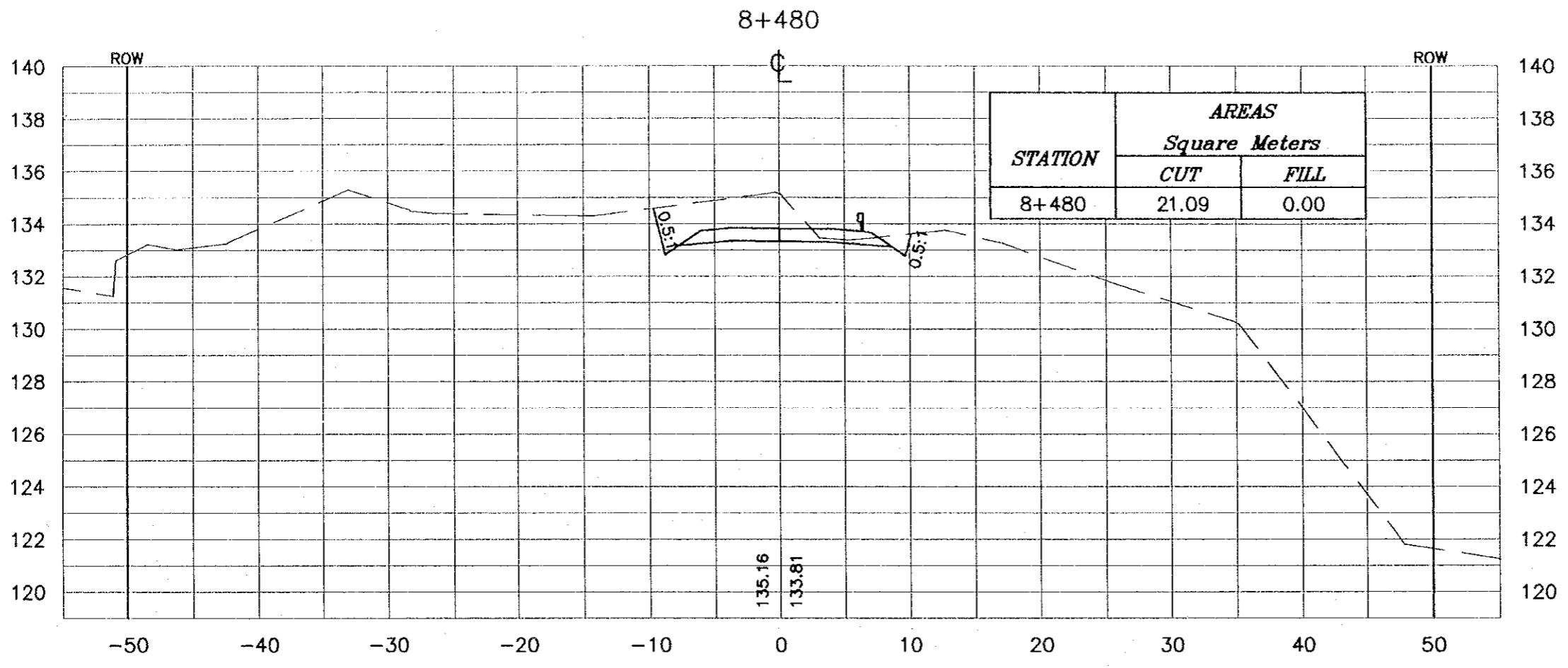

Project:
Tourism Sector Development Project
in the Hashemite Kingdom of Jordan

Executing Agency:
The Ministry of Tourism and Antiquities
The Ministry of Planning

SUB-PROJECT:
Dead Sea Parkway

Note:
This detailed design has been executed by a team of consultants as shown below in accordance with the agreement between Japan International Cooperation Agency (JICA) and JICA Study Team. The copyright of this drawing rests with JICA.

Designed by:
Japan International Cooperation Agency (JICA)

JICA Study Team:
Joint Venture of
Pacific Consultants International and
Yamashita Sekkol Inc.

Subcontracted Local Consultant:
 consolidated consultants
Engineering & Construction
Tel: 4612377 - Fax: 4612380 - AMM - JORDAN

Drawing Title:
CROSS-SECTION
8+460/8+480

Scale: H 1:400 V 1:200 **Drawing No.:** 351

NOTES :

- * FOR EXACT HEIGHTS AND DIMENSIONS OF BENCHES SEE TYPICAL ROAD CROSS-SECTION .
- * SLOPE H : V .

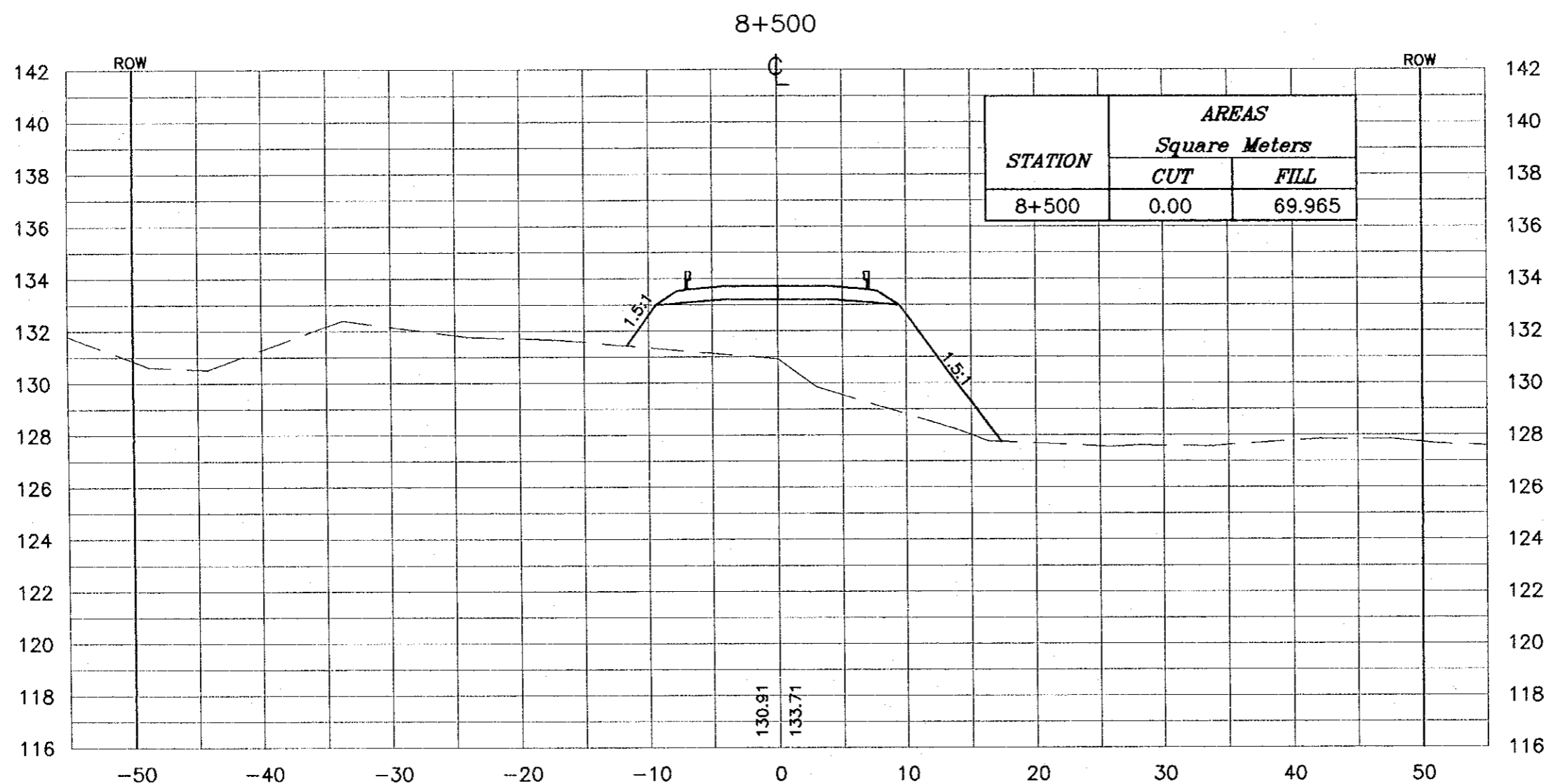

Project:
Tourism Sector Development Project
in the Hashemite Kingdom of Jordan

Executing Agency:
The Ministry of Tourism and Antiquities
The Ministry of Planning

SUB-PROJECT:
Dead Sea Parkway

Note:
This detailed design has been executed by a team of consultants as shown below in accordance with the agreement between Japan International Cooperation Agency (JICA) and JICA Study Team. The copyright of this drawing rests with JICA.

Designed by:
Japan International Cooperation Agency (JICA)

JICA Study Team:
Joint Venture of
Pacific Consultants International and
Yamashita Sekkei Inc.

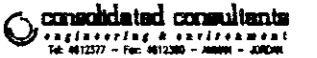
Subcontracted Local Consultant:

consolidated consultants
engineering & environment
Tel: 962577 - Fax: 962586 - AMMAN - JORDAN

Drawing Title:
CROSS-SECTION
8+500

Scale: H 1:400 V 1:200 **Drawing No.:** 352

NOTES :

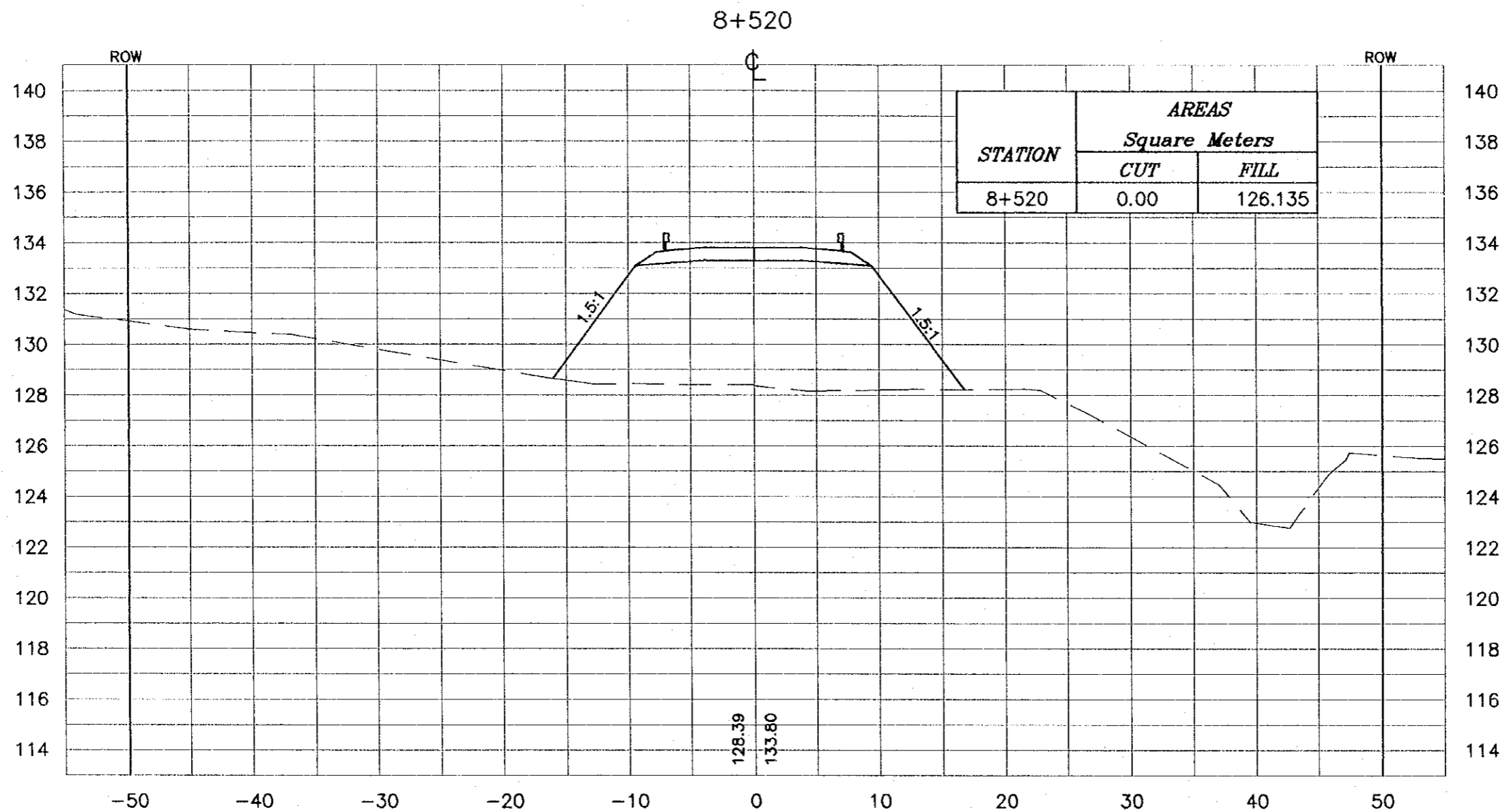
- * FOR EXACT HEIGHTS AND DIMENSIONS OF BENCHES SEE TYPICAL ROAD CROSS-SECTION .
- * SLOPE H : V .



Project:
Tourism Sector Development Project
in the Hashemite Kingdom of Jordan

Executing Agency:
The Ministry of Tourism and Antiquities
The Ministry of Planning

SUB-PROJECT:
Dead Sea Parkway

Note:
This detailed design has been executed by a team of consultants as shown below in accordance with the agreement between Japan International Cooperation Agency (JICA) and JICA Study Team. The copyright of this drawing rests with JICA.

Designed by:
Japan International Cooperation Agency (JICA)

JICA Study Team:
Joint Venture of Pacific Consultants International and Yamashita Sekkel Inc.

Subcontracted Local Consultant:

Tel: 4112777 - Fax: 4112200 - AMMAN - JORDAN

Drawing Title:
CROSS-SECTION
8+520

Scale: H 1:400 V 1:200 **Drawing No.:** 353

NOTES :

- * FOR EXACT HEIGHTS AND DIMENSIONS OF BENCHES SEE TYPICAL ROAD CROSS-SECTION .
- * SLOPE H : V .

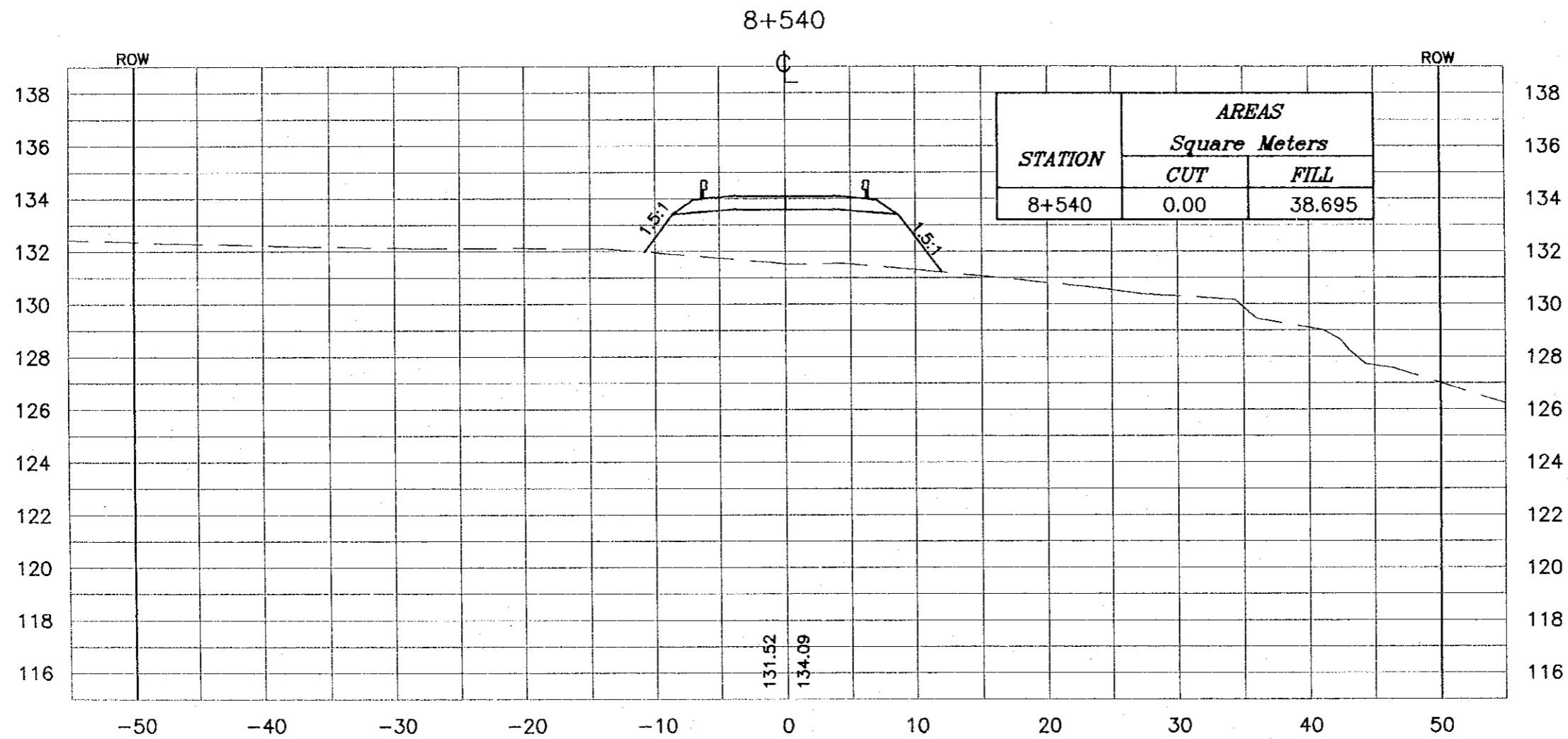

Project:
Tourism Sector Development Project
in the Hashemite Kingdom of Jordan

Executing Agency:
The Ministry of Tourism and Antiquities
The Ministry of Planning

SUB-PROJECT:
Dead Sea Parkway

Note:
This detailed design has been executed by a team of consultants as shown below in accordance with the agreement between Japan International Cooperation Agency (JICA) and JICA Study Team. The copyright of this drawing rests with JICA.

Designed by:
Japan International Cooperation Agency (JICA)

JICA Study Team:
Joint Venture of
Pacific Consultants International and
Yamashita Sekkei Inc.

Subcontracted Local Consultant:
 consolidated consultants
PROFESSIONAL CONSULTANTS
Tel: 412277 - Fax: 412280 - AMMAN - JORDAN

Drawing Title:
CROSS-SECTION
8+540

Scale: H 1:400 Drawing No.: 354
V 1:200

NOTES :

- * FOR EXACT HEIGHTS AND DIMENSIONS OF BENCHES SEE TYPICAL ROAD CROSS-SECTION .
- * SLOPE H : V .

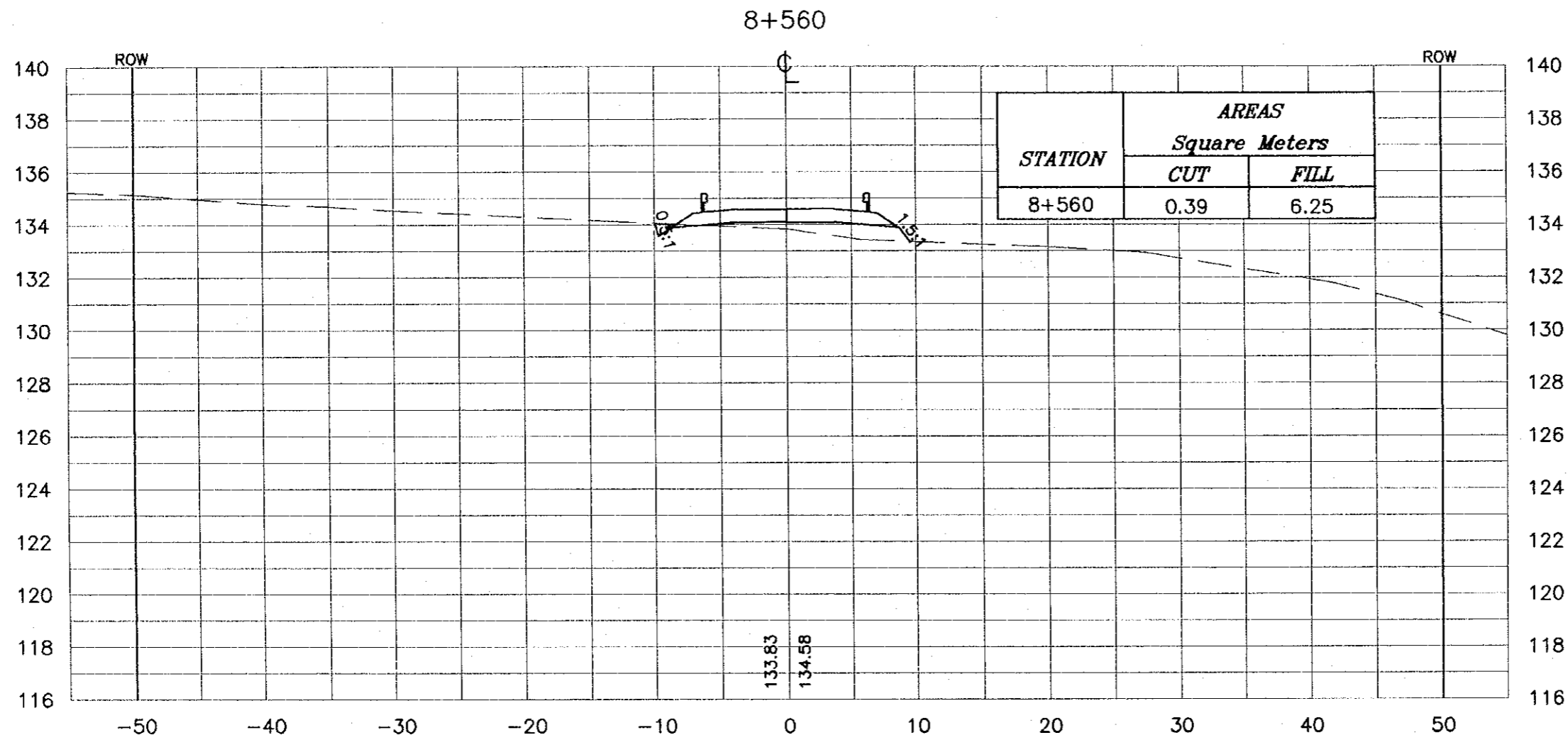

Project:
Tourism Sector Development Project
in the Hashemite Kingdom of Jordan

Executing Agency:
The Ministry of Tourism and Antiquities
The Ministry of Planning

SUB-PROJECT:
Dead Sea Parkway

Note:
This detailed design has been executed by a team of consultants as shown below in accordance with the agreement between Japan International Cooperation Agency (JICA) and JICA Study Team. The copyright of this drawing rests with JICA.

Designed by:
Japan International Cooperation Agency (JICA)

JICA Study Team:
Joint Venture of
Pacific Consultants International and
Yamashita Sekkei Inc.

Subcontracted Local Consultant:

consolidated consultants
engineering & environment
Tel: 961277 - Fax: 961280 - AMMAN - JORDAN

Drawing Title:
CROSS-SECTION
8+560

Scale: H 1:400 V 1:200 **Drawing No.:** 355

NOTES :

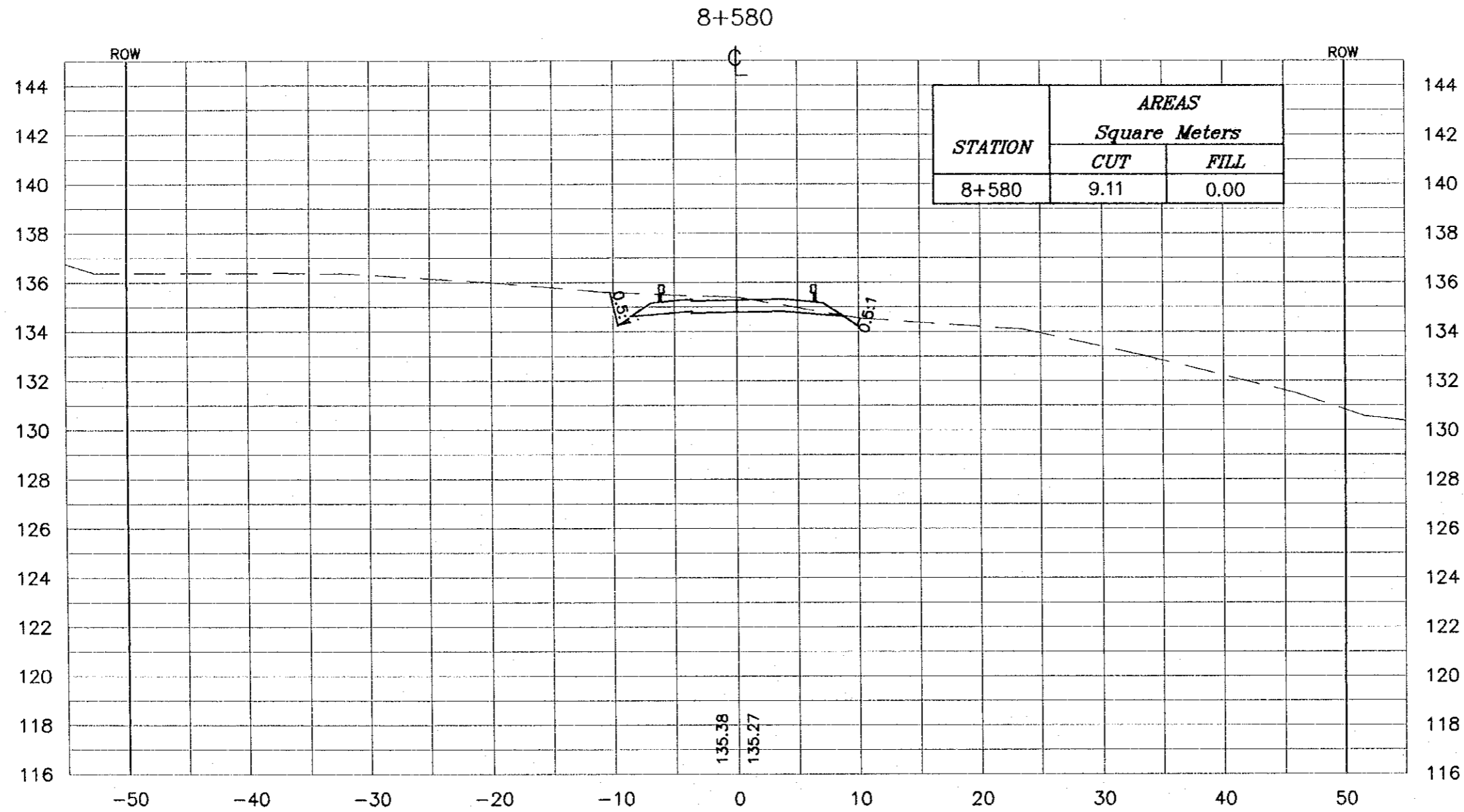
- * FOR EXACT HEIGHTS AND DIMENSIONS OF BENCHES SEE TYPICAL ROAD CROSS-SECTION .
- * SLOPE H : V .



Project:
Tourism Sector Development Project
in the Hashemite Kingdom of Jordan

Executing Agency:
The Ministry of Tourism and Antiquities
The Ministry of Planning

SUB-PROJECT:
Dead Sea Parkway

Note:
This detailed design has been executed by a team of consultants as shown below in accordance with the agreement between Japan International Cooperation Agency (JICA) and JICA Study Team. The copyright of this drawing rests with JICA.

Designed by:
Japan International Cooperation Agency (JICA)

JICA Study Team:
Joint Venture of
Pacific Consultants International and
Yamashita Sekkel Inc.

Subcontracted Local Consultant:
 consolidated consultants
engineering & environment
Tel: 9612377 - Fax: 9612380 - AMMAN - JORDAN

Drawing Title:
CROSS-SECTION
8+580

Scale: H 1:400 V 1:200 **Drawing No.:** 356

NOTES :

- * FOR EXACT HEIGHTS AND DIMENSIONS OF BENCHES SEE TYPICAL ROAD CROSS-SECTION .
- * SLOPE H : V .

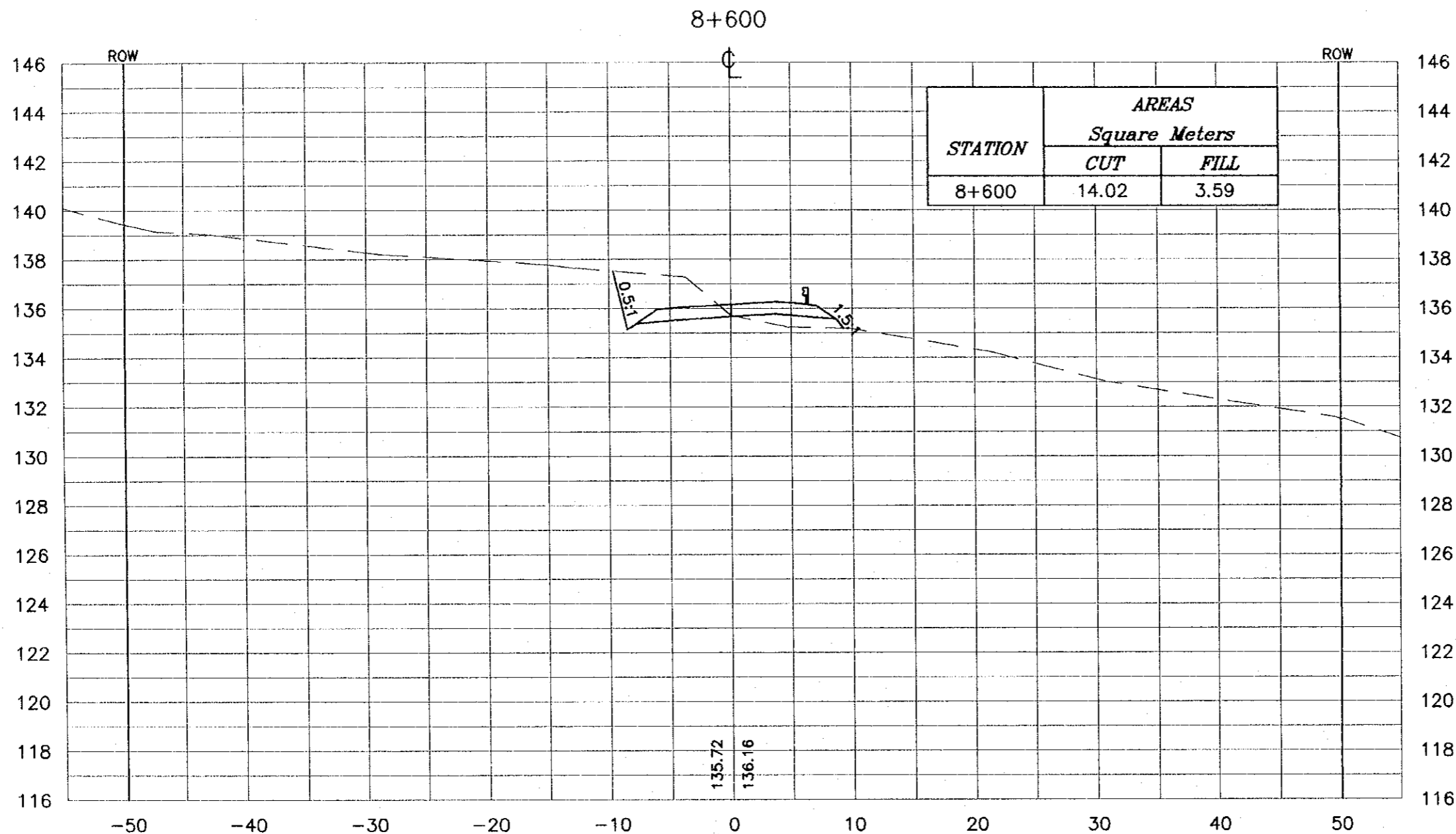

Project:
Tourism Sector Development Project
in the Hashemite Kingdom of Jordan

Executing Agency:
The Ministry of Tourism and Antiquities
The Ministry of Planning

SUB-PROJECT:
Dead Sea Parkway

Note:
This detailed design has been executed by a team of consultants as shown below in accordance with the agreement between Japan International Cooperation Agency (JICA) and JICA Study Team. The copyright of this drawing rests with JICA.

Designed by:
Japan International Cooperation Agency (JICA)

JICA Study Team:
Joint Venture of
Pacific Consultants International and
Yamato Sekkei Inc.

Subcontracted Local Consultant:
 consolidated consultants
engineering & environment
Tel: 412377 - Fax: 412380 - JORDAN - 22021

Drawing Title:
CROSS-SECTION
8+600

Scale: H 1:400 V 1:200 **Drawing No.:** 357

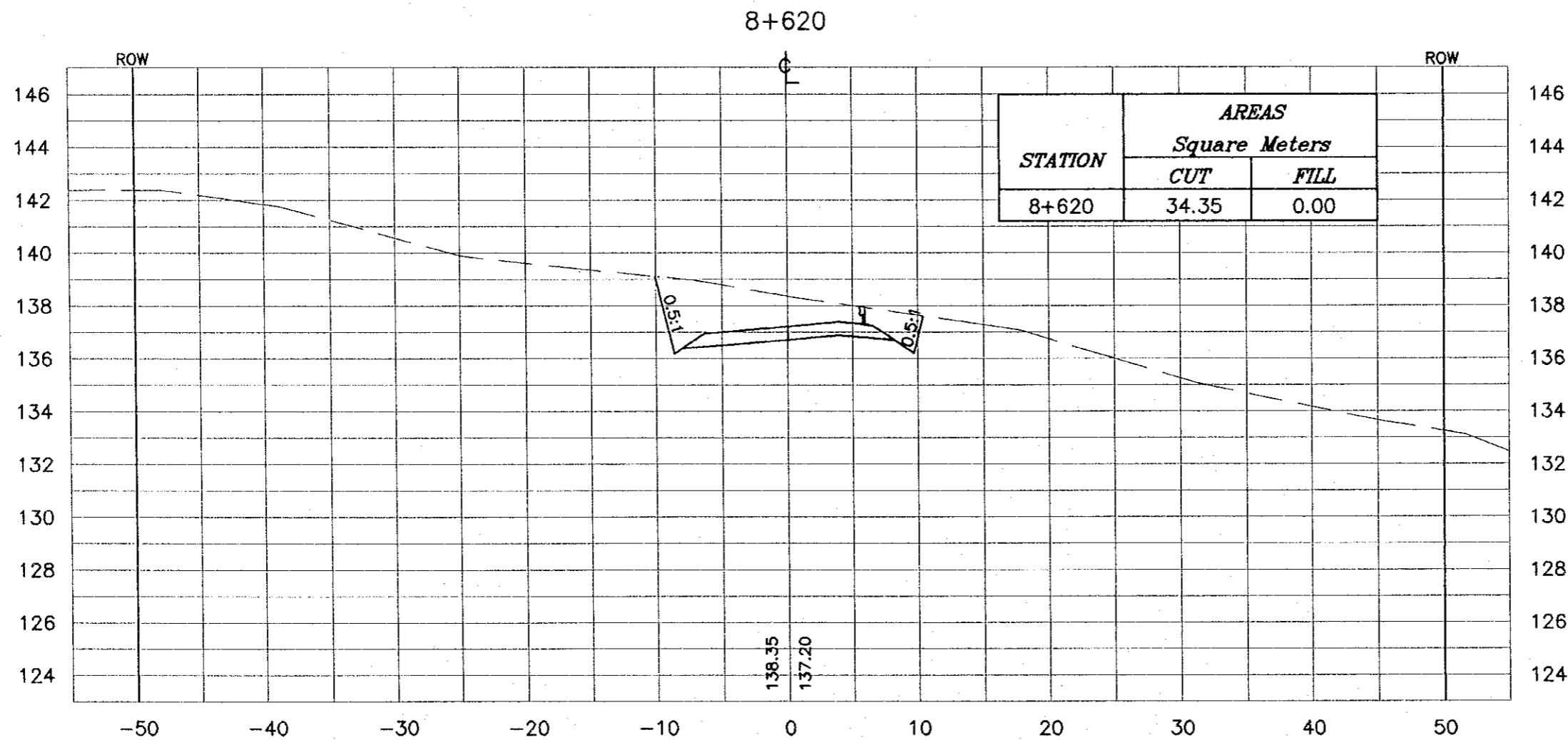
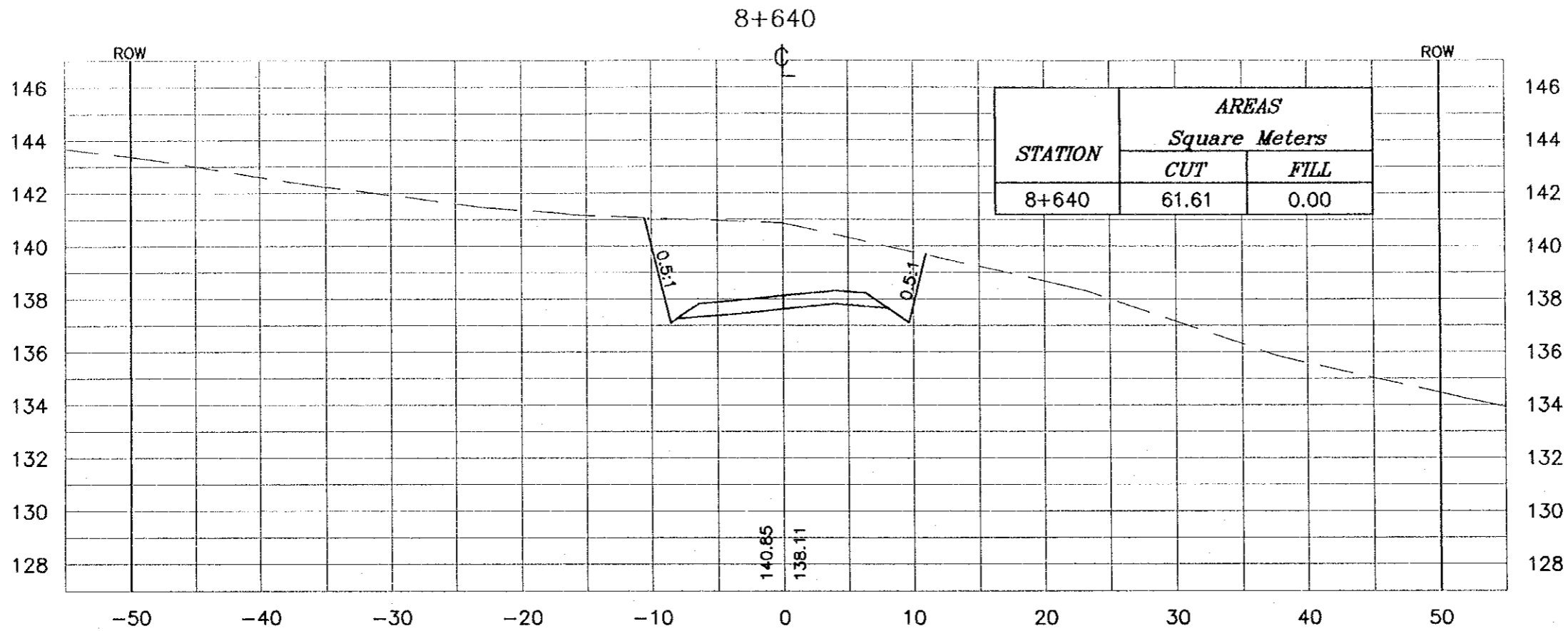

NOTES :

- * FOR EXACT HEIGHTS AND DIMENSIONS OF BENCHES SEE TYPICAL ROAD CROSS-SECTION .
- * SLOPE H : V .

Project:
Tourism Sector Development Project
in the Hashemite Kingdom of Jordan

Executing Agency:
The Ministry of Tourism and Antiquities
The Ministry of Planning

SUB-PROJECT:
Dead Sea Parkway

Note:
This detailed design has been executed by a team of consultants as shown below in accordance with the agreement between Japan International Cooperation Agency (JICA) and JICA Study Team.
The copyright of this drawing rests with JICA.

Designed by:
Japan International Cooperation Agency (JICA)

JICA Study Team:
Joint Venture of Pacific Consultants International and Yamashita Sekkei Inc.

Subcontracted Local Consultant:
 consolidated consultants
Engineering & Environment
Tel: 0012377 - Fax: 0012380 - AMMAN - JORDAN

Drawing Title:
CROSS-SECTION
8+620/8+640

Scale: H 1:400 V 1:200 **Drawing No.:** 358

NOTES :

- * FOR EXACT HEIGHTS AND DIMENSIONS OF BENCHES SEE TYPICAL ROAD CROSS-SECTION .
- * SLOPE H : V .

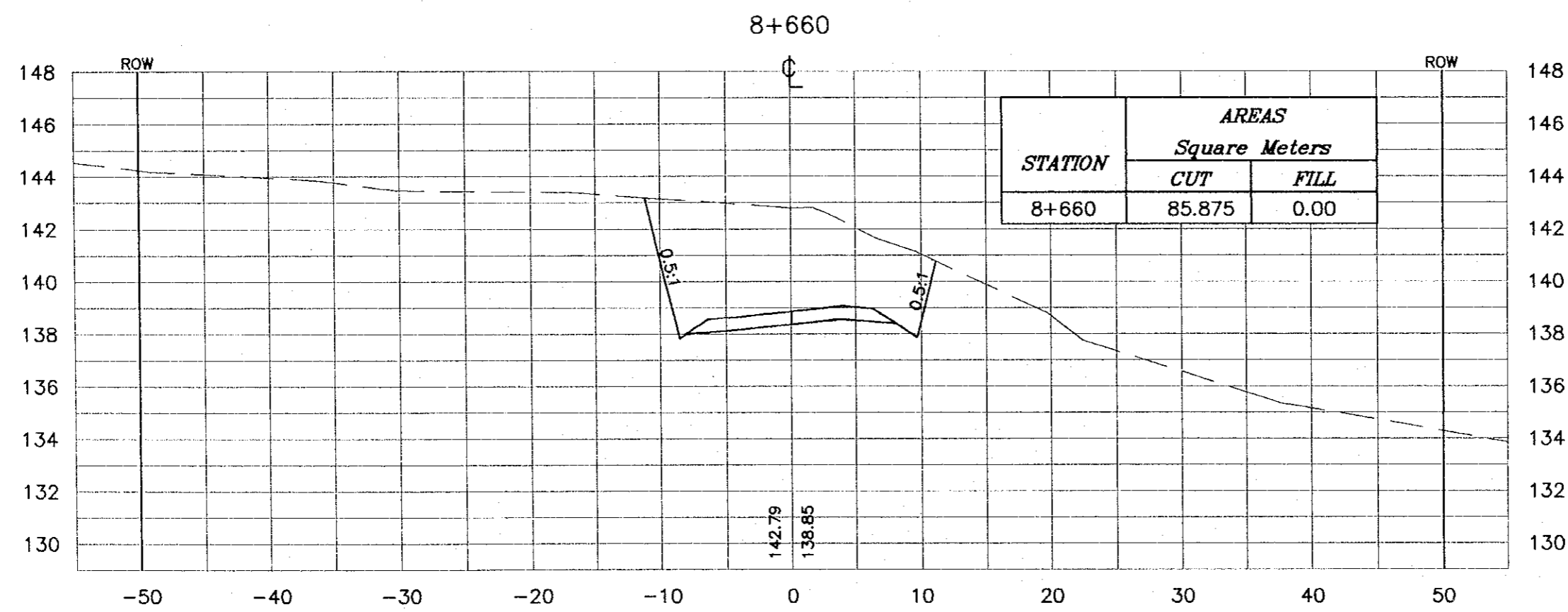
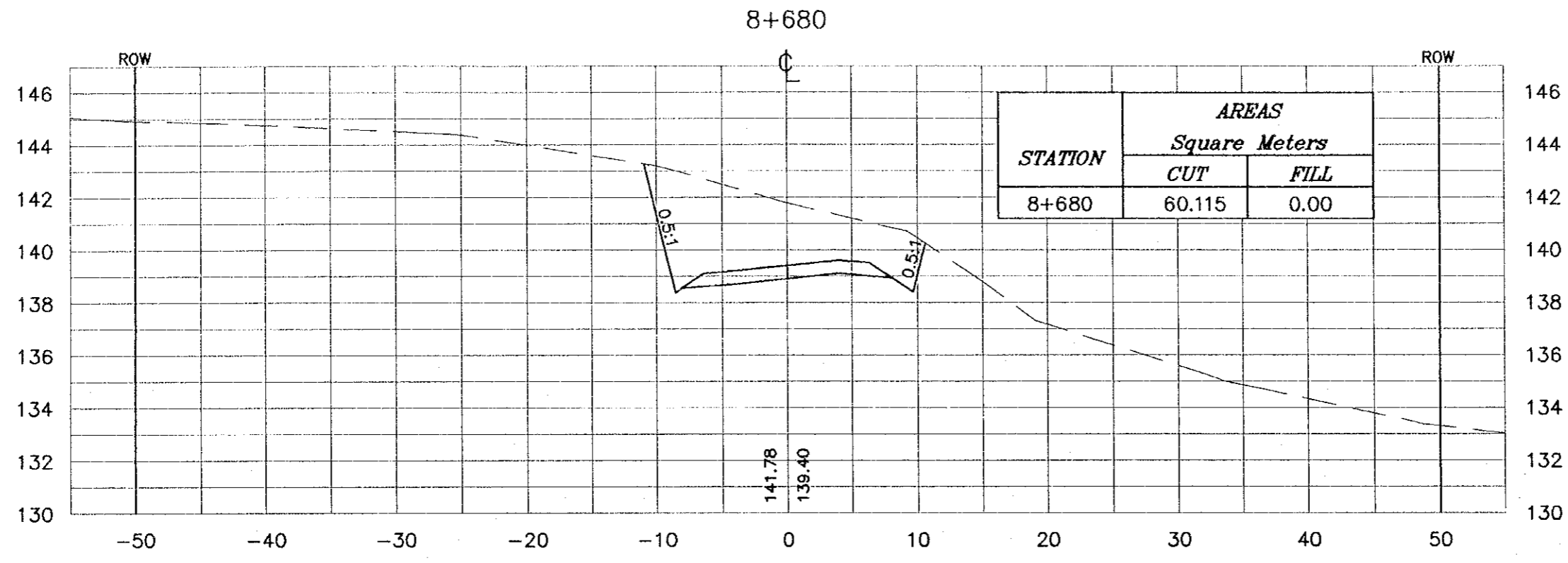

Project:
Tourism Sector Development Project
in the Hashemite Kingdom of Jordan

Executing Agency:
The Ministry of Tourism and Antiquities
The Ministry of Planning

SUB-PROJECT:
Dead Sea Parkway

Note:
This detailed design has been executed by
a team of consultants as shown below in
accordance with the agreement between
Japan International Cooperation Agency
(JICA) and JICA Study Team.
The copyright of this drawing rests with JICA.

Designed by:
Japan International Cooperation
Agency (JICA)

JICA Study Team:
Joint Venture of
Pacific Consultants International and
Yamashita Sekkei Inc.

Subcontracted Local Consultant:
 consolidated consultants
engineering & environment
Tel: 4612377 - Fax: 4612380 - AMMAN - JORDAN

Drawing Title:
CROSS-SECTION
8+660/8+680

Scale: H 1:400 V 1:200 **Drawing No.:** 359

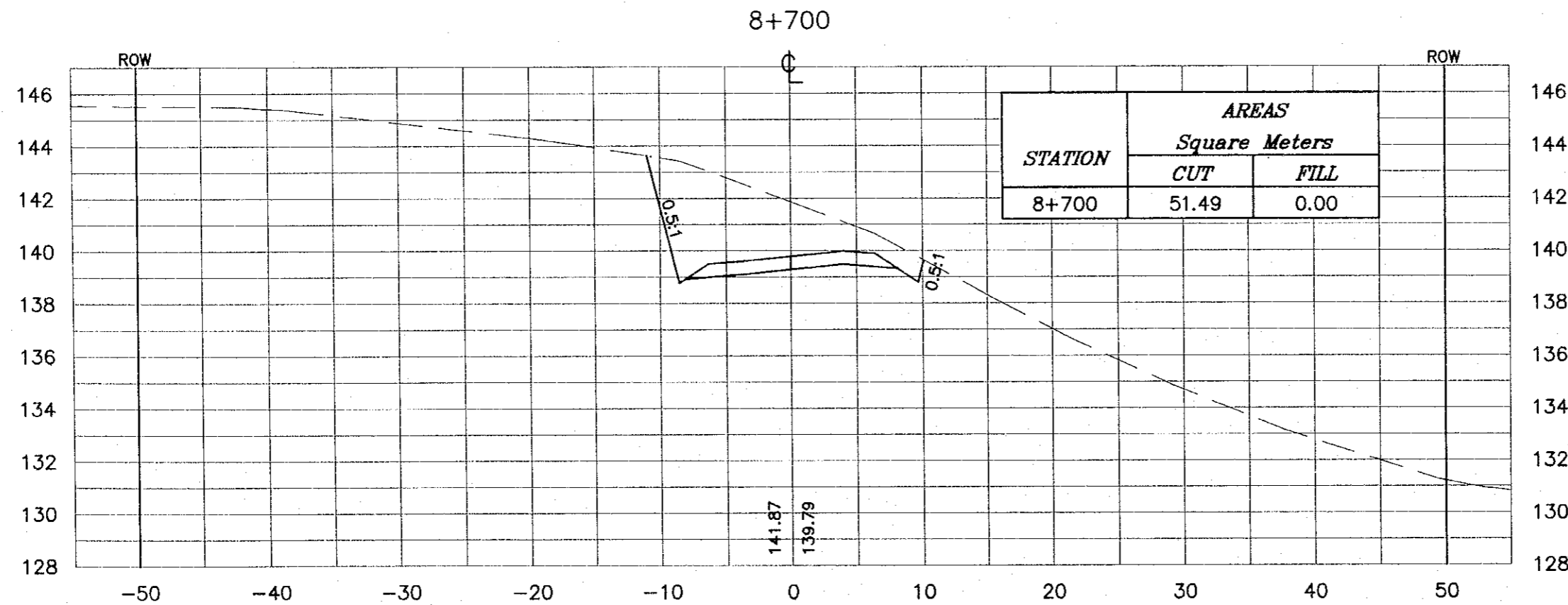
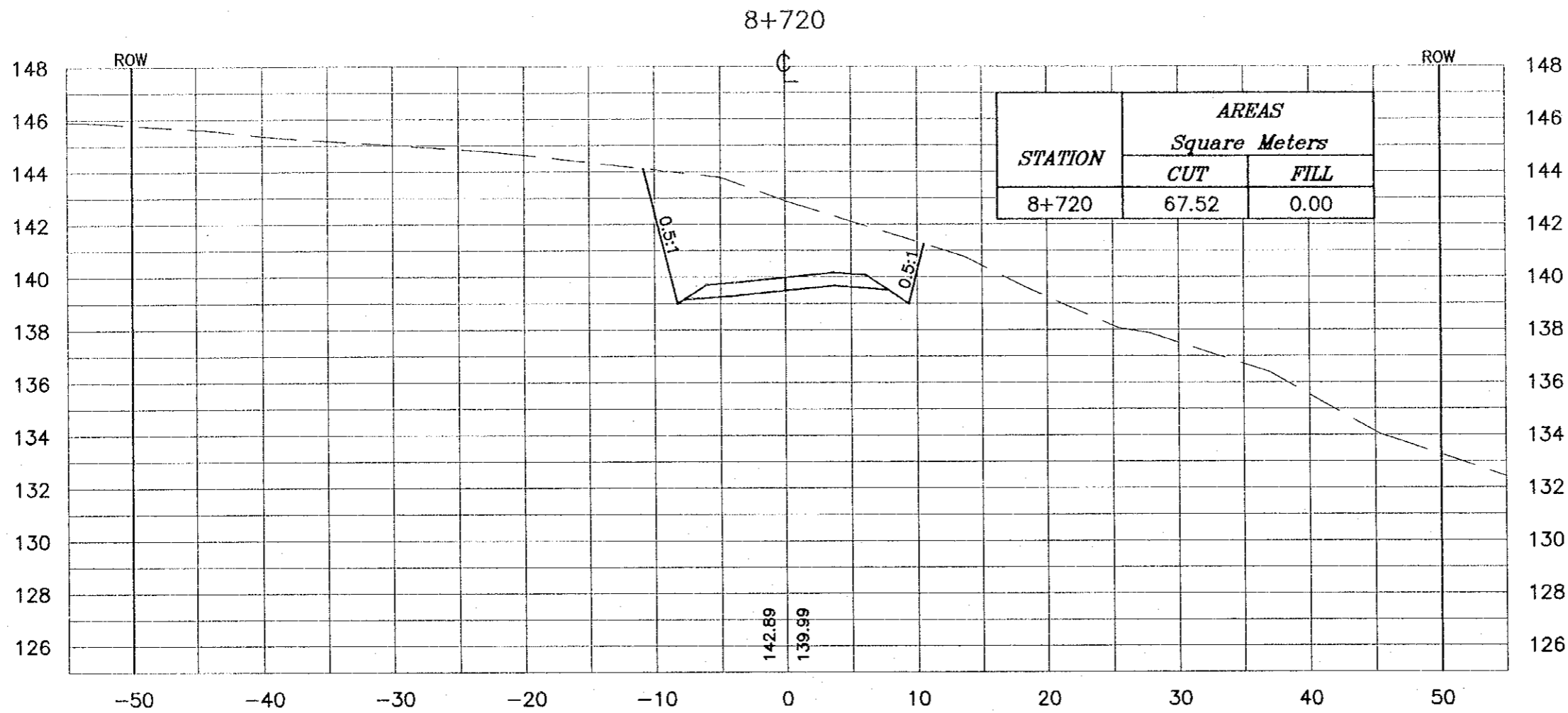

NOTES :

- * FOR EXACT HEIGHTS AND DIMENSIONS OF BENCHES SEE TYPICAL ROAD CROSS-SECTION .
- * SLOPE H : V .

Project:
Tourism Sector Development Project
in the Hashemite Kingdom of Jordan

Executing Agency:
The Ministry of Tourism and Antiquities
The Ministry of Planning

SUB-PROJECT:
Dead Sea Parkway

Note:
This detailed design has been executed by a team of consultants as shown below in accordance with the agreement between Japan International Cooperation Agency (JICA) and JICA Study Team. The copyright of this drawing rests with JICA.

Designed by:
Japan International Cooperation Agency (JICA)

JICA Study Team:
Joint Venture of
Pacifica Consultants International and
Yamashita Sekido Inc.

Subcontracted Local Consultant:
 consolidated consultants
engineering & environment
Tel: 9612377 - Fax: 9612380 - AMMAN - JORDAN

Drawing Title:
CROSS-SECTION
8+700/8+720

Scale: H 1:400 V 1:200 **Drawing No.:** 360

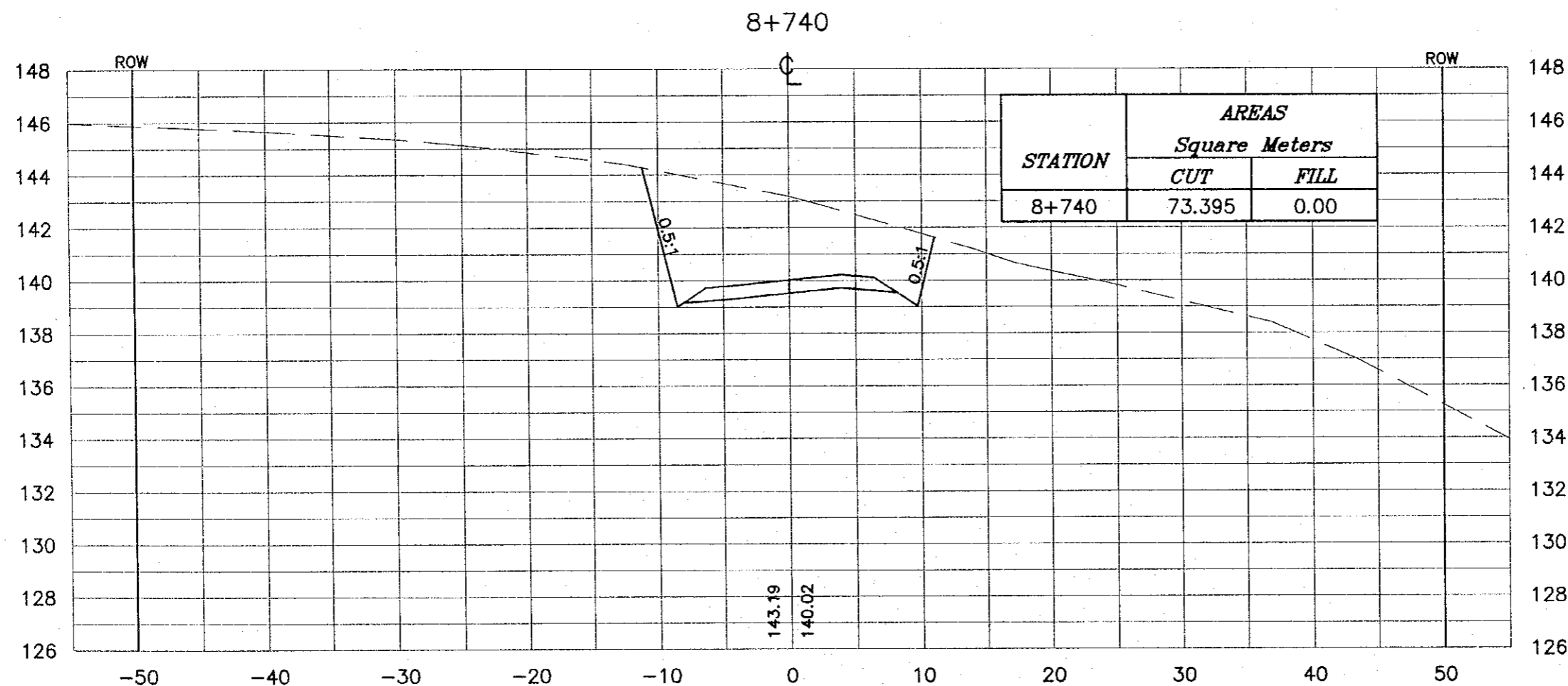
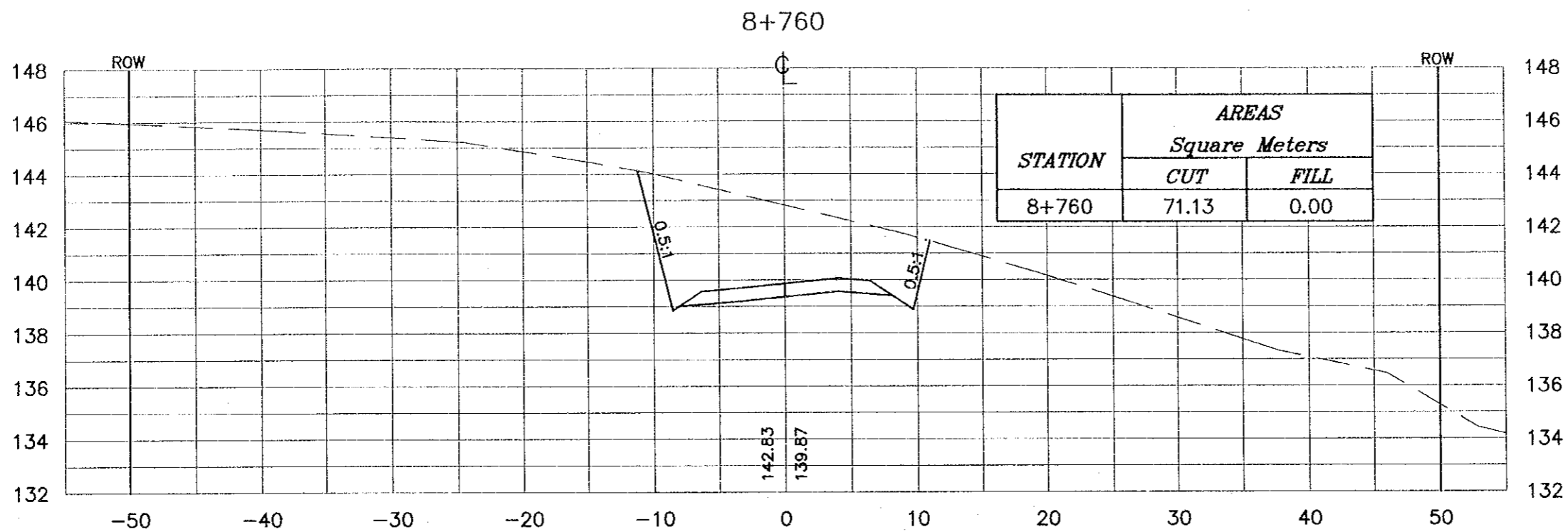

NOTES :

- * FOR EXACT HEIGHTS AND DIMENSIONS OF BENCHES SEE TYPICAL ROAD CROSS-SECTION .
- * SLOPE H : V .

Project:
Tourism Sector Development Project
in the Hashemite Kingdom of Jordan

Executing Agency:
The Ministry of Tourism and Antiquities
The Ministry of Planning

SUB-PROJECT:
Dead Sea Parkway

Note:
This detailed design has been executed by a team of consultants as shown below in accordance with the agreement between Japan International Cooperation Agency (JICA) and JICA Study Team. The copyright of this drawing rests with JICA.

Designed by:
Japan International Cooperation Agency (JICA)

JICA Study Team:
Joint Venture of
Pacific Consultants International and
Yamashita Sekkei Inc.

Subcontracted Local Consultant:

Tel: 9612377 - Fax: 9612390 - AMMAN - JORDAN

Drawing Title:
CROSS-SECTION
8+740/8+760

Scale: H 1:400 V 1:200 **Drawing No.:** 361

NOTES :

- * FOR EXACT HEIGHTS AND DIMENSIONS OF BENCHES SEE TYPICAL ROAD CROSS-SECTION .
- * SLOPE H : V .

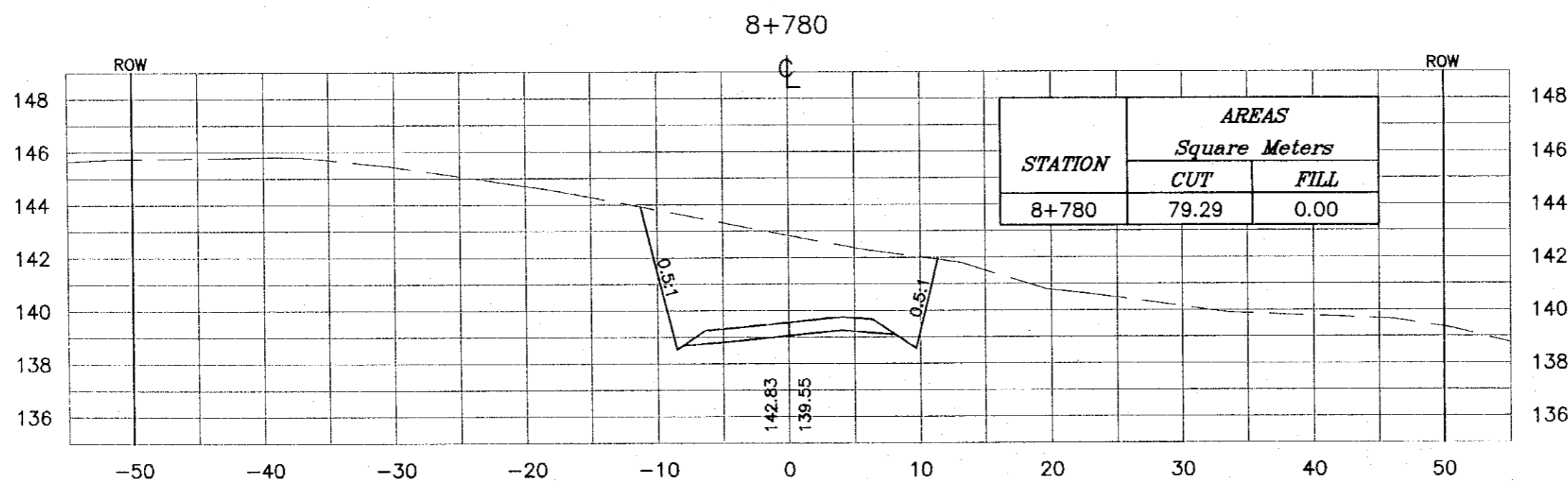
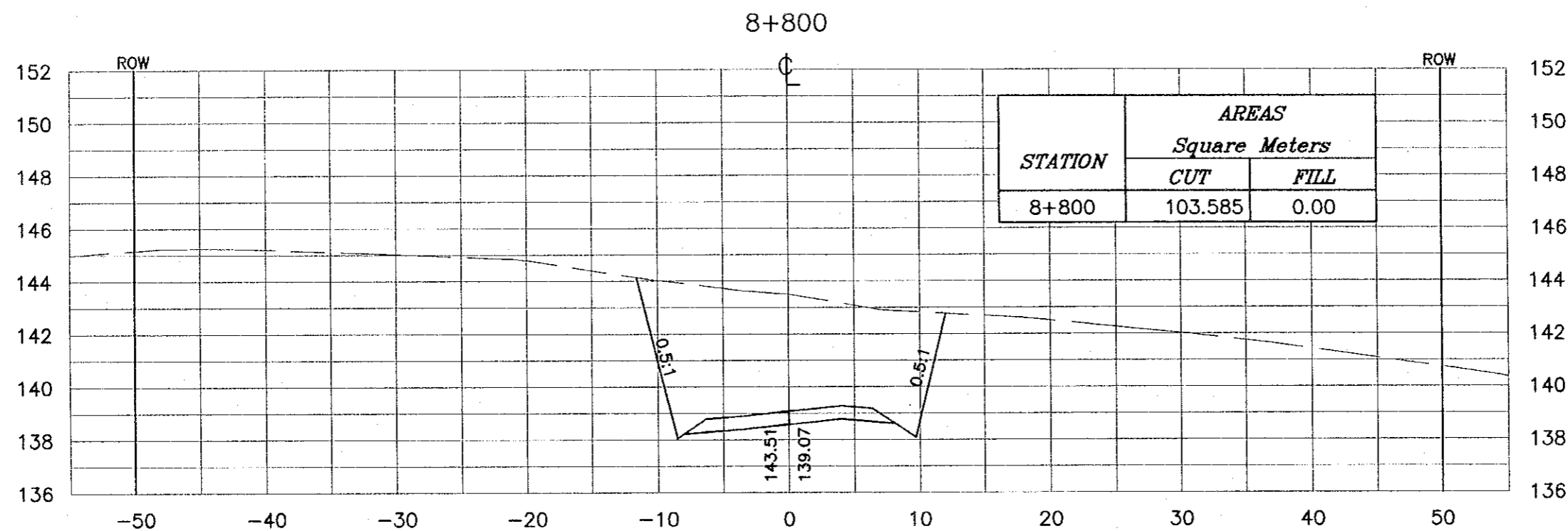

Project:
Tourism Sector Development Project
in the Hashemite Kingdom of Jordan

Executing Agency:
The Ministry of Tourism and Antiquities
The Ministry of Planning

SUB-PROJECT:
Dead Sea Parkway

Note:
This detailed design has been executed by a team of consultants as shown below in accordance with the agreement between Japan International Cooperation Agency (JICA) and JICA Study Team. The copyright of this drawing rests with JICA.

Designed by:
Japan International Cooperation Agency (JICA)

JICA Study Team:
Joint Venture of Pacific Consultants International and Yamashita Sekkei Inc.

Subcontracted Local Consultant:

ENGINEERING & ENVIRONMENT
Tel: 9612377 - Fax: 9612380 - JORDAN - AMMAN

Drawing Title:
CROSS-SECTION
8+780/8+800

Scale: H 1:400 V 1:200 **Drawing No.:** 362

NOTES :

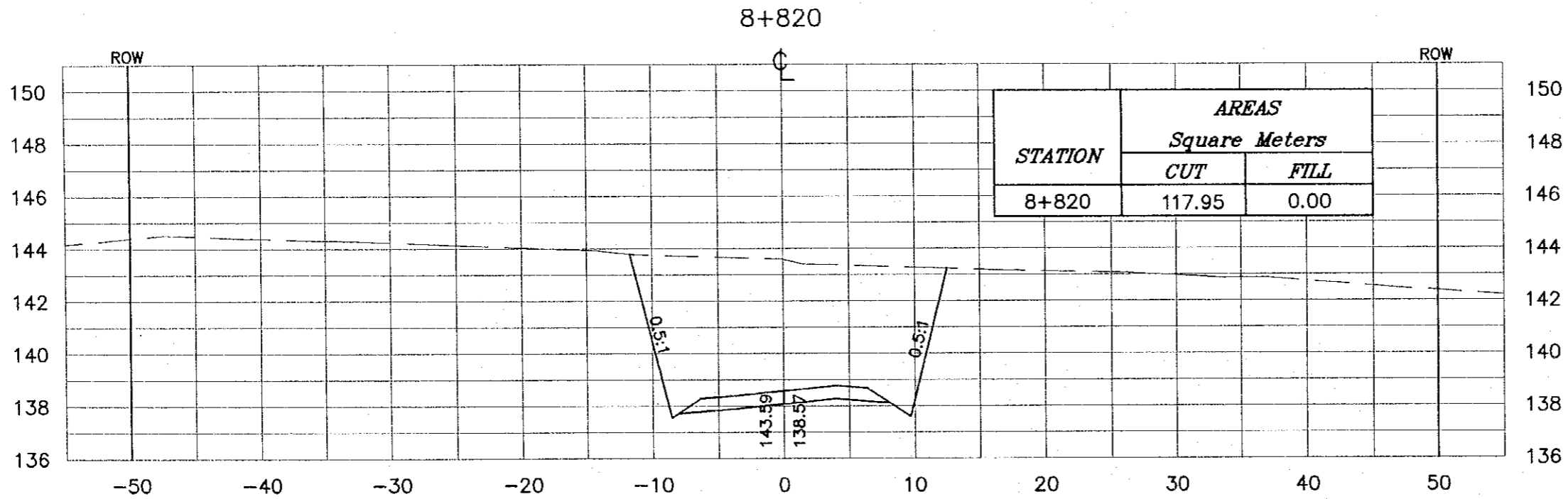
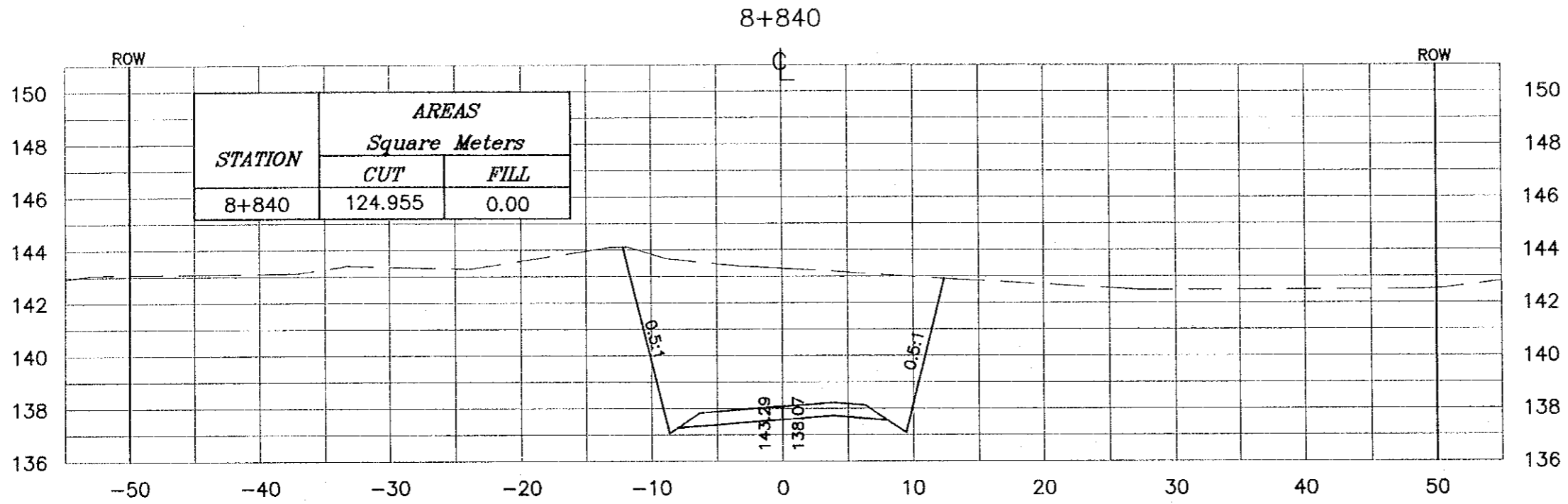
- * FOR EXACT HEIGHTS AND DIMENSIONS OF BENCHES SEE TYPICAL ROAD CROSS-SECTION .
- * SLOPE H : V .



Project:
Tourism Sector Development Project
in the Hashemite Kingdom of Jordan

Executing Agency:
The Ministry of Tourism and Antiquities
The Ministry of Planning

SUB-PROJECT:
Dead Sea Parkway

Note:
This detailed design has been executed by a team of consultants as shown below in accordance with the agreement between Japan International Cooperation Agency (JICA) and JICA Study Team. The copyright of this drawing rests with JICA.

Designed by:
Japan International Cooperation Agency (JICA)

JICA Study Team:
Joint Venture of Pacific Consultants International and Yamashita Sekkel Inc.

Subcontracted Local Consultant:
 consolidated consultants
engineering & environment
Tel: 9612377 - Fax: 9612380 - AMMAN - JORDAN

Drawing Title:
CROSS-SECTION
8+820/8+840

Scale: H 1:400 V 1:200 **Drawing No.:** 363

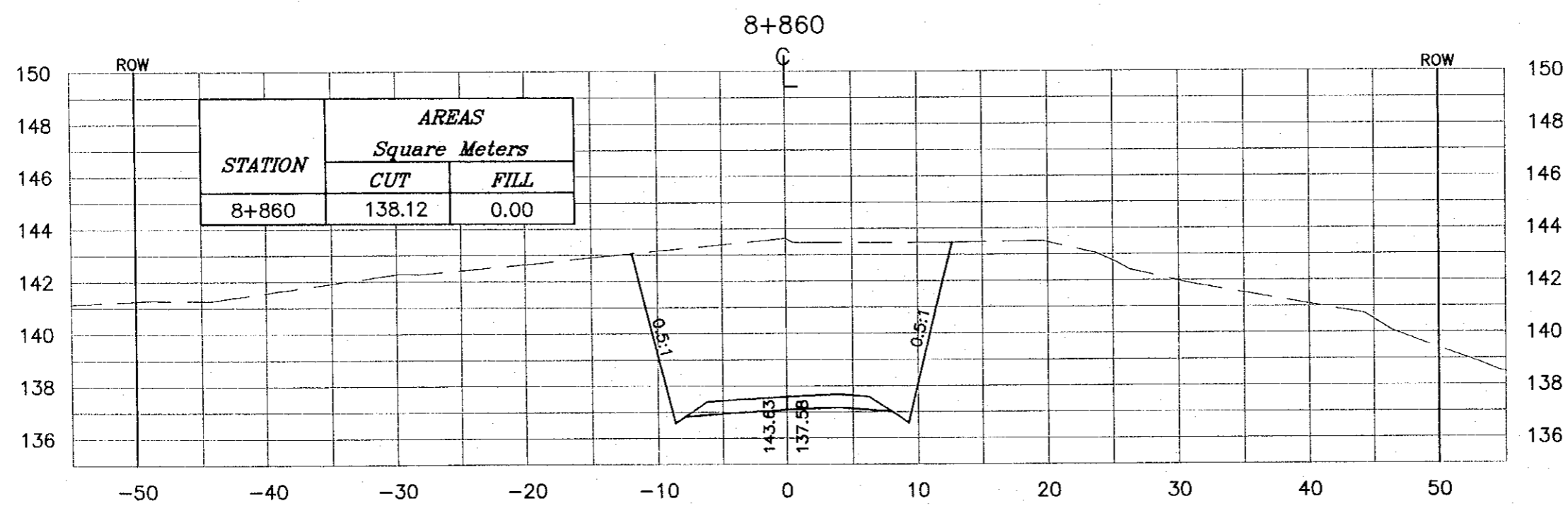
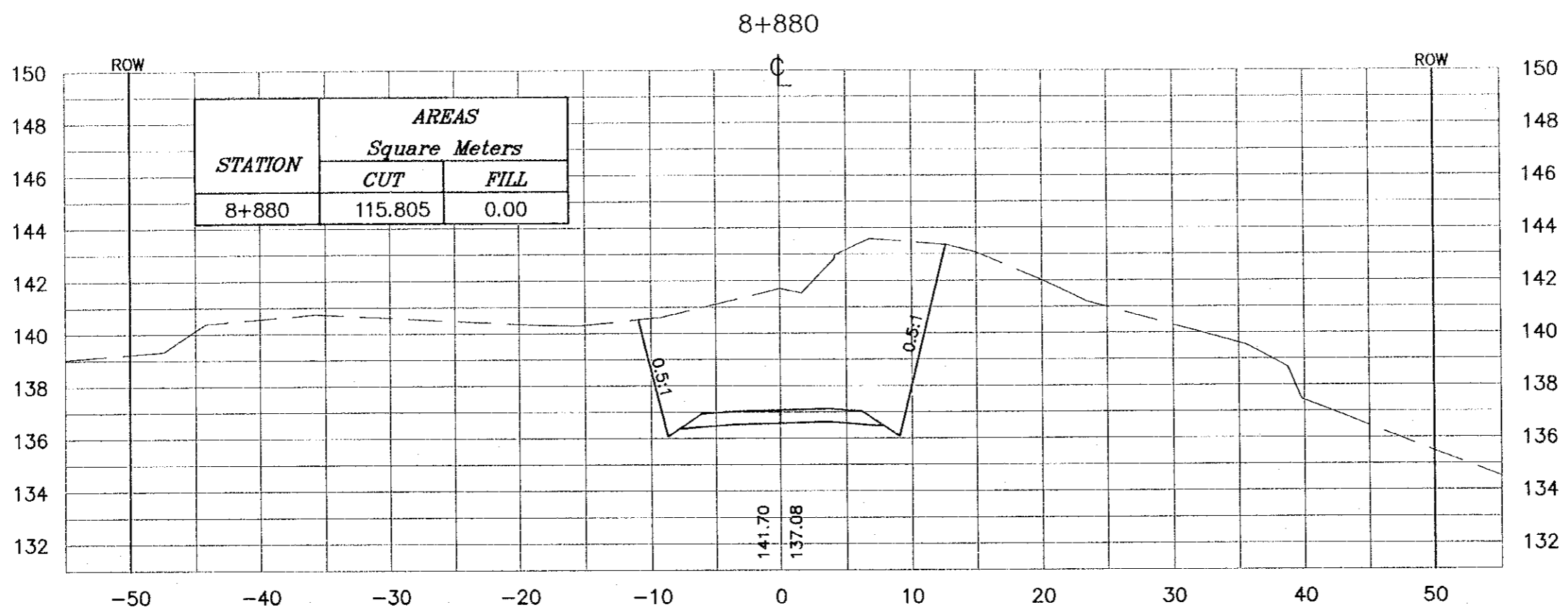

NOTES :
 * FOR EXACT HEIGHTS AND DIMENSIONS OF BENCHES SEE TYPICAL ROAD CROSS-SECTION .
 * SLOPE H : V .

Project:
 Tourism Sector Development Project
 in the Hashemite Kingdom of Jordan

Executing Agency:
 The Ministry of Tourism and Antiquities
 The Ministry of Planning

SUB-PROJECT:
 Dead Sea Parkway

Note:
 This detailed design has been executed by a team of consultants as shown below in accordance with the agreement between Japan International Cooperation Agency (JICA) and JICA Study Team. The copyright of this drawing rests with JICA.

Designed by:
 Japan International Cooperation Agency (JICA)

JICA Study Team:
 Joint Venture of
 Pacific Consultants International and
 Yamashita Sekkei Inc.

Subcontracted Local Consultant:

 consolidated consultants
 engineering & environment
 Tel: 9612377 - Fax: 9612360 - AMMAN - JORDAN

Drawing Title:
 CROSS-SECTION
 8+860/8+880

Scale: H 1:400 V 1:200 **Drawing No.:** 364

NOTES :

- * FOR EXACT HEIGHTS AND DIMENSIONS OF BENCHES SEE TYPICAL ROAD CROSS-SECTION .
- * SLOPE H : V .

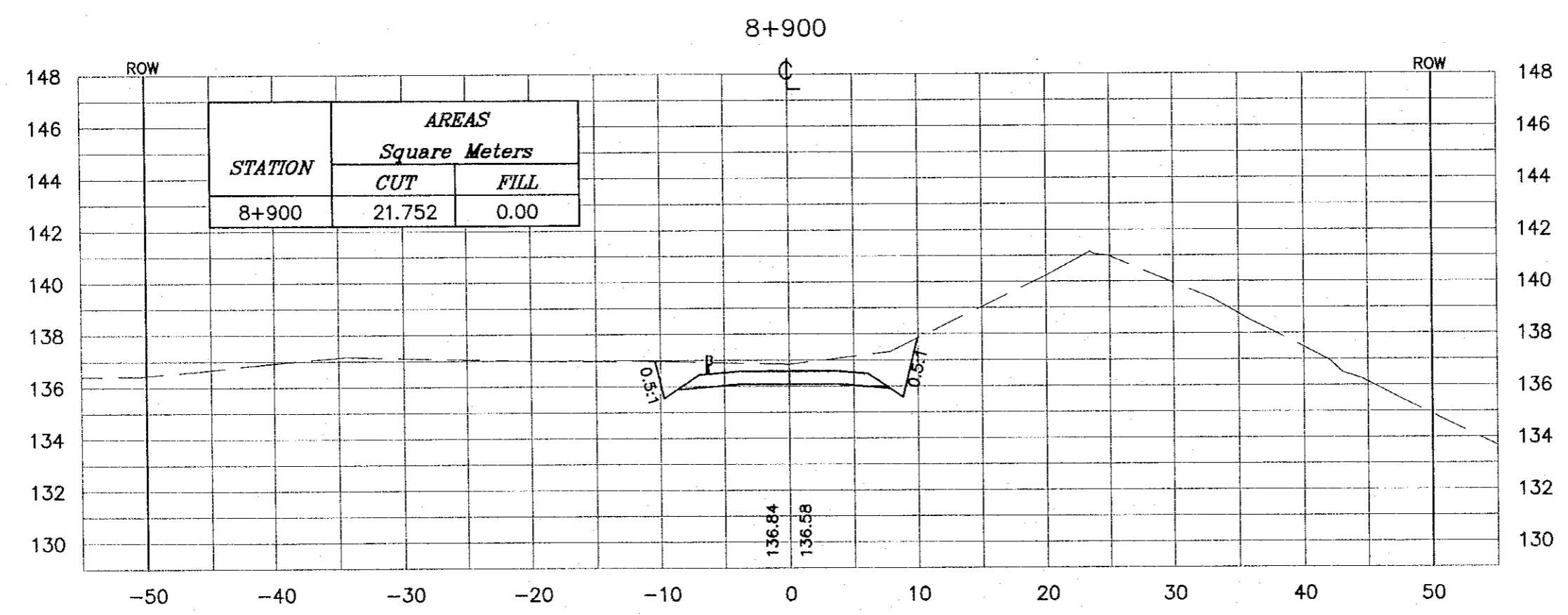
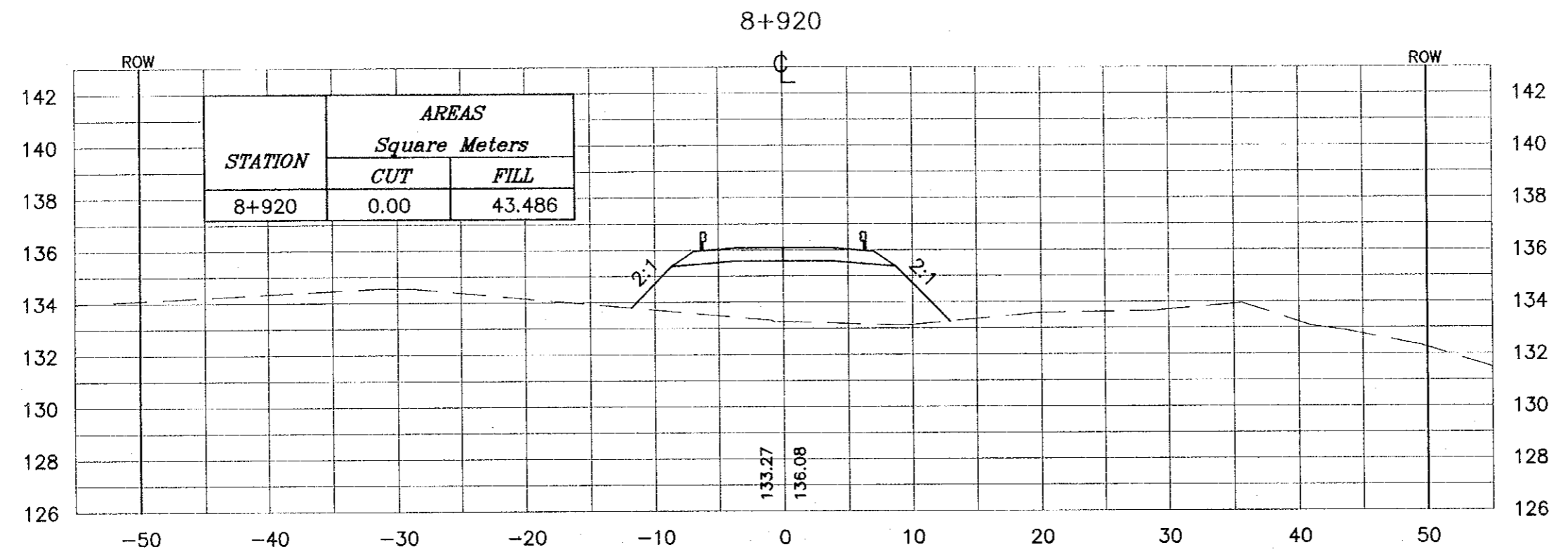

Project:
Tourism Sector Development Project
in the Hashemite Kingdom of Jordan

Executing Agency:
The Ministry of Tourism and Antiquities
The Ministry of Planning

SUB-PROJECT:
Dead Sea Parkway

Note:
This detailed design has been executed by a team of consultants as shown below in accordance with the agreement between Japan International Cooperation Agency (JICA) and JICA Study Team. The copyright of this drawing rests with JICA.

Designed by:
Japan International Cooperation Agency (JICA)

JICA Study Team:
Joint Venture of Pacific Consultants International and Yamashita Sekkei Inc.

Subcontracted Local Consultant:
 consolidated consultants
ENGINEERING & ENVIRONMENT
Tel: 9612377 - Fax: 9612380 - AMMAN - JORDAN

Drawing Title:
CROSS-SECTION
8+900/8+920

Scale: H 1:400 V 1:200 **Drawing No.:** 365

NOTES :

- * FOR EXACT HEIGHTS AND DIMENSIONS OF BENCHES SEE TYPICAL ROAD CROSS-SECTION .
- * SLOPE H : V .

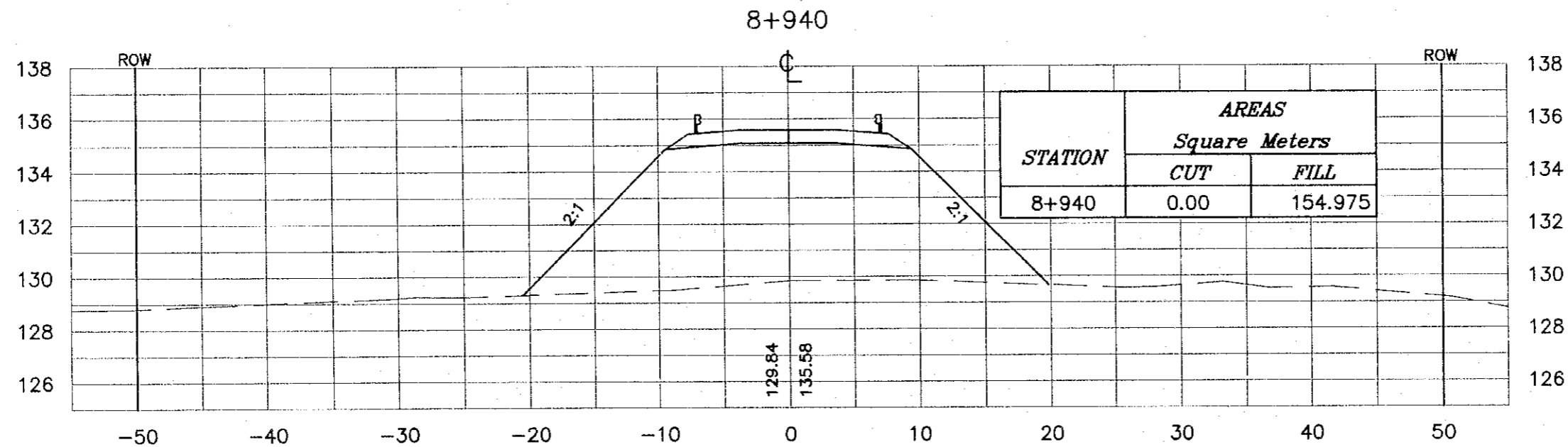
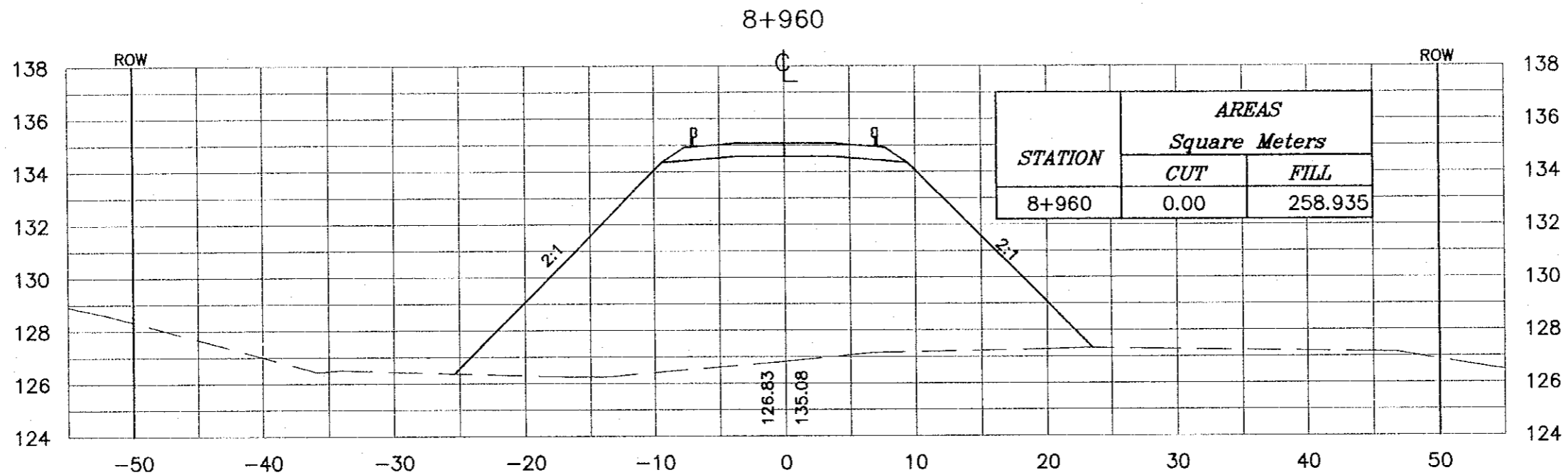

Project:
Tourism Sector Development Project
in the Hashemite Kingdom of Jordan

Executing Agency:
The Ministry of Tourism and Antiquities
The Ministry of Planning

SUB-PROJECT:
Dead Sea Parkway

Note:
This detailed design has been executed by
a team of consultants as shown below in
accordance with the agreement between
Japan International Cooperation Agency
(JICA) and JICA Study Team.
The copyright of this drawing rests with JICA.

Designed by:
Japan International Cooperation
Agency (JICA)

JICA Study Team:
Joint Venture of
Pacific Consultants International and
Yamashita Sekkel Inc.

Subcontracted Local Consultant:
consolidated consultants
engineering & environment
Tel: 962277 - Fax: 962280 - AMMAN - JORDAN

Drawing Title:
CROSS-SECTION
8+940/8+960

Scale: H 1:400 Drawing No.: 366
V 1:200

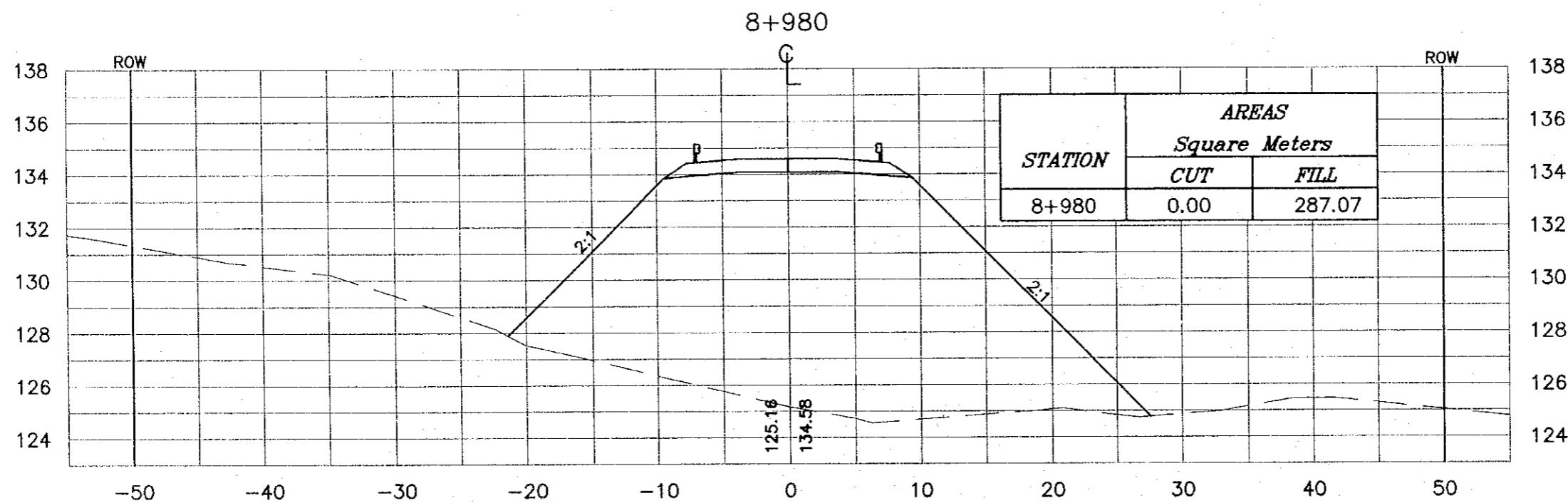
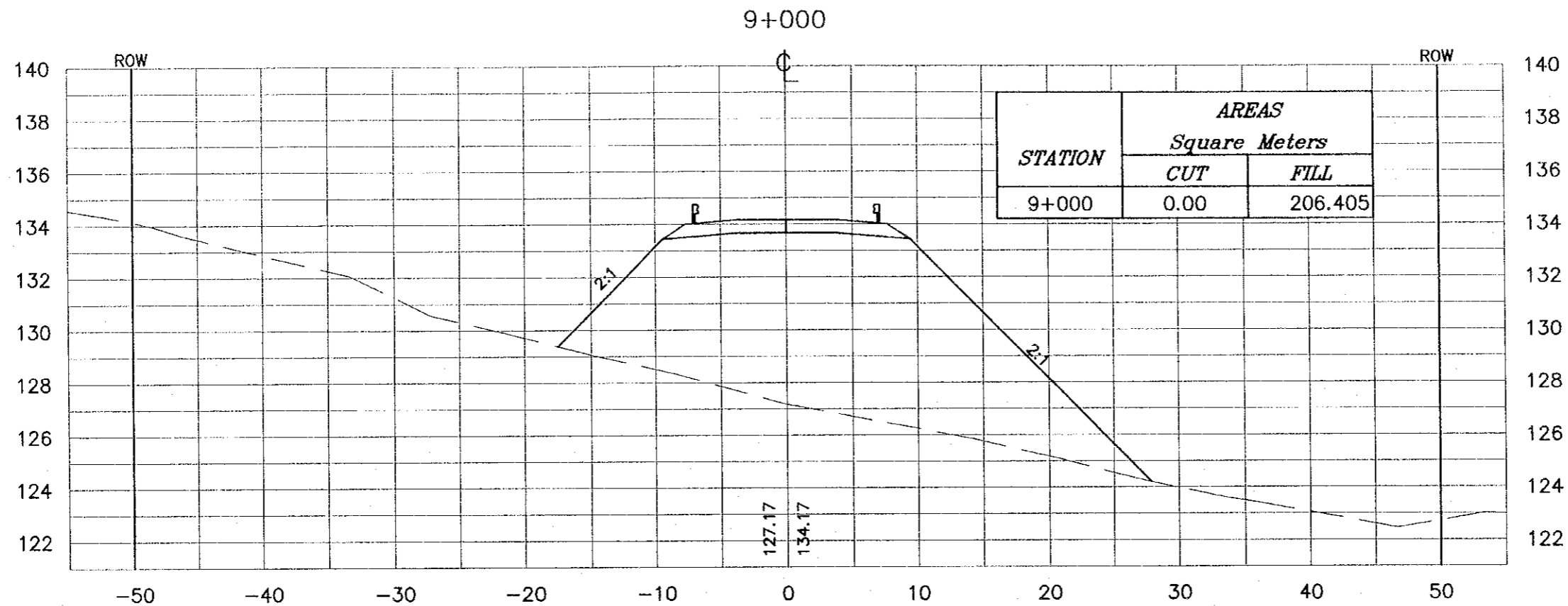

NOTES :

- * FOR EXACT HEIGHTS AND DIMENSIONS OF BENCHES SEE TYPICAL ROAD CROSS-SECTION .
- * SLOPE H : V .

Project:
Tourism Sector Development Project
In the Hashemite Kingdom of Jordan

Executing Agency:
The Ministry of Tourism and Antiquities
The Ministry of Planning

SUB-PROJECT:
Dead Sea Parkway

Note:
This detailed design has been executed by a team of consultants as shown below in accordance with the agreement between Japan International Cooperation Agency (JICA) and JICA Study Team. The copyright of this drawing rests with JICA.

Designed by:
Japan International Cooperation Agency (JICA)

JICA Study Team:
Joint Venture of
Pacific Consultants International and
Yamashita Sekkei Inc.

Subcontracted Local Consultant:
consolidated consultants
engineering & environment
Tel: 4613777 - Fax: 4613780 - AMMAN - JORDAN

Drawing Title:
CROSS-SECTION
8+980/9+000

Scale: H 1:400 V 1:200 Drawing No.: 367

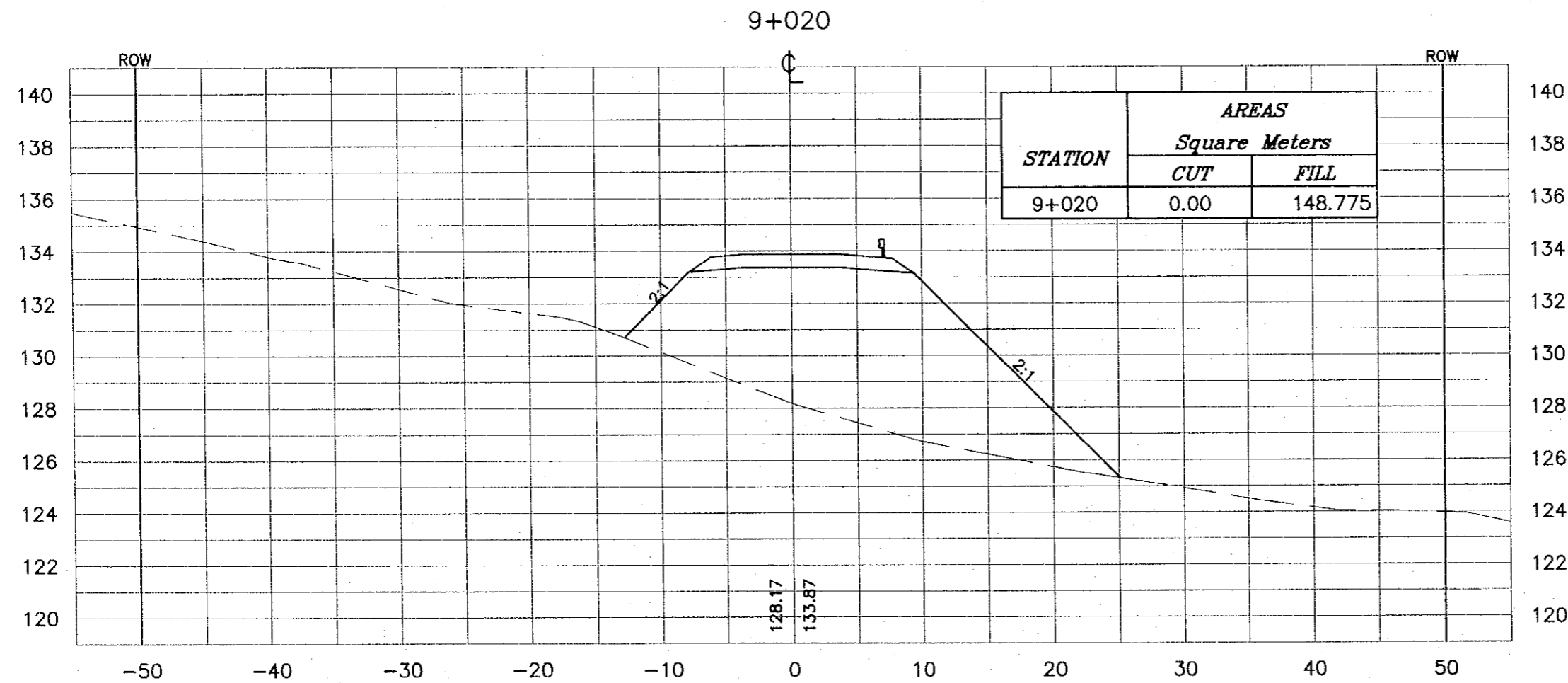

NOTES :

- * FOR EXACT HEIGHTS AND DIMENSIONS OF BENCHES SEE TYPICAL ROAD CROSS-SECTION .
- * SLOPE H : V .

Project:
Tourism Sector Development Project
in the Hashemite Kingdom of Jordan

Executing Agency:
The Ministry of Tourism and Antiquities
The Ministry of Planning

SUB-PROJECT:
Dead Sea Parkway

Note:
This detailed design has been executed by a team of consultants as shown below in accordance with the agreement between Japan International Cooperation Agency (JICA) and JICA Study Team. The copyright of this drawing rests with JICA.

Designed by:
Japan International Cooperation Agency (JICA)

JICA Study Team:
Joint Venture of Pacific Consultants International and Yamashita Sekitel Inc.

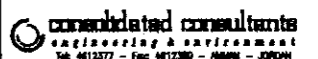
Subcontracted Local Consultants:

consolidated consultants
engineering & environment
Tel. 412377 - Fax 412380 - AMMAN - JORDAN

Drawing Title:
CROSS-SECTION
9+020/9+040

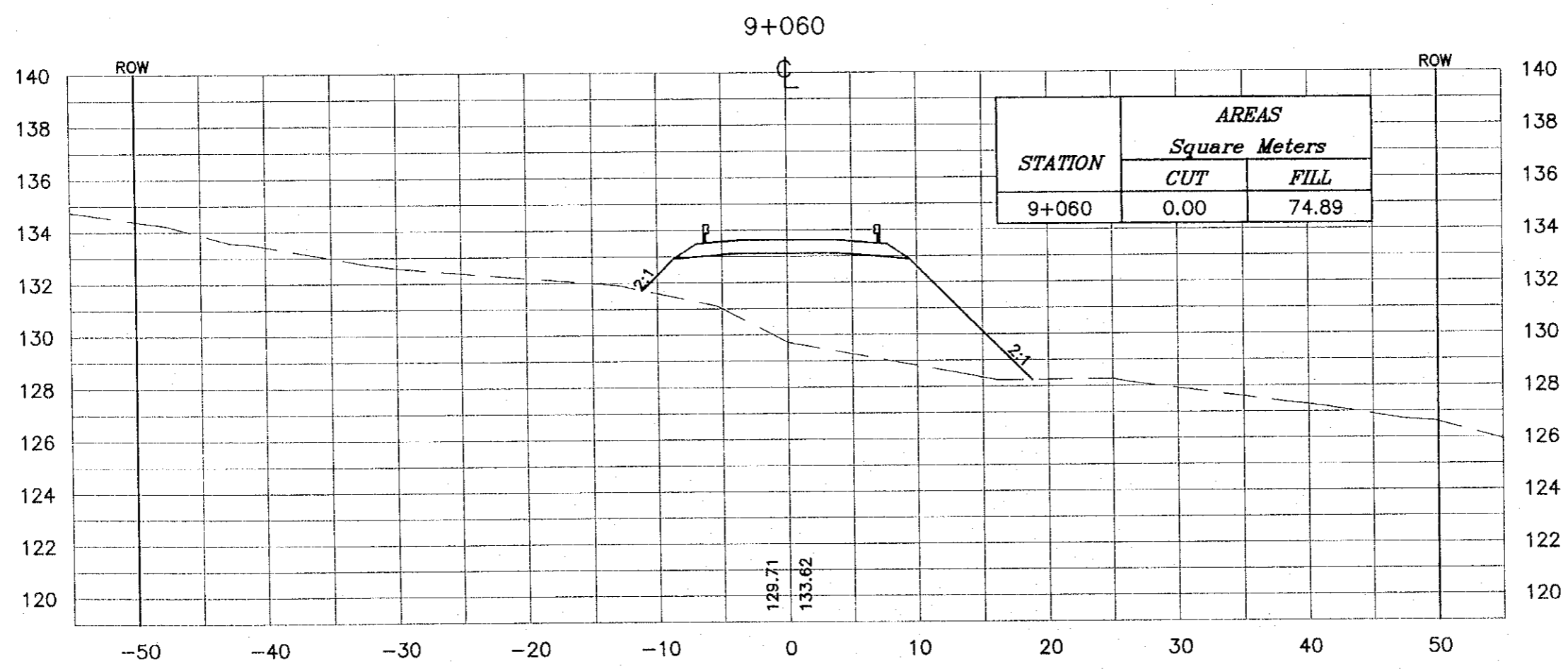
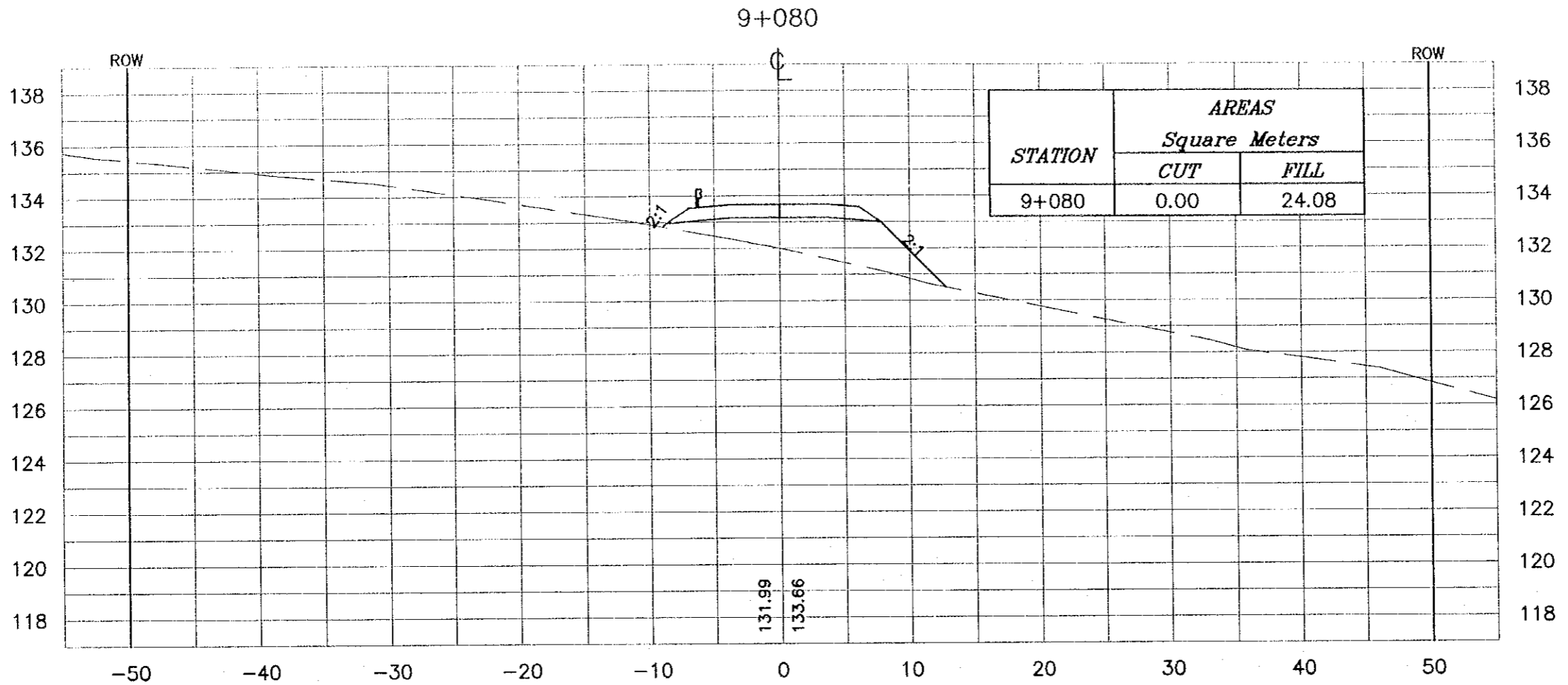
Scale: H 1:400 V 1:200 **Drawing No.:** 368



NOTES :

- * FOR EXACT HEIGHTS AND DIMENSIONS OF BENCHES SEE TYPICAL ROAD CROSS-SECTION .
- * SLOPE H : V .

Project:
Tourism Sector Development Project
In the Hashemite Kingdom of Jordan

Executing Agency:
The Ministry of Tourism and Antiquities
The Ministry of Planning

SUB-PROJECT:
Dead Sea Parkway

Note:
This detailed design has been executed by a team of consultants as shown below in accordance with the agreement between Japan International Cooperation Agency (JICA) and JICA Study Team. The copyright of this drawing rests with JICA.

Designed by:
Japan International Cooperation Agency (JICA)

JICA Study Team:
Joint Venture of
Pacific Consultants International and
Yamashita Sekkei Inc.

Subcontracted Local Consultant:
 consolidated consultants
Engineering & Environment
Tel: 962277 - Fax: 962280 - AMMAN - JORDAN

Drawing Title:
CROSS-SECTION
9+060/9+080

Scale: H 1:400 V 1:200 **Drawing No.:** 369

NOTES :

- * FOR EXACT HEIGHTS AND DIMENSIONS OF BENCHES SEE TYPICAL ROAD CROSS-SECTION .
- * SLOPE H : V .

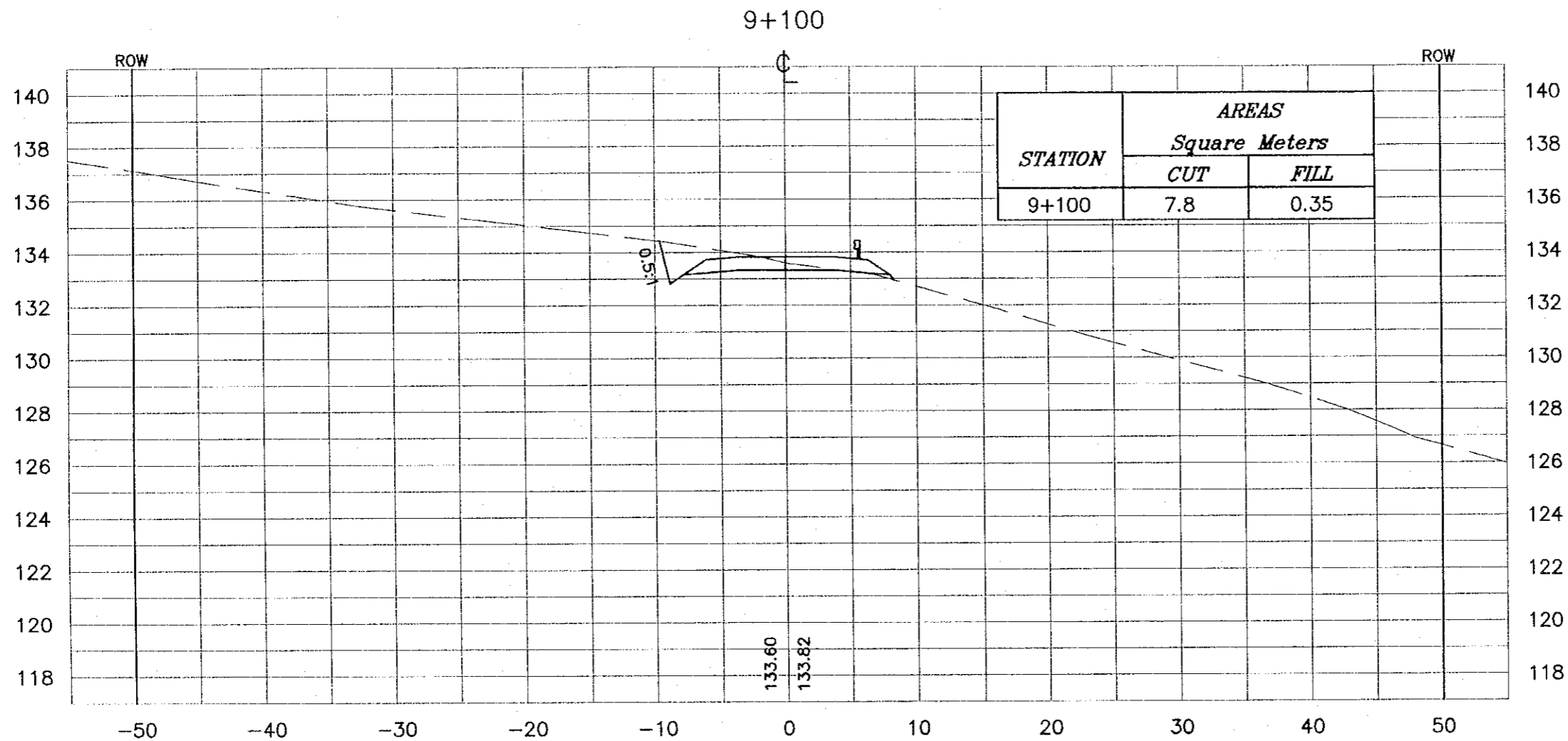

Project:
Tourism Sector Development Project
in the Hashemite Kingdom of Jordan

Executing Agency:
The Ministry of Tourism and Antiquities
The Ministry of Planning

SUB-PROJECT:
Dead Sea Parkway

Note:
This detailed design has been executed by a team of consultants as shown below in accordance with the agreement between Japan International Cooperation Agency (JICA) and JICA Study Team. The copyright of this drawing rests with JICA.

Designed by:
Japan International Cooperation Agency (JICA)

JICA Study Team:
Joint Venture of
Pacific Consultants International and
Yamashita Sekkei Inc.

Subcontracted Local Consultant:
 consolidated consultants
Engineering & Environment
Tel: 492377 - Fax: 492380 - 492381 - JORDAN

Drawing Title:
CROSS-SECTION
9+100

Scale: H 1:400 V 1:200 **Drawing No.:** 370

NOTES :

- * FOR EXACT HEIGHTS AND DIMENSIONS OF BENCHES SEE TYPICAL ROAD CROSS-SECTION .
- * SLOPE H : V .

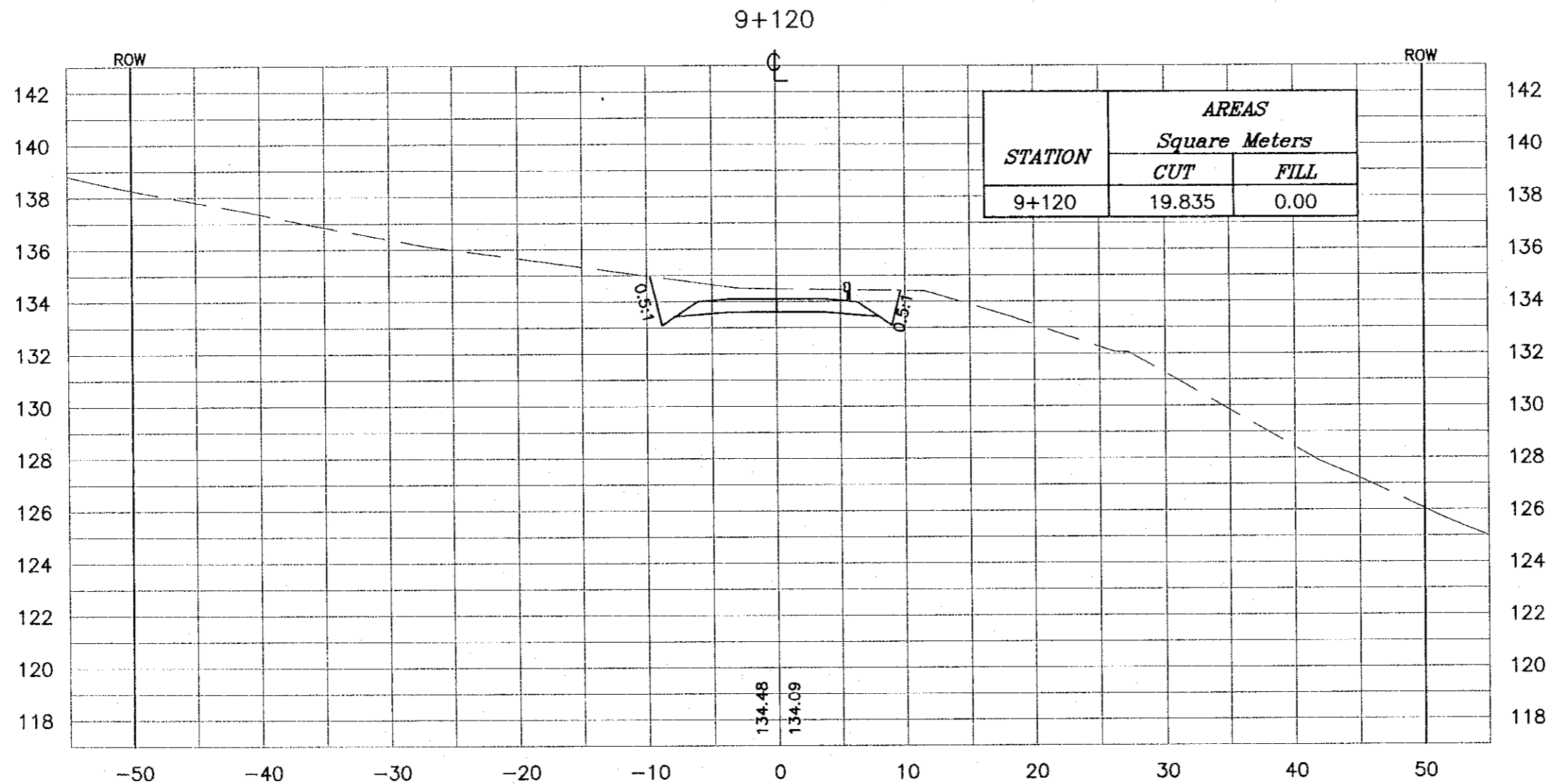

Project:
Tourism Sector Development Project
In the Hashemite Kingdom of Jordan

Executing Agency:
The Ministry of Tourism and Antiquities
The Ministry of Planning

SUB-PROJECT:
Dead Sea Parkway

Note:
This detailed design has been executed by a team of consultants as shown below in accordance with the agreement between Japan International Cooperation Agency (JICA) and JICA Study Team. The copyright of this drawing rests with JICA.

Designed by:
Japan International Cooperation Agency (JICA)

JICA Study Team:
Joint Venture of
Pacific Consultants International and
Yamashita Sekitel Inc.

Subcontracted Local Consultant:
 consolidated consultants
engineering & environment
TEL: 4612377 - Fax: 4612380 - AMMAN - JORDAN

Drawing Title:
CROSS-SECTION
9+120

Scale: H 1:400 V 1:200 **Drawing No.:** 371