

NOTES :
 * FOR EXACT HEIGHTS AND DIMENSIONS OF BENCHES SEE TYPICAL ROAD CROSS-SECTION .
 * SLOPE H : V .

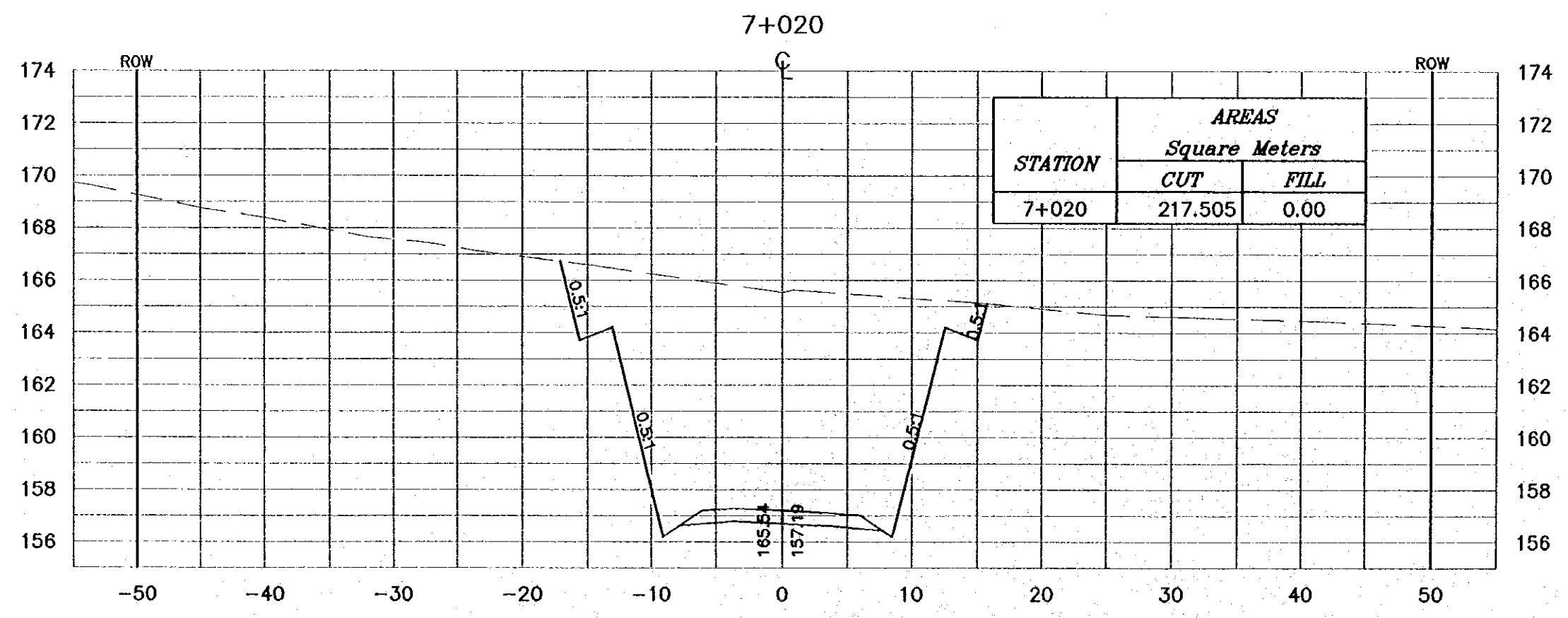
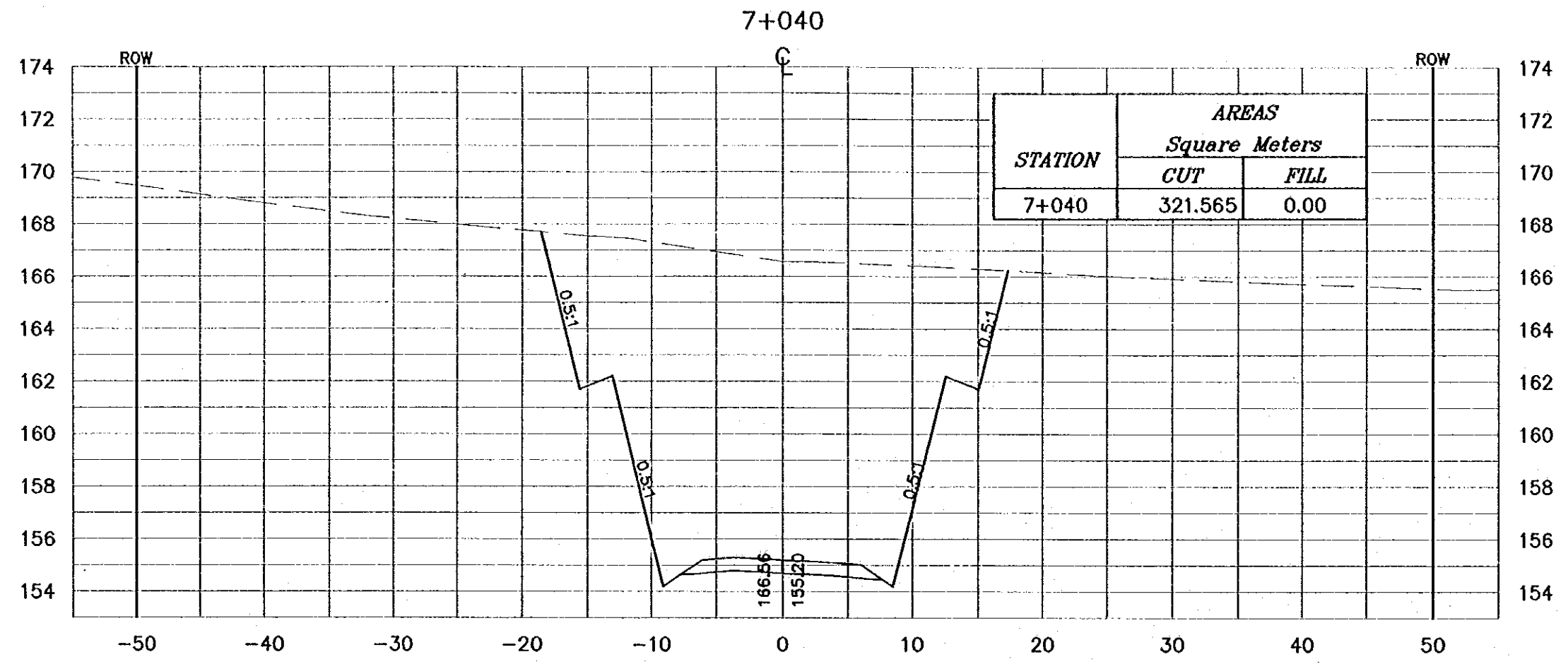

Project:
 Tourism Sector Development Project
 in the Hashemite Kingdom of Jordan

Executing Agency:
 The Ministry of Tourism and Antiquities
 The Ministry of Planning

SUB-PROJECT:
 Dead Sea Parkway

Note:
 This detailed design has been executed by a team of consultants as shown below in accordance with the agreement between Japan International Cooperation Agency (JICA) and JICA Study Team. The copyright of this drawing rests with JICA.

Designed by:
 Japan International Cooperation Agency (JICA)

JICA Study Team:
 Joint Venture of
 Pacific Consultants International and
 Yamashita Sekido Inc.

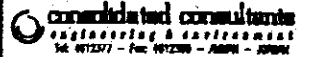
Subcontracted Local Consultant:

 consolidated consultants
 engineering & environment
 Tel: 972277 - Fax: 972288 - AMM - JORDAN

Drawing Title:
 CROSS-SECTION
 7+020/7+040

Scale:
 H 1:400
 V 1:200

Drawing No.: 303

NOTES :

- * FOR EXACT HEIGHTS AND DIMENSIONS OF BENCHES SEE TYPICAL ROAD CROSS-SECTION .
- * SLOPE H : V .

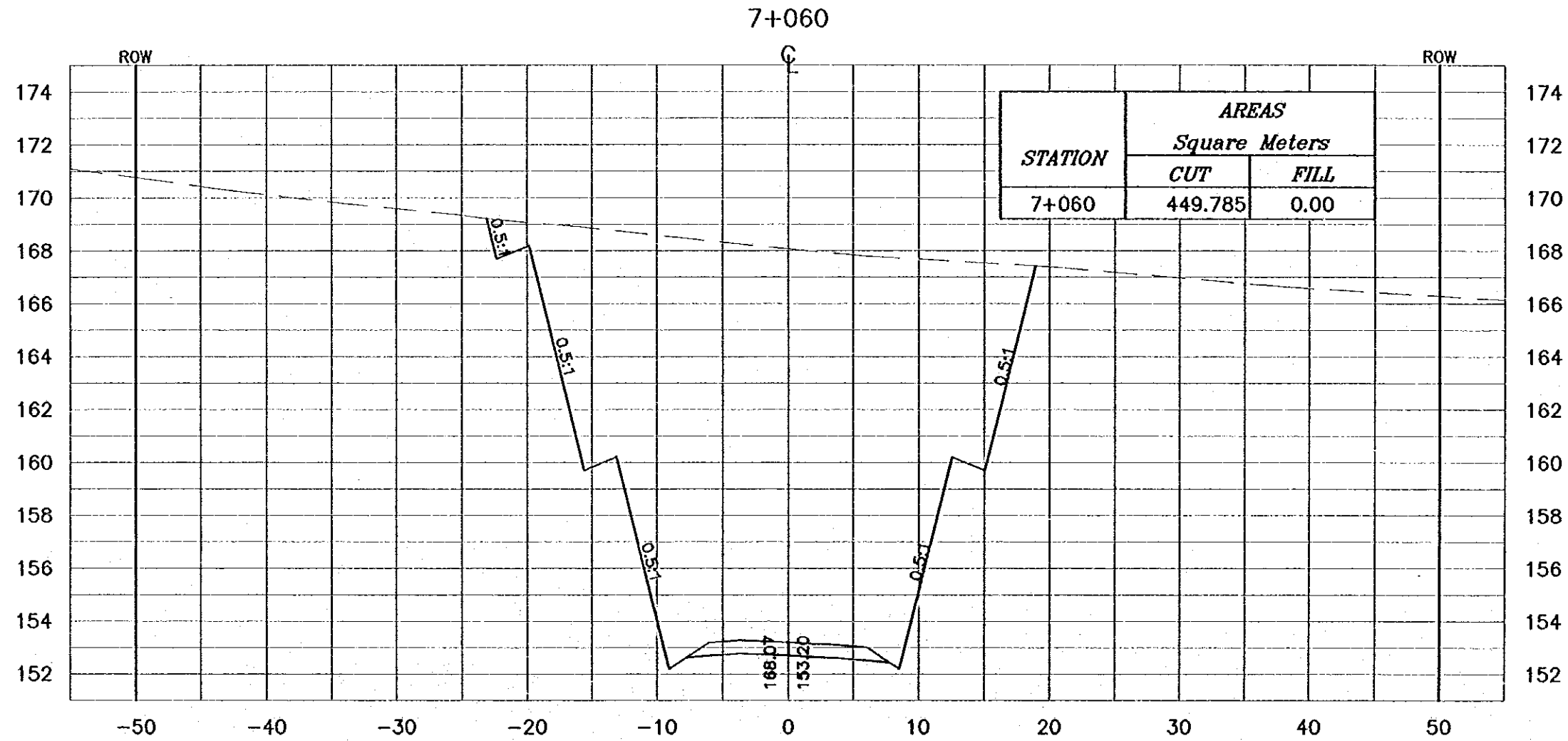

Project:
Tourism Sector Development Project
in the Hashemite Kingdom of Jordan

Executing Agency:
The Ministry of Tourism and Antiquities
The Ministry of Planning

SUB-PROJECT:
Dead Sea Parkway

Note:
This detailed design has been executed by a team of consultants as shown below in accordance with the agreement between Japan International Cooperation Agency (JICA) and JICA Study Team.
The copyright of this drawing rests with JICA.

Designed by:
Japan International Cooperation Agency (JICA)

JICA Study Team:
Joint Venture of
Pacific Consultants International and
Yamashita Seki Inc.

Subcontracted Local Consultant:

Tel: 0112377 - Fax: 0112380 - AMMAN - JORDAN

Drawing Title:
CROSS-SECTION
7+060

Scale: H 1:400 V 1:200 **Drawing No.:** 304

NOTES :

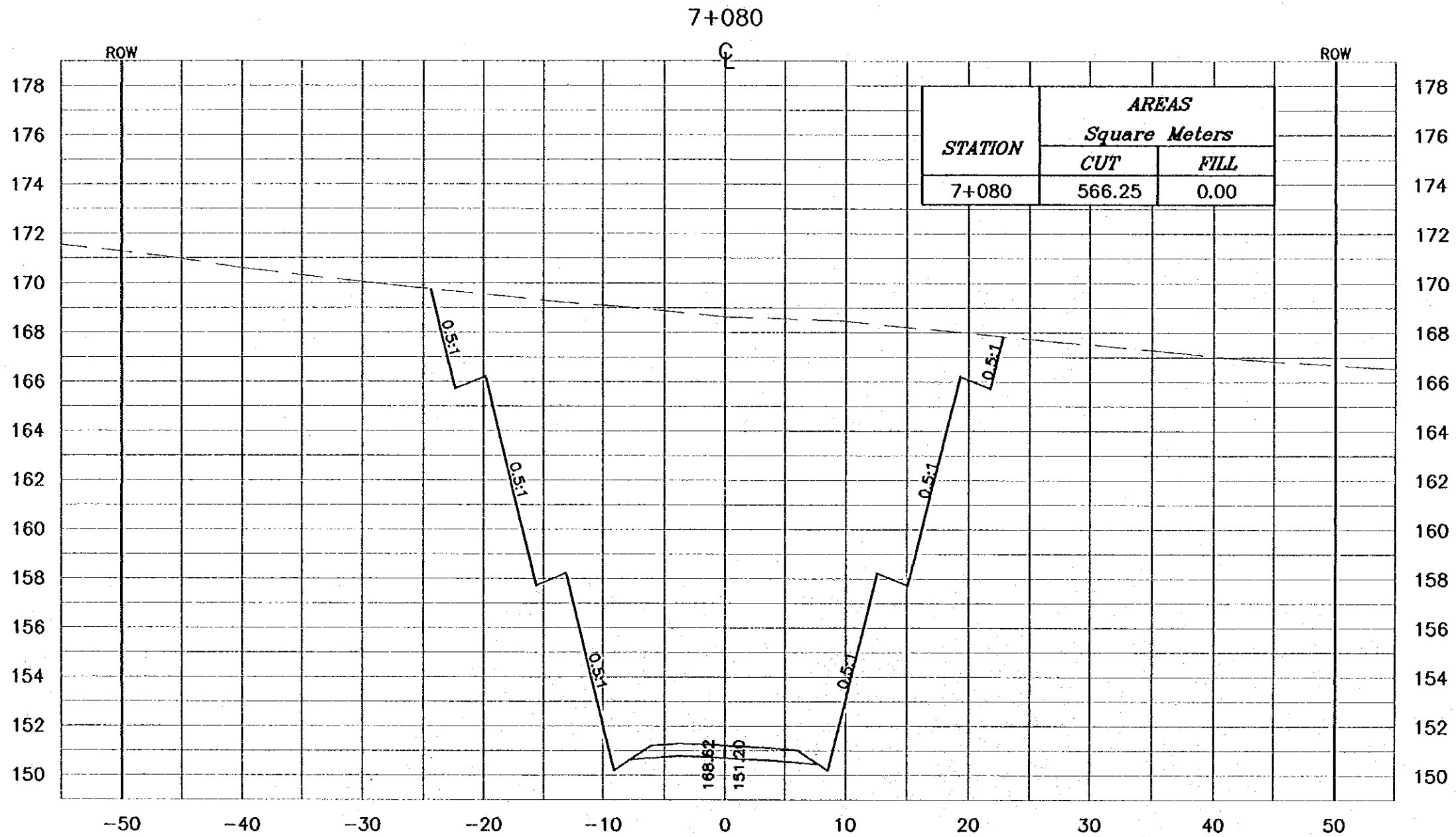
- * FOR EXACT HEIGHTS AND DIMENSIONS OF BENCHES SEE TYPICAL ROAD CROSS-SECTION .
- * SLOPE H : V .



Project:
Tourism Sector Development Project
in the Hashemite Kingdom of Jordan

Executing Agency:
The Ministry of Tourism and Antiquities
The Ministry of Planning

SUB-PROJECT:
Dead Sea Parkway

Note:
This detailed design has been executed by
a team of consultants as shown below in
accordance with the agreement between
Japan International Cooperation Agency
(JICA) and JICA Study Team.
The copyright of this drawing rests with JICA.

Designed by:
Japan International Cooperation
Agency (JICA)

JICA Study Team:
Joint Venture of
Pacific Consultants International and
Yamashita Sekitel Inc.

Subcontracted Local Consultant:

consolidated consultants
engineering & environment
Tel: 4812377 - Fax: 4812380 - AMMAN - JORDAN

Drawing Title:
CROSS-SECTION
7+080

Scale:
H: 1:400
V: 1:200

Drawing No.: 305

NOTES :

- * FOR EXACT HEIGHTS AND DIMENSIONS OF BENCHES SEE TYPICAL ROAD CROSS-SECTION .
- * SLOPE H : V .

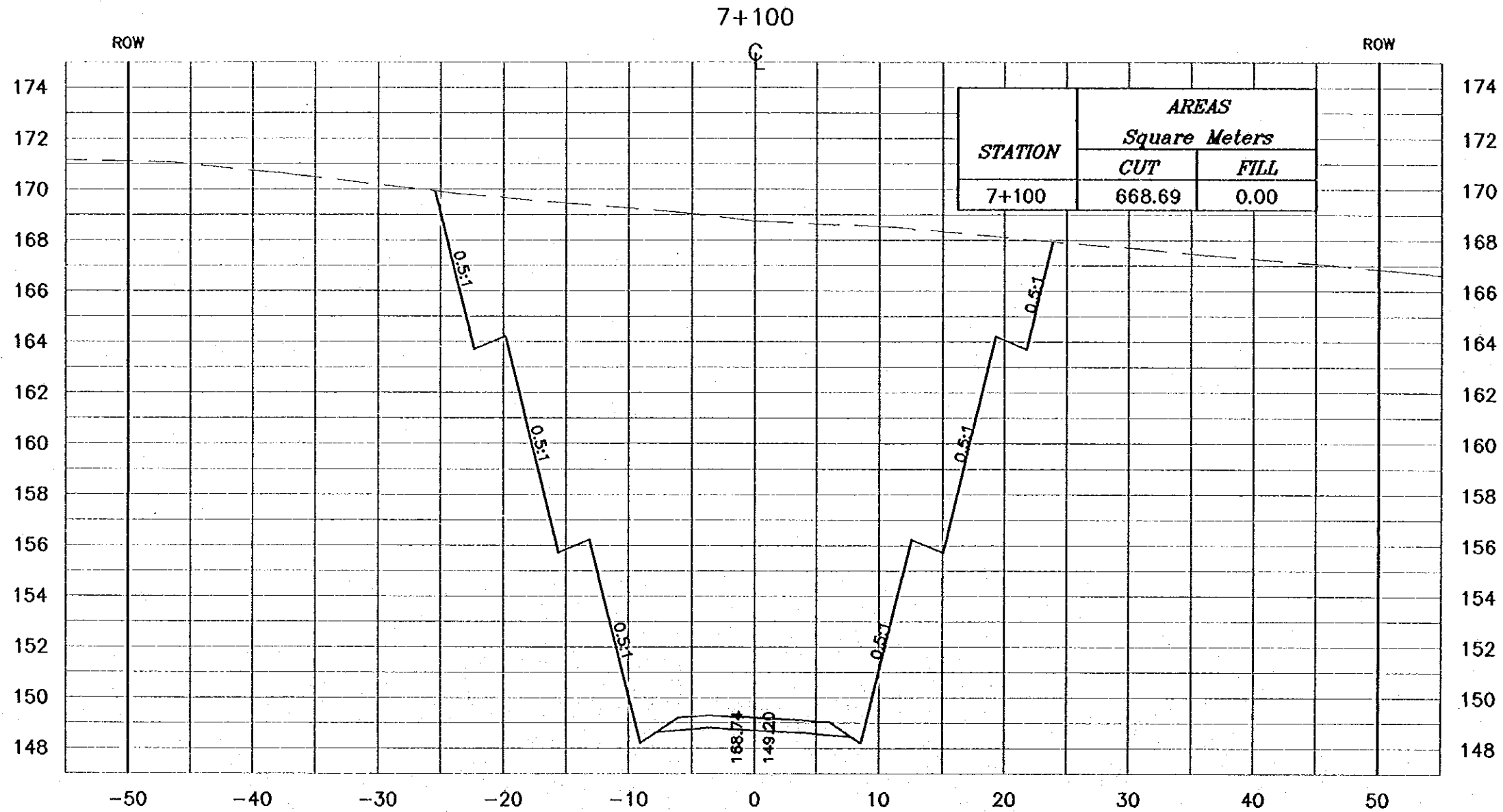

Project:
Tourism Sector Development Project
in the Hashemite Kingdom of Jordan

Executing Agency:
The Ministry of Tourism and Antiquities
The Ministry of Planning

SUB-PROJECT:
Dead Sea Parkway

Note:
This detailed design has been executed by
a team of consultants as shown below in
accordance with the agreement between
Japan International Cooperation Agency
(JICA) and JICA Study Team.
The copyright of this drawing rests with JICA.

Designed by:
Japan International Cooperation
Agency (JICA)

JICA Study Team:
Joint Venture of
Pacific Consultants International and
Yamashita Sekitai Inc.

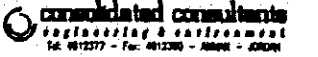
Subcontracted Local Consultant:

consolidated consultants
engineering & environment
Tel: 4612377 - Fax: 4612380 - Amman - JORDAN

Drawing Title:
CROSS-SECTION
7+100

Scale: H 1:400 V 1:200 **Drawing No.:** 306

NOTES :

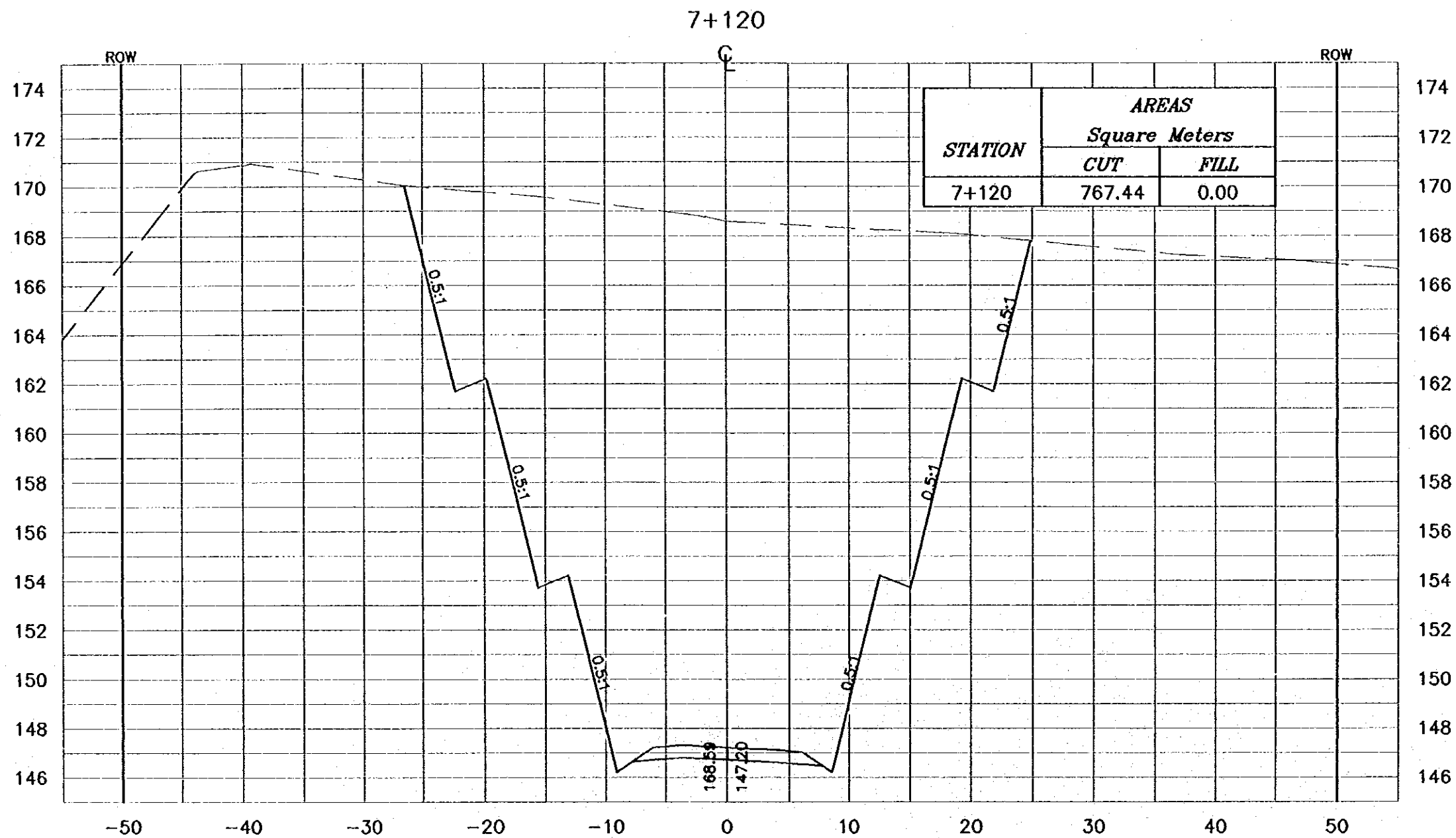
- * FOR EXACT HEIGHTS AND DIMENSIONS OF BENCHES SEE TYPICAL ROAD CROSS-SECTION .
- * SLOPE H : V .



Project:
Tourism Sector Development Project
in the Hashemite Kingdom of Jordan

Executing Agency:
The Ministry of Tourism and Antiquities
The Ministry of Planning

SUB-PROJECT:
Dead Sea Parkway

Note:
This detailed design has been executed by
a team of consultants as shown below in
accordance with the agreement between
Japan International Cooperation Agency
(JICA) and JICA Study Team.
The copyright of this drawing rests with JICA.

Designed by:
Japan International Cooperation
Agency (JICA)

JICA Study Team:
Joint Venture of
Pacific Consultants International and
Yamashita Seki Inc.

Subcontracted Local Consultant:

consolidated consultants
engineering & environment
Tel. 012377 - Fax. 012388 - AMM - 20204

Drawing Title:
CROSS-SECTION
7+120

Scale: H 1:400 V 1:200 **Drawing No.:** 307

NOTES :

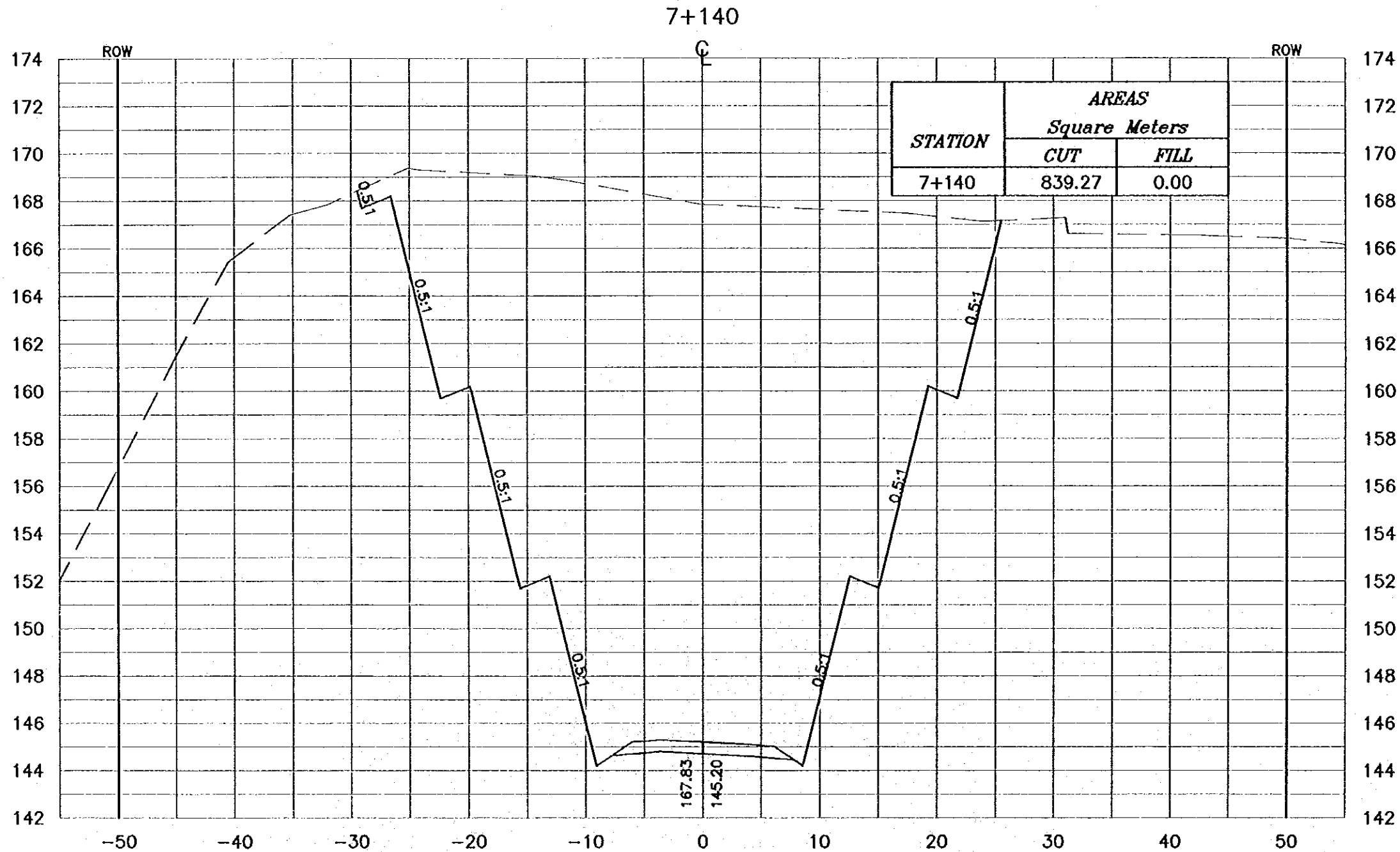
- * FOR EXACT HEIGHTS AND DIMENSIONS OF BENCHES SEE TYPICAL ROAD CROSS-SECTION .
- * SLOPE H : V .



Project:
Tourism Sector Development Project
in the Hashemite Kingdom of Jordan

Executing Agency:
The Ministry of Tourism and Antiquities
The Ministry of Planning

SUB-PROJECT:
Dead Sea Parkway

Note:
This detailed design has been executed by a team of consultants as shown below in accordance with the agreement between Japan International Cooperation Agency (JICA) and JICA Study Team. The copyright of this drawing rests with JICA.

Designed by:
Japan International Cooperation Agency (JICA)

JICA Study Team:
Joint Venture of Pacific Consultants International and Yamaoka Sakkai Inc.

Subcontracted Local Consultant:

consolidated consultants
engineering & environment
Tel: 992277 - Fax: 992288 - AMMAN - JORDAN

Drawing Title:
CROSS-SECTION
7+140

Scale:
H 1:400
V 1:200

Drawing No.: 308

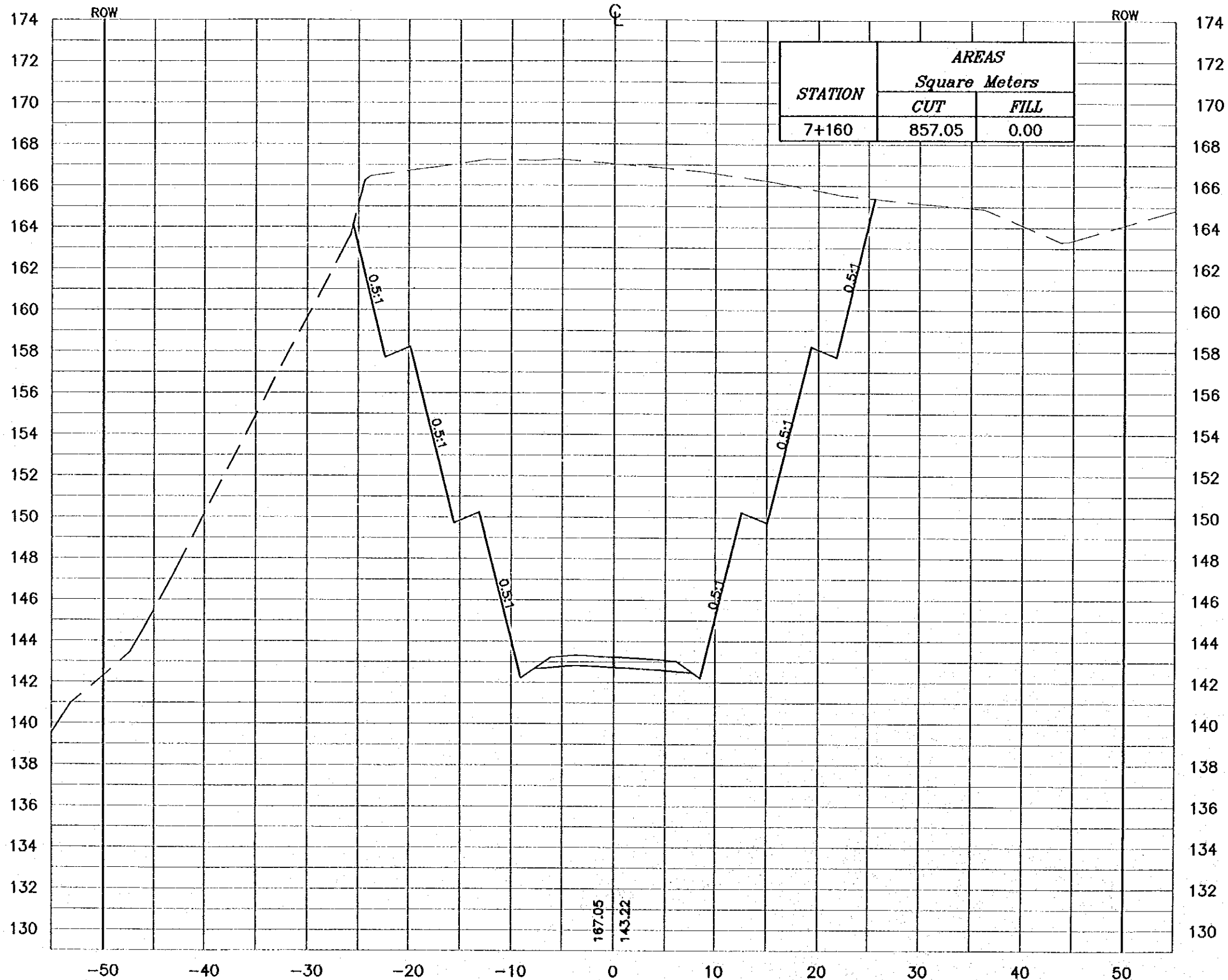
7+160



NOTES :

- * FOR EXACT HEIGHTS AND DIMENSIONS OF BENCHES SEE TYPICAL ROAD CROSS-SECTION .
- * SLOPE H : V .

Project:
Tourism Sector Development Project
in the Hashemite Kingdom of Jordan

Executing Agency:
The Ministry of Tourism and Antiquities
The Ministry of Planning

SUB-PROJECT:
Dead Sea Parkway

Note:
This detailed design has been executed by a team of consultants as shown below in accordance with the agreement between Japan International Cooperation Agency (JICA) and JICA Study Team.
The copyright of this drawing rests with JICA.

Designed by:
Japan International Cooperation Agency (JICA)

JICA Study Team:
Joint Venture of
Pacific Consultants International and
Yamashita Saitoh Inc.

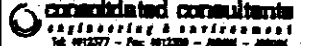
Subcontracted Local Consultant:

consolidated consultants
engineering & environment
Tel: 992377 - Fax: 992398 - Amman - Jordan

Drawing Title:
CROSS-SECTION
7+160

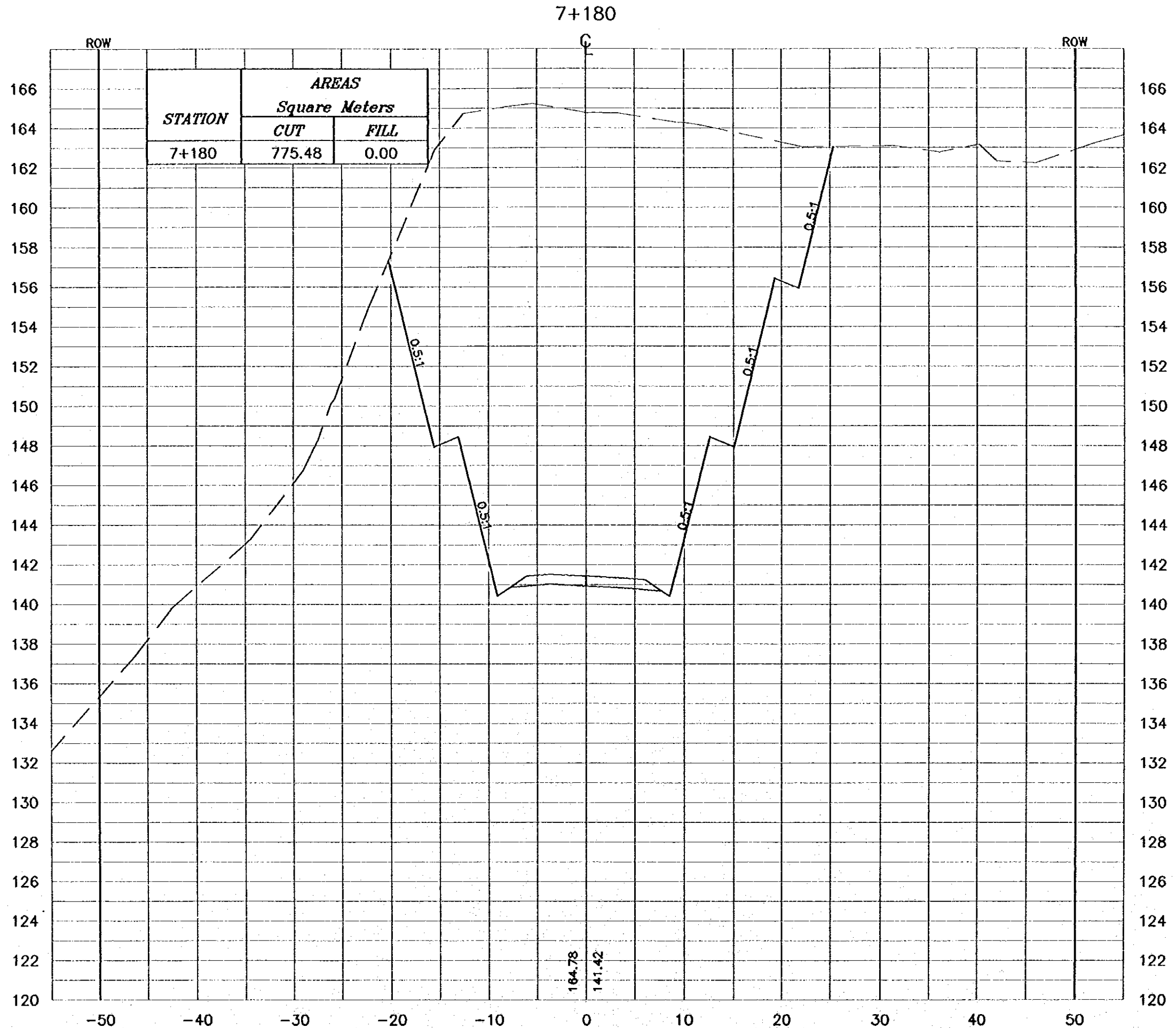
Scale: H 1:400 V 1:200 **Drawing No.:** 309



NOTES :

- * FOR EXACT HEIGHTS AND DIMENSIONS OF BENCHES SEE TYPICAL ROAD CROSS-SECTION .
- * SLOPE H : V .

Project:
Tourism Sector Development Project
in the Hashemite Kingdom of Jordan

Executing Agency:
The Ministry of Tourism and Antiquities
The Ministry of Planning

SUB-PROJECT:
Dead Sea Parkway

Note:
This detailed design has been executed by a team of consultants as shown below in accordance with the agreement between Japan International Cooperation Agency (JICA) and JICA Study Team. The copyright of this drawing rests with JICA.

Designed by:
Japan International Cooperation Agency (JICA)
JICA Study Team:
Joint Venture of Pacific Consultants International and Yawesha Seikoku Inc.

Subcontracted Local Consultant:
 consolidated consultants
engineering & environment
Tel: 992377 - Fax: 992388 - JORDAN - JORDAN

Drawing Title:
CROSS-SECTION
7+180

Scale: H 1:400 V 1:200 **Drawing No.:** 310

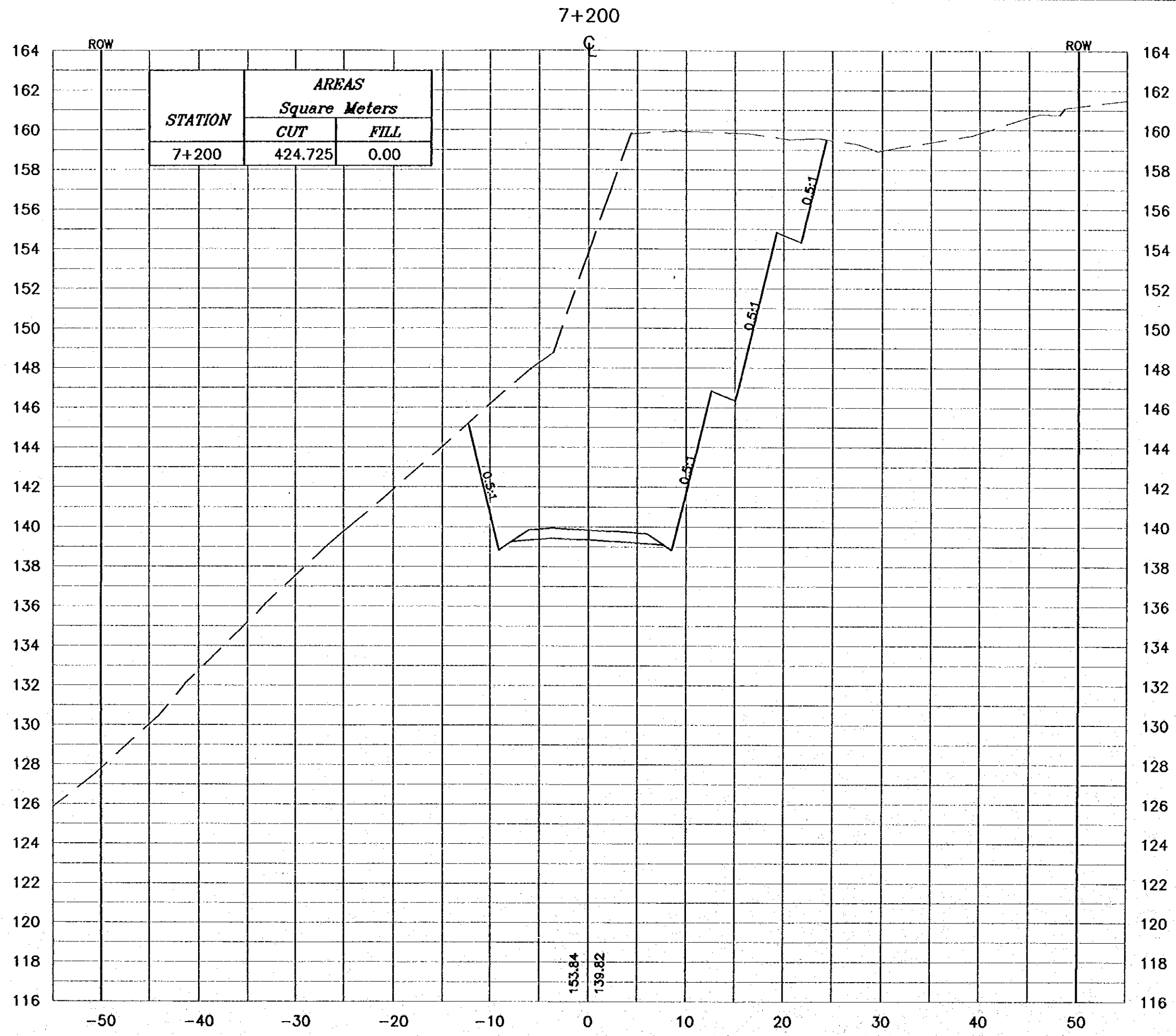

NOTES :

- * FOR EXACT HEIGHTS AND DIMENSIONS OF BENCHES SEE TYPICAL ROAD CROSS-SECTION .
- * SLOPE H : V .

Project:
Tourism Sector Development Project
in the Hashemite Kingdom of Jordan

Executing Agency:
The Ministry of Tourism and Antiquities
The Ministry of Planning

SUB-PROJECT:
Dead Sea Parkway

Note:
This detailed design has been executed by a team of consultants as shown below in accordance with the agreement between Japan International Cooperation Agency (JICA) and JICA Study Team. The copyright of this drawing rests with JICA.

Designed by:
Japan International Cooperation Agency (JICA)

JICA Study Team:
Joint Venture of Pacific Consultants International and Yansoelle Sekkol Inc.

Subcontracted Local Consultant:

consolidated consultants
engineering & environment
Tel: 9622577 - Fax: 9622598 - Amman - Jordan

Drawing Title:
CROSS-SECTION
7+200

Scale: H 1:400 V 1:200 **Drawing No.:** 311

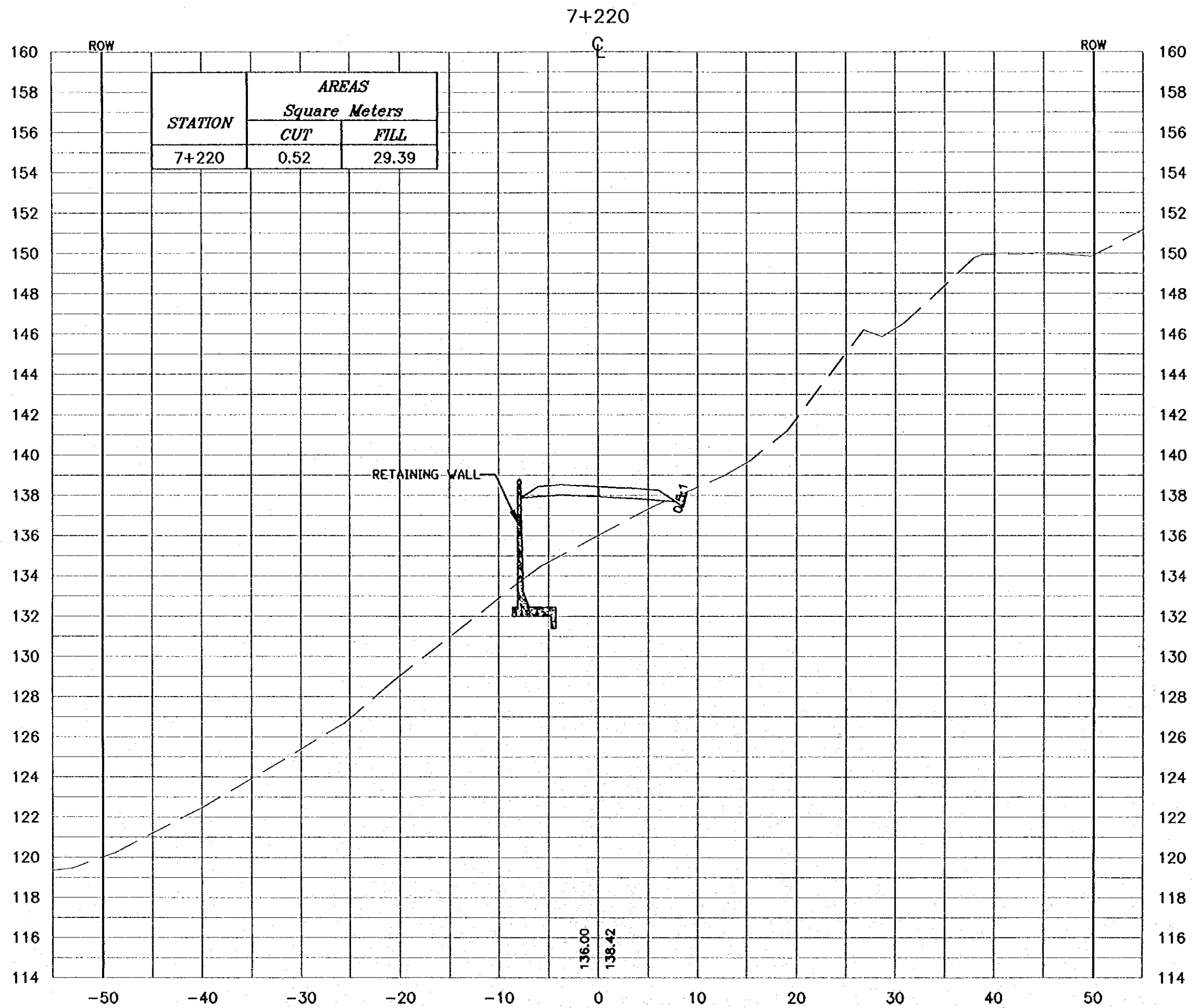

NOTES :

- * FOR EXACT HEIGHTS AND DIMENSIONS OF BENCHES SEE TYPICAL ROAD CROSS-SECTION .
- * SLOPE H : V .

Project:
Tourism Sector Development Project
in the Hashemite Kingdom of Jordan

Executing Agency:
The Ministry of Tourism and Antiquities
The Ministry of Planning

SUB-PROJECT:
Dead Sea Parkway

Note:
This detailed design has been executed by a team of consultants as shown below in accordance with the agreement between Japan International Cooperation Agency (JICA) and JICA Study Team.
The copyright of this drawing rests with JICA.

Designed by:
Japan International Cooperation Agency (JICA)

JICA Study Team:
Joint Venture of Pacific Consultants International and Yamashita Sekkol Inc.

Subcontracted Local Consultant:
 consolidated consultants
Engineering & Environment
No. 8512177 - Fax: 8512388 - Amman - JORDAN

Drawing Title:
CROSS-SECTION
7+220

Scale:
H 1:400
V 1:200

Drawing No.: 312

7+240

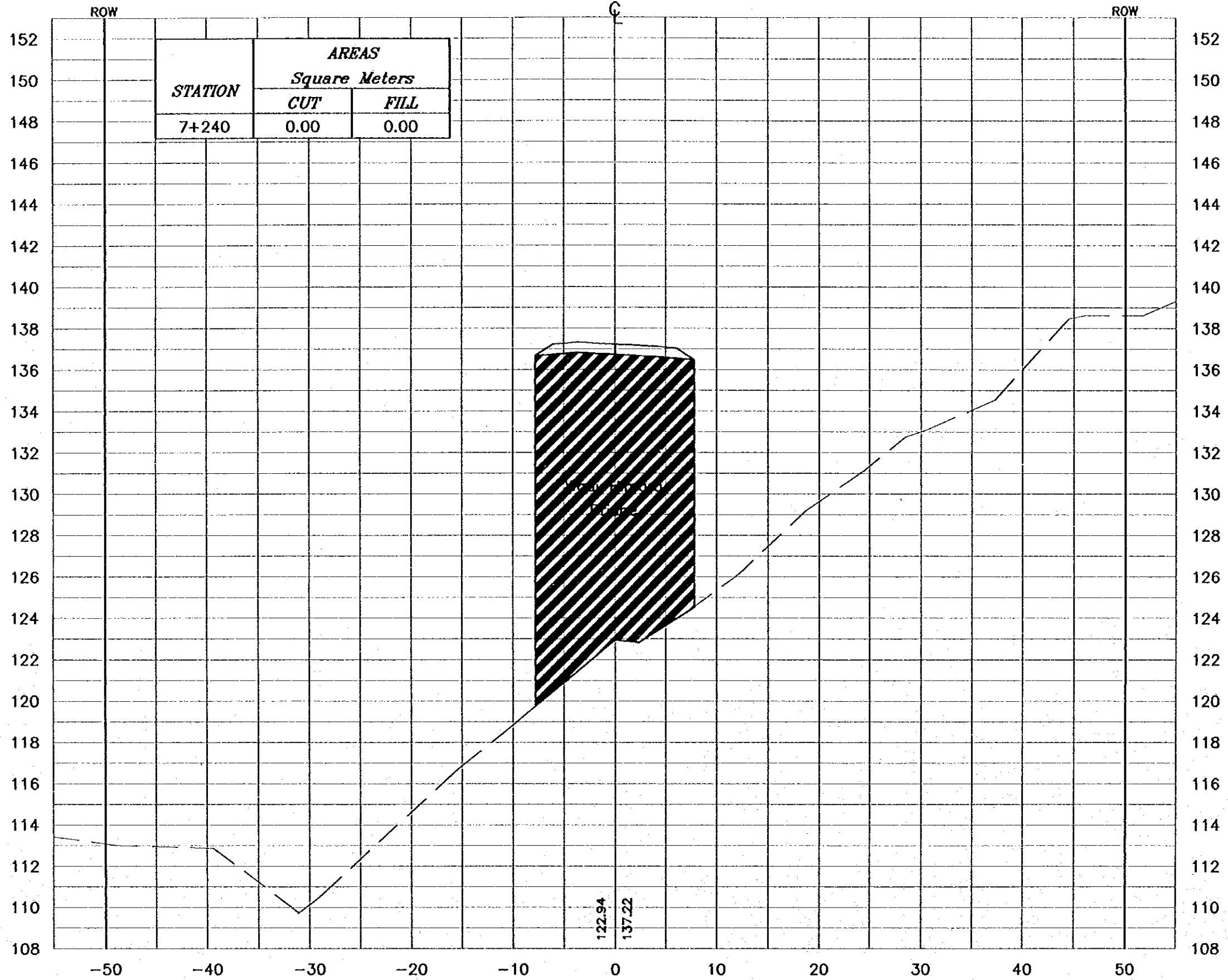

NOTES :
 * FOR EXACT HEIGHTS AND DIMENSIONS OF BENCHES SEE TYPICAL ROAD CROSS-SECTION .
 * SLOPE H : V .

Project:
 Tourism Sector Development Project
 in the Hashemite Kingdom of Jordan

Executing Agency:
 The Ministry of Tourism and Antiquities
 The Ministry of Planning

SUB-PROJECT:
 Dead Sea Parkway

Note:
 This detailed design has been executed by a team of consultants as shown below in accordance with the agreement between Japan International Cooperation Agency (JICA) and JICA Study Team.
 The copyright of this drawing rests with JICA.

Designed by:
 Japan International Cooperation Agency (JICA)

JICA Study Team:
 Joint Venture of
 Pacific Consultants International and
 Yamashita Seki & Co. Inc.

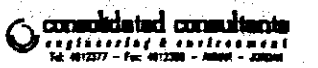
Subcontracted Local Consultant:

 consolidated consultants
 engineering & environment
 Tel: 497277 - Fax: 497288 - Amman - Jordan

Drawing Title:
 CROSS-SECTION
 7+240

Scale:
 H 1:400
 V 1:200

Drawing No.: 313

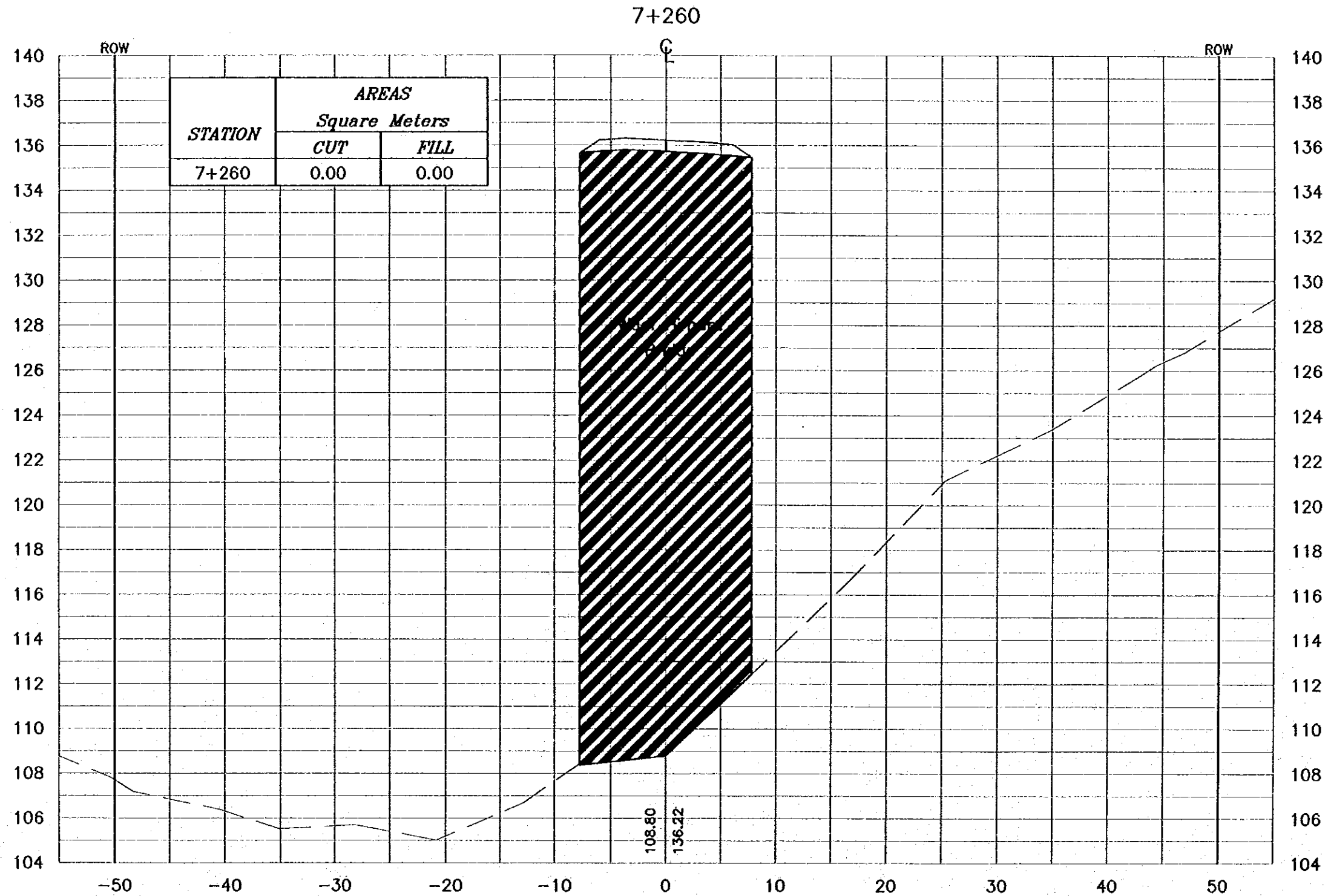
NOTES :
 * FOR EXACT HEIGHTS AND DIMENSIONS OF BENCHES SEE TYPICAL ROAD CROSS-SECTION .
 * SLOPE H : V .



Project:
 Tourism Sector Development Project
 in the Hashemite Kingdom of Jordan

Executing Agency:
 The Ministry of Tourism and Antiquities
 The Ministry of Planning

SUB-PROJECT:
 Dead Sea Parkway

Note:
 This detailed design has been executed by a team of consultants as shown below in accordance with the agreement between Japan International Cooperation Agency (JICA) and JICA Study Team. The copyright of this drawing rests with JICA.

Designed by:
 Japan International Cooperation Agency (JICA)

JICA Study Team:
 Joint Venture of Pacific Consultants International and Yamashita Sekido Inc.

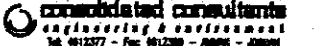
Subcontracted Local Consultant:

 Tel: 012277 - Fax: 012288 - AMM - JORDAN

Drawing Title:
 CROSS-SECTION
 7+260

Scale: H 1:400 V 1:200 **Drawing No.:** 314

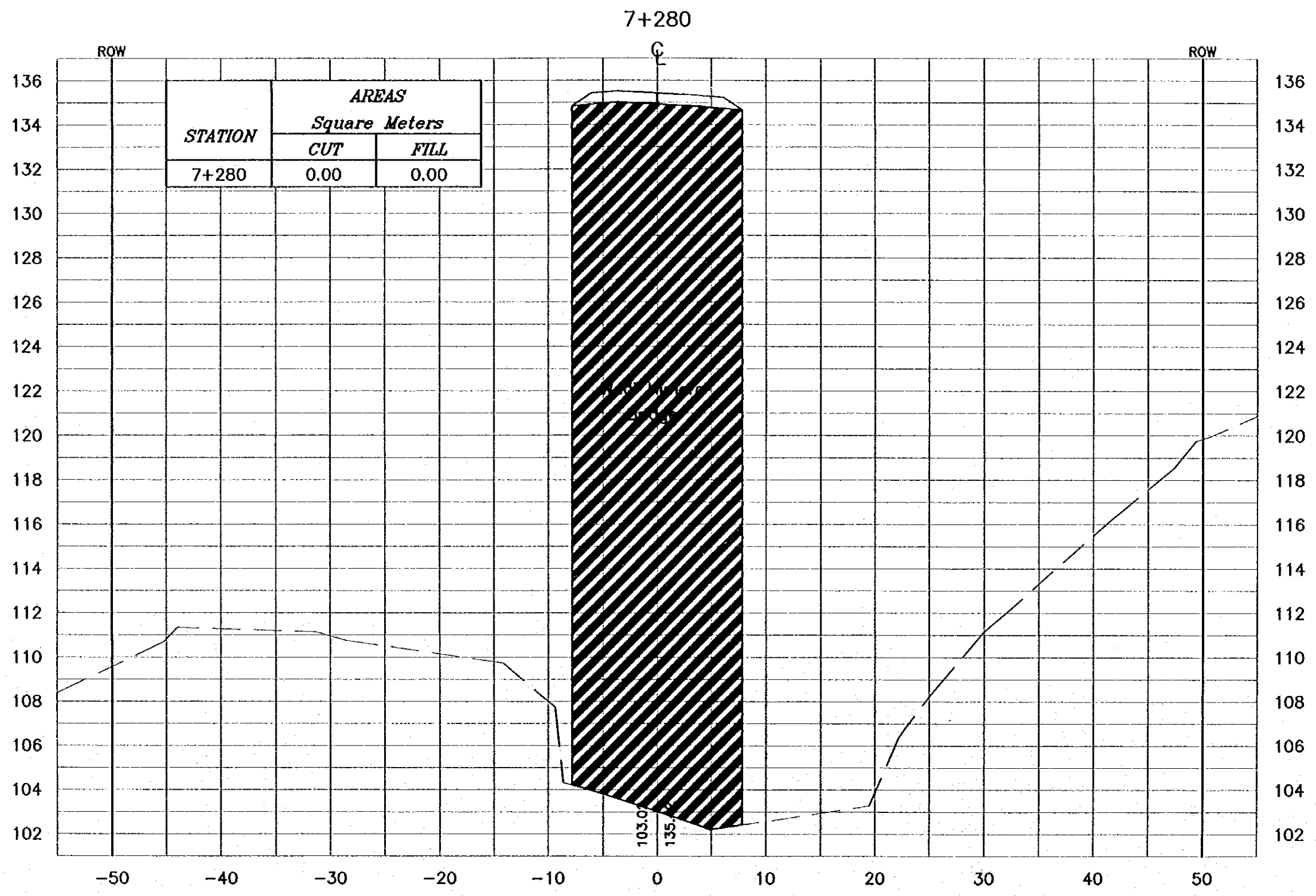
NOTES :
 * FOR EXACT HEIGHTS AND DIMENSIONS OF BENCHES SEE TYPICAL ROAD CROSS-SECTION .
 * SLOPE H : V .



Project:
 Tourism Sector Development Project
 in the Hashemite Kingdom of Jordan

Executing Agency:
 The Ministry of Tourism and Antiquities
 The Ministry of Planning

SUB-PROJECT:
 Dead Sea Parkway

Note:
 This detailed design has been executed by a team of consultants as shown below in accordance with the agreement between Japan International Cooperation Agency (JICA) and JICA Study Team. The copyright of this drawing rests with JICA.

Designed by:
 Japan International Cooperation Agency (JICA)

JICA Study Team:
 Joint Venture of Pacific Consultants International and Yamashita Sekidai Inc.

Subcontracted Local Consultant:

 consolidated consultants
 engineering & environment
 Tel: 9952577 - Fax: 9952588 - Amman - Jordan

Drawing Title:
 CROSS-SECTION
 7+280

Scale:
 H 1:400
 V 1:200

Drawing No.: 315

NOTES :

1. The design is based on the data provided by the client.
 2. The design is based on the design speed of 100 km/h.
 3. The design is based on the design load of 200 kN/m.
 4. The design is based on the design life of 100 years.

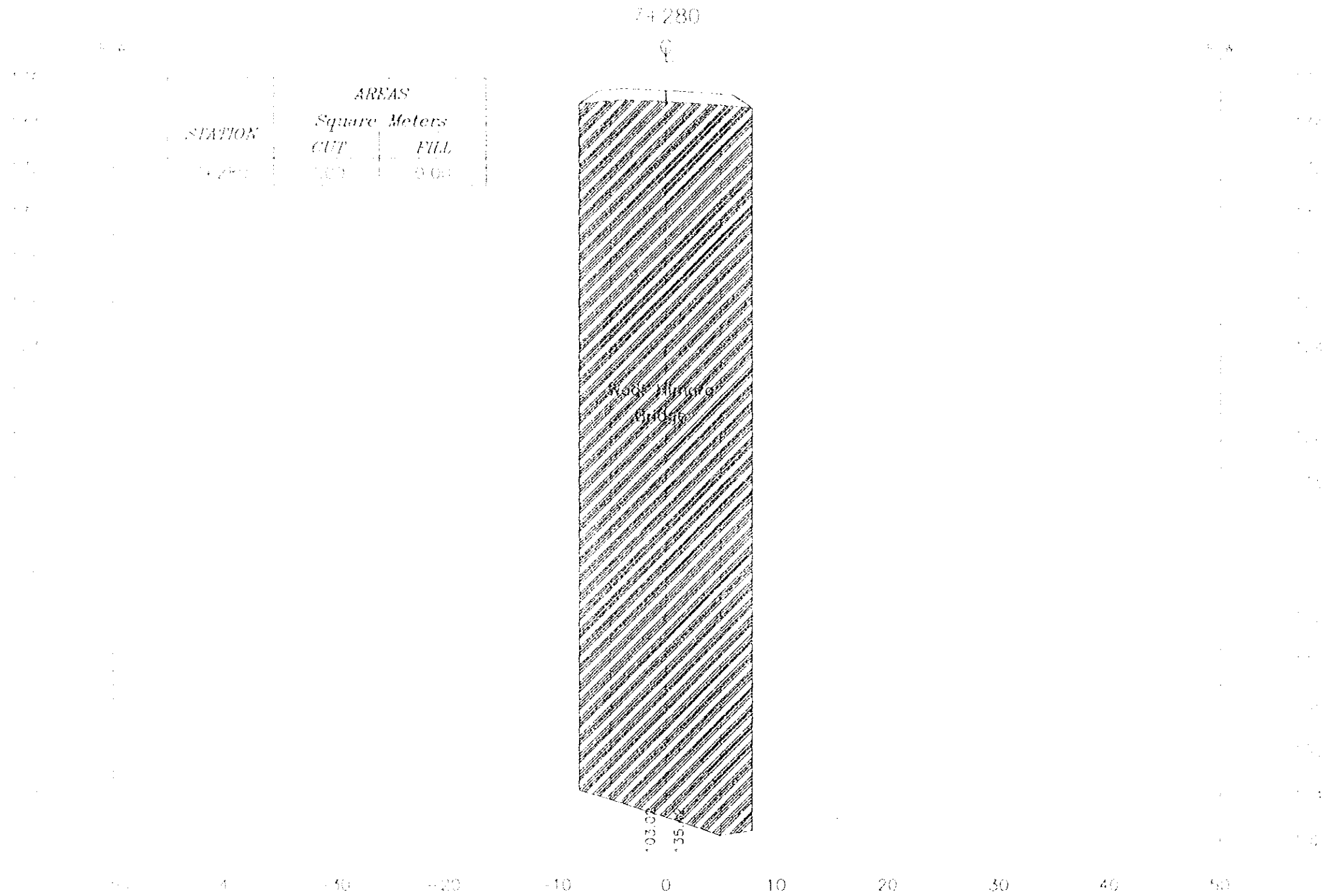

1. The design is based on the data provided by the client.
 2. The design is based on the design speed of 100 km/h.
 3. The design is based on the design load of 200 kN/m.
 4. The design is based on the design life of 100 years.

Designed by:
 Japan International Cooperation Agency (JICA)

JICA Study Team
 Joint Venture of
 Pacific Consultants International Ltd
 Kansai Sekkei Ltd

Subcontracted Local Consultant:
 consolidated consultants
 株式会社 総合コンサルタント
 〒100-0001 東京都千代田区千代田 1-1-1

Drawing Title:
 CROSS SECTION
 74.280

Scale: 1/400 | Drawing No.: 315
 1/200

NOTES :

- * FOR EXACT HEIGHTS AND DIMENSIONS OF BENCHES SEE TYPICAL ROAD CROSS-SECTION .
- * SLOPE H : V .

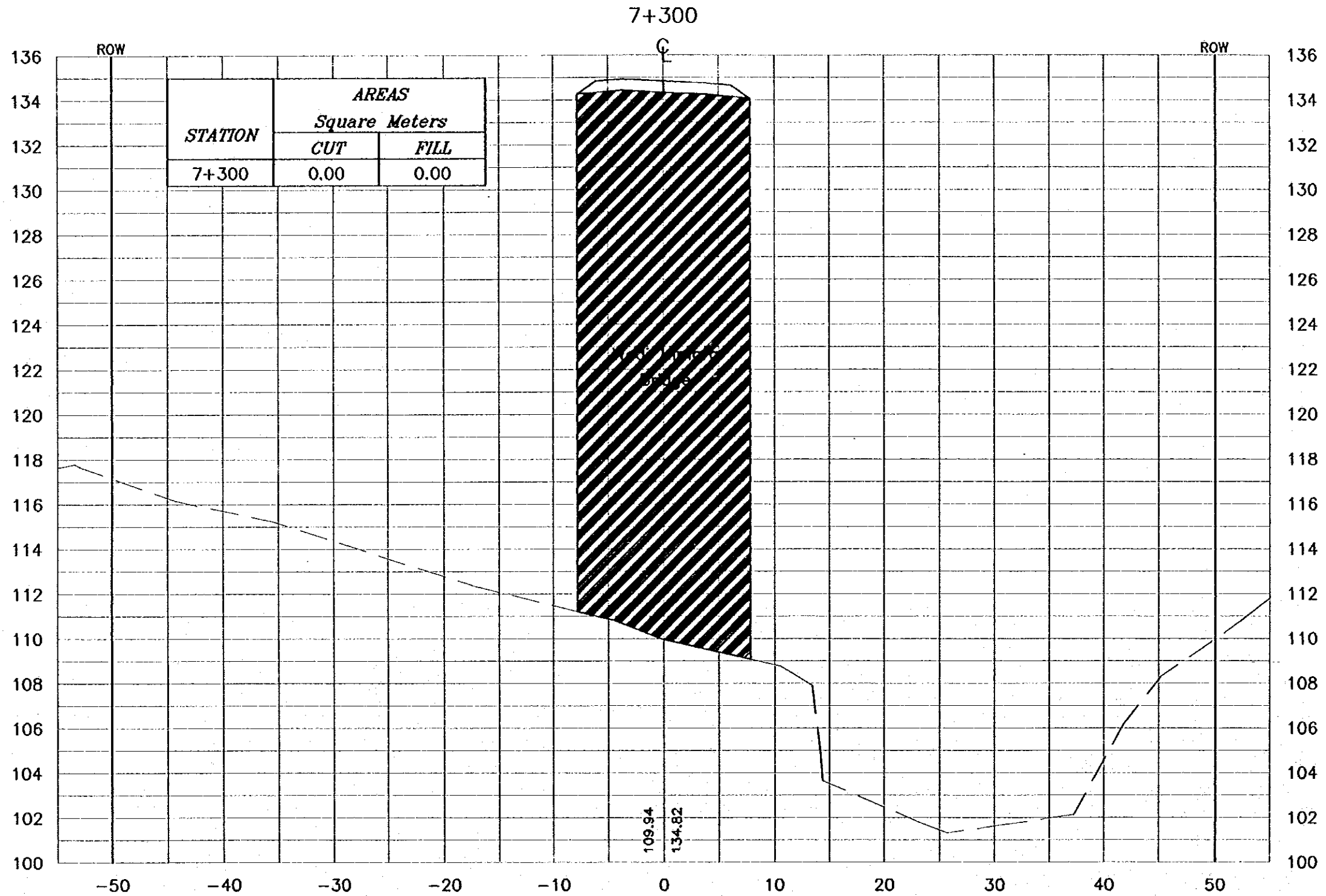

Project:
Tourism Sector Development Project
in the Hashemite Kingdom of Jordan

Executing Agency:
The Ministry of Tourism and Antiquities
The Ministry of Planning

SUB-PROJECT:
Dead Sea Parkway

Note:
This detailed design has been executed by
a team of consultants as shown below in
accordance with the agreement between
Japan International Cooperation Agency
(JICA) and JICA Study Team.
The copyright of this drawing rests with JICA.

Designed by:
Japan International Cooperation
Agency (JICA)

JICA Study Team:
Joint Venture of
Pacific Consultants International and
Yamashita Seikai Inc.

Subcontracted Local Consultant:
 **consolidated consultants**
engineering & environment
Tel: 952277 - Fax: 952280 - AMMAN - JORDAN

Drawing Title:
CROSS-SECTION
7+300

Scale: H 1:400 V 1:200 **Drawing No.:** 316

NOTES
 1. This drawing is a part of the
 2. JICA Study Team
 3. Project No. 152010-01
 4. Road Improvement Project
 5. in the City of
 6. Fukuoka, Japan

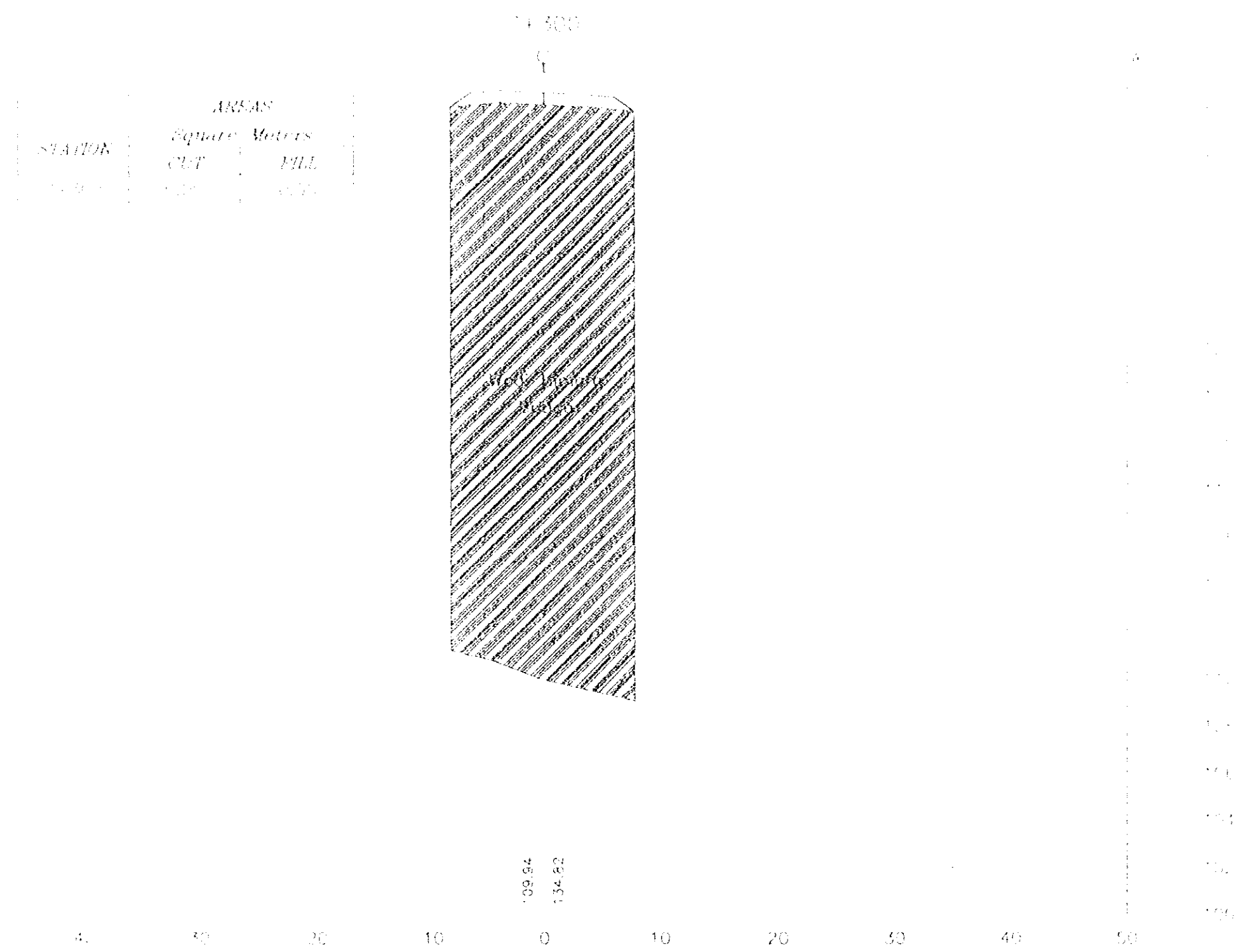

1. This drawing is a part of the
 2. JICA Study Team
 3. Project No. 152010-01
 4. Road Improvement Project
 5. in the City of
 6. Fukuoka, Japan

Designed by:
 Japan International Cooperation
 Agency (JICA)

JICA Study Team
 Joint Venture of
 Pacific Consultants International and
 Kansai Sekkei Inc.

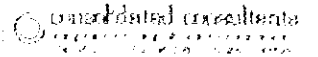
Subcontracted Local Consultant:

Drawn by:
 PACIFIC CONSULTANTS
 74.300

Sheet No. 14 of 16
 Working No. 1-120

NOTES :

- * FOR EXACT HEIGHTS AND DIMENSIONS OF BENCHES SEE TYPICAL ROAD CROSS-SECTION .
- * SLOPE H : V .

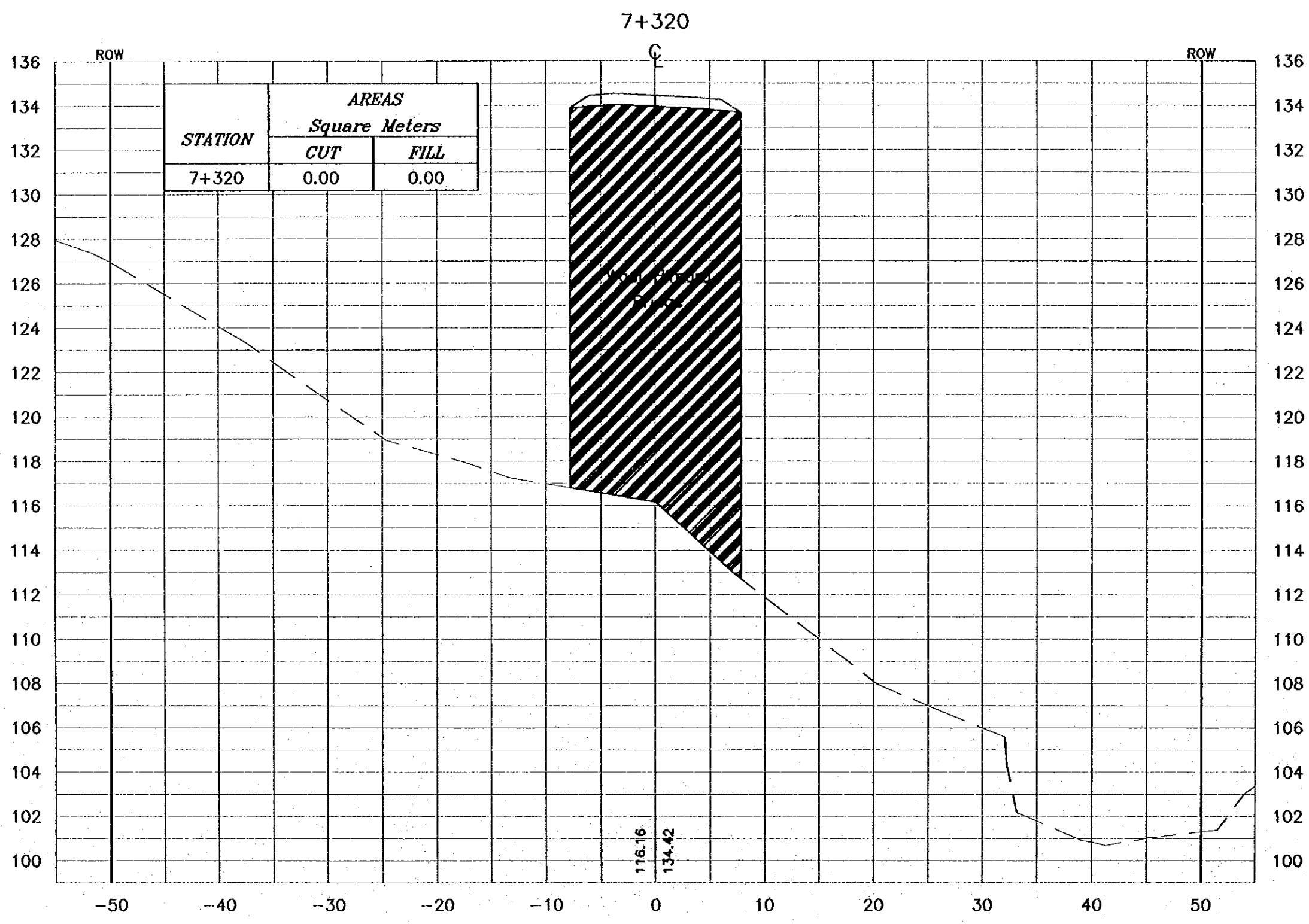

Project:
Tourism Sector Development Project
in the Hashemite Kingdom of Jordan

Executing Agency:
The Ministry of Tourism and Antiquities
The Ministry of Planning

SUB-PROJECT:
Dead Sea Parkway

Note:
This detailed design has been executed by a team of consultants as shown below in accordance with the agreement between Japan International Cooperation Agency (JICA) and JICA Study Team. The copyright of this drawing rests with JICA.

Designed by:
Japan International Cooperation Agency (JICA)

JICA Study Team:
Joint Venture of Pacific Consultants International and Yamashita Sekioku Inc.

Subcontracted Local Consultant:
 consolidated consultants
engineering & environment
Tel: 912277 - Fax: 912280 - AMMAN - JORDAN

Drawing Title:
CROSS-SECTION
7+320

Scale: H 1:400 V 1:200 **Drawing No.:** 317

NOTES :

- * FOR EXACT HEIGHTS AND DIMENSIONS OF BENCHES SEE TYPICAL ROAD CROSS-SECTION .
- * SLOPE H : V .

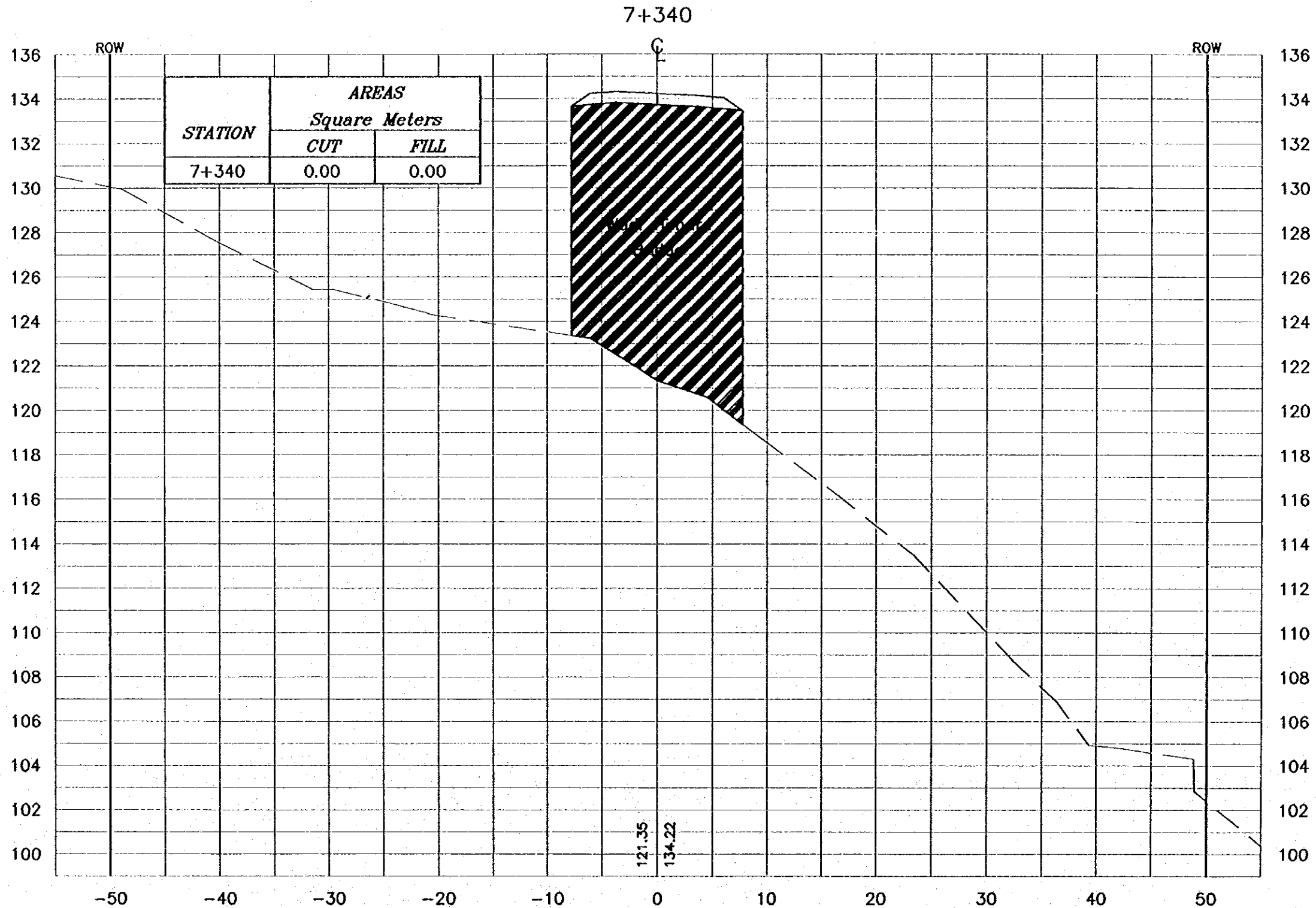

Project:
Tourism Sector Development Project
in the Hashemite Kingdom of Jordan

Executing Agency:
The Ministry of Tourism and Antiquities
The Ministry of Planning

SUB-PROJECT:
Dead Sea Parkway

Note:
This detailed design has been executed by
a team of consultants as shown below in
accordance with the agreement between
Japan International Cooperation Agency
(JICA) and JICA Study Team.
The copyright of this drawing rests with JICA.

Designed by:
Japan International Cooperation
Agency (JICA)

JICA Study Team:
Joint Venture of
Pacific Consultants International and
Yamashita Seki Inc.

Subcontracted Local Consultant:

consolidated consultants
engineering & architecture
Tel: 962577 - Fax: 962586 - AMM - JORDAN

Drawing Title:
CROSS-SECTION
7+340

Scale: 1:400
V 1:200 **Drawing No.:** 318

NOTES

1. This drawing is a part of the project and shall not be used for any other purpose without the written consent of the Engineer.

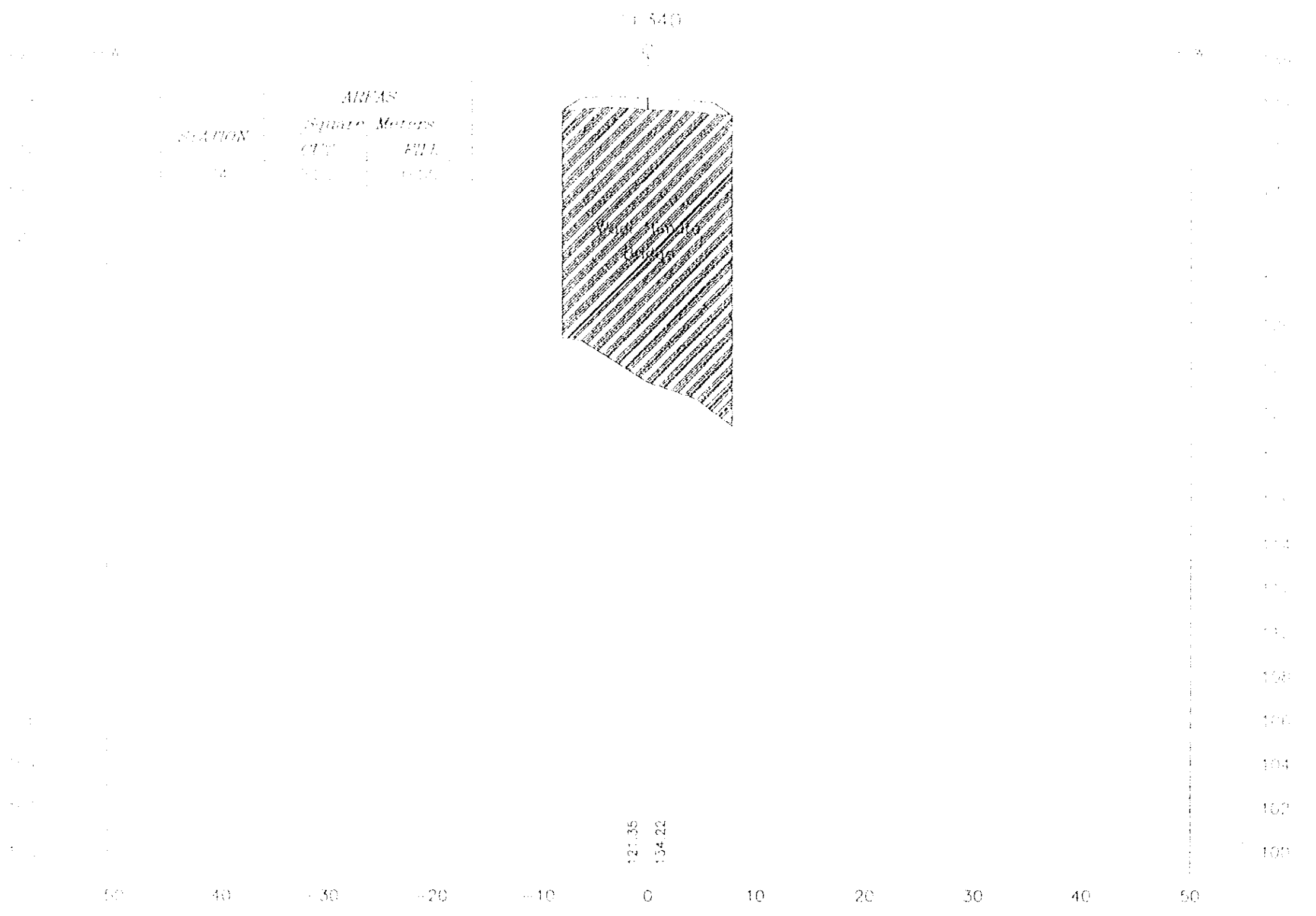

STATION	AREAS	
	CUT	FILL
71.340	121.35	134.22

Prepared by:
 Checked by:
 Design by:
 Checked by:
 Approved by:
 Date:

This drawing is a part of the project and shall not be used for any other purpose without the written consent of the Engineer.

Designed by:
 Checked by:
 Approved by:

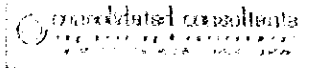
JICA Study Team
 Joint Venture of
 Pacific Consultants International and
 Kansai Denka Engineering Inc.
 Subcontracted Local Consultant

Drawing Title
 CROSS-SECTION
 71.340

Scale: 1:200
 Drawing No.: 318

7+360

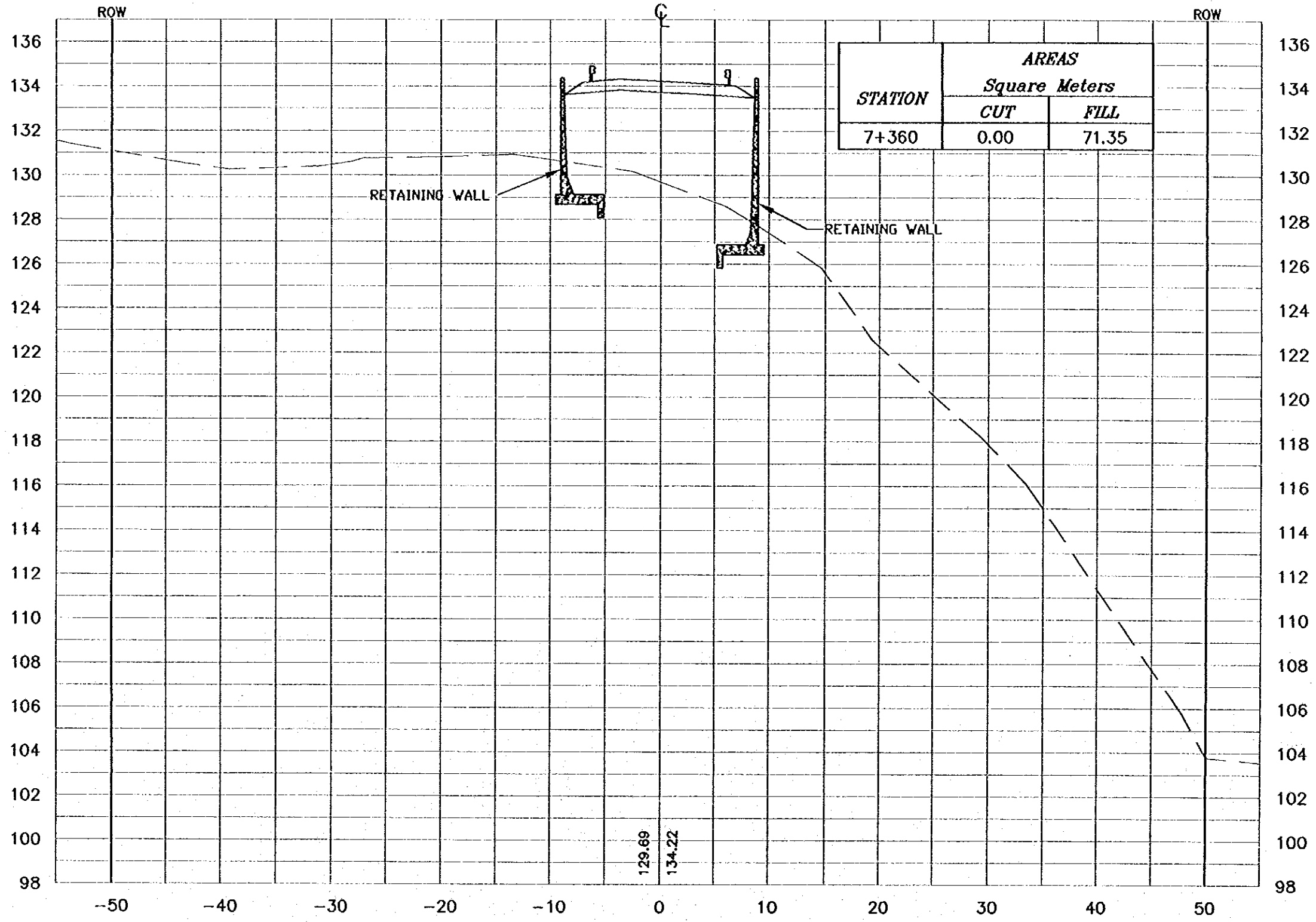

NOTES :

- * FOR EXACT HEIGHTS AND DIMENSIONS OF BENCHES SEE TYPICAL ROAD CROSS-SECTION .
- * SLOPE H : V .

Project:
Tourism Sector Development Project
in the Hashemite Kingdom of Jordan

Executing Agency:
The Ministry of Tourism and Antiquities
The Ministry of Planning

SUB-PROJECT:
Dead Sea Parkway

Note:
This detailed design has been executed by a team of consultants as shown below in accordance with the agreement between Japan International Cooperation Agency (JICA) and JICA Study Team. The copyright of this drawing rests with JICA.

Designed by:
Japan International Cooperation Agency (JICA)

JICA Study Team:
Joint Venture of Pacific Consultants International and Yamashita Seki Co. Inc.

Subcontracted Local Consultant:
consolidated consultants
Engineering & Architecture
P.O. Box 12377 - Fax: 9952360 - Amman - Jordan

Drawing Title:
CROSS-SECTION
7+360

Scale: H 1:400 V 1:200 **Drawing No.:** 319

7+380

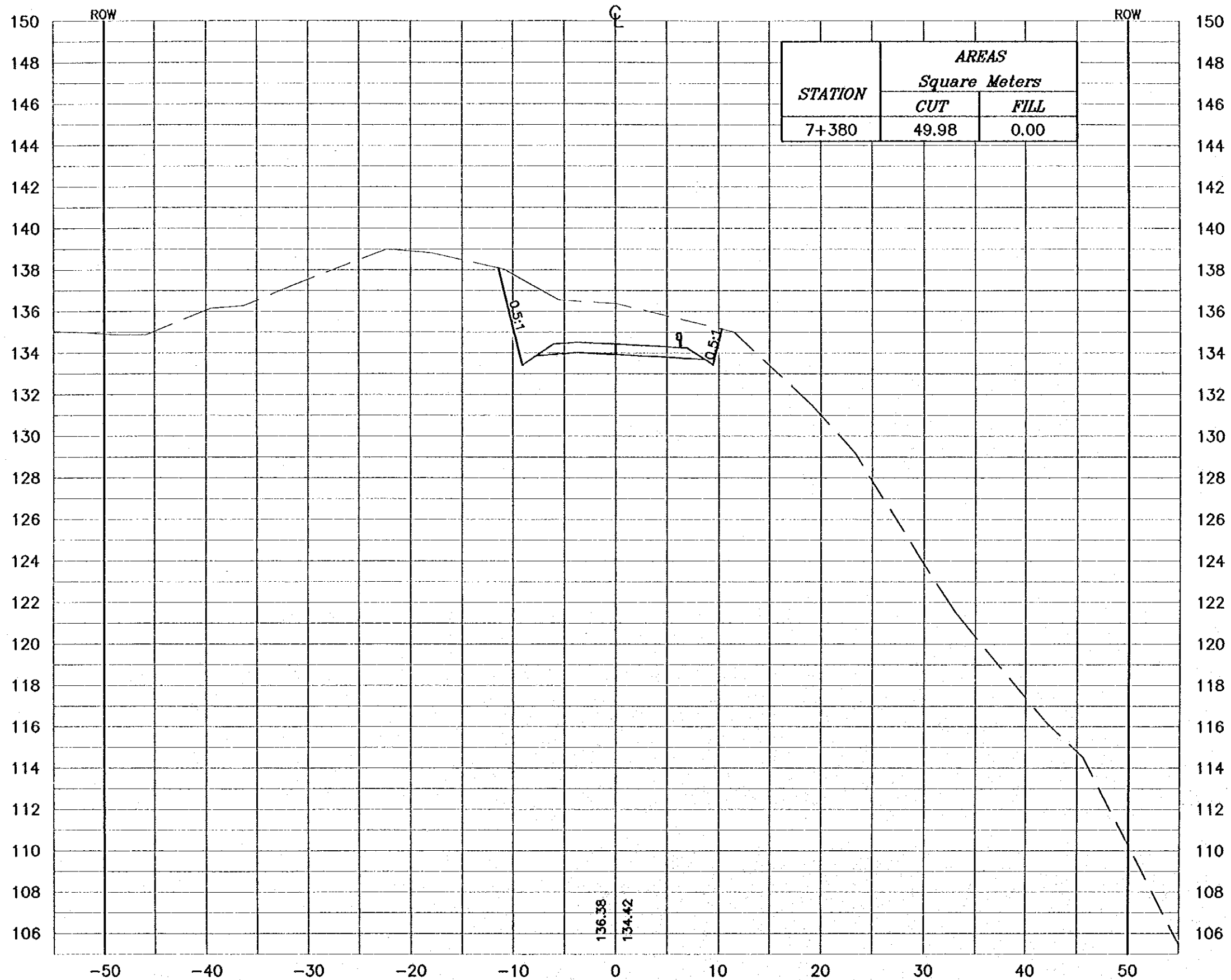

NOTES :

- * FOR EXACT HEIGHTS AND DIMENSIONS OF BENCHES SEE TYPICAL ROAD CROSS-SECTION .
- * SLOPE H : V .

Project:
Tourism Sector Development Project
in the Hashemite Kingdom of Jordan

Executing Agency:
The Ministry of Tourism and Antiquities
The Ministry of Planning

SUB-PROJECT:
Dead Sea Parkway

Note:
This detailed design has been executed by a team of consultants as shown below in accordance with the agreement between Japan International Cooperation Agency (JICA) and JICA Study Team.
The copyright of this drawing rests with JICA.

Designed by:
Japan International Cooperation Agency (JICA)

JICA Study Team:
Joint Venture of
Pacific Consultants International and
Yamashita Sekido Inc.

Subcontracted Local Consultant:

consolidated consultants
engineering & environment
No. 902571 - Fax. 902288 - JORDAN - JORDAN

Drawing Title:
CROSS-SECTION
7+380

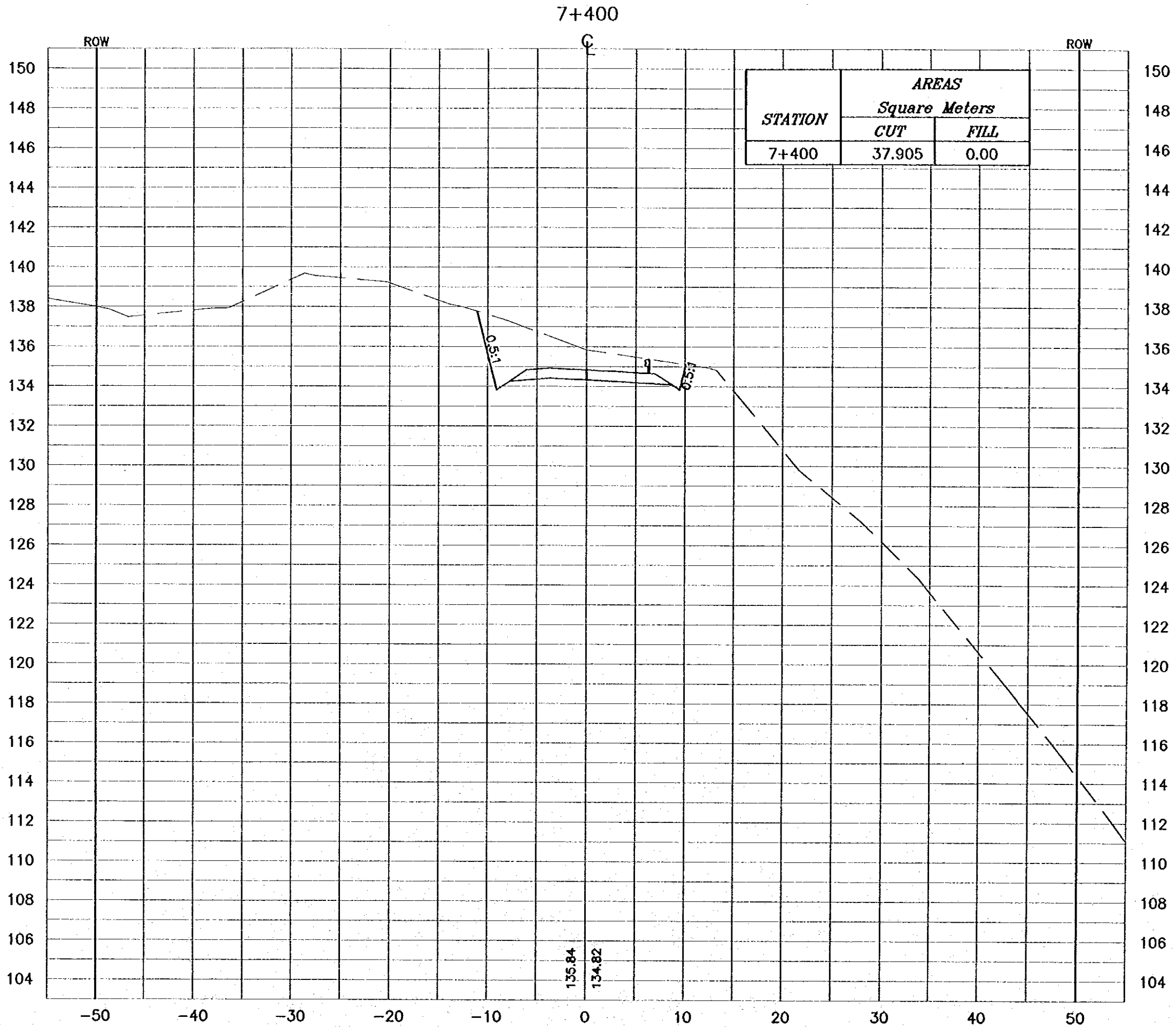
Scale: H 1:400 V 1:200 **Drawing No.:** 320



NOTES :

- * FOR EXACT HEIGHTS AND DIMENSIONS OF BENCHES SEE TYPICAL ROAD CROSS-SECTION .
- * SLOPE H : V .

Project:
Tourism Sector Development Project
in the Hashemite Kingdom of Jordan

Executing Agency:
The Ministry of Tourism and Antiquities
The Ministry of Planning

SUB-PROJECT:
Dead Sea Parkway

Note:
This detailed design has been executed by a team of consultants as shown below in accordance with the agreement between Japan International Cooperation Agency (JICA) and JICA Study Team. The copyright of this drawing rests with JICA.

Designed by:
Japan International Cooperation Agency (JICA)

JICA Study Team:
Joint Venture of
Pacific Consultants International and
Yamashita Seldal Inc.

Subcontracted Local Consultant:
consolidated consultants
ENGINEERING & ENVIRONMENTAL
Tel: 492327 - Fax: 492398 - AMMAN - JORDAN

Drawing Title:
CROSS-SECTION
7+400

Scale: H 1:400 V 1:200 **Drawing No.:** 321

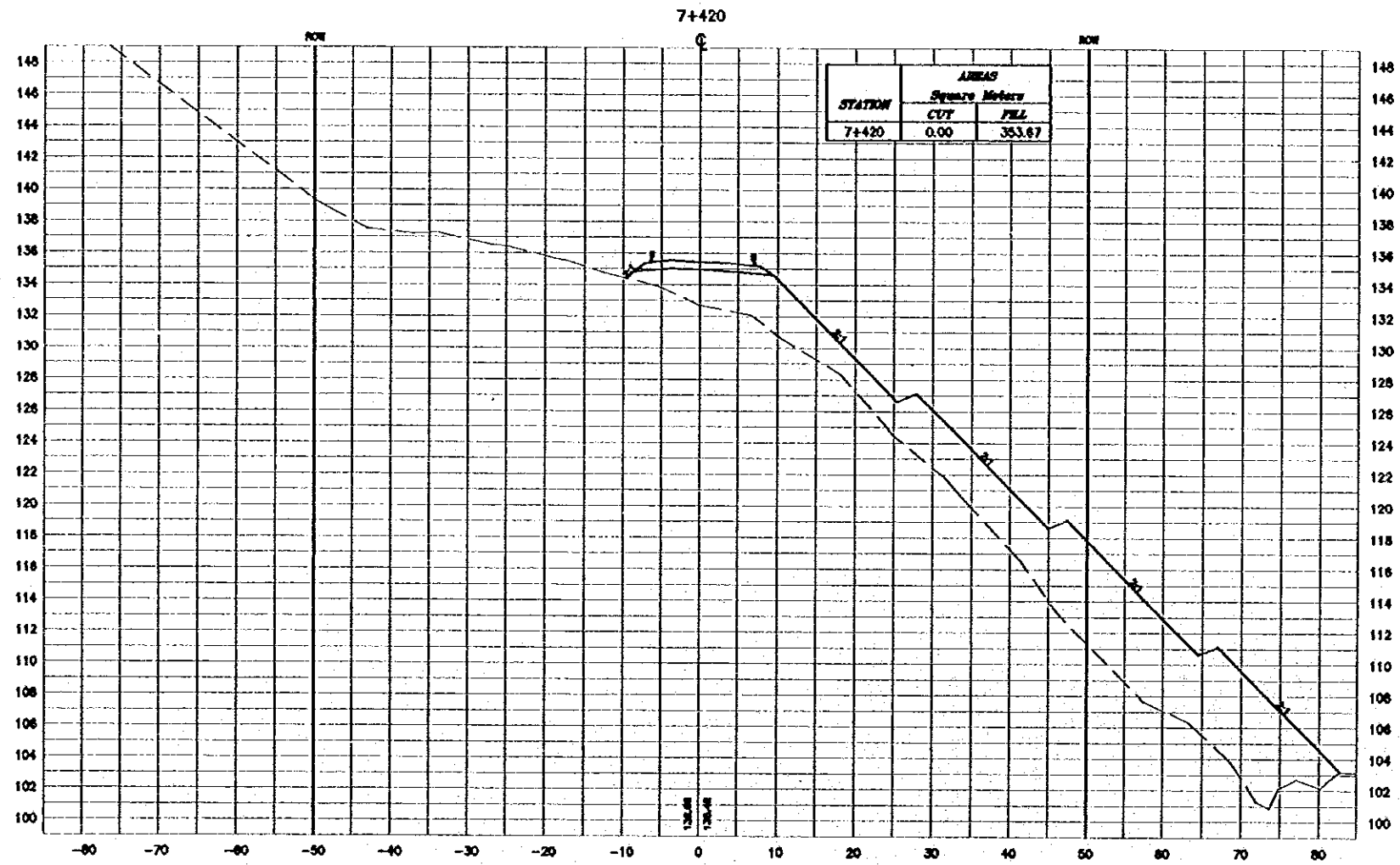

NOTES :

- * FOR EXACT HEIGHTS AND DIMENSIONS OF BENCHES SEE TYPICAL ROAD CROSS-SECTION .
- * SLOPE H : V .

Project:
Tourism Sector Development Project
in the Hashemite Kingdom of Jordan

Executing Agency:
The Ministry of Tourism and Antiquities
The Ministry of Planning

SUB-PROJECT:
Dead Sea Parkway

Note:
This detailed design has been executed by a team of consultants as shown below in accordance with the agreement between Japan International Cooperation Agency (JICA) and JICA Study Team.
The copyright of this drawing rests with JICA.

Designed by:
Japan International Cooperation Agency (JICA)

JICA Study Team:
Joint Venture of Pacific Consultants International and Yamashita Seiki Co. Inc.

Subcontracted Local Consultant:

consolidated consultants
engineering & environment
Tel. 4612577 - Fax. 4612580 - AMMAN - JORDAN

Drawing Title:
CROSS-SECTION
7+420

Scale: H: 1:800 V: 1:400 **Drawing No.:** 322

7+440

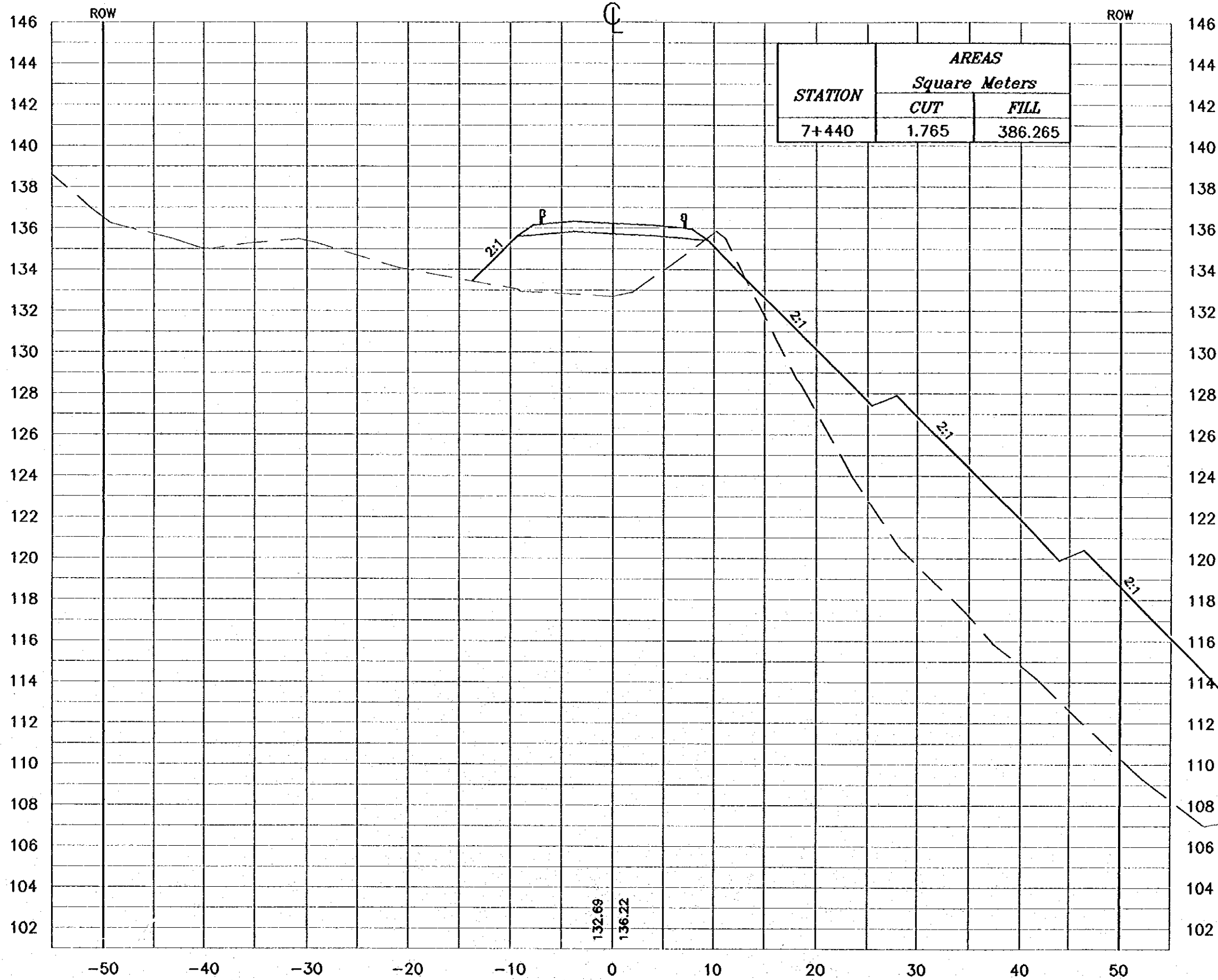

NOTES :

- * FOR EXACT HEIGHTS AND DIMENSIONS OF BENCHES SEE TYPICAL ROAD CROSS-SECTION .
- * SLOPE H : V .

Project:
Tourism Sector Development Project
in the Hashemite Kingdom of Jordan

Executing Agency:
The Ministry of Tourism and Antiquities
The Ministry of Planning

SUB-PROJECT:
Dead Sea Parkway

Note:
This detailed design has been executed by a team of consultants as shown below in accordance with the agreement between Japan International Cooperation Agency (JICA) and JICA Study Team. The copyright of this drawing rests with JICA.

Designed by:
Japan International Cooperation Agency (JICA)

JICA Study Team:
Joint Venture of Pacific Consultants International and Yamashita Sekihei Inc.

Subcontracted Local Consultant:

consolidated consultants
engineering & construction
Tel. 0112277 - Fax. 0112288 - Amman - Jordan

Drawing Title:
CROSS-SECTION
7+440

Scale: H 1:400 V 1:200 **Drawing No.:** 323

NOTES :

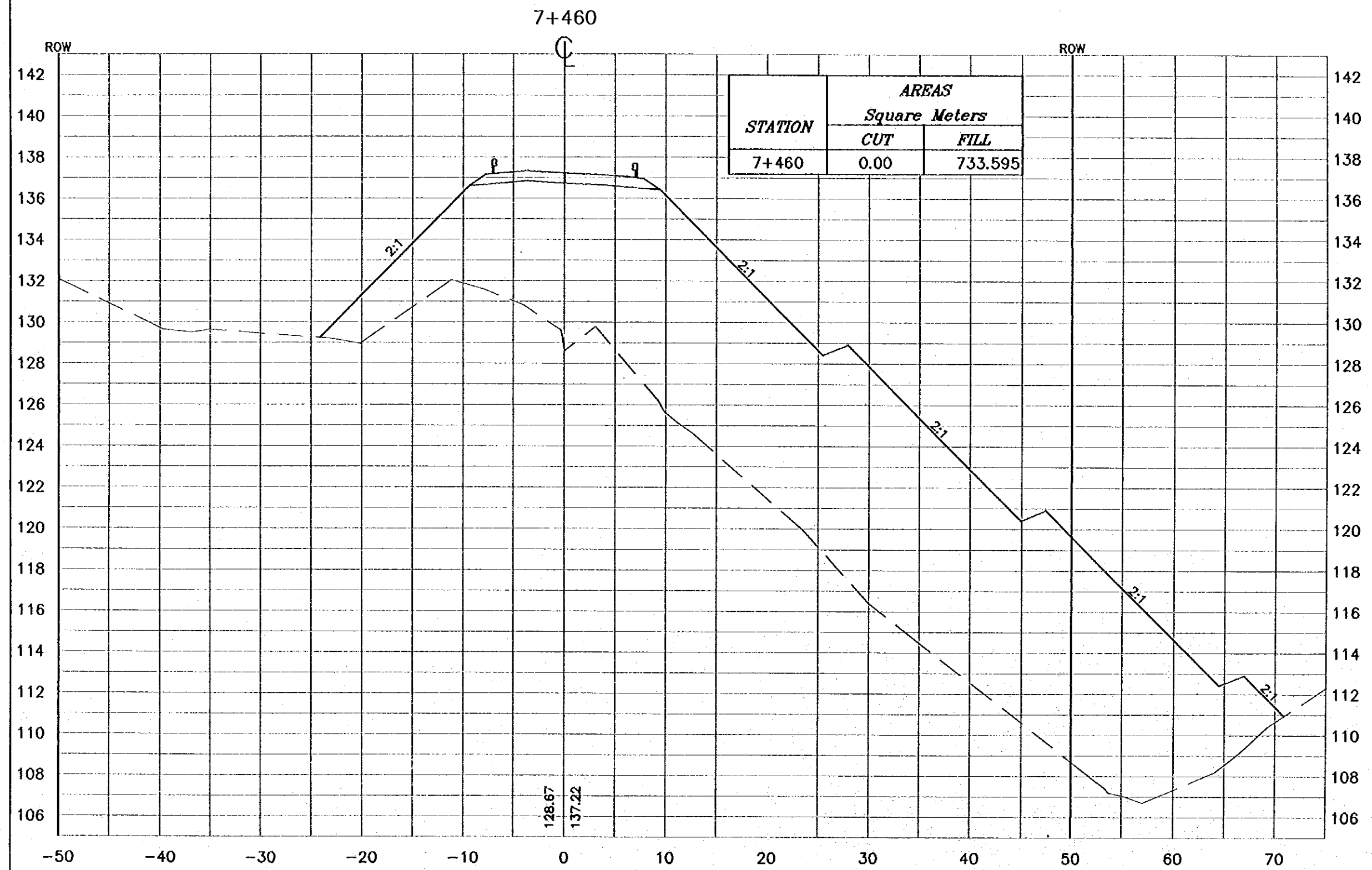
- * FOR EXACT HEIGHTS AND DIMENSIONS OF BENCHES SEE TYPICAL ROAD CROSS-SECTION .
- * SLOPE H : V .



Project:
Tourism Sector Development Project
in the Hashemite Kingdom of Jordan

Executing Agency:
The Ministry of Tourism and Antiquities
The Ministry of Planning

SUB-PROJECT:
Dead Sea Parkway

Note:
This detailed design has been executed by
a team of consultants as shown below in
accordance with the agreement between
Japan International Cooperation Agency
(JICA) and JICA Study Team.
The copyright of this drawing rests with JICA.

Designed by:
Japan International Cooperation
Agency (JICA)

JICA Study Team:
Joint Venture of
Pacific Consultants International and
Yamashita Sekitel Inc.

Subcontracted Local Consultant:
consolidated consultants
engineering & environment
14, 16/2277 - Fax: 9612380 - Amman - JORDAN

Drawing Title:
CROSS-SECTION
7+460

Scale: H 1:400 Drawing No.: 324
V 1:200

NOTES :

- * FOR EXACT HEIGHTS AND DIMENSIONS OF BENCHES SEE TYPICAL ROAD CROSS-SECTION .
- * SLOPE H : V .

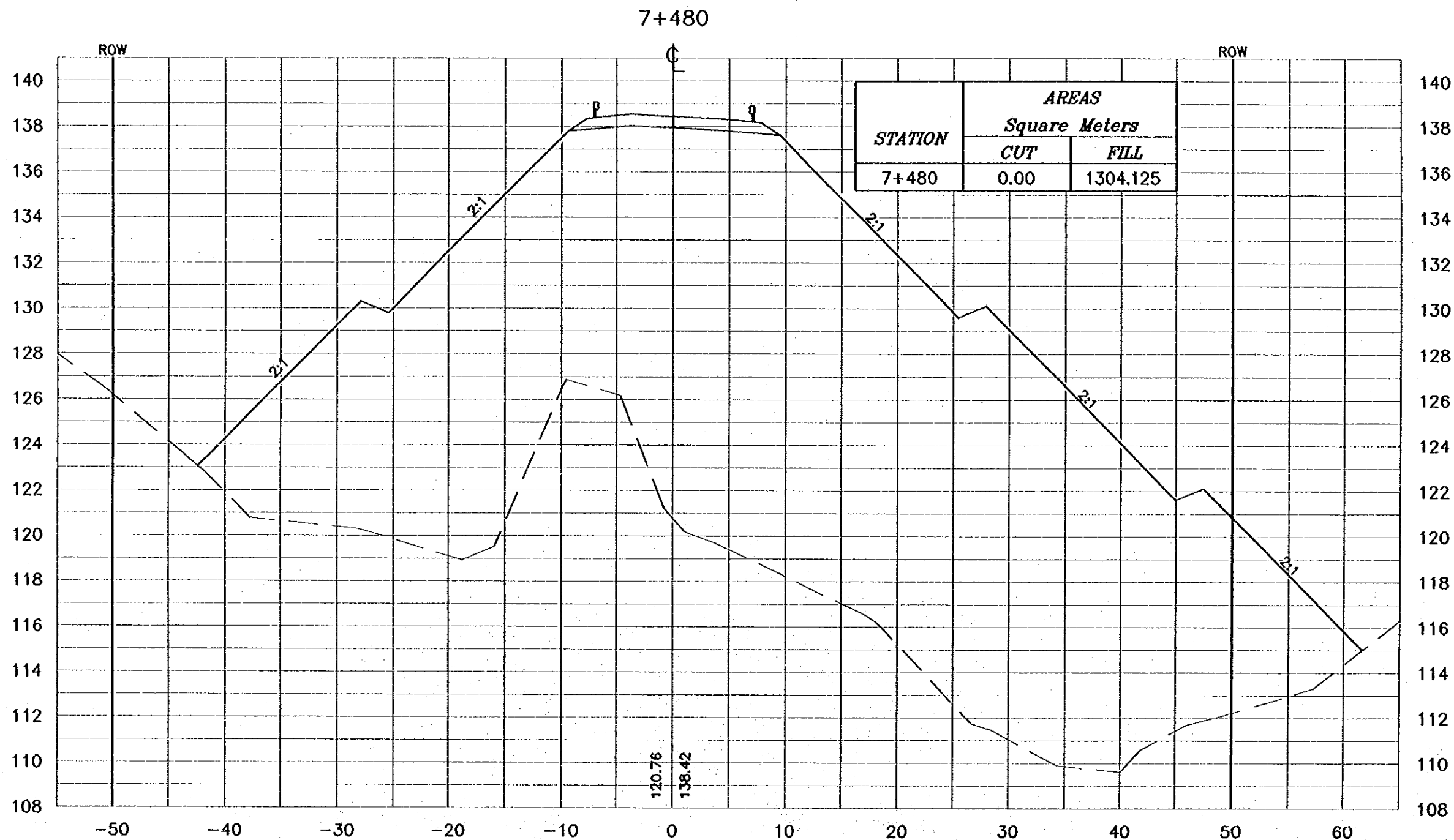

Project:
Tourism Sector Development Project
in the Hashemite Kingdom of Jordan

Executing Agency:
The Ministry of Tourism and Antiquities
The Ministry of Planning

SUB-PROJECT:
Dead Sea Parkway

Note:
This detailed design has been executed by
a team of consultants as shown below in
accordance with the agreement between
Japan International Cooperation Agency
(JICA) and JICA Study Team.
The copyright of this drawing rests with JICA.

Designed by:
Japan International Cooperation
Agency (JICA)

JICA Study Team:
Joint Venture of
Pacific Consultants International and
Yamashita Seiki Inc.

Subcontracted Local Consultant:
consolidated consultants
engineering & environment
Tel: 012377 - Fax: 012388 - AMM - JORDAN

Drawing Title:
CROSS-SECTION
7+480

Scale: H 1:400 V 1:200 **Drawing No.:** 325

NOTES :

- * FOR EXACT HEIGHTS AND DIMENSIONS OF BENCHES SEE TYPICAL ROAD CROSS-SECTION .
- * SLOPE H : V .

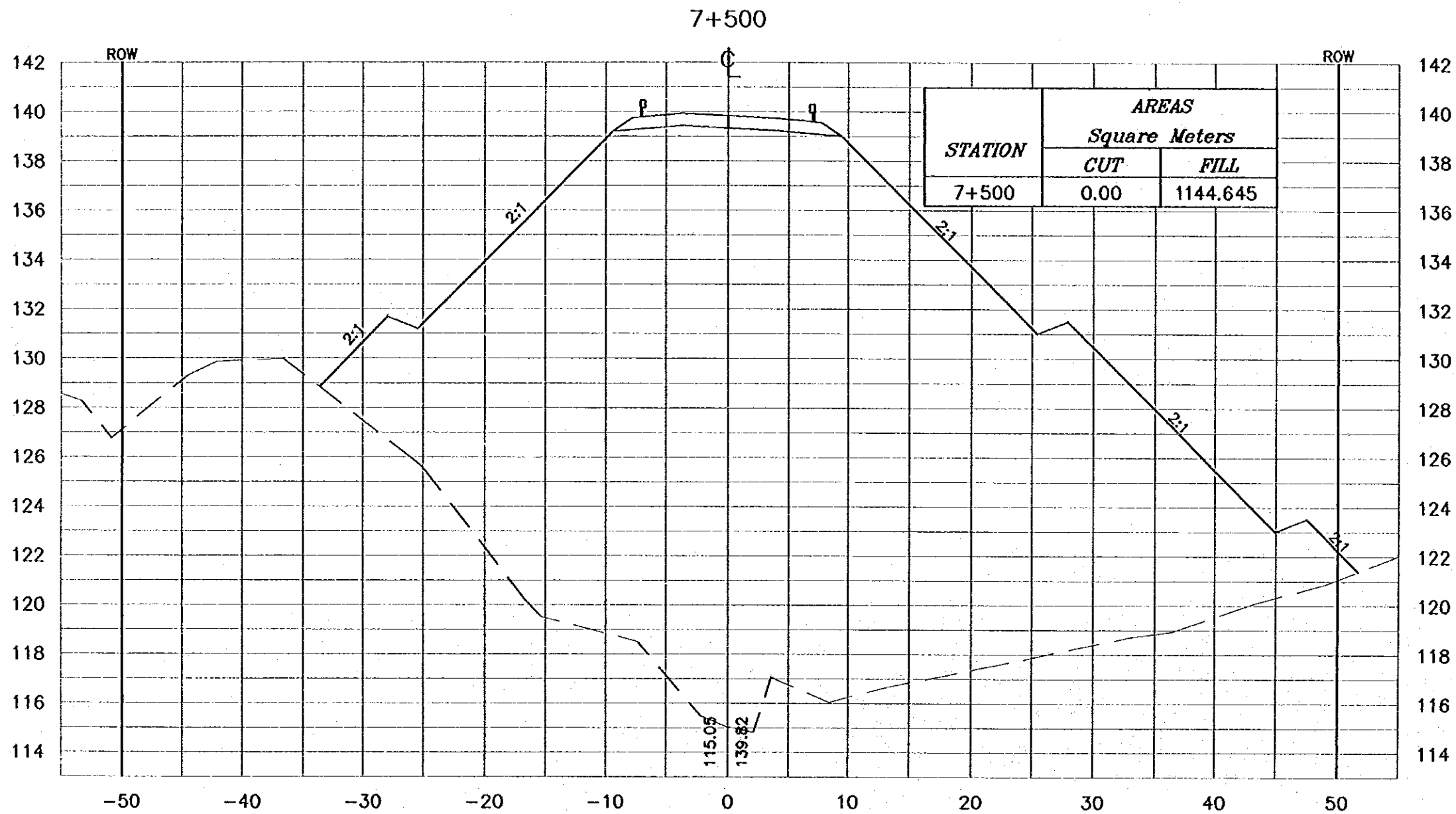

Project:
Tourism Sector Development Project
in the Hashemite Kingdom of Jordan

Executing Agency:
The Ministry of Tourism and Antiquities
The Ministry of Planning

SUB-PROJECT:
Dead Sea Parkway

Note:
This detailed design has been executed by a team of consultants as shown below in accordance with the agreement between Japan International Cooperation Agency (JICA) and JICA Study Team. The copyright of this drawing rests with JICA.

Designed by:
Japan International Cooperation Agency (JICA)

JICA Study Team:
Joint Venture of Pacific Consultants International and Yamashita Sekkei Inc.

Subcontracted Local Consultant:
 consolidated consultants
engineering & environment
Tel: 012377 - Fax: 012391 - JORDAN - JORDAN

Drawing Title:
CROSS-SECTION
7+500

Scale: H 1:400 V 1:200 **Drawing No.:** 326

NOTES :

- * FOR EXACT HEIGHTS AND DIMENSIONS OF BENCHES SEE TYPICAL ROAD CROSS-SECTION .
- * SLOPE H : V .

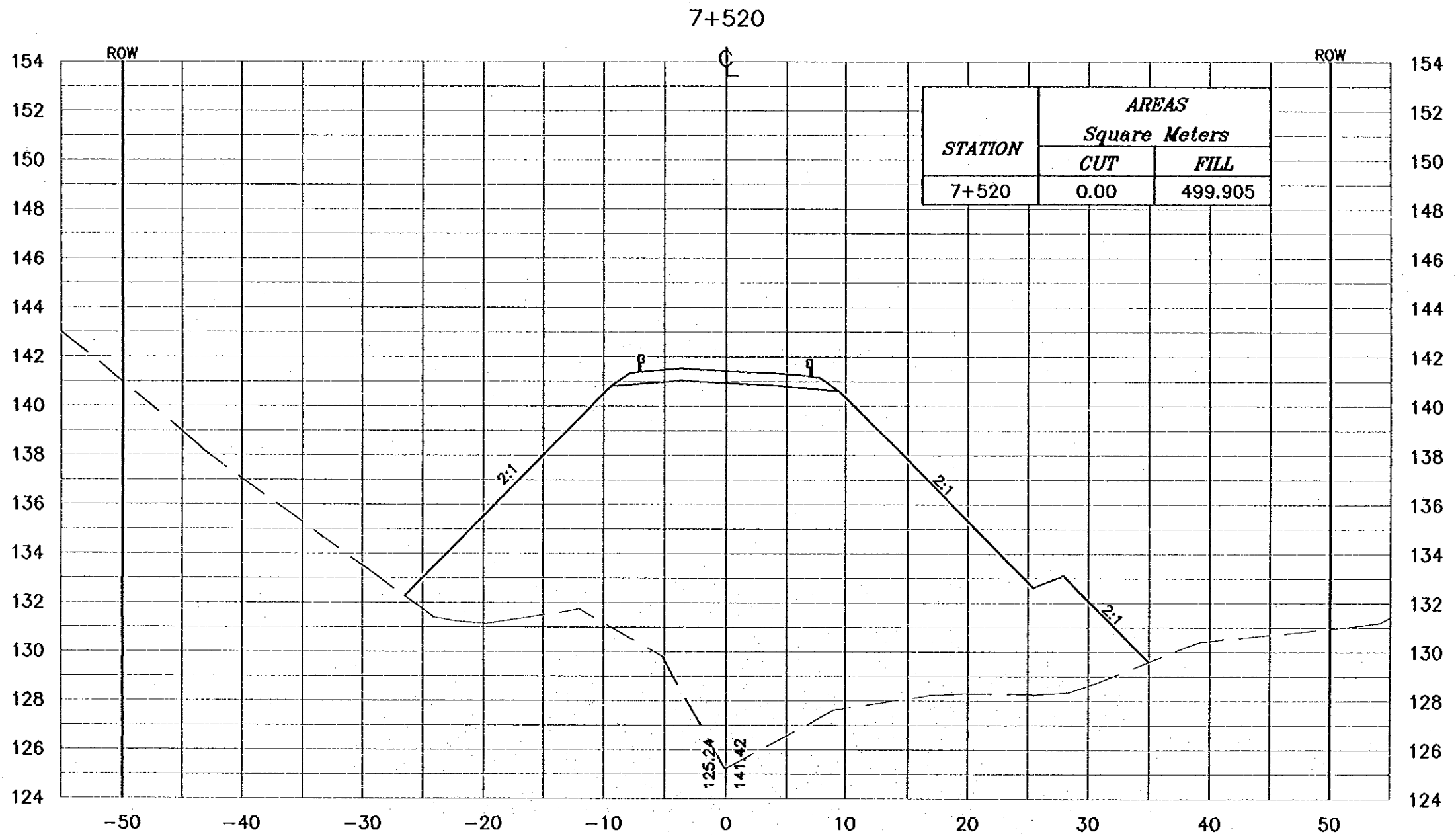

Project:
Tourism Sector Development Project
in the Hashemite Kingdom of Jordan

Executing Agency:
The Ministry of Tourism and Antiquities
The Ministry of Planning

SUB-PROJECT:
Dead Sea Parkway

Note:
This detailed design has been executed by
a team of consultants as shown below in
accordance with the agreement between
Japan International Cooperation Agency
(JICA) and JICA Study Team.
The copyright of this drawing rests with JICA.

Designed by:
Japan International Cooperation
Agency (JICA)

JICA Study Team:
Joint Venture of
Pacific Consultants International and
Yamashita Sekkol Inc.

Subcontracted Local Consultant:

Consolidated Consultants
Engineering & Environment
Tel: 0112377 - Fax: 0112300 - Amman - Jordan

Drawing Title:
CROSS-SECTION
7+520

Scale: H 1:400 V 1:200 **Drawing No.:** 327

NOTES :

- * FOR EXACT HEIGHTS AND DIMENSIONS OF BENCHES SEE TYPICAL ROAD CROSS-SECTION .
- * SLOPE H : V .

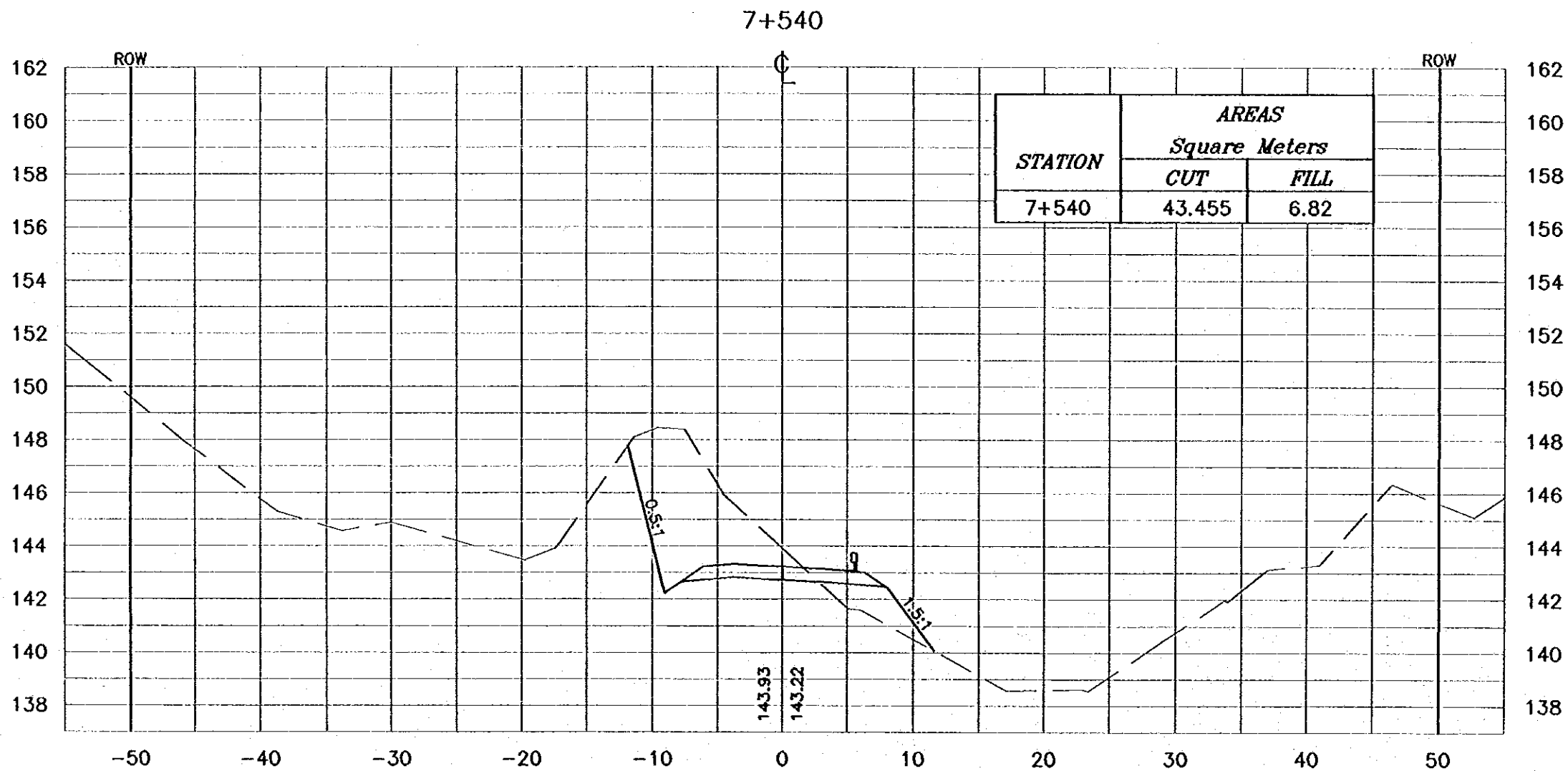

Project:
Tourism Sector Development Project
in the Hashemite Kingdom of Jordan

Executing Agency:
The Ministry of Tourism and Antiquities
The Ministry of Planning

SUB-PROJECT:
Dead Sea Parkway

Note:
This detailed design has been executed by
a team of consultants as shown below in
accordance with the agreement between
Japan International Cooperation Agency
(JICA) and JICA Study Team.
The copyright of this drawing rests with JICA.

Designed by:
Japan International Cooperation
Agency (JICA)

JICA Study Team:
Joint Venture of
Pacific Consultants International and
Yamashita Seki Co. Inc.

Subcontracted Local Consultant:

consolidated consultants
engineering & construction
Tel: 9622377 - Fax: 9622380 - Amman - Jordan

Drawing Title:
CROSS-SECTION
7+540

Scale: H 1:400 V 1:200 **Drawing No.:** 328

NOTES :

- * FOR EXACT HEIGHTS AND DIMENSIONS OF BENCHES SEE TYPICAL ROAD CROSS-SECTION .
- * SLOPE H : V .

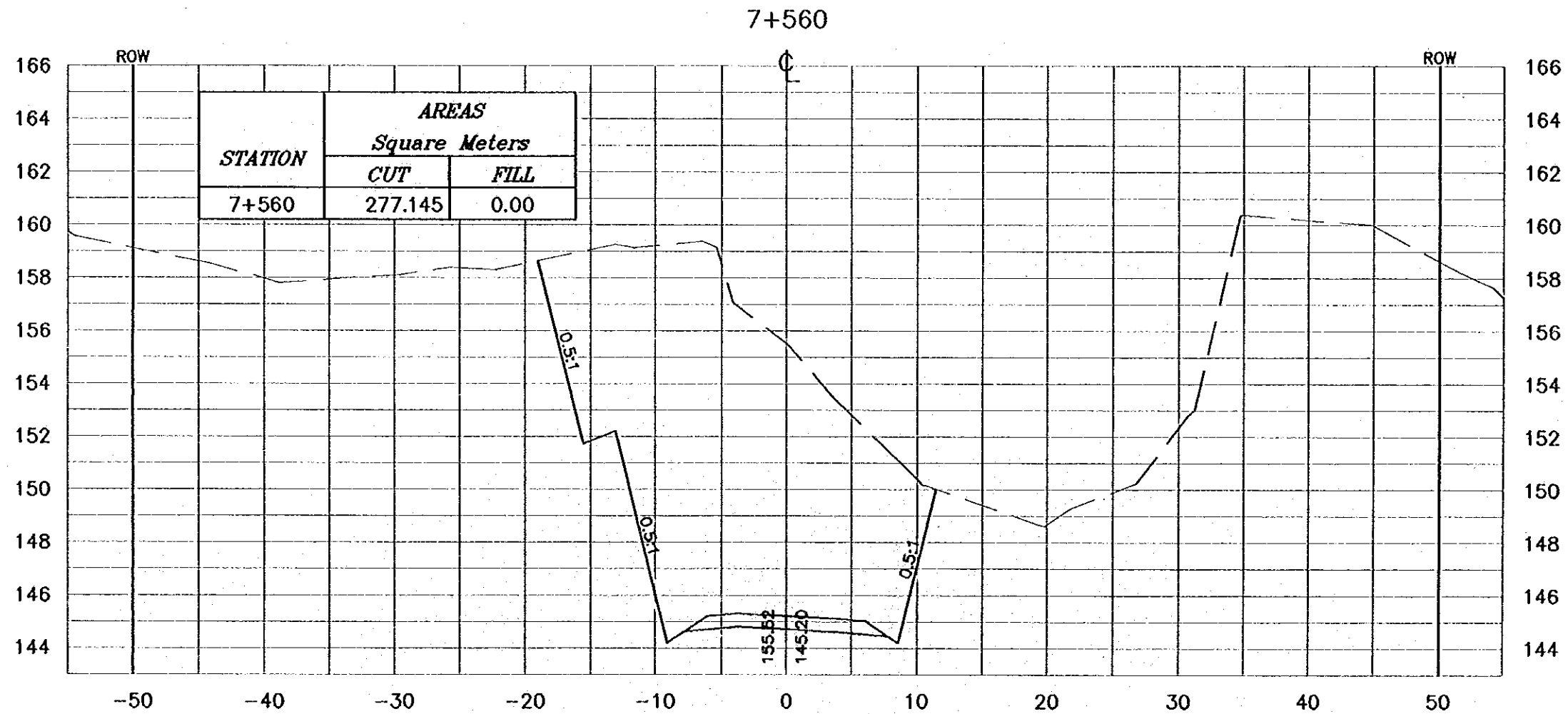

Project:
Tourism Sector Development Project
in the Hashemite Kingdom of Jordan

Executing Agency:
The Ministry of Tourism and Antiquities
The Ministry of Planning

SUB-PROJECT:
Dead Sea Parkway

Note:
This detailed design has been executed by
a team of consultants as shown below in
accordance with the agreement between
Japan International Cooperation Agency
(JICA) and JICA Study Team.
The copyright of this drawing rests with JICA.

Designed by:
Japan International Cooperation
Agency (JICA)

JICA Study Team:
Joint Venture of
Pacific Consultants International and
Yamashita Seiki Inc.

Subcontracted Local Consultant:

Tel. 012377 - Fax. 012388 - JORDAN - JORDAN

Drawing Title:
CROSS-SECTION
7+560

Scale: H 1:400 V 1:200 **Drawing No.:** 329

NOTES :

- * FOR EXACT HEIGHTS AND DIMENSIONS OF BENCHES SEE TYPICAL ROAD CROSS-SECTION .
- * SLOPE H : V .

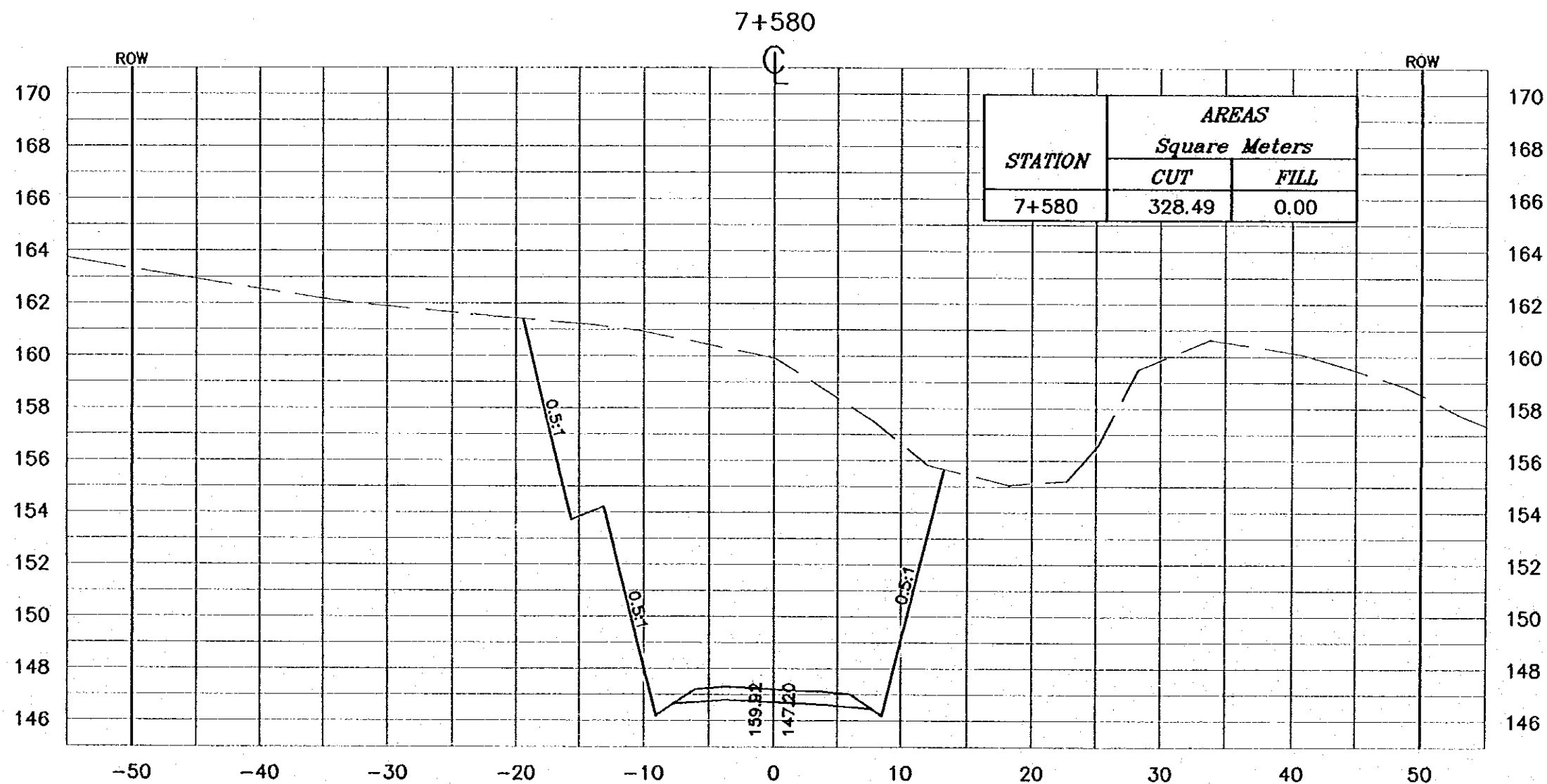

Project:
Tourism Sector Development Project
in the Hashemite Kingdom of Jordan

Executing Agency:
The Ministry of Tourism and Antiquities
The Ministry of Planning

SUB-PROJECT:
Dead Sea Parkway

Note:
This detailed design has been executed by
a team of consultants as shown below in
accordance with the agreement between
Japan International Cooperation Agency
(JICA) and JICA Study Team.
The copyright of this drawing rests with JICA.

Designed by:
Japan International Cooperation
Agency (JICA)

JICA Study Team:
Joint Venture of
Pacific Consultants International and
Yamashita Seidai Inc.

Subcontracted Local Consultant:
 consolidated consultants
engineering & environment
Tel: 4912277 - Fax: 4912798 - www.jica.com

Drawing Title:
CROSS-SECTION
7+580

Scale: H 1:400 V 1:200 **Drawing No.:** 330

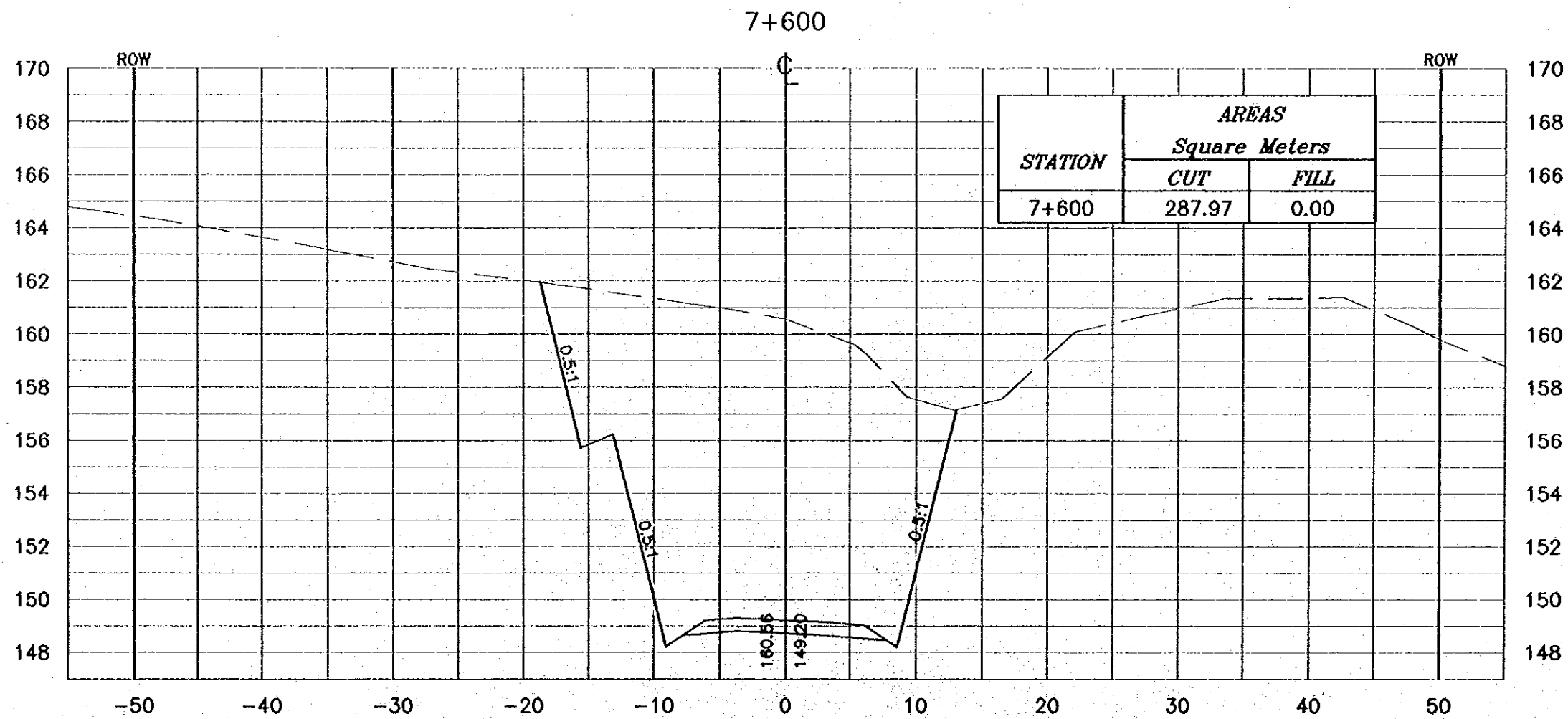
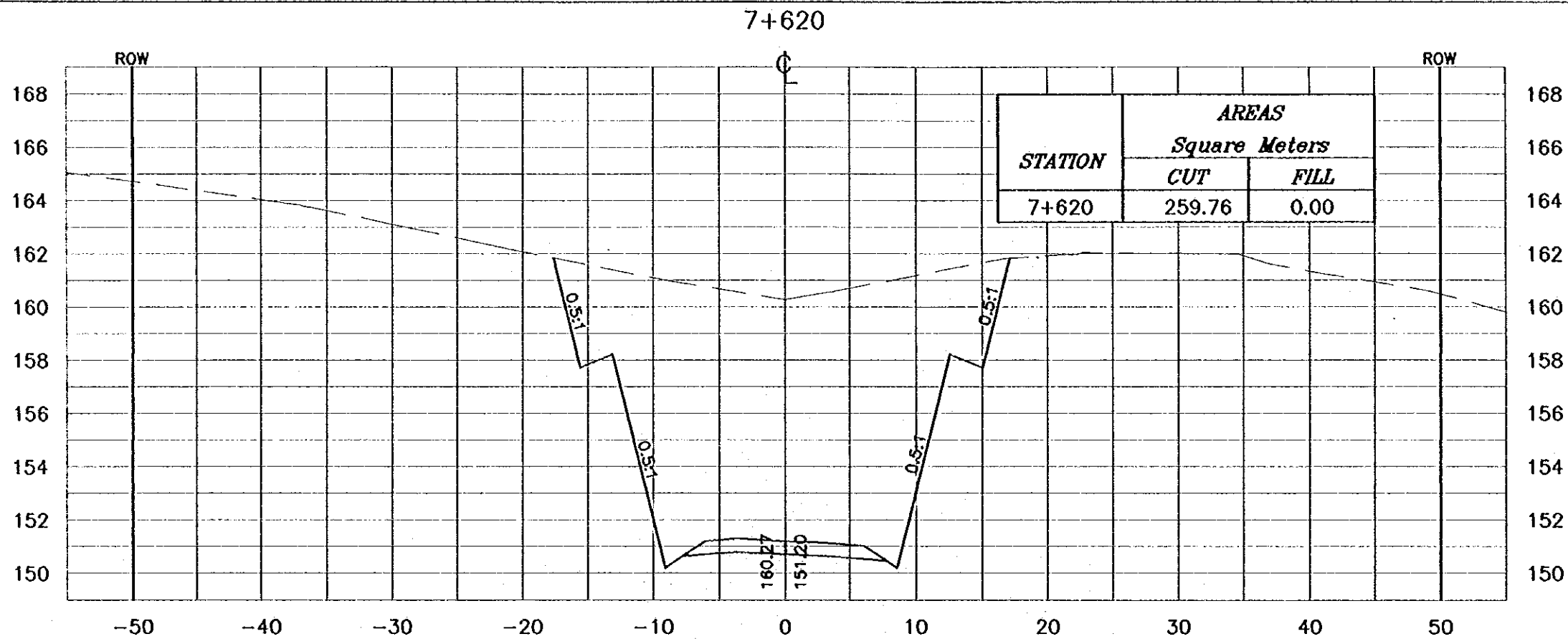

NOTES :

- * FOR EXACT HEIGHTS AND DIMENSIONS OF BENCHES SEE TYPICAL ROAD CROSS-SECTION .
- * SLOPE H : V .

Project:
Tourism Sector Development Project
in the Hashemite Kingdom of Jordan

Executing Agency:
The Ministry of Tourism and Antiquities
The Ministry of Planning

SUB-PROJECT:
Dead Sea Parkway

Note:
This detailed design has been executed by a team of consultants as shown below in accordance with the agreement between Japan International Cooperation Agency (JICA) and JICA Study Team. The copyright of this drawing rests with JICA.

Designed by:
Japan International Cooperation Agency (JICA)

JICA Study Team:
Joint Venture of Pacific Consultants International and Yamashita Sekkol Inc.

Subcontracted Local Consultant:
 consolidated consultants
engineering & environment
Tel: 4612377 - Fax: 4612368 - Amman - JORDAN

Drawing Title:
CROSS-SECTION
7+600/7+620

Scale: H 1:400 V 1:200 **Drawing No.:** 331

NOTES :

- * FOR EXACT HEIGHTS AND DIMENSIONS OF BENCHES SEE TYPICAL ROAD CROSS-SECTION .
- * SLOPE H : V .

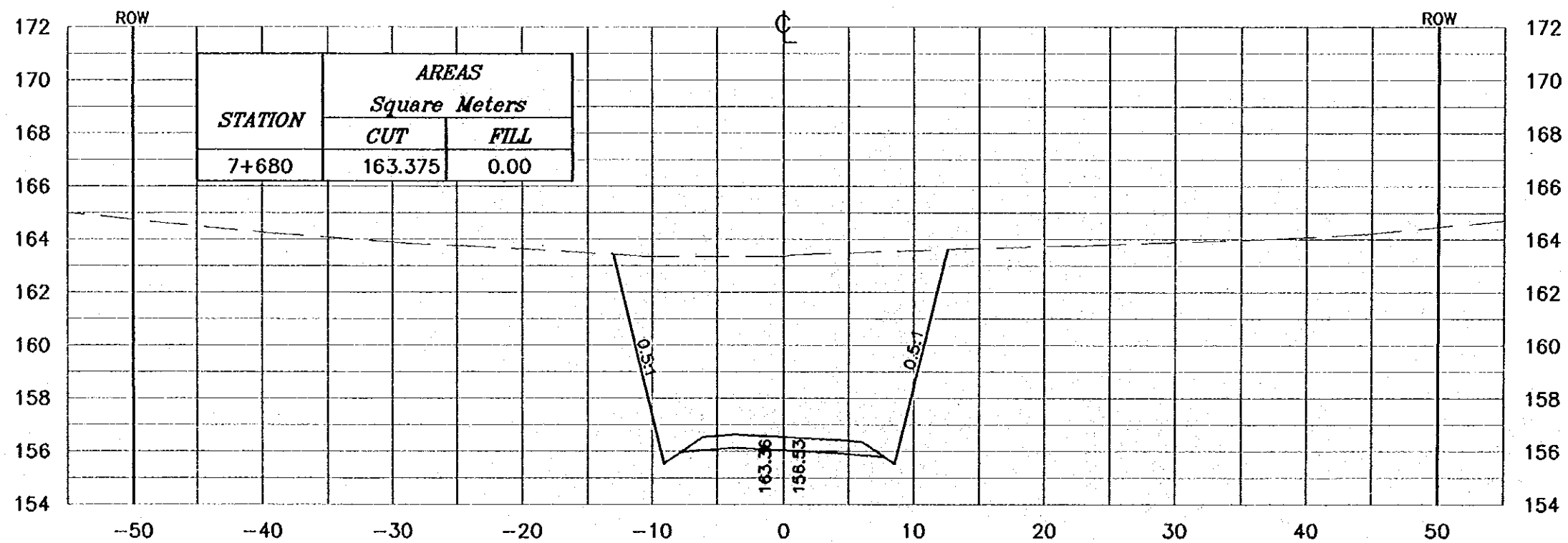
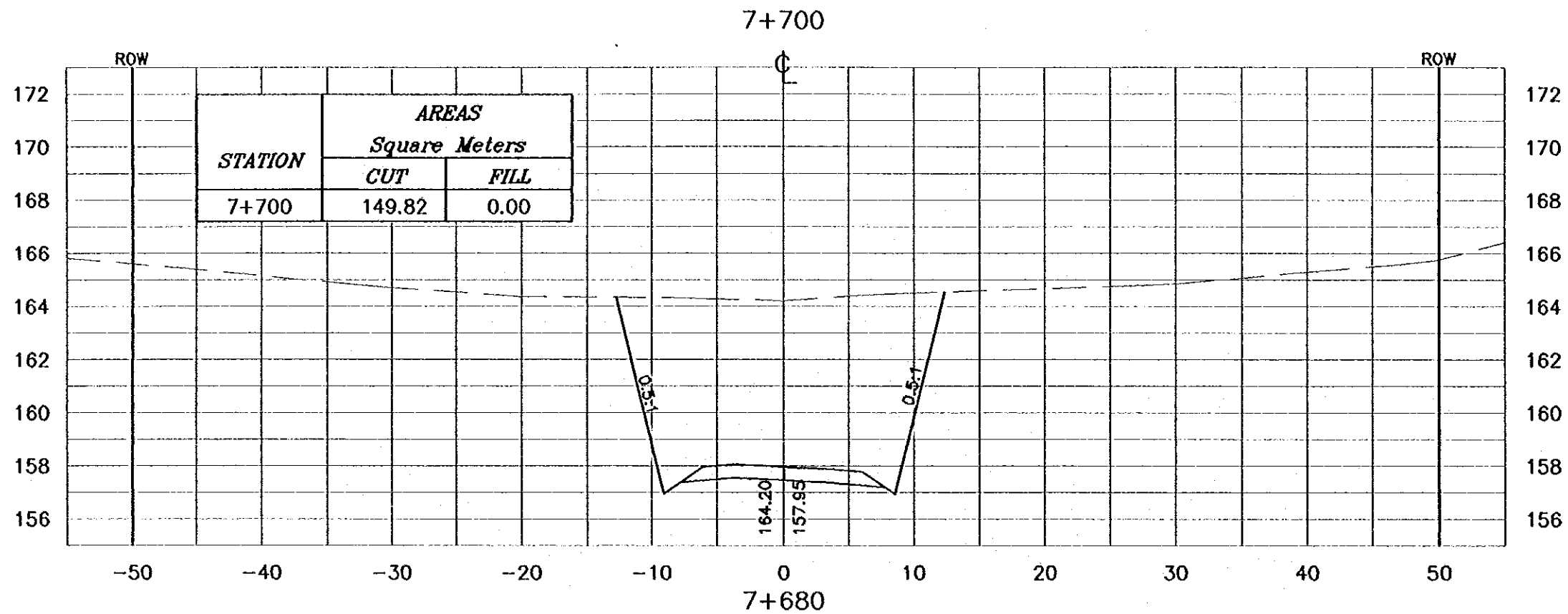

Project:
Tourism Sector Development Project
in the Hashemite Kingdom of Jordan

Executing Agency:
The Ministry of Tourism and Antiquities
The Ministry of Planning

SUB-PROJECT:
Dead Sea Parkway

Note:
This detailed design has been executed by a team of consultants as shown below in accordance with the agreement between Japan International Cooperation Agency (JICA) and JICA Study Team. The copyright of this drawing rests with JICA.

Designed by:
Japan International Cooperation Agency (JICA)

JICA Study Team:
Joint Venture of Pacific Consultants International and Yamashita Sekiul Inc.

Subcontracted Local Consultant:
 consolidated consultants
ENGINEERING & ENVIRONMENT
Tel: 012377 - Fax: 012388 - AMMAN - JORDAN

Drawing Title:
CROSS-SECTION
7+680/7+700

Scale: H 1:400 V 1:200 **Drawing No.:** 333

NOTES :

- * FOR EXACT HEIGHTS AND DIMENSIONS OF BENCHES SEE TYPICAL ROAD CROSS-SECTION .
- * SLOPE H : V .

7+740

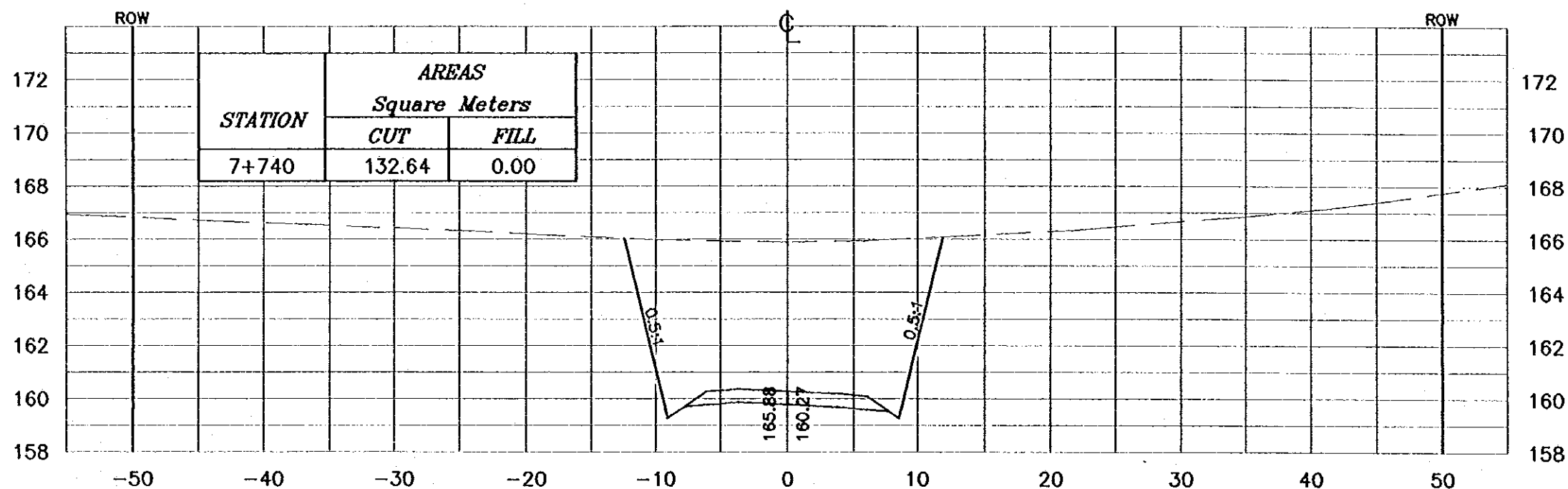

7+720

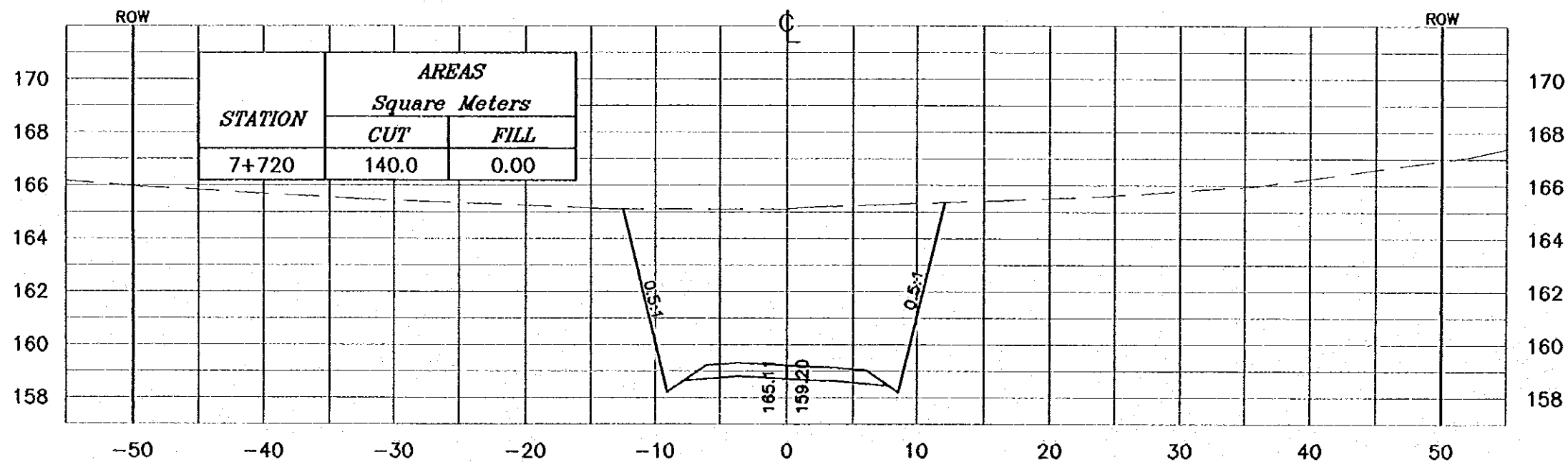

Project:
Tourism Sector Development Project
in the Hashemite Kingdom of Jordan

Escalating Agency:
The Ministry of Tourism and Antiquities
The Ministry of Planning

SUB-PROJECT:
Dead Sea Parkway

Note:
This detailed design has been executed by
a team of consultants as shown below in
accordance with the agreement between
Japan International Cooperation Agency
(JICA) and JICA Study Team.
The copyright of this drawing rests with JICA.

Designed by:
Japan International Cooperation
Agency (JICA)

JICA Study Team:
Joint Venture of
Pacific Consultants International and
Yamashita Seki Inc.

Subcontracted Local Consultant:
consolidated consultants
engineering & environment
Tel: 962277 - Fax: 962288 - 78991 - 20201

Drawing Title:
CROSS-SECTION
7+720/7+740

Scale: H 1:400 V 1:200 **Drawing No.:** 334

NOTES :

- * FOR EXACT HEIGHTS AND DIMENSIONS OF BENCHES SEE TYPICAL ROAD CROSS-SECTION .
- * SLOPE H : V .

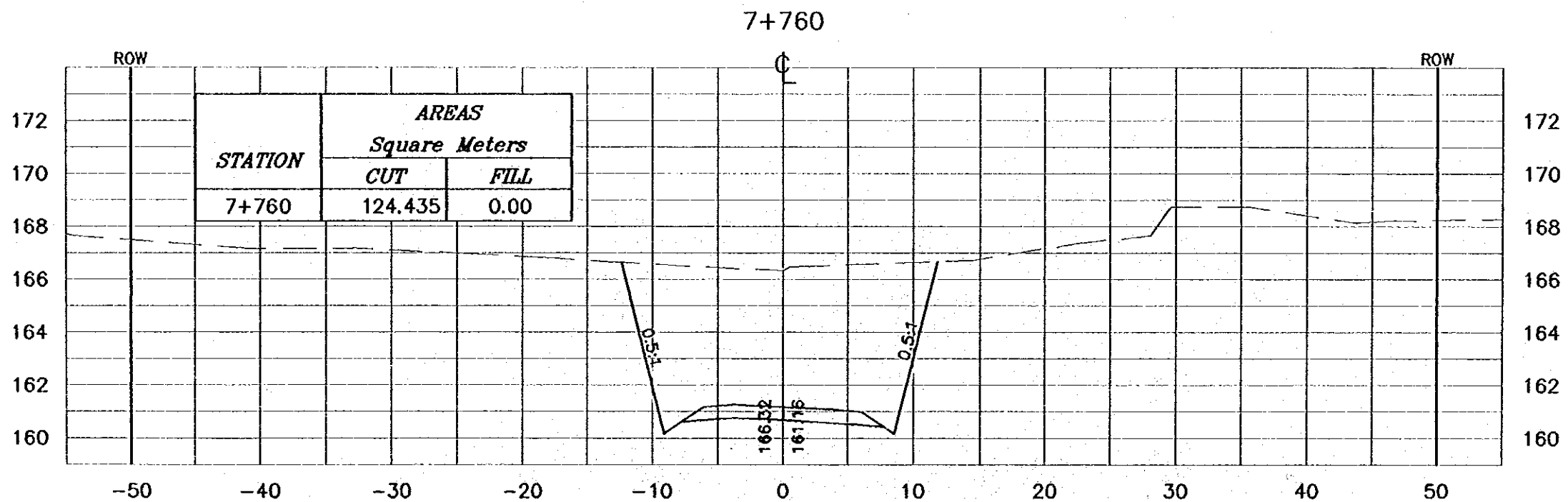
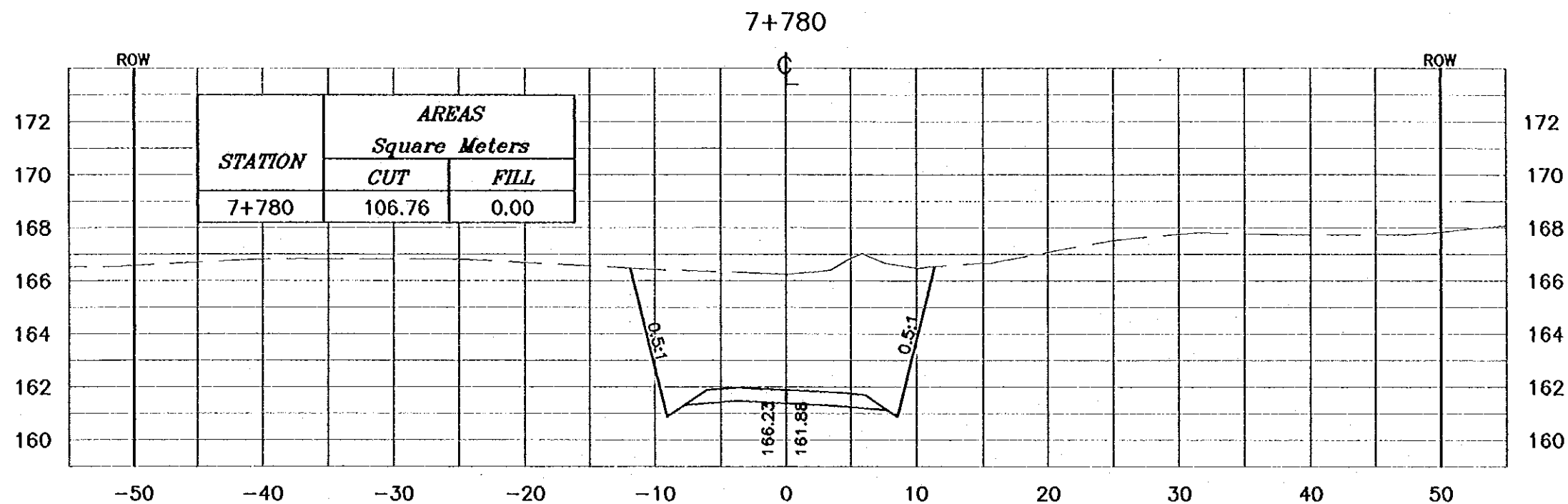

Project:
Tourism Sector Development Project
in the Hashemite Kingdom of Jordan

Executing Agency:
The Ministry of Tourism and Antiquities
The Ministry of Planning

SUB-PROJECT:
Dead Sea Parkway

Note:
This detailed design has been executed by
a team of consultants as shown below in
accordance with the agreement between
Japan International Cooperation Agency
(JICA) and JICA Study Team.
The copyright of this drawing rests with JICA.

Designed by:
Japan International Cooperation
Agency (JICA)

JICA Study Team:
Joint Venture of
Pacific Consultants International and
Yamashita Sekitai Inc.

Subcontracted Local Consultant:
 consolidated consultants
engineering & environment
Tel: 0512377 - Fax: 0512388 - AMMAN - JORDAN

Drawing Title:
CROSS-SECTION
7+760/7+780

Scale: H 1:400 V 1:200 **Drawing No.:** 335

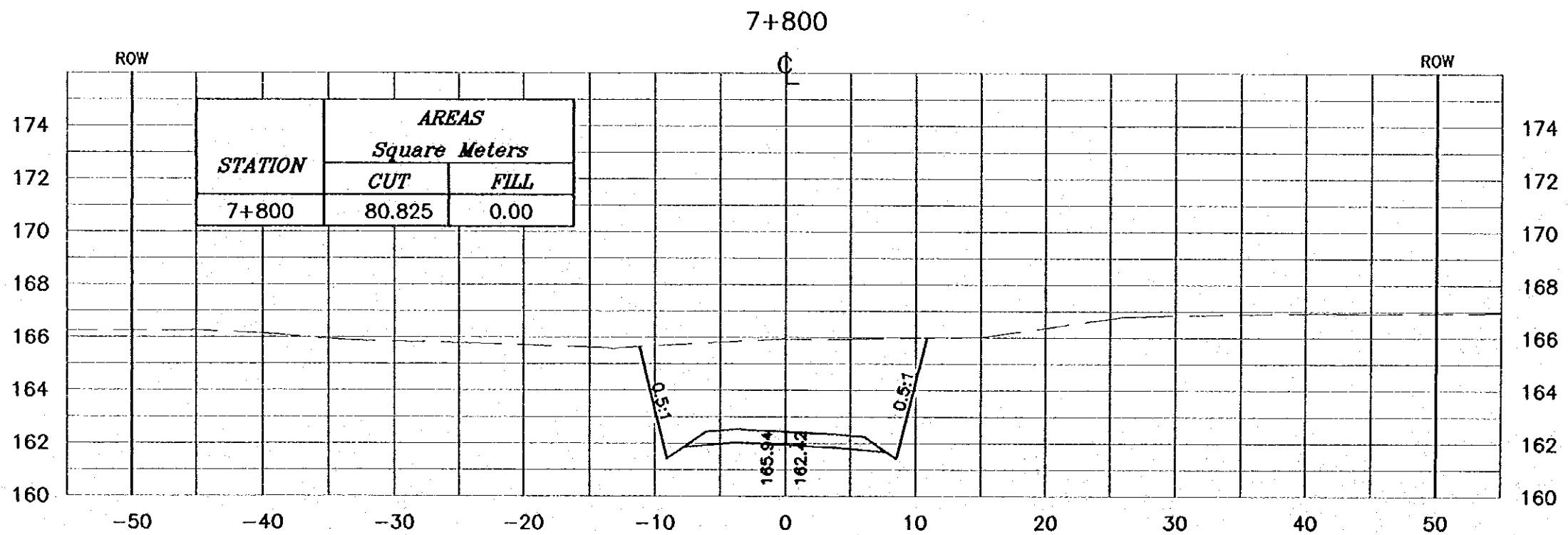
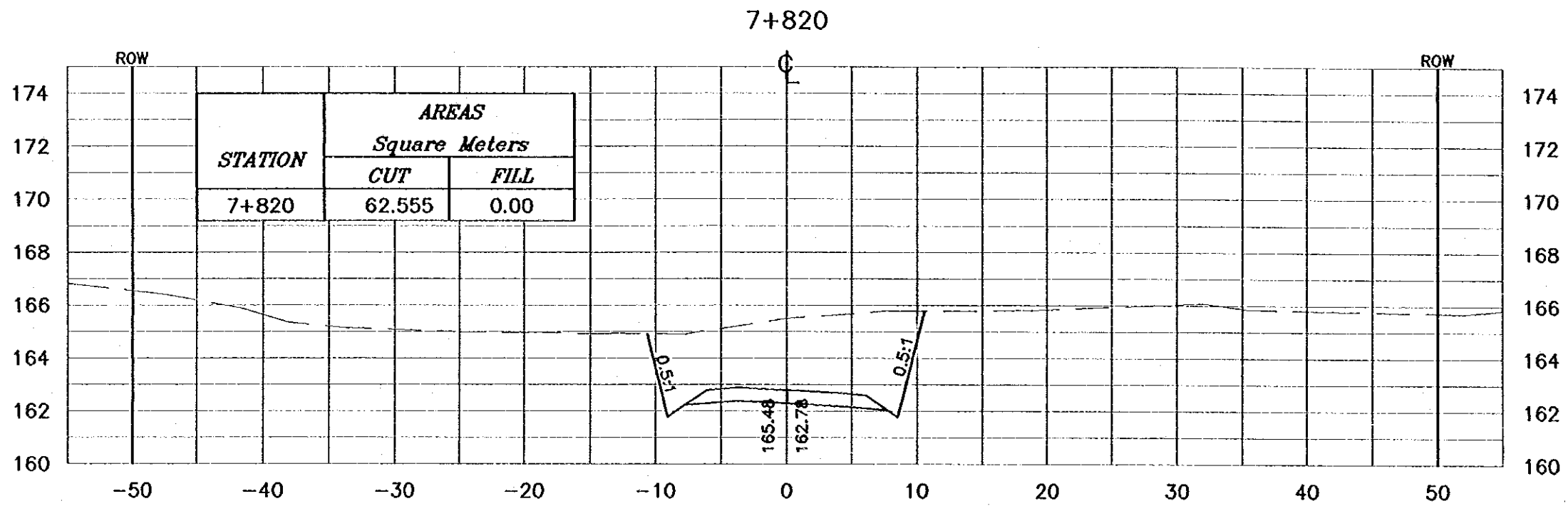

NOTES :

- * FOR EXACT HEIGHTS AND DIMENSIONS OF BENCHES SEE TYPICAL ROAD CROSS-SECTION .
- * SLOPE H : V .

Project:
Tourism Sector Development Project
in the Hashemite Kingdom of Jordan

Executing Agency:
The Ministry of Tourism and Antiquities
The Ministry of Planning

SUB-PROJECT:
Dead Sea Parkway

Note:
This detailed design has been executed by a team of consultants as shown below in accordance with the agreement between Japan International Cooperation Agency (JICA) and JICA Study Team. The copyright of this drawing rests with JICA.

Designed by:
Japan International Cooperation Agency (JICA)

JICA Study Team:
Joint Venture of Pacific Consultants International and Yamashita Sekitai Inc.

Subcontracted Local Consultant:
 consolidated consultants
engineering & environment
Tel: 492277 - Fax: 492288 - Amman - Jordan

Drawing Title:
CROSS-SECTION
7+800/7+820

Scale: H 1:400 V 1:200 **Drawing No.:** 336

NOTES :

- * FOR EXACT HEIGHTS AND DIMENSIONS OF BENCHES SEE TYPICAL ROAD CROSS-SECTION .
- * SLOPE H : V .

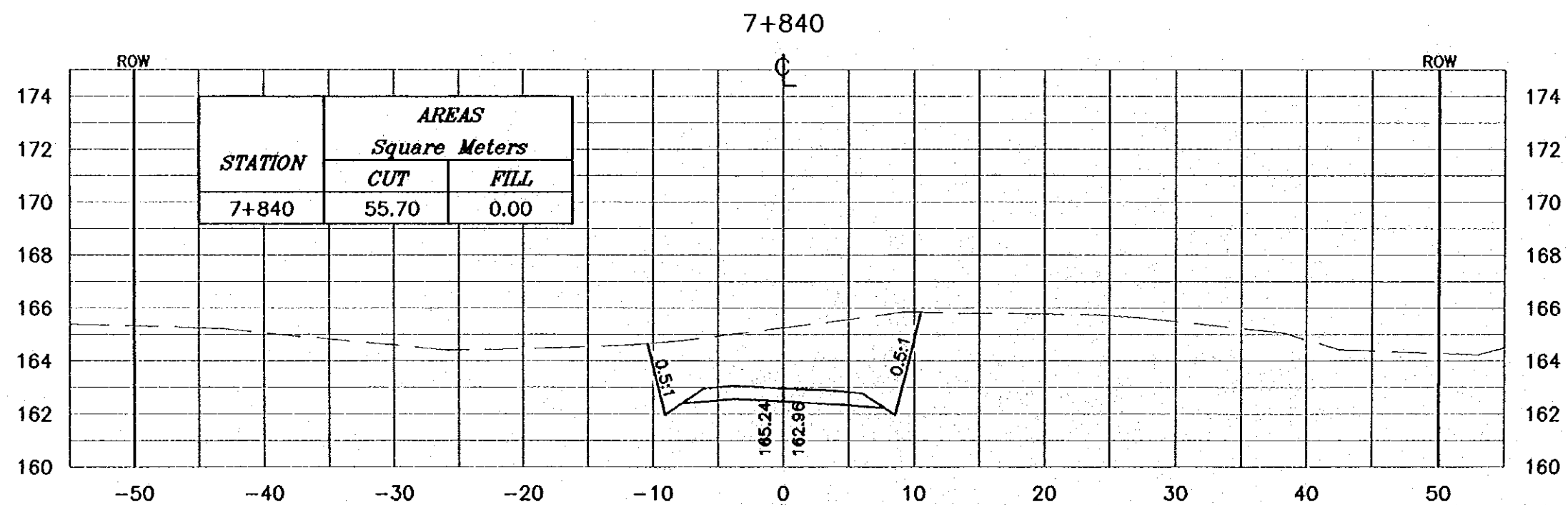
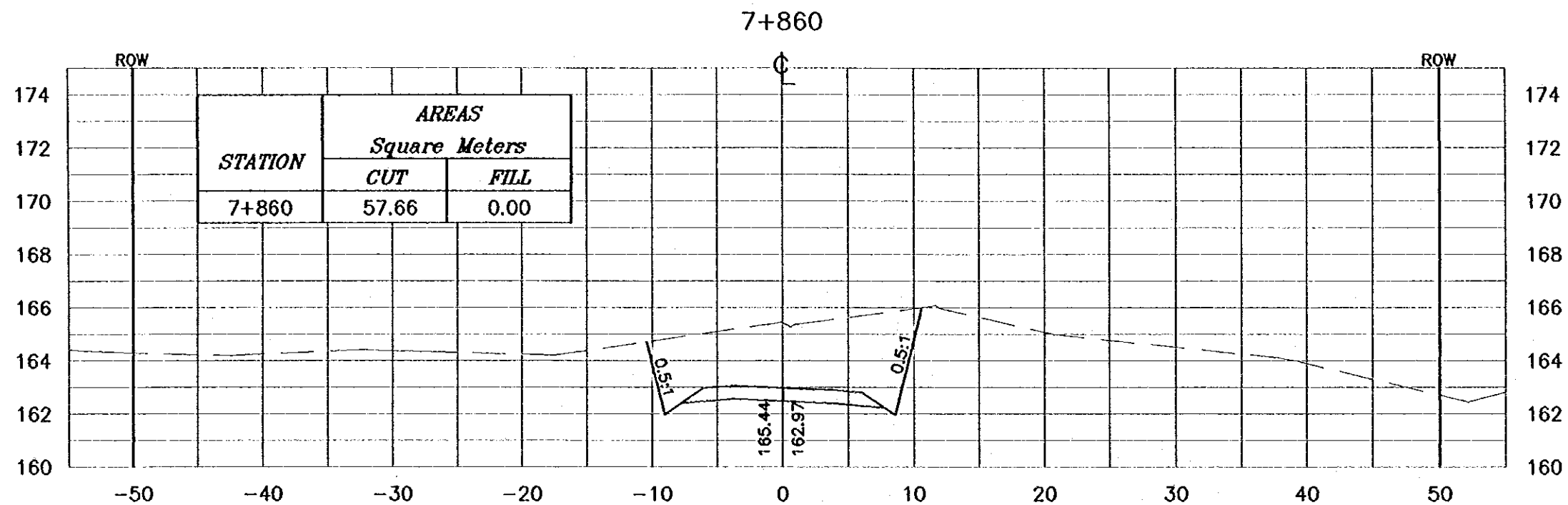

Project:
Tourism Sector Development Project
in the Hashemite Kingdom of Jordan

Executing Agency:
The Ministry of Tourism and Antiquities
The Ministry of Planning

SUB-PROJECT:
Dead Sea Parkway

Note:
This detailed design has been executed by a team of consultants as shown below in accordance with the agreement between Japan International Cooperation Agency (JICA) and JICA Study Team. The copyright of this drawing rests with JICA.

Designed by:
Japan International Cooperation Agency (JICA)

JICA Study Team:
Joint Venture of Pacific Consultants International and Yamashita Seki Inc.

Subcontracted Local Consultant:
 consolidated consultants
engineering & environment
Tel: 9612277 - Fax: 9612288 - AMMAN - JORDAN

Drawing Title:
CROSS-SECTION
7+840/7+860

Scale: H 1:400 V 1:200 **Drawing No.:** 337

NOTES :

- * FOR EXACT HEIGHTS AND DIMENSIONS OF BENCHES SEE TYPICAL ROAD CROSS-SECTION .
- * SLOPE H : V .

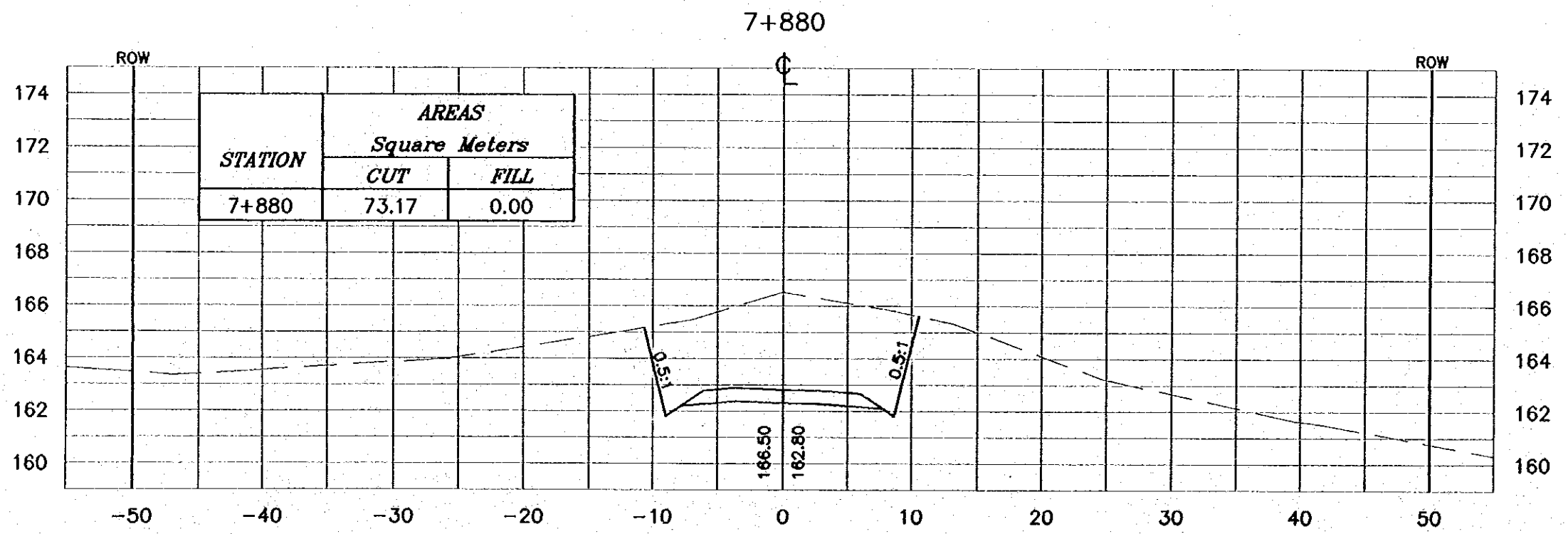
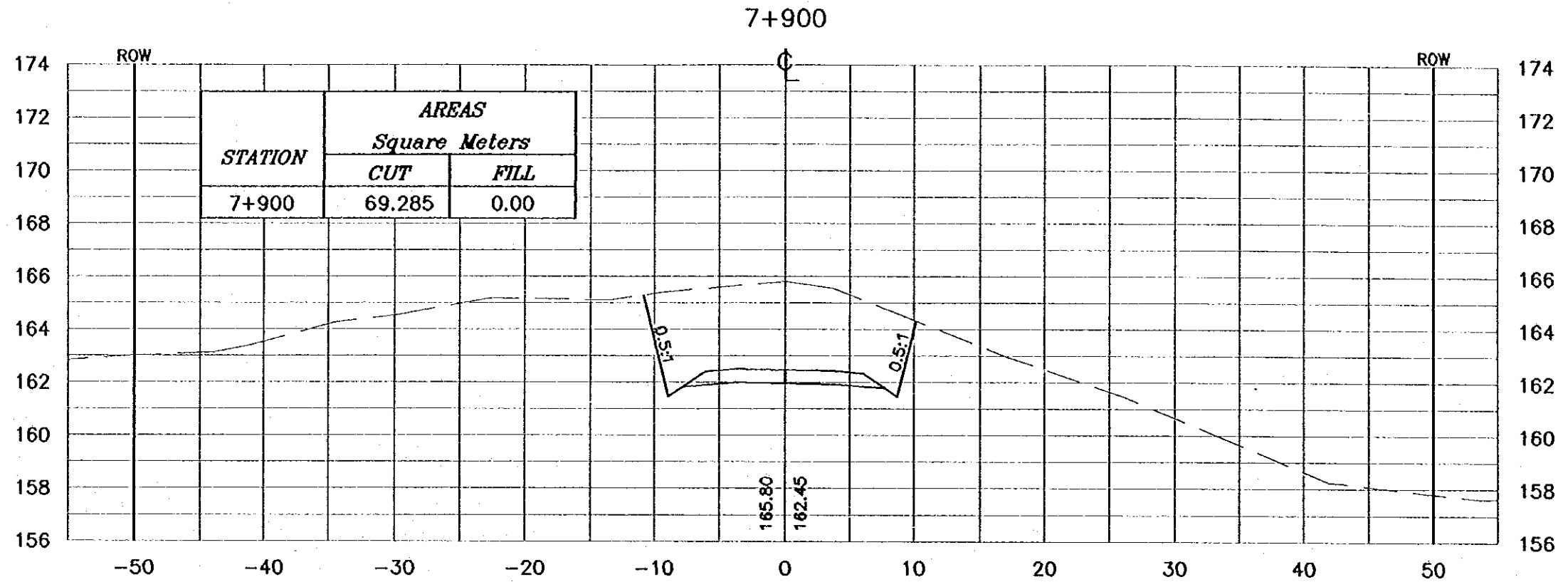

Project:
Tourism Sector Development Project
in the Hashemite Kingdom of Jordan

Executing Agency:
The Ministry of Tourism and Antiquities
The Ministry of Planning

SUB-PROJECT:
Dead Sea Parkway

Note:
This detailed design has been executed by a team of consultants as shown below in accordance with the agreement between Japan International Cooperation Agency (JICA) and JICA Study Team. The copyright of this drawing rests with JICA.

Designed by:
Japan International Cooperation Agency (JICA)

JICA Study Team:
Joint Venture of
Pacific Consultants International and
Yamashita Sekizai Inc.

Subcontracted Local Consultant:

consolidated consultants
engineering & environment
14 412277 - Fax: 412288 - Amman - JORDAN

Drawing Title:
CROSS-SECTION
7+880/7+900

Scale: H 1:400 V 1:200 Drawing No.: 338

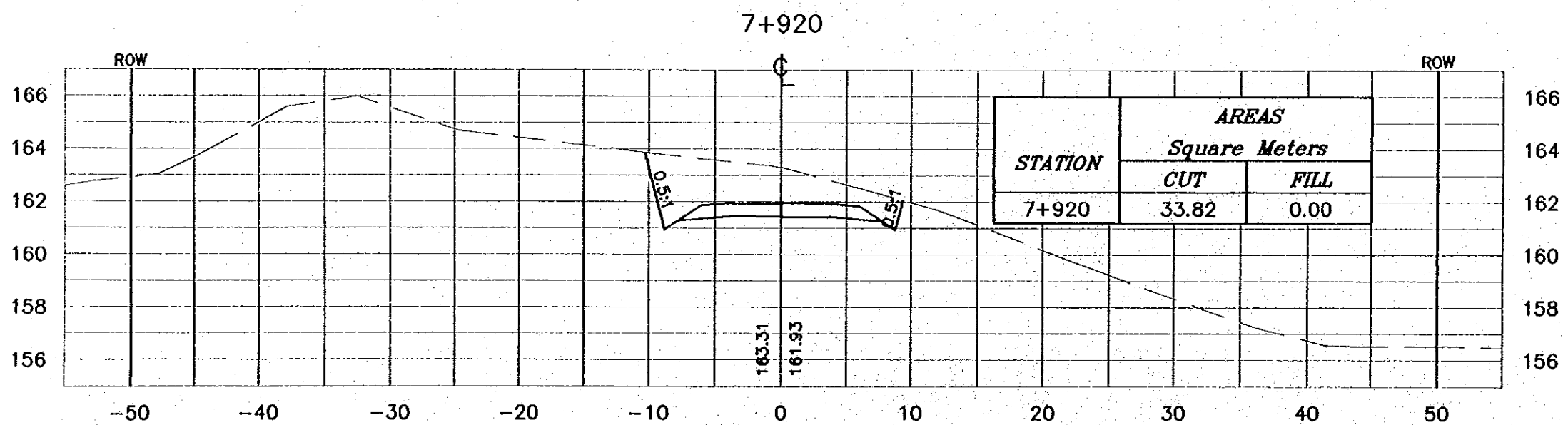
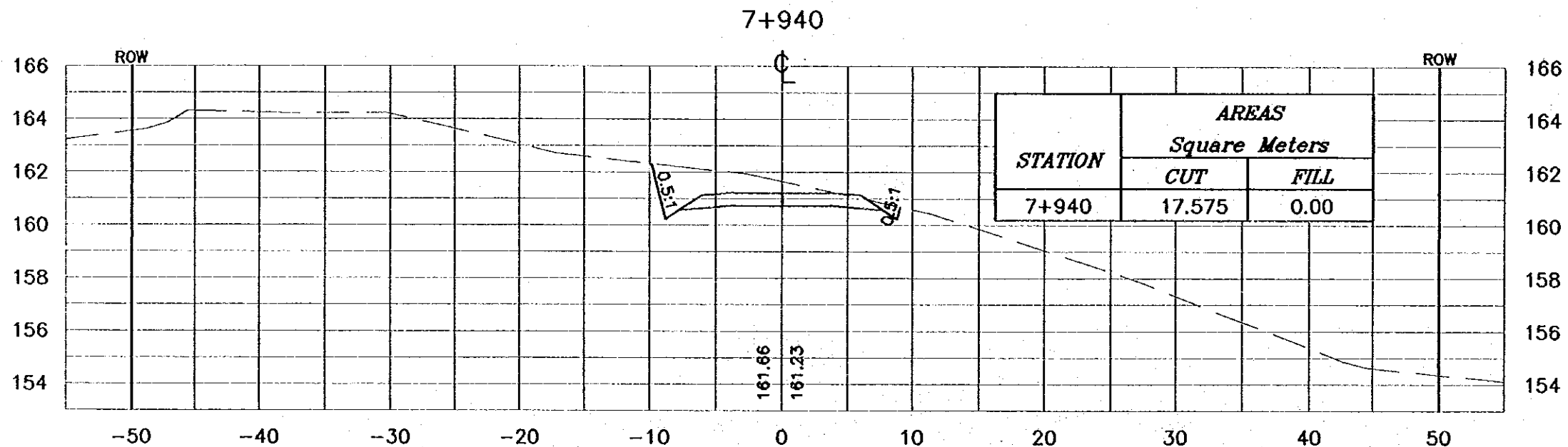
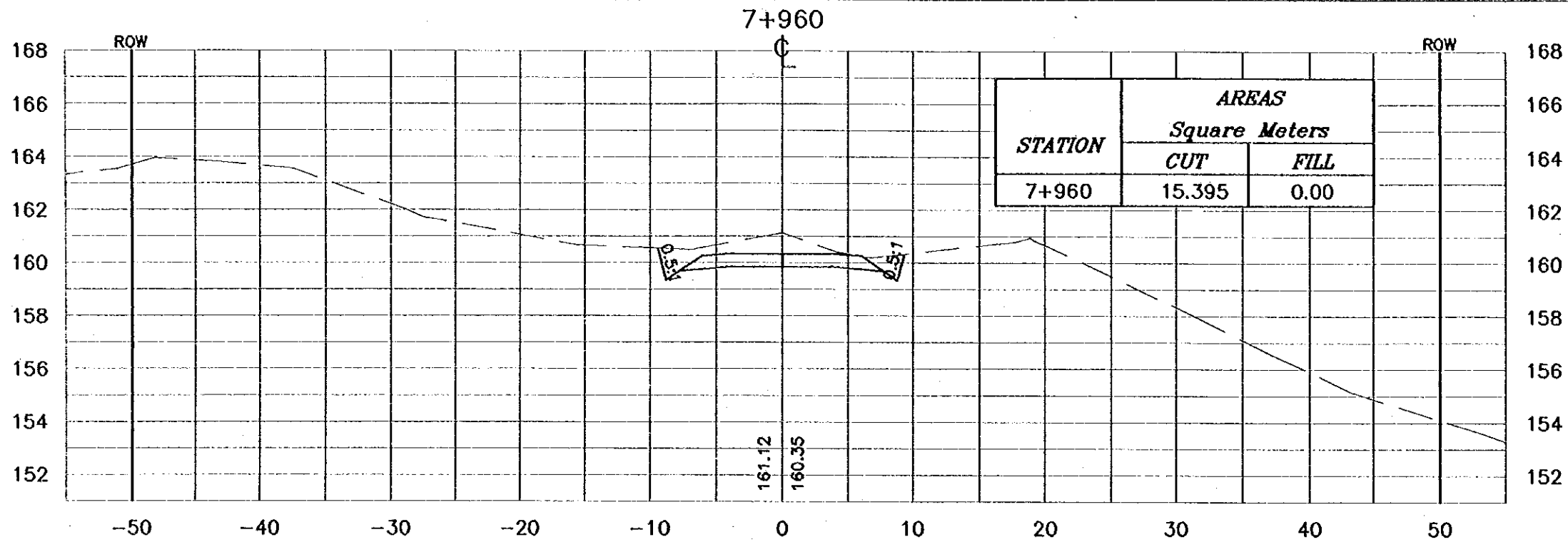

NOTES :

- * FOR EXACT HEIGHTS AND DIMENSIONS OF BENCHES SEE TYPICAL ROAD CROSS-SECTION .
- * SLOPE H : V .

Project:
Tourism Sector Development Project
in the Hashemite Kingdom of Jordan

Executing Agency:
The Ministry of Tourism and Antiquities
The Ministry of Planning

SUB-PROJECT:
Dead Sea Parkway

Note:
This detailed design has been executed by
a team of consultants as shown below in
accordance with the agreement between
Japan International Cooperation Agency
(JICA) and JICA Study Team.
The copyright of this drawing rests with JICA.

Designed by:
Japan International Cooperation
Agency (JICA)

JICA Study Team:
Joint Venture of
Pacific Consultants International and
Yamashita Sekido Inc.

Subcontracted Local Consultant:
consolidated consultants
ENGINEERING & ENVIRONMENT
Tel: 961277 - Fax: 961289 - Amman - Jordan

Drawing Title:
CROSS-SECTION
7+920/7+940/7+960

Scale: H 1:400 Drawing No.: 339
V 1:200

NOTES :

- * FOR EXACT HEIGHTS AND DIMENSIONS OF BENCHES SEE TYPICAL ROAD CROSS-SECTION .
- * SLOPE H : V .

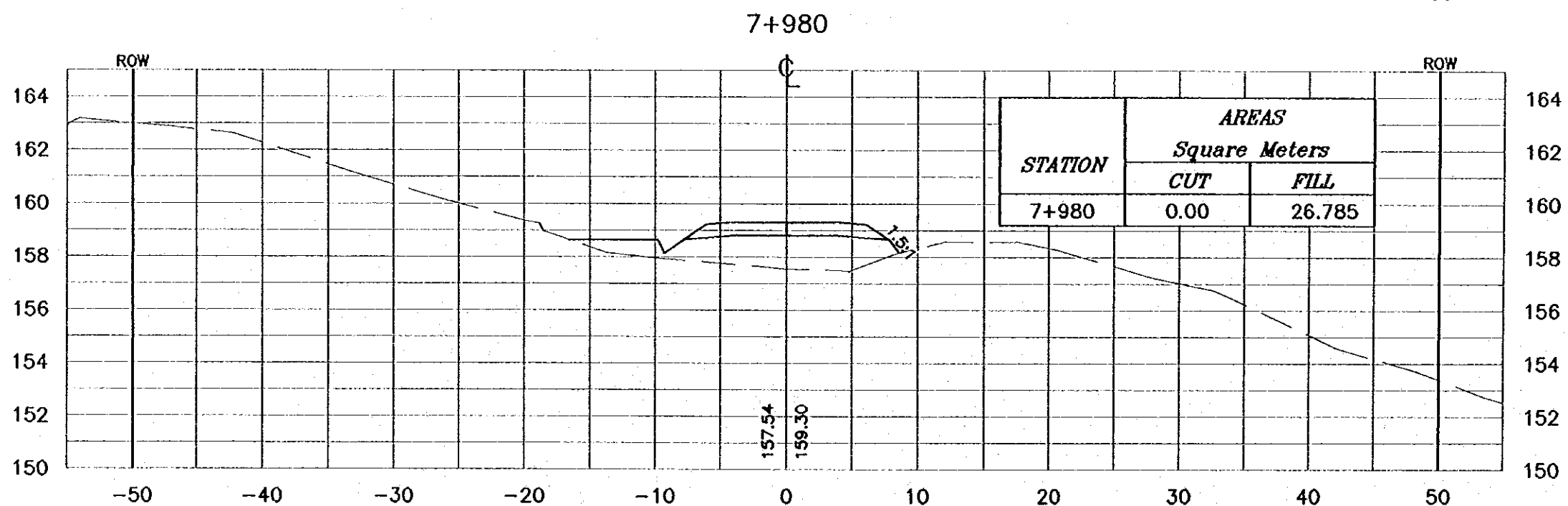
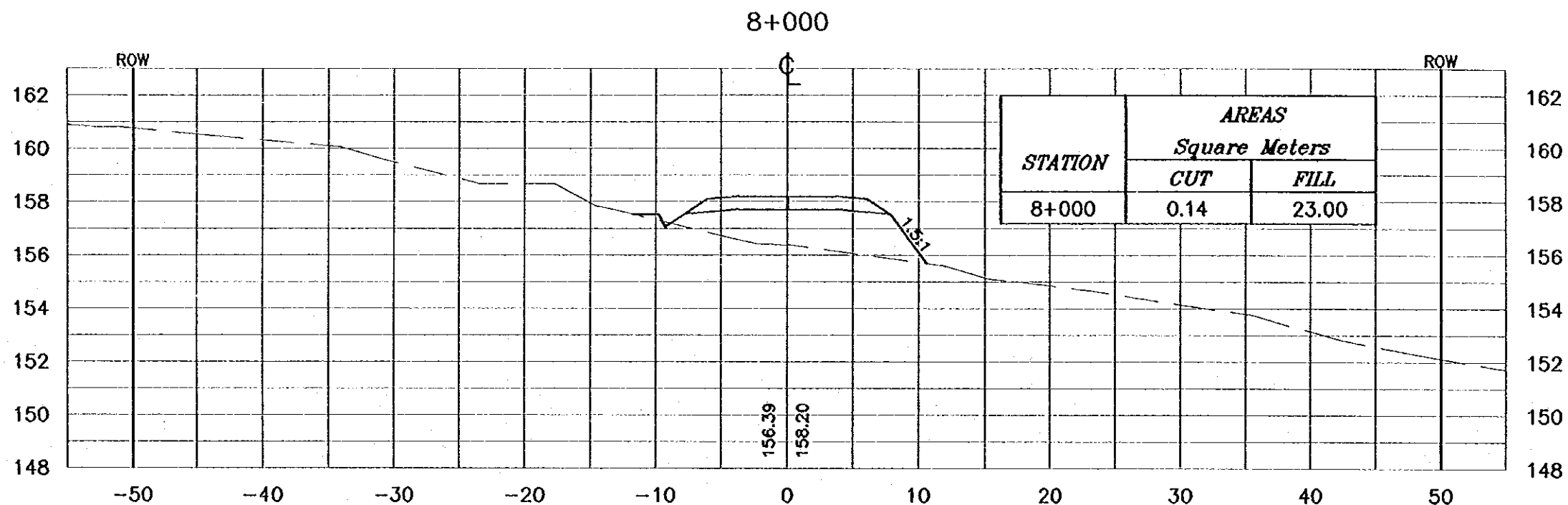

Project:
Tourism Sector Development Project
in the Hashemite Kingdom of Jordan

Executing Agency:
The Ministry of Tourism and Antiquities
The Ministry of Planning

SUB-PROJECT:
Dead Sea Parkway

Note:
This detailed design has been executed by
a team of consultants as shown below in
accordance with the agreement between
Japan International Cooperation Agency
(JICA) and JICA Study Team.
The copyright of this drawing rests with JICA.

Designed by:
Japan International Cooperation
Agency (JICA)

JICA Study Team:
Joint Venture of
Pacific Consultants International and
Yamashita Seikoh Inc.

Subcontracted Local Consultant:
 consolidated consultants
engineering & architecture
P.O. Box 1277 - Fax: 9952388 - Amman - Jordan

Drawing Title:
CROSS-SECTION
7+980/8+000

Scale: H 1:400 V 1:200 **Drawing No.:** 340

JICA