

NOTES :

- * FOR EXACT HEIGHTS AND DIMENSIONS OF BENCHES SEE TYPICAL ROAD CROSS-SECTION .
- * SLOPE H : V .

Project:
Tourism Sector Development Project
in the Hashemite Kingdom of Jordan

Executing Agency:
The Ministry of Tourism and Antiquities
The Ministry of Planning

SUB-PROJECT:
Dead Sea Parkway

Note:
This detailed design has been executed by a team of consultants as shown below in accordance with the agreement between Japan International Cooperation Agency (JICA) and JICA Study Team. The copyright of this drawing rests with JICA.

Designed by:
Japan International Cooperation Agency (JICA)

JICA Study Team:
Joint Venture of
Pacific Consultants International and
Yamashita Sato Inc.

Subcontracted Local Consultant:
 consolidated consultants
engineering & environment
Tel. 0112277 - Fax 0112288 - Amman - Jordan

Drawing Title:
CROSS-SECTION
5+620/5+640

Scale: 1:400
1:200

Drawing No.: 269

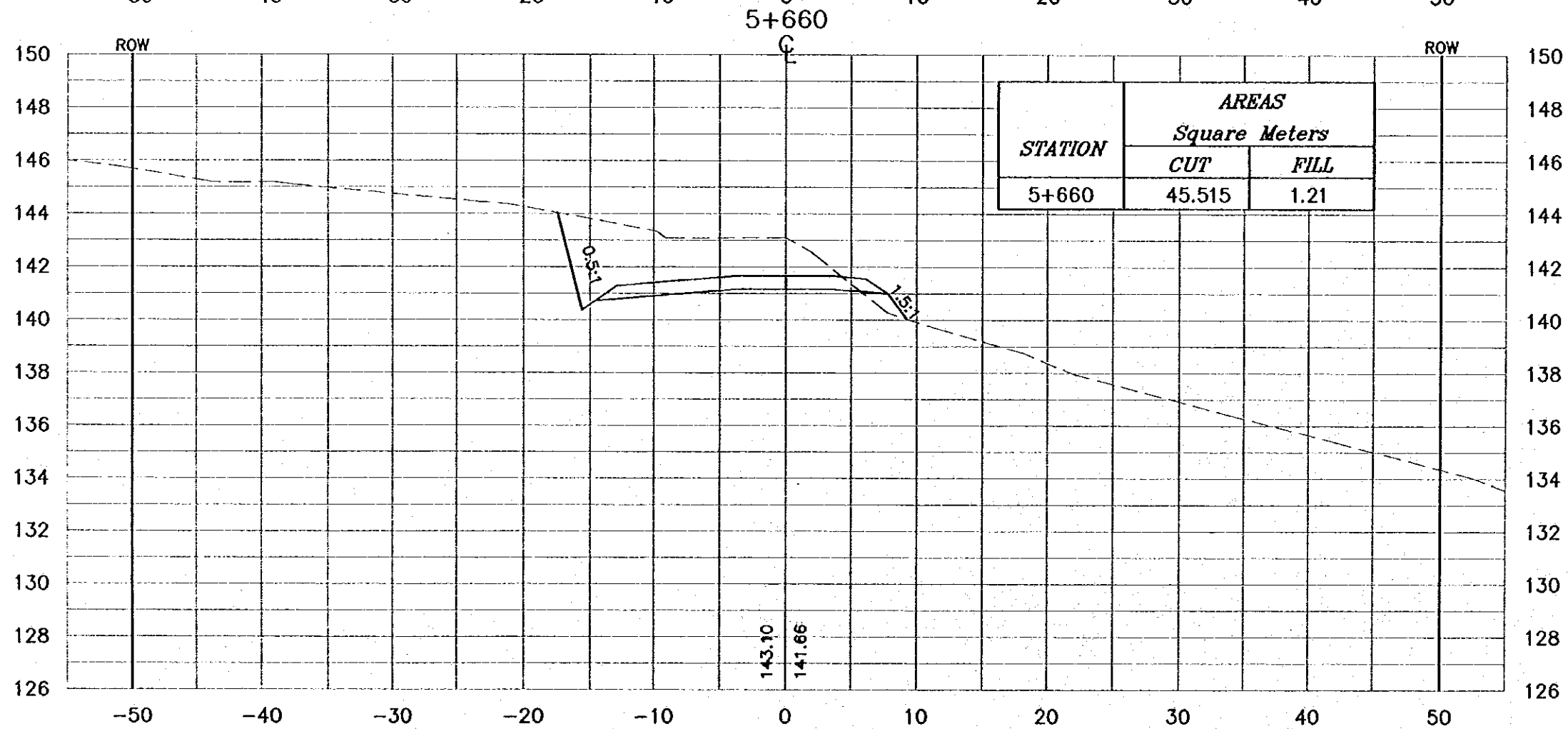
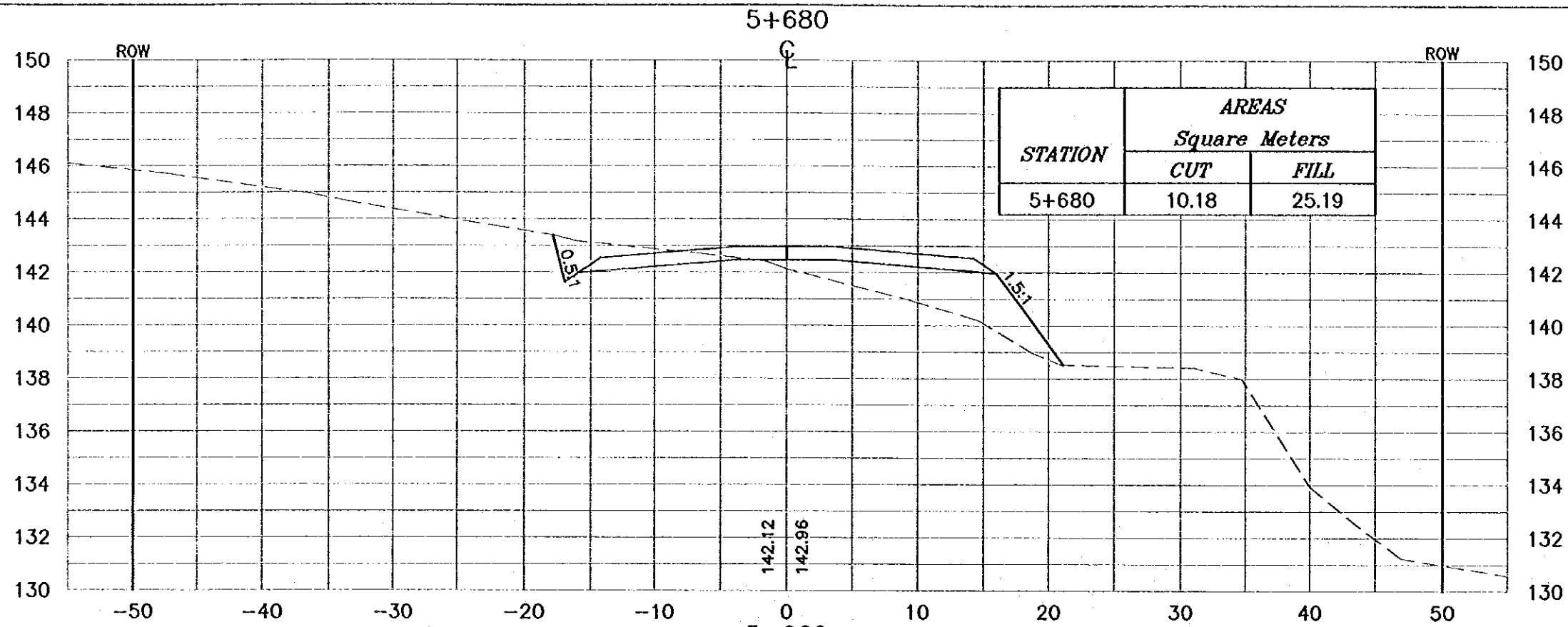

NOTES :

- * FOR EXACT HEIGHTS AND DIMENSIONS OF BENCHES SEE TYPICAL ROAD CROSS-SECTION .
- * SLOPE H : V .

Project:
Tourism Sector Development Project
in the Hashemite Kingdom of Jordan

Executing Agency:
The Ministry of Tourism and Antiquities
The Ministry of Planning

SUB-PROJECT:
Dead Sea Parkway

Note:
This detailed design has been executed by a team of consultants as shown below in accordance with the agreement between Japan International Cooperation Agency (JICA) and JICA Study Team. The copyright of this drawing rests with JICA.

Designed by:
Japan International Cooperation Agency (JICA)

JICA Study Team:
Joint Venture of Pacific Consultants International and Yamaoka Seidoh Inc.

Subcontracted Local Consultant:
 consolidated consultants
engineering & environment
Tel: 0112377 - Fax: 0112380 - AMM - JORDAN

Drawing Title:
CROSS-SECTION
5+560/5+580

Scale: H 1:400 **Drawing No.:** 270
V 1:200

NOTES :

- * FOR EXACT HEIGHTS AND DIMENSIONS OF BENCHES SEE TYPICAL ROAD CROSS-SECTION .
- * SLOPE H : V .

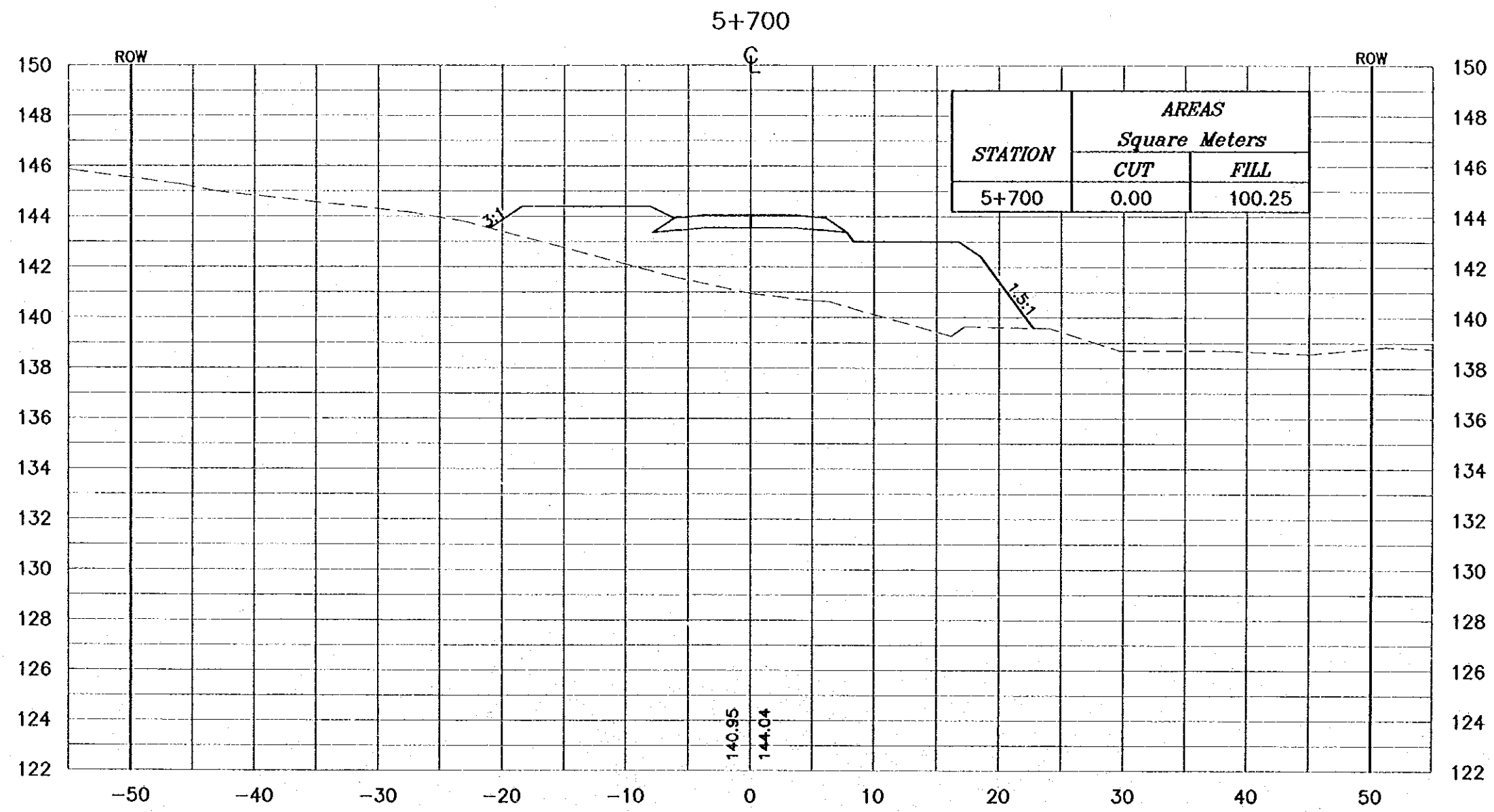

Project:
Tourism Sector Development Project
in the Hashemite Kingdom of Jordan

Executing Agency:
The Ministry of Tourism and Antiquities
The Ministry of Planning

SUB-PROJECT:
Dead Sea Parkway

Note:
This detailed design has been executed by
a team of consultants as shown below in
accordance with the agreement between
Japan International Cooperation Agency
(JICA) and JICA Study Team.
The copyright of this drawing rests with JICA.

Designed by:
Japan International Cooperation
Agency (JICA)

JICA Study Team:
Joint Venture of
Pacific Consultants International and
Yamashita Seki & Co. Inc.

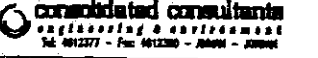
Subcontracted Local Consultant:

consolidated consultants
INCORPORATED IN JAPAN
TEL. 03-3277-1111 - FAX 03-3277-1111

Drawing Title:
CROSS-SECTION
5+700

Scale:
H 1:400
V 1:200

Drawing No.: 271

NOTES :

- * FOR EXACT HEIGHTS AND DIMENSIONS OF BENCHES SEE TYPICAL ROAD CROSS-SECTION .
- * SLOPE H : V .

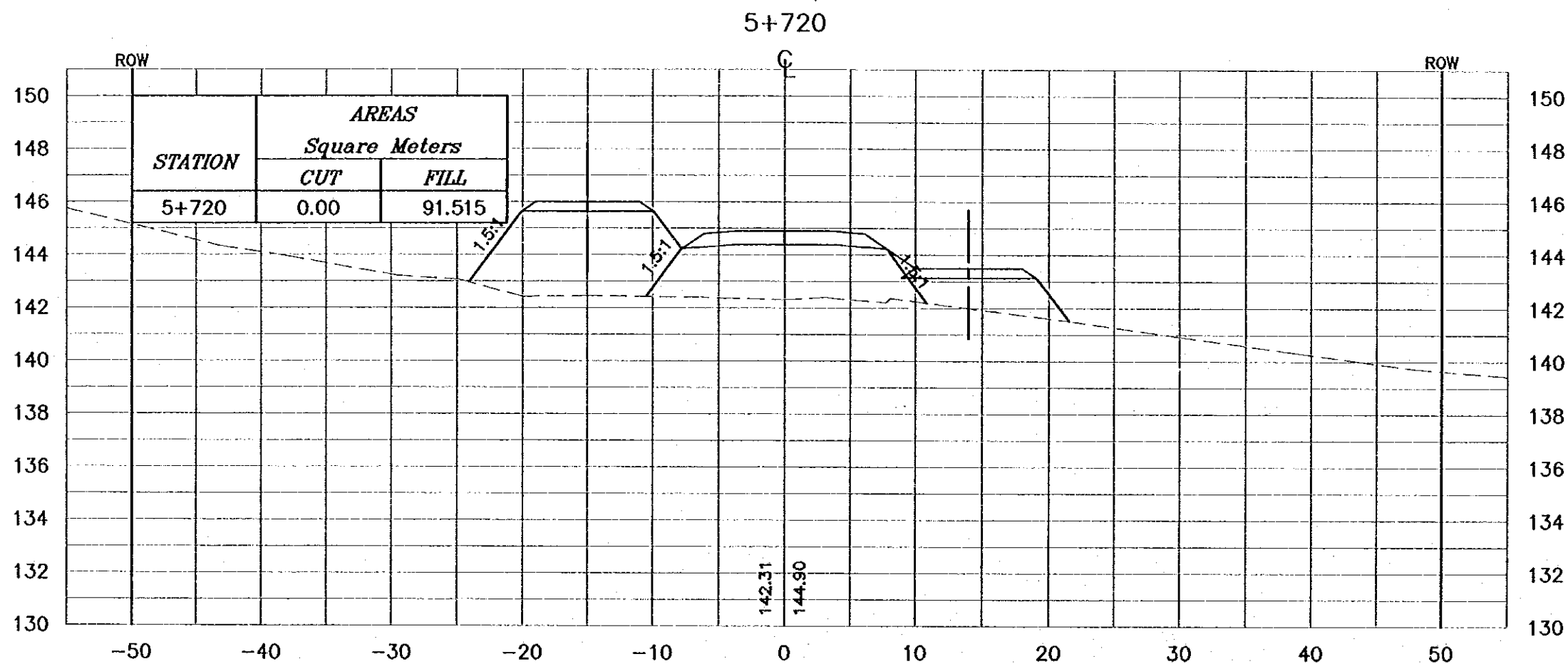

Project:
Tourism Sector Development Project
in the Hashemite Kingdom of Jordan

Escalling Agency:
The Ministry of Tourism and Antiquities
The Ministry of Planning

SUB-PROJECT:
Dead Sea Parkway

Note:
This detailed design has been executed by
a team of consultants as shown below in
accordance with the agreement between
Japan International Cooperation Agency
(JICA) and JICA Study Team.
The copyright of this drawing rests with JICA.

Designed by:
Japan International Cooperation
Agency (JICA)

JICA Study Team:
Joint Venture of
Pacific Consultants International and
Yamashita Sekitai Inc.

Subcontracted Local Consultant:

consolidated consultants
engineering & environment
Tel: 0112277 - Fax: 0112288 - AMMAN - JORDAN

Drawing Title:
CROSS-SECTION
5+720

Scale:
H 1:400
V 1:200

Drawing No.: 272

NOTES :

- * FOR EXACT HEIGHTS AND DIMENSIONS OF BENCHES SEE TYPICAL ROAD CROSS-SECTION .
- * SLOPE H : V .

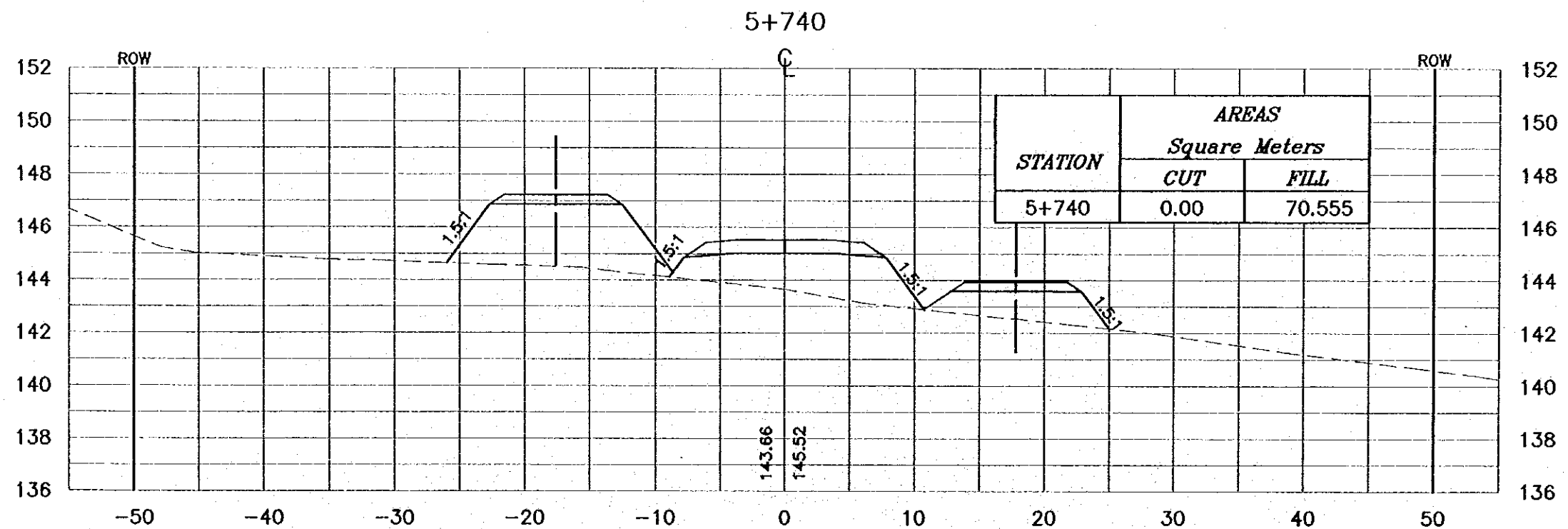
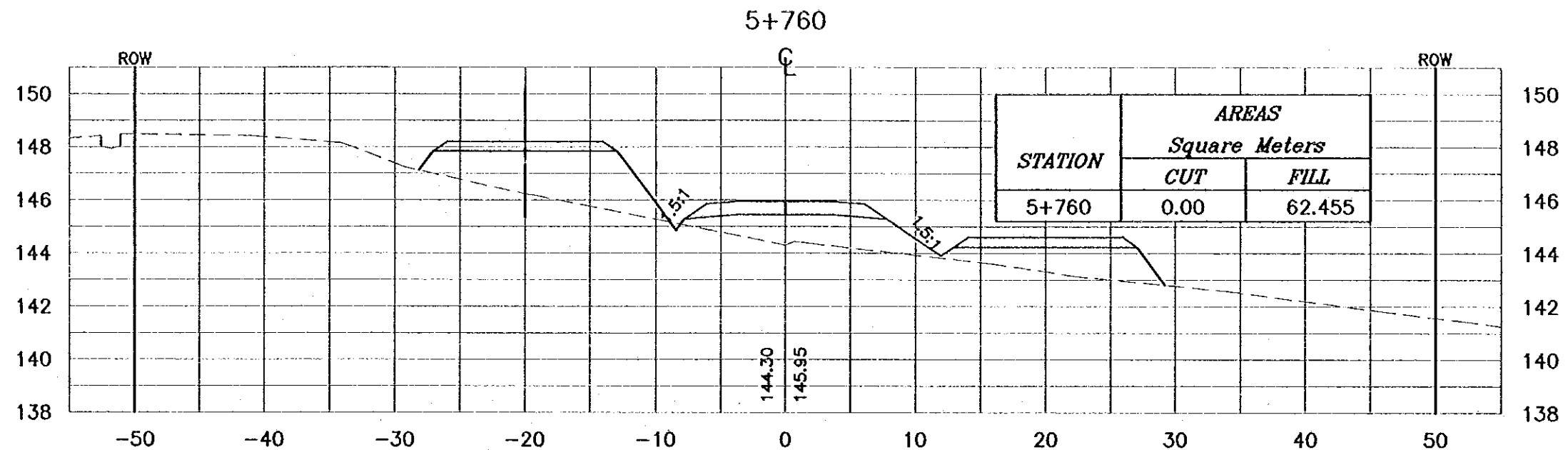

Project:
Tourism Sector Development Project
in the Hashemite Kingdom of Jordan

Executing Agency:
The Ministry of Tourism and Antiquities
The Ministry of Planning

SUB-PROJECT:
Dead Sea Parkway

Note:
This detailed design has been executed by
a team of consultants as shown below in
accordance with the agreement between
Japan International Cooperation Agency
(JICA) and JICA Study Team.
The copyright of this drawing rests with JICA.

Designed by:
Japan International Cooperation
Agency (JICA)

JICA Study Team:
Joint Venture of
Pacific Consultants International and
Yamashita Sekido Inc.

Subcontracted Local Consultant:
 consolidated consultants
engineering & environment
Tel: 0112277 - Fax: 0112280 - JORDAN - AMMAN

Drawing Title:
CROSS-SECTION
5+740/5+760

Scale: H 1:400 V 1:200 **Drawing No.:** 273

NOTES :

- * FOR EXACT HEIGHTS AND DIMENSIONS OF BENCHES SEE TYPICAL ROAD CROSS-SECTION .
- * SLOPE H : V .

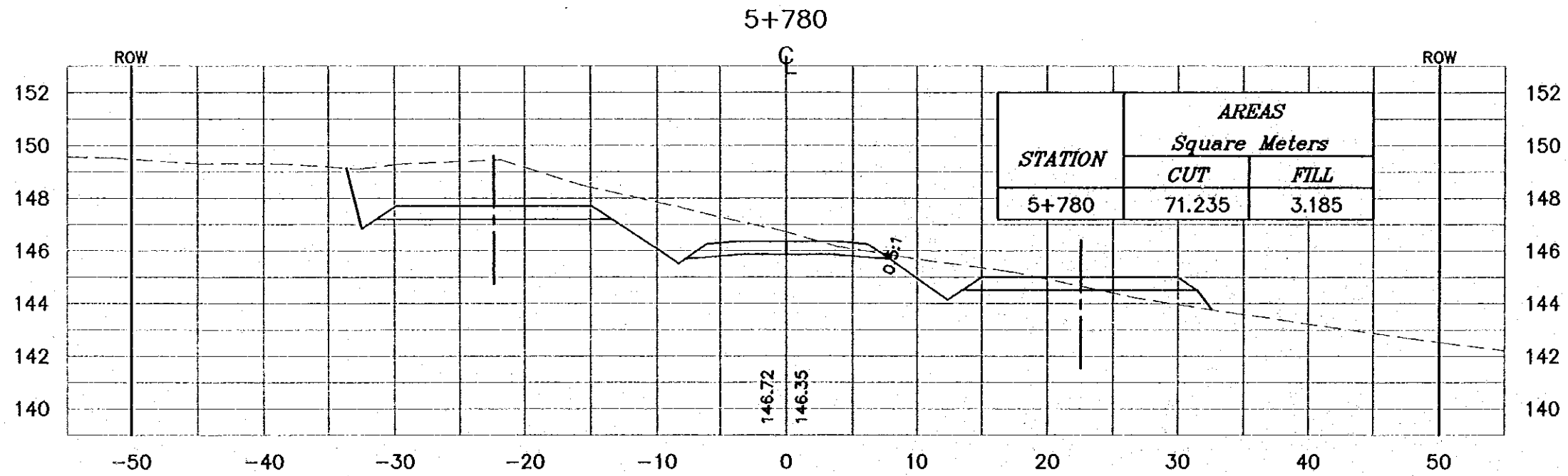
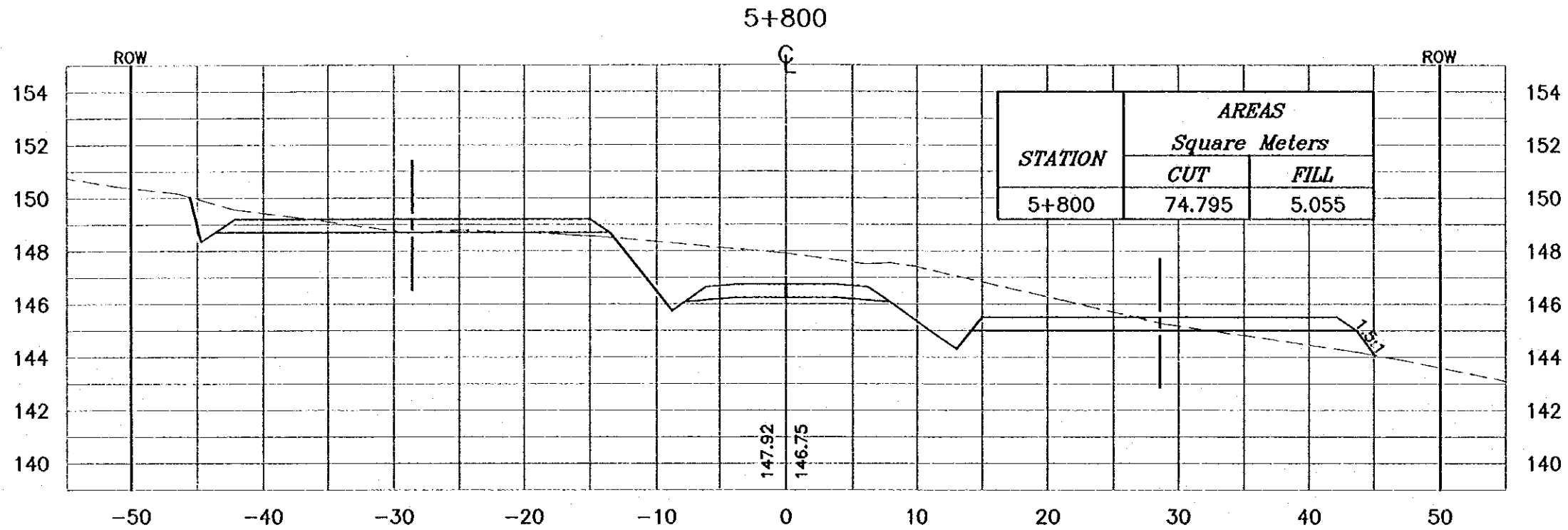

Project:
Tourism Sector Development Project
in the Hashemite Kingdom of Jordan

Executing Agency:
The Ministry of Tourism and Antiquities
The Ministry of Planning

SUB-PROJECT:
Dead Sea Parkway

Note:
This detailed design has been executed by a team of consultants as shown below in accordance with the agreement between Japan International Cooperation Agency (JICA) and JICA Study Team. The copyright of this drawing rests with JICA.

Designed by:
Japan International Cooperation Agency (JICA)

JICA Study Team:
Joint Venture of
Pacific Consultants International and
Yamashita Sato Inc.

Subcontracted Local Consultant:
consolidated consultants
engineering & environment
Tel. 961577 - Fax 961289 - JARAH - JORDAN

Drawing Title:
CROSS-SECTION
5+780/5+800

Scale: H 1:400 V 1:200 Drawing No.: 274

NOTES :

- * FOR EXACT HEIGHTS AND DIMENSIONS OF BENCHES SEE TYPICAL ROAD CROSS-SECTION .
- * SLOPE H : V .

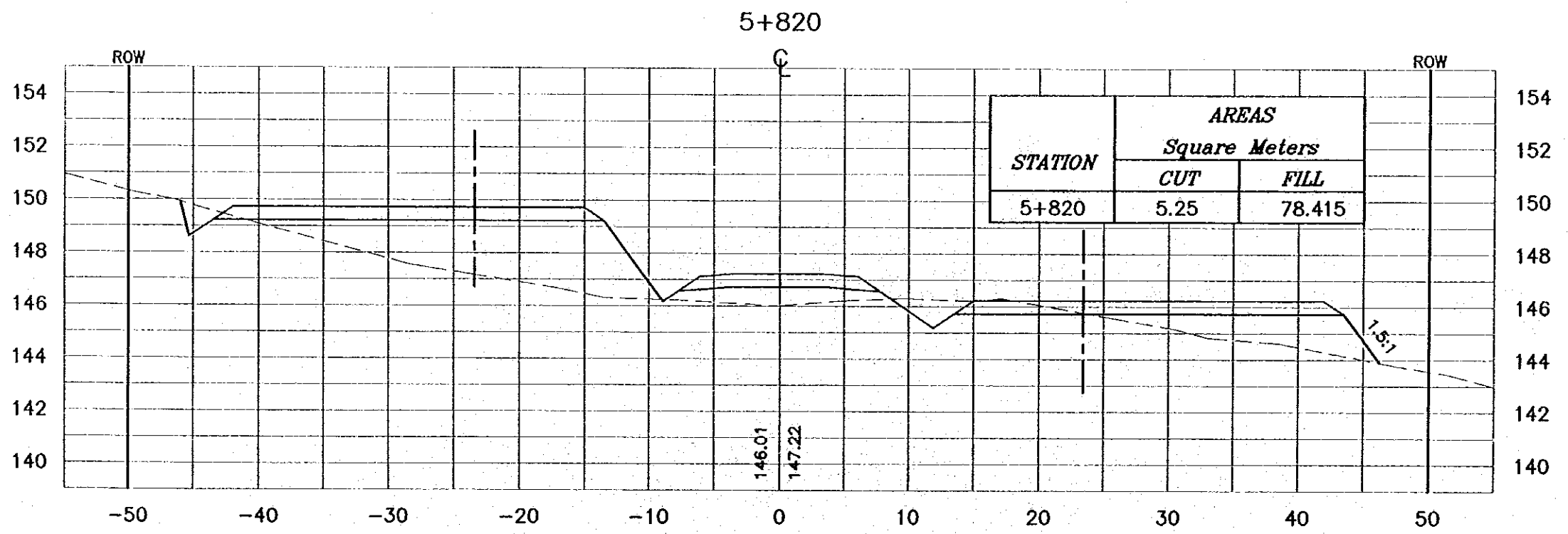
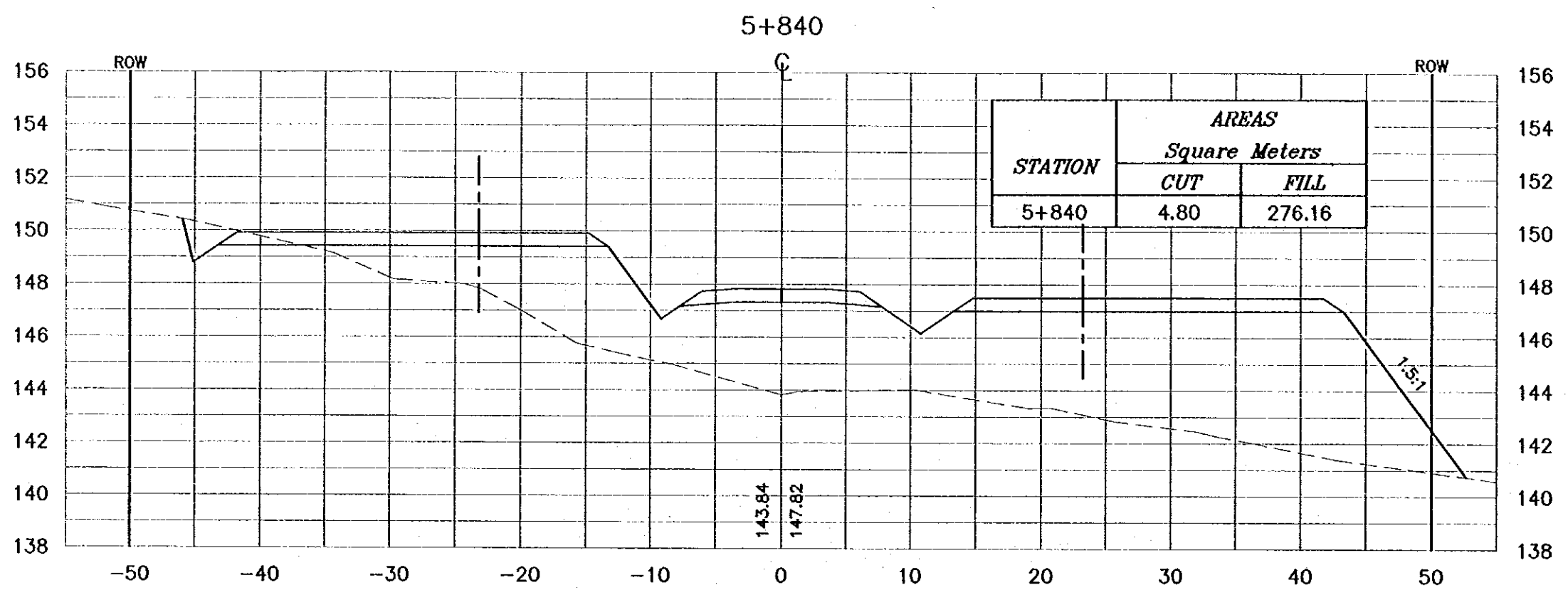

Project:
Tourism Sector Development Project
in the Hashemite Kingdom of Jordan

Executing Agency:
The Ministry of Tourism and Antiquities
The Ministry of Planning

SUB-PROJECT:
Dead Sea Parkway

Note:
This detailed design has been executed by a team of consultants as shown below in accordance with the agreement between Japan International Cooperation Agency (JICA) and JICA Study Team. The copyright of this drawing rests with JICA.

Designed by:
Japan International Cooperation Agency (JICA)

JICA Study Team:
Joint Venture of Pacific Consultants International and Yamashita Sekitai Inc.

Subcontracted Local Consultant:
consolidated consultants
engineering & environment
14c 012577 - P.O. BOX 9000 - AMMAN - JORDAN

Drawing Title:
CROSS-SECTION
5+820/5+840

Scale: 1:400
V 1:200

Drawing No.: 275

NOTES :

- * FOR EXACT HEIGHTS AND DIMENSIONS OF BENCHES SEE TYPICAL ROAD CROSS-SECTION .
- * SLOPE H : V .

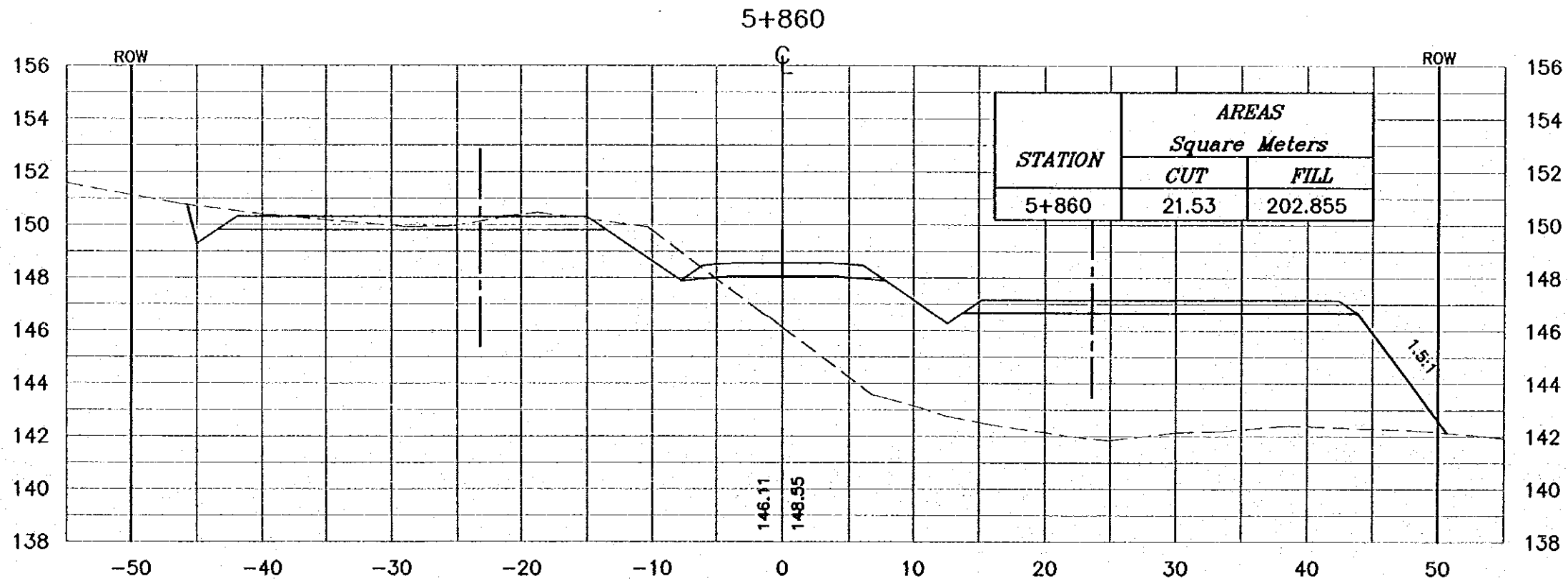
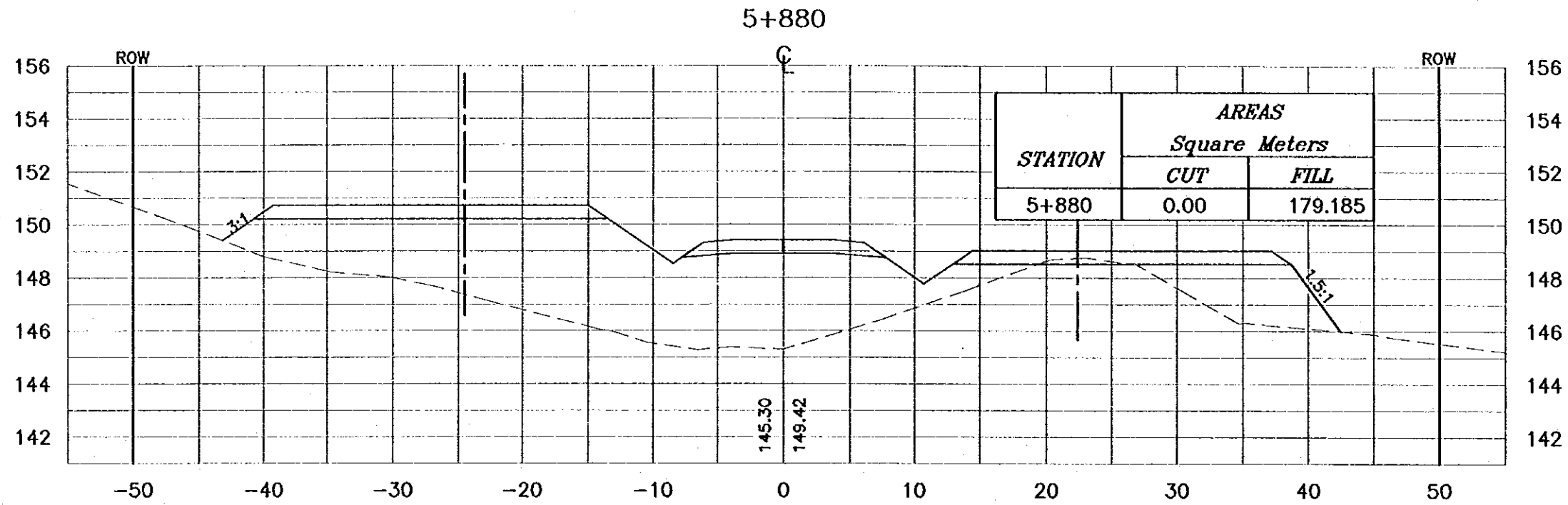

Project:
Tourism Sector Development Project
in the Hashemite Kingdom of Jordan

Executing Agency:
The Ministry of Tourism and Antiquities
The Ministry of Planning

SUB-PROJECT:
Dead Sea Parkway

Note:
This detailed design has been executed by
a team of consultants as shown below in
accordance with the agreement between
Japan International Cooperation Agency
(JICA) and JICA Study Team.
The copyright of this drawing rests with JICA.

Designed by:
Japan International Cooperation
Agency (JICA)

JICA Study Team:
Joint Venture of
Pacific Consultants International and
Yamashita Seldel Inc.

Subcontracted Local Consultant:
 consolidated consultants
ENGINEERING & ENVIRONMENT
Tel: 9952277 - Fax: 9952288 - AMMAN - JORDAN

Drawing Title:
CROSS-SECTION
5+860/5+880

Scale: H 1:400 V 1:200 **Drawing No.:** 276

NOTES :

- * FOR EXACT HEIGHTS AND DIMENSIONS OF BENCHES SEE TYPICAL ROAD CROSS-SECTION .
- * SLOPE H : V .

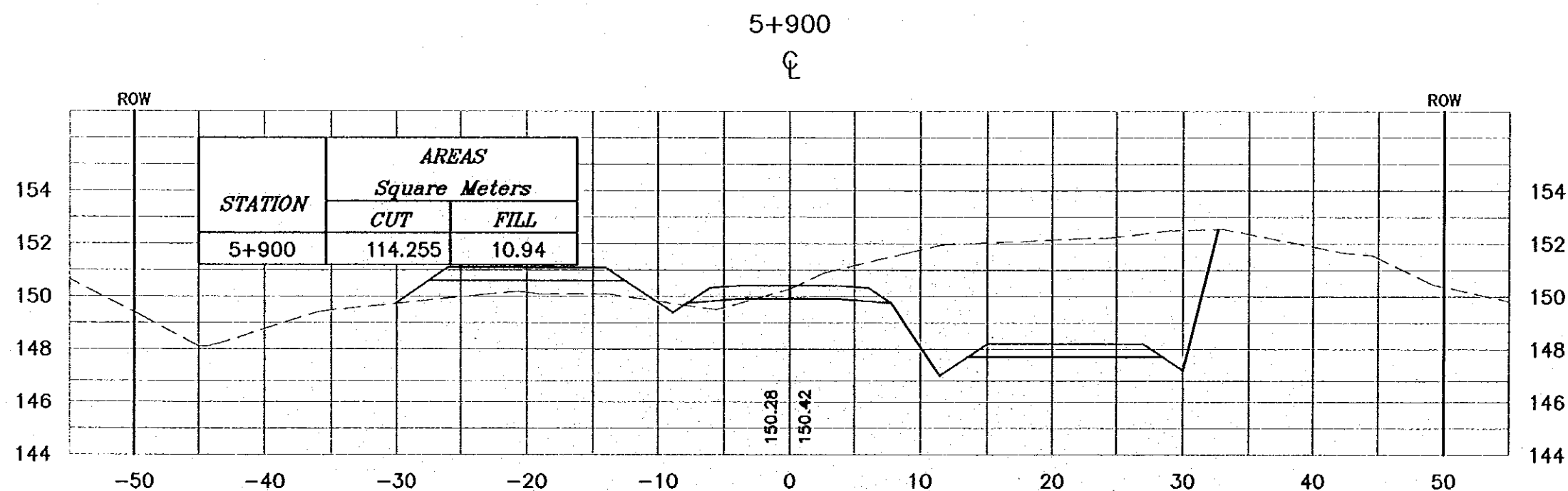
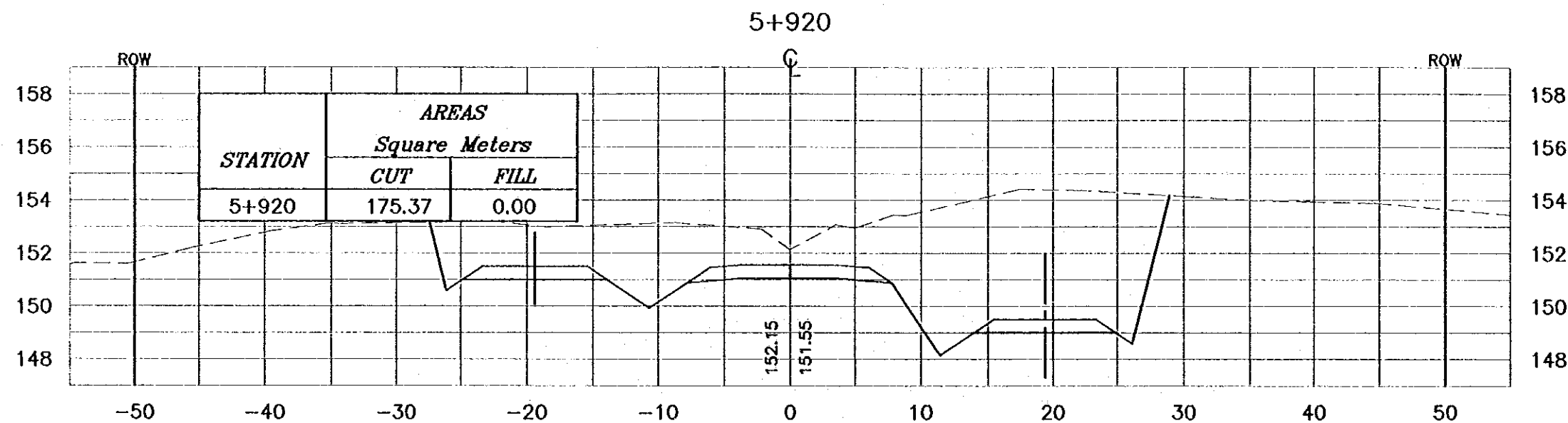

Project:
Tourism Sector Development Project
in the Hashemite Kingdom of Jordan

Executing Agency:
The Ministry of Tourism and Antiquities
The Ministry of Planning

SUB-PROJECT:
Dead Sea Parkway

Note:
This detailed design has been executed by a team of consultants as shown below in accordance with the agreement between Japan International Cooperation Agency (JICA) and JICA Study Team. The copyright of this drawing rests with JICA.

Designed by:
Japan International Cooperation Agency (JICA)

JICA Study Team:
Joint Venture of Pacific Consultants International and Yamashita Saito Inc.

Subcontracted Local Consultant:
 consolidated consultants
engineering & environment
Tel. 992377 - Fax 992388 - AMM - JORDAN

Drawing Title:
CROSS-SECTION
5+900/5+920

Scale:
H 1:400
V 1:200

Drawing No.: 277

NOTES :

- * FOR EXACT HEIGHTS AND DIMENSIONS OF BENCHES SEE TYPICAL ROAD CROSS-SECTION .
- * SLOPE H : V .

Project:
Tourism Sector Development Project
in the Hashemite Kingdom of Jordan

Executing Agency:
The Ministry of Tourism and Antiquities
The Ministry of Planning

SUB-PROJECT:
Dead Sea Parkway

Note:
This detailed design has been executed by
a team of consultants as shown below in
accordance with the agreement between
Japan International Cooperation Agency
(JICA) and JICA Study Team.
The copyright of this drawing rests with JICA.

Designed by:
Japan International Cooperation
Agency (JICA)

JICA Study Team:
Joint Venture of
Pacific Consultants International and
Yamashita Sekisui Inc.

Subcontracted Local Consultant:
consolidated consultants
engineering & environment
Tel. 9952577 - Fax. 9952388 - Amman - Jordan

Drawing Title:
CROSS-SECTION
5+940/5+960/5+980

Scale: H 1:400 Drawing No.: 278
V 1:200

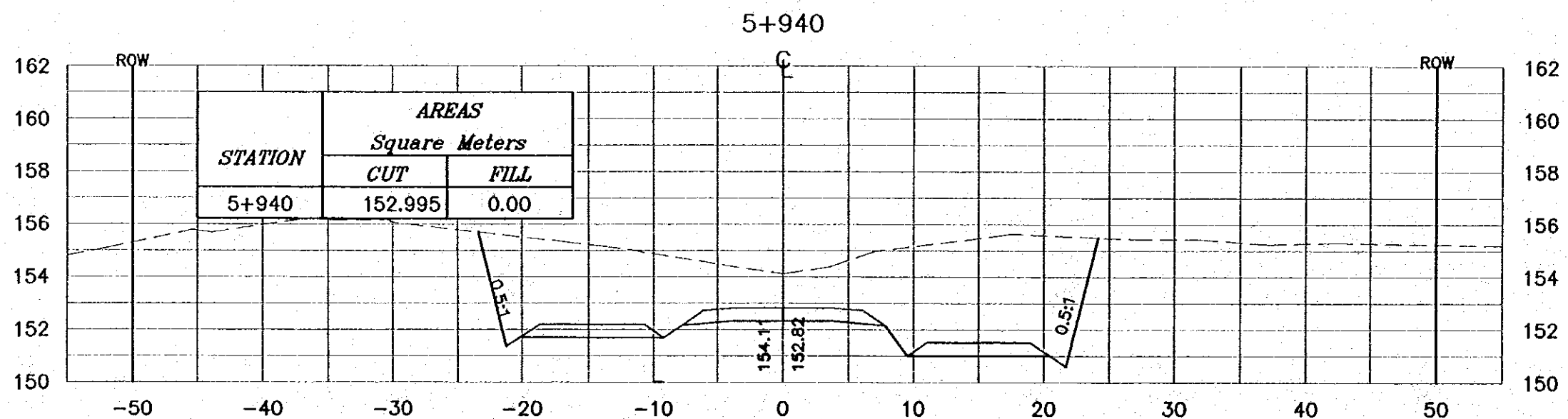
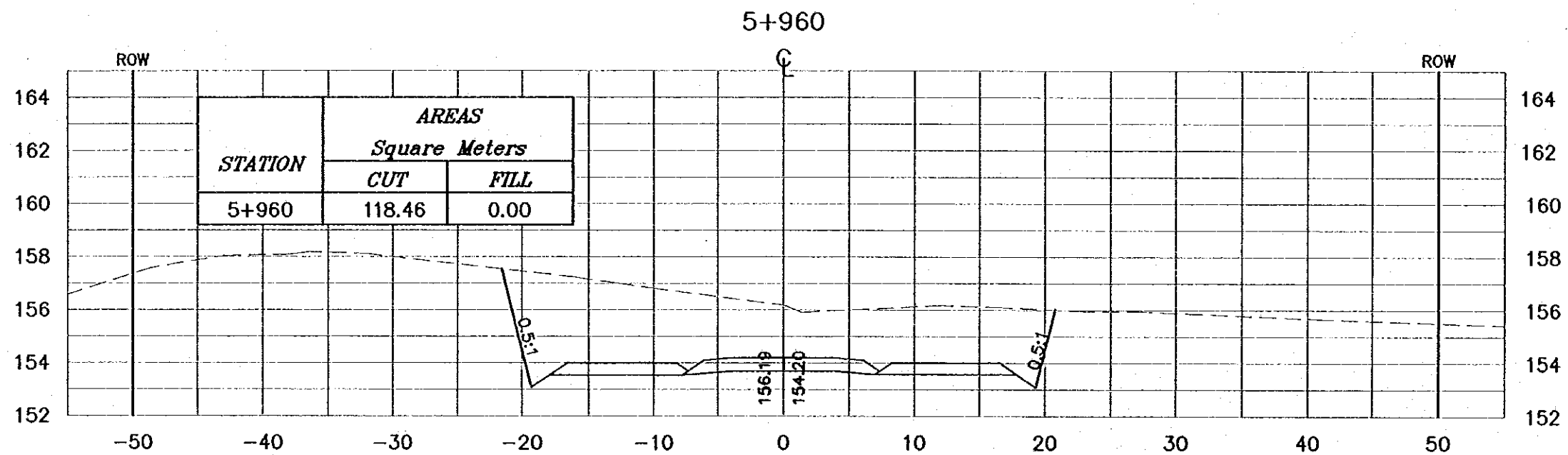
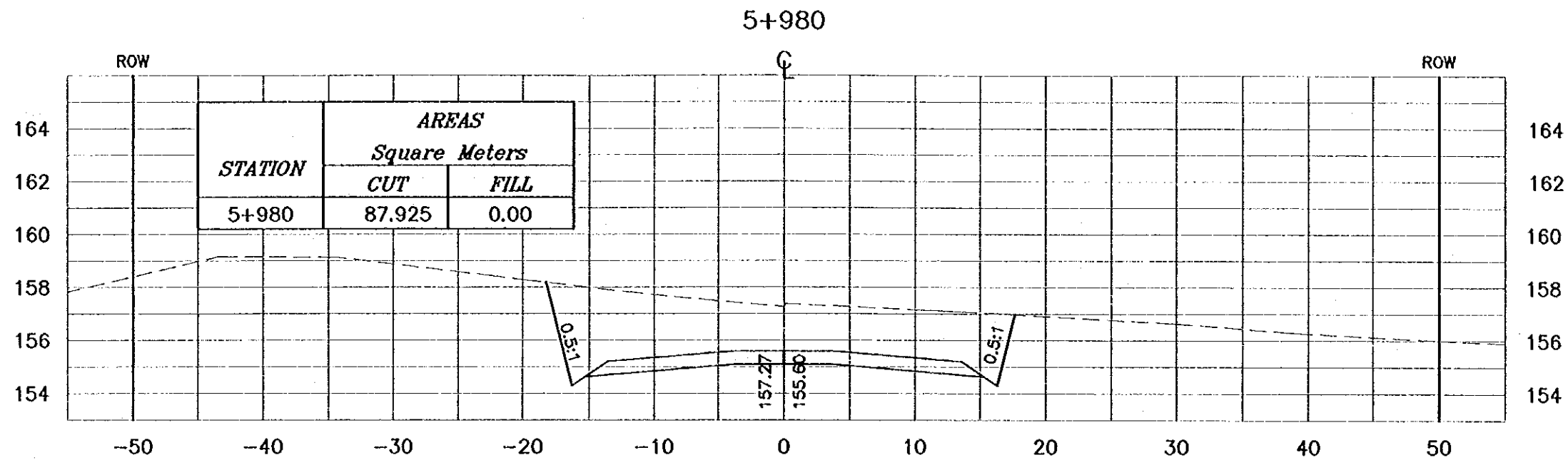

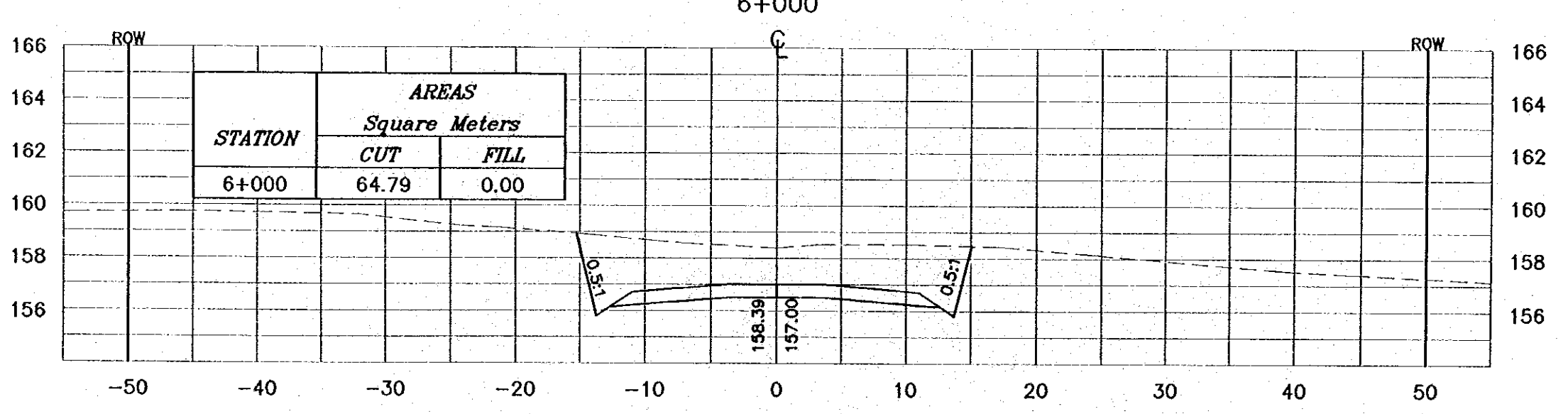
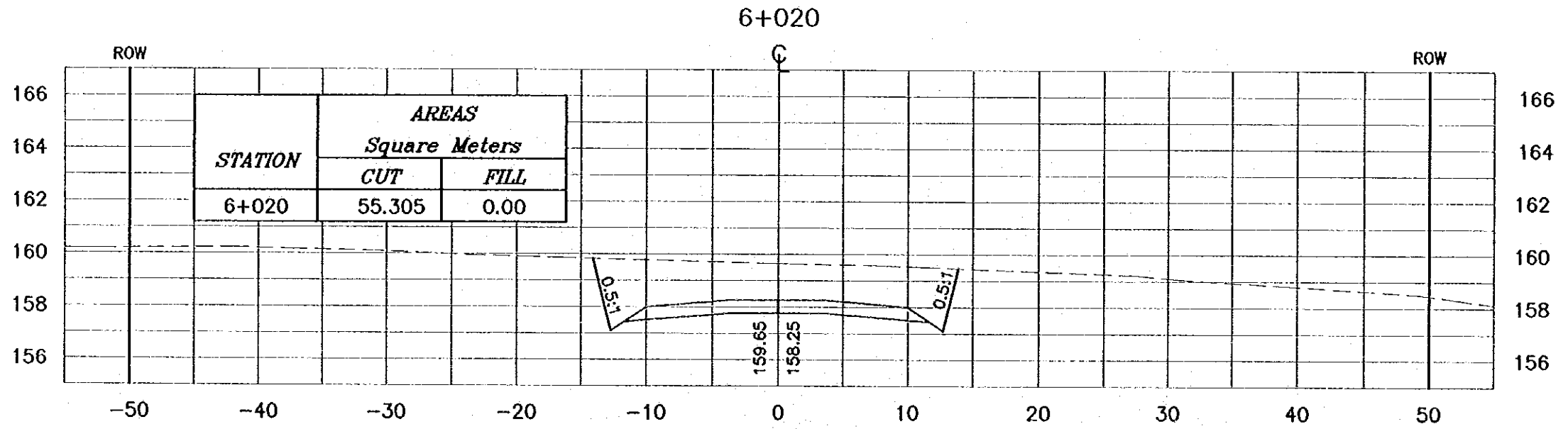
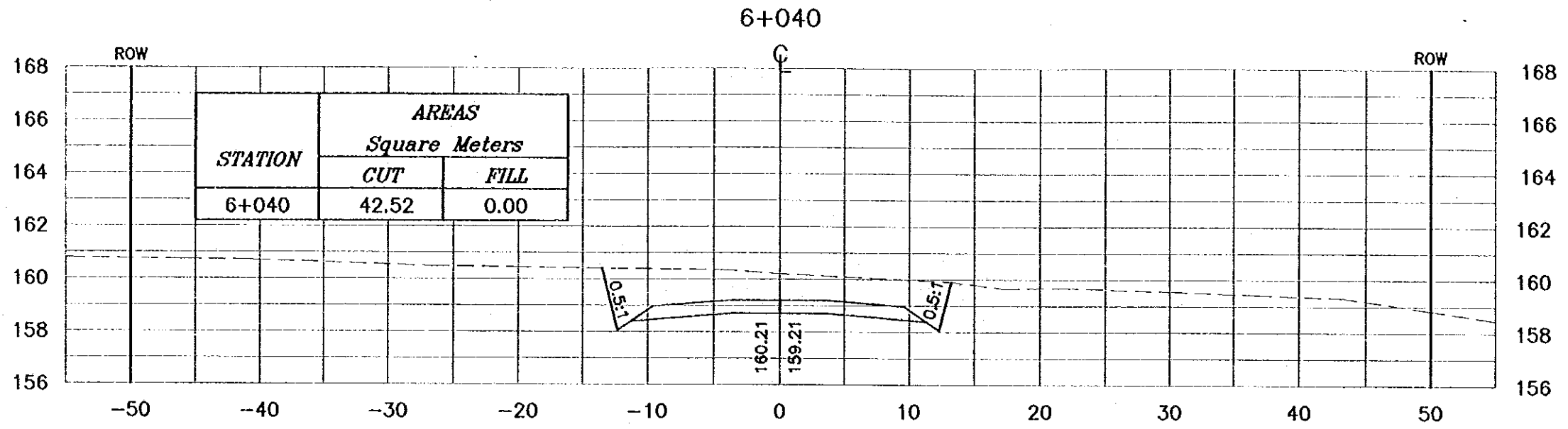

NOTES :

- * FOR EXACT HEIGHTS AND DIMENSIONS OF BENCHES SEE TYPICAL ROAD CROSS-SECTION .
- * SLOPE H : V .

Project:
Tourism Sector Development Project
In the Hashemite Kingdom of Jordan

Executing Agency:
The Ministry of Tourism and Antiquities
The Ministry of Planning

SUB-PROJECT:
Dead Sea Parkway

Note:
This detailed design has been executed by a team of consultants as shown below in accordance with the agreement between Japan International Cooperation Agency (JICA) and JICA Study Team. The copyright of this drawing rests with JICA.

Designed by:
Japan International Cooperation Agency (JICA)
JICA Study Team:
Joint Venture of Pacific Consultants International and Yamasaki Sekido Inc.

Subcontracted Local Consultant:
 consolidated consultants
ENGINEERING & ENVIRONMENT
Tel: 992227 - Fax: 992228 - Amman - Jordan

Drawing Title:
CROSS-SECTION
6+000/6+020/6+040

Scale: H: 1:400 V: 1:200 **Drawing No.:** 279

NOTES :

* FOR EXACT HEIGHTS AND DIMENSIONS OF BENCHES SEE TYPICAL ROAD CROSS-SECTION .

* SLOPE H : V .

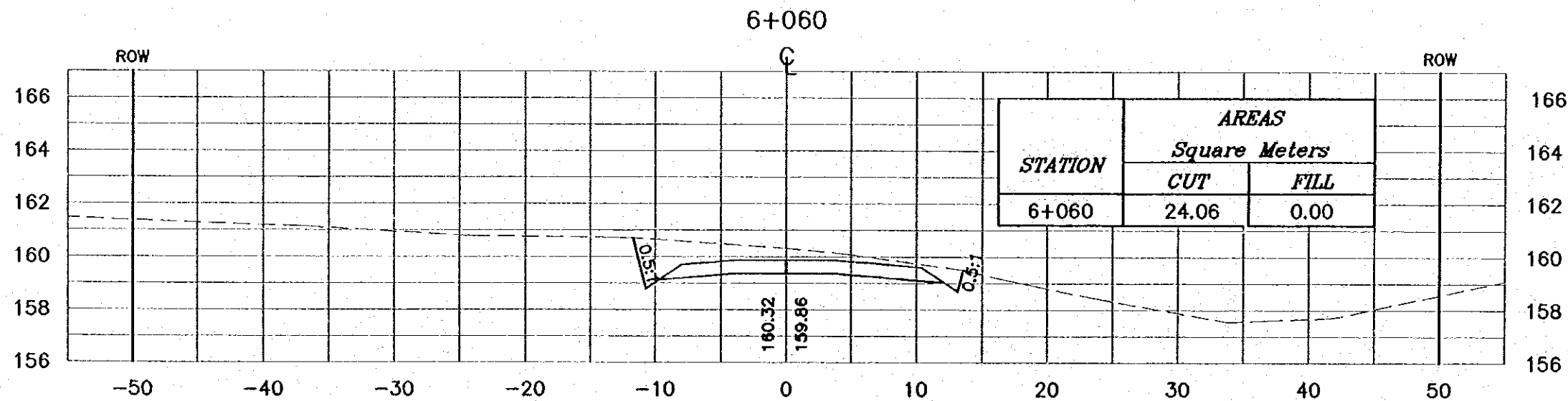
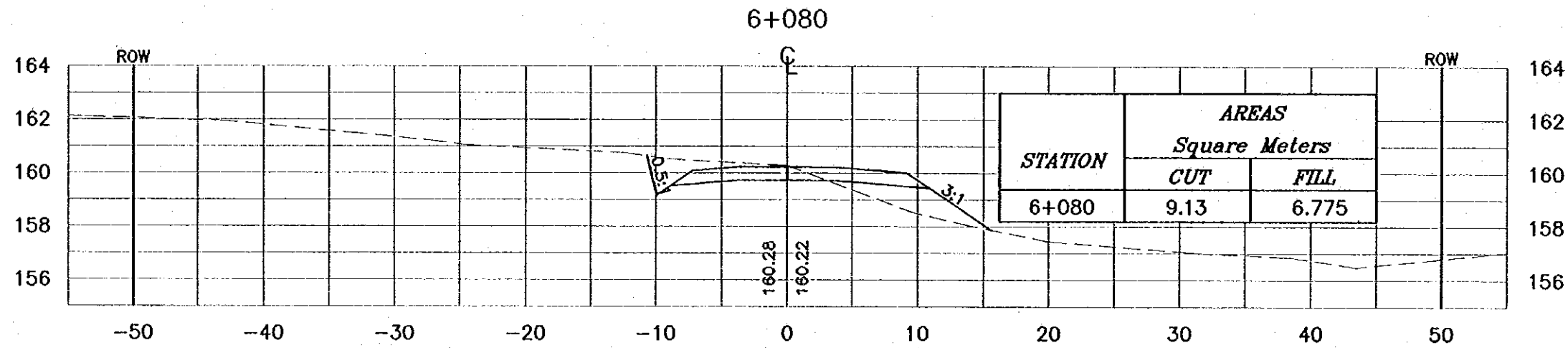
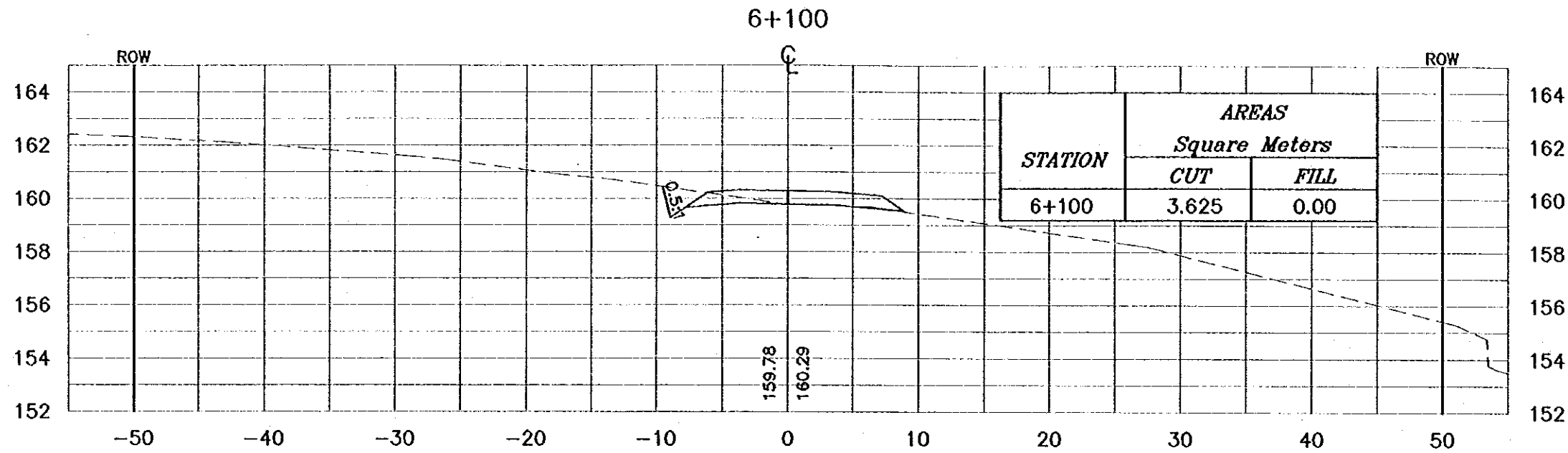

Project:
Tourism Sector Development Project
in the Hashemite Kingdom of Jordan

Executing Agency:
The Ministry of Tourism and Antiquities
The Ministry of Planning

SUB-PROJECT:
Dead Sea Parkway

Note:
This detailed design has been executed by
a team of consultants as shown below in
accordance with the agreement between
Japan International Cooperation Agency
(JICA) and JICA Study Team.
The copyright of this drawing rests with JICA.

Designed by:
Japan International Cooperation
Agency (JICA)

JICA Study Team:
Joint Venture of
Pacific Consultants International and
Yamashita Seidai Inc.

Subcontracted Local Consultant:
consolidated consultants
CONSULTING & ENVIRONMENT
16, 111277 - Fax: 111288 - AMM - JORDAN

Drawing Title:
CROSS-SECTION
6+060/6+080/6+100

Scale: H 1:400 V 1:200 Drawing No.: 280

NOTES :

- * FOR EXACT HEIGHTS AND DIMENSIONS OF BENCHES SEE TYPICAL ROAD CROSS-SECTION .
- * SLOPE H : V .

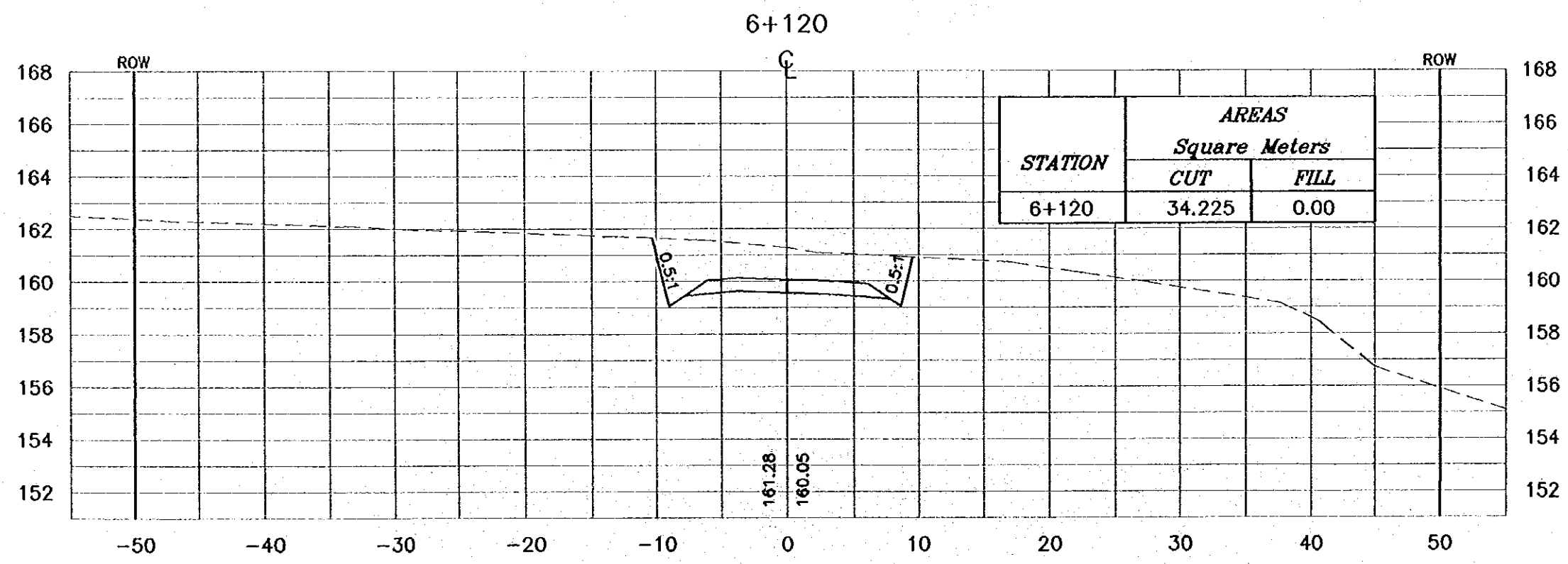
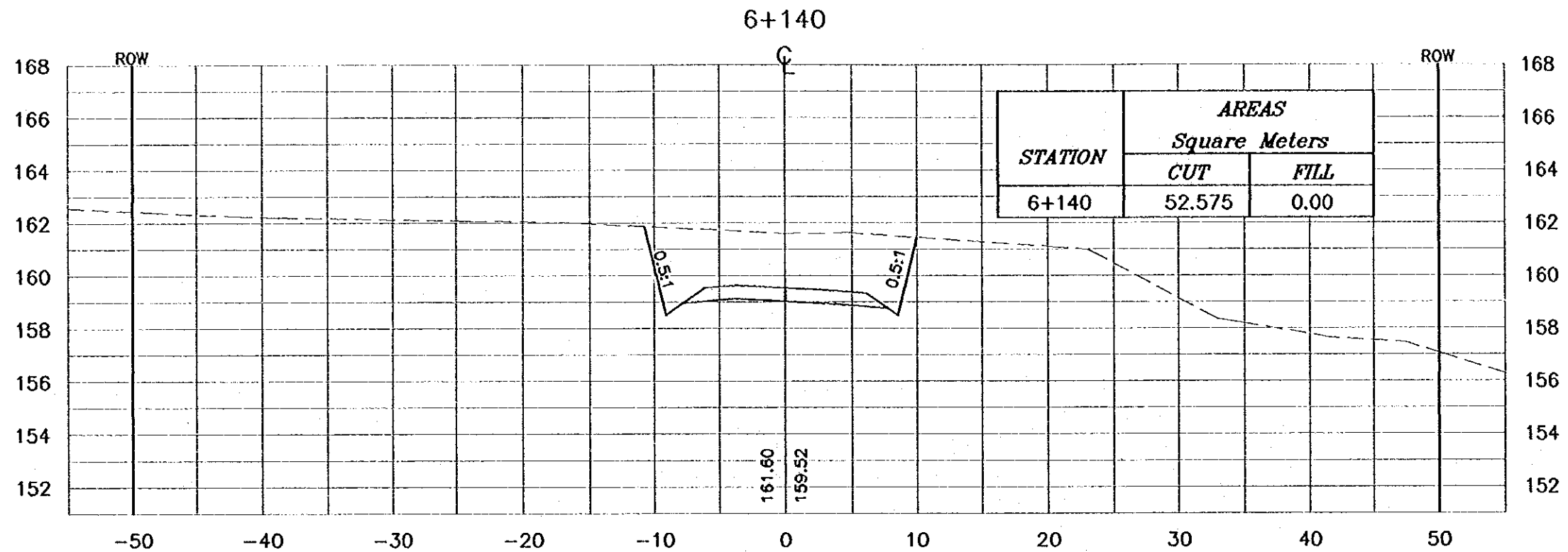

Project:
Tourism Sector Development Project
in the Hashemite Kingdom of Jordan

Executing Agency:
The Ministry of Tourism and Antiquities
The Ministry of Planning

SUB-PROJECT:
Dead Sea Parkway

Note:
This detailed design has been executed by a team of consultants as shown below in accordance with the agreement between Japan International Cooperation Agency (JICA) and JICA Study Team. The copyright of this drawing rests with JICA.

Designed by:
Japan International Cooperation Agency (JICA)

JICA Study Team:
Joint Venture of
Pacific Consultants International and
Yamashita Seki Co. Inc.

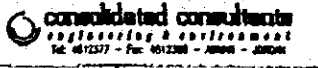
Subcontracted Local Consultant:

Tel: 4872377 - Fax: 4812288 - AMMAN - JORDAN

Drawing Title:
CROSS-SECTION
6+120/6+140

Scale: H 1:400 V 1:200 **Drawing No.:** 281

NOTES :

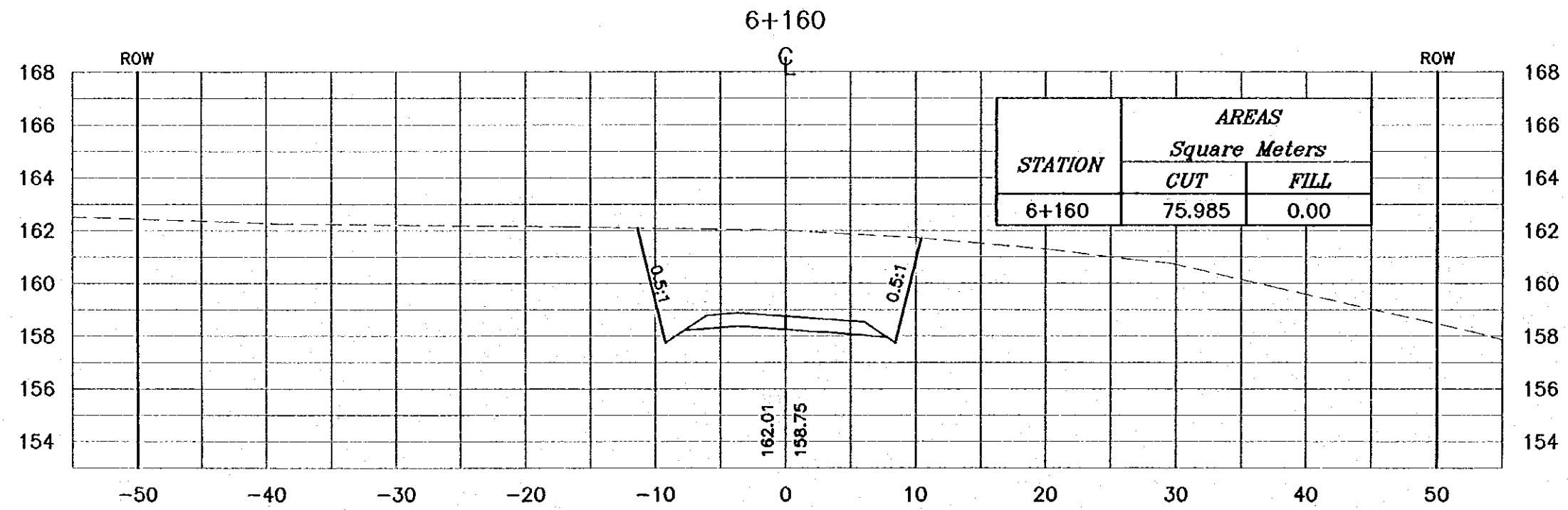
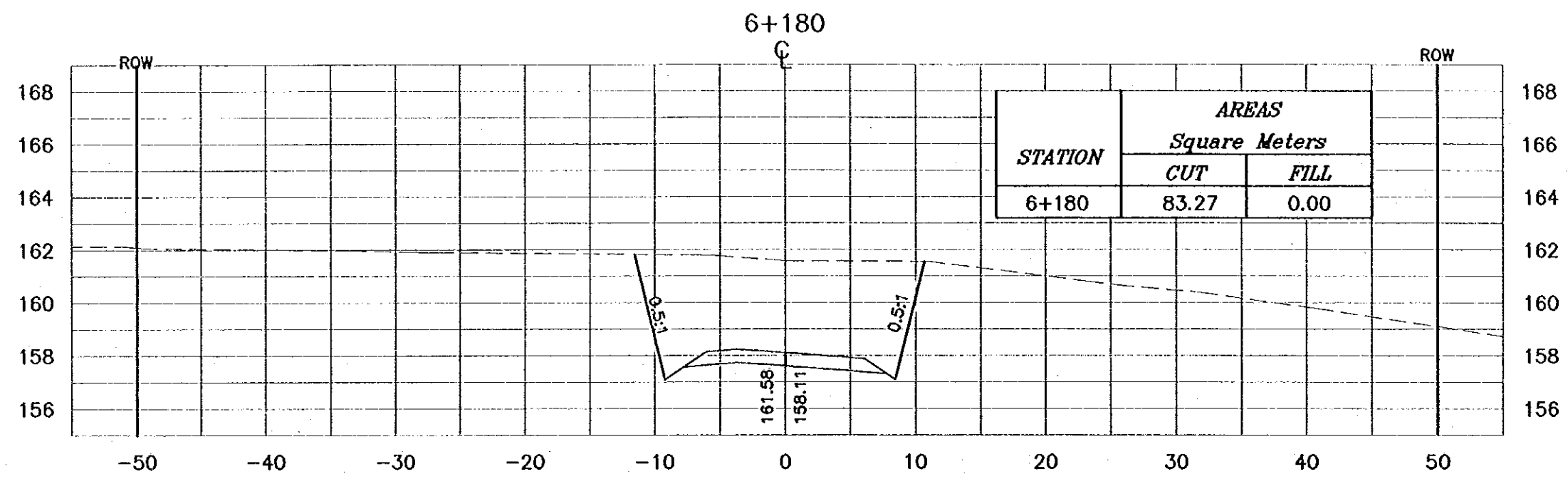
- * FOR EXACT HEIGHTS AND DIMENSIONS OF BENCHES SEE TYPICAL ROAD CROSS-SECTION .
- * SLOPE H : V .



Project:
Tourism Sector Development Project
In the Hashemite Kingdom of Jordan

Executing Agency:
The Ministry of Tourism and Antiquities
The Ministry of Planning

SUB-PROJECT:
Dead Sea Parkway

Note:
This detailed design has been executed by a team of consultants as shown below in accordance with the agreement between Japan International Cooperation Agency (JICA) and JICA Study Team.
The copyright of this drawing rests with JICA.

Designed by:
Japan International Cooperation Agency (JICA)

JICA Study Team:
Joint Venture of
Pacific Consultants International and
Yamashita Sekido Inc.

Subcontracted Local Consultant:
consolidated consultants
engineering & environment
Tel: 9612377 - Fax: 9612388 - Amman - Jordan

Drawing Title:
CROSS-SECTION
6+160/6+180

Scale: H 1:400 V 1:200 Drawing No.: 282

NOTES :

- * FOR EXACT HEIGHTS AND DIMENSIONS OF BENCHES SEE TYPICAL ROAD CROSS-SECTION .
- * SLOPE H : V .

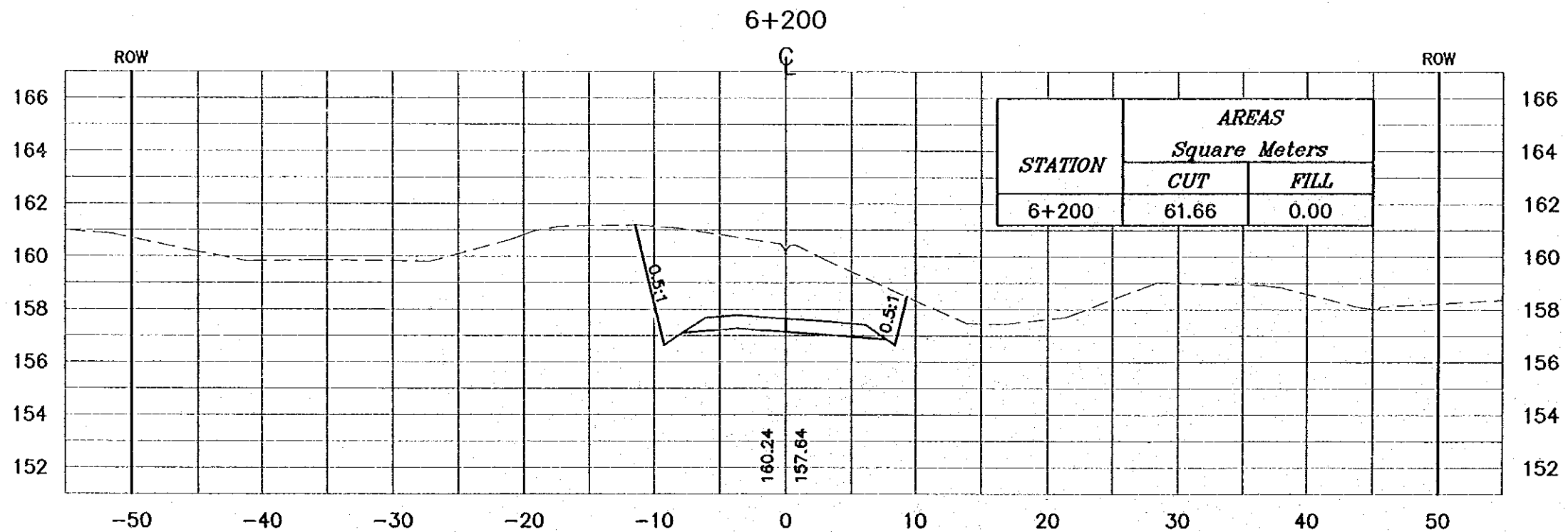
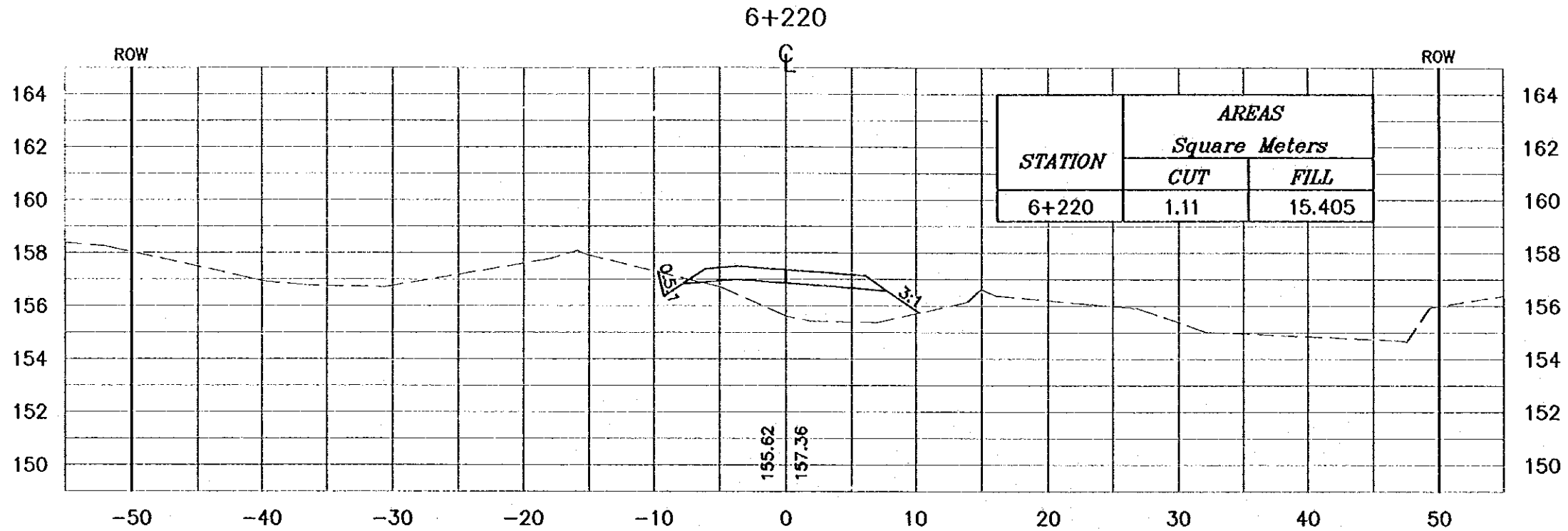

Project:
Tourism Sector Development Project
In the Hashemite Kingdom of Jordan

Executing Agency:
The Ministry of Tourism and Antiquities
The Ministry of Planning

SUB-PROJECT:
Dead Sea Parkway

Note:
This detailed design has been executed by a team of consultants as shown below in accordance with the agreement between Japan International Cooperation Agency (JICA) and JICA Study Team. The copyright of this drawing rests with JICA.

Designed by:
Japan International Cooperation Agency (JICA)

JICA Study Team:
Joint Venture of
Pacific Consultants International and
Yamashita Seikoku Inc.

Subcontracted Local Consultant:
 consolidated consultants
engineering & environment
Tel: 0112277 - Fax: 0112200 - Amman - Jordan

Drawing Title:
CROSS-SECTION
6+200/6+220

Scale: H 1:400 **Drawing No.:** 283
V 1:200

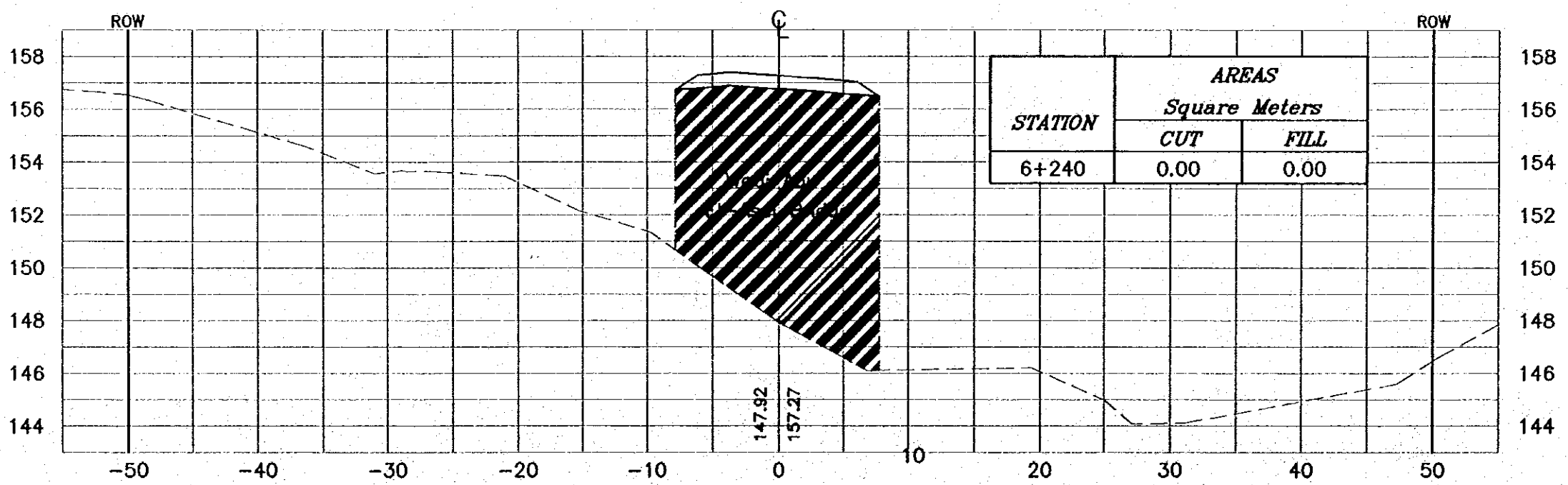
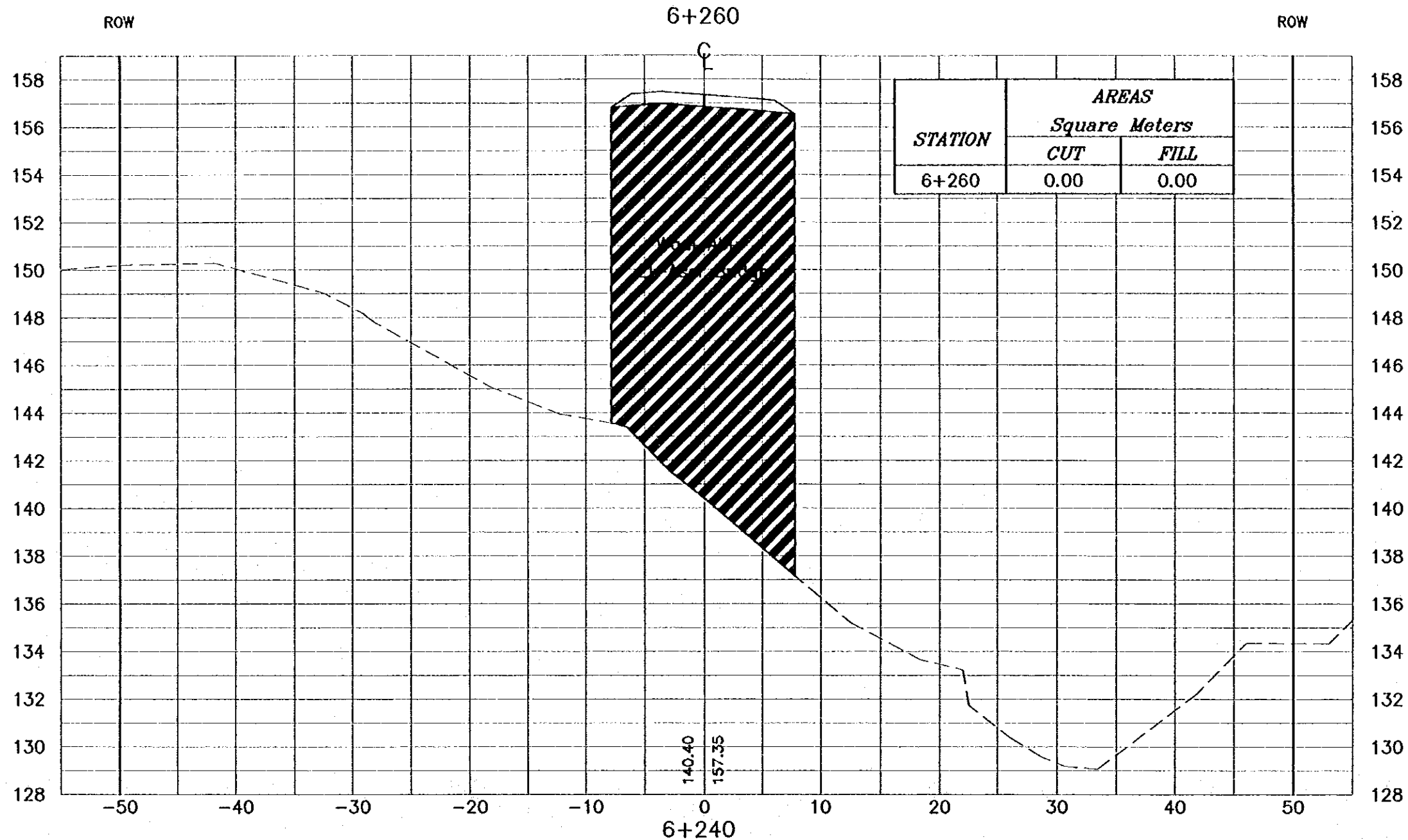

NOTES :
 * FOR EXACT HEIGHTS AND DIMENSIONS OF BENCHES SEE TYPICAL ROAD CROSS-SECTION .
 * SLOPE H : V .

Project:
 Tourism Sector Development Project
 in the Hashemite Kingdom of Jordan

Executing Agency:
 The Ministry of Tourism and Antiquities
 The Ministry of Planning

SUB-PROJECT:
 Dead Sea Parkway

Note:
 This detailed design has been executed by a team of consultants as shown below in accordance with the agreement between Japan International Cooperation Agency (JICA) and JICA Study Team. The copyright of this drawing rests with JICA.

Designed by:
 Japan International Cooperation Agency (JICA)

JICA Study Team:
 Joint Venture of Pacific Consultants International and Yamashita Sekido Inc.

Subcontracted Local Consultant:

 consolidated consultants
 engineering & environment
 Tel: 962277 - Fax: 962278 - Amman - Jordan

Drawing Title:
 CROSS-SECTION
 6+240/6+260

Scale: H 1:400 V 1:200 **Drawing No.:** 284

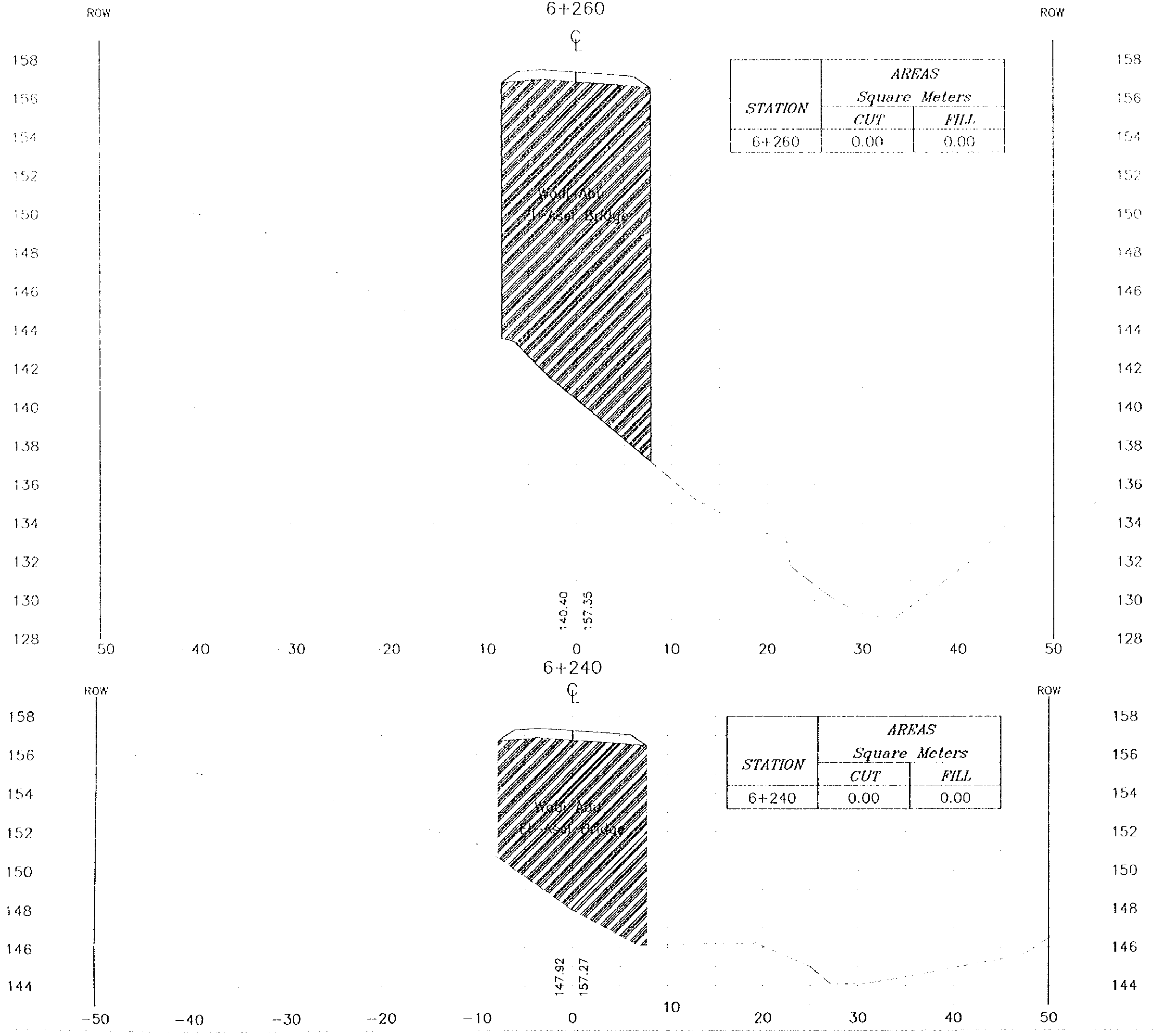

STATION	AREAS	
	Square Meters	
	CUT	FILL
6+260	0.00	0.00

STATION	AREAS	
	Square Meters	
	CUT	FILL
6+240	0.00	0.00

- NOTES :**
- FOR EXACT HEIGHTS AND DIMENSIONS OF BENCHES SEE TYPICAL ROAD CROSS-SECTION .
 - SLOPE H : V .

Project:
Tourism Sector Development Project
in the Hashemite Kingdom of Jordan

Executing Agency:
The Ministry of Tourism and Antiquities
The Ministry of Planning

SUB-PROJECT:
Dead Sea Parkway

Note:
This detailed design has been executed by
a team of consultants as shown below in
accordance with the agreement between
Japan International Cooperation Agency
(JICA) and JICA Study Team.
The copyright of this drawing rests with JICA.

Designed by:
Japan International Cooperation
Agency (JICA)

JICA Study Team:
Joint Venture of
Pacific Consultants International and
Yamashita Sekkei Inc.

Subcontracted Local Consultant:
consolidated consultants
engineering & environment
Tel: 052277 - Fax: 052260 - 052261 - 052262

Drawing Title:
CROSS-SECTION
6+240/6+260

Scale: H 1:400 V 1:200 Drawing No.: 284

NOTES :

- * FOR EXACT HEIGHTS AND DIMENSIONS OF BENCHES SEE TYPICAL ROAD CROSS-SECTION .
- * SLOPE H : V .

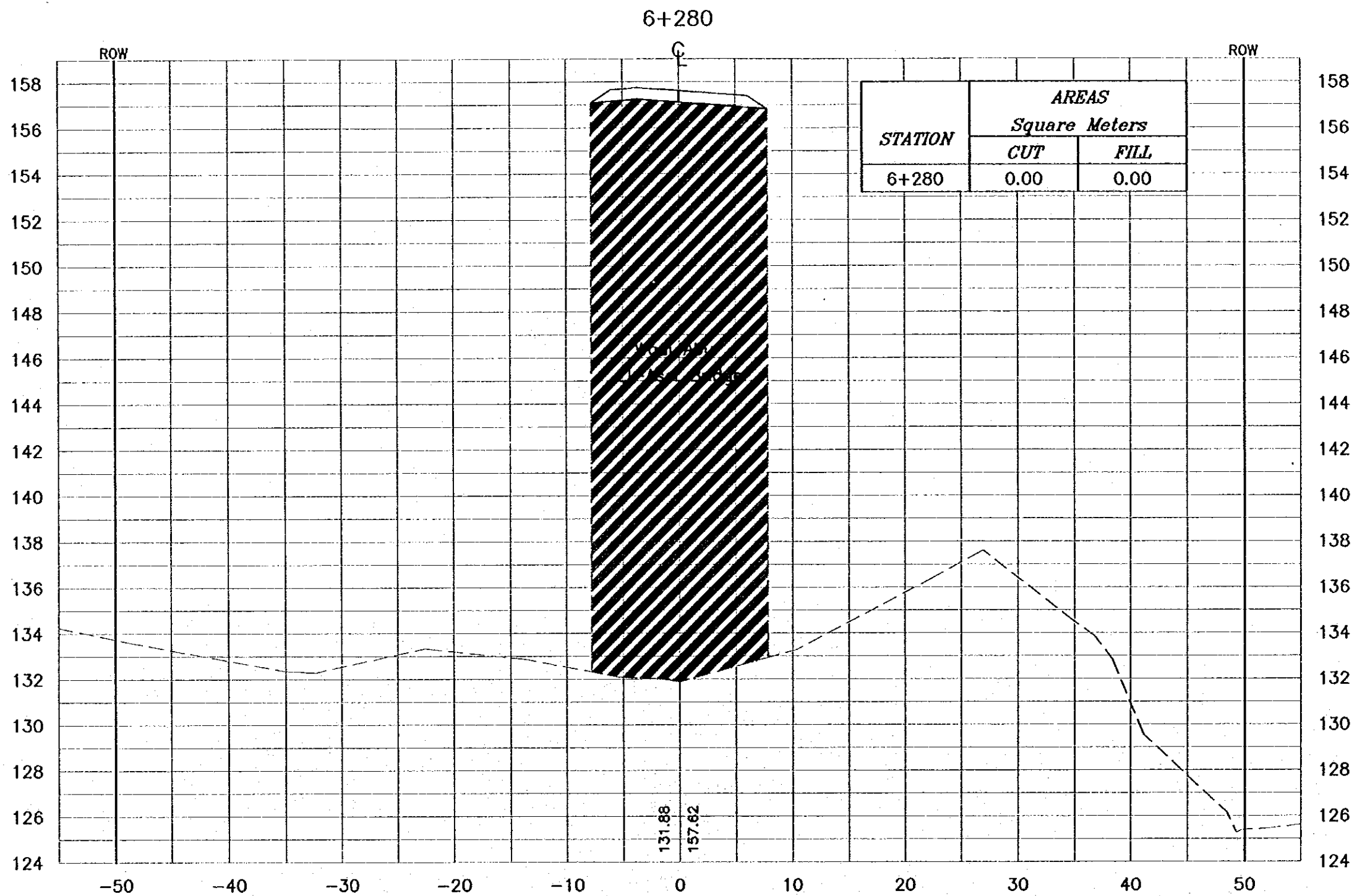

Project:
Tourism Sector Development Project
in the Hashemite Kingdom of Jordan

Executing Agency:
The Ministry of Tourism and Antiquities
The Ministry of Planning

SUB-PROJECT:
Dead Sea Parkway

Note:
This detailed design has been executed by
a team of consultants as shown below in
accordance with the agreement between
Japan International Cooperation Agency
(JICA) and JICA Study Team.
The copyright of this drawing rests with JICA.

Designed by:
Japan International Cooperation
Agency (JICA)

JICA Study Team:
Joint Venture of
Pacific Consultants International and
Yamashita Seikei Inc.

Subcontracted Local Consultant:
consolidated consultants
engineering & environment
Tel: 9952577 - Fax: 9952588 - Amman - Jordan

Drawing Title:
CROSS-SECTION
6+280

Scale: H 1:400 V 1:200 Drawing No.: 285

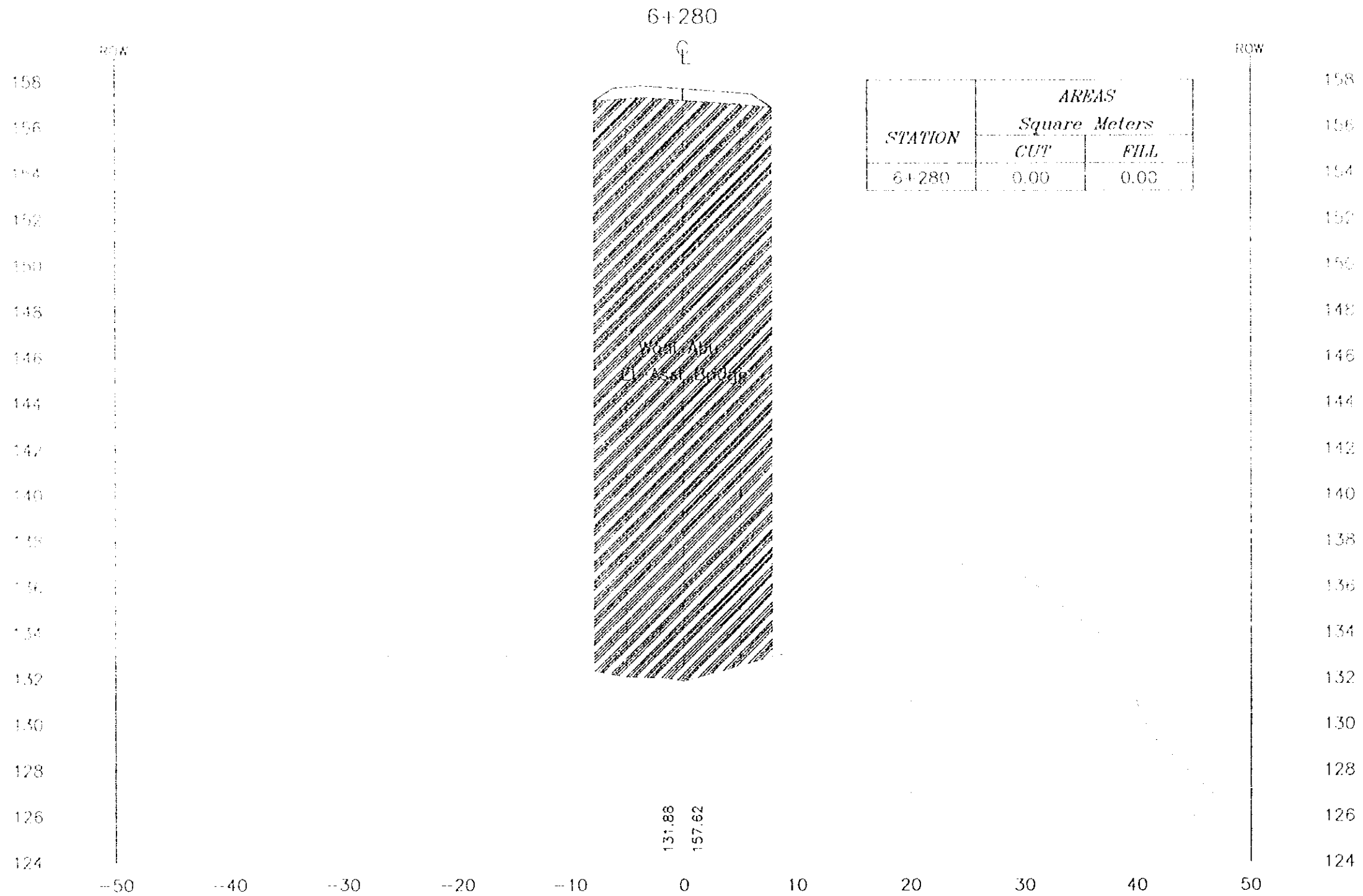

NOTES :

- FOR EXACT HEIGHTS AND DIMENSIONS OF BENCHES SEE TYPICAL ROAD CROSS SECTION.
- SLOPE H = V

Project: Tourism Sector Development Project in the Hashemite Kingdom of Jordan
 Executing Agency: The Ministry of Tourism and Antiquities, The Ministry of Planning

SUB-PROJECT: Dead Sea Parkway

Note: This detailed design has been executed by a team of consultants as shown below in accordance with the agreement between Japan International Cooperation Agency (JICA) and JICA Study Team. The copyright of this drawing rests with JICA.

Designed by: Japan International Cooperation Agency (JICA)

JICA Study Team: Joint Venture of Pacific Consultants International and Yamato Sekkei Inc.

Subcontracted Local Consultant: **consolidated consultants**
 engineering & environment
 14 412377 - Tel: 412366 - MOA, JICA

Drawing Title: CROSS-SECTION
 6+280

Scale: H 1:400 V 1:200 Drawing No.: 285

NOTES :

- * FOR EXACT HEIGHTS AND DIMENSIONS OF BENCHES SEE TYPICAL ROAD CROSS-SECTION .
- * SLOPE H : V .

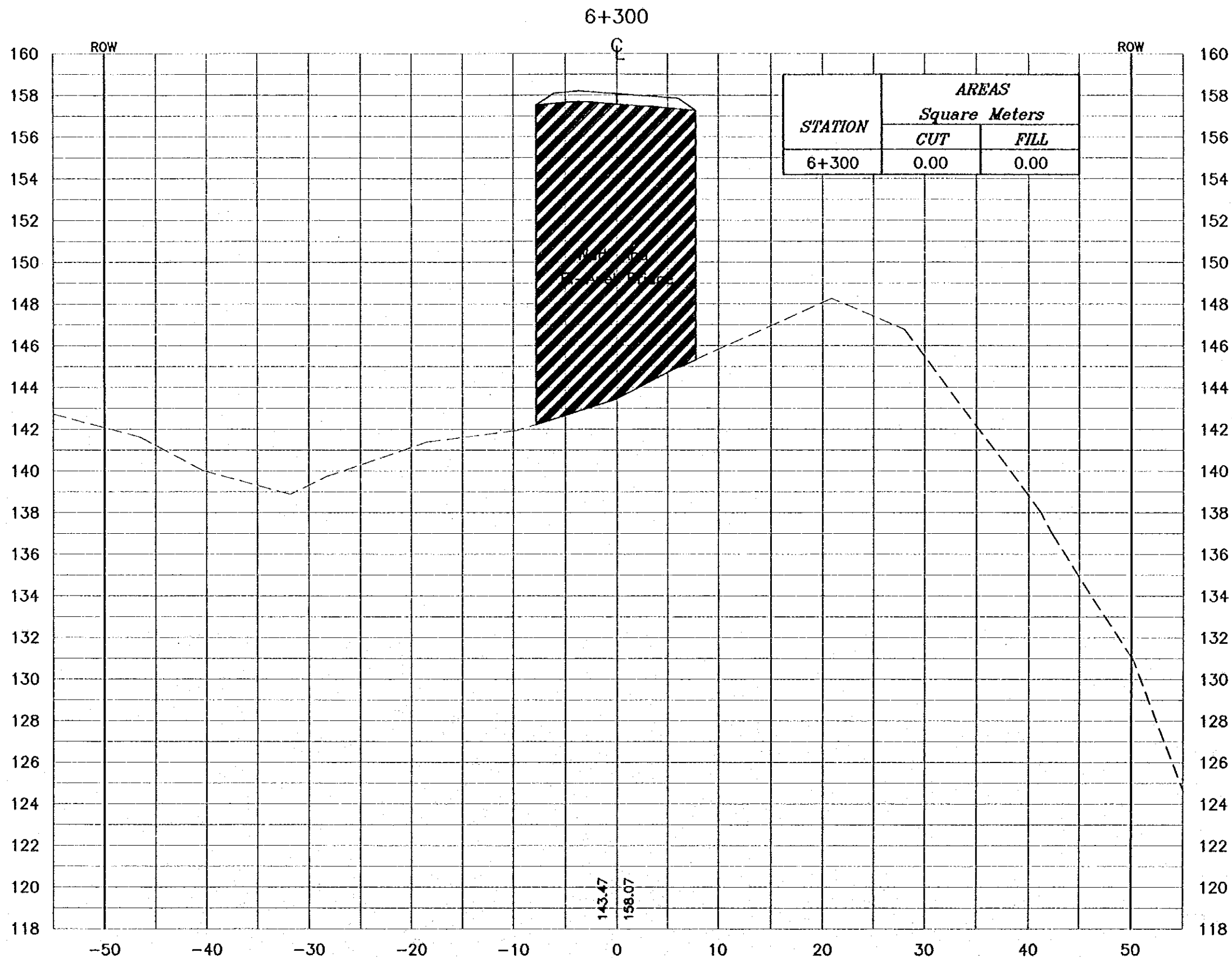

Project:
Tourism Sector Development Project
in the Hashemite Kingdom of Jordan

Executing Agency:
The Ministry of Tourism and Antiquities
The Ministry of Planning

SUB-PROJECT:
Dead Sea Parkway

Note:
This detailed design has been executed by
a team of consultants as shown below in
accordance with the agreement between
Japan International Cooperation Agency
(JICA) and JICA Study Team.
The copyright of this drawing rests with JICA.

Designed by:
Japan International Cooperation
Agency (JICA)

JICA Study Team:
Joint Venture of
Pacific Consultants International and
Yamashita Sekido Inc.

Subcontracted Local Consultant:
consolidated consultants
engineering & environment
Tel. 012377 - Fax. 012388 - AMMAN - JORDAN

Drawing Title:
CROSS-SECTION
6+300

Scale: H 1:400 V 1:200 Drawing No.: 286

NOTES :

- FOR EXACT HEIGHTS AND DIMENSIONS OF BENCHES SEE TYPICAL ROAD CROSS SECTION.
- SLOPE H = 1 V = 1

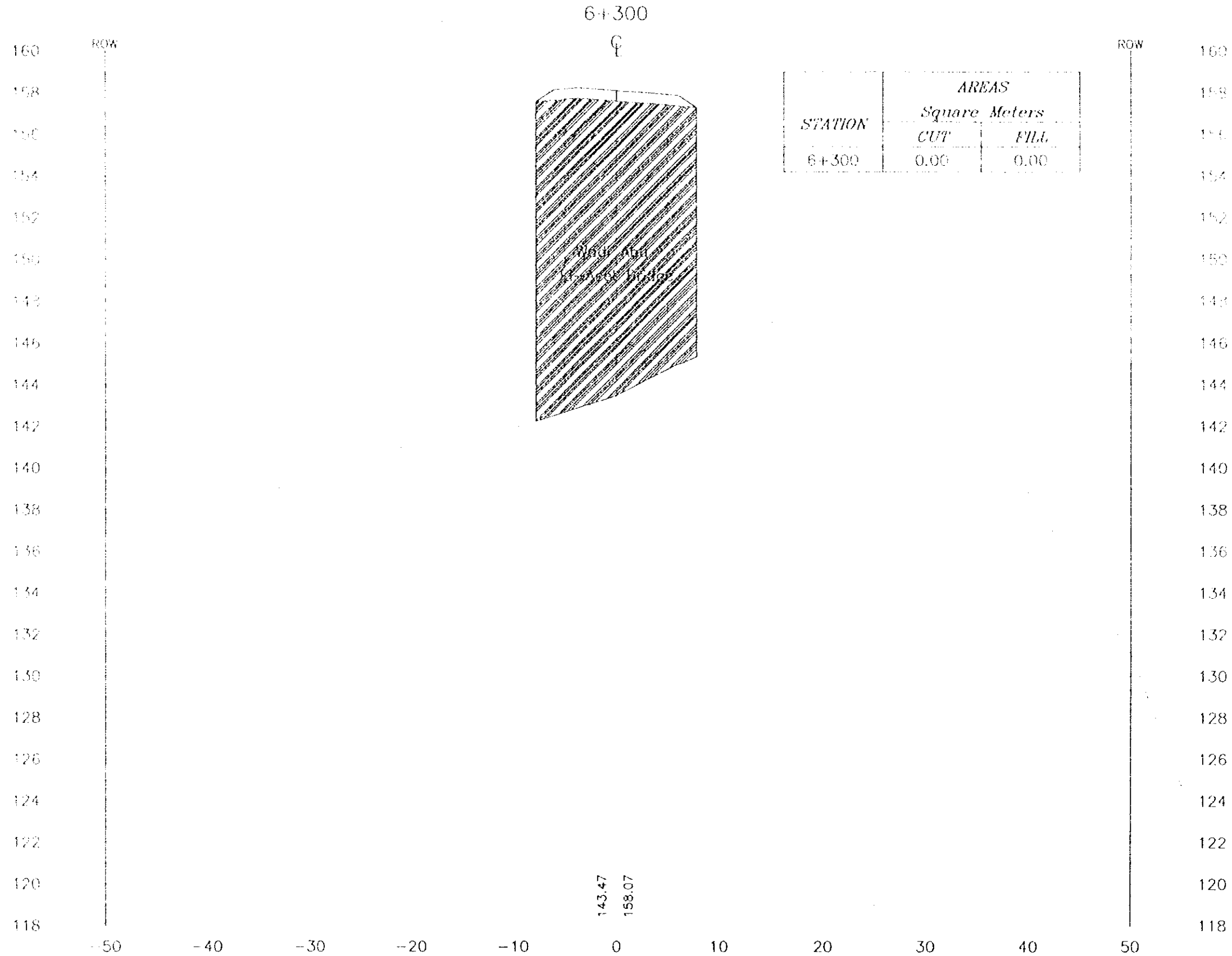

Project:
Tourism Sector Development Project
in the Hashemite Kingdom of Jordan

Executing Agency:
The Ministry of Tourism and Antiquities
The Ministry of Planning

SUB-PROJECT:
Dead Sea Parkway

Note:
This detailed design has been executed by
a team of consultants as shown below in
accordance with the agreement between
Japan International Cooperation Agency
(JICA) and JICA Study Team.
The copyright of this drawing rests with JICA.

Designed by:
Japan International Cooperation
Agency (JICA)

JICA Study Team:
Joint Venture of
Pacific Consultants International and
Yamato Sekkei Inc.

Subcontracted Local Consultant:
consolidated consultants
ENGINEERING & ARCHITECTURE
P.O. BOX 101111 - JORDAN - AMMAN

Drawing Title:
CROSS-SECTION
6+300

Scale: H 1:400 V 1:200 Drawing No.: 286

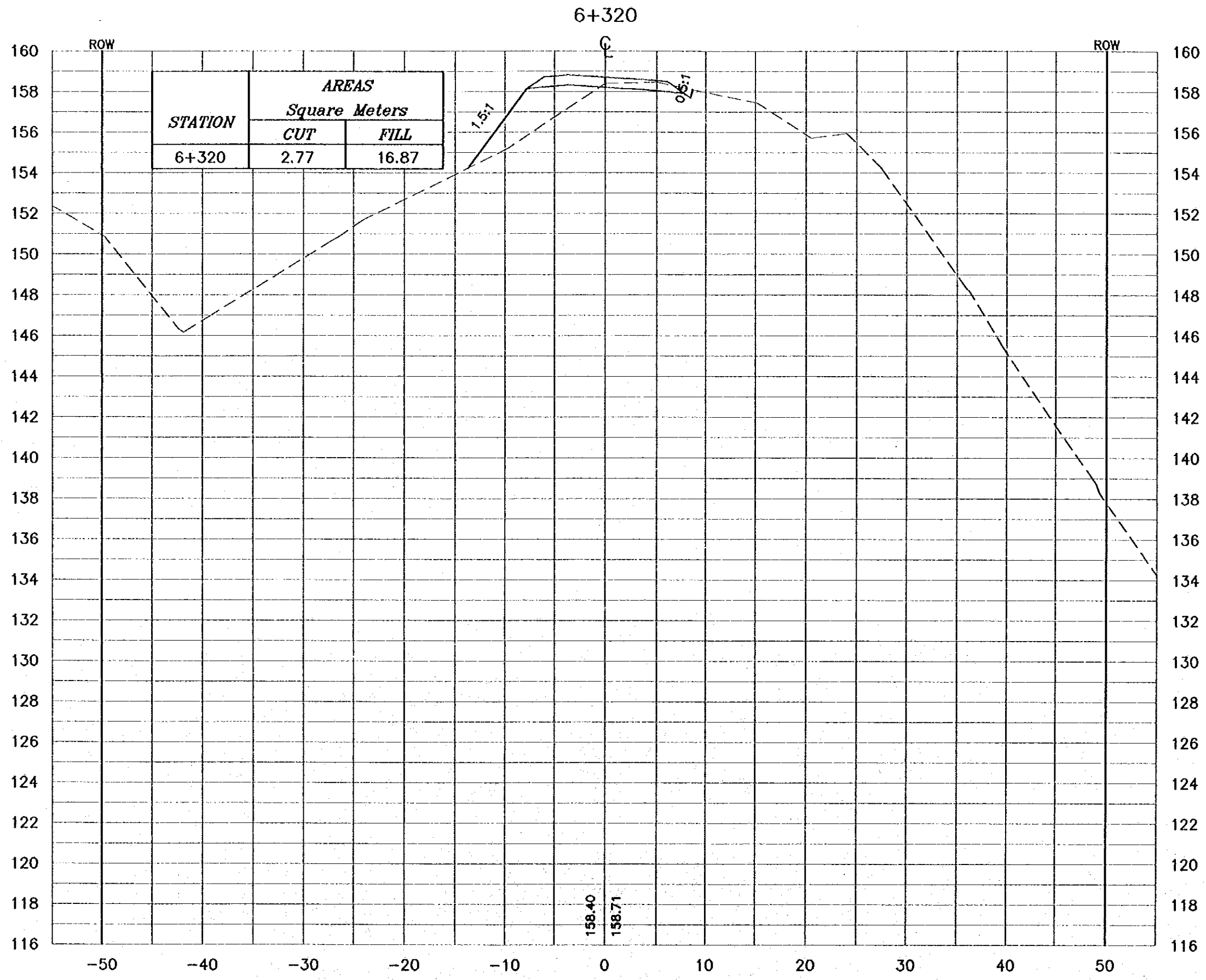

NOTES :

- * FOR EXACT HEIGHTS AND DIMENSIONS OF BENCHES SEE TYPICAL ROAD CROSS-SECTION .
- * SLOPE H : V .

Project:
Tourism Sector Development Project
in the Hashemite Kingdom of Jordan

Executing Agency:
The Ministry of Tourism and Antiquities
The Ministry of Planning

SUB-PROJECT:
Dead Sea Parkway

Note:
This detailed design has been executed by a team of consultants as shown below in accordance with the agreement between Japan International Cooperation Agency (JICA) and JICA Study Team. The copyright of this drawing rests with JICA.

Designed by:
Japan International Cooperation Agency (JICA)

JICA Study Team:
Joint Venture of
Pacific Consultants International and
Yamashita Seki Inc.

Subcontracted Local Consultant:

consolidated consultants
ENGINEERING & ENVIRONMENT
Tel: 9612777 - Fax: 9612300 - AMMAN - JORDAN

Drawing Title:
CROSS-SECTION
6+320

Scale: H 1:400 V 1:200 **Drawing No.:** 287

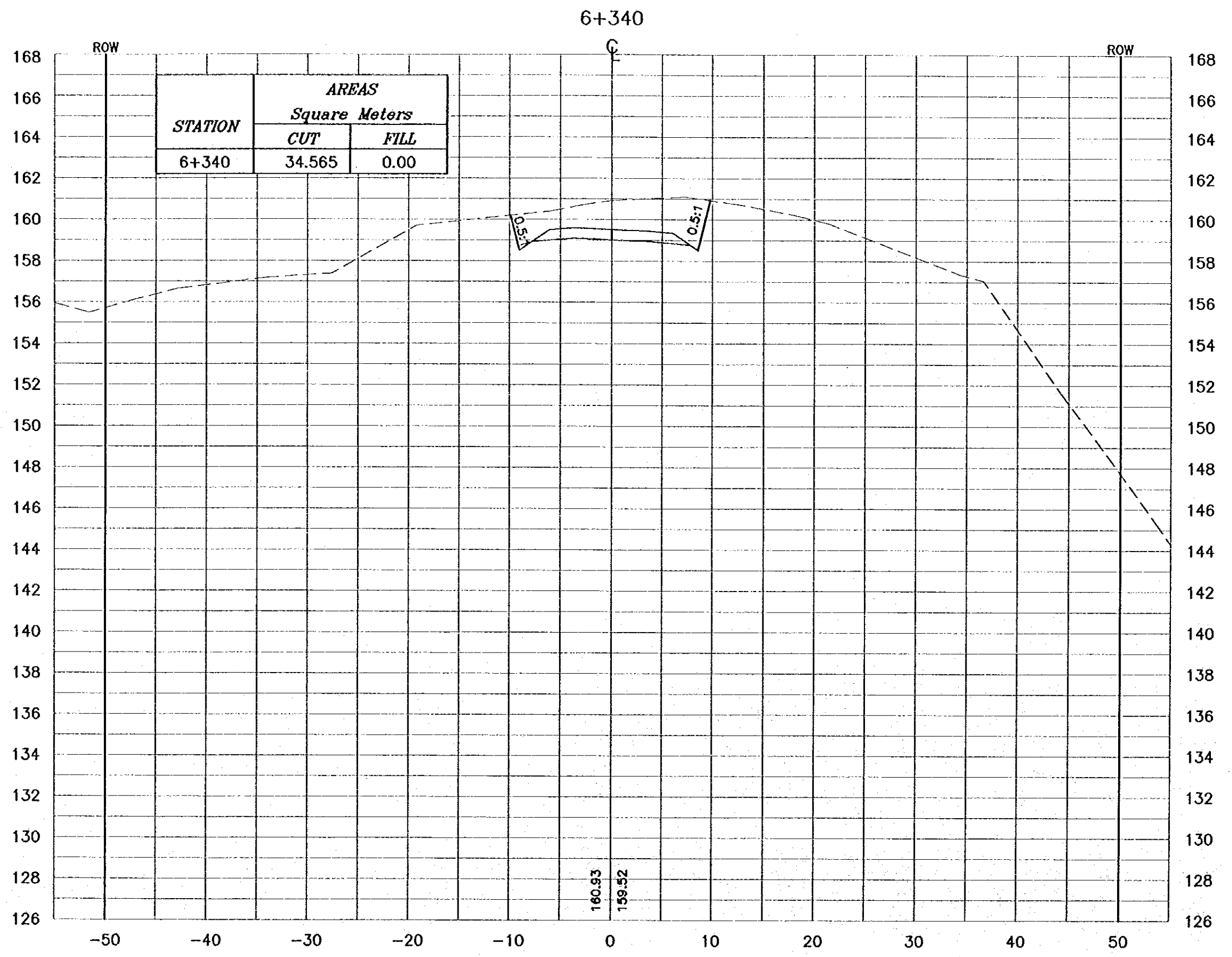

NOTES :
 * FOR EXACT HEIGHTS AND DIMENSIONS OF BENCHES SEE TYPICAL ROAD CROSS-SECTION .
 * SLOPE H : V .

Project:
 Tourism Sector Development Project in the Hashemite Kingdom of Jordan

Executing Agency:
 The Ministry of Tourism and Antiquities
 The Ministry of Planning

SUB-PROJECT:
 Dead Sea Parkway

Note:
 This detailed design has been executed by a team of consultants as shown below in accordance with the agreement between Japan International Cooperation Agency (JICA) and JICA Study Team. The copyright of this drawing rests with JICA.

Designed by:
 Japan International Cooperation Agency (JICA)

JICA Study Team:
 Joint Venture of Pacific Consultants International and Yamashita Sekitai Inc.

Subcontracted Local Consultant:

 consolidated consultants
 engineering & environment
 Tel: 972277 - Fax: 972286 - JORDAN - ZARQA

Drawing Title:
 CROSS-SECTION
 6+340

Scale: H 1:400 V 1:200 **Drawing No.:** 288

NOTES :

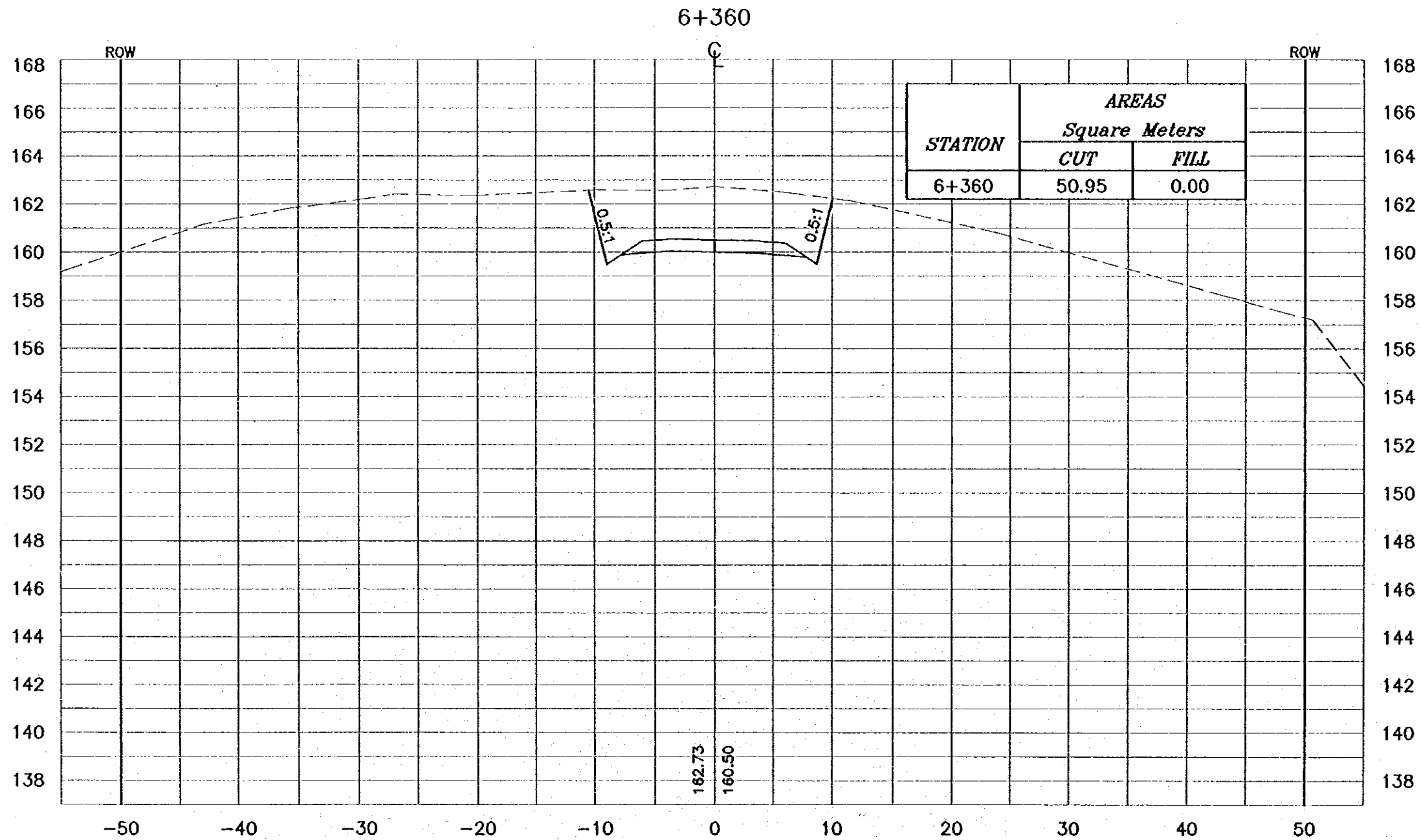
- * FOR EXACT HEIGHTS AND DIMENSIONS OF BENCHES SEE TYPICAL ROAD CROSS-SECTION .
- * SLOPE H : V .



Project:
Tourism Sector Development Project
in the Hashemite Kingdom of Jordan

Executing Agency:
The Ministry of Tourism and Antiquities
The Ministry of Planning

SUB-PROJECT:
Dead Sea Parkway

Note:
This detailed design has been executed by a team of consultants as shown below in accordance with the agreement between Japan International Cooperation Agency (JICA) and JICA Study Team. The copyright of this drawing rests with JICA.

Designed by:
Japan International Cooperation Agency (JICA)

JICA Study Team:
Joint Venture of Pacific Consultants International and Yamaoka Seikoku Inc.

Subcontracted Local Consultant:

 consolidated consultants
 engineering & environment
 Tel: 962277 - Fax: 962288 - Amman - Jordan

Drawing Title:
CROSS-SECTION
6+360

Scale: H 1:400 V 1:200 **Drawing No.:** 289

NOTES :

- * FOR EXACT HEIGHTS AND DIMENSIONS OF BENCHES SEE TYPICAL ROAD CROSS-SECTION .
- * SLOPE H : V .

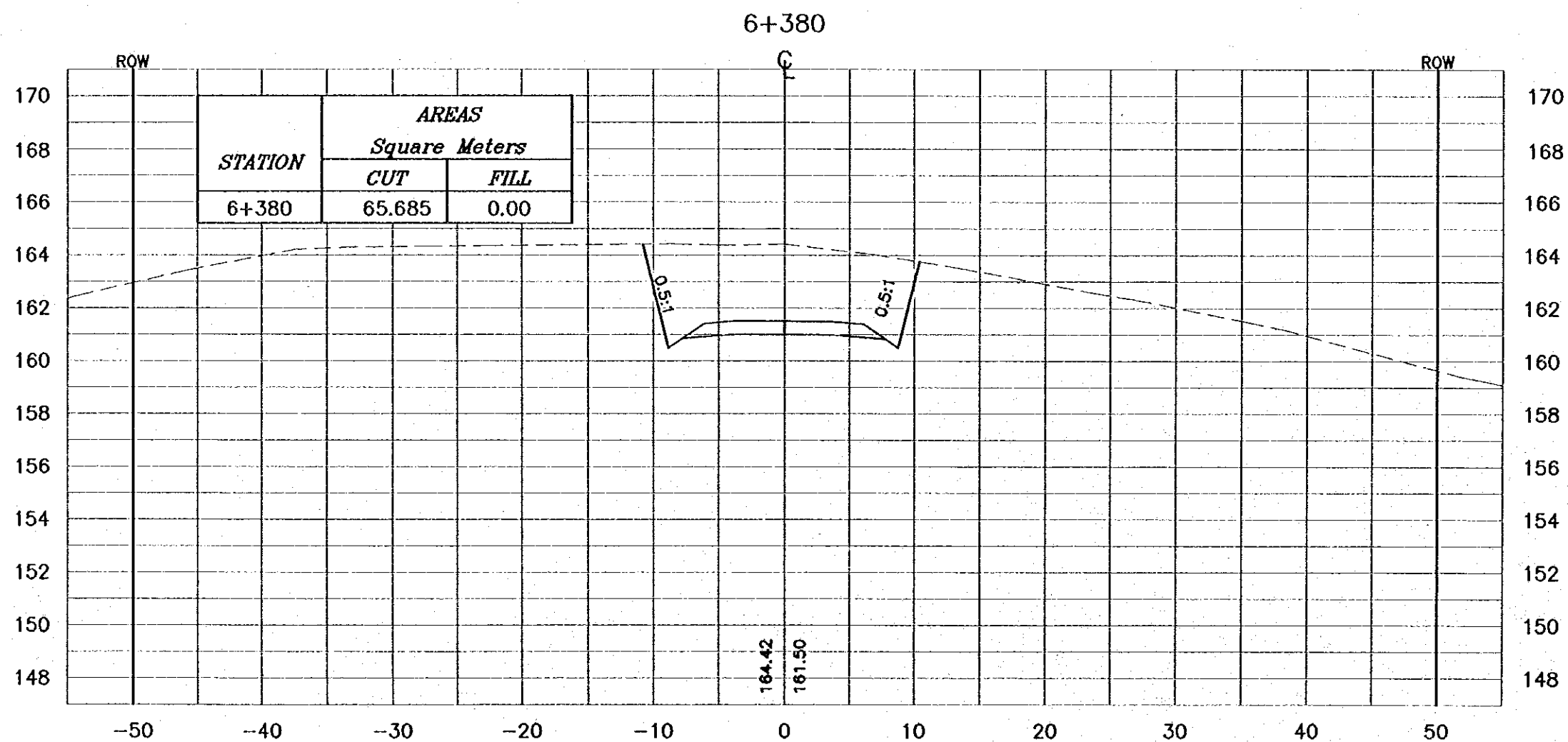
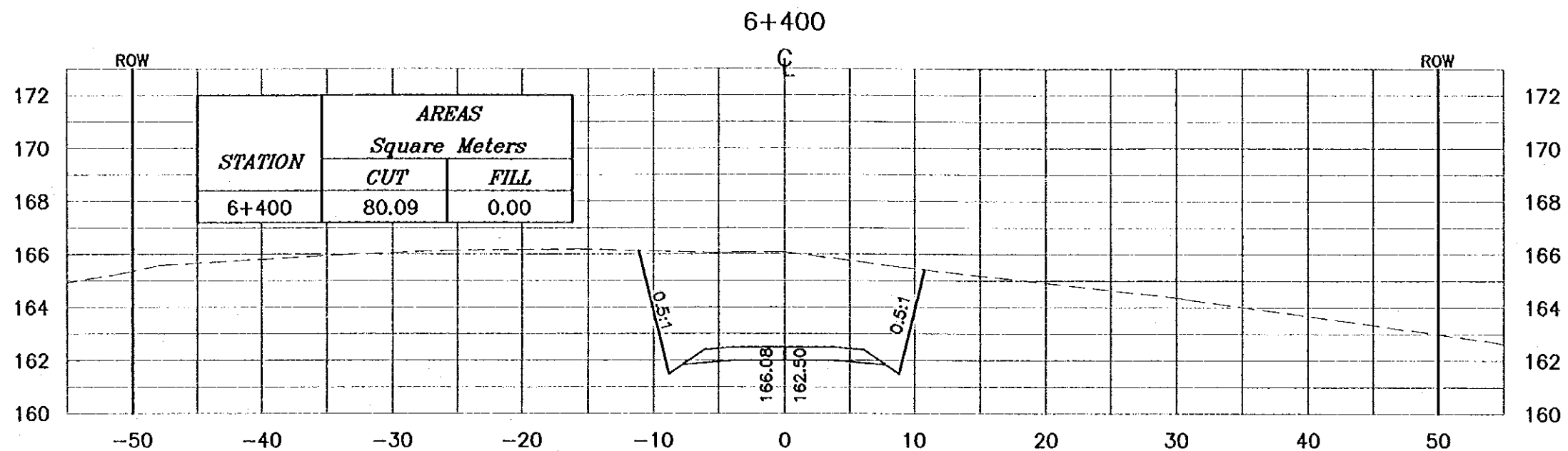

Project:
Tourism Sector Development Project
in the Hashemite Kingdom of Jordan

Executing Agency:
The Ministry of Tourism and Antiquities
The Ministry of Planning

SUB-PROJECT:
Dead Sea Parkway

Note:
This detailed design has been executed by
a team of consultants as shown below in
accordance with the agreement between
Japan International Cooperation Agency
(JICA) and JICA Study Team.
The copyright of this drawing rests with JICA.

Designed by:
Japan International Cooperation
Agency (JICA)

JICA Study Team:
Joint Venture of
Pacific Consultants International and
Yamashita Selski Inc.

Subcontracted Local Consultant:
 consolidated consultants
engineering & environment
Tel: 012377 - Fax: 012380 - AMMAN - JORDAN

Drawing Title:
CROSS-SECTION
6+380/6+400

Scale: H 1:400 V 1:200 **Drawing No.:** 290

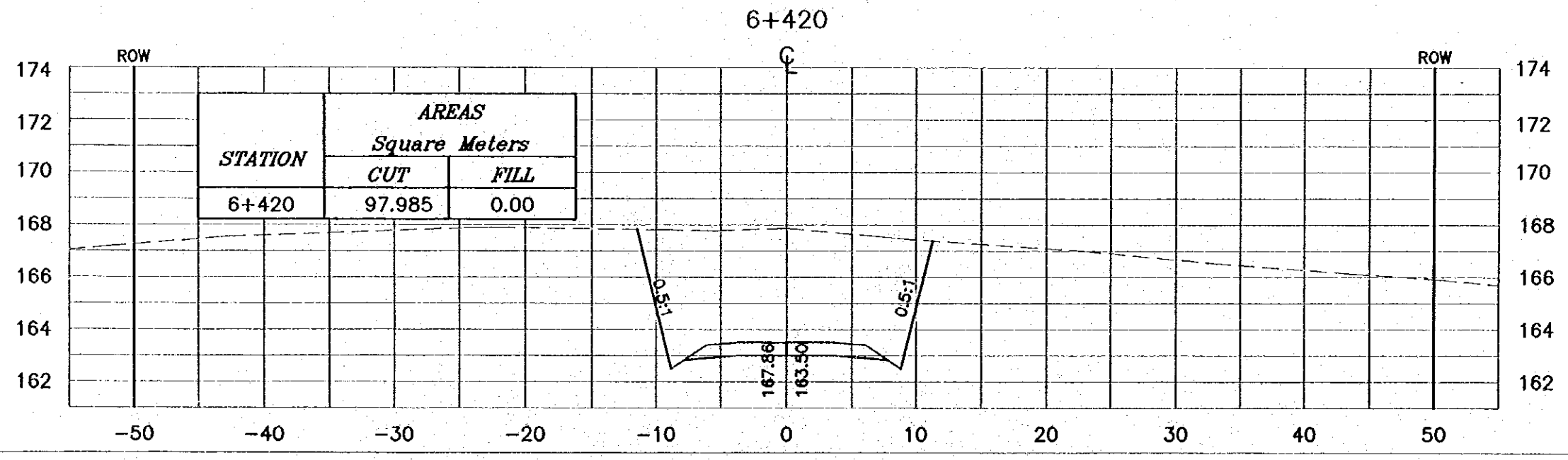
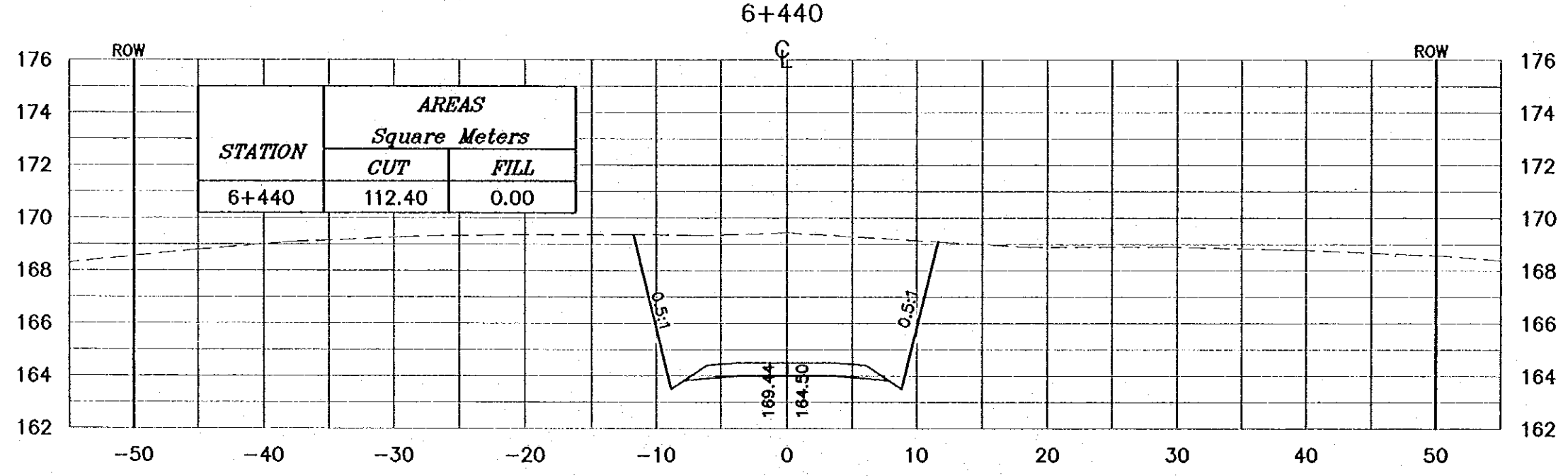
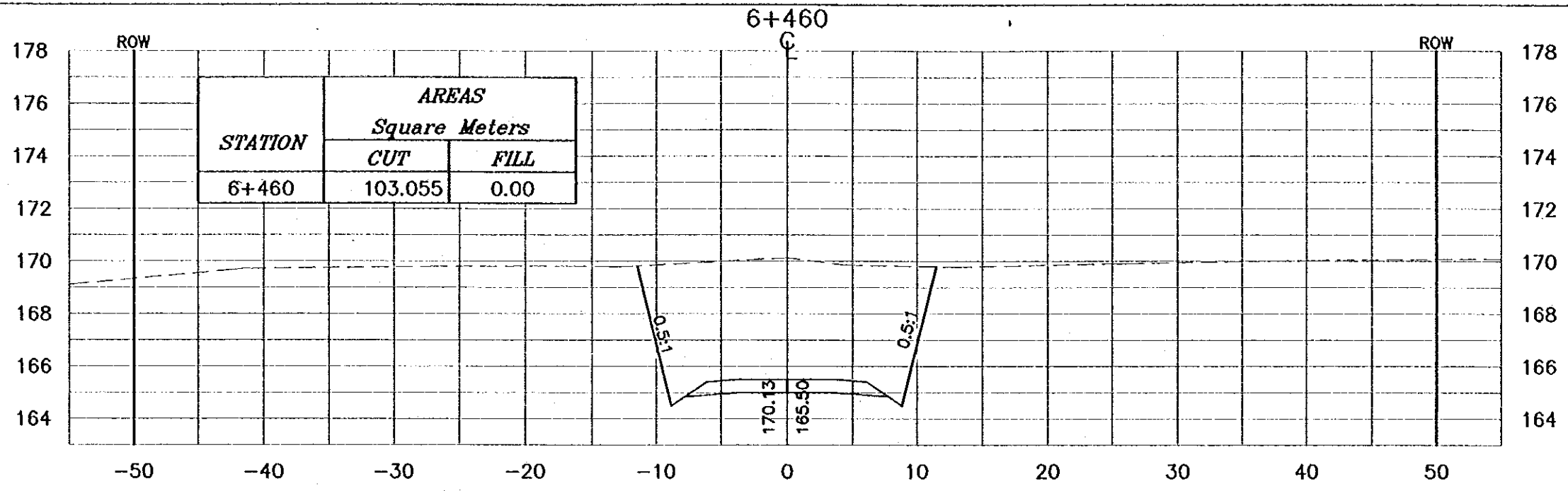

NOTES :
 * FOR EXACT HEIGHTS AND DIMENSIONS OF BENCHES SEE TYPICAL ROAD CROSS-SECTION .
 * SLOPE H : V .

Project:
 Tourism Sector Development Project
 in the Hashemite Kingdom of Jordan

Executing Agency:
 The Ministry of Tourism and Antiquities
 The Ministry of Planning

SUB-PROJECT:
 Dead Sea Parkway

Note:
 This detailed design has been executed by a team of consultants as shown below in accordance with the agreement between Japan International Cooperation Agency (JICA) and JICA Study Team. The copyright of this drawing rests with JICA.

Designed by:
 Japan International Cooperation Agency (JICA)

JICA Study Team:
 Joint Venture of Pacific Consultants International and Yamashita Seidai Inc.

Subcontracted Local Consultant:

 consolidated consultants
 ENGINEERING & ENVIRONMENT
 Tel. 0112277 - Fax 0112280 - AMMAN - JORDAN

Drawing Title:
 CROSS-SECTION
 6+420/6+440/6+460

Scale:
 H 1:400
 V 1:200

Drawing No.: 291

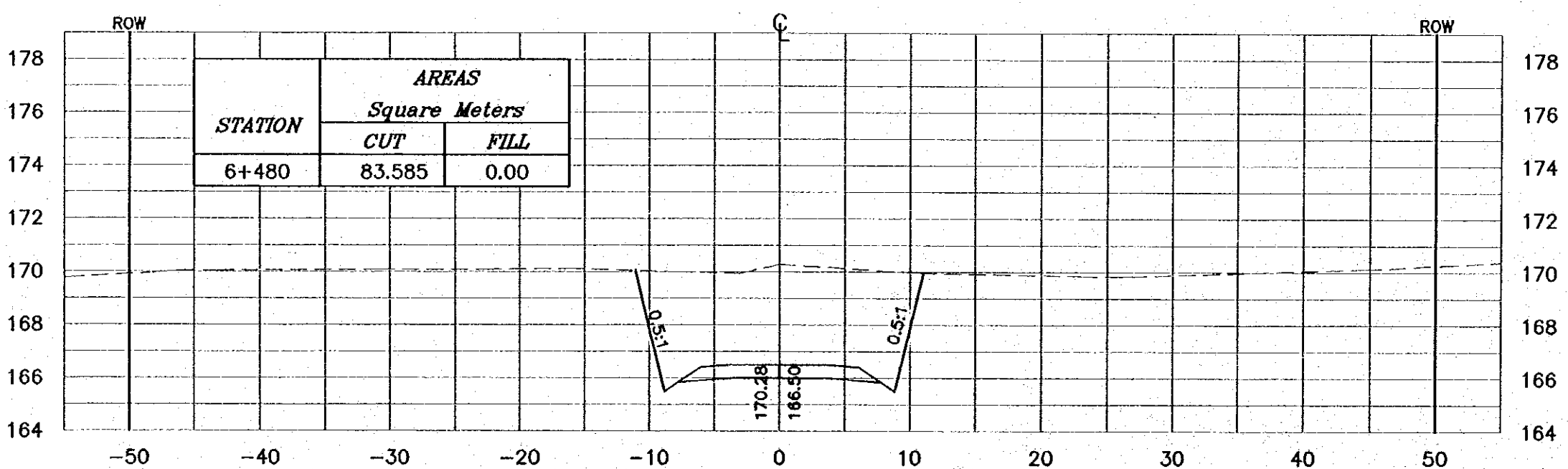
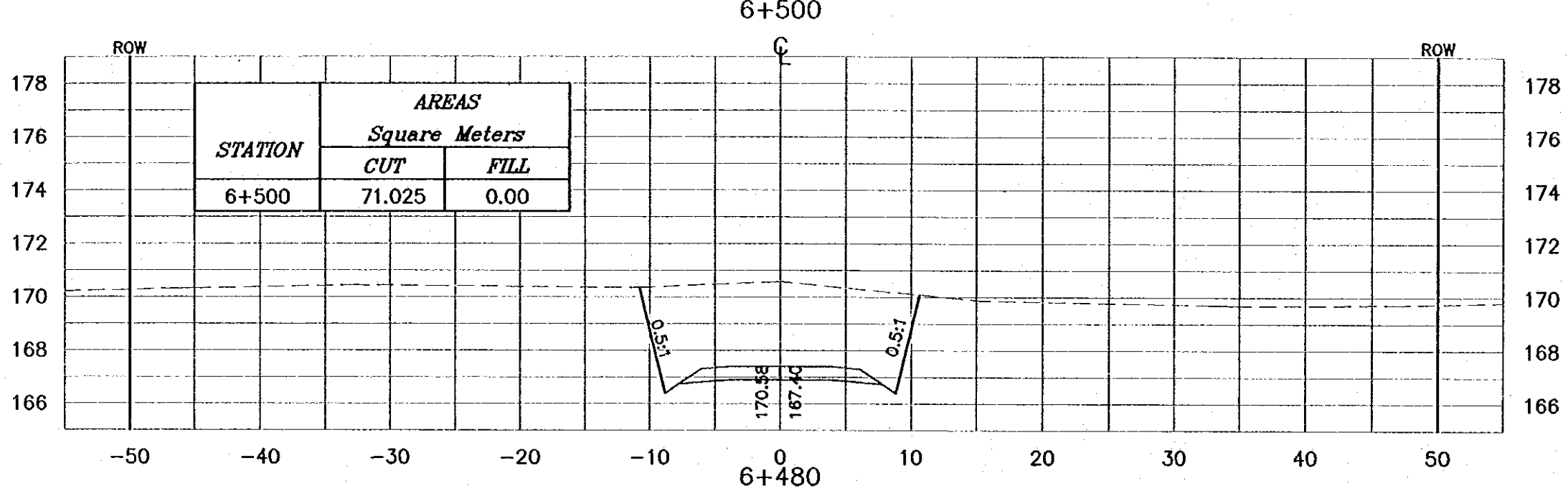
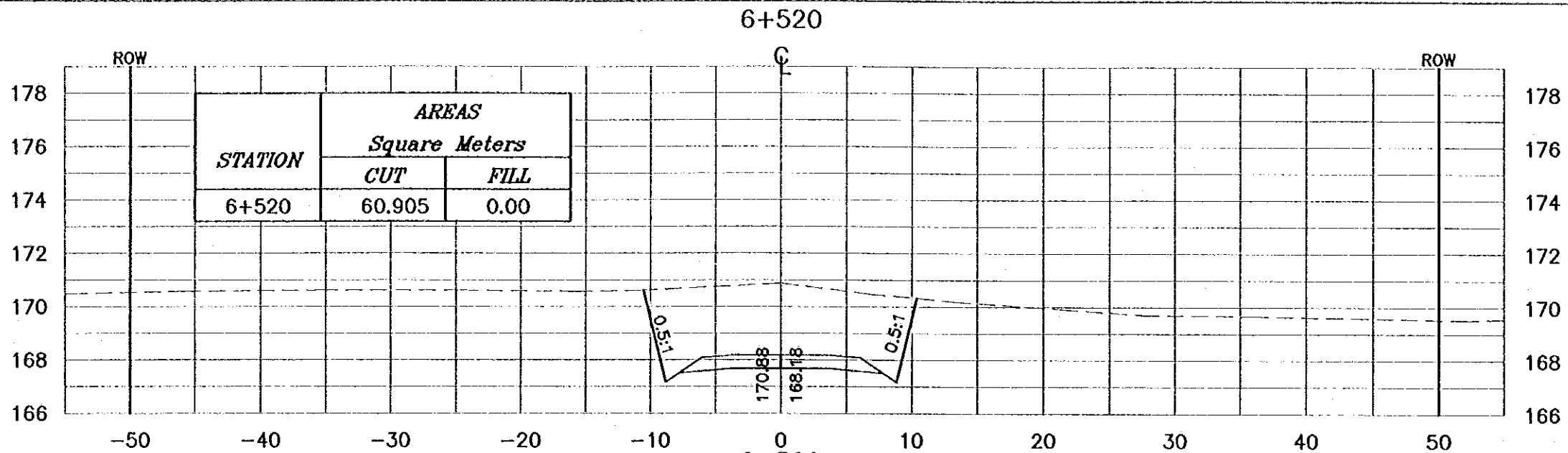

NOTES :

- * FOR EXACT HEIGHTS AND DIMENSIONS OF BENCHES SEE TYPICAL ROAD CROSS-SECTION .
- * SLOPE H : V .

Project:
Tourism Sector Development Project
in the Hashemite Kingdom of Jordan

Executing Agency:
The Ministry of Tourism and Antiquities
The Ministry of Planning

SUB-PROJECT:
Dead Sea Parkway

Note:
This detailed design has been executed by a team of consultants as shown below in accordance with the agreement between Japan International Cooperation Agency (JICA) and JICA Study Team. The copyright of this drawing rests with JICA.

Designed by:
Japan International Cooperation Agency (JICA)

JICA Study Team:
Joint Venture of
Pacific Consultants International and
Yamouita Sakkai Inc.

Subcontracted Local Consultants:

162 402277 - Fax: 402280 - JORDAN - AMMAN

Drawing Title:
CROSS-SECTION
6+480/6+500/6+520

Scale: H 1:400 V 1:200 **Drawing No.:** 292

NOTES :

- * FOR EXACT HEIGHTS AND DIMENSIONS OF BENCHES SEE TYPICAL ROAD CROSS-SECTION .
- * SLOPE H : V .

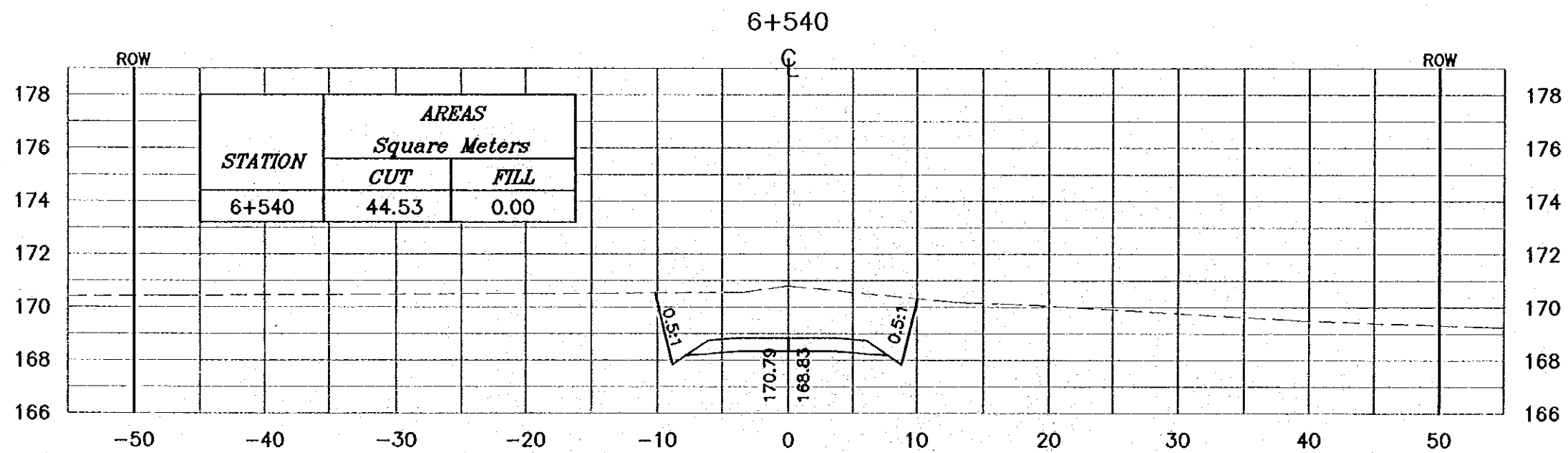
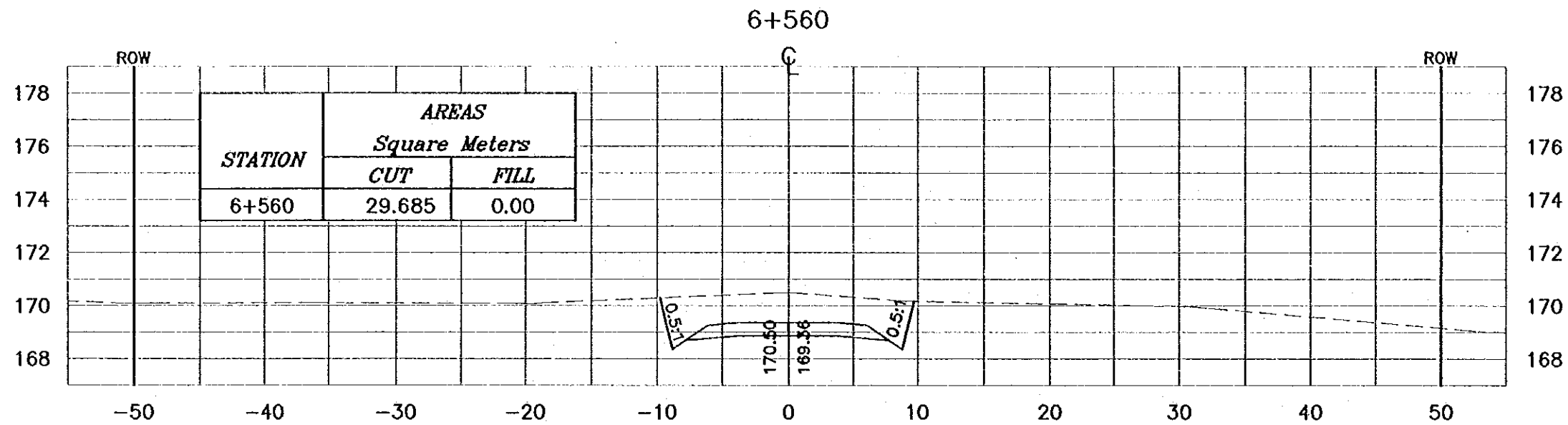

Project:
Tourism Sector Development Project
in the Hashemite Kingdom of Jordan

Executing Agency:
The Ministry of Tourism and Antiquities
The Ministry of Planning

SUB-PROJECT:
Dead Sea Parkway

Note:
This detailed design has been executed by
a team of consultants as shown below in
accordance with the agreement between
Japan International Cooperation Agency
(JICA) and JICA Study Team.
The copyright of this drawing rests with JICA.

Designed by:
Japan International Cooperation
Agency (JICA)

JICA Study Team:
Joint Venture of
Pacific Consultants International and
Yamashita Seldot Inc.

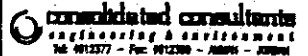
Subcontracted Local Consultant:

No. 912377 - Fax: 912388 - Amman - Jordan

Drawing Title:
CROSS-SECTION
6+540/6+560

Scale: H 1:400 Drawing No.: 293
V 1:200

NOTES :

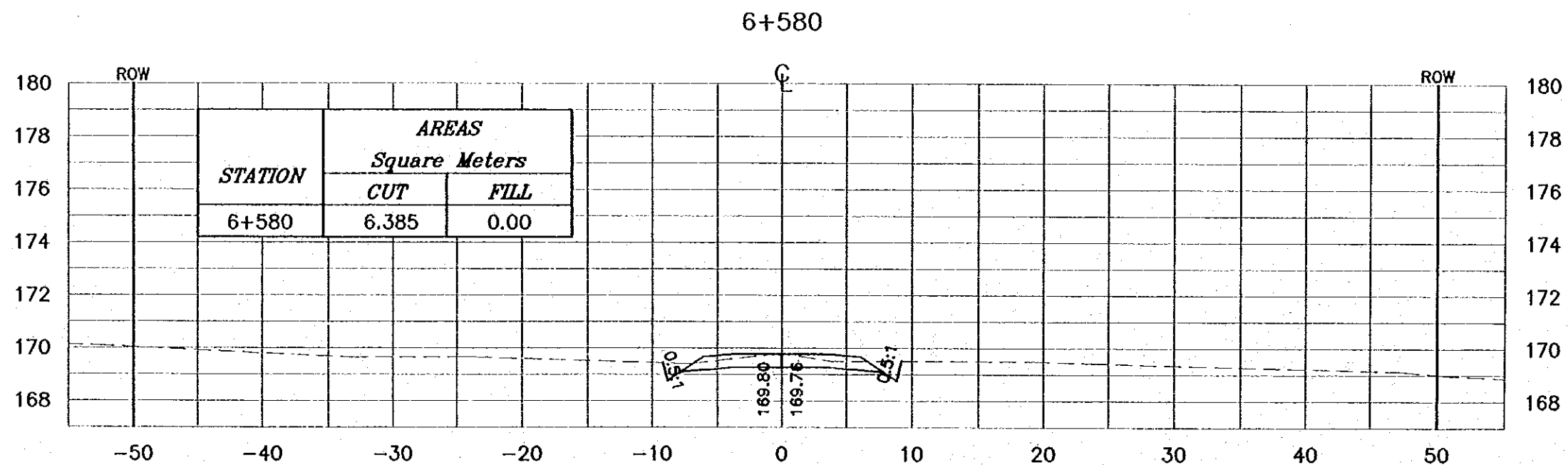
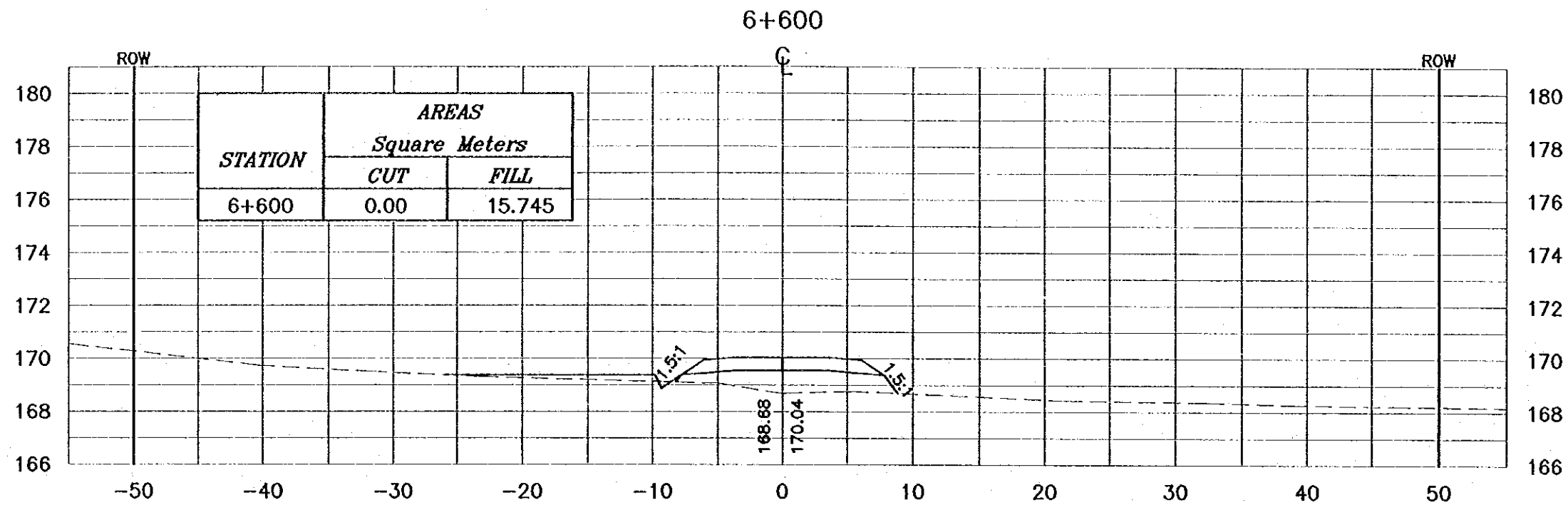
- * FOR EXACT HEIGHTS AND DIMENSIONS OF BENCHES SEE TYPICAL ROAD CROSS-SECTION .
- * SLOPE H : V .



Project:
Tourism Sector Development Project
in the Hashemite Kingdom of Jordan

Executing Agency:
The Ministry of Tourism and Antiquities
The Ministry of Planning

SUB-PROJECT:
Dead Sea Parkway

Note:
This detailed design has been executed by
a team of consultants as shown below in
accordance with the agreement between
Japan International Cooperation Agency
(JICA) and JICA Study Team.
The copyright of this drawing rests with JICA.

Designed by:
Japan International Cooperation
Agency (JICA)

JICA Study Team:
Joint Venture of
Pacific Consultants International and
Yamashita Seldel Inc.

Subcontracted Local Consultant:
 consolidated consultants
ENGINEERING & ENVIRONMENT
Tel: 0112277 - Fax: 0112280 - 88991 - JORDAN

Drawing Title:
CROSS-SECTION
6+580/6+600

Scale: H 1:400 V 1:200 **Drawing No.:** 294

NOTES :

- * FOR EXACT HEIGHTS AND DIMENSIONS OF BENCHES SEE TYPICAL ROAD CROSS-SECTION .
- * SLOPE H : V .

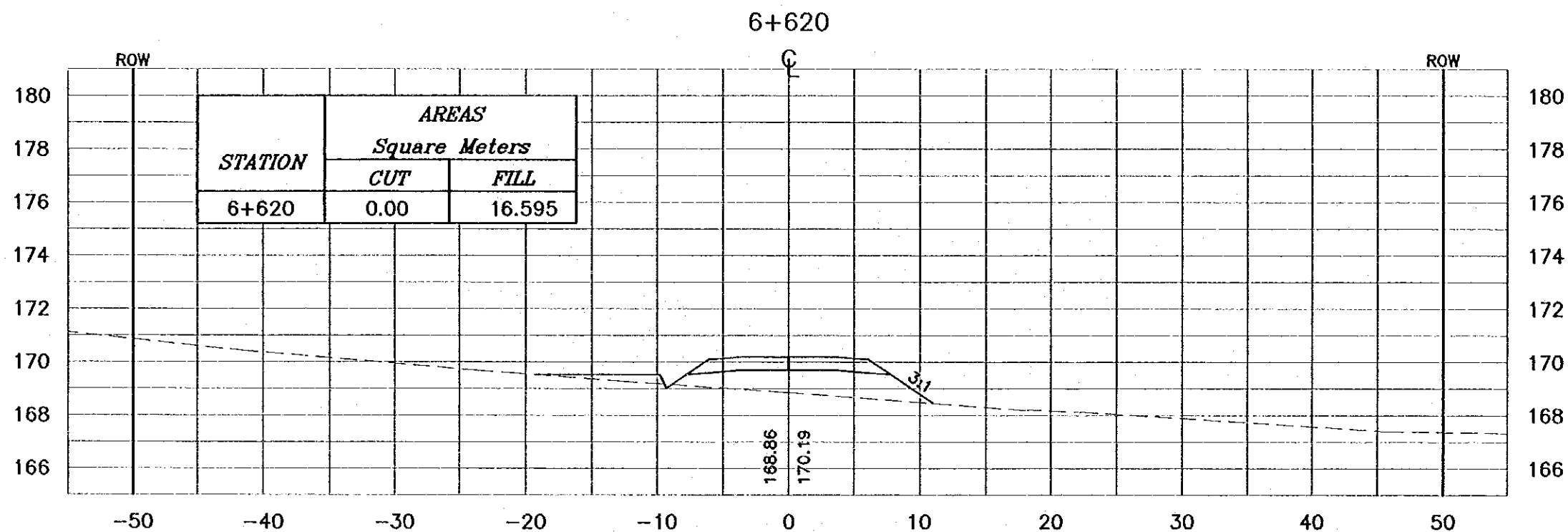

Project:
Tourism Sector Development Project
in the Hashemite Kingdom of Jordan

Executing Agency:
The Ministry of Tourism and Antiquities
The Ministry of Planning

SUB-PROJECT:
Dead Sea Parkway

Note:
This detailed design has been executed by
a team of consultants as shown below in
accordance with the agreement between
Japan International Cooperation Agency
(JICA) and JICA Study Team.
The copyright of this drawing rests with JICA.

Designed by:
Japan International Cooperation
Agency (JICA)

JICA Study Team:
Joint Venture of
Pacifica Consultants International and
Yamashita Seidai Inc.

Subcontracted Local Consultant:

consolidated consultants
engineering & environment
Tel: 0112277 - Fax: 0112280 - Amman - Jordan

Drawing Title:
CROSS-SECTION
6+620

Scale: H 1:400 V 1:200 **Drawing No.:** 295

NOTES :

- * FOR EXACT HEIGHTS AND DIMENSIONS OF BENCHES SEE TYPICAL ROAD CROSS-SECTION .
- * SLOPE H : V .

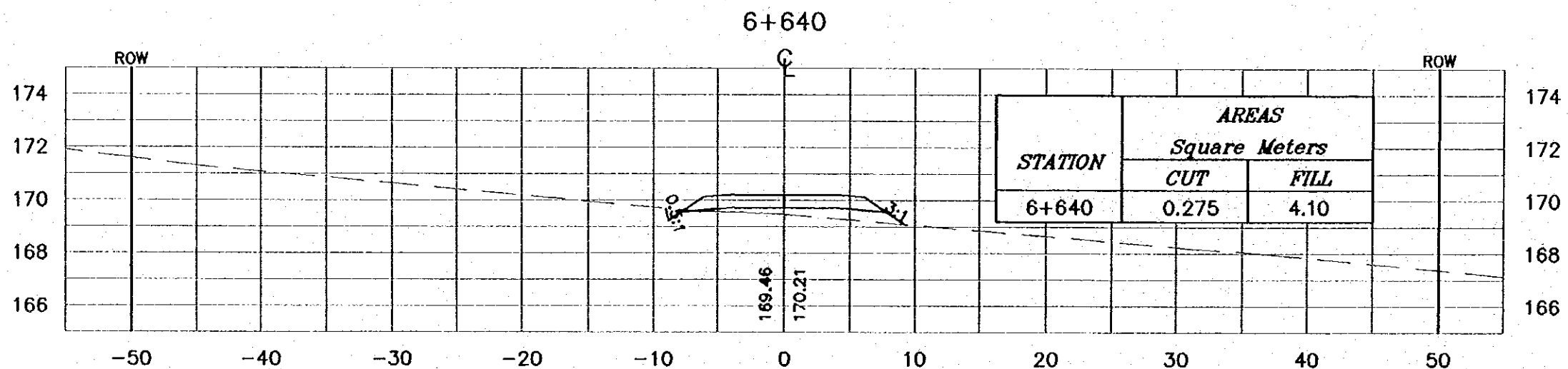
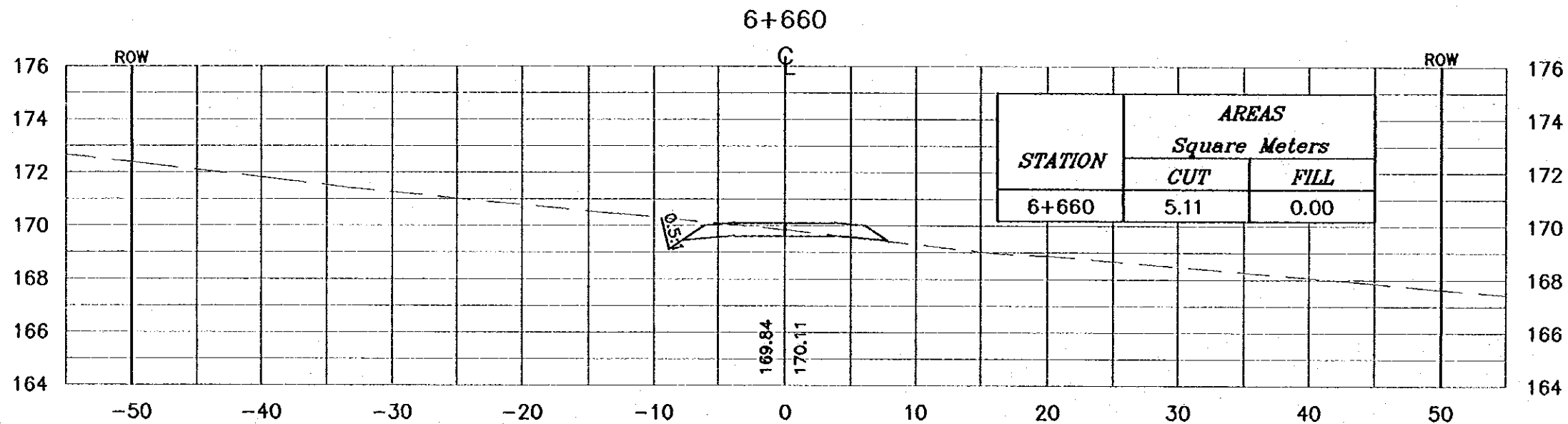
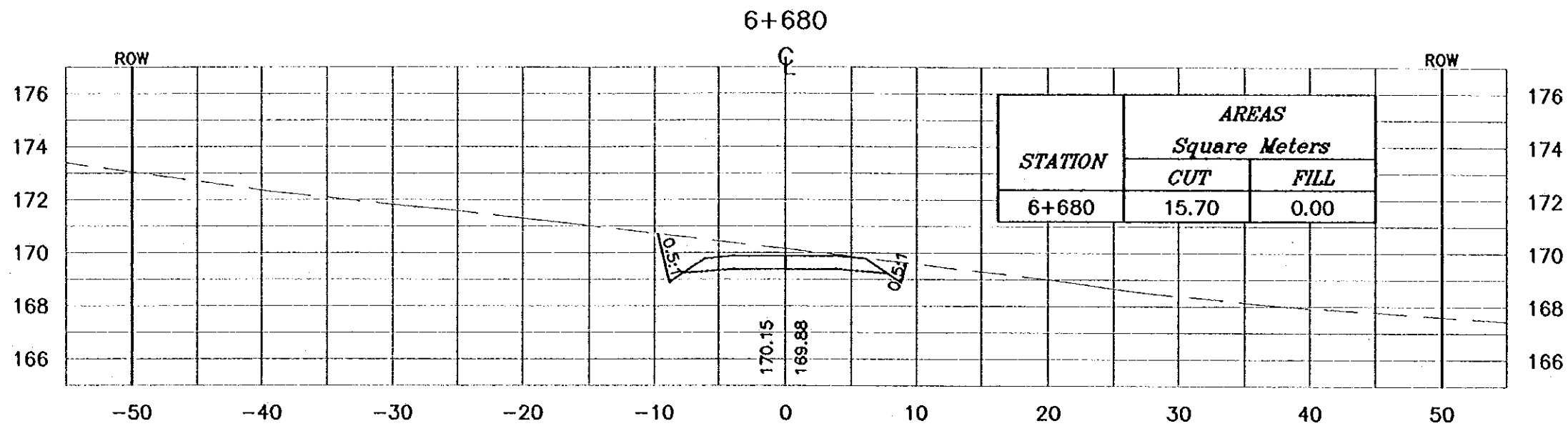

Project:
Tourism Sector Development Project
in the Hashemite Kingdom of Jordan

Executing Agency:
The Ministry of Tourism and Antiquities
The Ministry of Planning

SUB-PROJECT:
Dead Sea Parkway

Note:
This detailed design has been executed by
a team of consultants as shown below in
accordance with the agreement between
Japan International Cooperation Agency
(JICA) and JICA Study Team.
The copyright of this drawing rests with JICA.

Designed by:
Japan International Cooperation
Agency (JICA)

JICA Study Team:
Joint Venture of
Pacific Consultants International and
Yamashita Seikou Inc.

Subcontracted Local Consultant:

consolidated consultants
engineering & construction
Tel: 962277 - Fax: 962280 - Amman - Jordan

Drawing Title:
CROSS-SECTION
6+640/6+660/6+680

Scale:
H 1:400
V 1:200

Drawing No.: 296

NOTES :

- * FOR EXACT HEIGHTS AND DIMENSIONS OF BENCHES SEE TYPICAL ROAD CROSS-SECTION .
- * SLOPE H : V .

Project:
Tourism Sector Development Project
in the Hashemite Kingdom of Jordan

Executing Agency:
The Ministry of Tourism and Antiquities
The Ministry of Planning

SUB-PROJECT:
Dead Sea Parkway

Note:
This detailed design has been executed by a team of consultants as shown below in accordance with the agreement between Japan International Cooperation Agency (JICA) and JICA Study Team.
The copyright of this drawing rests with JICA.

Designed by:
Japan International Cooperation Agency (JICA)

JICA Study Team:
Joint Venture of Pacific Consultants International and Yamashita Seki Inc.

Subcontracted Local Consultant:
consolidated consultants
engineering & environment
1st floor - P.O. Box 992288 - Amman - Jordan

Drawing Title:
CROSS-SECTION
6+700/6+720/6+740

Scale: H 1:400 V 1:200 Drawing No.: 297

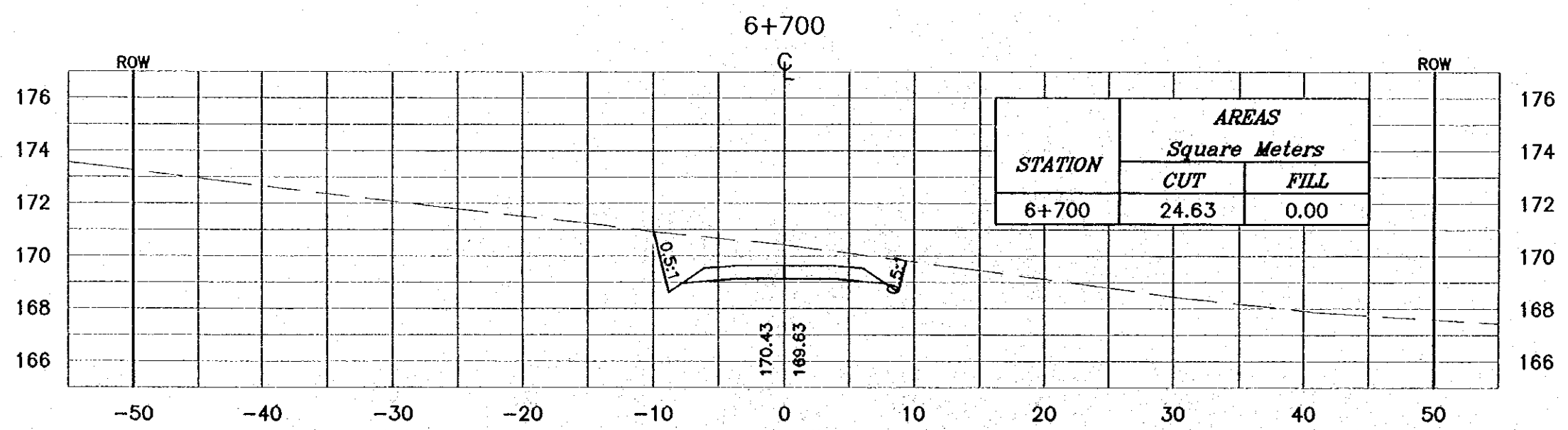
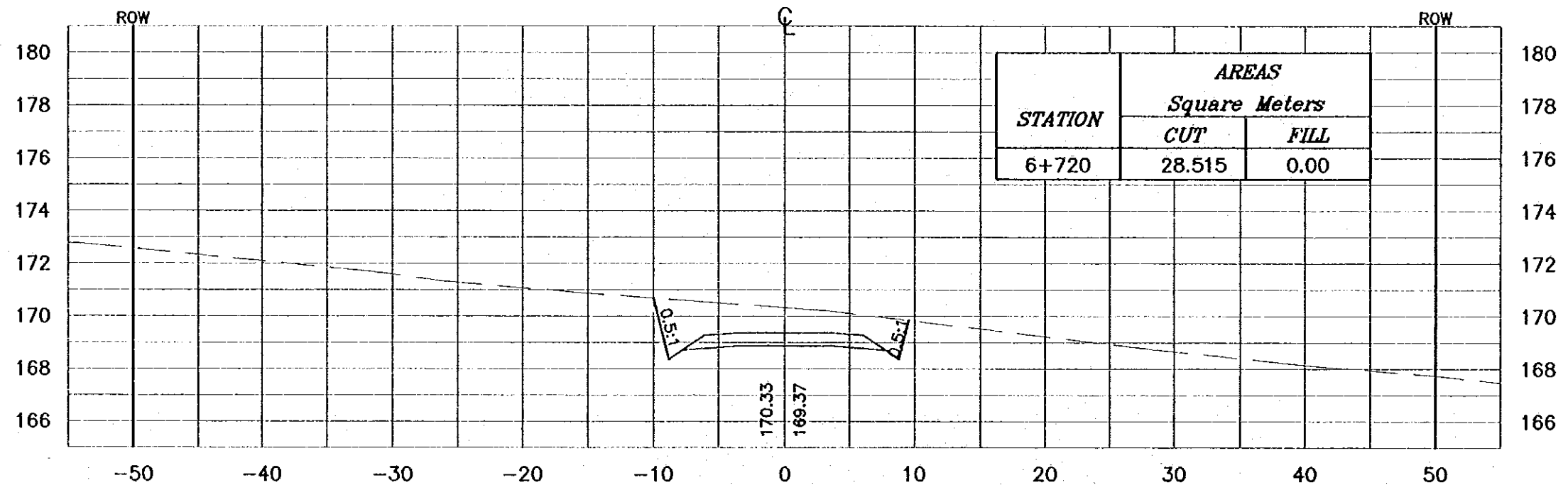
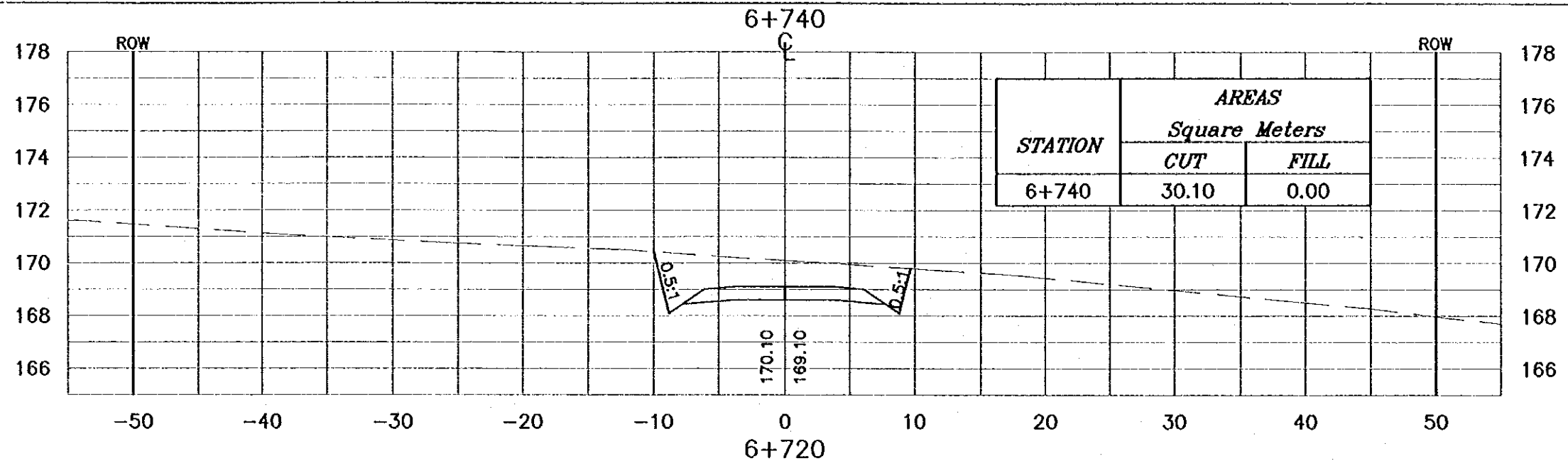

NOTES :

- * FOR EXACT HEIGHTS AND DIMENSIONS OF BENCHES SEE TYPICAL ROAD CROSS-SECTION .
- * SLOPE H : V .

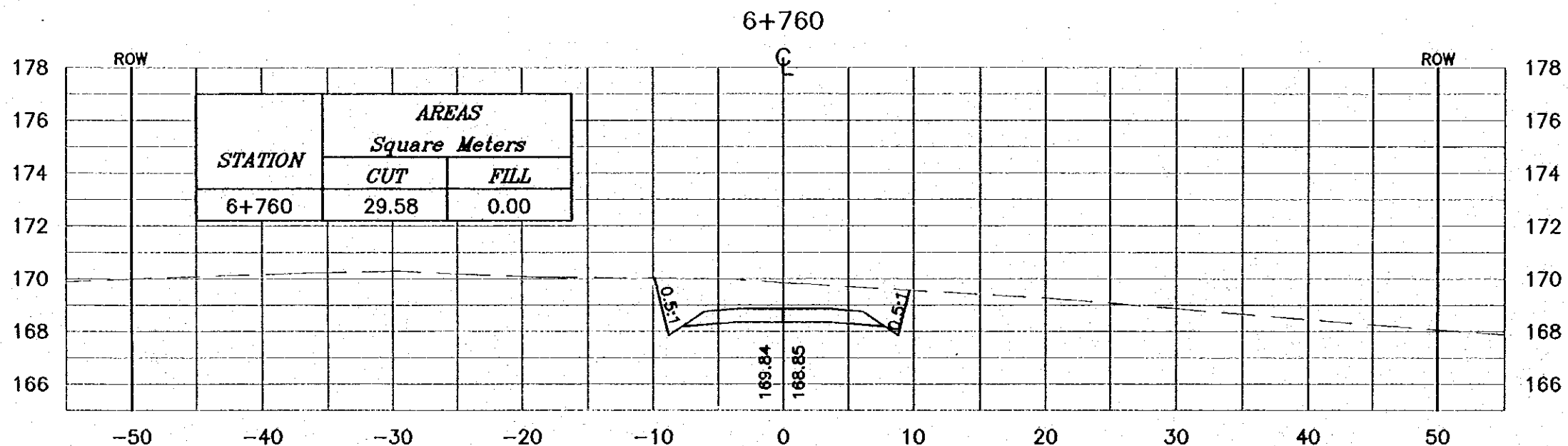
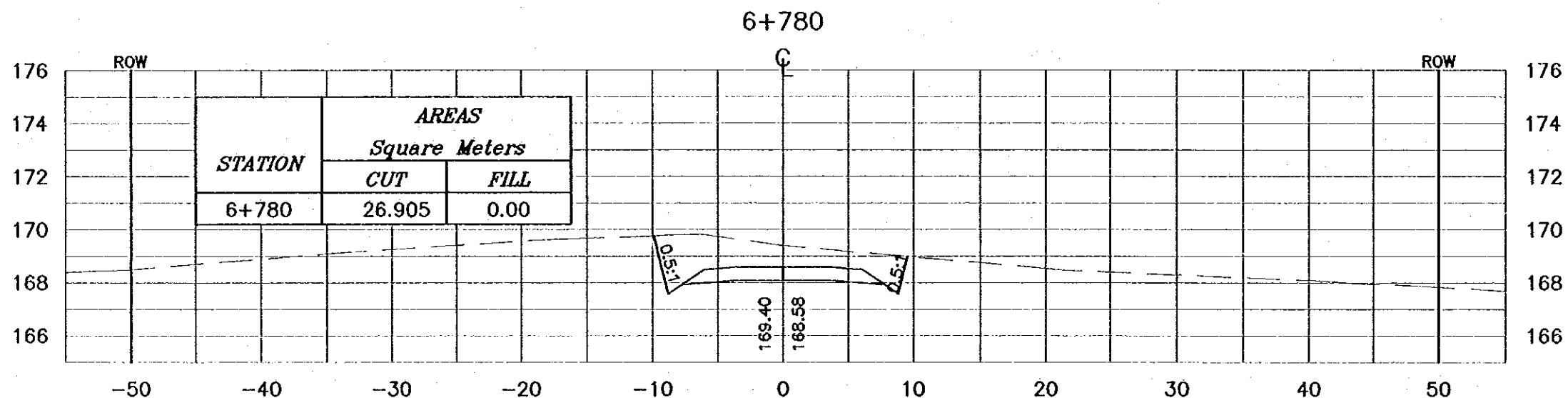
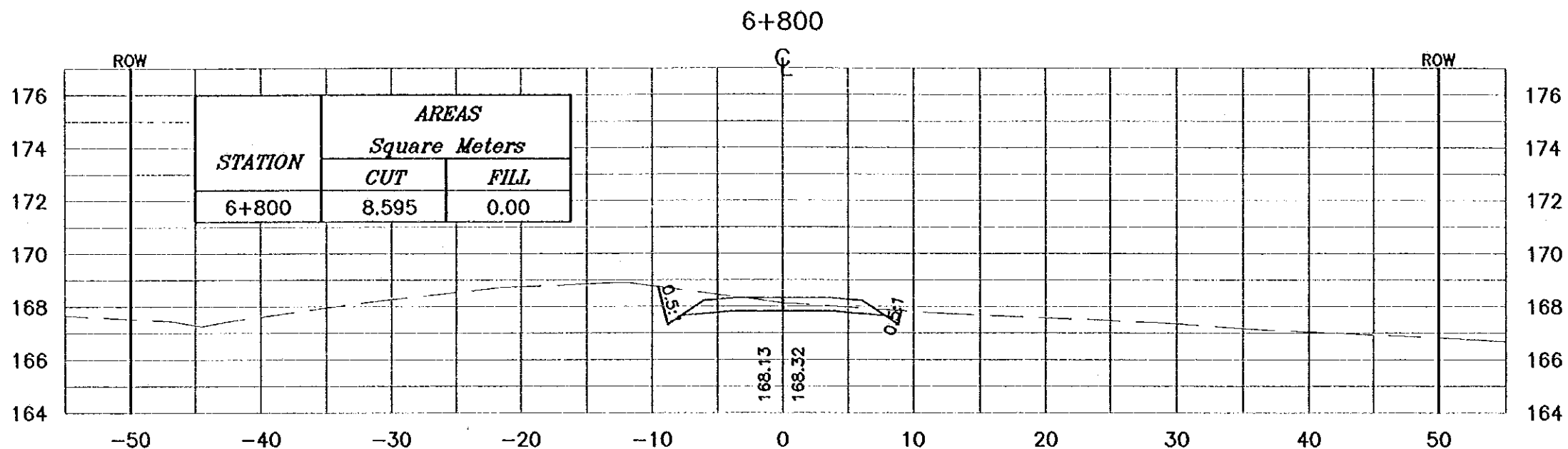

Project:
Tourism Sector Development Project
in the Hashemite Kingdom of Jordan

Executing Agency:
The Ministry of Tourism and Antiquities
The Ministry of Planning

SUB-PROJECT:
Dead Sea Parkway

Note:
This detailed design has been executed by
a team of consultants as shown below in
accordance with the agreement between
Japan International Cooperation Agency
(JICA) and JICA Study Team.
The copyright of this drawing rests with JICA.

Designed by:
Japan International Cooperation
Agency (JICA)

JICA Study Team:
Joint Venture of
Pacific Consultants International and
Yamashita Sekido Inc.

Subcontracted Local Consultant:
 consolidated consultants
engineering & environment
Tel: 9912577 - Fax: 9912588 - JORDAN - AMMAN

Drawing Title:
CROSS-SECTION
6+760/6+780/6+800

Scale:
H 1:400
V 1:200

Drawing No.: 298

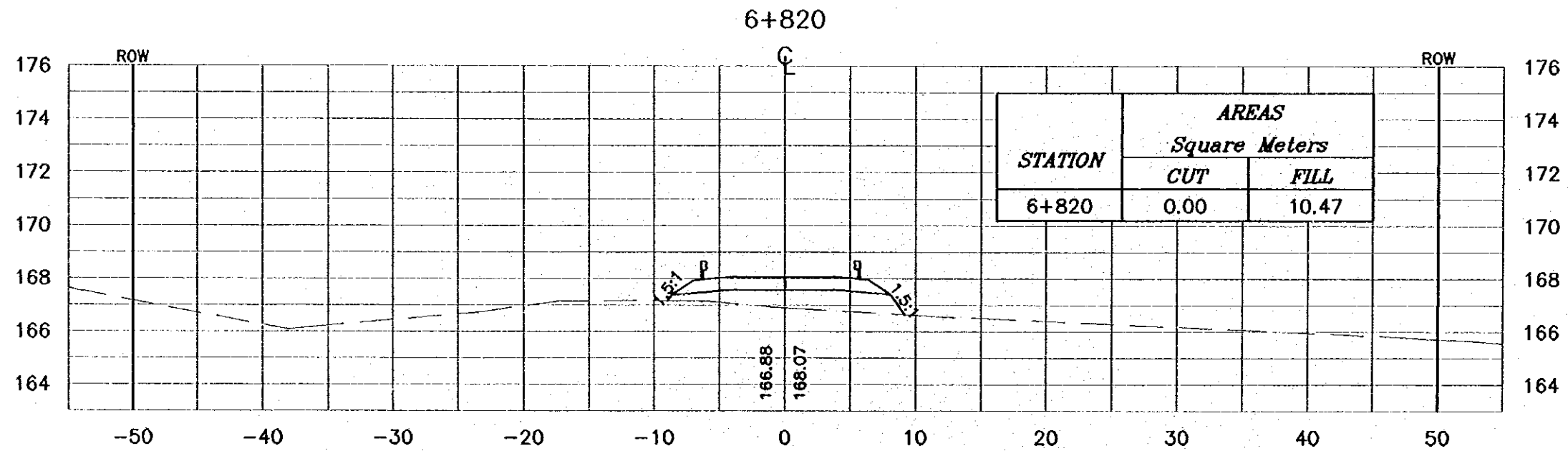
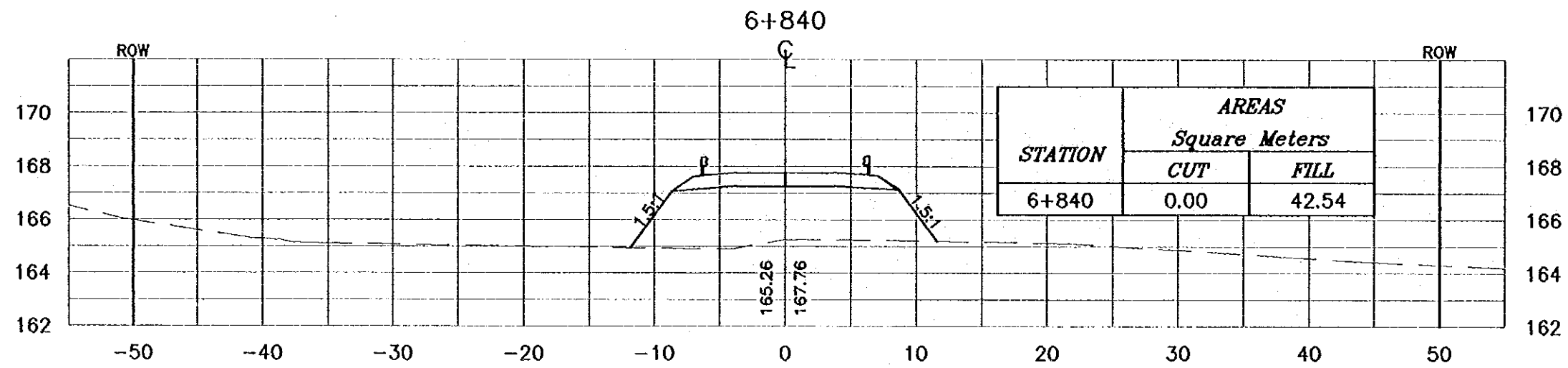
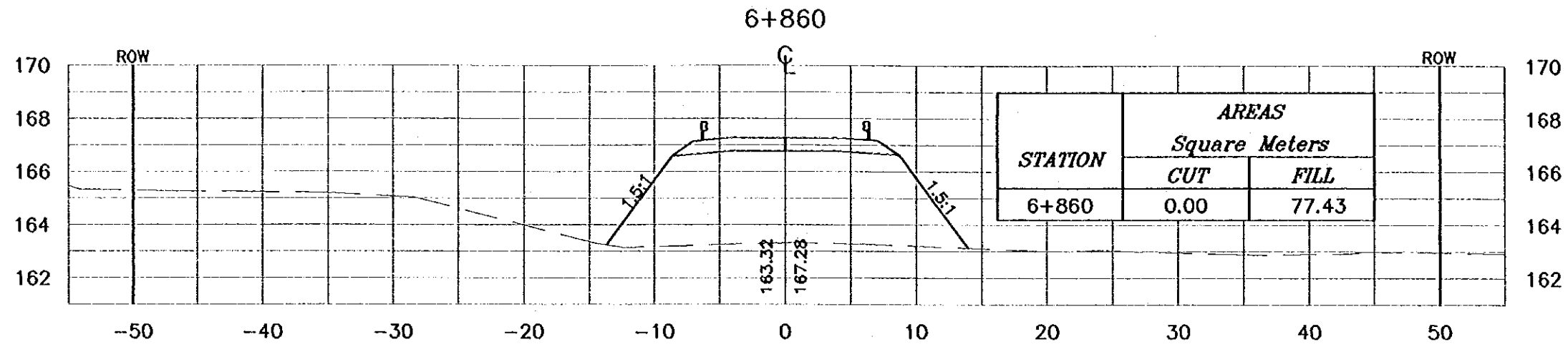

NOTES :

- * FOR EXACT HEIGHTS AND DIMENSIONS OF BENCHES SEE TYPICAL ROAD CROSS-SECTION .
- * SLOPE H : V .

Project:
Tourism Sector Development Project
in the Hashemite Kingdom of Jordan

Executing Agency:
The Ministry of Tourism and Antiquities
The Ministry of Planning

SUB-PROJECT:
Dead Sea Parkway

Note:
This detailed design has been executed by a team of consultants as shown below in accordance with the agreement between Japan International Cooperation Agency (JICA) and JICA Study Team.
The copyright of this drawing rests with JICA.

Designed by:
Japan International Cooperation Agency (JICA)

JICA Study Team:
Joint Venture of Pacific Consultants International and Yamashita Seki Inc.

Subcontracted Local Consultant:
 consolidated consultants
engineering & architecture
Tel: 4912377 - Fax: 4912388 - Beirut - JORDAN

Drawing Title:
CROSS-SECTION
6+820/6+840/6+860

Scale: H 1:400 V 1:200 Drawing No.: 299

NOTES :

- * FOR EXACT HEIGHTS AND DIMENSIONS OF BENCHES SEE TYPICAL ROAD CROSS-SECTION .
- * SLOPE H : V .

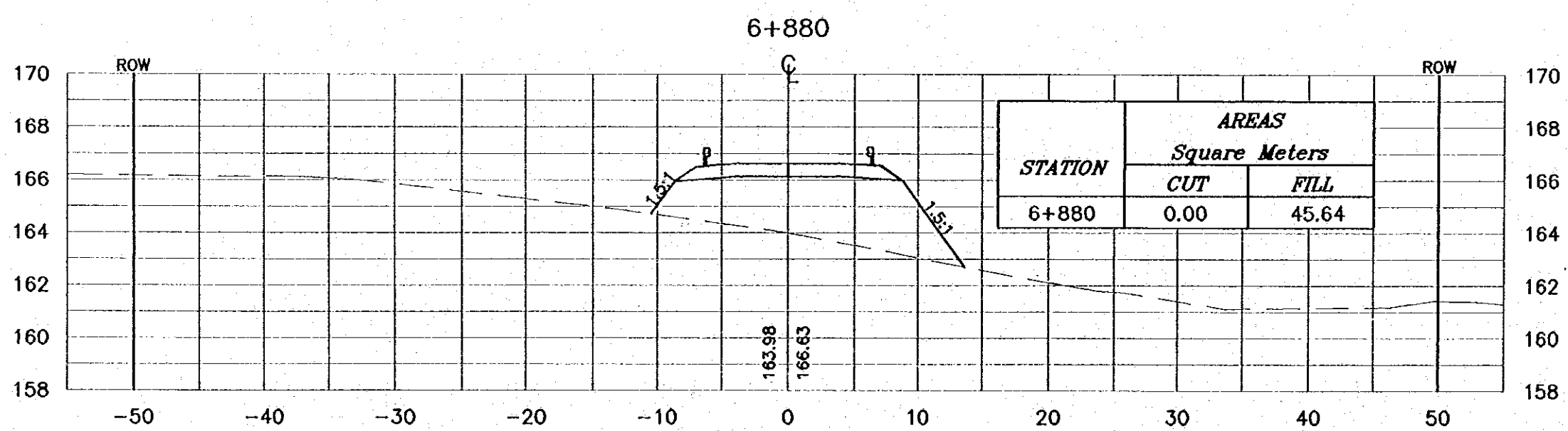
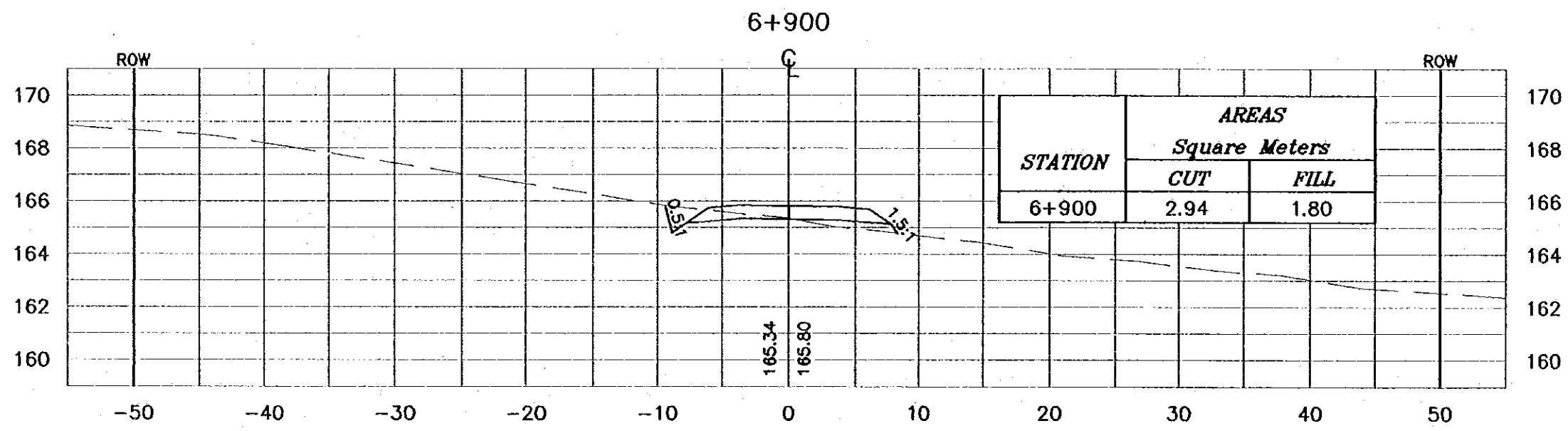
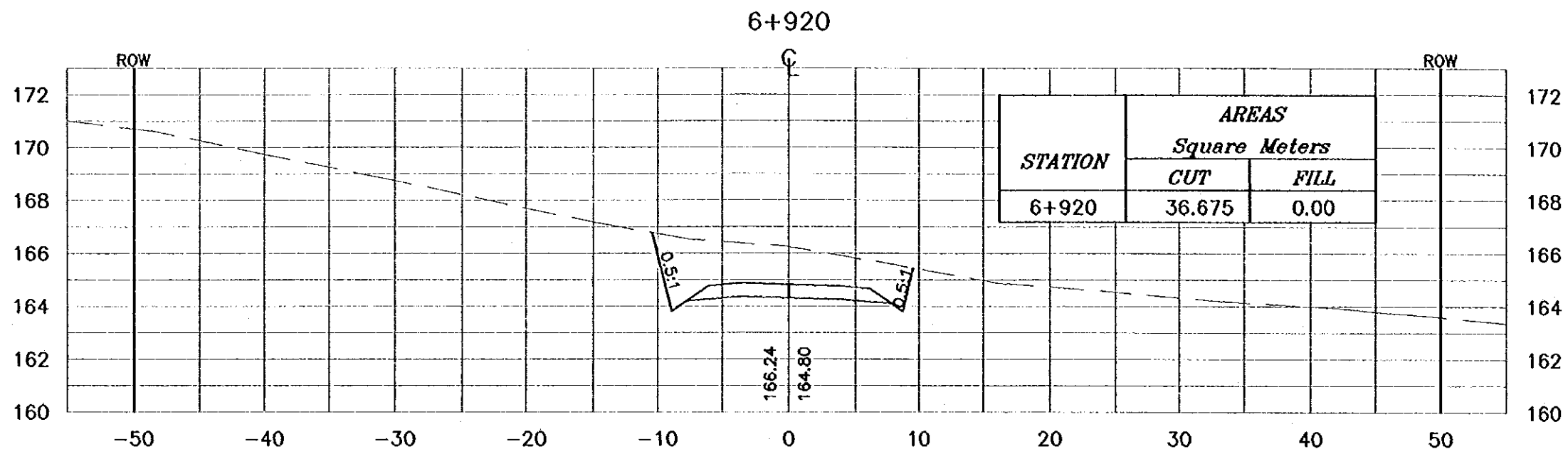

Project:
Tourism Sector Development Project
in the Hashemite Kingdom of Jordan

Executing Agency:
The Ministry of Tourism and Antiquities
The Ministry of Planning

SUB-PROJECT:
Dead Sea Parkway

Note:
This detailed design has been executed by a team of consultants as shown below in accordance with the agreement between Japan International Cooperation Agency (JICA) and JICA Study Team. The copyright of this drawing rests with JICA.

Designed by:
Japan International Cooperation Agency (JICA)

JICA Study Team:
Joint Venture of Pacific Consultants International and Yamashita Seki Co. Inc.

Subcontracted Local Consultant:
 consolidated consultants
engineering & environment
Tel: 4612377 - Fax: 4612388 - JORDAN - JORDAN

Drawing Title:
CROSS-SECTION
6+880/6+900/6+920

Scale: H 1:400 V 1:200 **Drawing No.:** 300

NOTES :

- * FOR EXACT HEIGHTS AND DIMENSIONS OF BENCHES SEE TYPICAL ROAD CROSS-SECTION .
- * SLOPE H : V .

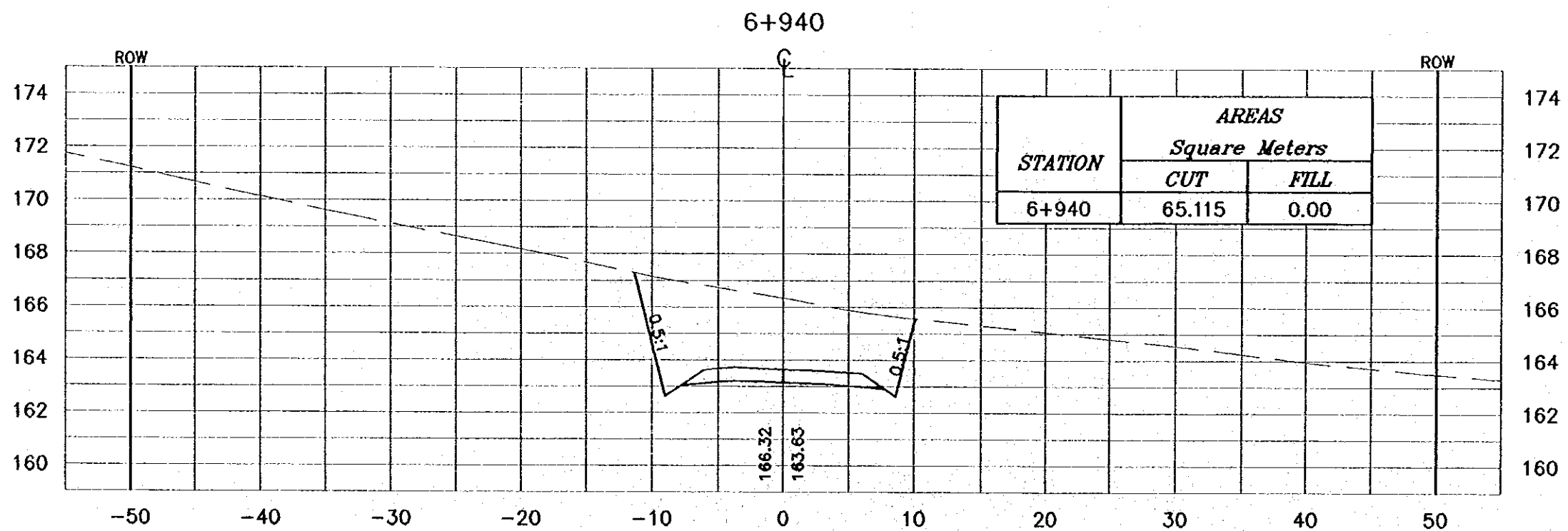
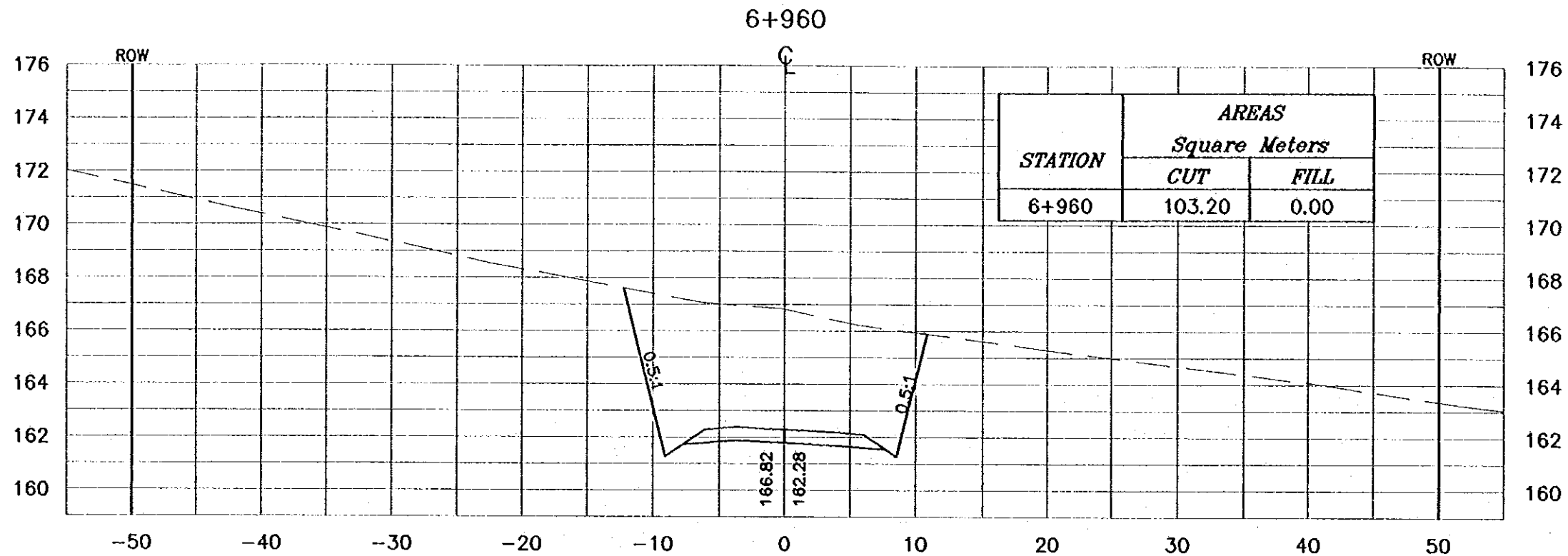

Project:
Tourism Sector Development Project
in the Hashemite Kingdom of Jordan

Executing Agency:
The Ministry of Tourism and Antiquities
The Ministry of Planning

SUB-PROJECT:
Dead Sea Parkway

Note:
This detailed design has been executed by a team of consultants as shown below in accordance with the agreement between Japan International Cooperation Agency (JICA) and JICA Study Team. The copyright of this drawing rests with JICA.

Designed by:
Japan International Cooperation Agency (JICA)

JICA Study Team:
Joint Venture of Pacific Consultants International and Yamashita Seiki Inc.

Subcontracted Local Consultant:
 consolidated consultants
engineering & environment
TA 01237 - Fax 01238 - AMM - JORDAN

Drawing Title:
CROSS-SECTION
6+940/6+960

Scale: H 1:400 V 1:200 **Drawing No.:** 301

NOTES :

* FOR EXACT HEIGHTS AND DIMENSIONS OF BENCHES SEE TYPICAL ROAD CROSS-SECTION .

* SLOPE H : V .

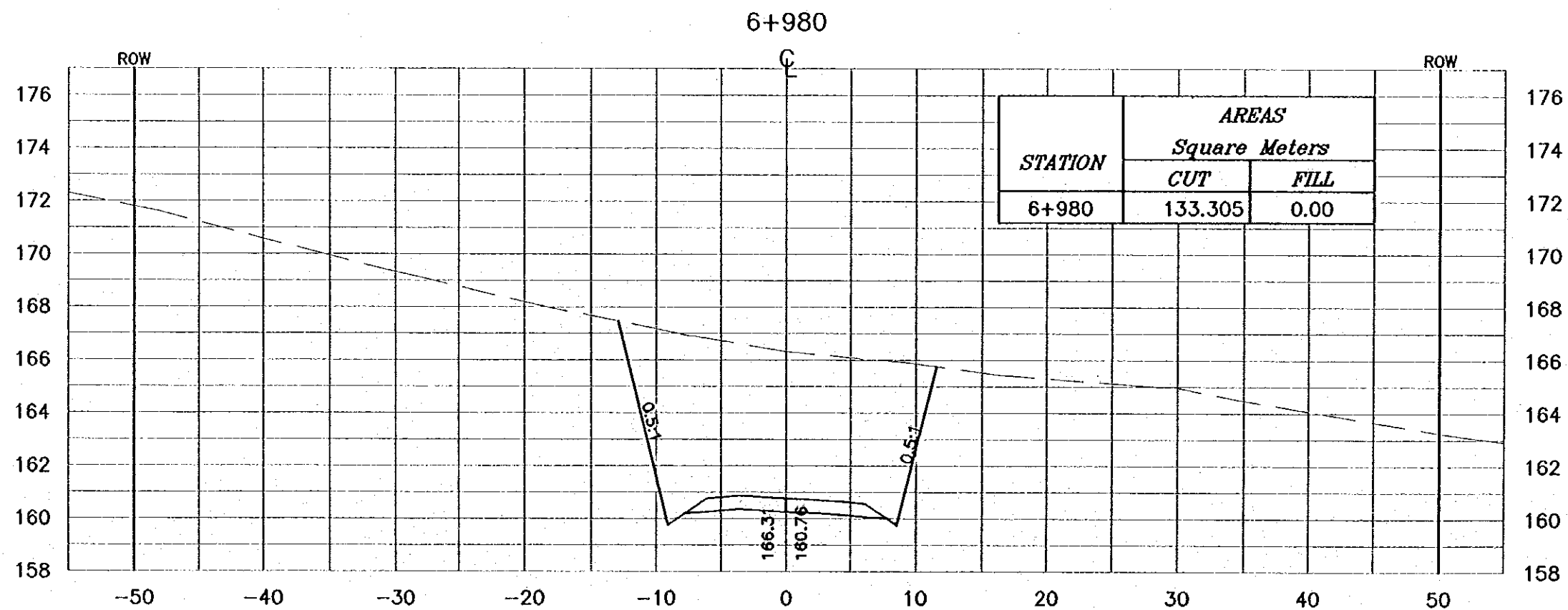
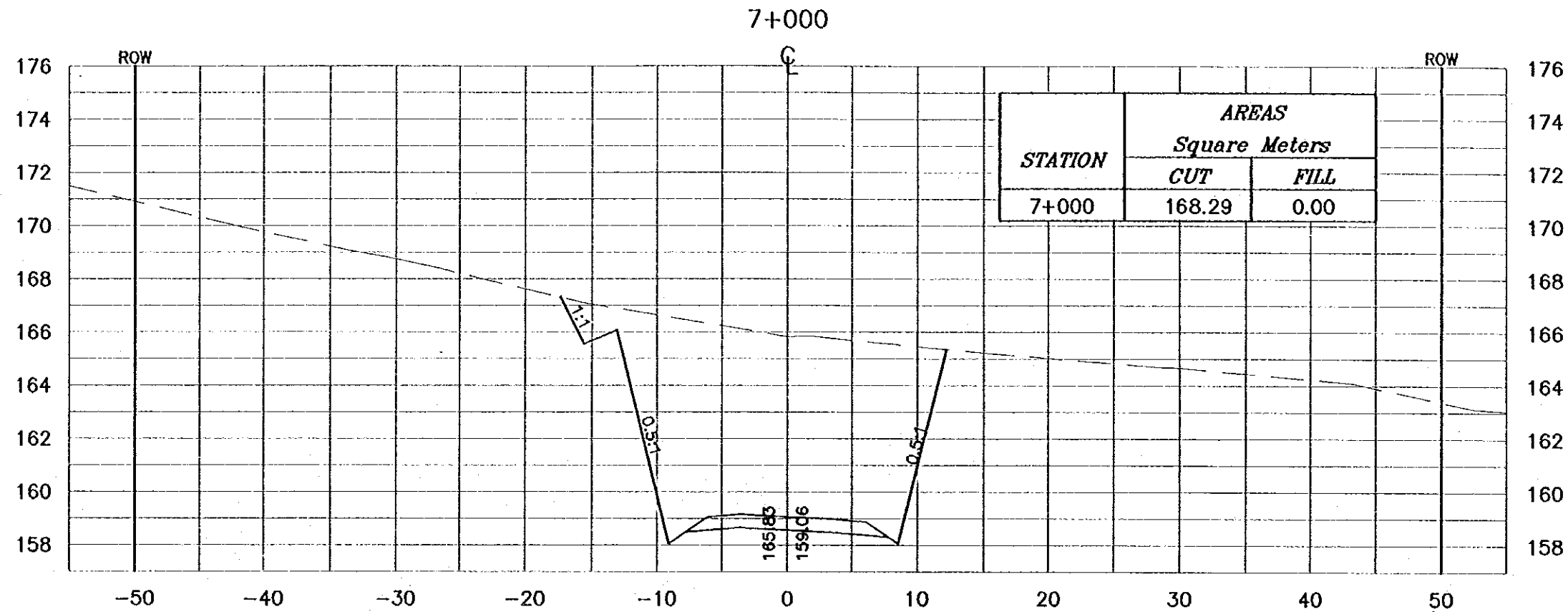

Project:
Tourism Sector Development Project
in the Hashemite Kingdom of Jordan

Executing Agency:
The Ministry of Tourism and Antiquities
The Ministry of Planning

SUB-PROJECT:
Dead Sea Parkway

Note:
This detailed design has been executed by
a team of consultants as shown below in
accordance with the agreement between
Japan International Cooperation Agency
(JICA) and JICA Study Team.
The copyright of this drawing rests with JICA.

Designed by:
Japan International Cooperation
Agency (JICA)

JICA Study Team:
Joint Venture of
Pacific Consultants International and
Yamashita Saitoh Inc.

Subcontracted Local Consultant:

Consolidated Consultants
Engineering & Environment
Tel: 012277 - Fax: 012280 - AMM - JORDAN

Drawing Title:
CROSS-SECTION
6+980/7+000

Scale:
H 1:400 V 1:200 Drawing No.: 302