

CONSOLIDATION AND TREATMENT OF FACADES

1- Treat, maintain and clean stone facades:

- Replacement of missing stones details
- Removal of organic growth (vegetations) and repair cracks.
- Repointing of joints.
- Clean stone facades, if necessary.
- Treat all cement block/concrete wall parapets, by stone finishing or appropriate plasters

2. Shop Fronts One Openings:

- maintain all traditional wood shops and doors
- repair, maintain, clean, treat, and repaint all shops shutter doors.

3- AWNINGS AND SIGNAGE

To encourage the replacement of the already existing awning and signs gradually with the newly suggested designs

4- VISUAL VISTAS

to preserve the visual vistas and the visual axis along and on both sides of the tourist street

5- AMENITIES

(Drainage , electricity and telephone poles)

- Because of inadequacy and improper installation of the existing & roof drainage system, a complete new system consisting of down pipes & spouts shall be installed.
- For recommendation and guide lines to improve electricity and telephone installation refer to drwg. ts.s.011t.

Project: Tourism Sector Development Project in the Hashemite Kingdom of Jordan	
Executing Agency The Ministry of Tourism and Antiquities The Ministry of Planning	
SUB-PROJECT: Karak Tourism Development Project Tourist Street	
Note: This detailed design has been executed by a team of consultants as shown below in accordance with the agreement between Japan International Cooperation Agency (JICA) and JICA Study Team. The copyright of this drawing rests with JICA .	
Designed by: Japan International Cooperation Agency (JICA) JICA Study Team: Joint Venture of Pacific Consultants International and Yamasita Sekkei Inc. Subcontracted Local Consultant:  Tel: 4612377 - Fax: 4612380 - AMMAN - JORDAN	
Drawing Title: TOURIST STREET	
Scale: N.T.S.	Drawing No.: T.S.S.010T



REMOVE PAINT (CLEAN STONE)



ENCOURAGE the REMOVAL OF OLD RAIN WATER PIPES AND THE INSTALLATION OF NEW ONES



REMOVE CONCRETE (BLOCKS) PARAPET AND INSTALL STONE COURSES INSTEAD



REMOVE ALL TRAFFIC SIGNS AND INSTALL NEW ONE TO SUIT THE DESIGN

Project:
Tourism Sector Development Project
in the Hashemite Kingdom of Jordan

Executing Agency
The Ministry of Tourism and Antiquities
The Ministry of Planning

SUB-PROJECT:
Karak Tourism Development Project
Tourist Street

Note:
This detailed design has been executed by a team of consultants as shown below in accordance with the agreement between Japan International Cooperation Agency (JICA) and JICA Study Team.

The copyright of this drawing rests with JICA .

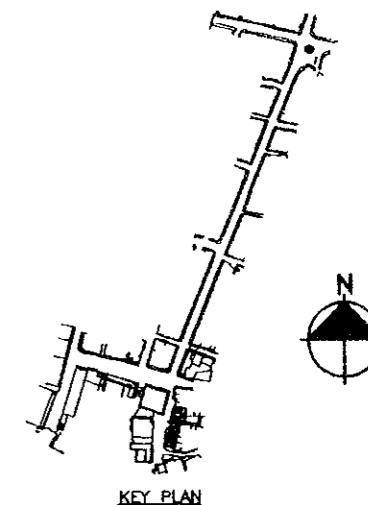

Designed by:
Japan International Cooperation Agency (JICA)

JICA Study Team:
Joint Venture of
Pacific Consultants International and
Yamasita Sekkei Inc.

Subcontracted Local Consultant:

consolidated consultants
engineering & environment
Tel: 4612377 - Fax: 4612380 - AMMAN - JORDAN

Drawing Title:
TOURIST STREET

Scale:
N.T.S.

Drawing No.:
TS.S.011



*TO LIMIT THE HEIGHT OF THE BUILDINGS TO BE CONSTRUCTED
IN FUTURE IN ORDER TO COPE WITH THE HIGHEST OF THE TRADITIONAL*

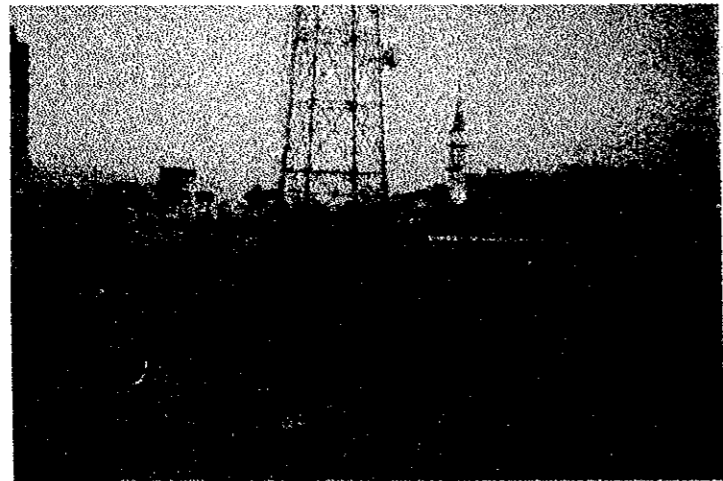

*REMOVE TELECOMMUNICATION TOWER
AND INSTALL IT AWAY FROM THE CORE OF THE CITY*



*REPAIR, MAINTAIN, CLEAN, TREAT,
AND PAINT FOR SHOPS SHUTTER STEEL DOORS*



*REMOVE VEGETATION, CLEAN AND REPAIR CRACKS
IN STONE AND BUILD NEW STONE COURSES FOR PARAPET*

Project:
Tourism Sector Development Project
in the Hashemite Kingdom of Jordan

Executing Agency
The Ministry of Tourism and Antiquities
The Ministry of Planning

SUB-PROJECT:
Karak Tourism Development Project
Tourist Street

Note:
This detailed design has been executed by
a team of consultants as shown below in
accordance with the agreement between
Japan International Cooperation Agency
(JICA) and JICA Study Team.

The copyright of this drawing rests with
JICA .

Designed by:
Japan International Cooperation
Agency (JICA)

JICA Study Team:
Joint Venture of
Pacific Consultants International and
Yamasita Sekkei Inc.

Subcontracted Local Consultant:

 **consolidated consultants**
engineering & environment
Tel: 4612377 - Fax: 4612380 - AMMAN - JORDAN

TOURIST STREET
Drawing Title:

Scale:
N.T.S.

Drawing No.:
TS.S.012

2



**REPAIR, MAINTAIN, CLEAN, TREAT, PAINT
AND REGLAZE ALL WINDOWS, DOORS AND HANDRAILS**

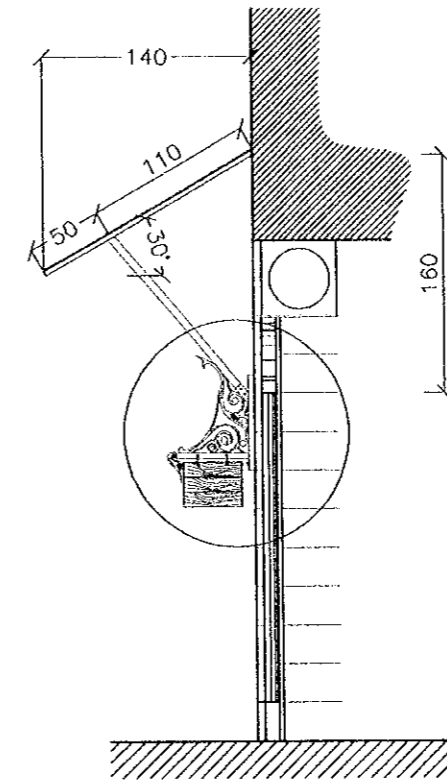

SCALE 1:50

MAINTAIN TRADITIONAL TYPICAL AWNINGS



**MAINTAIN TRADITIONAL TYPICAL
WOOD SHOP DOORS**



**REMOVE STRUCTURES ON PUBLIC OWNERSHIP
AND MAINTAIN DISTINGUISHED BUILDINGS FROM DEMOLITION**

Project:
Tourism Sector Development Project
in the Hashemite Kingdom of Jordan

Executing Agency
The Ministry of Tourism and Antiquities
The Ministry of Planning

SUB-PROJECT:
Karak Tourism Development Project
Tourist Street

Note:
This detailed design has been executed by
a team of consultants as shown below in
accordance with the agreement between
Japan International Cooperation Agency
(JICA) and JICA Study Team.

The copyright of this drawing rests with
JICA .

Designed by:
Japan International Cooperation
Agency (JICA)

JICA Study Team:
Joint Venture of
Pacific Consultants International and
Yamasita Sekkei Inc.

Subcontracted Local Consultant:

consolidated consultants
engineering & environment
Tel: 4612377 - Fax: 4612380 - AMMAN - JORDAN

TOURIST STREET
Drawing Title:

Scale:
N.T.S.

Drawing No.:
TS.S.013

2

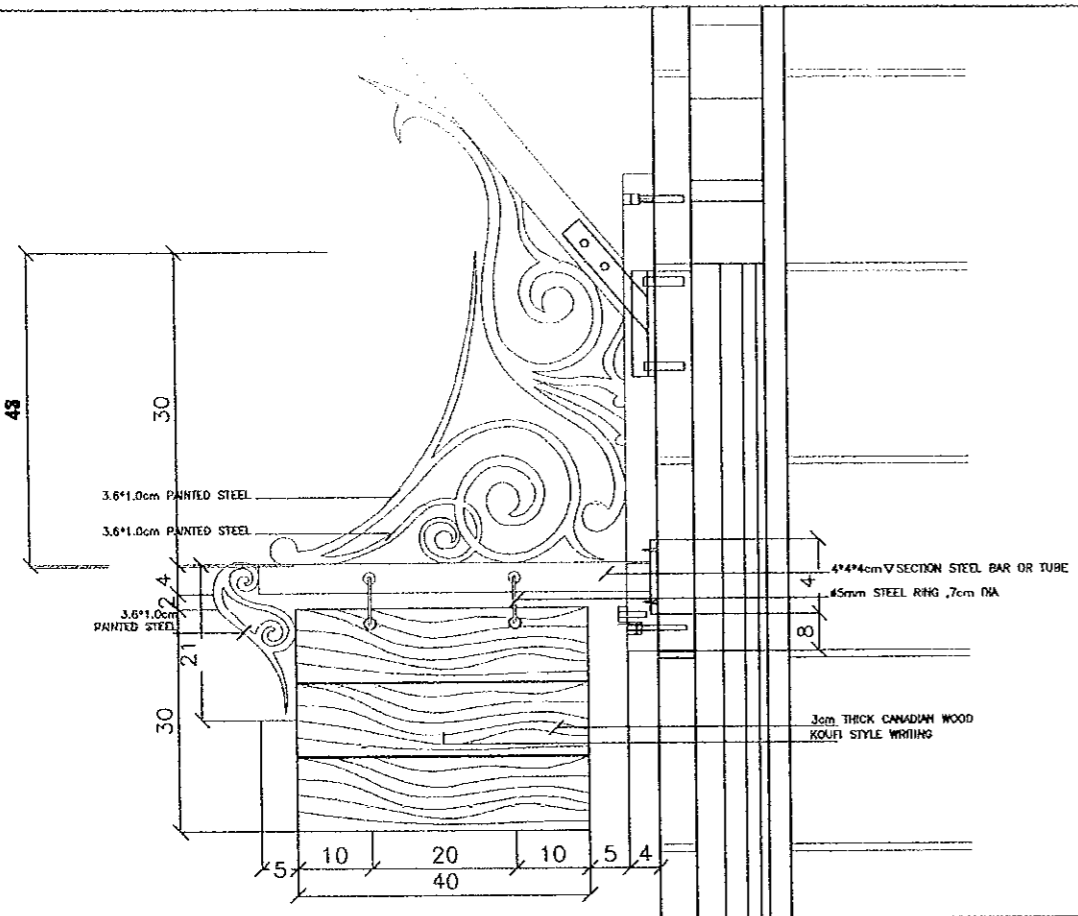

PROPOSED TRADITIONAL WALL MOUNTED STREET LIGHTING

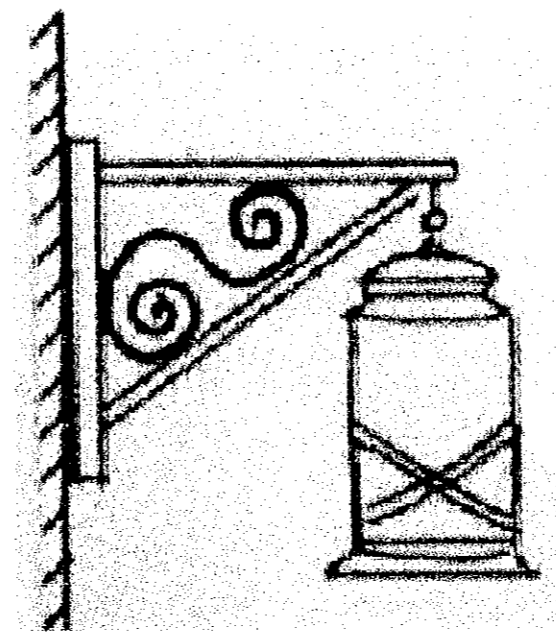

PROPOSED TRADITIONAL WALL MOUNTED STREET SIGNS

Project:
Tourism Sector Development Project
in the Hashemite Kingdom of Jordan

Executing Agency
The Ministry of Tourism and Antiquities
The Ministry of Planning

SUB-PROJECT:
Karak Tourism Development Project
Tourist Street

Note:
This detailed design has been executed by a team of consultants as shown below in accordance with the agreement between Japan International Cooperation Agency (JICA) and JICA Study Team.

The copyright of this drawing rests with JICA.

Designed by:
Japan International Cooperation Agency (JICA)

JICA Study Team:
Joint Venture of Pacific Consultants International and Yamasita Sekkei Inc.

Subcontracted Local Consultant:

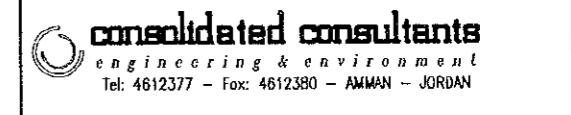

Tourist Street
Drawing Title:

Scale: N.T.S. **Drawing No.:** TS.S.014

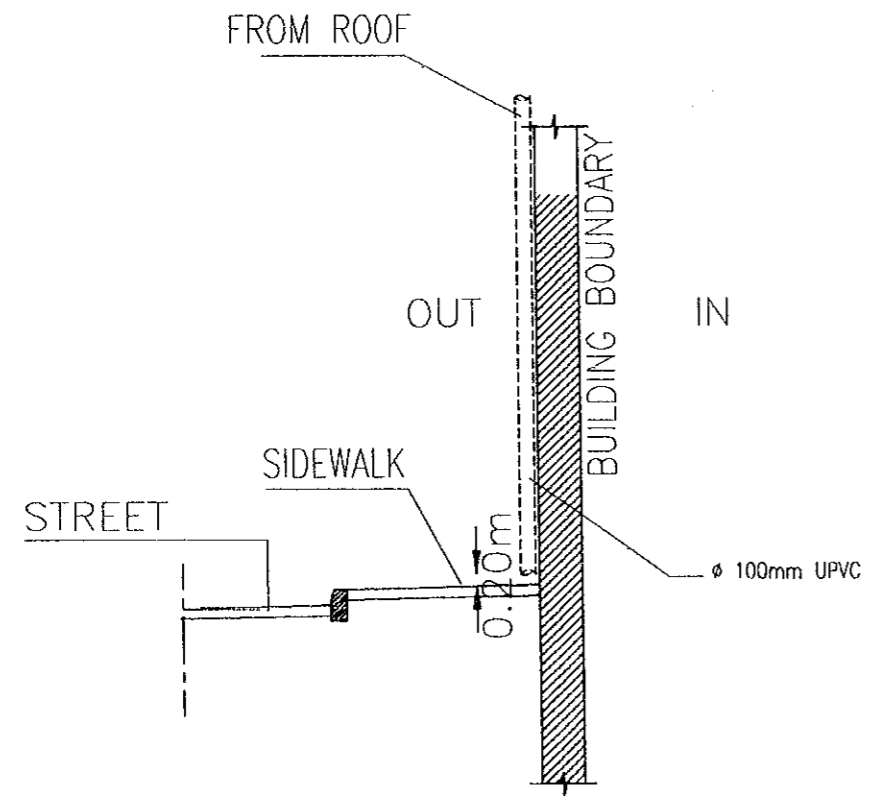

PROPOSED RAIN WATER DRAINAGE ROOF DETAIL

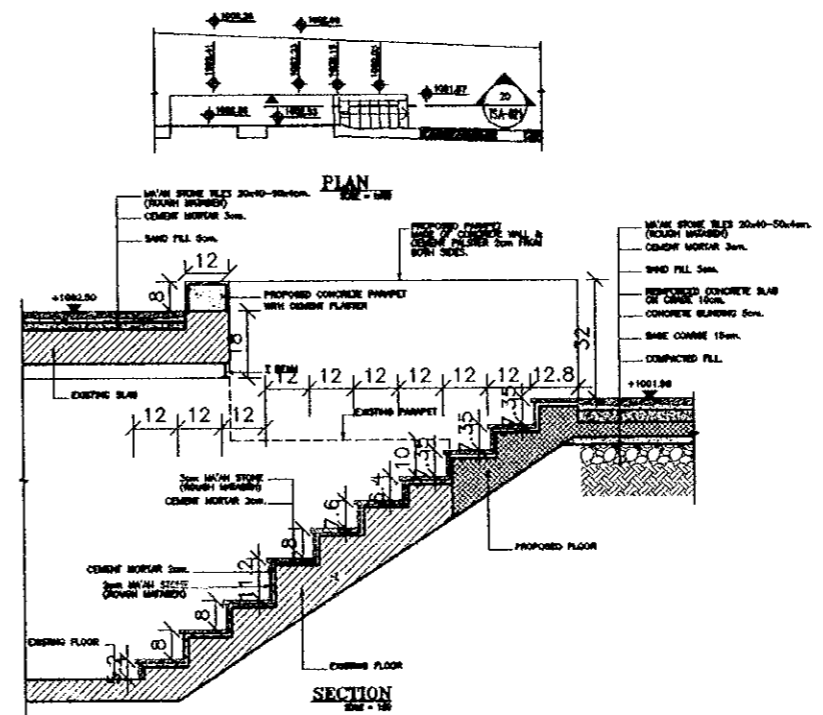

PROPOSED DETAIL FOR DEVELOPMENT OF BANANA STORE ENTRANCE



EXISTING CONDITION

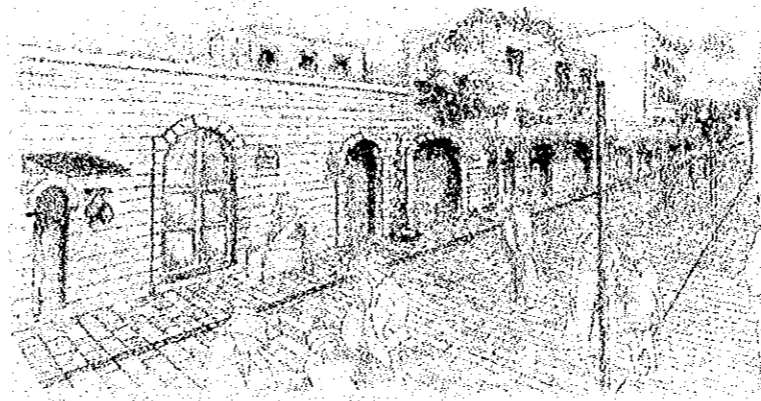

PROPOSED SOLUTION

Project:
Tourism Sector Development Project
in the Hashemite Kingdom of Jordan

Executing Agency
The Ministry of Tourism and Antiquities
The Ministry of Planning

SUB-PROJECT:
Karak Tourism Development Project
Tourist Street

Note:
This detailed design has been executed by
a team of consultants as shown below in
accordance with the agreement between
Japan International Cooperation Agency
(JICA) and JICA Study Team.

The copyright of this drawing rests with
JICA .

Street Improvement:

- Encourage new services and facilities
for users such as restaurants,
bookshope, crafts shops, coffee shops,
open market...etc.
- Enhance the traditional shops of the
street such as Akash, Al Helaby
(food outlets)
- Not to renew licenses for commercial
outlets in relation to selling old
clothes & shoes in the street.
- Pedestrian as a priority
- Availability of access service for shop owners
- Wide & improved sidewalks which
are shaded wherever possible
- Street furniture & planting
at appropriate locations

Designed by:
Japan International Cooperation
Agency (JICA)

JICA Study Team:
Joint Venture of
Pacific Consultants International and
Yamasita Sekkei Inc.

Subcontracted Local Consultant:



TOURIST STREET

Drawing Title:

Scale:
N.T.S.



Drawing No.:
TSS.015

EXISTING CONDITION

PROPOSED SOLUTION

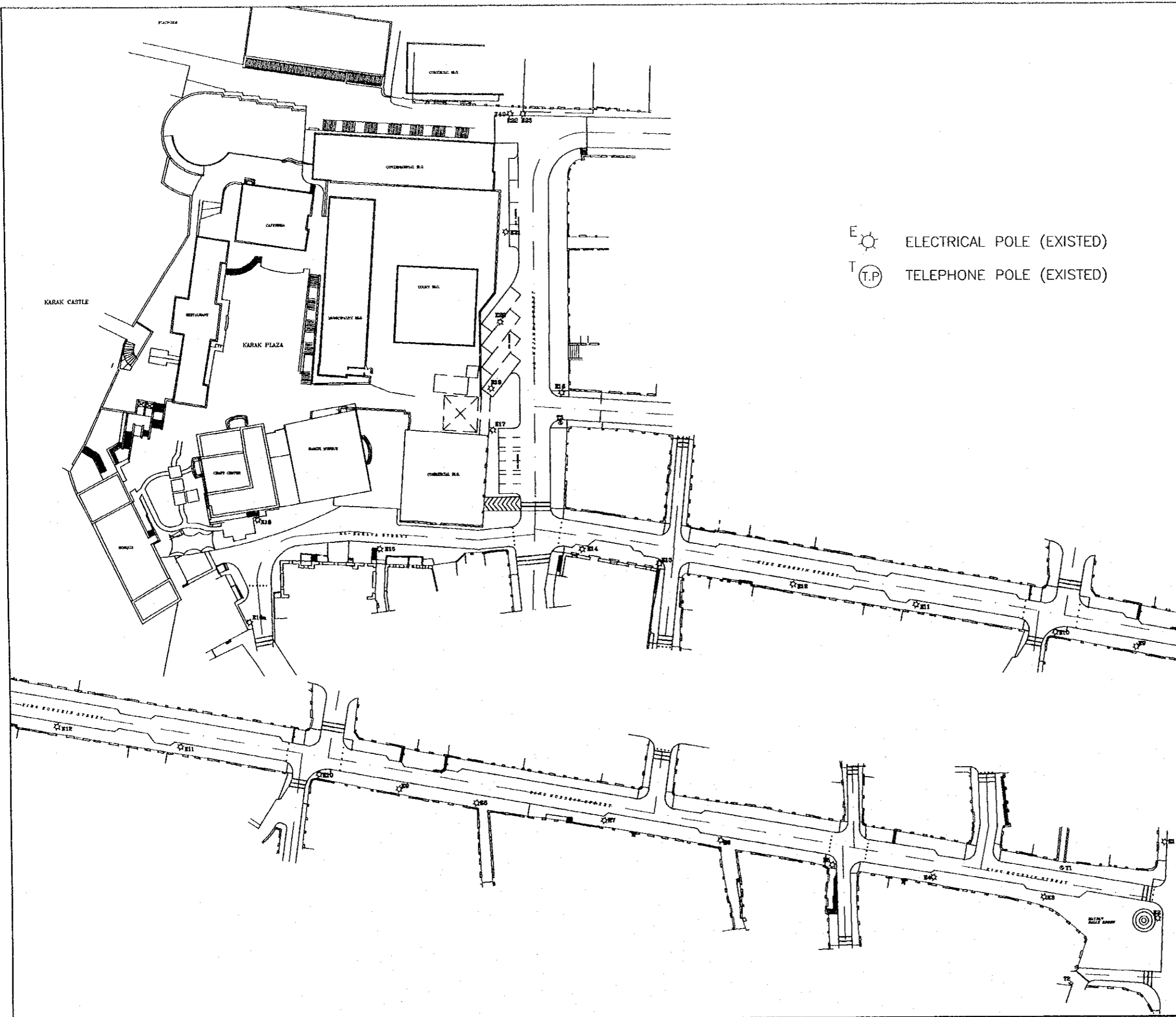
55



E  ELECTRICAL POLE (EXISTED)
 T.P.  TELEPHONE POLE (EXISTED)

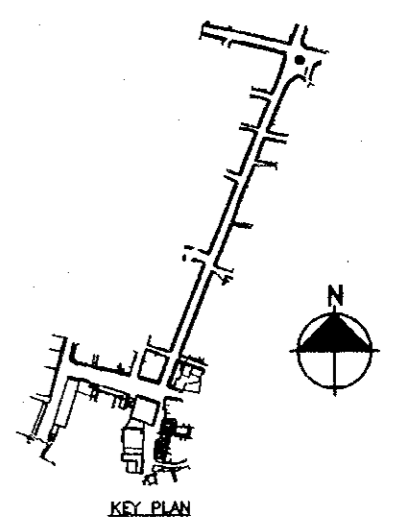

Project:
 Tourism Sector Development Project
 in the Hashemite Kingdom of Jordan

Executing Agency
 The Ministry of Tourism and Antiquities
 The Ministry of Planning

SUB-PROJECT:
 Karak Tourism Development Project
 Tourist Street

Note:
 This detailed design has been executed by
 a team of consultants as shown below in
 accordance with the agreement between
 Japan International Cooperation Agency
 (JICA) and JICA Study Team.

The copyright of this drawing rests with
 JICA .

Designed by:
 Japan International Cooperation
 Agency (JICA)

JICA Study Team:
 Joint Venture of
 Pacific Consultants International and
 Yamasita Sekkei Inc.

Subcontracted Local Consultant:
 **consolidated consultants**
 engineering & environment
 Tel: 4612377 - Fax: 4612380 - AMMAN - JORDAN

Drawing Title: **POWER, TELEPHONE
 POLES LOCATIONS**

Scale:
 1/1000

Drawing No.:
 T.S.S-017

25

**Comments On Electrical & Telephone
Over Head Lines Network In
karak Tourist Street (see Drawings Ts-er002- Ts-er006)**

The following comments are related to drawing No. E01:

1. Pole E⁷ is an old pole with no wires, to be removed.
2. The wires between E1 and E2 pass over houses roofs and they need a Bracket.
3. The cable from E1 to the front house is connected by a tape without insulators.
4. The wires on pole T1 put in a random way without being organized, and the next houses feed is done by dangling wires across the street.
5. Feeding the shops from E3 is done by very close insulators to the shops, and also dangling ropes must be removed from the pole which was used for the signboards, and also the lighting unit cover is opened and exposed to air and moisture as well.
6. Feeding the shops from pole E4 doesn't go along with safety regulations, and the cables are dangling in bad manner, also the telephone wires were fixed on it and the ropes must be removed from the pole which were used for hanging the signboards.
7. Pole E5 is inclined and telephone cables are fixed on it in addition to ropes for signboards.
8. The dangling ropes from pole E6 should be removed and the cables from the pole to the shops are not connected to insulators, but with tape instead, and also there is a dangling connection from this pole to one of the shops.
9. The pole E7 is inclined and has dangling wires and cable to one of the next shops, and a cover needed for the lamp.
10. The feeding cables from pole E8 are installed in a bad and random way.
11. One of the cables is dangling in a bad way from pole E9 to one of the houses.
12. Pole E10 needs a lamp and a cover as well, and also one of the cables is dangling in a bad way to the front shop and it is running through one of the windows.
13. The cable from pole E11 needs to be strengthened to the front shop.
14. The cables are dangling in bad way to the front shops from pole E12.
15. Pole E13 needs a lamp cover.
16. A lamp cover needed for pole E14 and one of the cables is dangling in bad way to the other side of the street and in touch with the front house roof.
17. The distance between poles E14 and E15 is too long and needs an additional pole since the cable and wires are dangling in bad way.
18. One of the cables is dangling in bad way from pole E15 to the front house.
19. The cable from pole E16 is dangling in bad way towards the Civil Defense building.
20. Pole E16A is too close to one of the houses and it needs a bracket.
21. Telephone cables are dangling in bad way from pole E15 to the front house and are fastened to the walls and fixed in a randomly way.
22. Pole T3 has a dangling old telephone wires.
23. Remodify the connections of the wires and cables from pole E18 straight to the next houses.
24. The wires between poles E19 and E20 is being touched by trees.
25. Feeding cables from pole E21 to Karak antiquities department is dangerous as it is tied to insulators too close to the window.
26. Feeding cables from pole E22 to E23 are too close to one of the houses and it need a brackets.
27. Connections from pole T4 to the next houses and randomly fixed.

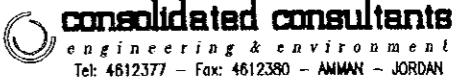
Project: Tourism Sector Development Project in the Hashemite Kingdom of Jordan	
Executing Agency The Ministry of Tourism and Antiquities The Ministry of Planning	
SUB-PROJECT: Karak Tourism Development Project Tourist Street	
Note: This detailed design has been executed by a team of consultants as shown below in accordance with the agreement between Japan International Cooperation Agency (JICA) and JICA Study Team. The copyright of this drawing rests with JICA .	
Designed by: Japan International Cooperation Agency (JICA) JICA Study Team: Joint Venture of Pacific Consultants International and Yamasita Sekkei Inc. Subcontracted Local Consultant:	
 consolidated consultants <small>engineering & environment Tel: 4612377 - Fax: 4612380 - AMMAN - JORDAN</small>	
ELECTICAL NOTES	
Drawing Title:	
Scale: N.T.S	Drawing No.: T.S.S-018

43

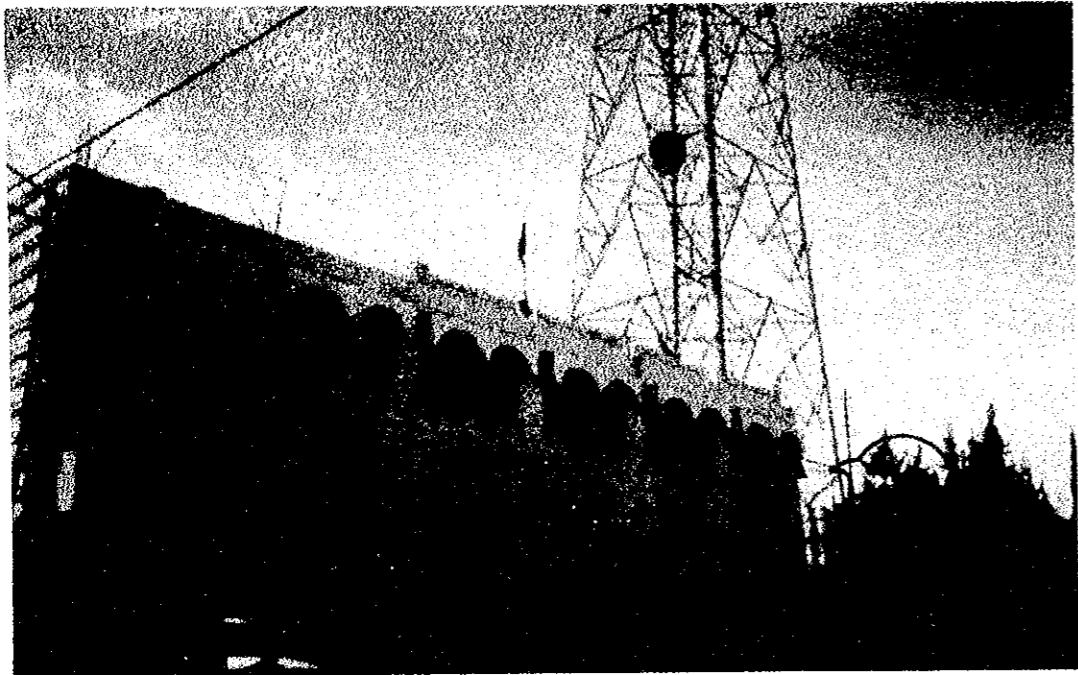

A- BAD CONNECTION OF POLE (E17)



A- POLE (E16A) IS TOO CLOSE TO THE HOUSE

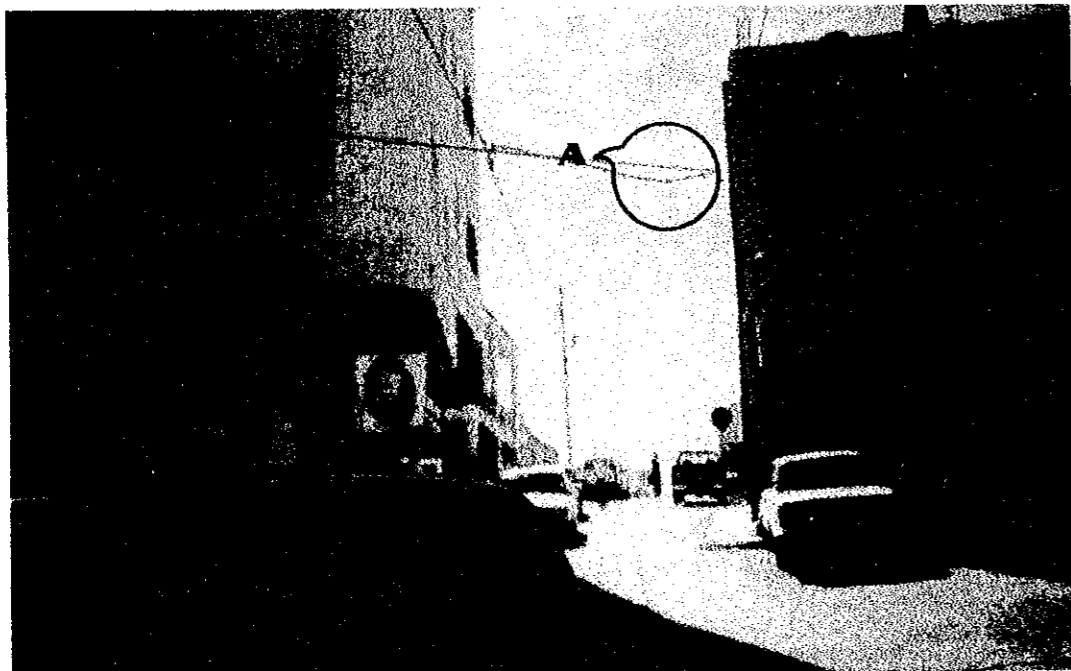

A- THE DISTANCE BETWEEN POLES (E14 & E15) IS TOO LONG AND NEEDS AN ADDITIONAL POLE SINCE THE CABLE & WIRES ARE DANGLING IN BAD WAY

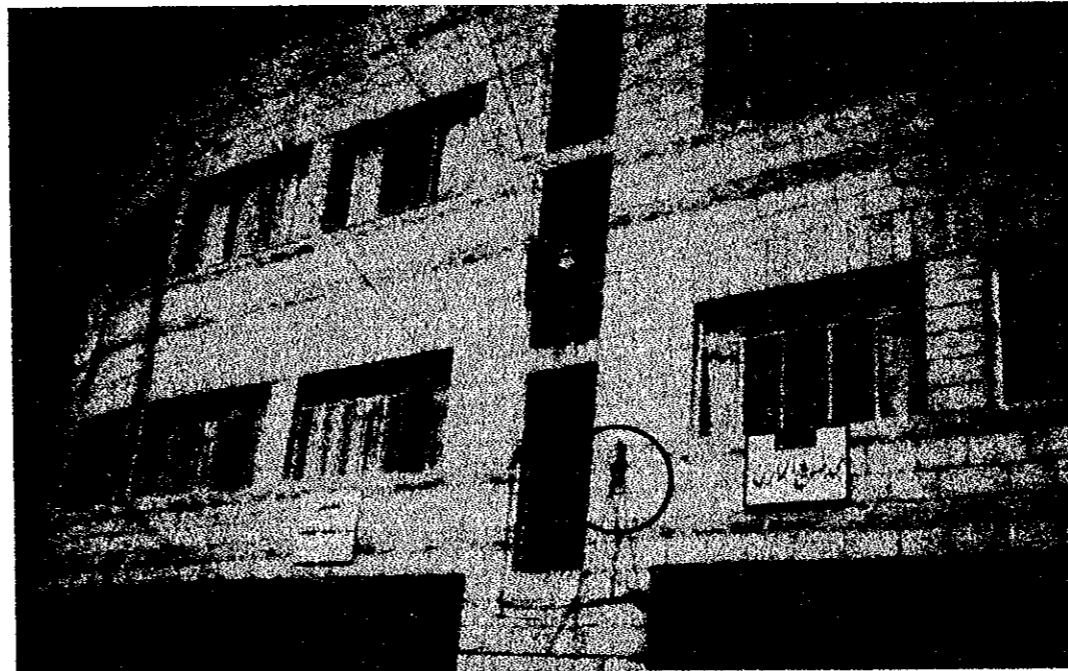

A- FEEDING CABLES FROM POLE (E21) TO KARAK ANTIQUITIES DEPARTMENT IS DANGEROUS AS IT IS TIED TO INSULATORS TOO CLOSE TO THE WINDOW

Project:
Tourism Sector Development Project
in the Hashemite Kingdom of Jordan

Executing Agency
The Ministry of Tourism and Antiquities
The Ministry of Planning

SUB-PROJECT:
Karak Tourism Development Project
Tourist Street

Note:
This detailed design has been executed by a team of consultants as shown below in accordance with the agreement between Japan International Cooperation Agency (JICA) and JICA Study Team.

The copyright of this drawing rests with JICA .

Designed by:
Japan International Cooperation Agency (JICA)

JICA Study Team:
Joint Venture of
Pacific Consultants International and
Yamasita Sekkei Inc.

Subcontracted Local Consultant:

consolidated consultants
engineering & environment
Tel: 4612377 - Fax: 4612380 - AMMAN - JORDAN

PHOTOS FOR EXISTING
POWER AND TELEPHONE
NETWORK SITUATION
Drawing Title:

Scale:
N.T.S

Drawing No.:
T.S.S-019

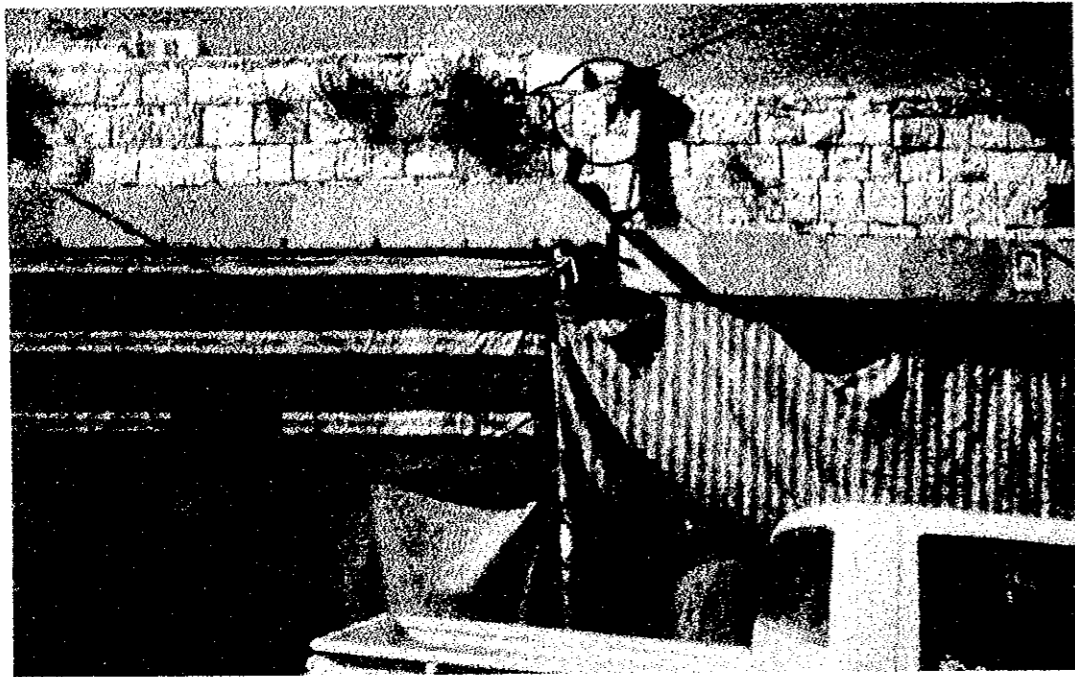

A- BAD CONNECTION FROM POLE (E12)



A- BAD CONNECTION FROM POLE (E14)



A- DANGLING CABLES AND BAD CONNECTION FROM POLE (E5)



A- OLD POLE TO BE REMOVED
B- ELECTRICAL POLE TOO CLOSE TO HOUSES

Project:
Tourism Sector Development Project
in the Hashemite Kingdom of Jordan

Executing Agency
The Ministry of Tourism and Antiquities
The Ministry of Planning

SUB-PROJECT:
Karak Tourism Development Project
Tourist Street

Note:
This detailed design has been executed by
a team of consultants as shown below in
accordance with the agreement between
Japan International Cooperation Agency
(JICA) and JICA Study Team.

The copyright of this drawing rests with
JICA .

Designed by:
Japan International Cooperation
Agency (JICA)

JICA Study Team:
Joint Venture of
Pacific Consultants International and
Yamasita Sekkei Inc.

Subcontracted Local Consultant:

consolidated consultants
engineering & environment
Tel: 4612377 - Fax: 4612380 -- AMMAN -- JORDAN

PHOTOS FOR EXISTING
POWER AND TELEPHONE
Drawing Title: NETWORK SITUATION

Scale:
N.T.S

Drawing No.:
TS.S-020

65



A- CABLES NOT CONNECTED TO INSULATORS
B- DANGLING CABLES

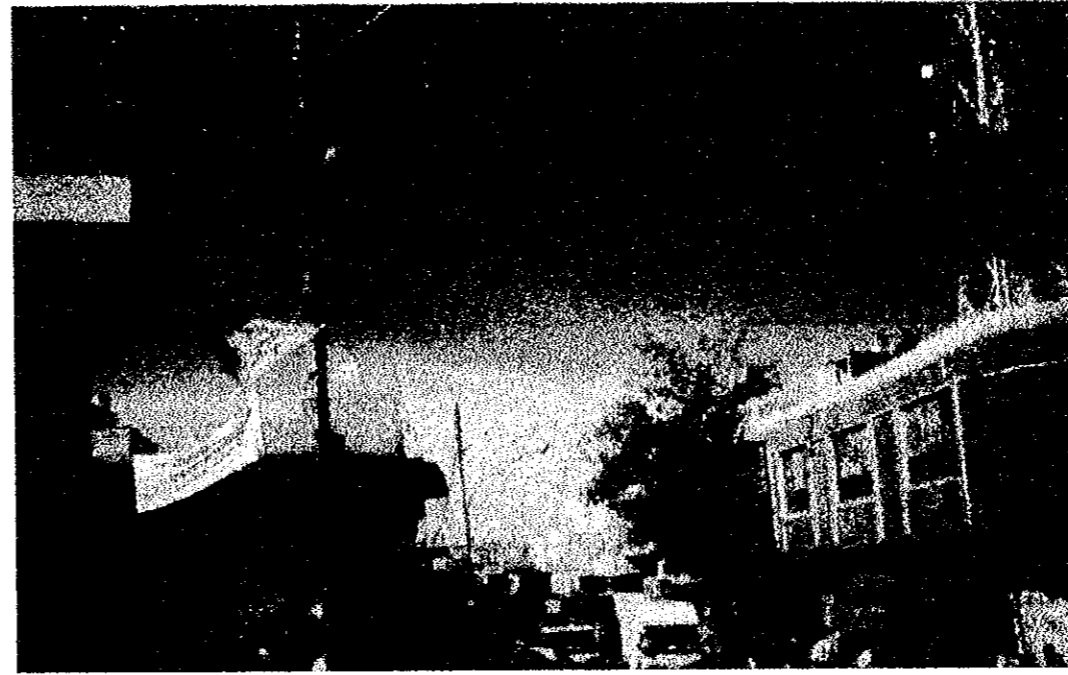

A- CABLES PASS OVER THE ROOFS



A- CABLE CONNECTION TO THE HOUSE WITHOUT INSULATOR



A- DANGLING WIRES, INCLINED POLE & A COVER NEEDED FOR THE LAMP

Project:
Tourism Sector Development Project
in the Hashemite Kingdom of Jordan

Executing Agency
The Ministry of Tourism and Antiquities
The Ministry of Planning

SUB-PROJECT:
Karak Tourism Development Project
Tourist Street

Note:
This detailed design has been executed by
a team of consultants as shown below in
accordance with the agreement between
Japan International Cooperation Agency
(JICA) and JICA Study Team.

The copyright of this drawing rests with
JICA .

Designed by:
Japan International Cooperation
Agency (JICA)

JICA Study Team:
Joint Venture of
Pacific Consultants International and
Yamasita Sekkei Inc.

Subcontracted Local Consultant:

consolidated consultants
engineering & environment
Tel: 4612377 - Fax: 4612380 - AMMAN - JORDAN

PHOTOS FOR EXISTING
POWER AND TELEPHONE
Drawing Title: NETWORK SITUATION

Scale: N.T.S. Drawing No.: TS.S-021

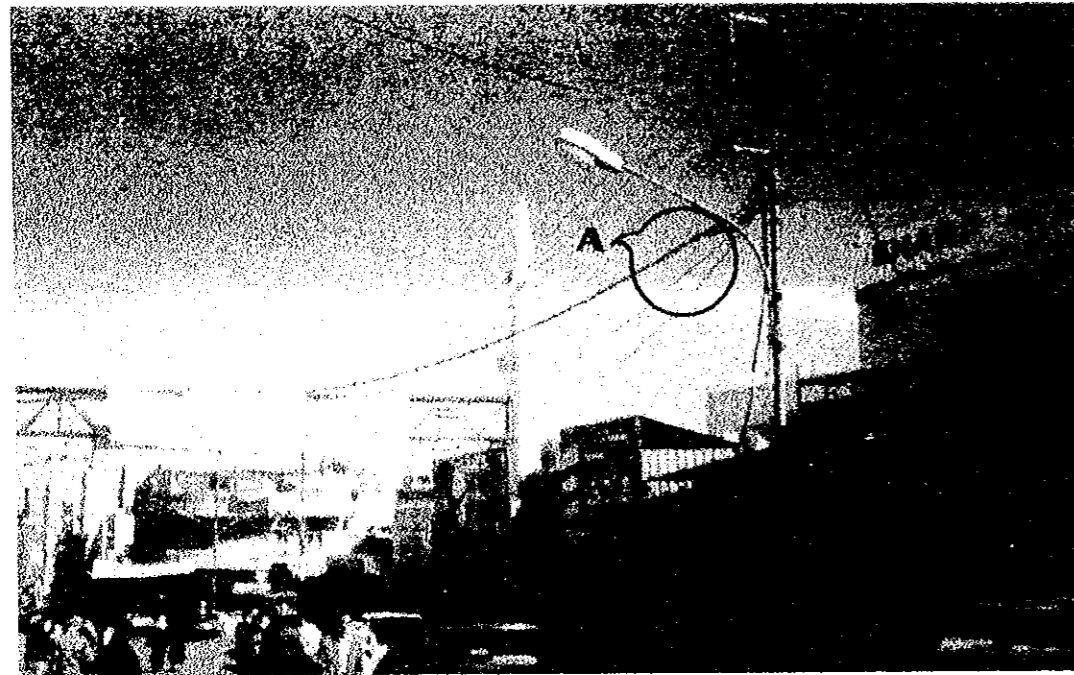

A- DANGLING CABLES FROM POLE (E4)

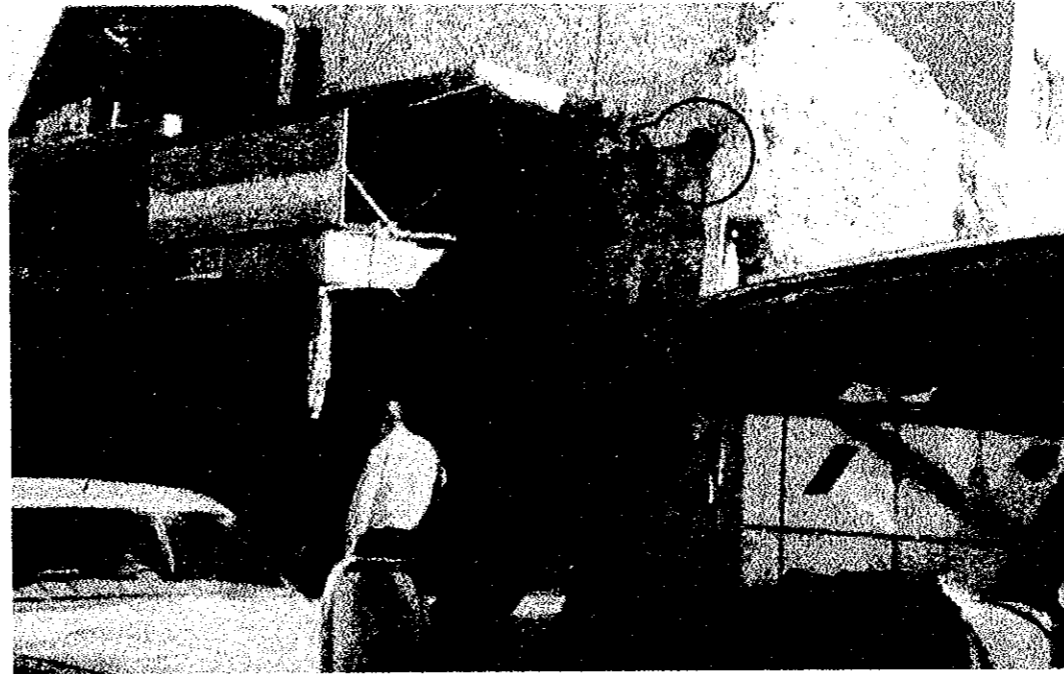

A - TELEPHONE CABLES ON STORES FACADE



A- OLD HOUSE CONNECTION CLOSE TO (E6)



A- DANGLING CABLES FROM POLE (E12)

Project:
Tourism Sector Development Project
in the Hashemite Kingdom of Jordan

Executing Agency
The Ministry of Tourism and Antiquities
The Ministry of Planning

SUB-PROJECT:
Karak Tourism Development Project
Tourist Street

Note:
This detailed design has been executed by
a team of consultants as shown below in
accordance with the agreement between
Japan International Cooperation Agency
(JICA) and JICA Study Team.

The copyright of this drawing rests with
JICA .

Designed by:
Japan International Cooperation
Agency (JICA)

JICA Study Team:
Joint Venture of
Pacific Consultants International and
Yamasita Sekkei Inc.

Subcontracted Local Consultant:

consolidated consultants
engineering & environment
Tel: 4612377 - Fax: 4612380 - AMMAN - JORDAN

PHOTOS FOR EXISTING
POWER AND TELEPHONE
Drawing Title: NETWORK SITUATION

Scale:
N.T.S

Drawing No.:
T.S.S-022

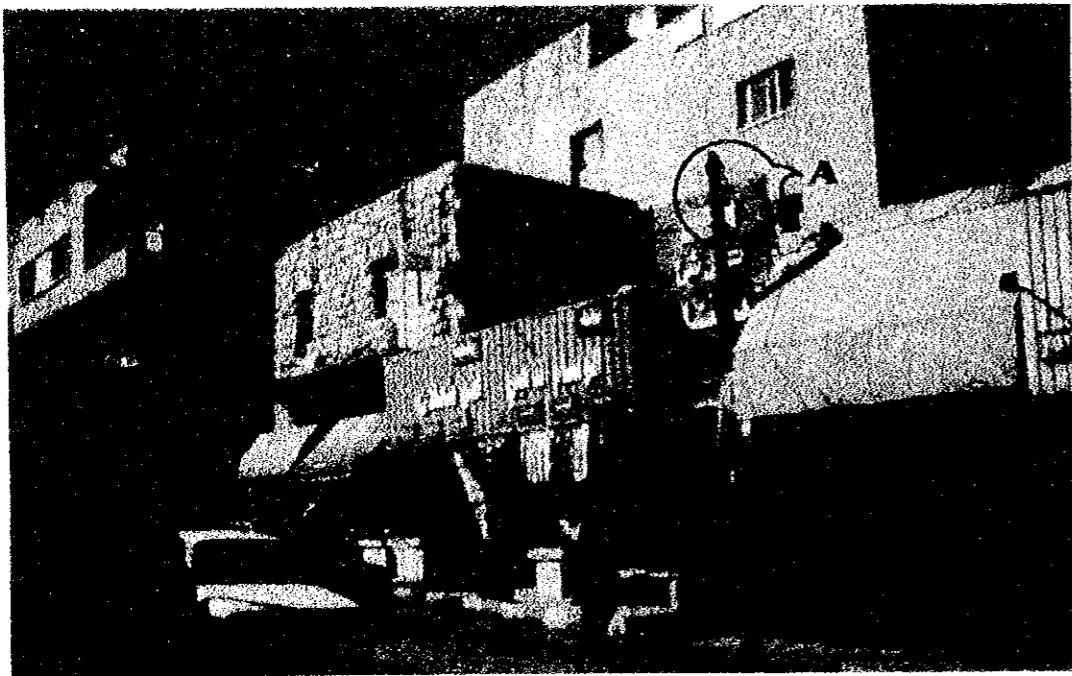

A- BAD ARRANGEMENT OF TELEPHONE CABLES ON POLE (T1)



A- TELEPHONE CABLE FIXED TO ELECTRICAL POLE



A-WRONG CONNECTION TO HOUSES FROM POLE (E3)



A- WIRES BETWEEN POLES (E19 & E20) ARE BEING TOUCHED BY TREES



A- FEEDING CABLE ENTER THE BUILDING FROM THE WINDOW

Project:
Tourism Sector Development Project
in the Hashemite Kingdom of Jordan

Executing Agency
The Ministry of Tourism and Antiquities
The Ministry of Planning

SUB-PROJECT:
Karak Tourism Development Project
Tourist Street

Note:
This detailed design has been executed by a team of consultants as shown below in accordance with the agreement between Japan International Cooperation Agency (JICA) and JICA Study Team.

The copyright of this drawing rests with JICA .

Designed by:
Japan International Cooperation Agency (JICA)

JICA Study Team:
Joint Venture of
Pacific Consultants International and
Yamasita Sekkei Inc.

Subcontracted Local Consultant:

consolidated consultants
engineering & environment
Tel: 4612377 - Fax: 4612380 - AMMAN - JORDAN

PHOTOS FOR EXISTING
POWER AND TELEPHONE
DRAWING TITLE: NETWORK SITUATION

Scale: N.T.S. | Drawing No.: T.S.S-023

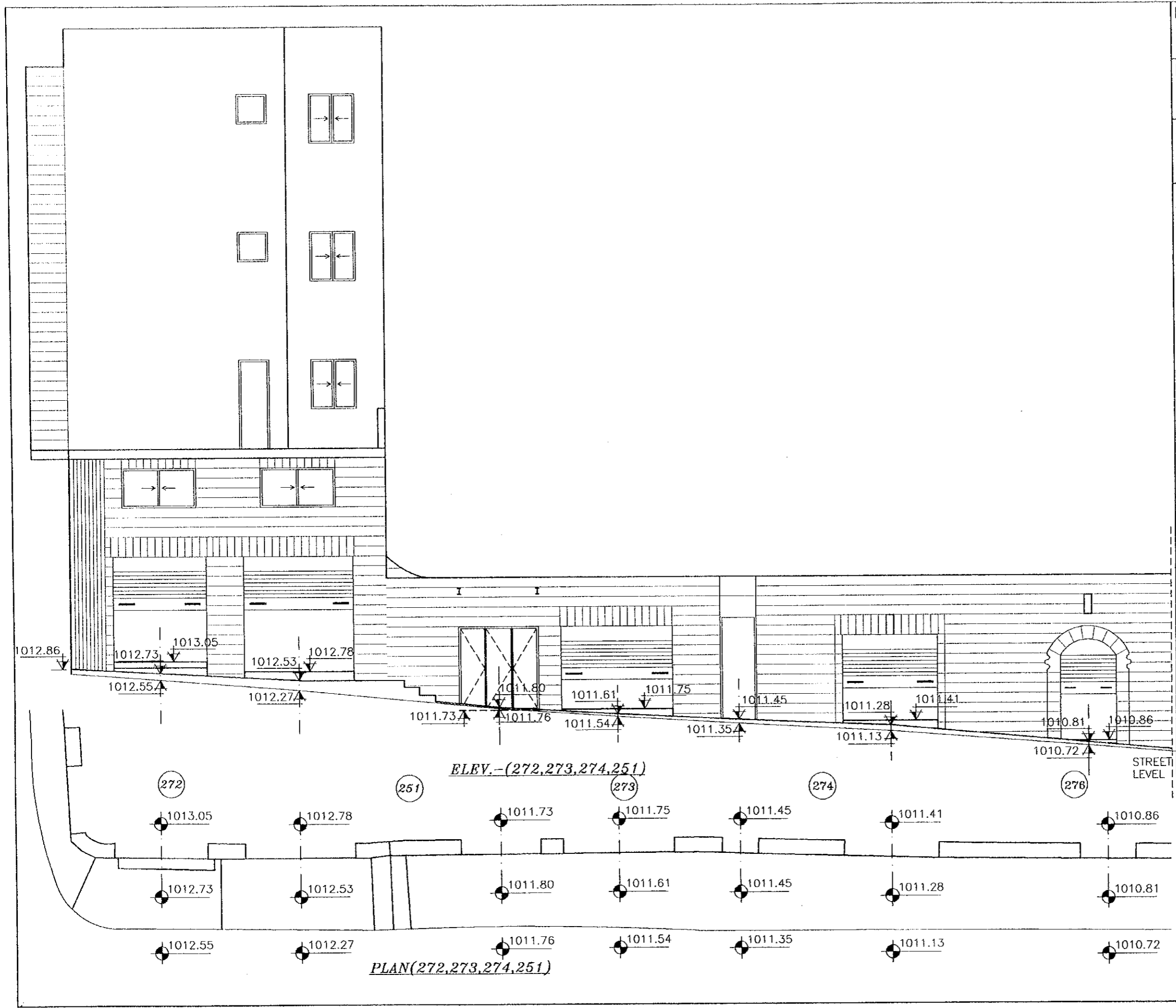

Project:
 Tourism Sector Development Project
 in the Hashemite Kingdom of Jordan

Executing Agency
 The Ministry of Tourism and Antiquities
 The Ministry of Planning

SUB-PROJECT:
 Karak Tourism Development Project
 Tourist Street

Note:
 This detailed design has been executed by
 a team of consultants as shown below in
 accordance with the agreement between
 Japan International Cooperation Agency
 (JICA) and JICA Study Team.
 The copyright of this drawing rests with
 JICA .

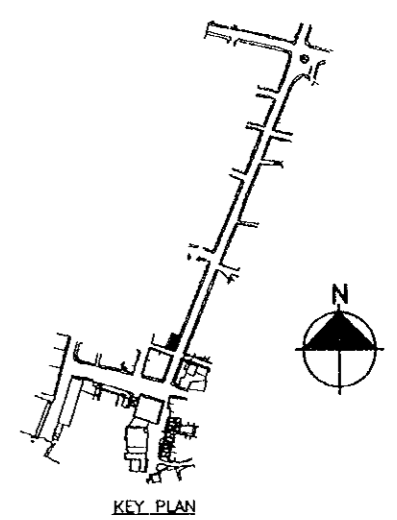

Designed by:
 Japan International Cooperation
 Agency (JICA)

JICA Study Team:
 Joint Venture of
 Pacific Consultants International and
 Yamasita Sekkei Inc.

Subcontracted Local Consultant:

consolidated consultants
 engineering & environment
 Tel: 4612377 - Fax: 4612380 - AMMAN - JORDAN

Drawing Title: **TOURIST STREET
 SURVEY LAY OUT**

Scale: **1:100** | Drawing No.: **TS.S-002**

65

Project:
 Tourism Sector Development Project
 in the Hashemite Kingdom of Jordan

Executing Agency
 The Ministry of Tourism and Antiquities
 The Ministry of Planning

SUB-PROJECT:
 Karak Tourism Development Project
 Tourist Street

Note:
 This detailed design has been executed by
 a team of consultants as shown below in
 accordance with the agreement between
 Japan International Cooperation Agency
 (JICA) and JICA Study Team.

The copyright of this drawing rests with
 JICA .

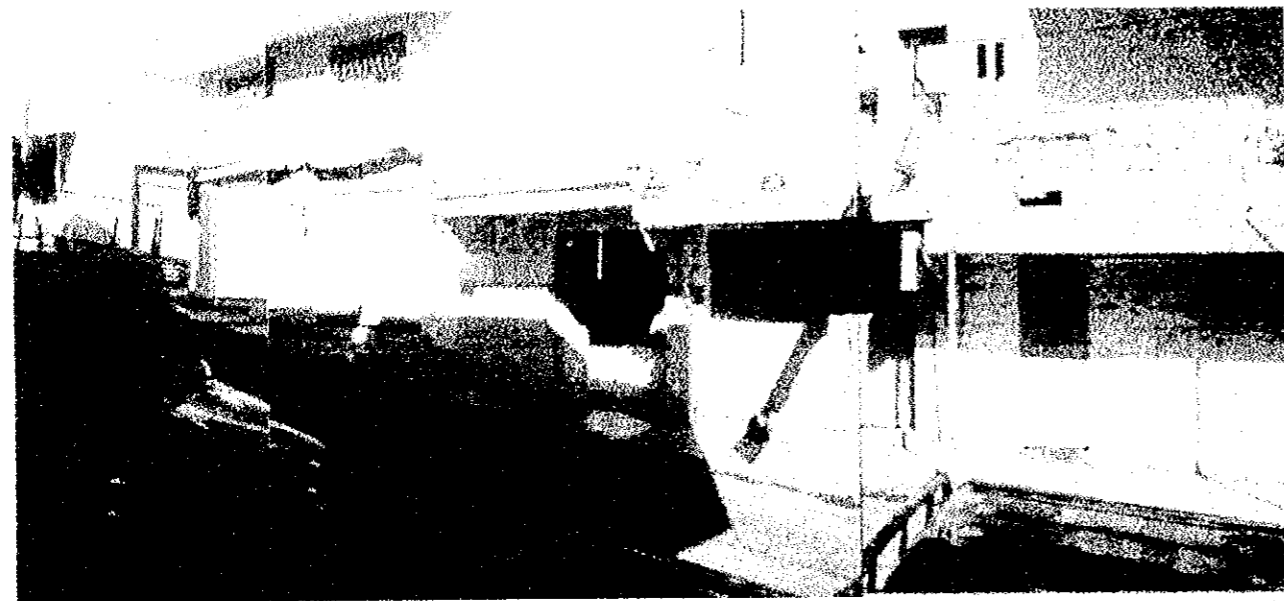

PHOTO NO. (3)

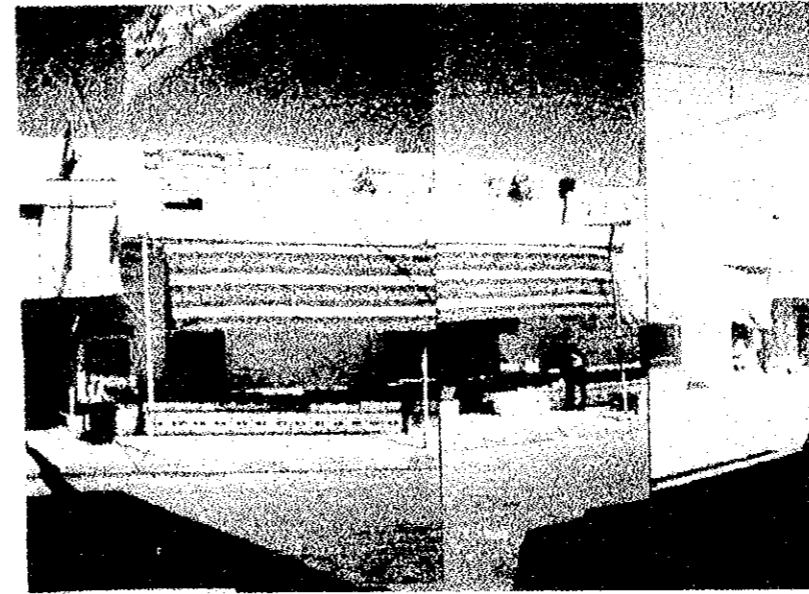

PHOTO NO. (4)

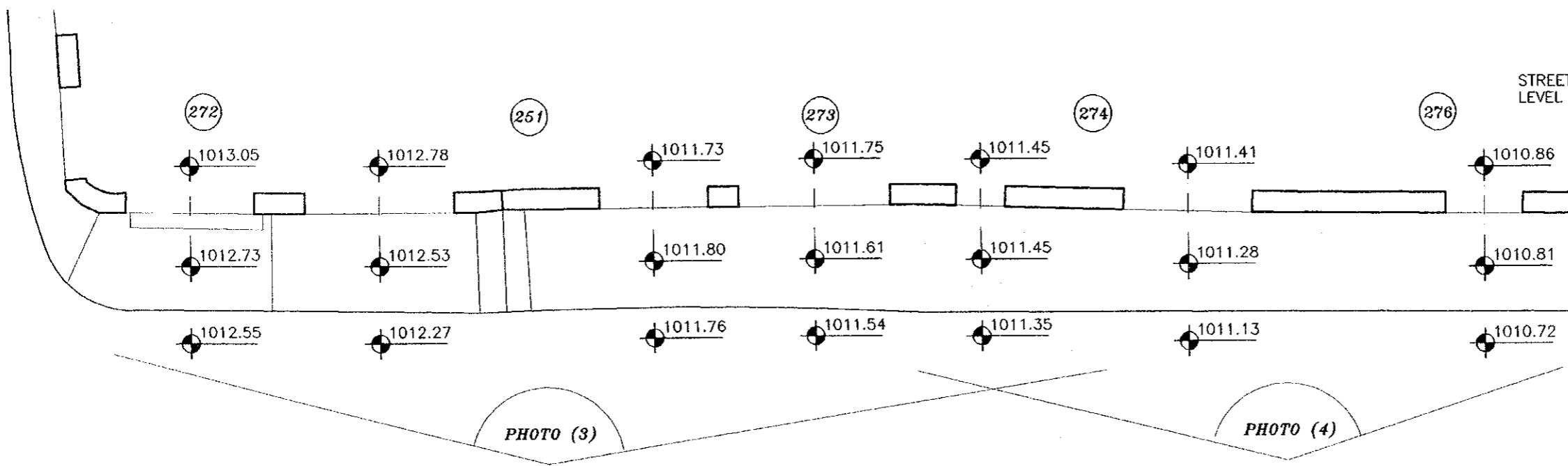
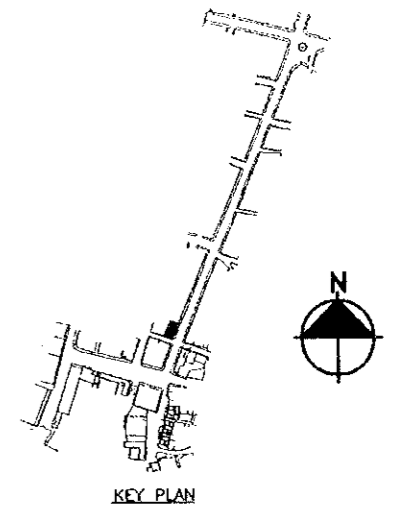

PHOTO (3)

PHOTO (4)

PLAN(272,273,274,251)

Designed by:
 Japan International Cooperation
 Agency (JICA)

JICA Study Team:
 Joint Venture of
 Pacific Consultants International and
 Yamasita Sekkei Inc.

Subcontracted Local Consultant:

consolidated consultants
 engineering & environment
 Tel: 4612377 - Fax: 4612380 - AMMAN - JORDAN

Drawing Title: **TOURIST STREET
 SURVEY LAY OUT**

Scale:
1:100

Drawing No.:
T.S.S-002P

49