

NO.	DATE	REVISIONS	ORIGINATED	DESIGNED	APPROVED	APPROVED

THE REPUBLIC OF INDONESIA
 MINISTRY OF PUBLIC WORKS
 DIRECTORATE GENERAL OF WATER RESOURCES DEVELOPMENT AND FLOOD CONTROL, URBAN DRAINAGE AND WATER RESOURCES GENERAL OF HUMAN SETTLEMENT
 AND DIRECTORATE GENERAL OF HUMAN SETTLEMENT
JRATUNSELUNA FLOOD CONTROL PROJECT
 COMPONENT: WEST FLOODWAY / GARANG RIVER IMPROVEMENT
CHANNEL AND DIKE WORKS
WEST FLOODWAY
CROSS SECTIONS (38/39)

PROVINCE: CENTRAL JAVA
 DISTRICT: SEMARANG CITY
 DRAWING NO. WG-PF-CR-Cr-53
 SHEET NO. 55

SAJAH INTERNATIONAL COOPERATION AGENCY
 CJI ENGINEERING CO., LTD. IN ASSOCIATION WITH
 PACIFIC CONSULTANTS INTERNATIONAL AND
 PAKSI INTERNATIONAL P.C.
 CHIEF OF PLANNING AND DESIGN
 PROJECT MANAGER

DESIGNED: [Signature]
 CHECKED: [Signature]
 DATE: [Date]
 CONTRACT NO.: [Number]

WF. 99+30

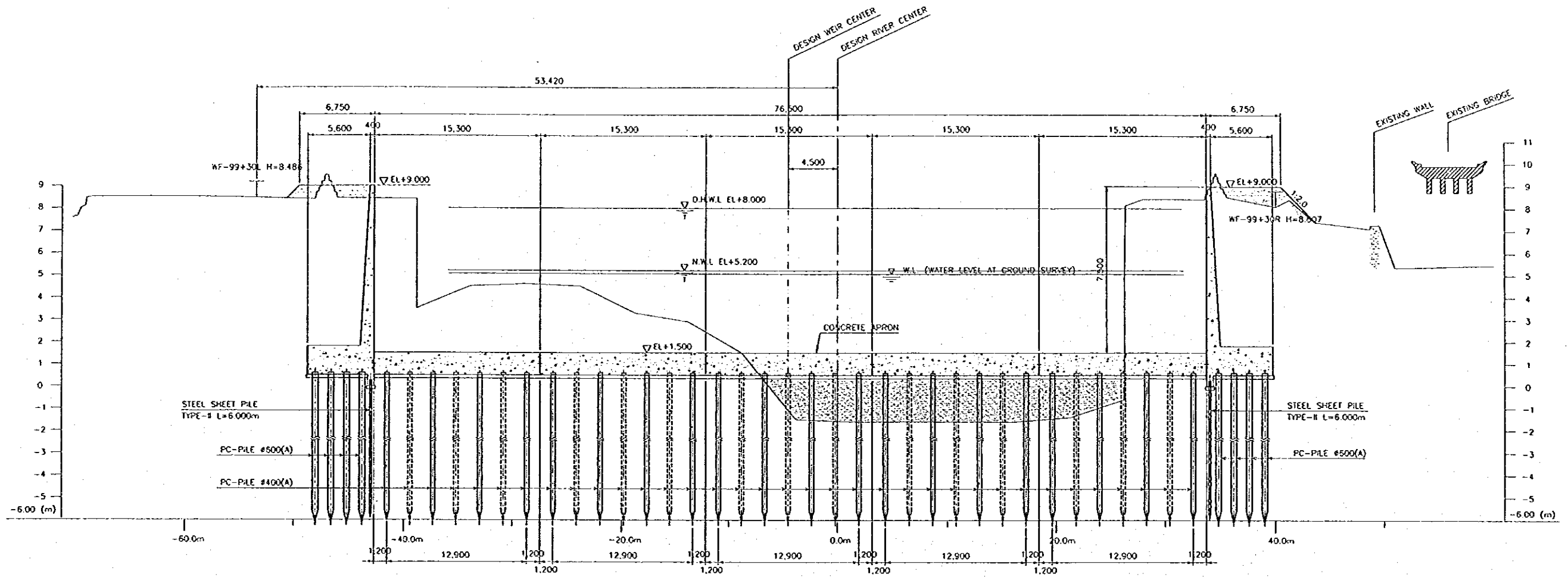

WF. 99+43

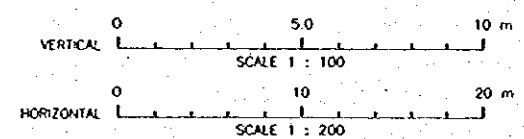
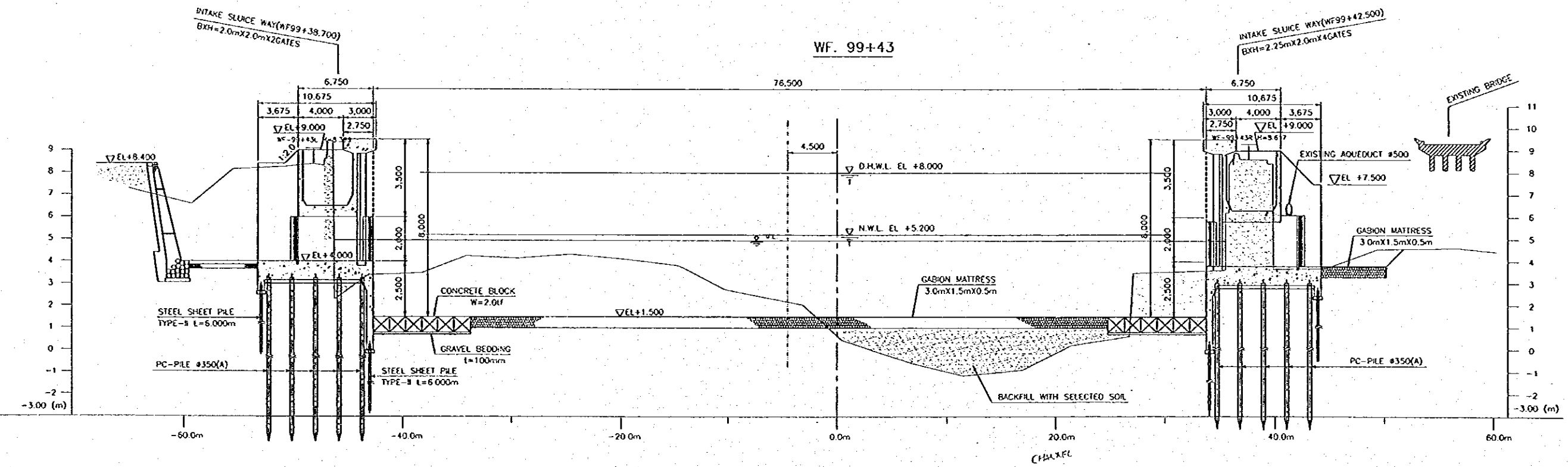

NO.	DATE	REVISIONS	ORIGINATED	DESIGNED	APPROVED

THE REPUBLIC OF INDONESIA MINISTRY OF PUBLIC WORKS DIRECTORATE GENERAL OF WATER RESOURCES DEVELOPMENT AND DIRECTORATE GENERAL OF HUMAN SETTLEMENT		PROVINCE CENTRAL JAVA
IRATUNSELUNA FLOOD CONTROL PROJECT COMPONENT: WEST FLOODWAY / GARANG RIVER IMPROVEMENT CHANNEL AND DIKE WORKS GARANG RIVER CROSS SECTIONS (4/31)		PROJECT NAME FLOOD CONTROL, URBAN DRAINAGE AND WATER RESOURCE DEVELOPMENT IN SEMARANG IN THE REPUBLIC OF INDONESIA
LAYAN INTERNATIONAL CONSULTING FIRM CTE ENGINEERING CO., LTD. IN ASSOCIATION WITH PACIFIC CONSULTANTS INTERNATIONAL AND PARCO INTERNATIONAL, INC.		DISTRICT SEMARANG CITY
DESIGNED: [Signature] CHECKED: [Signature]		DRAWING NO. WG-PH-CH-CT-55 SHEET NO. 57
APPROVED: [Signature] CHIEF OF PLANNING AND DESIGN PROJECT MANAGER		DATE: [Date] CONTRACT NO.

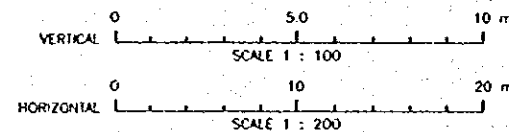
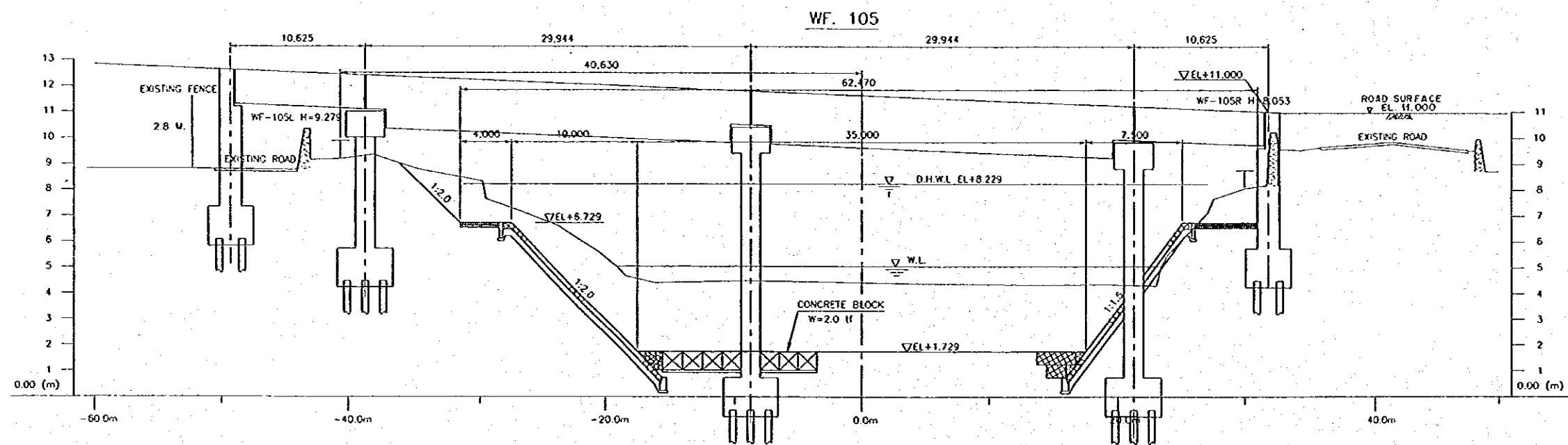
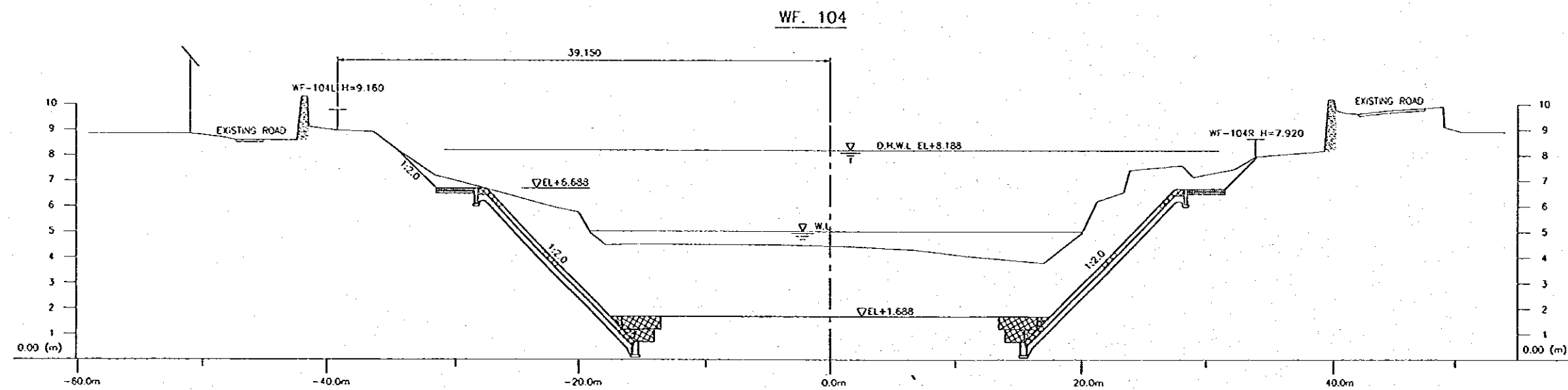
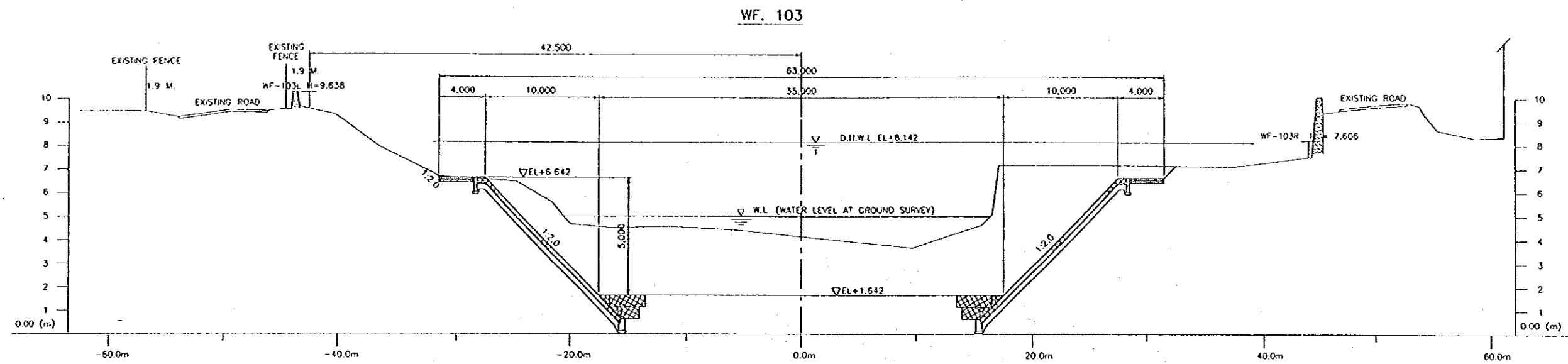

NO.	DATE	REVISIONS	ORIGINATED	DESIGNED	APPROVED

THE REPUBLIC OF INDONESIA MINISTRY OF PUBLIC WORKS DIRECTORATE GENERAL OF WATER RESOURCES DEVELOPMENT AND DIRECTORATE GENERAL OF HUMAN SETTLEMENT		PROVINCE CENTRAL JAWA
JRATUNSELUNA FLOOD CONTROL PROJECT COMPONENT: WEST FLOODWAY / GARANG RIVER IMPROVEMENT CHANNEL AND DIKE WORKS GARANG RIVER CROSS SECTIONS (3 / 34)		PROJECT NAME FLOOD CONTROL, URBAN DRAINAGE AND WATER RESOURCES DEVELOPMENT IN SEMARANG IN THE REPUBLIC OF INDONESIA
JAPAN INTERNATIONAL COOPERATION AGENCY CITI ENGINEERING CO., LTD. IN ASSOCIATION WITH PACIFIC CONSULTANTS INTERNATIONAL AND PACIFIC INTERNATIONAL INC.		DISTRICT SEMARANG CITY
DESIGNED CHECKED		DRAWING NO. 89 - P1 - CH - CR. 51 SHEET NO. 59
APPROVED CHIEF OF PLANNING AND DESIGN PROJECT MANAGER		DATE CONTRACT NO.

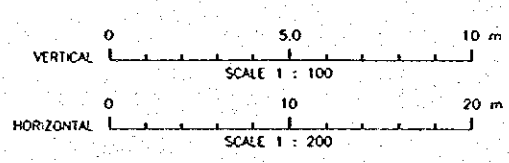
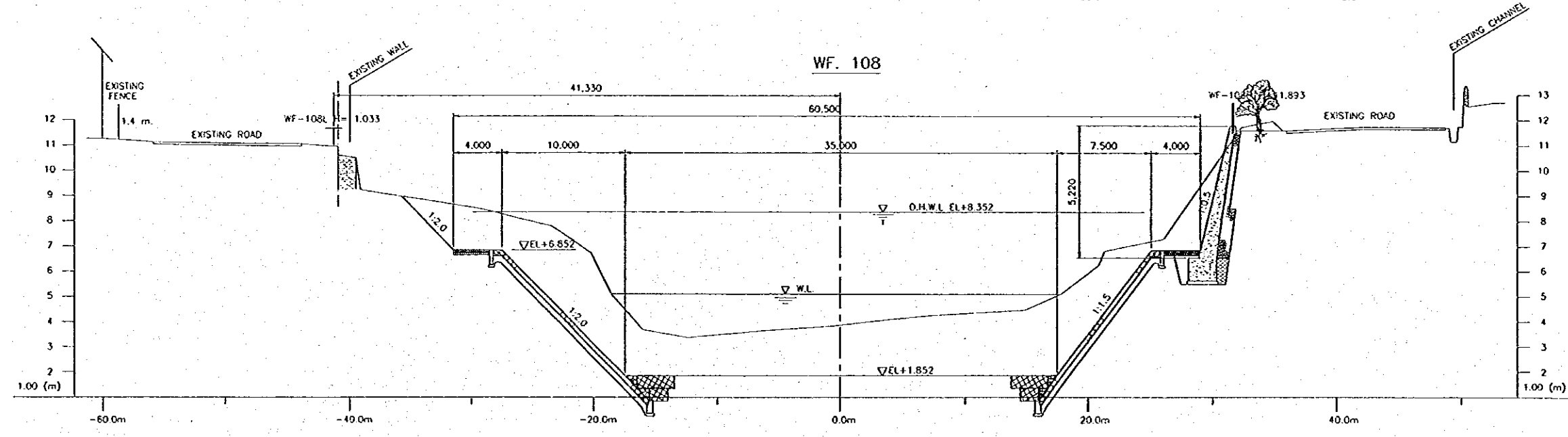
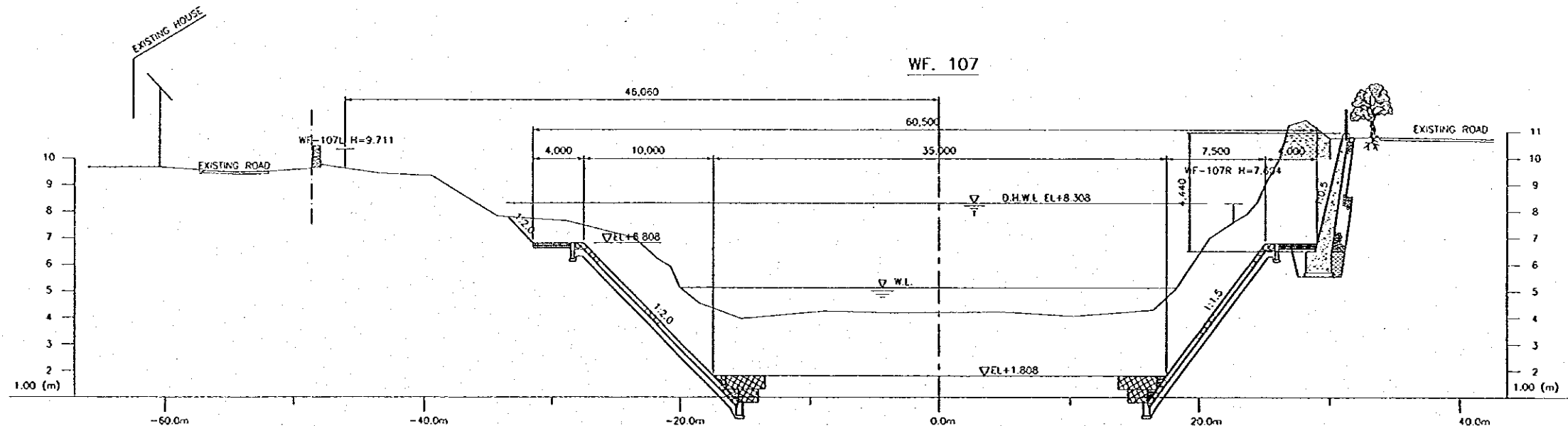
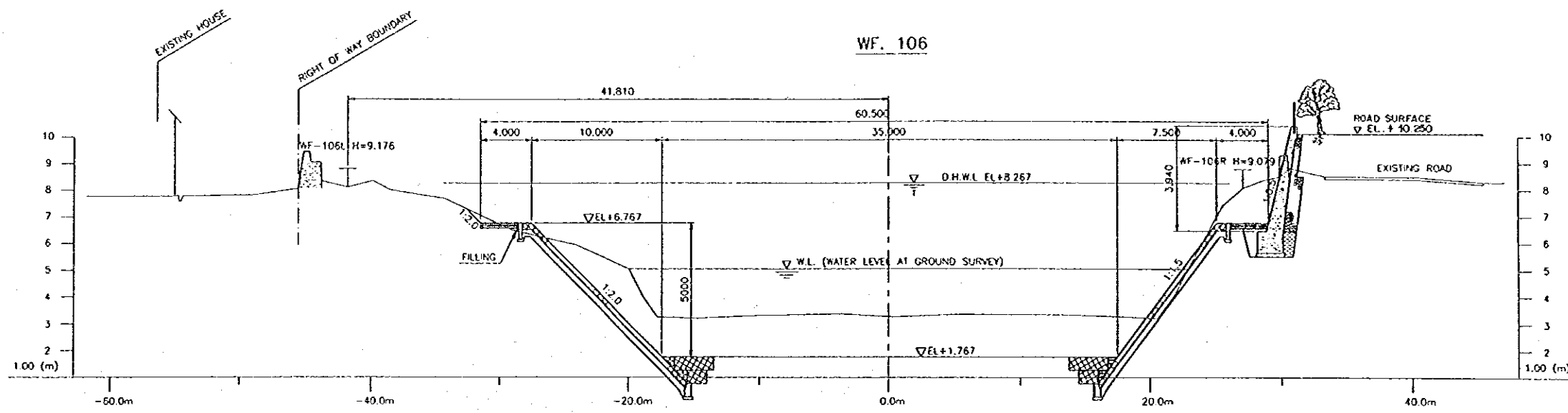

NO.	DATE	REVISIONS	ORIGINATED	DESIGNED	APPROVED

THE REPUBLIC OF INDONESIA MINISTRY OF PUBLIC WORKS DIRECTORATE GENERAL OF WATER RESOURCES DEVELOPMENT AND DIRECTORATE GENERAL OF HUMAN SETTLEMENT		PROVINCE: CENTRAL JAWA PROJECT NAME: FLOOD CONTROL, URBAN DRAINAGE AND WATER RESOURCES DEVELOPMENT IN SEMARANG IN THE REPUBLIC OF INDONESIA DISTRICT: SEMARANG CITY DRAWING NO. W9-P1-CH-CR.58 SHEET NO. 66
IRATUNSELUNA FLOOD CONTROL PROJECT COMPONENT: WEST FLOODWAY / GARANG RIVER IMPROVEMENT CHANNEL AND DIKE WORKS GARANG RIVER CROSS SECTIONS (4/31)		DATE: _____ CONTRACT NO.: _____
JAPAN INTERNATIONAL COOPERATION AGENCY CTE ENGINEERING CO., LTD. IN ASSOCIATION WITH PACIFIC CONSULTANTS INTERNATIONAL AND PARCO INTERNATIONAL, INC.	DESIGNED: _____ CHECKED: _____ CROW OF PLANNING AND DESIGN PROJECT MANAGER	DATE: _____ CONTRACT NO.: _____

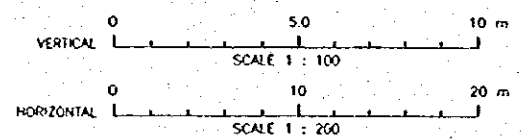
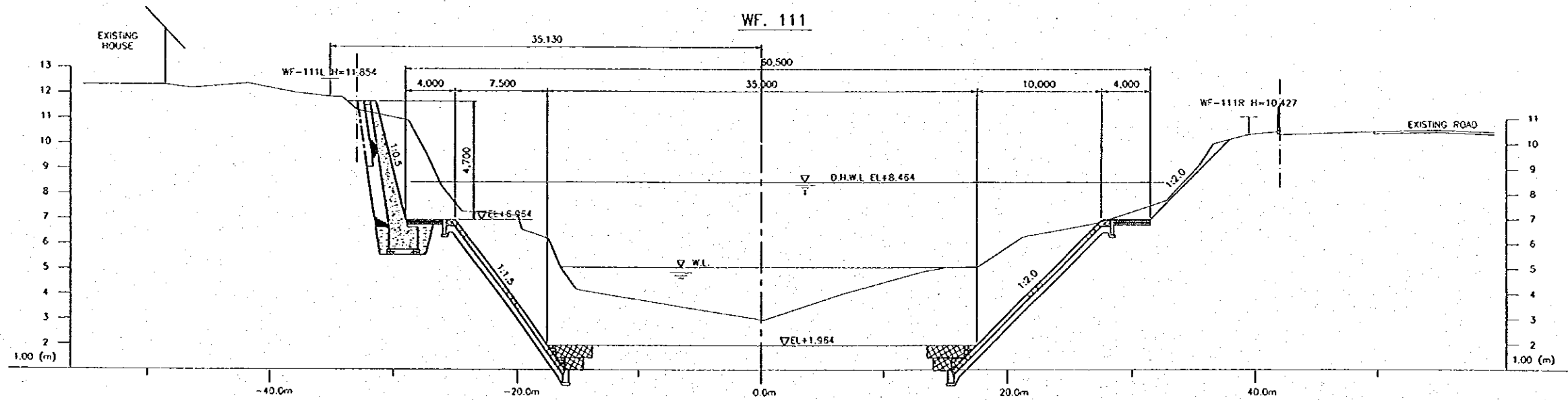
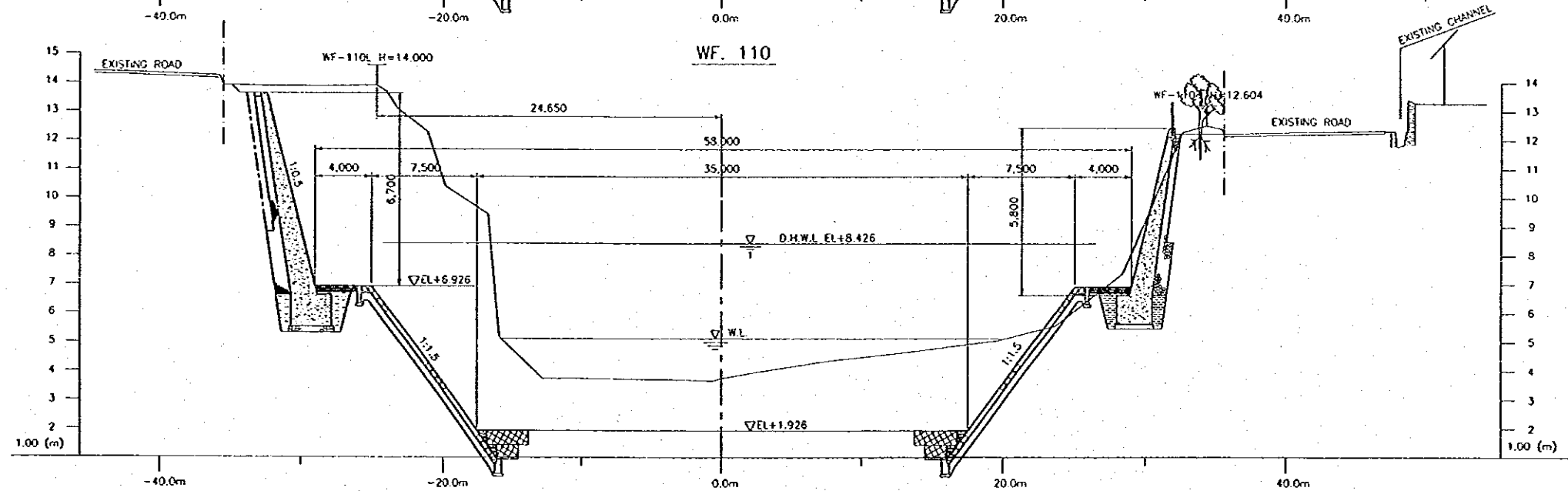
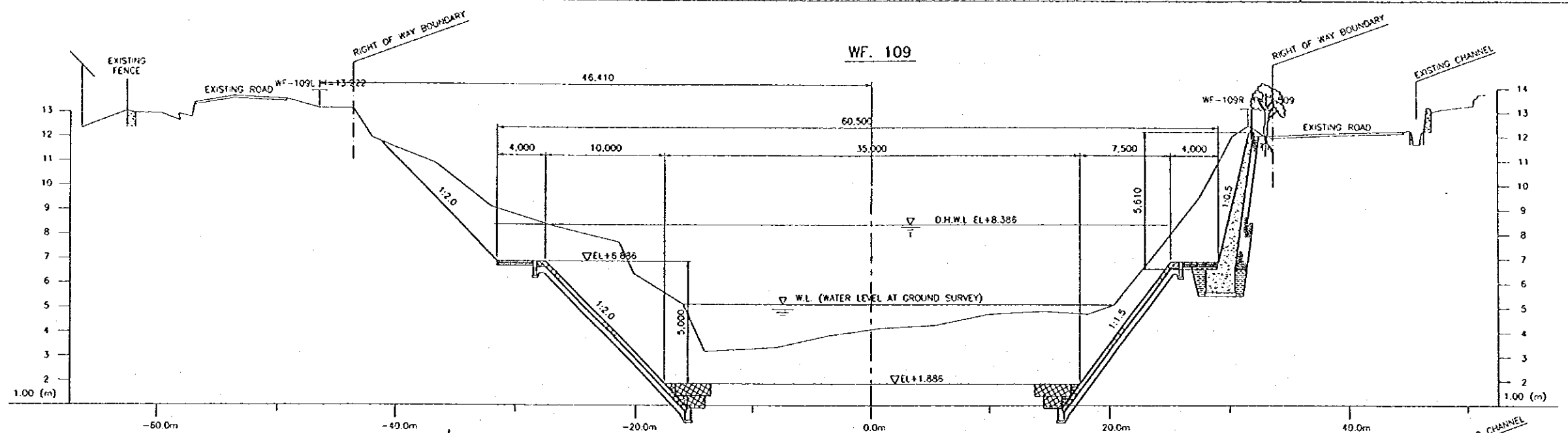

NO.	DATE	REVISIONS	ORIGINATED	DESIGNED	APPROVED

THE REPUBLIC OF INDONESIA MINISTRY OF PUBLIC WORKS DIRECTORATE GENERAL OF WATER RESOURCES DEVELOPMENT AND DIRECTORATE GENERAL OF HUMAN SETTLEMENT		PROVINCE CENTRAL JAVA
PRATUNSELUNA FLOOD CONTROL PROJECT COMPONENT: WEST FLOODWAY / GARANO RIVER IMPROVEMENT CHANNEL AND DIKE WORKS GARANG RIVER CROSS SECTIONS (5/31)		PROJECT NAME FLOOD CONTROL, URBAN DRAINAGE AND WATER RESOURCE DEVELOPMENT IN SEMARANG IN THE REPUBLIC OF INDONESIA
JAPAN INTERNATIONAL COOPERATION AGENCY CITI ENGINEERING CO., LTD. IN ASSOCIATION WITH PACIFIC CONSULTANTS INTERNATIONAL, INC. JAPCO INTERNATIONAL, INC.		DISTRICT SEMARANG CITY
DESIGNED CHECKED CURVE OF PLANNING AND DESIGN PROJECT MANAGER		DRAWING NO. WS-P1-CH-Cr. 58 SHEET NO. 61 DATE CONTRACT NO.

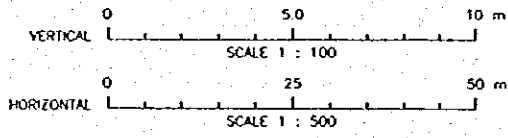
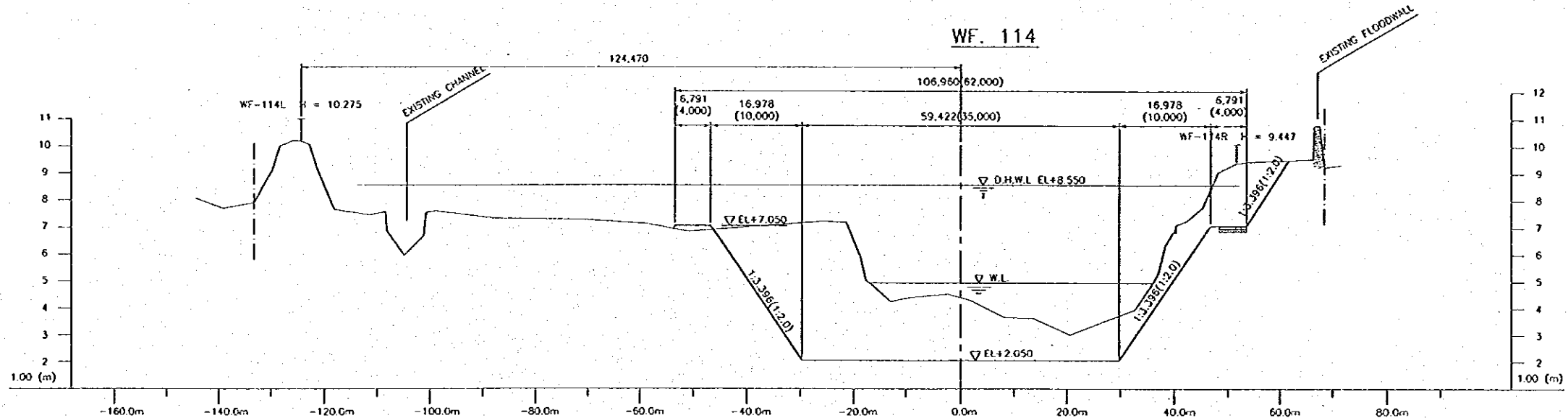
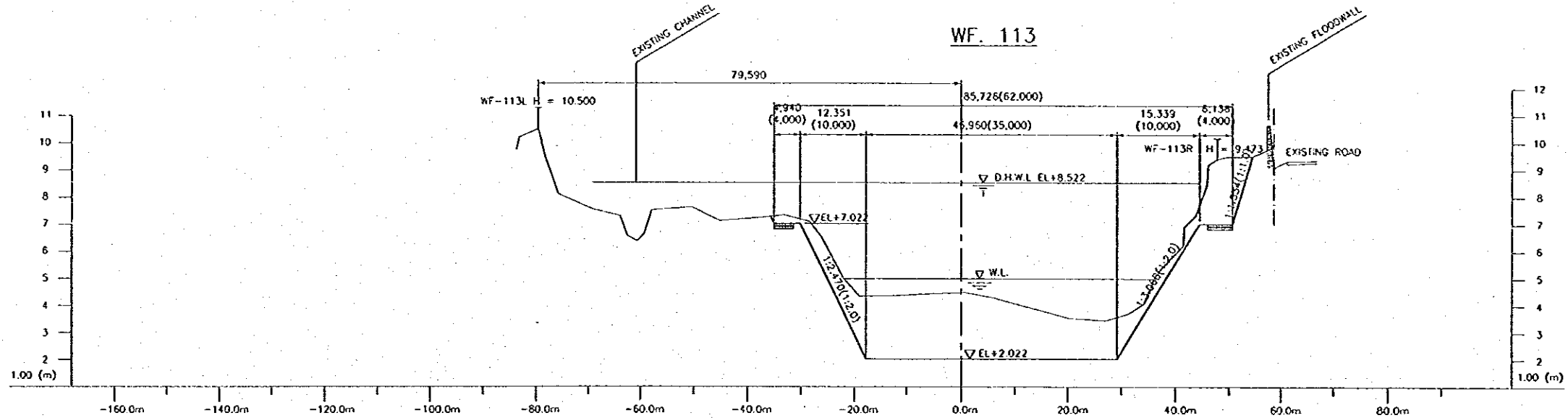
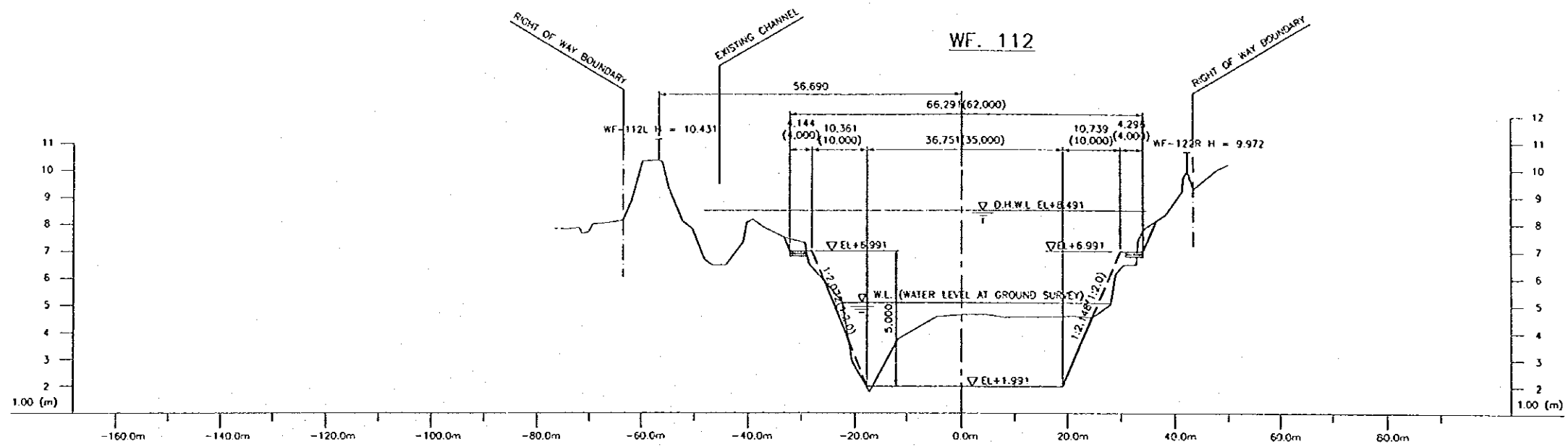

The number in parentheses shows the design dimension of channel cross section which is perpendicular to the design center line of river channel.

NO.	DATE	REVISIONS	ORIGINATED	DESIGNED	APPROVED

THE REPUBLIC OF INDONESIA MINISTRY OF PUBLIC WORKS DIRECTORATE GENERAL OF WATER RESOURCES DEVELOPMENT AND DIRECTORATE GENERAL OF HUMAN SETTLEMENT		PROVINCE: CENTRAL JAVA PROJECT NAME: FLOOD CONTROL, LEAKY DRAINAGE AND WATER SERVICE DEVELOPMENT IN SEMARANG IN THE REPUBLIC OF INDONESIA DISTRICT: SEMARANG CITY DRAWING NO. WS-P-1-CH-Cr. 64 SHEET NO. 61 DATE: _____ CONTRACT NO. _____
DRATUNSELUNA FLOOD CONTROL PROJECT COMPONENT: WEST FLOODWAY / GARANG RIVER IMPROVEMENT CHANNEL AND DIKE WORKS GARANG RIVER CROSS SECTIONS (6/31)		DESIGNED: _____ CHECKED: _____ APPROVED: _____ PROJECT MANAGER
JAWA INTERNATIONAL COORDINATION CENTER CITI ENGINEERING CO., LTD. IN ASSOCIATION WITH PACIFIC CONSULTANTS INTERNATIONAL AND JAWA INTERNATIONAL, INC.		APPROVED: _____ CENTER OF PLANNING AND DESIGN

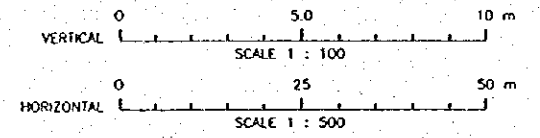
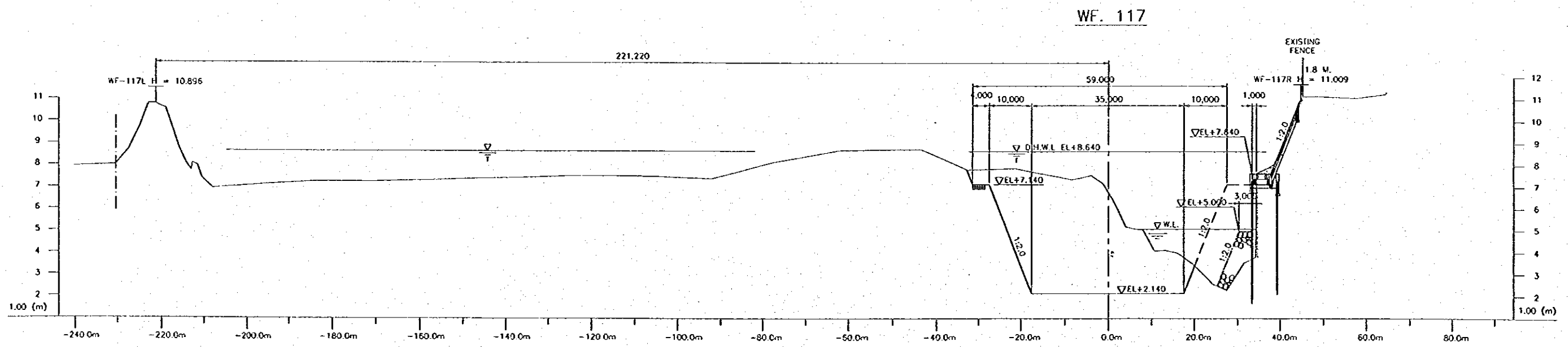
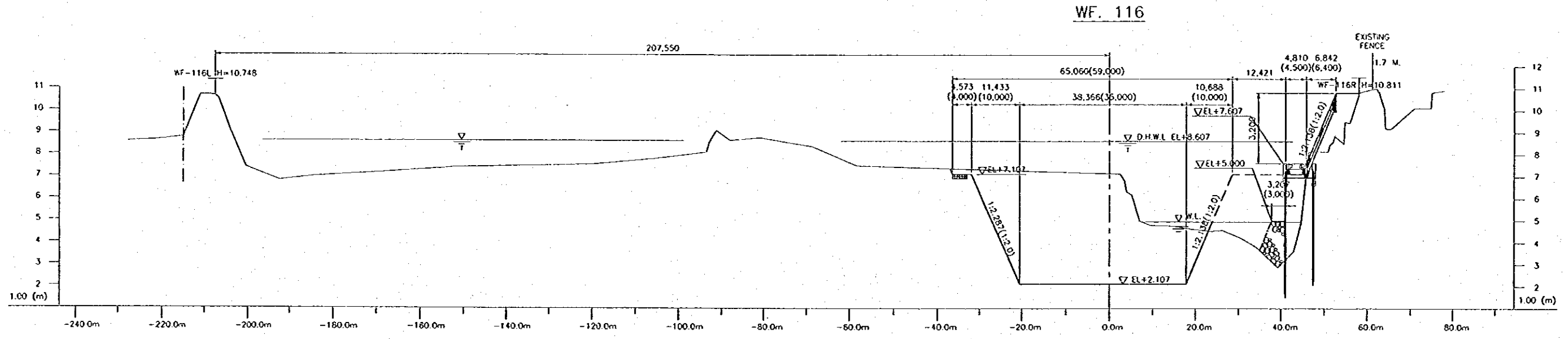
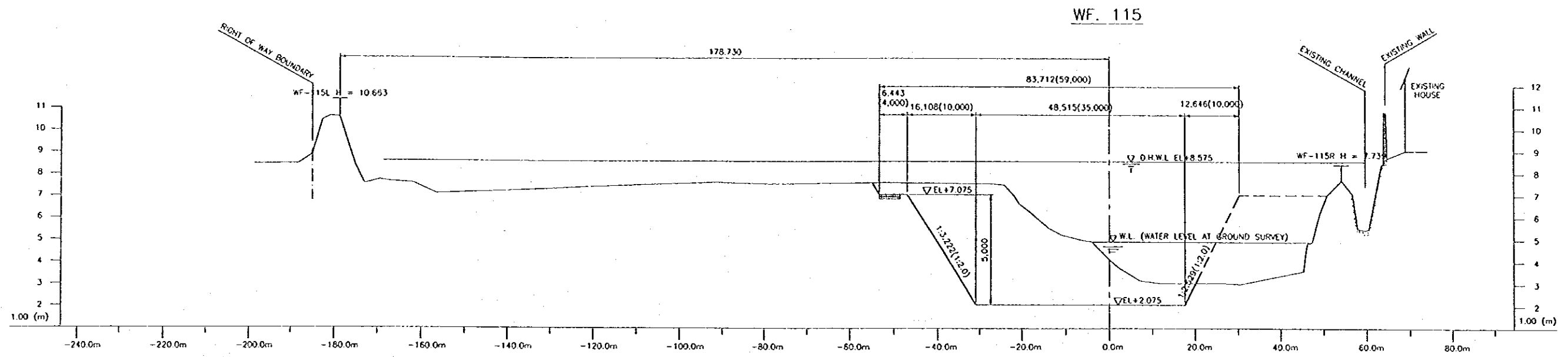

The number in parentheses shows the design dimensions of channel cross section which is perpendicular to the design center line of river channel. (WF-115, WF-116)

NO.	DATE	REVISIONS	ORIGINATED	DESIGNED	APPROVED

THE REPUBLIC OF INDONESIA
 MINISTRY OF PUBLIC WORKS
 DIRECTORATE GENERAL OF WATER RESOURCES DEVELOPMENT AND DIRECTORATE GENERAL OF HUMAN SETTLEMENT

PROPOSAL: CENTRAL JAVA
 PROJECT NAME: FLOOD CONTROL, URBAN DRAINAGE AND WATER RESOURCES DEVELOPMENT IN SEMARANG IN THE REPUBLIC OF INDONESIA
 DISTRICT: SEMARANG CITY
 DRAWING NO. W8-P1-CH-Cr. 61
 SHEET NO. 63

JAPAN INTERNATIONAL COOPERATION AGENCY
 CCI ENGINEERING CO., LTD. IN ASSOCIATION WITH
 PACIFIC CONSULTANTS INTERNATIONAL INC.
 AND INTERNATIONAL ENGINEERING INC.

DESIGNED: [Signature]
 CHECKED: [Signature]
 CHIEF OF PLANNING AND DESIGN
 PROJECT MANAGER

DATE: [Date]
 CONTRACT NO. [Number]

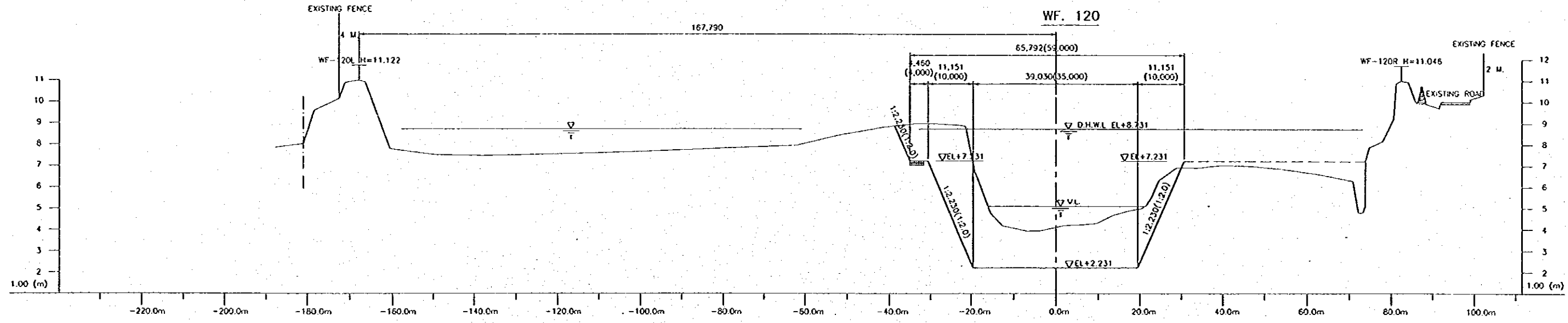
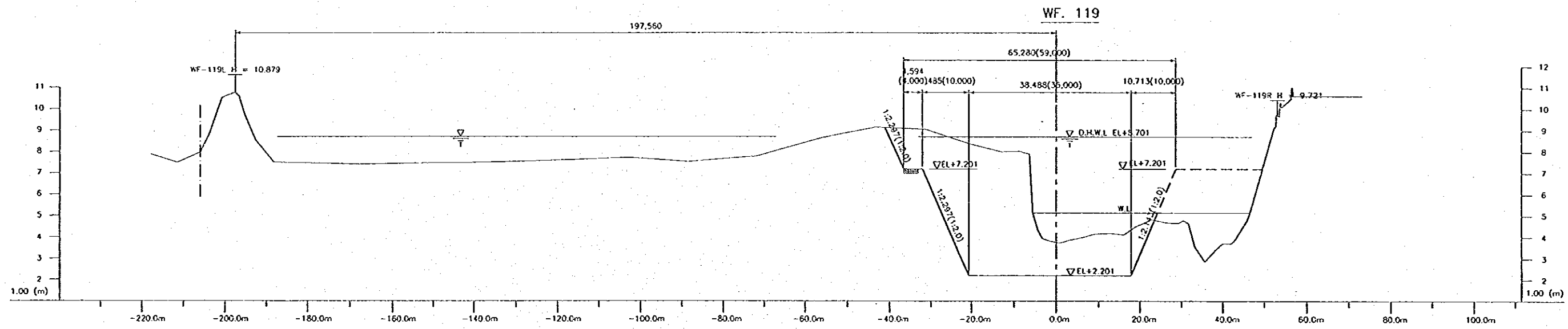
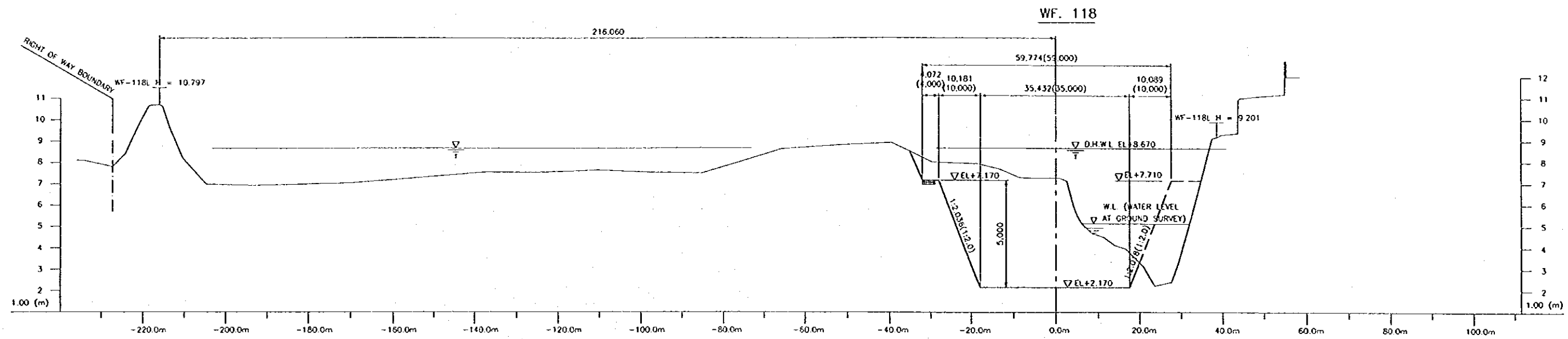

The number in parentheses shows the design dimensions of channel cross section which is perpendicular to the design center line of river channel.

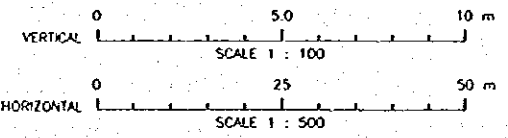

NO.	DATE	REVISIONS	ORIGINATED	DESIGNED	APPROVED

THE REPUBLIC OF INDONESIA MINISTRY OF PUBLIC WORKS DIRECTORATE GENERAL OF WATER RESOURCES DEVELOPMENT AND DIRECTORATE GENERAL OF HUMAN SETTLEMENT		PROVINCE CENTRAL JAVA
IRATUNSELUNA FLOOD CONTROL PROJECT COMPONENT: WEST FLOODWAY / GARANG RIVER IMPROVEMENT CHANNEL AND DIKE WORKS GARANG RIVER CROSS SECTIONS (8 / 31)		PROJECT NAME FLOOD CONTROL, URBAN DRAINAGE AND WATER RESOURCES DEVELOPMENT IN SEMARANG IN THE REPUBLIC OF INDONESIA
DISTRICT SEMARANG CITY		DRAWING NO. WS - P4 - CH - Cr. 82
SHEET NO. 64		DATE
CONTRACT NO.		PROJECT MANAGER

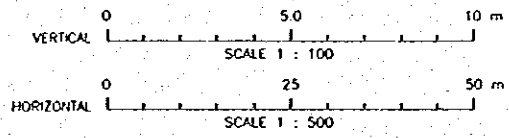
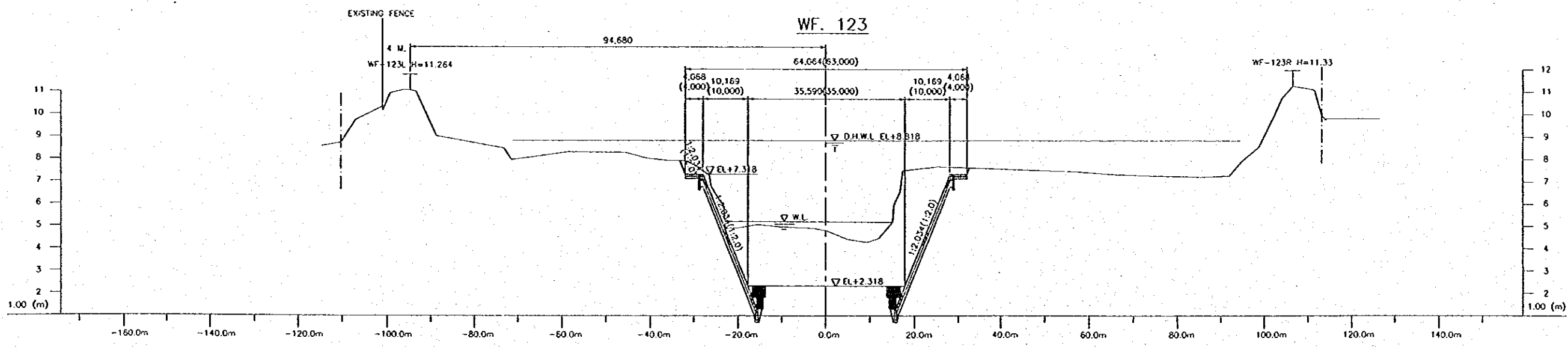
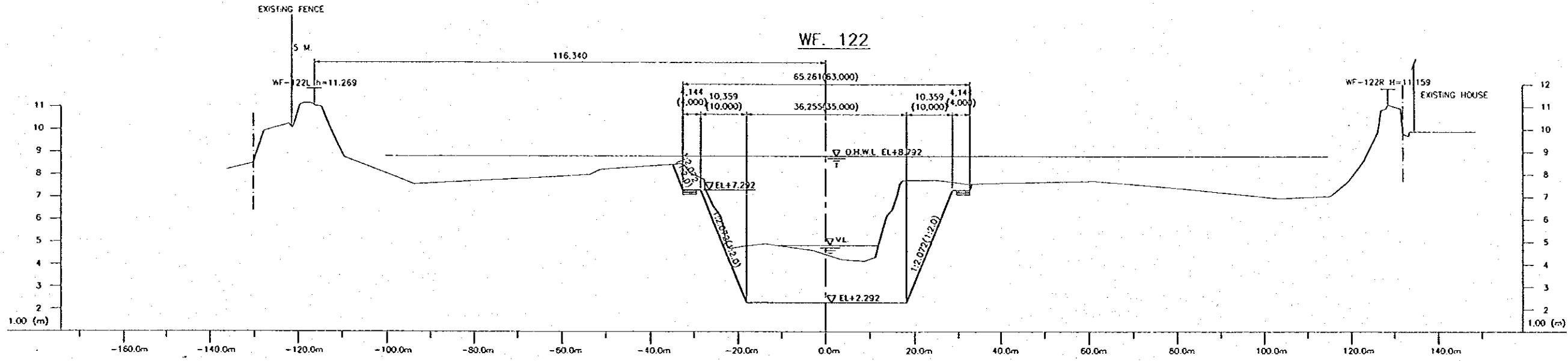
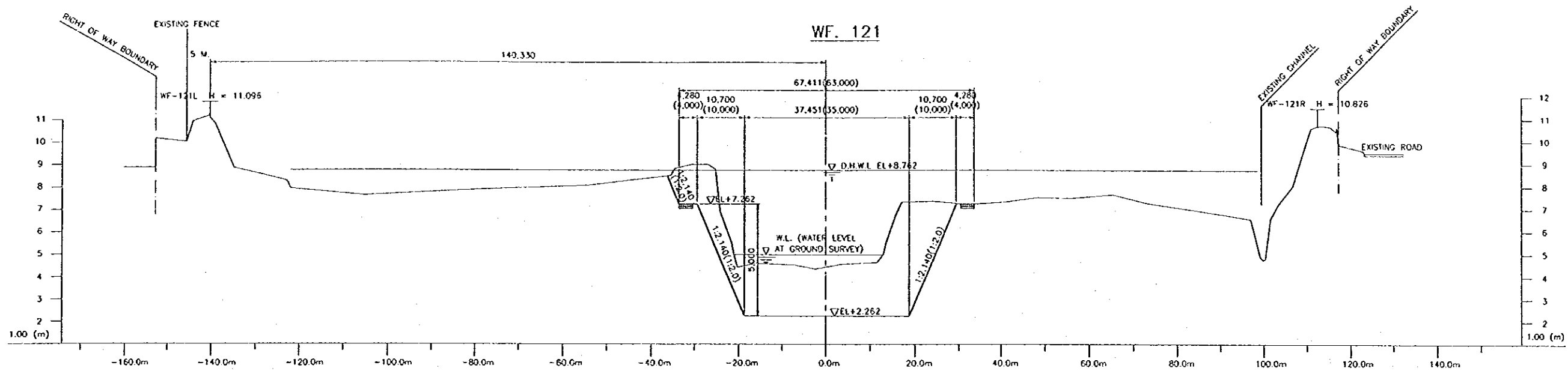

The number in parentheses shows the design dimensions of channel cross section which is perpendicular to design center line of river channel.

NO.	DATE	REVISIONS	ORIGINATED	DESIGNED	APPROVED

THE REPUBLIC OF INDONESIA MINISTRY OF PUBLIC WORKS DIRECTORATE GENERAL OF WATER RESOURCES DEVELOPMENT AND DIRECTORATE GENERAL OF HUMAN SETTLEMENT		PROVINCE CENTRAL JAVA
JRATUNSELUNA FLOOD CONTROL PROJECT COMPONENT: WEST FLOODWAY / GARANG RIVER IMPROVEMENT CHANNEL AND DIKE WORKS GARANG RIVER CROSS SECTIONS (9 / 31)		PROJECT NAME FLOOD CONTROL, URBAN DRAINAGE AND WATER RESOURCES DEVELOPMENT IN SEMARANG IN THE REPUBLIC OF INDONESIA
LULUWAT INTERNATIONAL CONSULTING AGENCY PT. INDOBARANG CO., LTD. IN ASSOCIATION WITH PACIFIC CONSULTANTS INTERNATIONAL AND YANCO INTERNATIONAL INC.		DISTRICT SEMARANG CITY
CHECKED DESIGNED PROJECT MANAGER		DRAWING NO. WU - P1 - CH - C-83 SUBSET NO. 65 DATE CONTRACT NO.

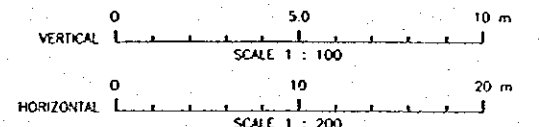
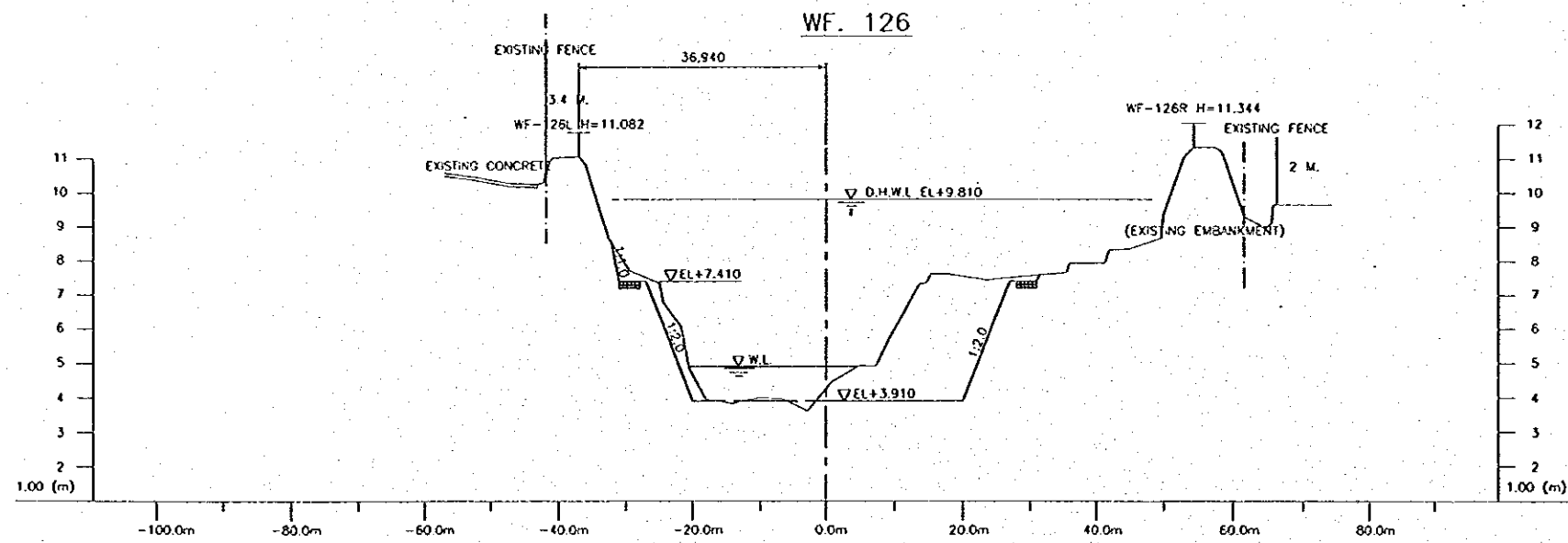
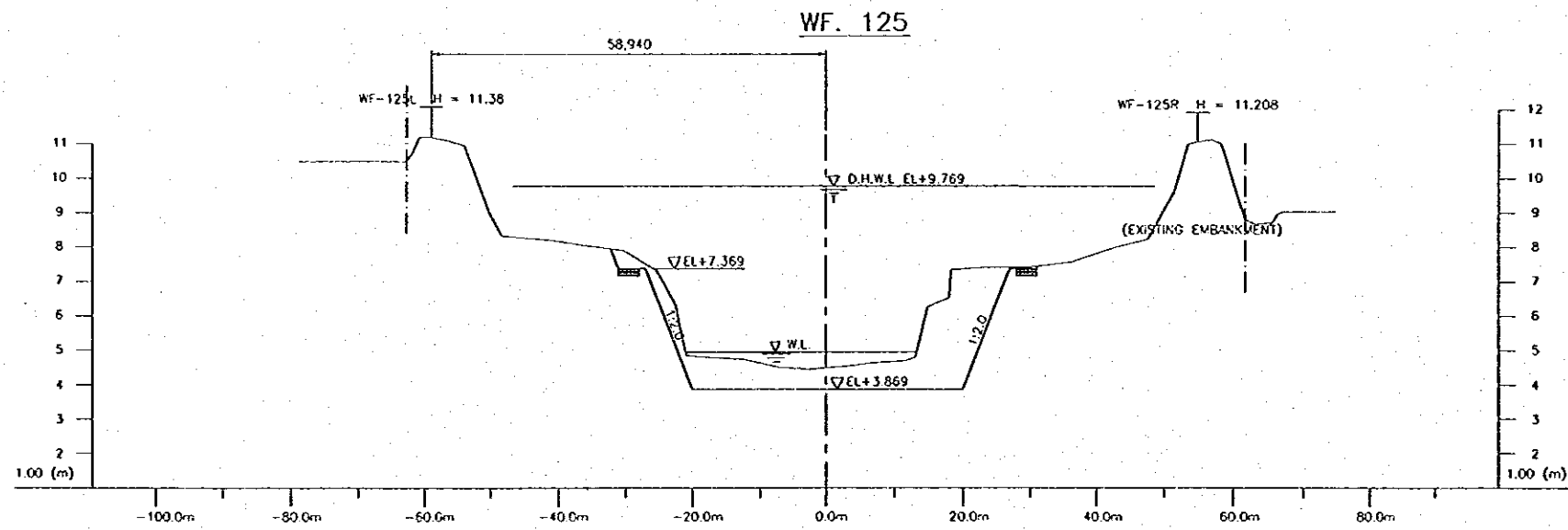
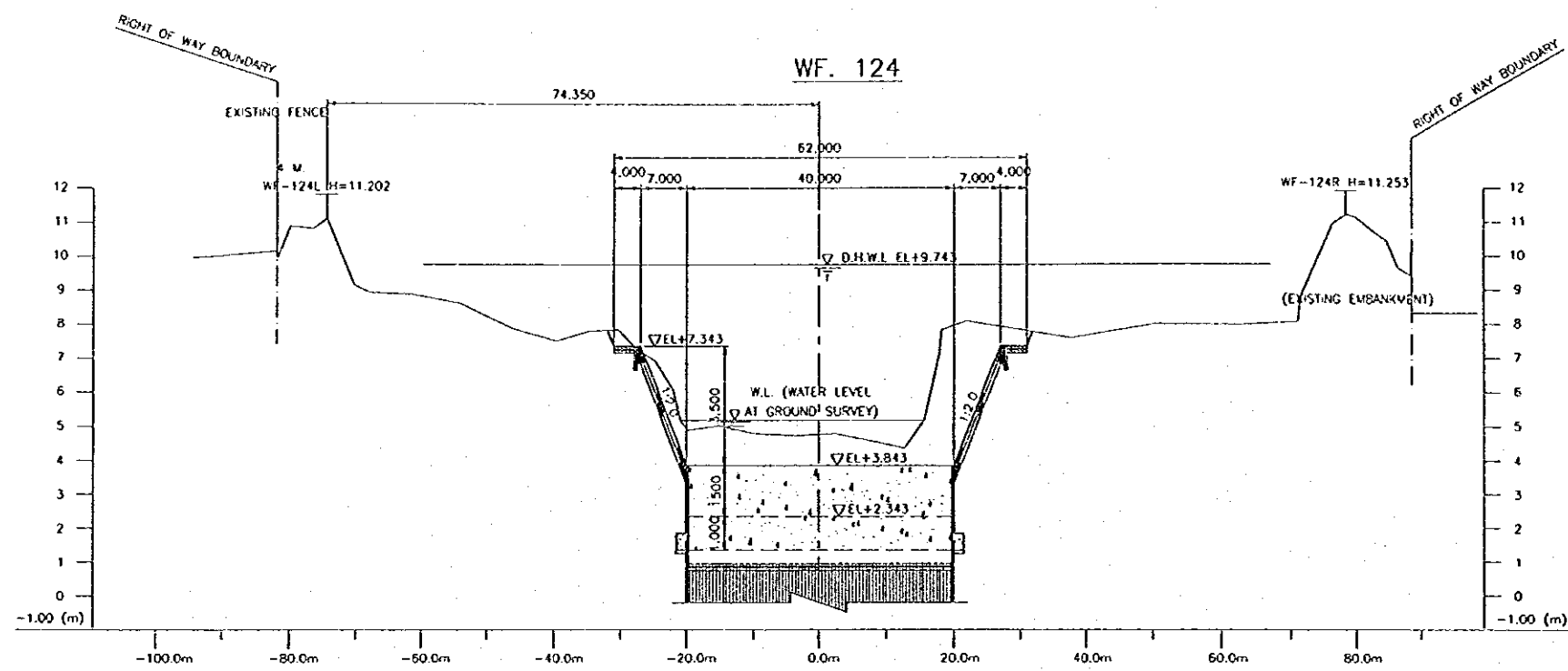

NO.	DATE	REVISIONS	ORIGINATED	DESIGNED	APPROVED

THE REPUBLIC OF INDONESIA MINISTRY OF PUBLIC WORKS DIRECTORATE GENERAL OF WATER RESOURCES DEVELOPMENT AND DIRECTORATE GENERAL OF HUMAN SETTLEMENT		PROVINCE CENTRAL JAVA
JATUNSELUNA FLOOD CONTROL PROJECT COMPONENT: WEST FLOODWAY / GARANG RIVER IMPROVEMENT CHANNEL AND DIKE WORKS GARANG RIVER CROSS SECTIONS (40/31)		PROJECT NAME FLOOD CONTROL, URBAN DRAINAGE AND WATER RESOURCES DEVELOPMENT IN SEMARANG IN THE REPUBLIC OF INDONESIA
LAMAR INTERNATIONAL COOPERATION AGENCY CIE ENGINEERING CO. LTD. IN ASSOCIATION WITH PACIFIC CONSULTANTS INTERNATIONAL AND JABOD PTE. INTERNATIONAL INC.		DISTRICT SEMARANG CITY DRAWING NO. W2-P1-GH-CF-64 SHEET NO. 66
DESIGNED	CHECKED	DATE
ORIGINATED	APPROVED	CONTRACT NO.
CORE OF PLANNING AND DESIGN PROJECT MANAGER		

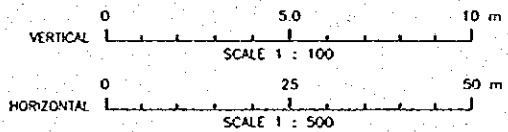
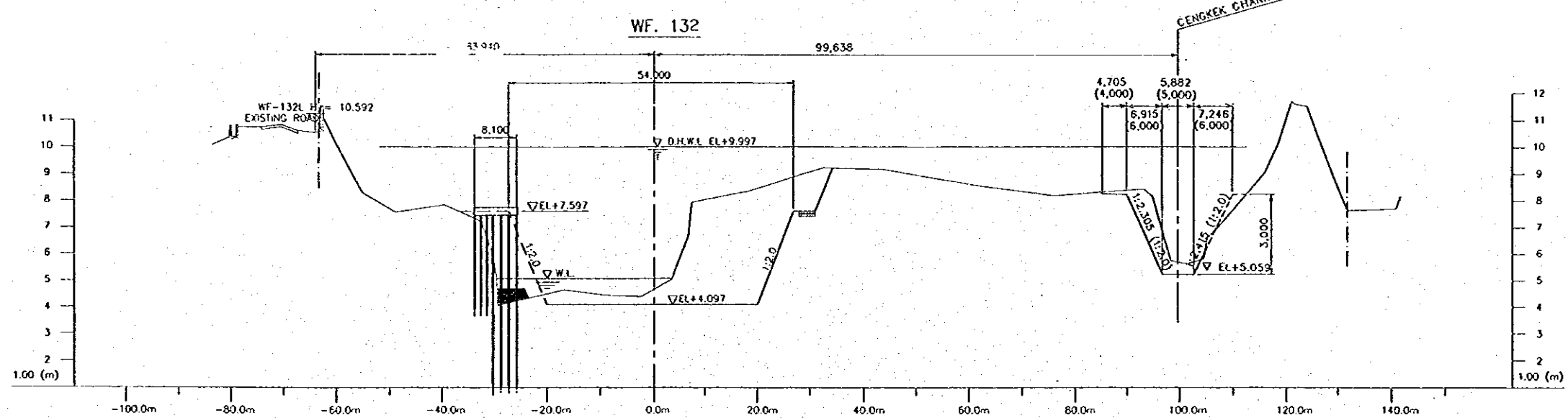
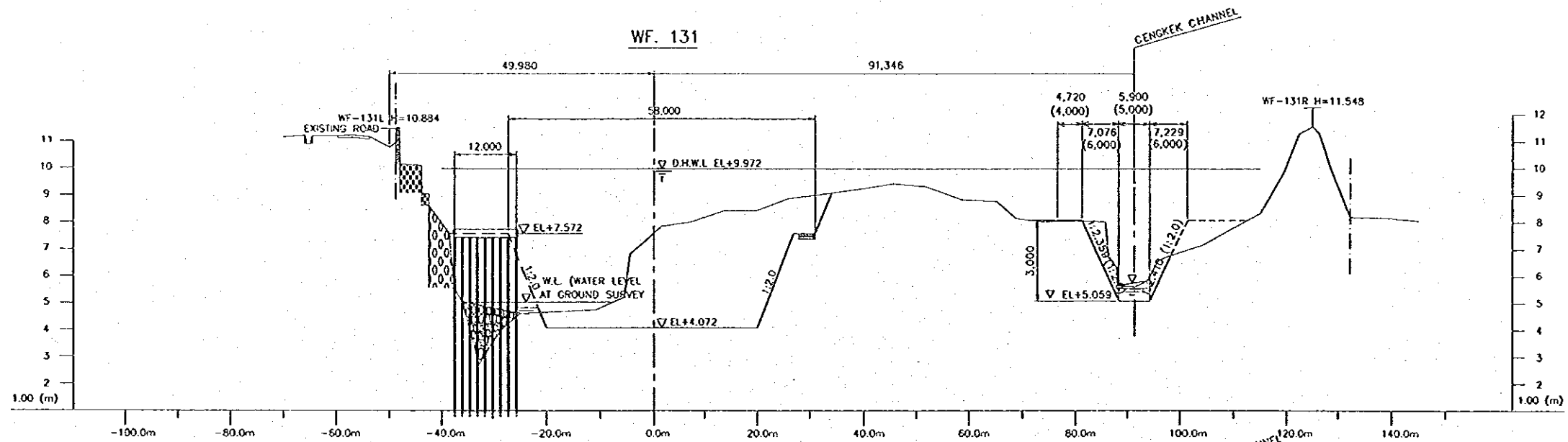
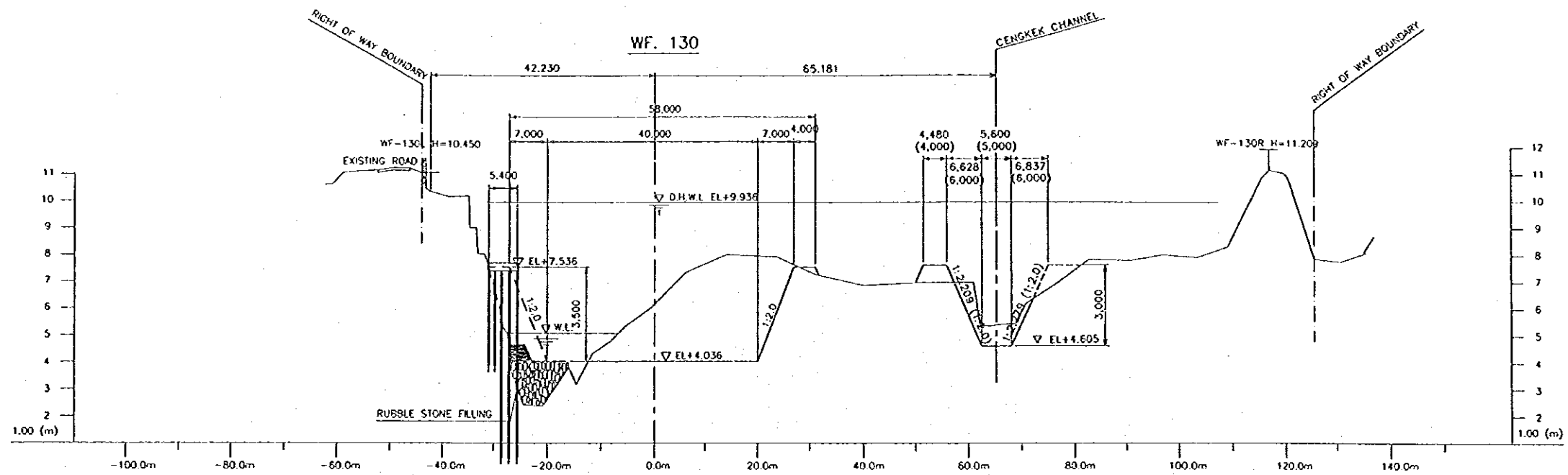

NO.	DATE	REVISIONS	ORIGINATED	DESIGNED	APPROVED

THE REPUBLIC OF INDONESIA
 MINISTRY OF PUBLIC WORKS
 DIRECTORATE GENERAL OF WATER RESOURCES DEVELOPMENT
 AND DIRECTORATE GENERAL OF HUMAN SETTLEMENT

JRATUNSELUNA FLOOD CONTROL PROJECT
 COMPONENT: WEST FLOODWAY / GARANO RIVER IMPROVEMENT
CHANNEL AND DIKE WORKS
GARANG RIVER
CROSS SECTIONS (12 / 31)

PROVINCE: CENTRAL JAVA
 PROJECT NAME: FLOOD CONTROL, STREAM DRAINAGE AND WATER RESOURCES DEVELOPMENT BY BANGALANG IN THE REPUBLIC OF INDONESIA
 DISTRICT: SEMARANG CITY
 DRAWING NO. WF-P1-CH-CV-68
 SHEET NO. 68
 DATE: _____
 CONTRACT NO. _____

DESIGNED: [Signature]
 CHECKED: [Signature]
 PROJECT MANAGER: [Signature]

APPROVED: _____

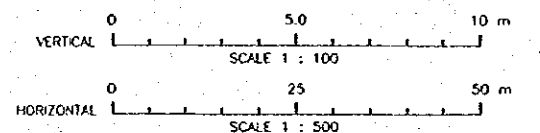
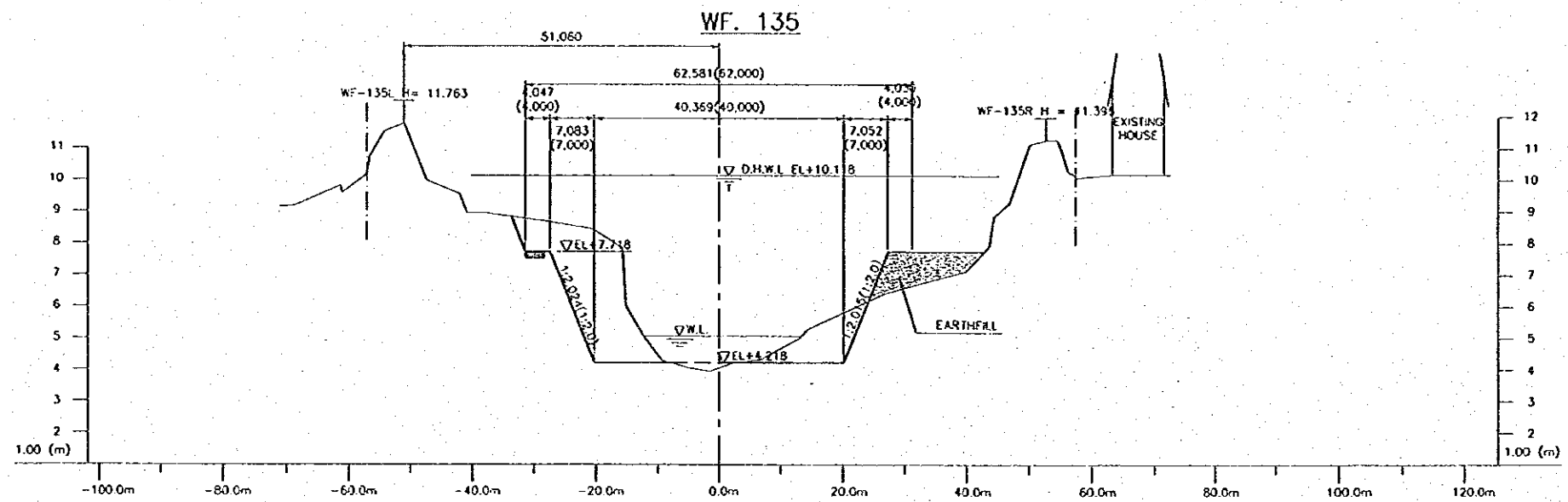
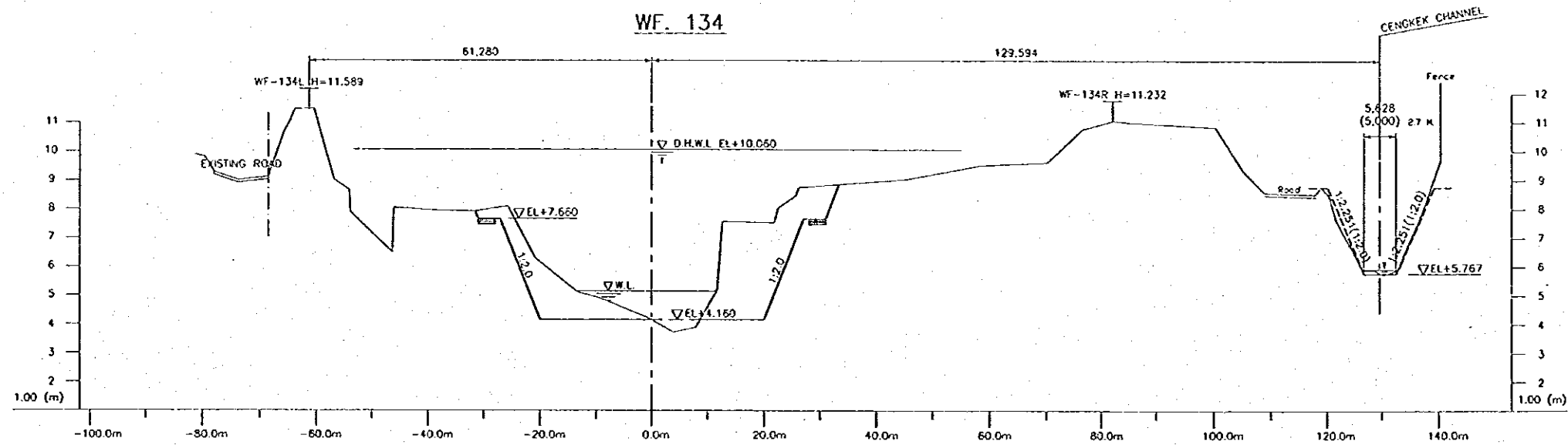
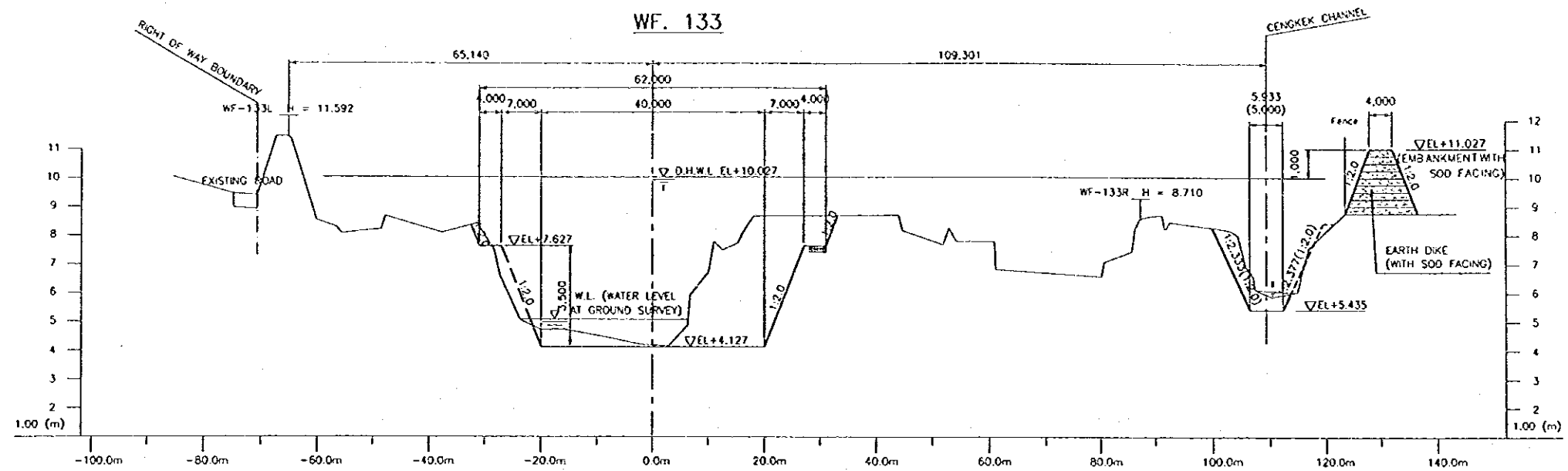

The number in parentheses shows the design dimensions of channel cross section which is perpendicular to the design center line of river channel. (WF-135)

NO.	DATE	REVISION	ORIGINATOR	DESIGNED	APPROVED

THE REPUBLIC OF INDONESIA MINISTRY OF PUBLIC WORKS DIRECTORATE GENERAL OF WATER RESOURCES DEVELOPMENT AND DIRECTORATE GENERAL OF HUMAN SETTLEMENT		PROVINCE: CENTRAL JAWA PROJECT NAME: FLOOD CONTROL, URBAN DRAINAGE AND WATER RESOURCES DEVELOPMENT IN SEMARANG IN THE REPUBLIC OF INDONESIA DISTRICT: SEMARANG CITY DRAWING NO. WG - PI - CH - CA - 67 SHEET NO. 69
IRATUNSELUNA FLOOD CONTROL PROJECT COMPONENT: WEST FLOODWAY / GARANG RIVER IMPROVEMENT CHANNEL AND DIKE WORKS GARANG RIVER CROSS SECTIONS (13 / 31)		DATE: _____ CONTRACT NO.: _____
JAPAN INTERNATIONAL COOPERATION AGENCY OTE ENGINEERING CO. LTD. IN ASSOCIATION WITH PACIFIC CONSULTANTS INTERNATIONAL AND JACOBS ENGINEERING INC.	DESIGNED: _____ CHECKED: _____ CHIEF OF PLANNING AND DESIGN	APPROVED: _____ PROJECT MANAGER

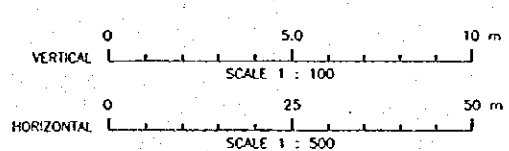
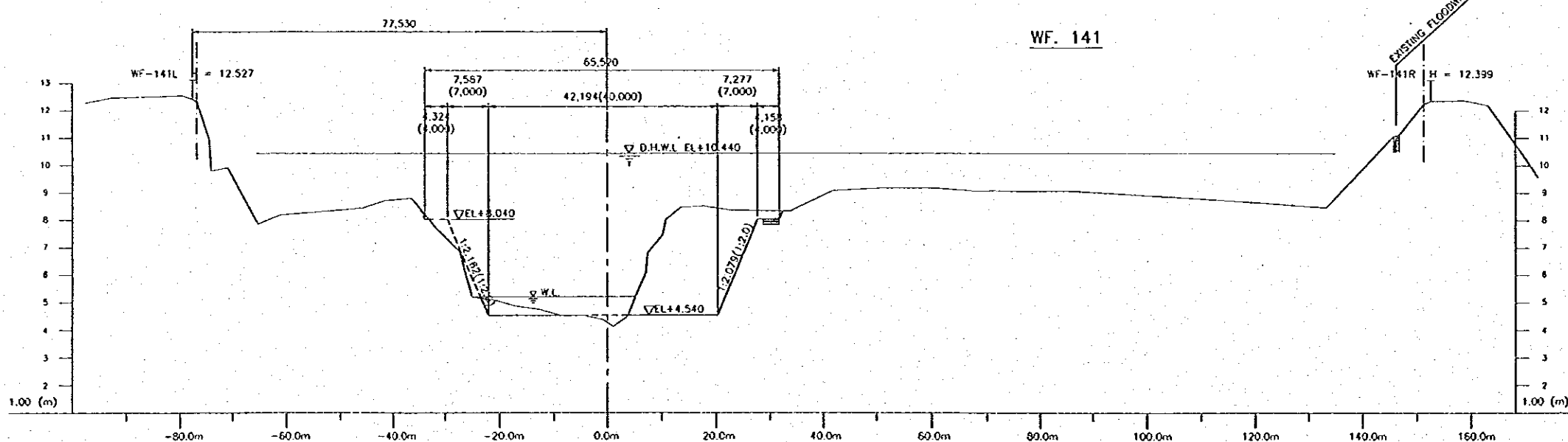
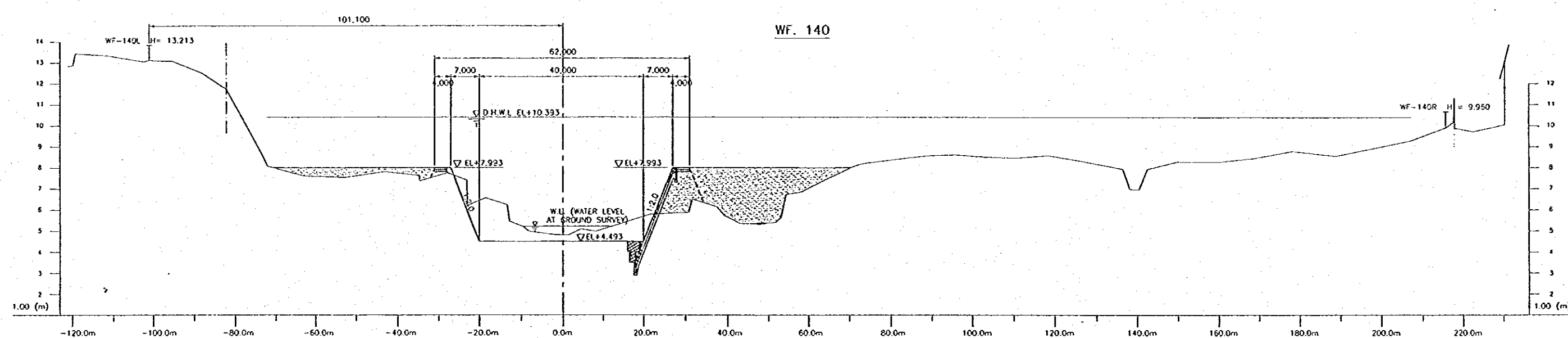
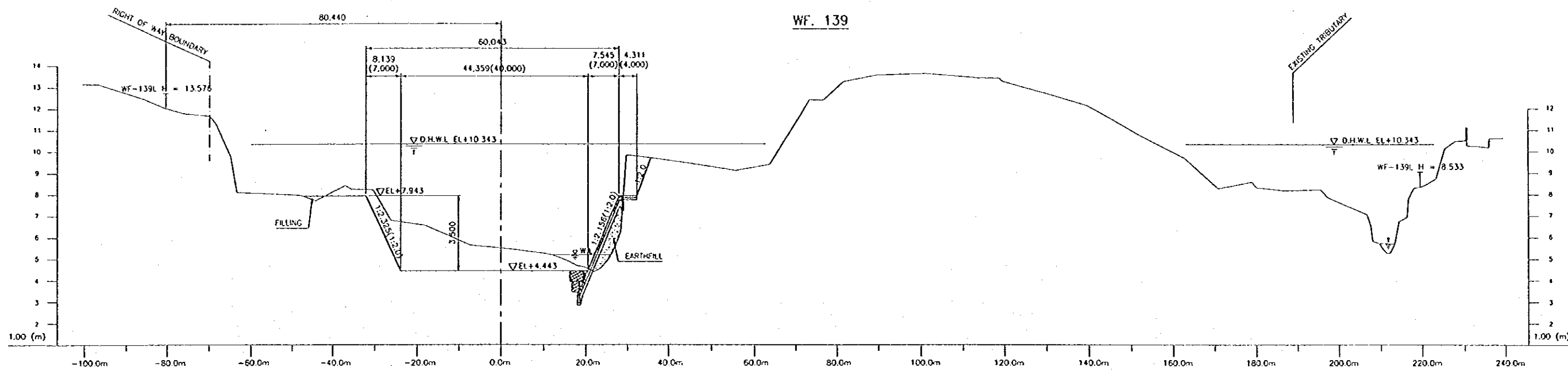

The number in parentheses shows the design dimensions of channel cross section which is perpendicular to the design center line of river channel. (WF-139, WF-141)

NO.	DATE	REVISIONS	ORIGINATED	DRAWN	APPROVED

THE REPUBLIC OF INDONESIA MINISTRY OF PUBLIC WORKS DIRECTORATE GENERAL OF WATER RESOURCES DEVELOPMENT AND DIRECTORATE GENERAL OF HUMAN SETTLEMENT		PROVINCE: CENTRAL JAWA PROJECT NAME: FLOOD CONTROL, URBAN DRAINAGE AND WATER RESOURCES DEVELOPMENT IN SEMARANG IN THE REPUBLIC OF INDONESIA DISTRICT: SEMARANG CITY DRAWING NO. WS-P1-CH-CR.09 SHEET NO. 11
IRATUNSLUNA FLOOD CONTROL PROJECT COMPONENT: WEST FLOODWAY / GARANG RIVER IMPROVEMENT CHANNEL AND DIKE WORKS GARANG RIVER CROSS SECTIONS (15/31)		DESIGNED: [Signature] CHECKED: [Signature] DATE: [Date] CONTRACT NO.: [Number]
SAFARI INTERNATIONAL COOPERATION AGENCY CIL ENGINEERING CO., LTD. IN ASSOCIATION WITH PACIFIC CONSULTANTS INTERNATIONAL INC. PARCO INTERNATIONAL INC.		CRRP OF PLANNING AND DESIGN PROJECT MANAGER: [Signature]

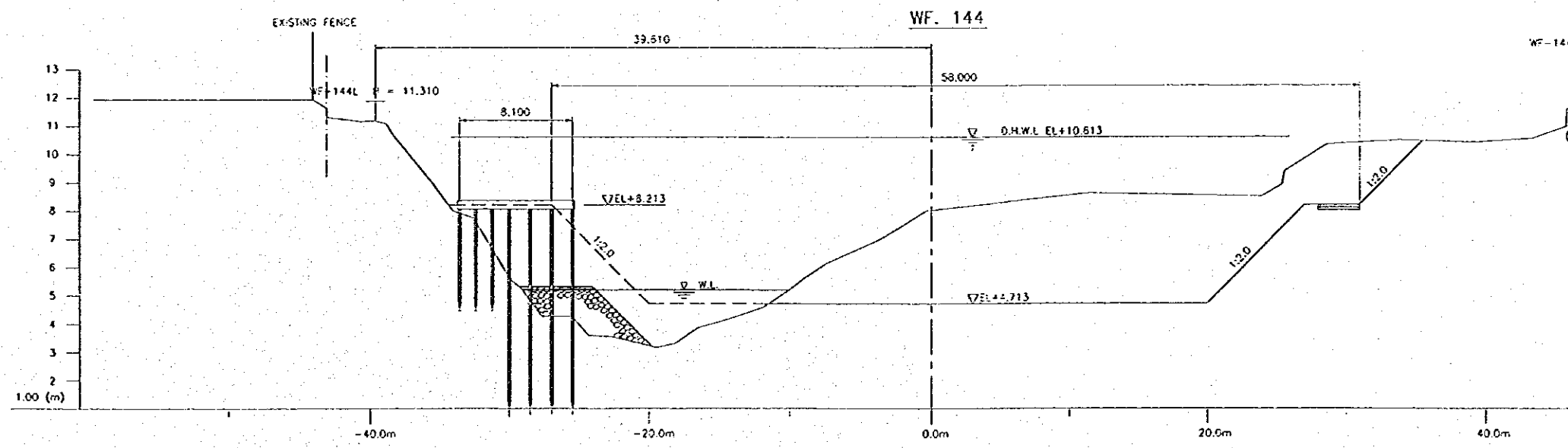
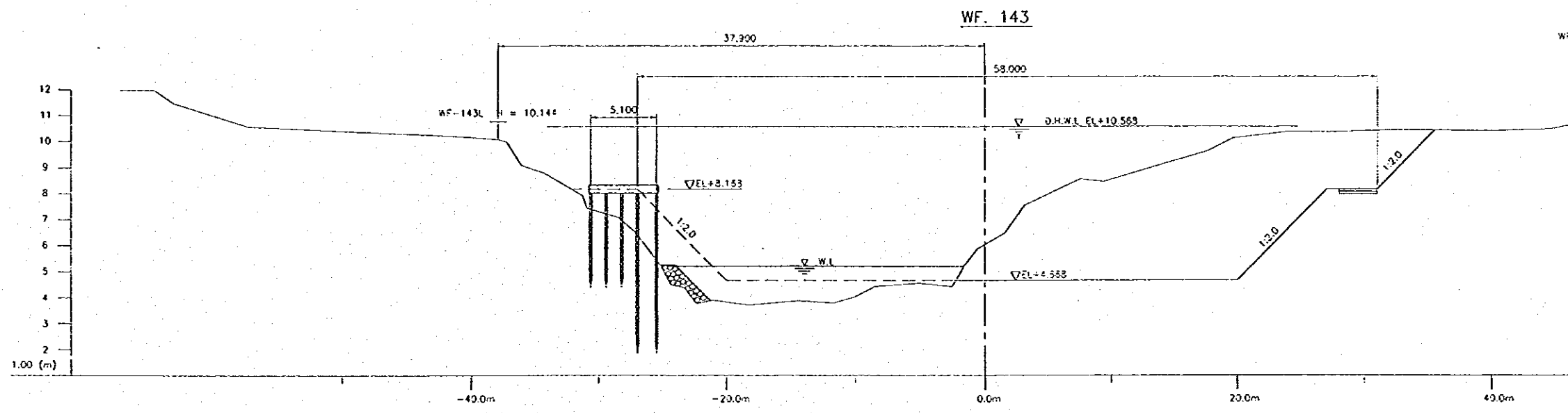
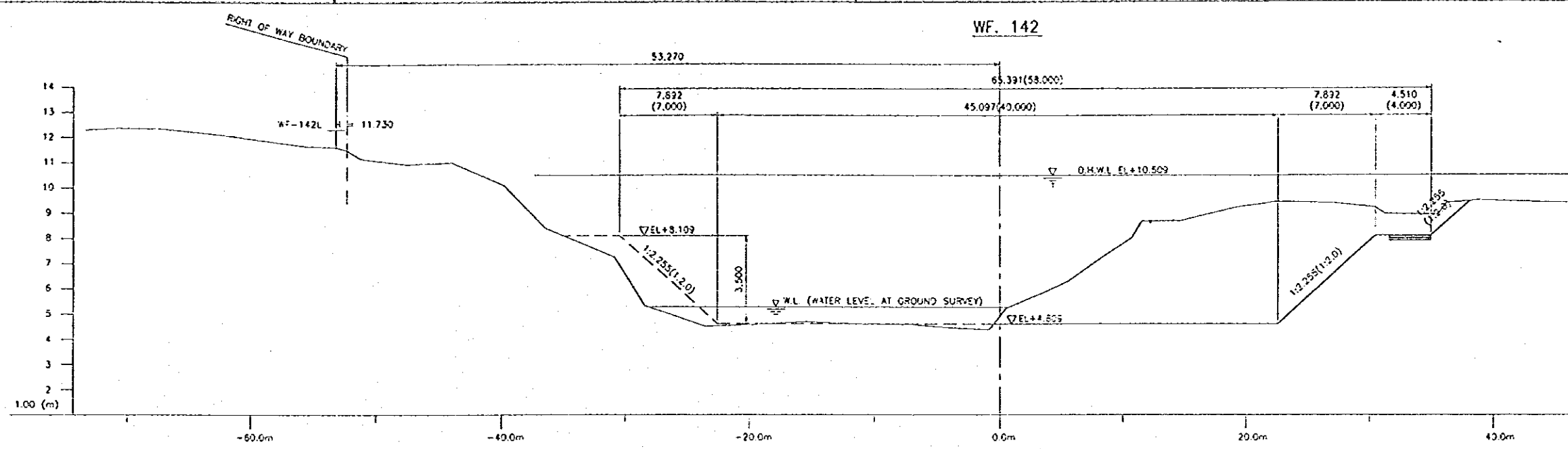

The number in parenthesis shows the design dimensions of channel cross section which is perpendicular to the design center line of river channel. (WF-142)

NO.	DATE	REV.

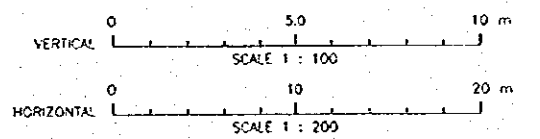
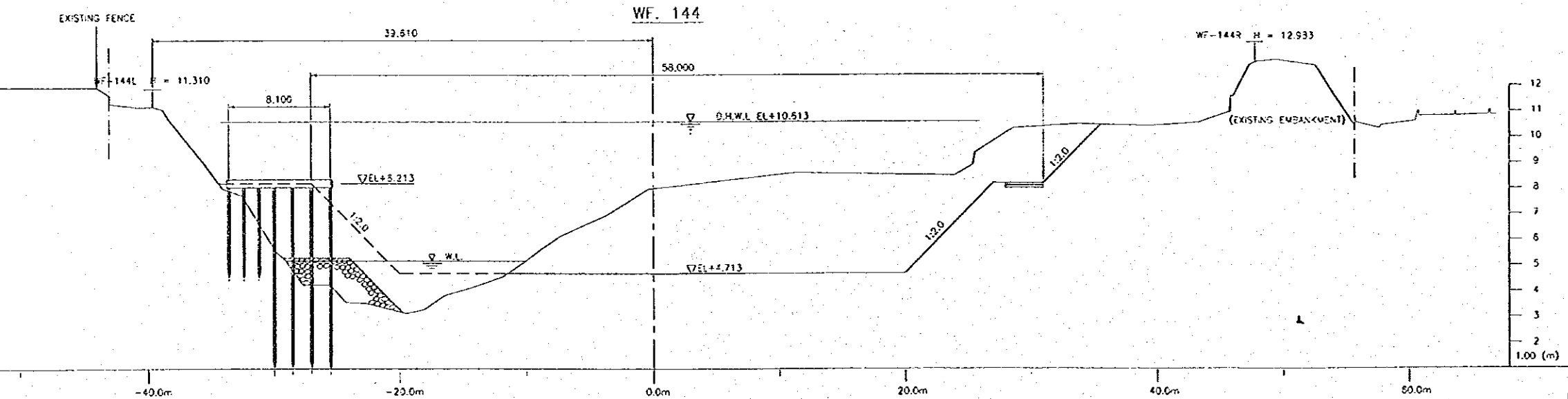
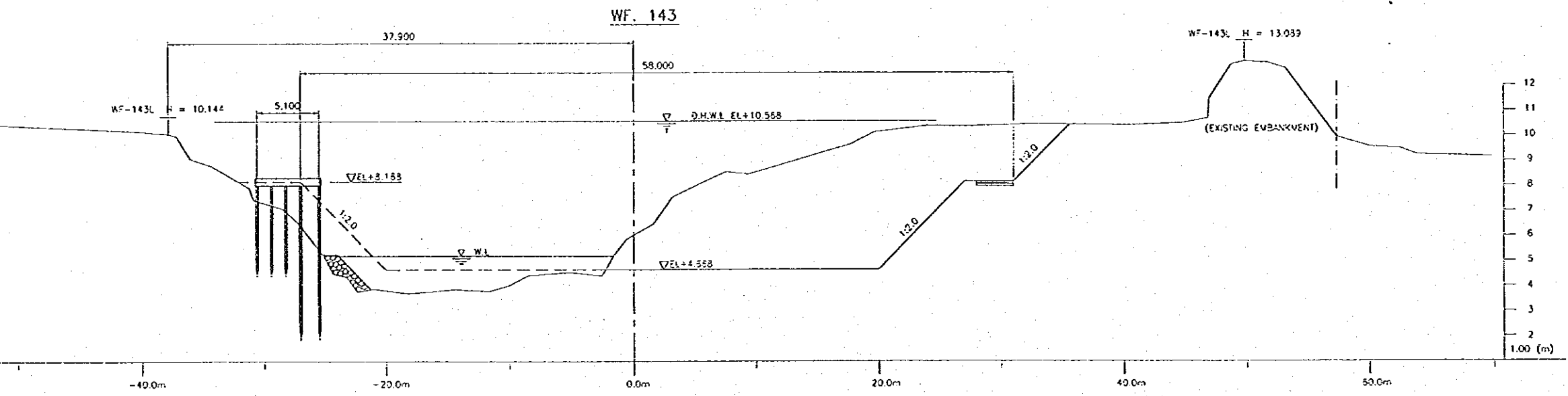
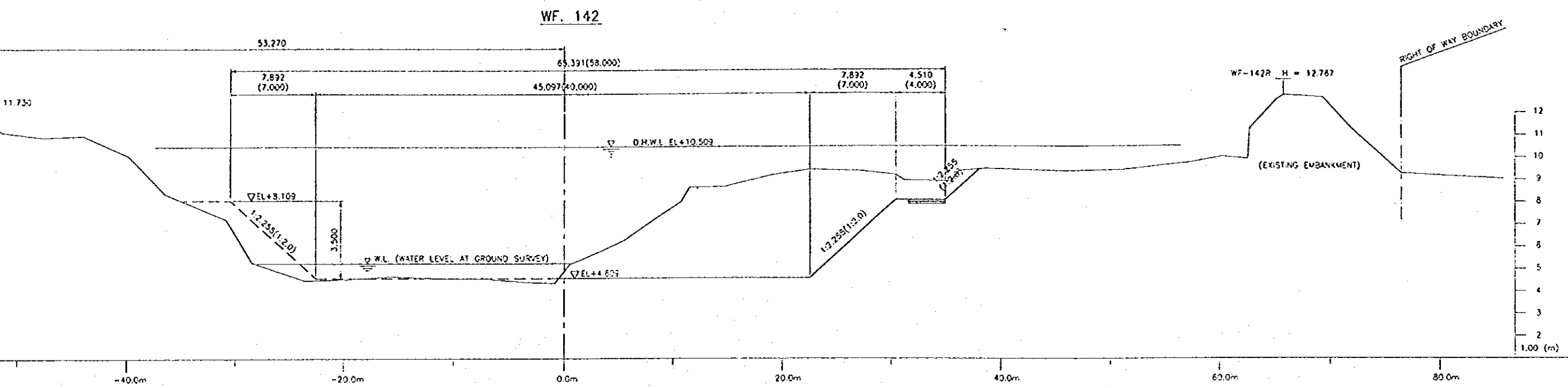

The number in parenthesis shows the design dimensions of channel cross section which is perpendicular to the design center line of river channel. (WF-142)

NO.	DATE	REVISIONS	ORIGINATED	DESIGNED	APPROVED

THE REPUBLIC OF INDONESIA MINISTRY OF PUBLIC WORKS DIRECTORATE GENERAL OF WATER RESOURCES DEVELOPMENT AND DIRECTORATE GENERAL OF HUMAN SETTLEMENT		PROVINCE CENTRAL JAVA	
BRATUNSELUNA FLOOD CONTROL PROJECT COMPONENT: WEST FLOODWAY / GARANG RIVER IMPROVEMENT CHANNEL AND DIKE WORKS GARANG RIVER CROSS SECTIONS (16 / 31)		PROJECT NAME FLOOD CONTROL, URBAN DRAINAGE AND WATER RESOURCES DEVELOPMENT IN SEMARANG IN THE REPUBLIC OF INDONESIA	
SAPAN INTERNATIONAL COOPERATION AGENCY CIVIL ENGINEERING CO., LTD. IN ASSOCIATION WITH PACIFIC CONSULTANTS INTERNATIONAL AND FARSI INTERNATIONAL INC.		DISTRICT SEMARANG CITY	
DESIGNED CHECKED CHIEF OF PLANNING AND DESIGN		DRAWING NO. WG-PF-CH-Cr. 78 SHEET NO. 72	
APPROVED PROJECT MANAGER		DATE CONTRACT NO.	

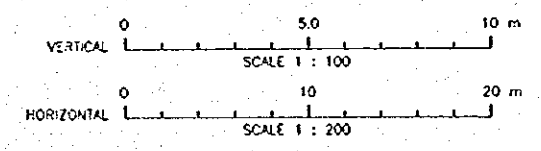
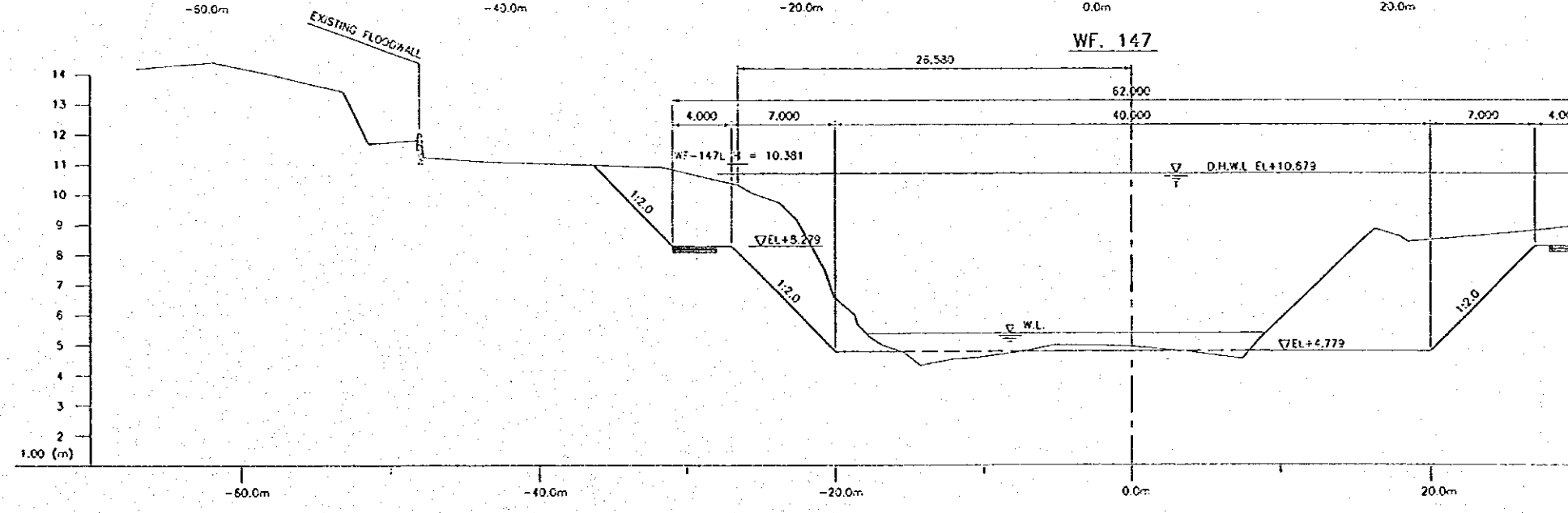
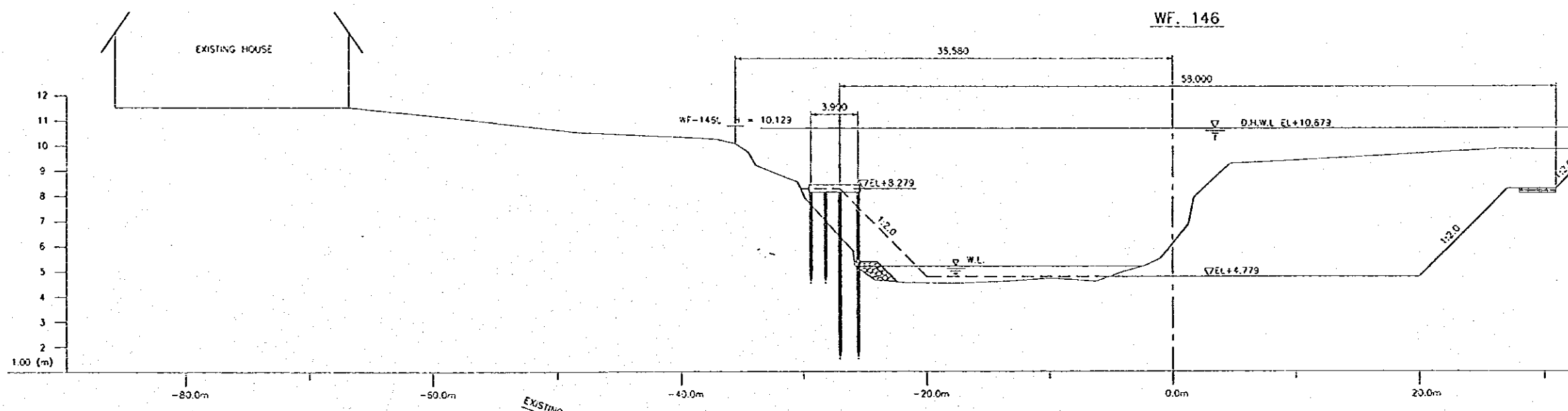
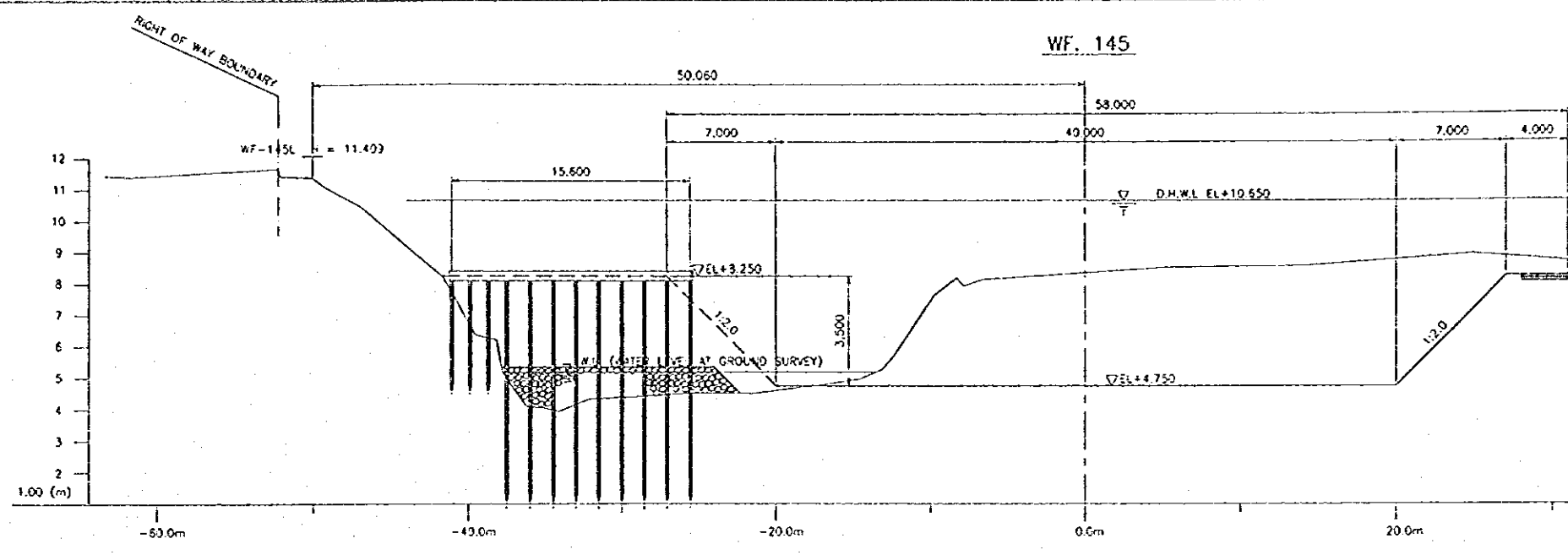

NO.	DATE	REVISION

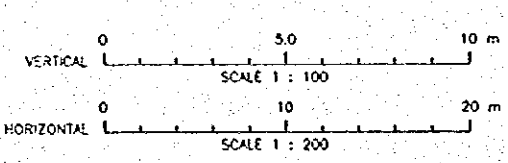
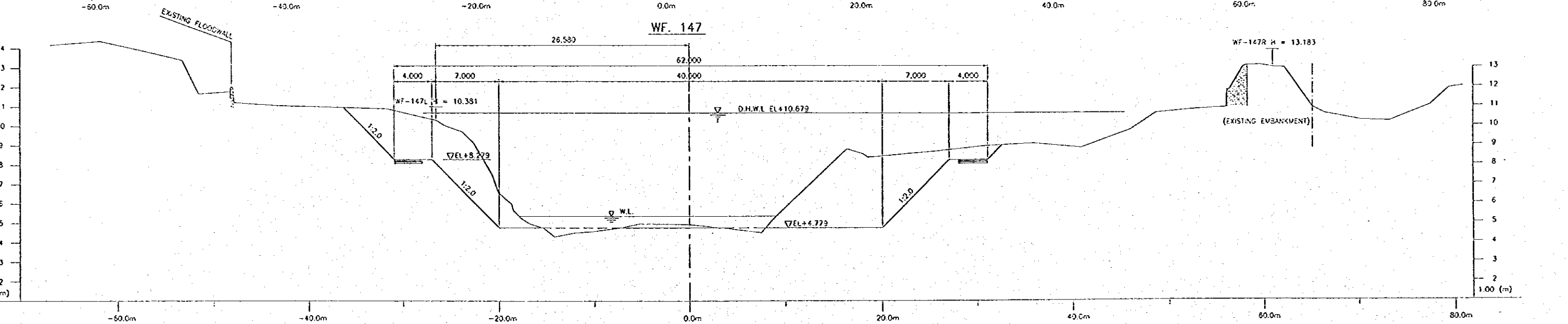
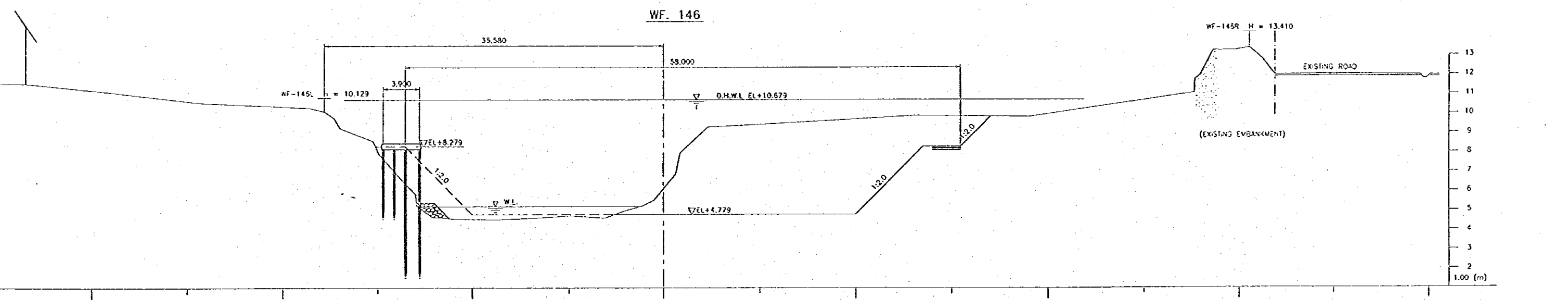
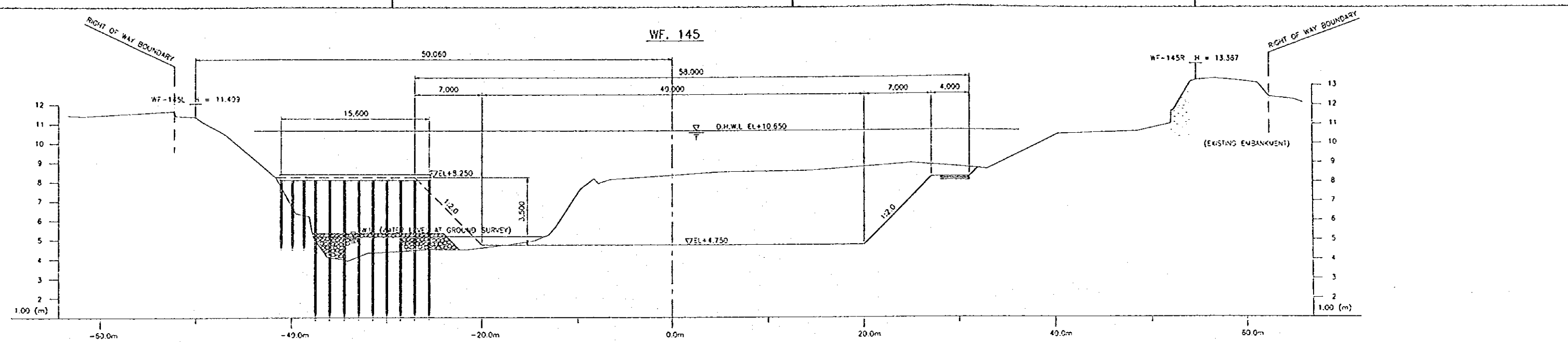

NO.	DATE	REVISIONS	ORIGINATED	DESIGNED	APPROVED

THE REPUBLIC OF INDONESIA MINISTRY OF PUBLIC WORKS DIRECTORATE GENERAL OF WATER RESOURCES DEVELOPMENT AND DIRECTORATE GENERAL OF HUMAN SETTLEMENT		PROVINCE CENTRAL JAVA
BRATUNSELUNA FLOOD CONTROL PROJECT COMPONENT: WEST FLOODWAY / GARANG RIVER IMPROVEMENT CHANNEL AND DIKE WORKS GARANG RIVER CROSS SECTIONS (17/31)		PROJECT NAME FLOOD CONTROL, URBAN DRAINAGE AND WATER RESOURCES DEVELOPMENT IN SEMARANG IN THE REPUBLIC OF INDONESIA
JAPAN INTERNATIONAL COOPERATION AGENCY CITY ENGINEERING CO., LTD. IN ASSOCIATION WITH PACIFIC CONSULTANTS INTERNATIONAL AND PABO ENGINEERING CO.		DISTRICT SEMARANG CITY
DESIGNED: [Signature] CHECKED: [Signature] CRIEY OF PLANNING AND DESIGN		DRAWING NO. W3-P1-CH-Cr.11 SHEET NO. 13
APPROVED: [Signature] PROJECT MANAGER		DATE: [] CONTRACT NO.

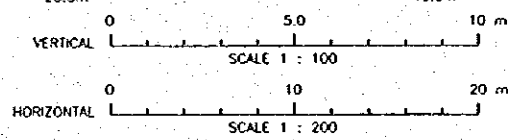
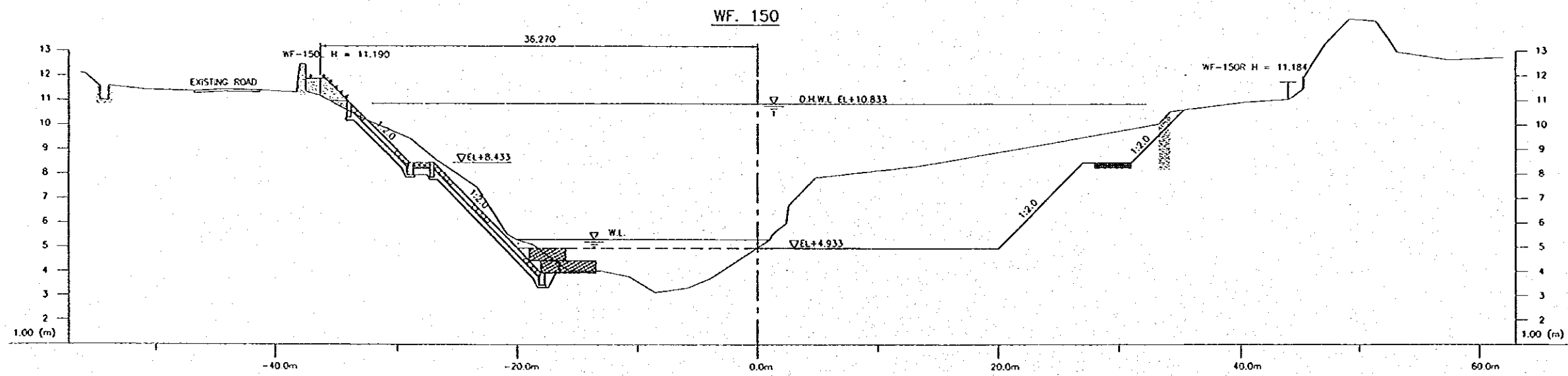
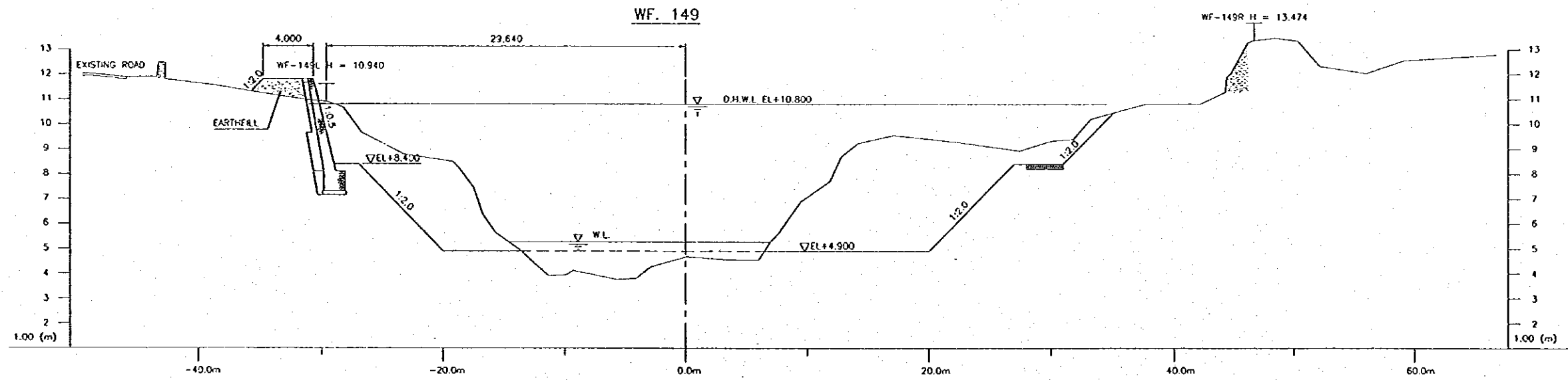
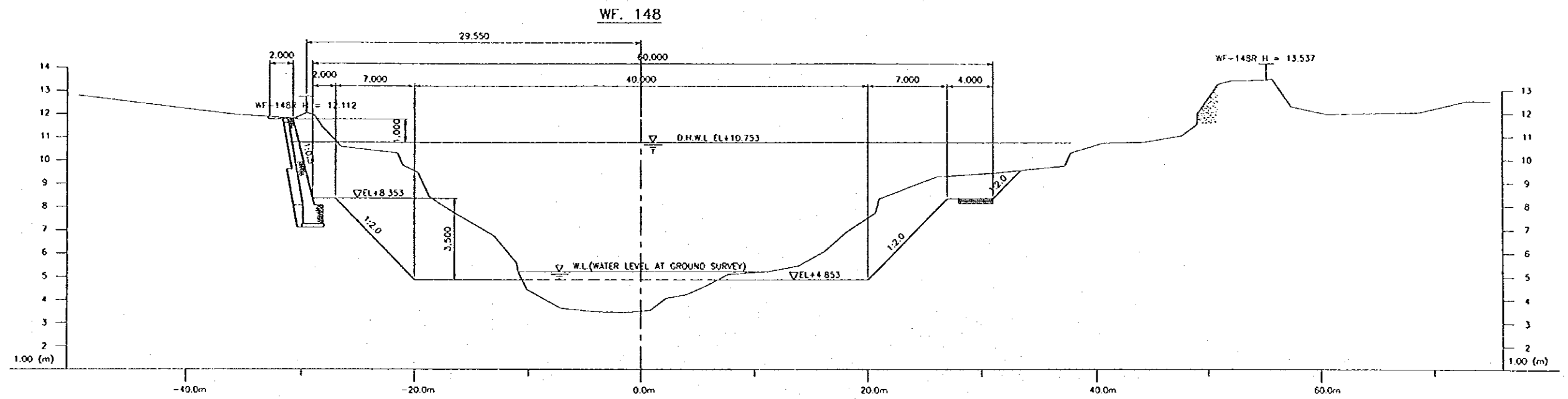

NO.	DATE	REVISIONS	ORDINATED	DRAWN	APPROVED

THE REPUBLIC OF INDONESIA
 MINISTRY OF PUBLIC WORKS
 DIRECTORATE GENERAL OF WATER RESOURCES DEVELOPMENT
 AND DIRECTORATE GENERAL OF HUMAN SETTLEMENT
JRATUNSELUNA FLOOD CONTROL PROJECT
COMPONENT: WEST FLOODWAY / GARANO RIVER IMPROVEMENT
CHANNEL AND DIKE WORKS
GARANG RIVER
CROSS SECTIONS (18/31)

PROJECT MANAGER: [Signature]
 CHIEF OF PLANNING AND DESIGN: [Signature]

DESIGNED	CHECKED
DATE	CONTRACT NO.

PROVINCE	CENTRAL JAVA
PROJECT NAME	FLOOD CONTROL, URBAN DRAINAGE AND WATER RESOURCES DEVELOPMENT IN SEMARANG IN THE REPUBLIC OF INDONESIA
DISTRICT	SEMARANG CITY
DRAWING NO.	WS-P1-GH-O-11
SHEET NO.	14

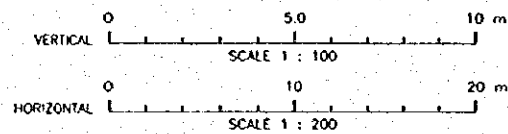
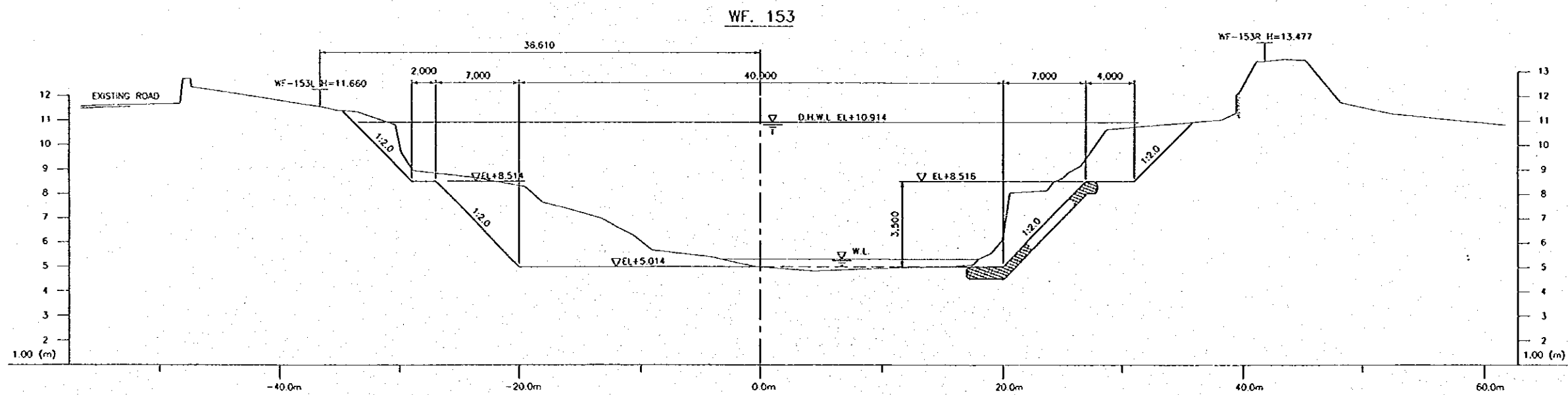
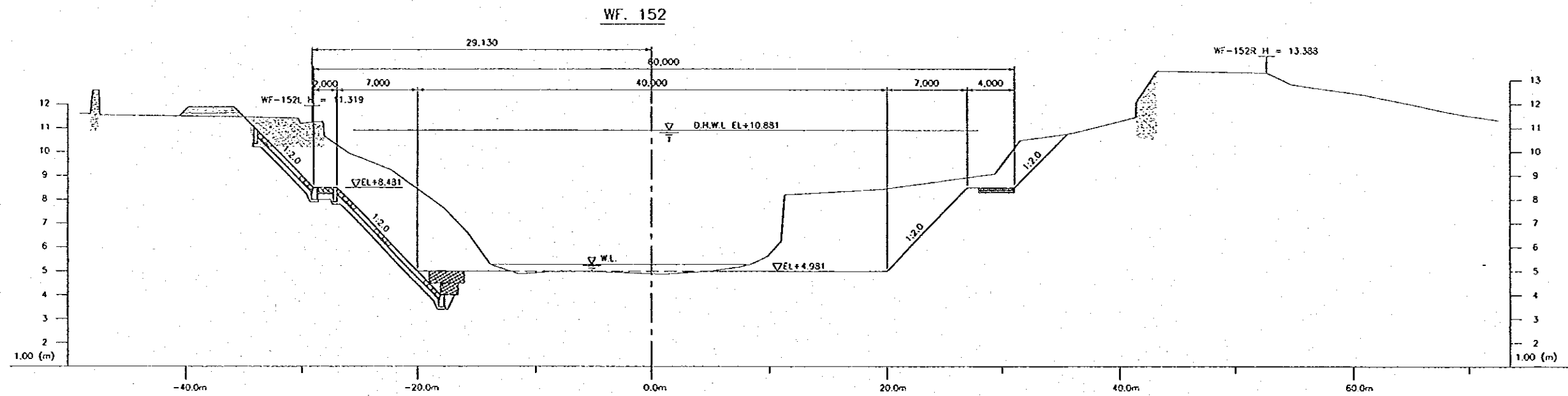
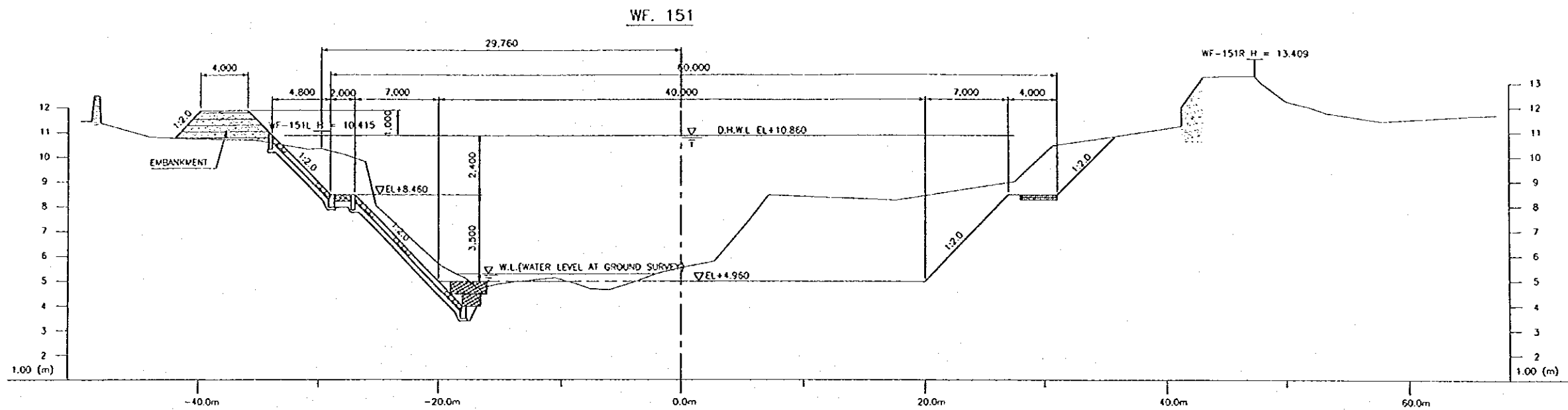

NO.	DATE	REVISIONS	ORIGINATED	DESIGNED	APPROVED

<p>THE REPUBLIC OF INDONESIA MINISTRY OF PUBLIC WORKS DIRECTORATE GENERAL OF WATER RESOURCES DEVELOPMENT AND DIRECTORATE GENERAL OF HUMAN SETTLEMENT</p>		PROVIDER	CENTRAL JAVA
		PROJECT NAME	FLOOD CONTROL, URBAN DRAINAGE AND WATER RESOURCES DEVELOPMENT IN SEMARANG IN THE REPUBLIC OF INDONESIA
<p>IRATUNSELUNA FLOOD CONTROL PROJECT COMPONENT: WEST FLOODWAY / GARANG RIVER IMPROVEMENT CHANNEL AND DIKE WORKS GARANG RIVER CROSS SECTIONS (19/31)</p>		CITY	SEMARANG CITY
<p>SAJAH INTERNATIONAL COOPERATION AGENCY CIE INTERNATIONAL CO., LTD. IN ASSOCIATION WITH PACIFIC CONSULTANTS INTERNATIONAL, INC. PACCO INTERNATIONAL, INC.</p>		DRAWING NO.	WG-P1-GH-Cv.73
<p>DESIGNED: [Signature] CHECKED: [Signature]</p>		SHEET NO.	75
<p>OFFICE OF PLANNING AND DESIGN PROJECT MANAGER</p>		DATE	
<p>APPROVED: [Signature]</p>		CONTRACT NO.	

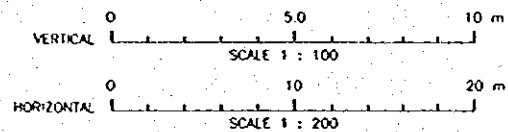
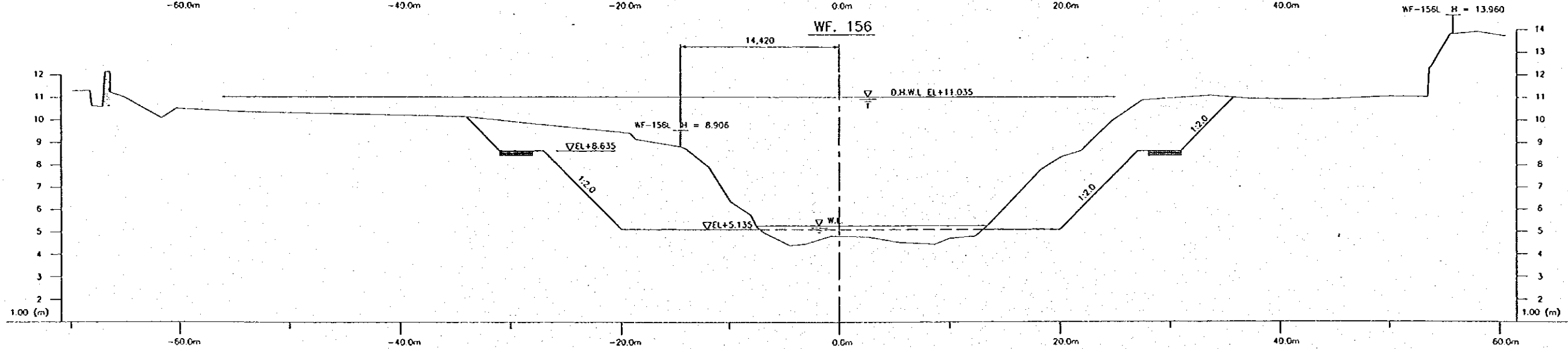
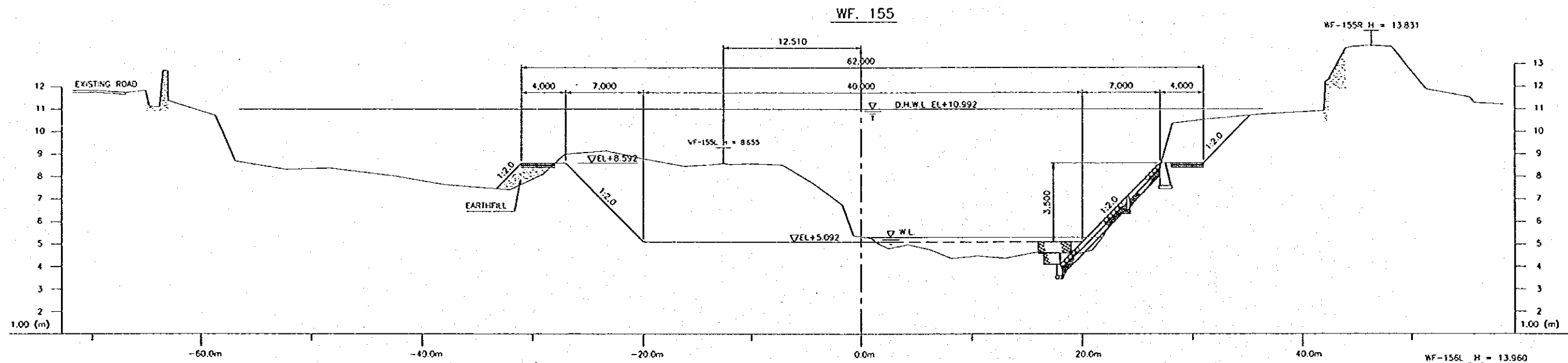
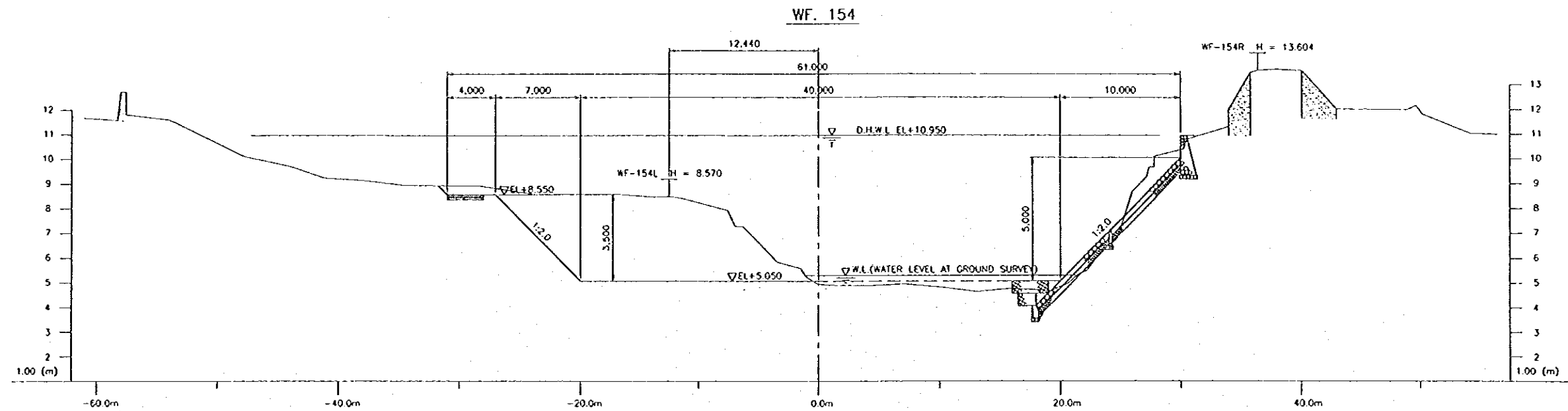

NO.	DATE	REVISIONS	ORIGINATED	DESIGNED	APPROVED

THE REPUBLIC OF INDONESIA MINISTRY OF PUBLIC WORKS DIRECTORATE GENERAL OF WATER RESOURCES DEVELOPMENT AND DIRECTORATE GENERAL OF HUMAN SETTLEMENT		PROVINCE CENTRAL JAVA
IRATUNSELUNA FLOOD CONTROL PROJECT COMPONENT: WEST FLOODWAY / GARANG RIVER IMPROVEMENT CHANNEL AND DIKE WORKS GARANG RIVER CROSS SECTIONS (20/31)		PROJECT NAME FLOOD CONTROL, URBAN DRAINAGE AND WATER RESOURCES DEVELOPMENT BY REGIONS IN THE REPUBLIC OF INDONESIA
JAPAN INTERNATIONAL COOPERATION AGENCY CITY ENGINEERING CO., LTD. IN ASSOCIATION WITH PACIFIC CONSULTANTS INTERNATIONAL AND PARCO INTERNATIONAL, INC.		DISTRICT SEMARANG CITY
DISBURSED CHECKED DATE CONTRACTING		DRAWING NO. WS-PE-CH-CR-16 SHEET NO. 76
APPROVED CHIEF OF PLANNING AND DESIGN PROJECT MANAGER		DATE CONTRACTING

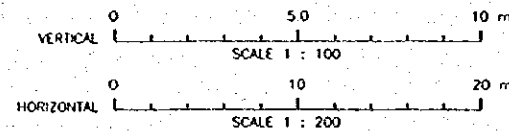
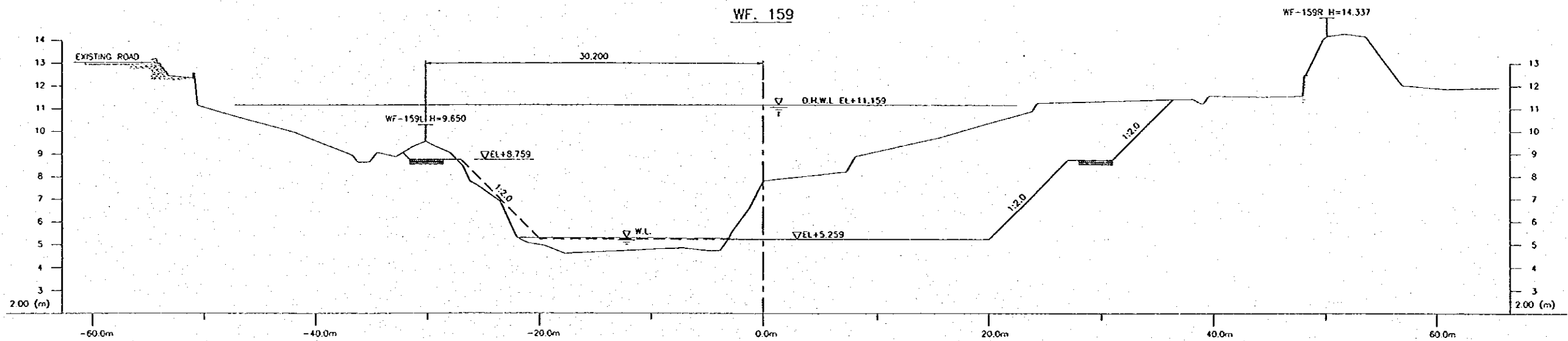
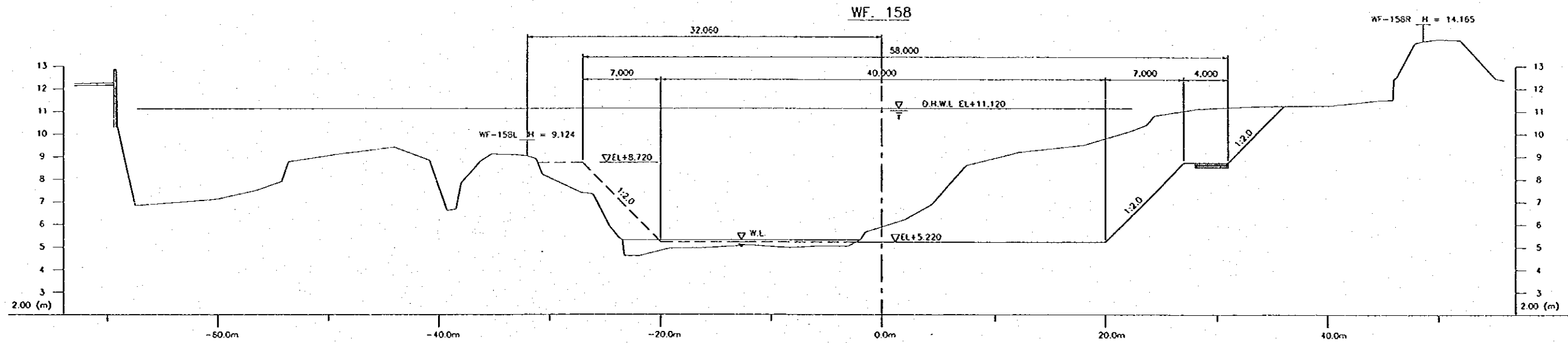
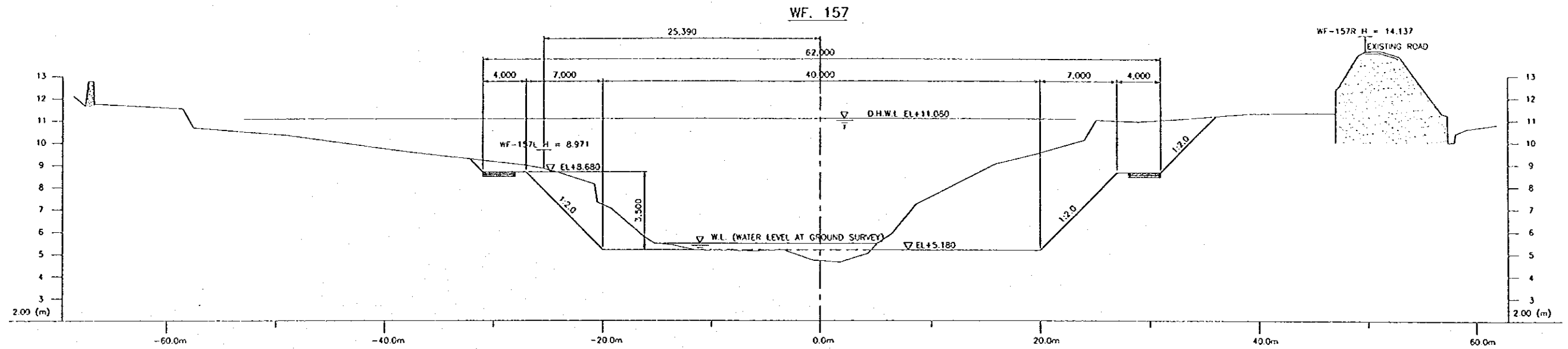

NO.	DATE	REVISIONS	ORIGINATED	DESIGNED	APPROVED

THE REPUBLIC OF INDONESIA MINISTRY OF PUBLIC WORKS DIRECTORATE GENERAL OF WATER RESOURCES DEVELOPMENT AND DIRECTORATE GENERAL OF HUMAN SETTLEMENT		PROVINCE CENTRAL JAVA
JATUNSELUMA FLOOD CONTROL PROJECT COMPONENT: WEST FLOODWAY / GARANO RIVER IMPROVEMENT CHANNEL AND DIKE WORKS GARANG RIVER CROSS SECTIONS (21/31)		PROJECT NAME FLOOD CONTROL, URBAN DRAINAGE AND WATER RESOURCES DEVELOPMENT OF SEMARANG IN THE REPUBLIC OF INDONESIA
SAFARI INTERNATIONAL COOPERATION AGENCY CIL INDIONESIA CO. LTD. IN ASSOCIATION WITH PACIFIC CONSULTANTS INTERNATIONAL AND PARCO INTERNATIONAL INC.		DISTRICT SEMARANG CITY
DESIGNED CHECKED CHERY OF PLANNING AND DESIGN		DRAWING NO. W8 - P4 - CH - Cr. 18 SHEET NO. 11
APPROVED PROJECT MANAGER		DATE CONTRACT NO.

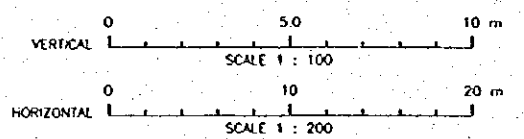
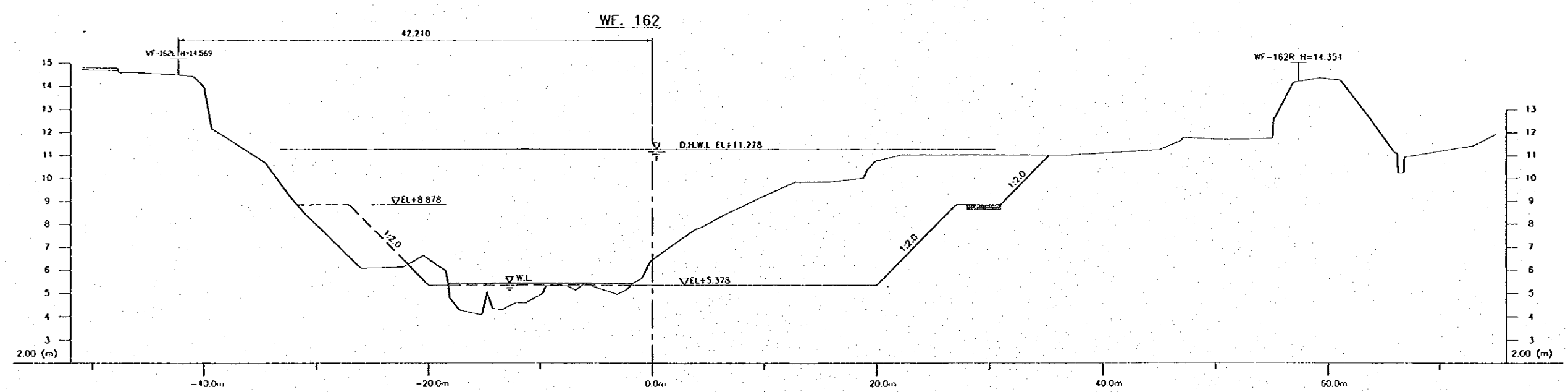
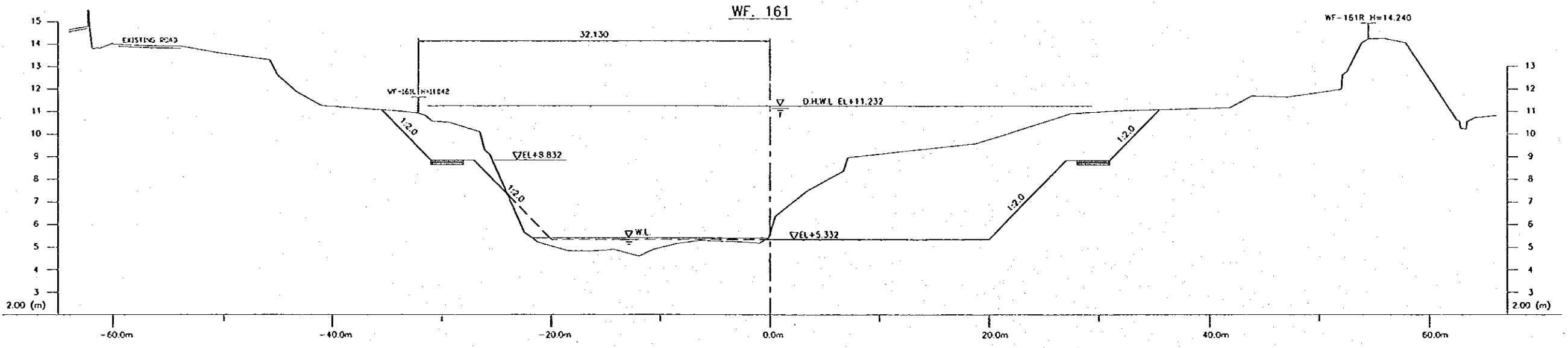
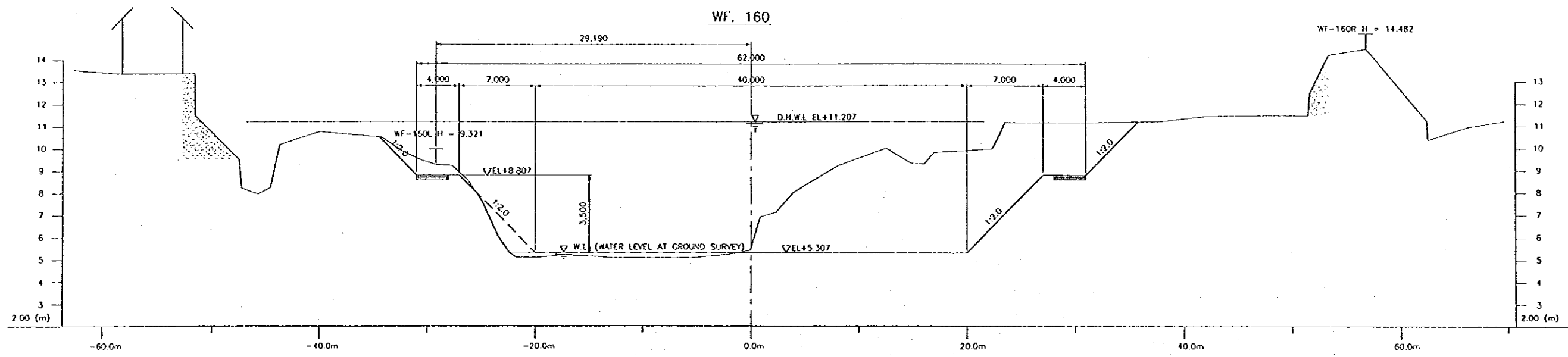

NO.	DATE	REVISIONS	ORIGINATED	DESIGNED	APPROVED

THE REPUBLIC OF INDONESIA MINISTRY OF PUBLIC WORKS DIRECTORATE GENERAL OF WATER RESOURCES DEVELOPMENT AND DIRECTORATE GENERAL OF HUMAN SETTLEMENT		PROVIDER CENTRAL JAVA
IRATUNSELUNA FLOOD CONTROL PROJECT COMPONENT: WEST FLOODWAY / GARANG RIVER IMPROVEMENT CHANNEL AND DIKE WORKS GARANG RIVER CROSS SECTIONS (22/31)		PROJECT NAME FLOOD CONTROL, URBAN DRAINAGE AND WATER RESOURCES DEVELOPMENT IN SEMARANG IN THE REPUBLIC OF INDONESIA
JAPAN INTERNATIONAL COOPERATION AGENCY CII ENGINEERING CO., LTD. IN ASSOCIATION WITH PACIFIC CONSULTANTS INTERNATIONAL AND FARO INTERNATIONAL, INC.		DISTRICT SEMARANG CITY
DESIGNED CHECKED CHIEF OF PLANNING AND DESIGN PROJECT MANAGER		DRAWING NO. WF-PS-CH-CR.78 SHEET NO. 78 DATE CONTRACT NO.

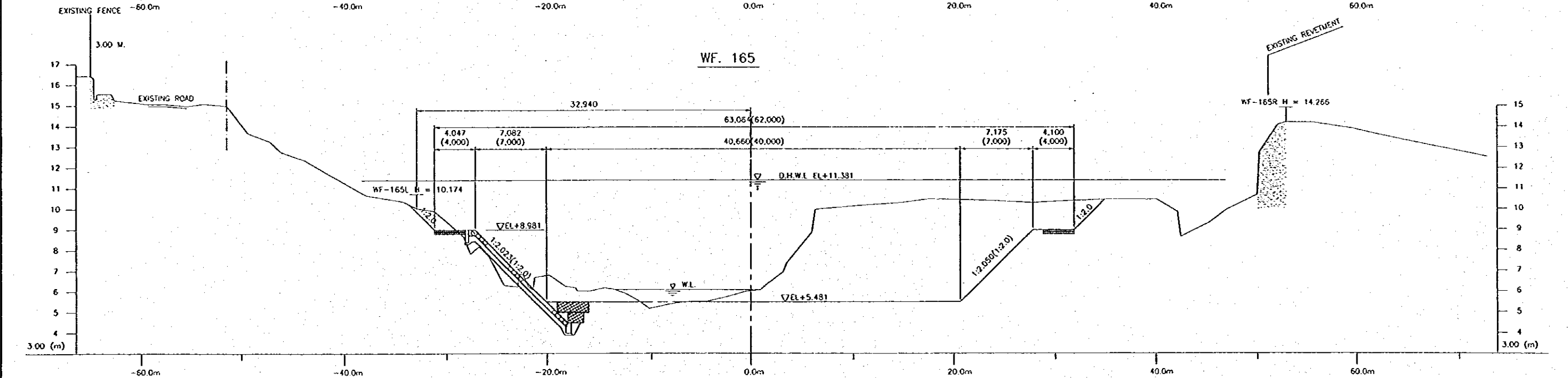
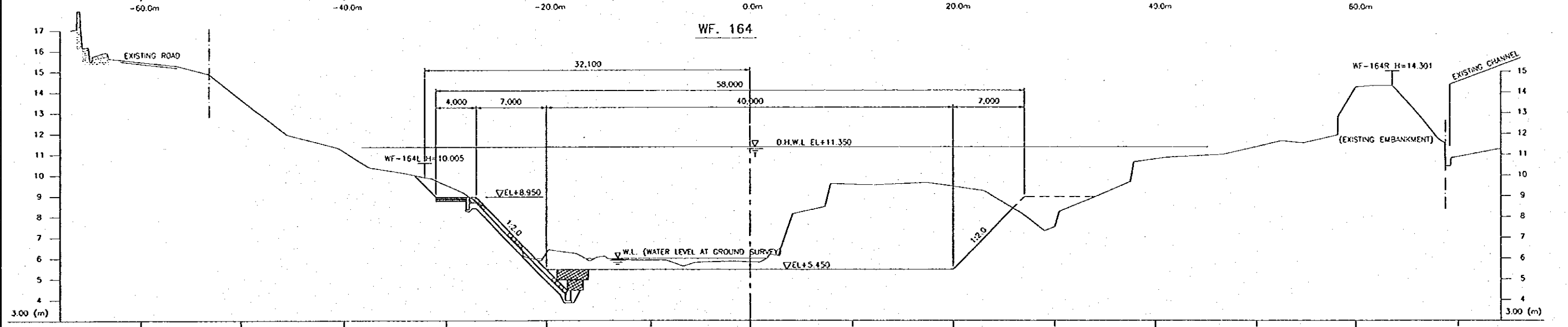
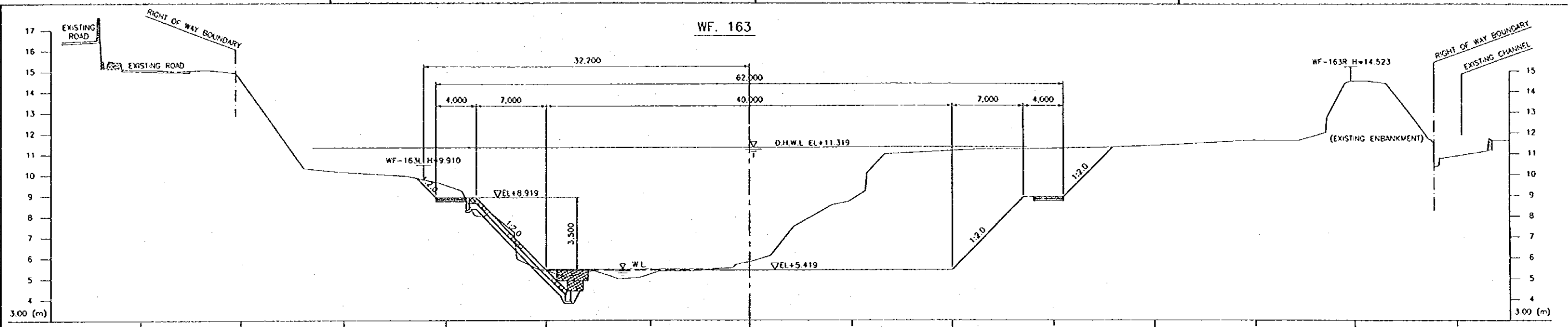

The number in parentheses shows the design dimensions of channel cross section which is perpendicular to the design center line of river channel. (WF. 165)

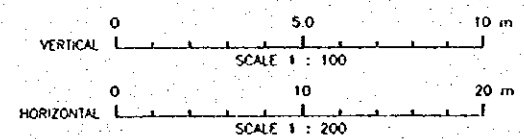

NO.	DATE	REVISIONS	ORDERED BY	DRAWN BY	APPROVED BY

THE REPUBLIC OF INDONESIA MINISTRY OF PUBLIC WORKS DIRECTORATE GENERAL OF WATER RESOURCES DEVELOPMENT AND DIRECTORATE GENERAL OF HUMAN SETTLEMENT		PROVINCE CENTRAL JAVA
JRATUNSELUNA FLOOD CONTROL PROJECT COMPONENT: WEST FLOODWAY / GARANG RIVER IMPROVEMENT CHANNEL AND DIKE WORKS GARANG RIVER CROSS SECTIONS (23/31)		PROJECT NAME FLOOD CONTROL, URBAN DRAINAGE AND WATER RESOURCES DEVELOPMENT IN SEMARANG IN THE REPUBLIC OF INDONESIA
JAPAN INTERNATIONAL COOPERATION AGENCY CITY ENGINEERING CO., LTD. IN ASSOCIATION WITH PACIFIC CONSULTANTS INTERNATIONAL AND PAKO INTERNATIONAL INC.		DISTRICT SEMARANG CITY
DESIGNED CHECKED CORRECTED PROJECT MANAGER		DRAWING NO. W 0 - P 1 - CH - C 77 SHEET NO. 79 DATE CONTRACT NO.

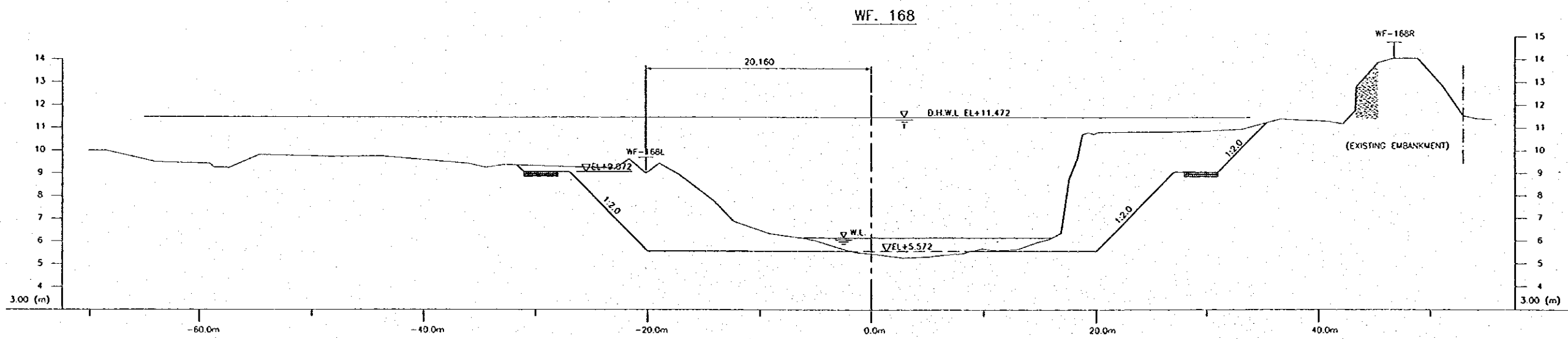
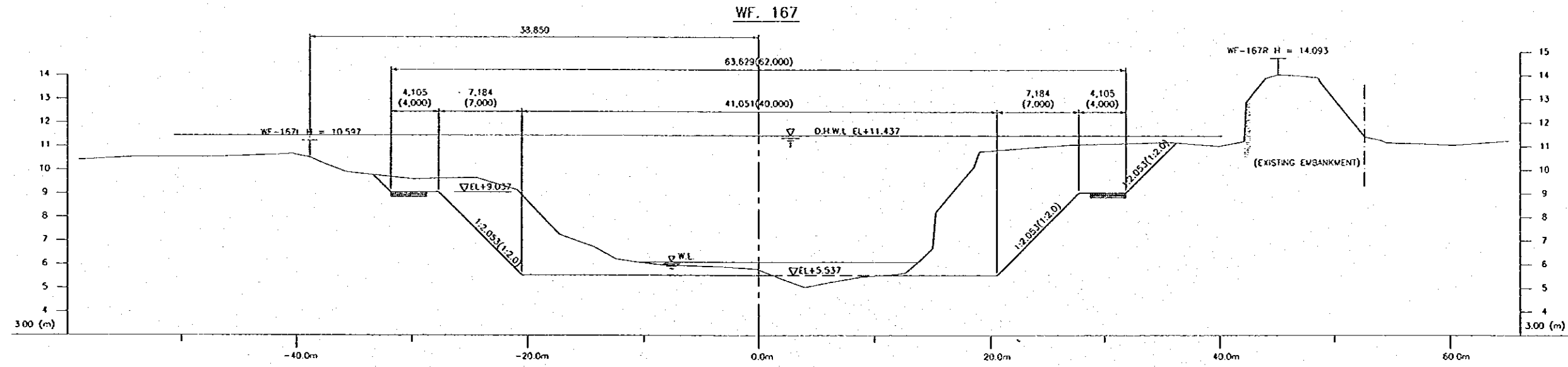
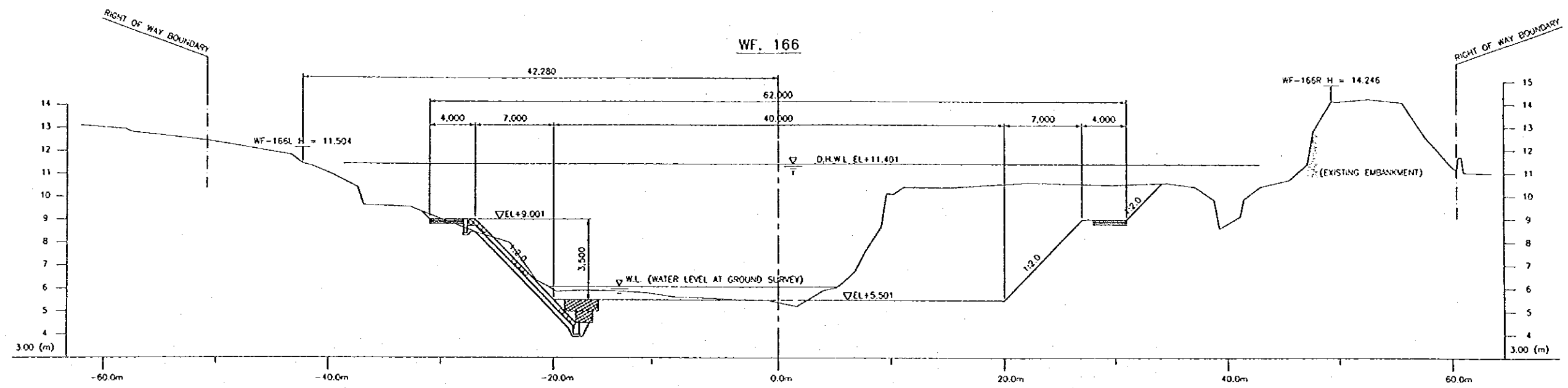

The number in parentheses shows the design dimensions of channel cross section which is perpendicular to the design center line of river channel. (WF. 167)

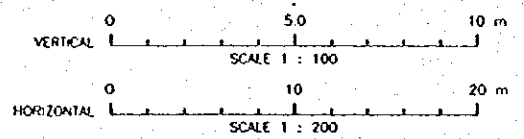

NO.	DATE	REVISIONS	ORIGINATED	DESIGNED	APPROVED

THE REPUBLIC OF INDONESIA MINISTRY OF PUBLIC WORKS DIRECTORATE GENERAL OF WATER RESOURCES DEVELOPMENT AND DIRECTORATE GENERAL OF HUMAN SETTLEMENT		PROVINCE: CENTRAL JAVA PROJECT NAME: FLOOD CONTROL, URBAN DRAINAGE AND WATER RESOURCES DEVELOPMENT IN SEMARANG IN THE REPUBLIC OF INDONESIA DISTRICT: SEMARANG CITY DRAWING NO.: WS - PH - CH - Cc 78 SHEET NO.: 80
JATUNSELUNA FLOOD CONTROL PROJECT COMPONENT: WEST FLOODWAY / GARANG RIVER IMPROVEMENT CHANNEL AND DIKE WORKS GARANG RIVER CROSS SECTIONS (24/31)		DATE: 11/1988 CONTRACT NO.:
SAFAN INTERNATIONAL CORPORATION AGENT CITI ENGINEERING CO., LTD. BY APPOINTMENT WITH PACIFIC CONSULTANTS INTERNATIONAL AND TAIPO INTERNATIONAL INC. CHIEF OF PLANNING AND DESIGN	DESIGNED: [Signature] CHECKED: [Signature]	PROJECT MANAGER: [Signature]

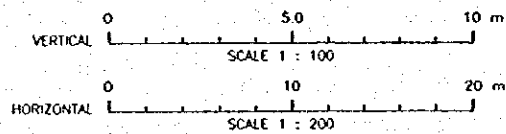
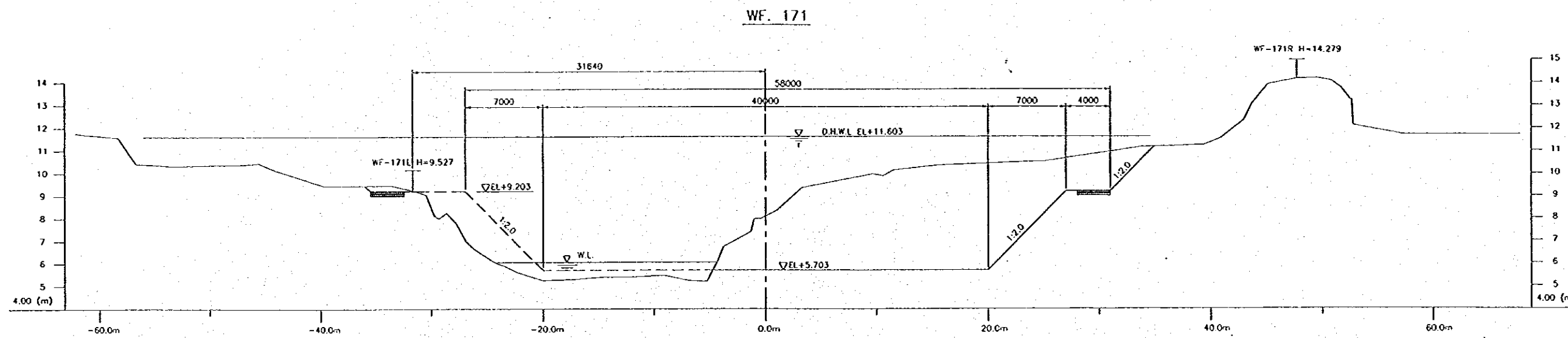
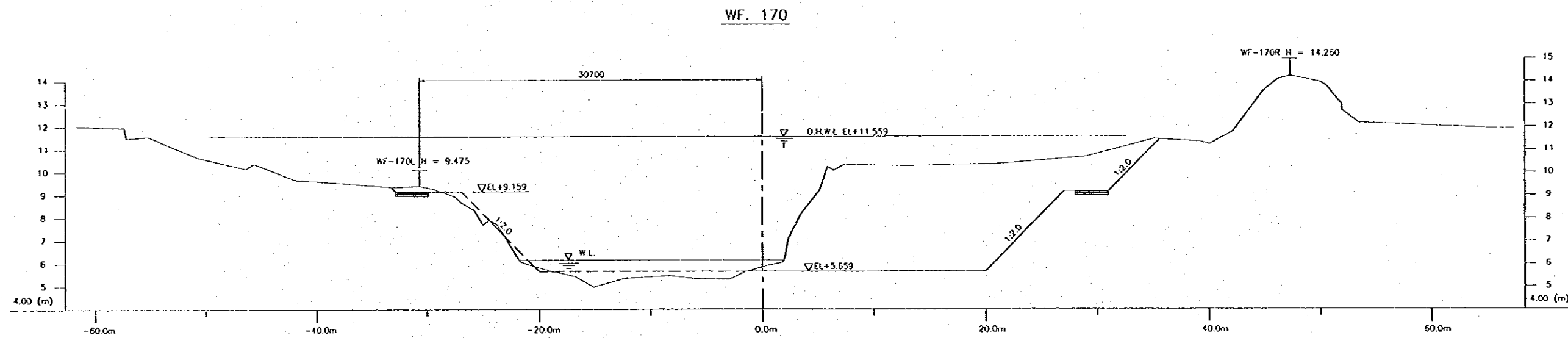
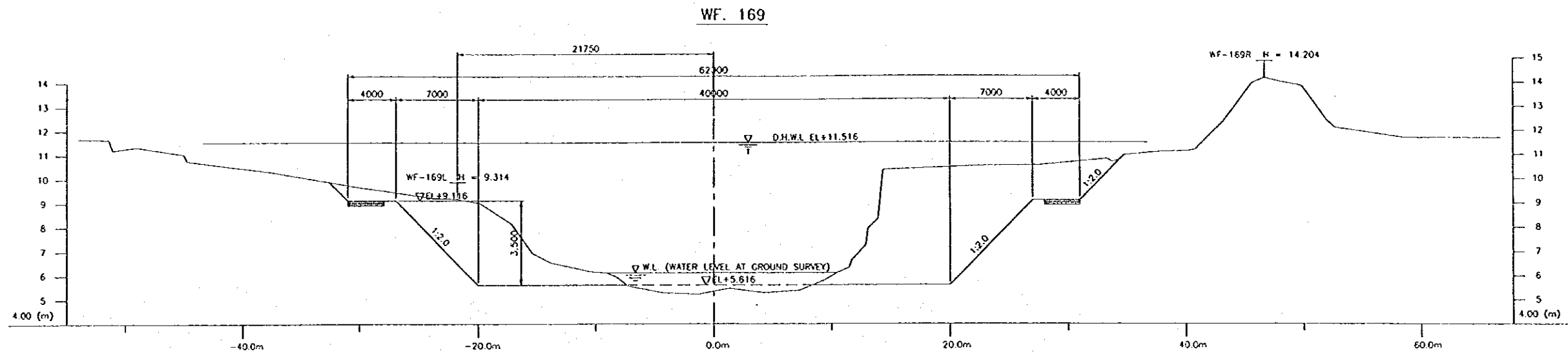

NO.	DATE	REVISIONS	ORIGINATED	DESIGNED	APPROVED

THE REPUBLIC OF INDONESIA MINISTRY OF PUBLIC WORKS DIRECTORATE GENERAL OF WATER RESOURCES DEVELOPMENT AND DIRECTORATE GENERAL OF HUMAN SETTLEMENT		PROVINCE CENTRAL JAVA	
JRATUNSELUKA FLOOD CONTROL PROJECT COMPONENT: WEST FLOODWAY / GARANG RIVER IMPROVEMENT CHANNEL AND DIKE WORKS GARANG RIVER CROSS SECTIONS (25/31)		PROJECT NAME FLOOD CONTROL, URBAN DRAINAGE AND WATER RESOURCES DEVELOPMENT IN SEMARANG IN THE REPUBLIC OF INDONESIA	
JAPAN INTERNATIONAL COOPERATION AGENCY CITY ENGINEERING CO., LTD. in association with PACIFIC CONSULTANTS INTERNATIONAL INC. JACO INTERNATIONAL INC.		DESIGNED <i>[Signature]</i>	CHECKED <i>[Signature]</i>
CHIEF OF PLANNING AND DESIGN PROJECT MANAGER		DATE <i>[Date]</i>	CONTRACT NO. <i>[Contract No.]</i>

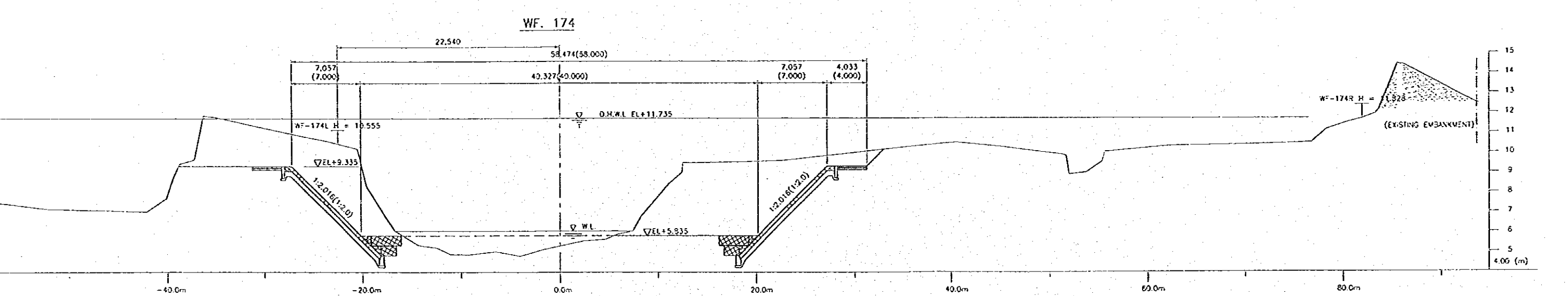
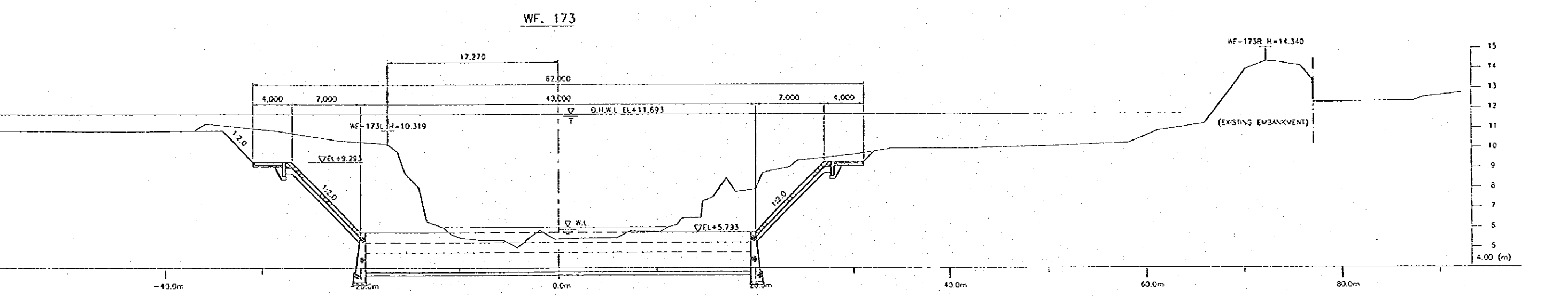
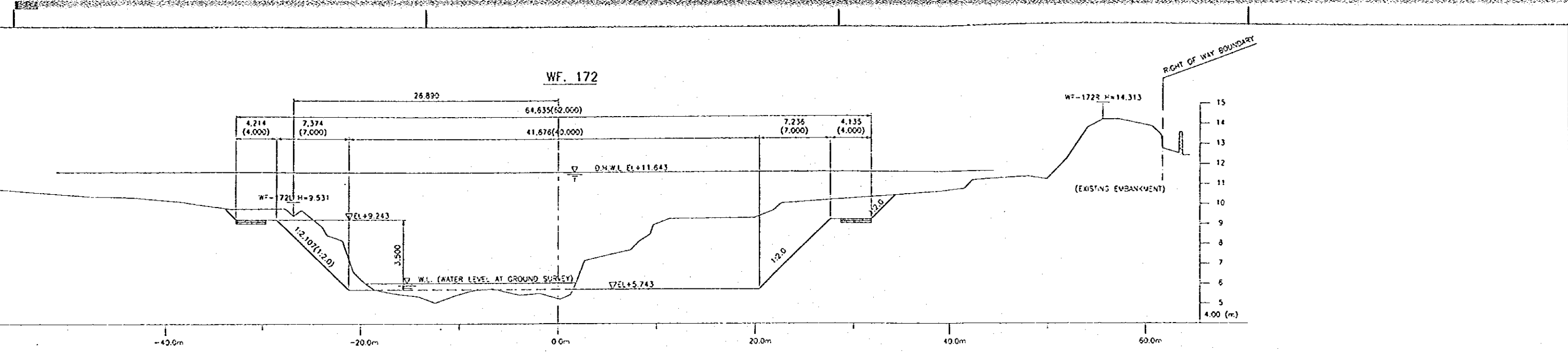

The number in parenthesis shows the design dimensions of channel cross section which is perpendicular to the design center line of river channel. (WF. 172, WF. 174)

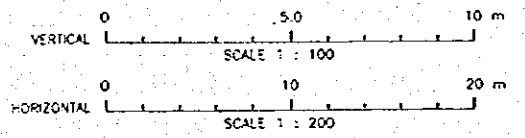

NO.	DATE	REVISIONS	ORIGINATED	DESIGNED	APPROVED

THE REPUBLIC OF INDONESIA MINISTRY OF PUBLIC WORKS DIRECTORATE GENERAL OF WATER RESOURCES DEVELOPMENT AND DIRECTORATE GENERAL OF HUMAN SETTLEMENT		PROVINCE CENTRAL JAWA
JRAYUNSELUNA FLOOD CONTROL PROJECT COMPONENT: WEST FLOODWAY / GARANG RIVER IMPROVEMENT CHANNEL AND DIKE WORKS GARANG RIVER CROSS SECTIONS (26/31)		PROJECT NAME FLOOD CONTROL, URBAN DRAINAGE AND WATER RESOURCES DEVELOPMENT IN SEMARANG IN THE REPUBLIC OF INDONESIA
JAPAN INTERNATIONAL COOPERATION AGENCY CITY ENGINEERING CO., LTD. IN ASSOCIATION WITH PACIFIC CONSULTANTS INTERNATIONAL AND PARCO INTERNATIONAL INC.		DISTRICT SEMARANG CITY
DESIGNED: [Signature] CHECKED: [Signature]		DRAWING NO. WS-P1-CH-CR-88 SHEET NO. 82
CHIEF OF PLANNING AND DESIGN PROJECT MANAGER		DATE CONTRACT NO.

WF. 174+18
TOLL WAY BRIDGE

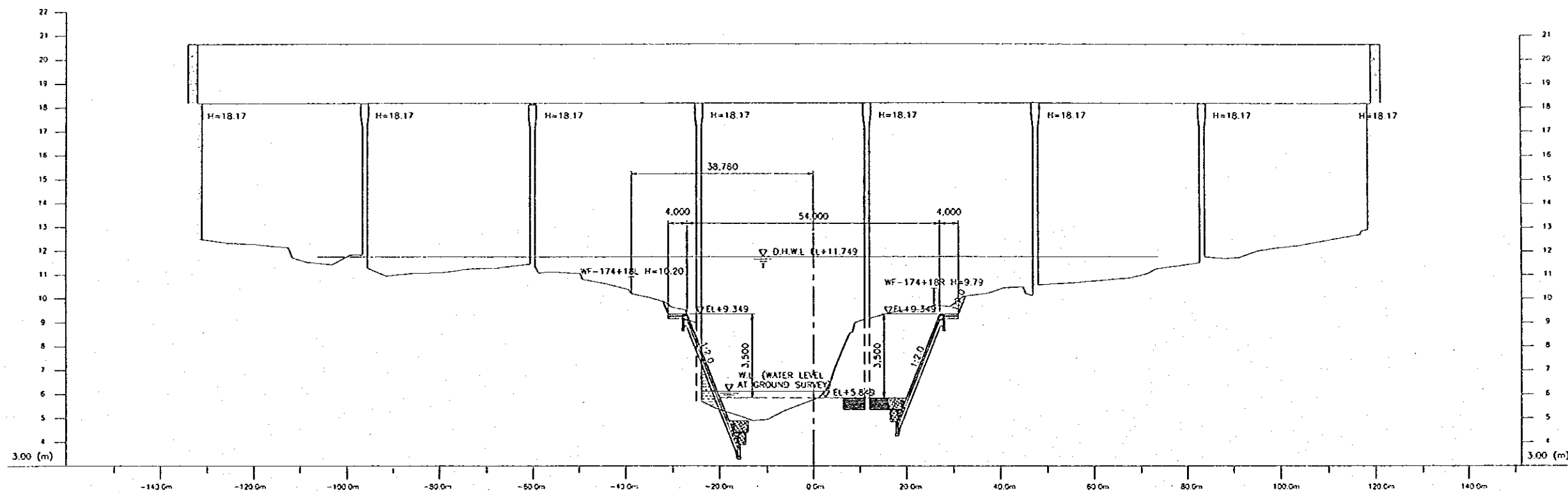

WF. 175

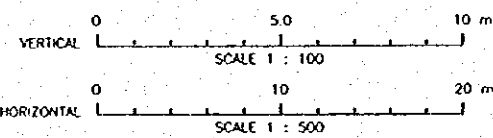
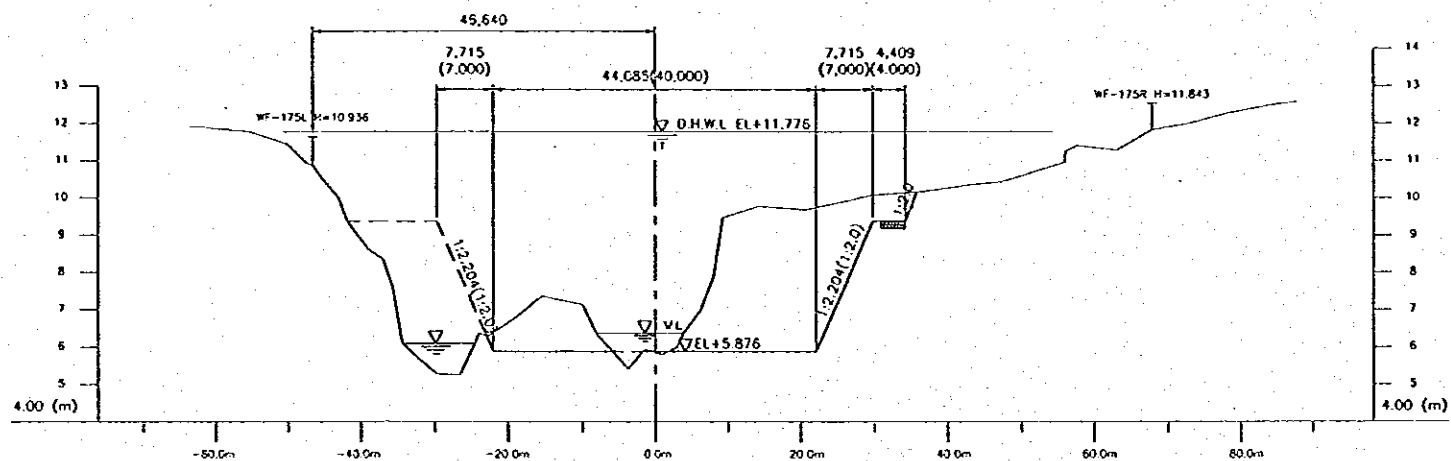

The number in parentheses shows the design dimensions of channel cross section which is perpendicular to the design center line of river channel. (WF. 175)

NO.	DATE	REVISIONS	ORIGINATED	DESIGNED	APPROVED

THE REPUBLIC OF INDONESIA MINISTRY OF PUBLIC WORKS DIRECTORATE GENERAL OF WATER RESOURCES DEVELOPMENT AND DIRECTORATE GENERAL OF HUMAN SETTLEMENT		PROJECT: CENTRAL JAVA PROJECT NAME: FLOOD CONTROL, URBAN DRAINAGE AND WATER RESOURCES DEVELOPMENT IN SEMARANG IN THE REPUBLIC OF INDONESIA DISTRICT: SEMARANG CITY DRAWING NO. WS - P1 - CH - 07.81 SHEET NO. 83
JATUNSELUNA FLOOD CONTROL PROJECT COMPONENT: WEST FLOODWAY / GARANG RIVER IMPROVEMENT CHANNEL AND DIKE WORKS GARANG RIVER CROSS SECTIONS (27/31)		DATE: _____ CONTRACT NO.: _____
JAPAN INTERNATIONAL COOPERATION AGENCY CHE. SHIMIZU CO., LTD. IN ASSOCIATION WITH PACIFIC CONSULTANTS INTERNATIONAL, INC. JAWA INTERNATIONAL, INC.		DESIGNED: _____ CHECKED: _____ APPROVED: _____ PROJECT MANAGER