

JAPAN INTERNATIONAL COOPERATION AGENCY  
 THE STUDY ON THE OUTER CIRCULAR HIGHWAY  
 TO THE CITY OF COLOMBO

Interchange At Road A1

ORIENTAL CONSULTANTS CO.Ltd.  
 February -2000 | Sheet No: 45

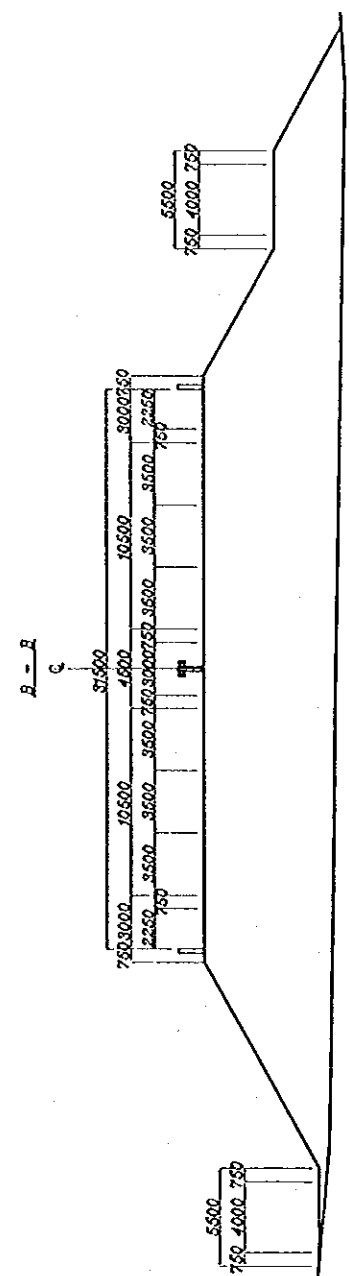
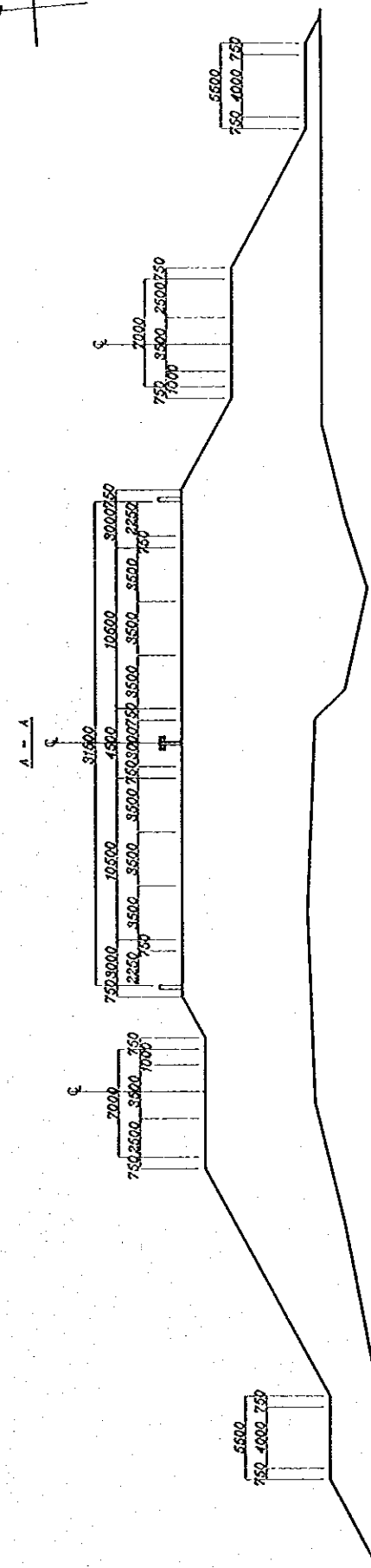
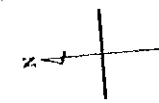
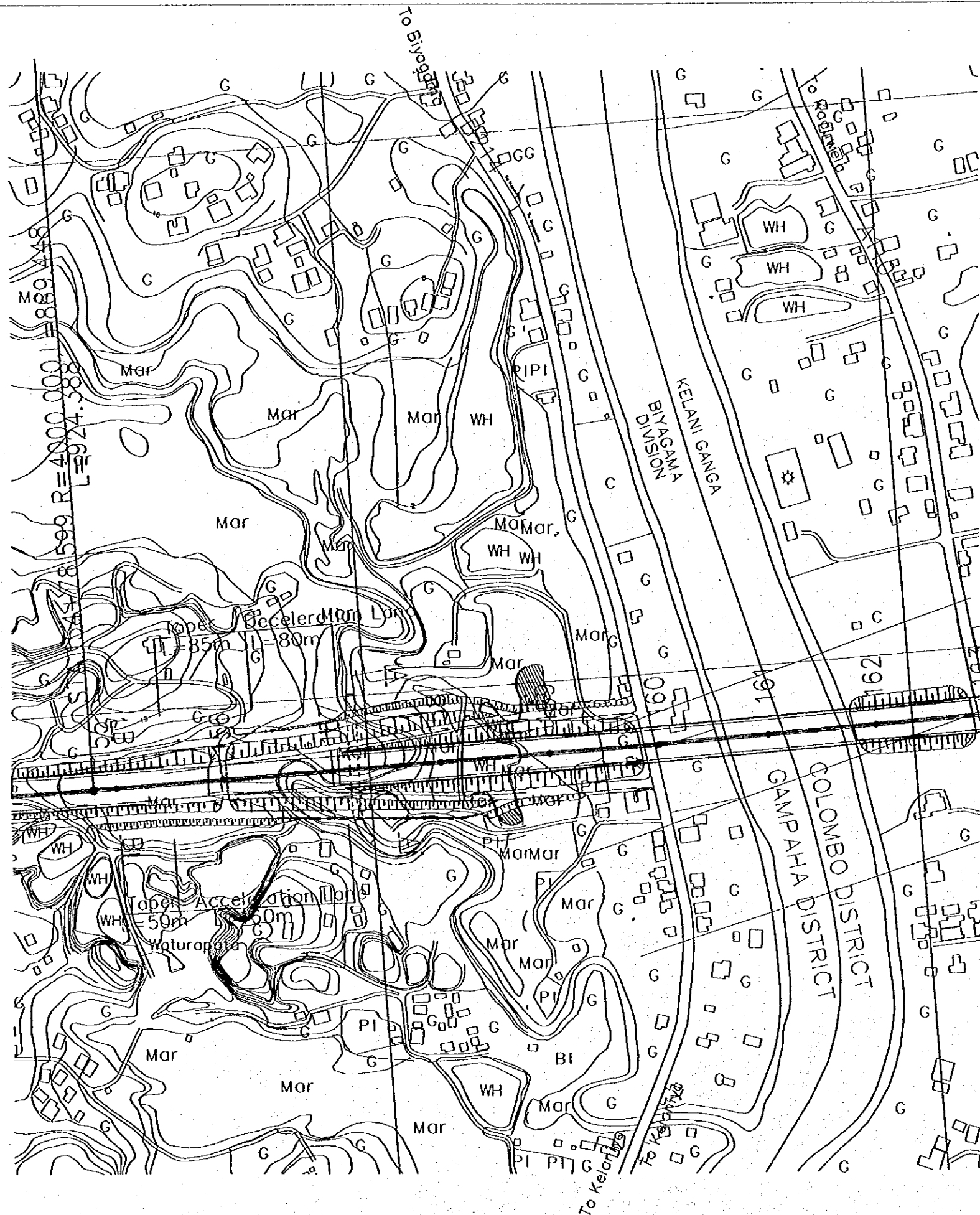

JAPAN INTERNATIONAL COOPERATION AGENCY  
 THE STUDY ON THE OUTER CIRCULAR HIGHWAY  
 TO THE CITY OF COLONBO

Interchange At Road B214

ORIENTAL CONSULTANTS CO. LTD.  
 February - 2000 | Sheet No: 46

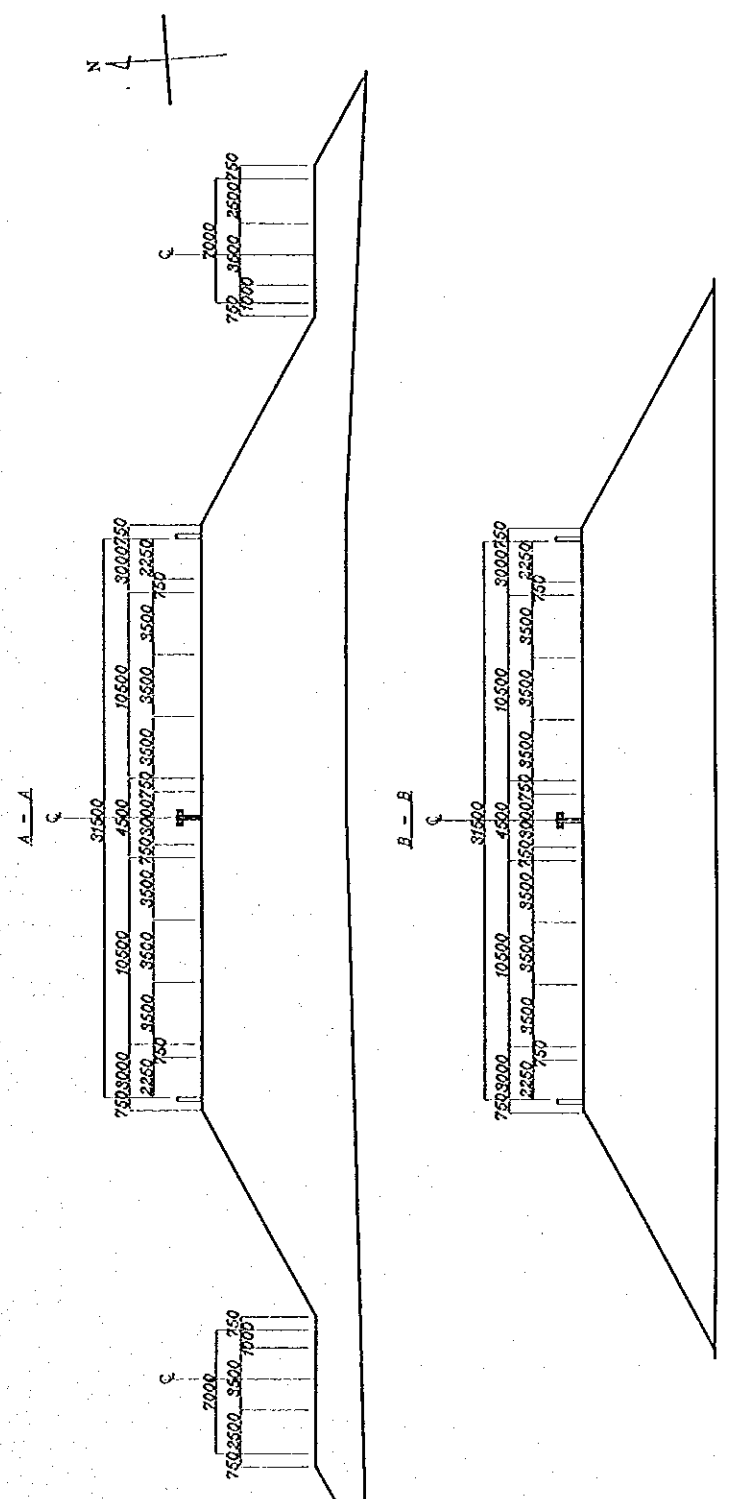
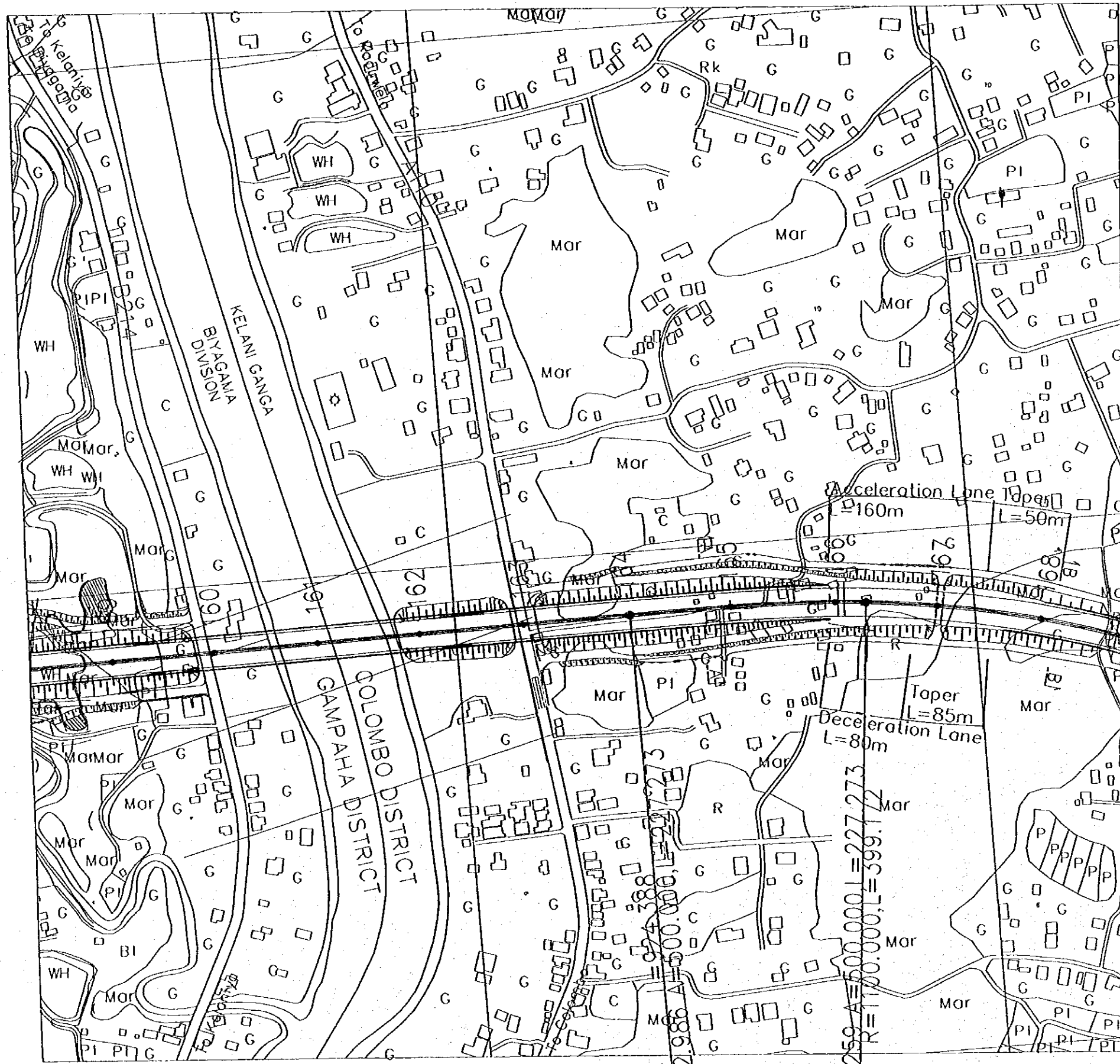

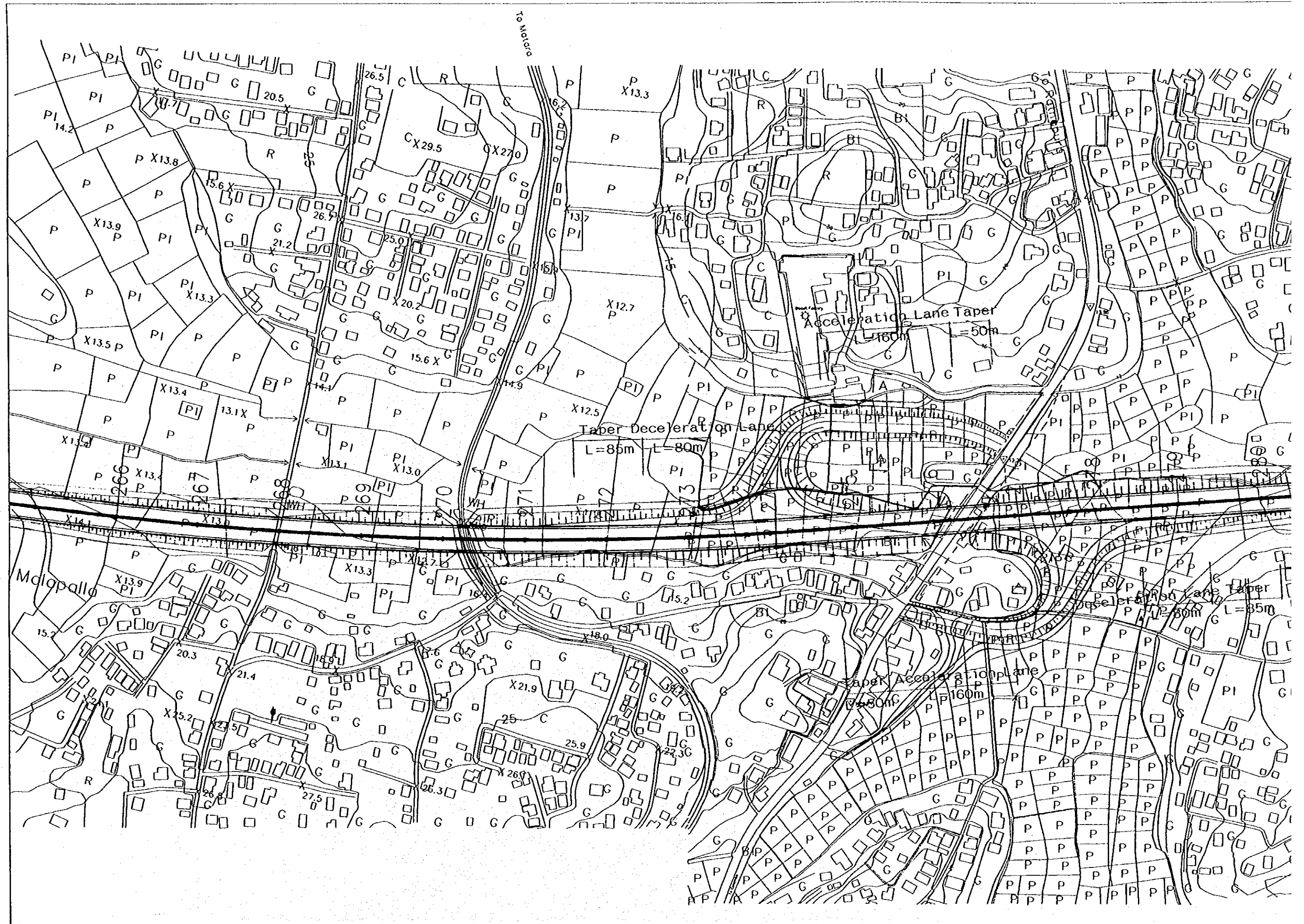

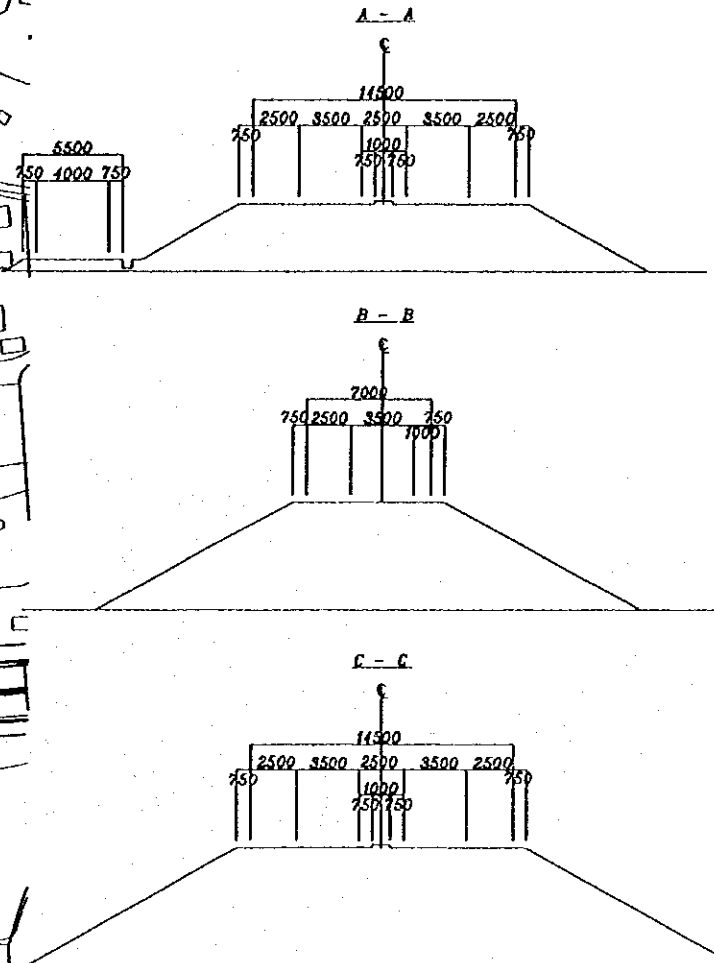
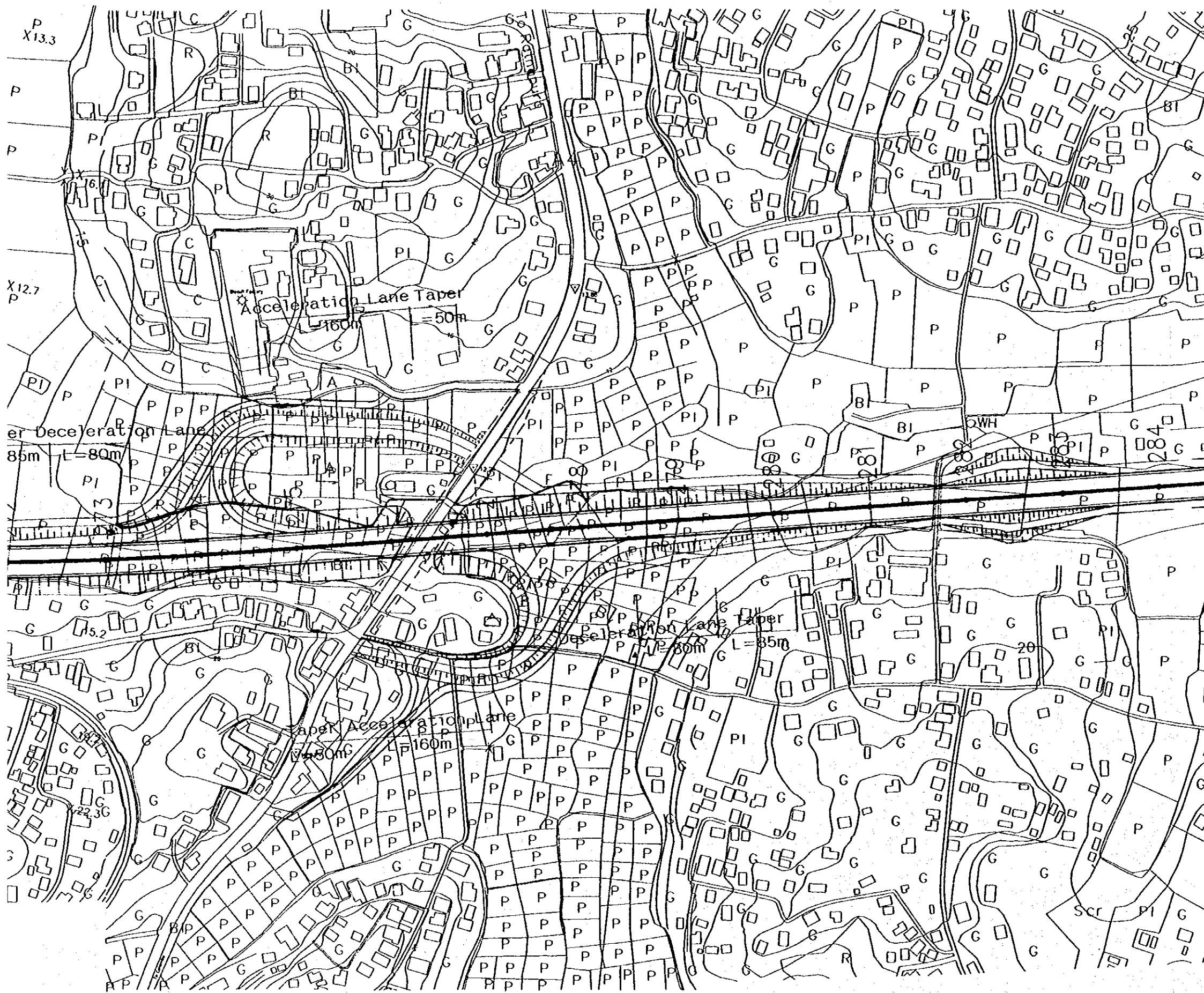

JAPAN INTERNATIONAL COOPERATION AGENCY  
 THE STUDY ON THE OUTER CIRCULAR HIGHWAY  
 TO THE CITY OF COLOMBO

Interchange At Road A4 (1)  
 (Basic: Half Clover Type)

ORIENTAL CONSULTANTS CO.LTD  
 February - 2000      Sheet No. 48

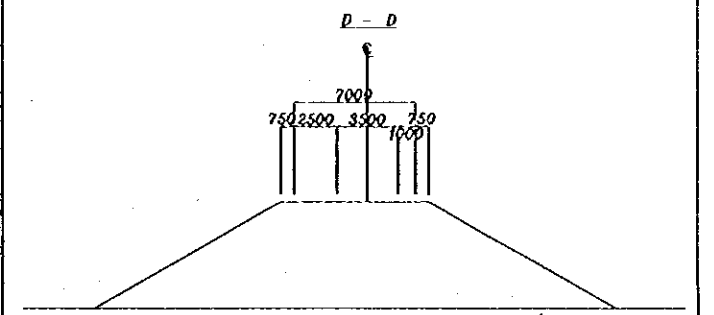
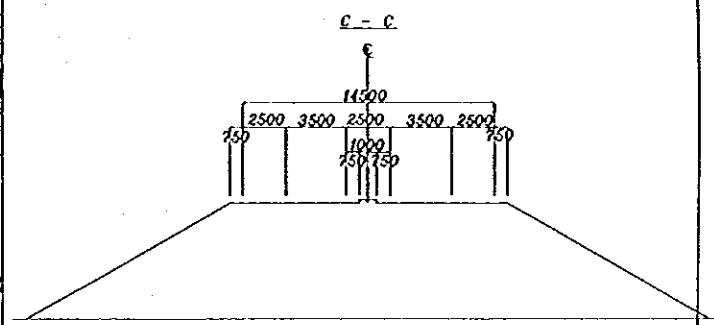
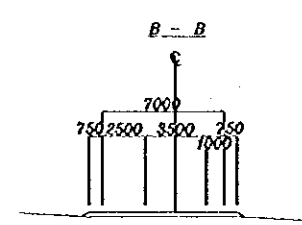
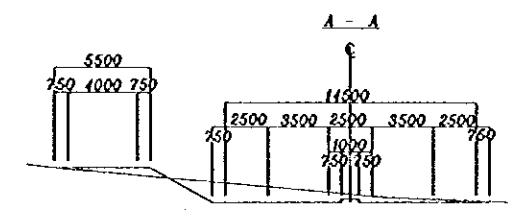
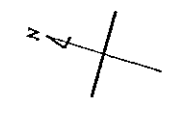

JAPAN INTERNATIONAL COOPERATION AGENCY  
 THE STUDY ON THE OUTER CIRCULAR HIGHWAY  
 TO THE CITY OF COLOMBO

Interchange At Road A4 (2)  
 (Alternative: Double Trumpet Type)

ORIENTAL CONSULTANTS CO. Ltd.  
 February - 2000 Sheet No. 49

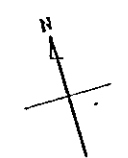

2000+000.1=367.030

A-A

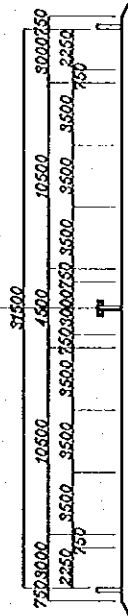

B-B

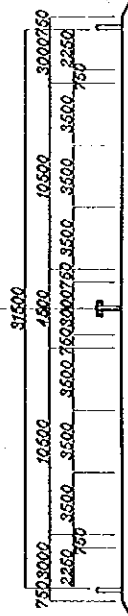

JAPAN INTERNATIONAL COOPERATION AGENCY  
THE STUDY ON THE OUTER CIRCULAR HIGHWAY  
TO THE CITY OF COLOMBO

Interchange At Road B84



ORIENTAL CONSULTANTS CO. LTD.

February -2000

Sheet No: 50



JAPAN INTERNATIONAL COOPERATION AGENCY  
 THE STUDY ON THE OUTER CIRCULAR HIGHWAY  
 TO THE CITY OF COLOMBO

Interchange At Road A8



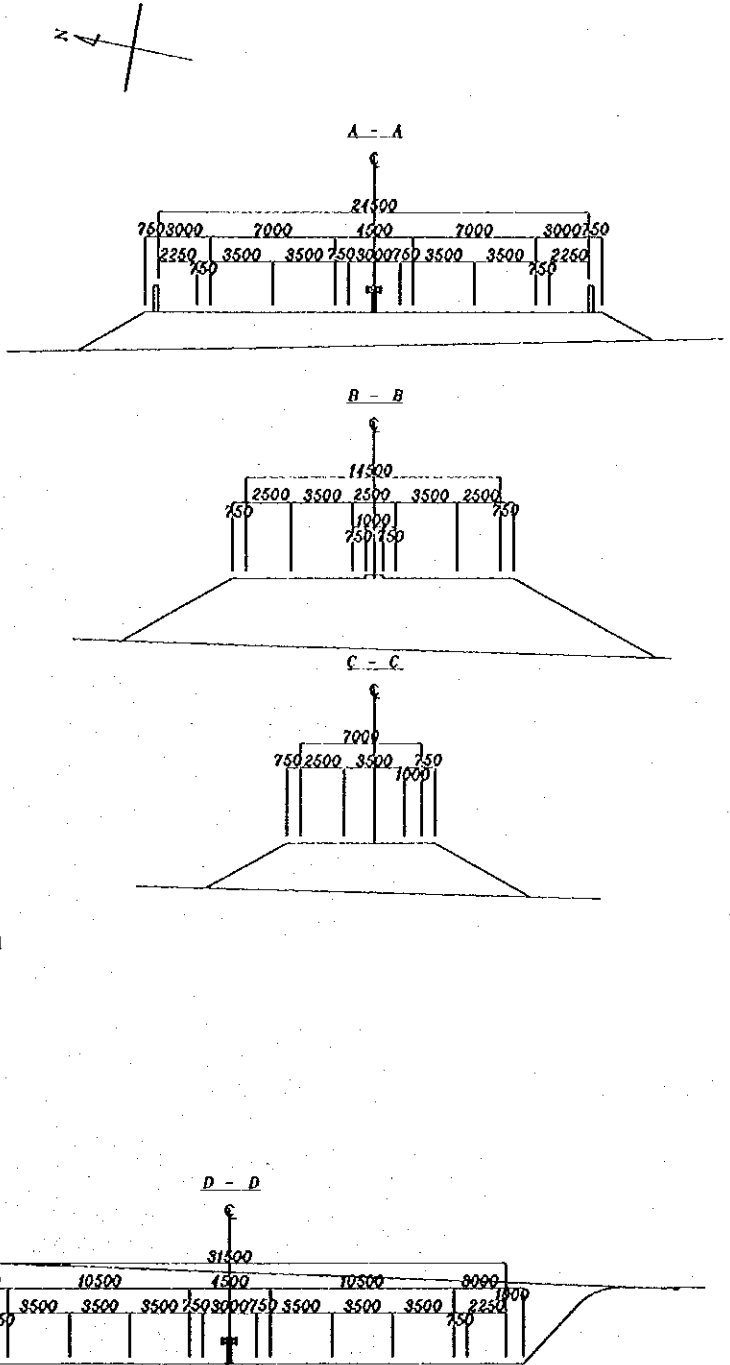
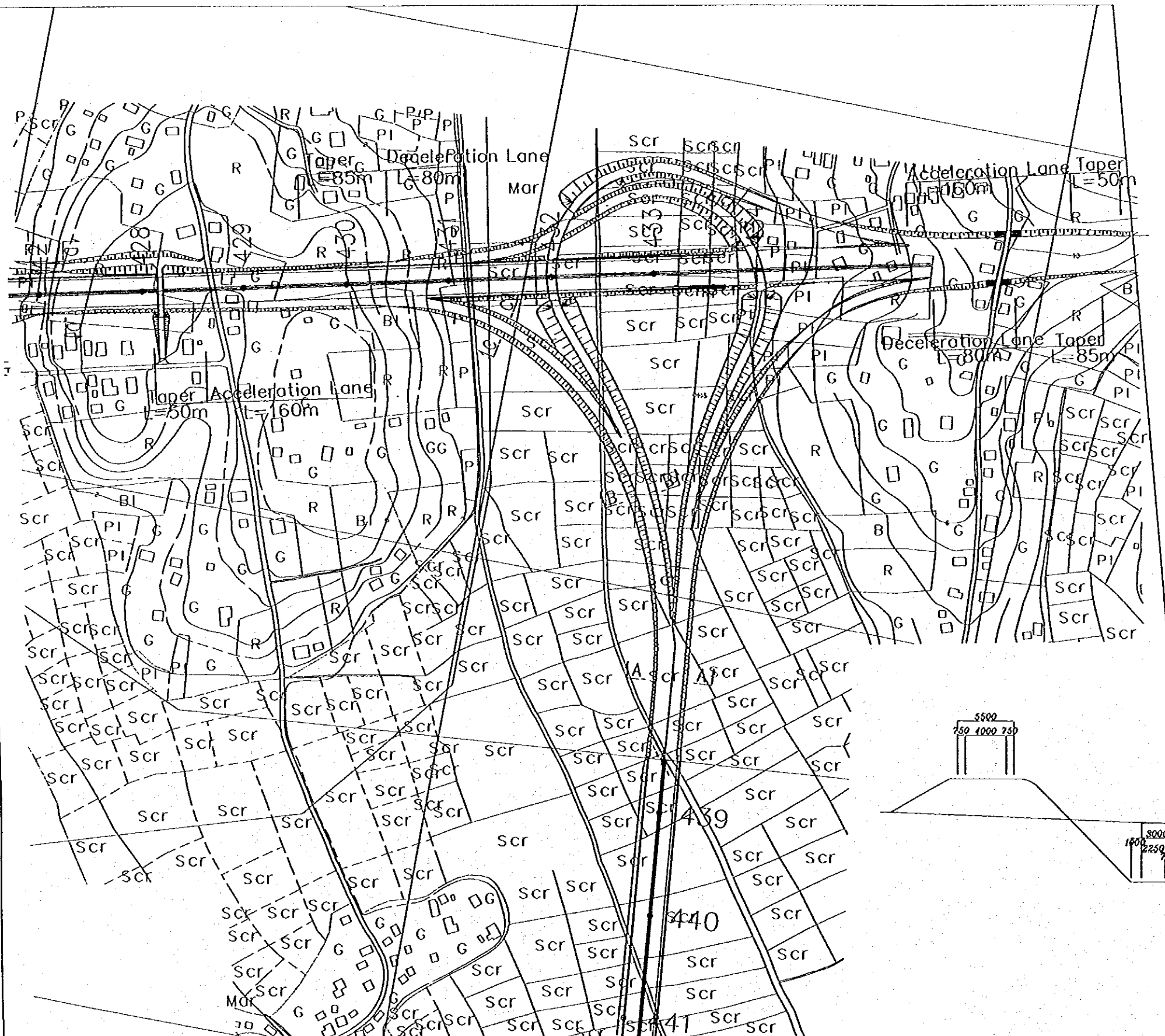

JAPAN INTERNATIONAL COOPERATION AGENCY  
 THE STUDY ON THE OUTER CIRCULAR HIGHWAY  
 TO THE CITY OF COLOMBO

Junction At Southern Transport Corridor

ORIENTAL CONSULTANTS CO. Ltd.  
 February -2000 Sheet No. 52

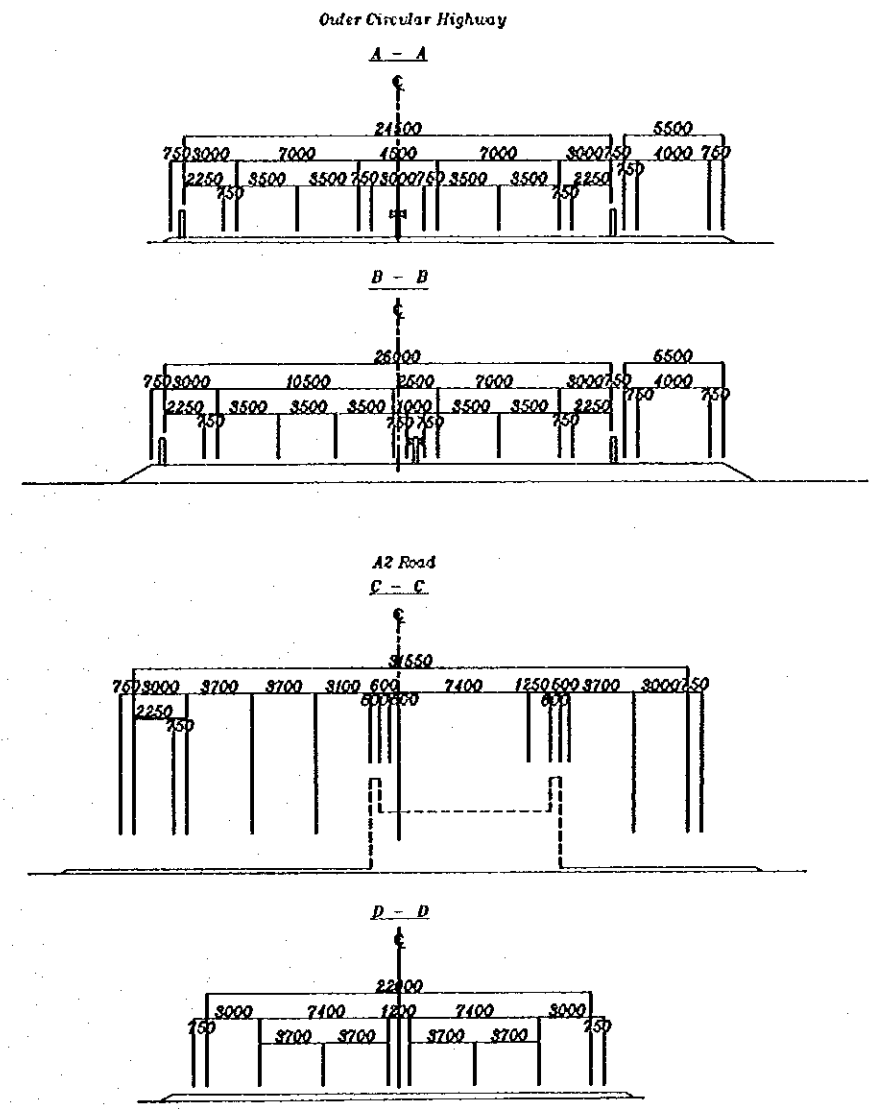
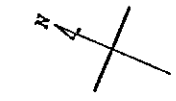
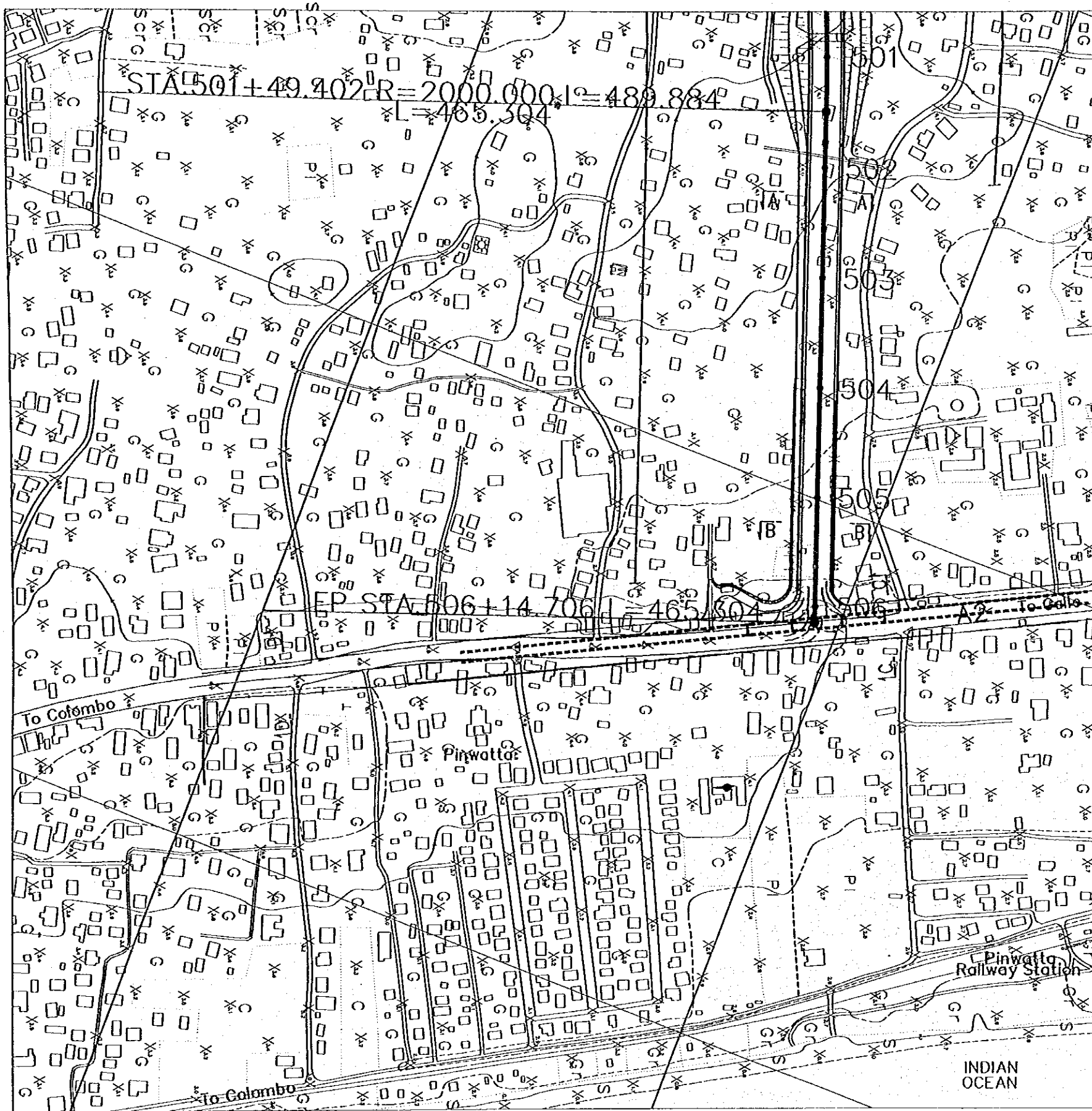

JAPAN INTERNATIONAL COOPERATION AGENCY  
 THE STUDY ON THE OUTER CIRCULAR HIGHWAY  
 TO THE CITY OF COLOMBO

Interchange At Road A2

ORIENTAL CONSULTANTS CO. LTD.  
 February -2000 Sheet No: 53

JICA

