

# 圖 面

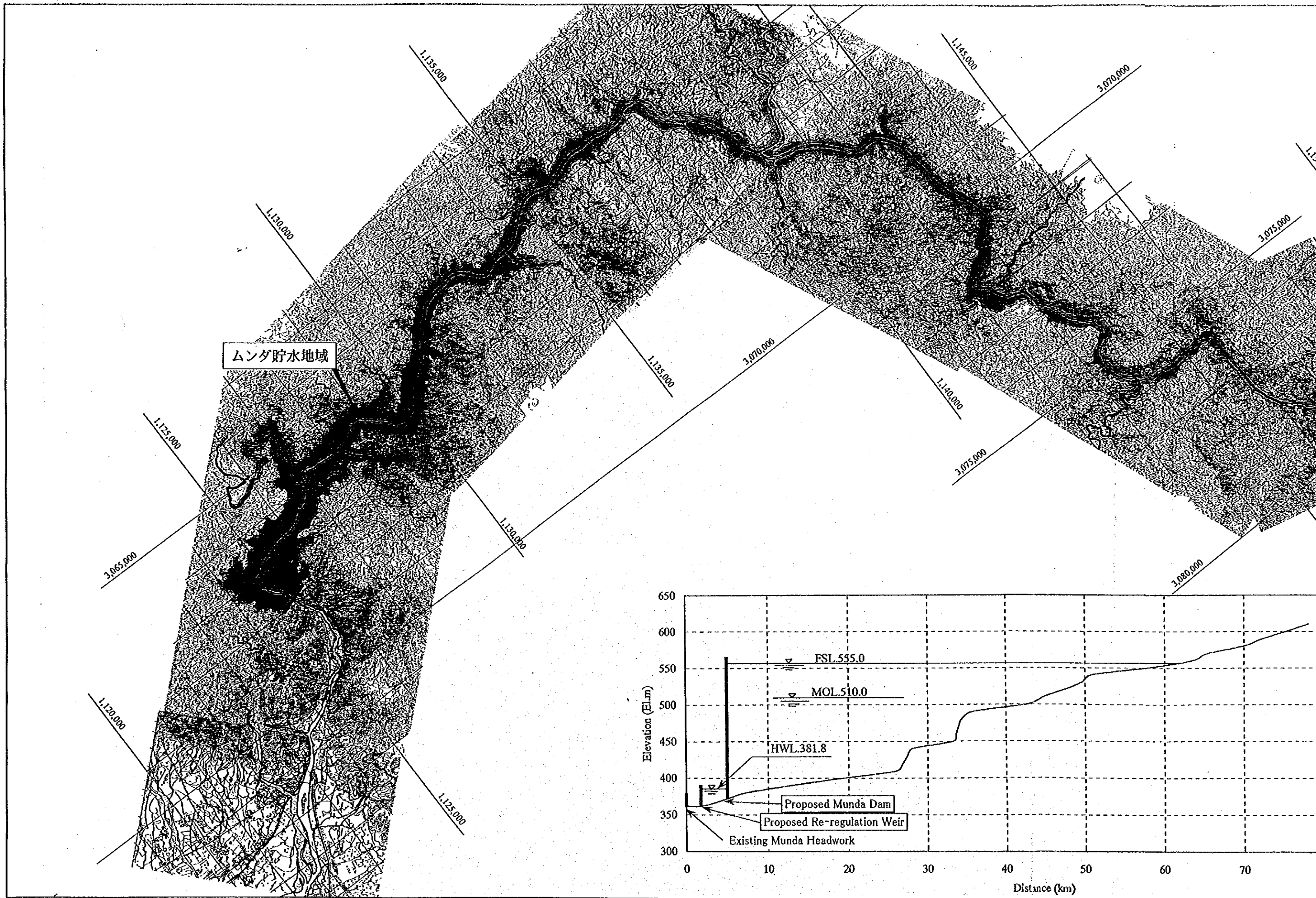

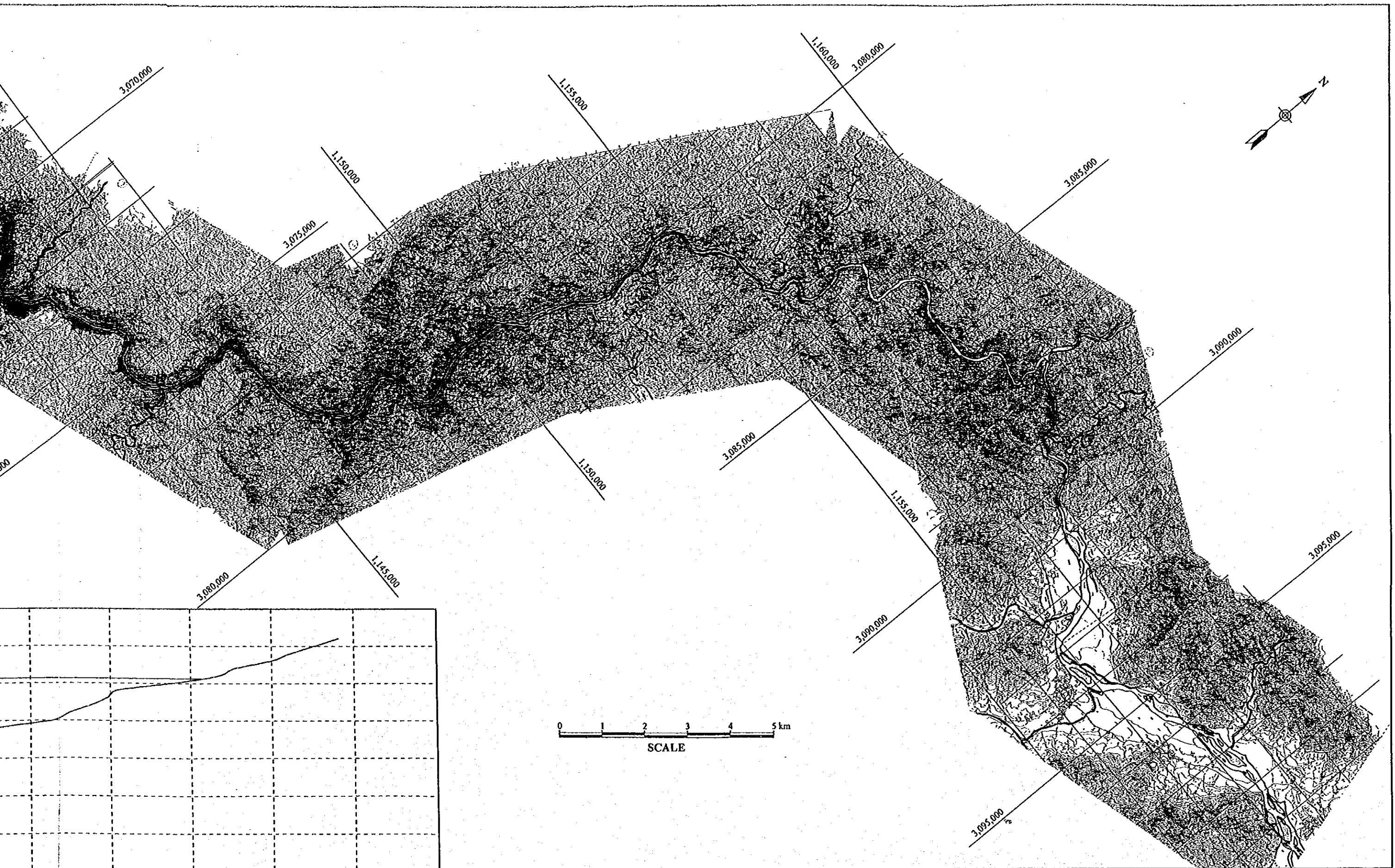

40 50 60 70 80 90  
Distance (km)

FEASIBILITY STUDY  
ON THE DEVELOPMENT OF MUNDA DAM MULTIPURPOSE PROJECT  
IN ISLAMIC REPUBLIC OF PAKISTAN  
JAPAN INTERNATIONAL COOPERATION AGENCY

図面 S1

貯水地域

SD1



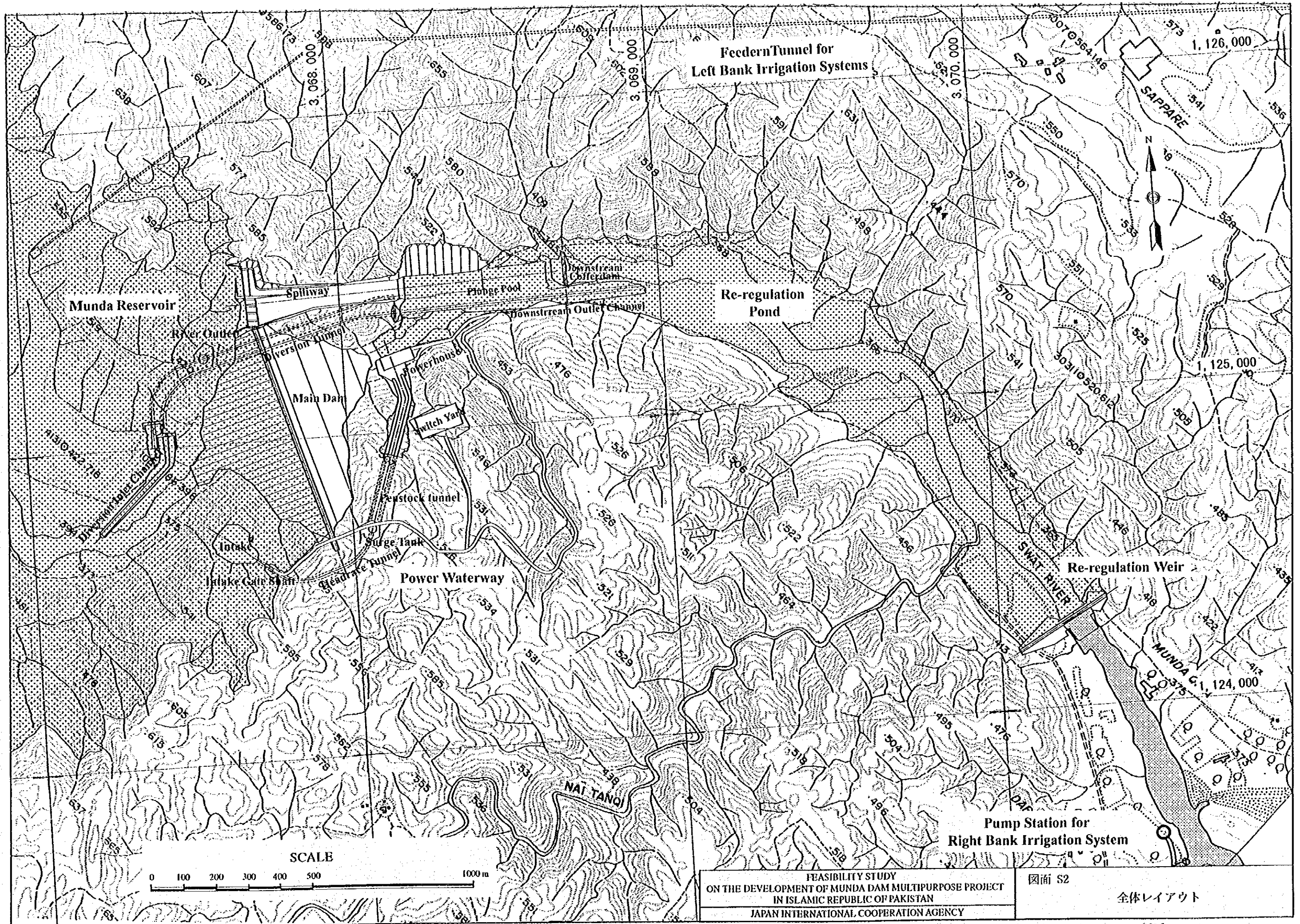

FEASIBILITY STUDY  
 ON THE DEVELOPMENT OF MUNDA DAM MULTIPURPOSE PROJECT  
 IN ISLAMIC REPUBLIC OF PAKISTAN  
 JAPAN INTERNATIONAL COOPERATION AGENCY

図面 S2  
 全体レイアウト

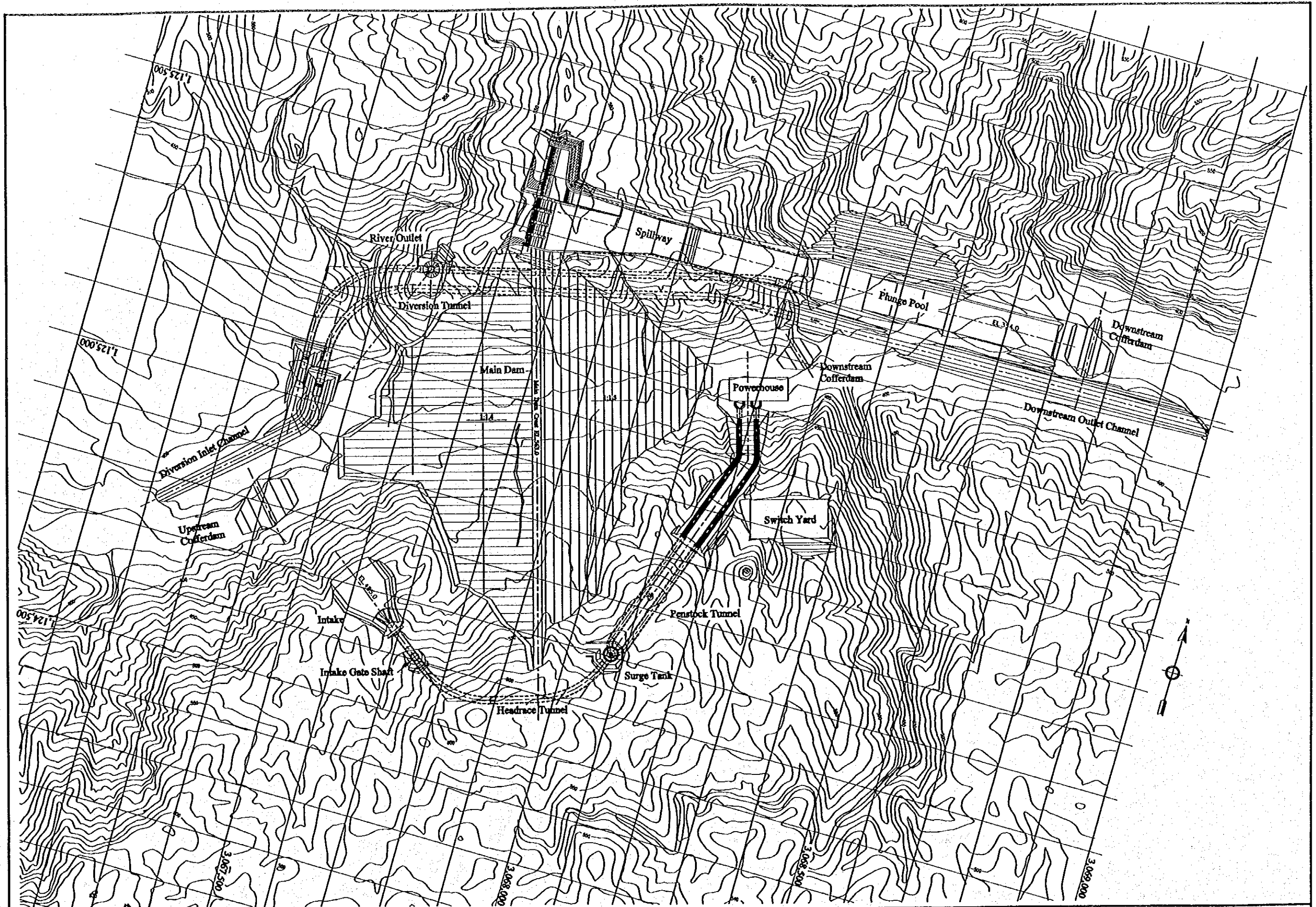

FEASIBILITY STUDY  
 ON THE DEVELOPMENT OF MUNDA DAM MULTIPURPOSE PROJECT  
 IN ISLAMIC REPUBLIC OF PAKISTAN  
 JAPAN INTERNATIONAL COOPERATION AGENCY

図面 S3

全体平面図



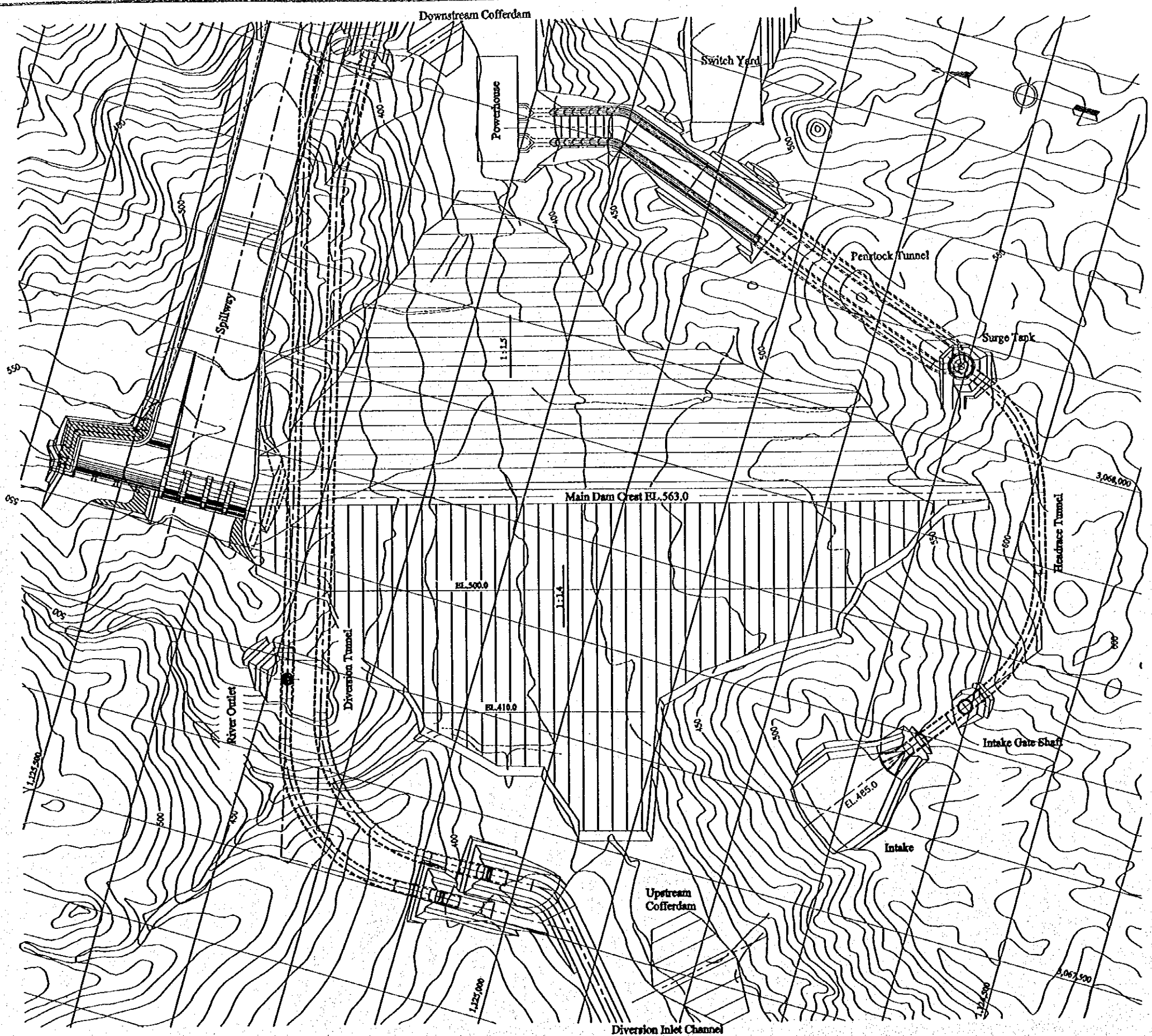

SCALE A 0 200m

PLAN SCALE A

FRASIBILITY STUDY  
 ON THE DEVELOPMENT OF MUNDA DAM MULTIPURPOSE PROJECT  
 IN ISLAMIC REPUBLIC OF PAKISTAN  
 JAPAN INTERNATIONAL COOPERATION AGENCY

図面 S4

メインダム平面図

SD4

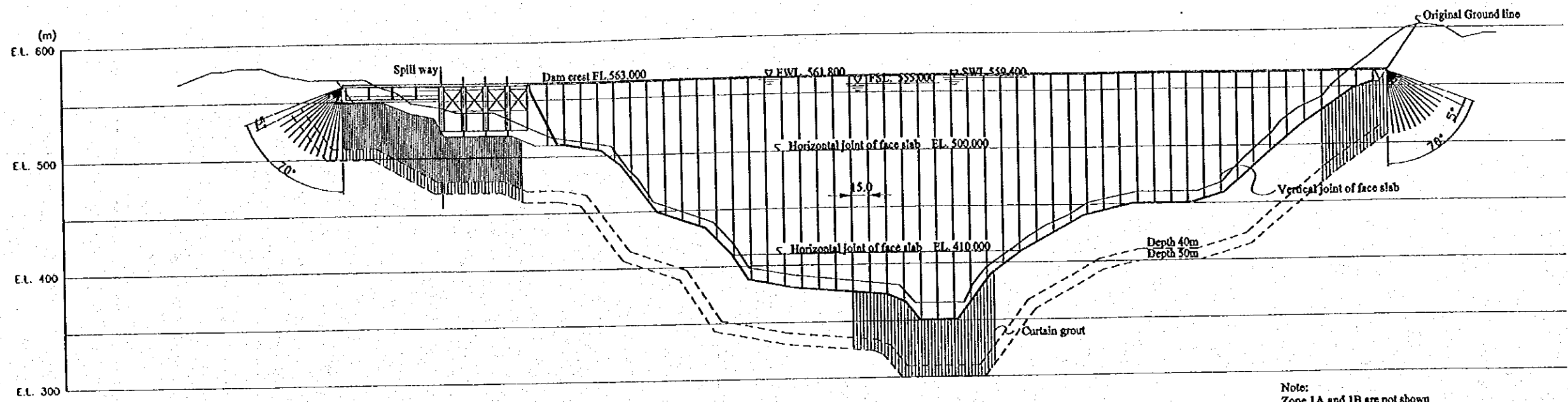

MAIN DAM FRONT ELEVATION

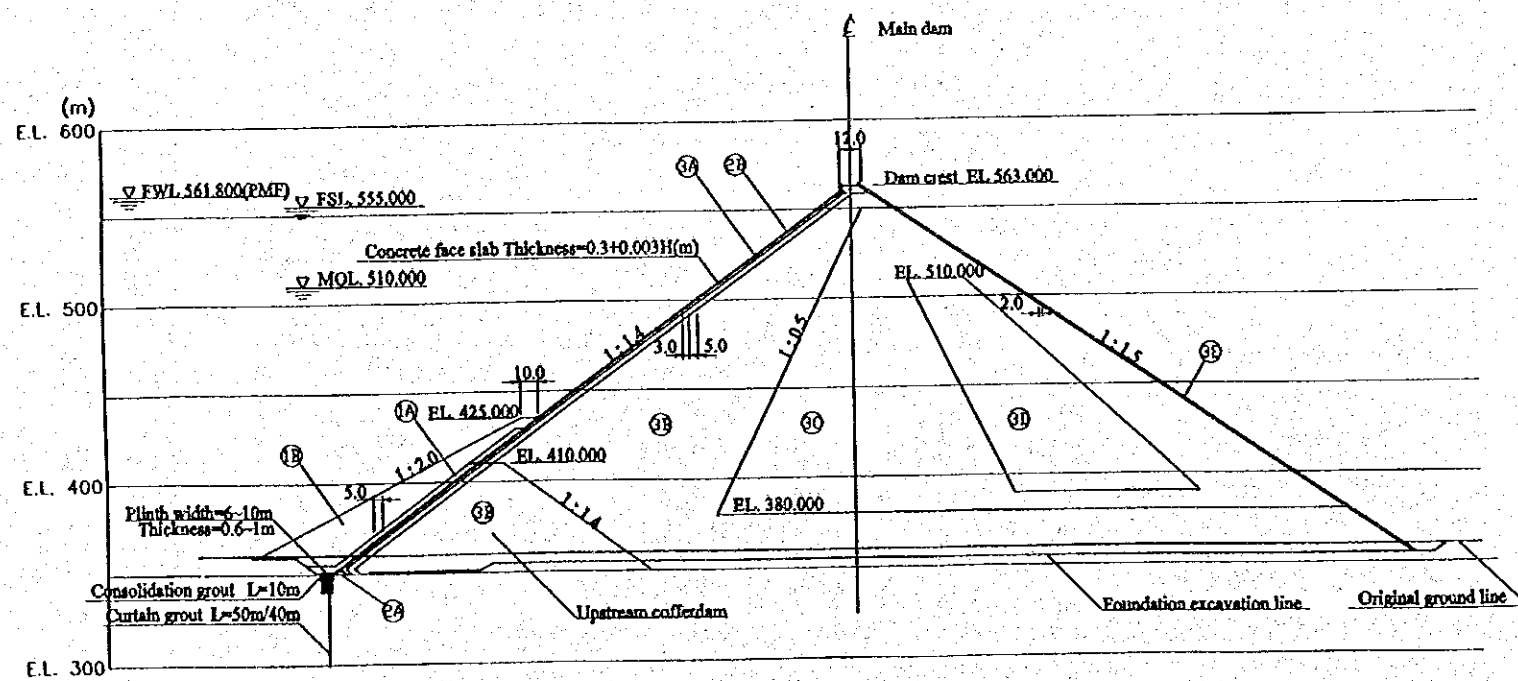

TYPICAL SECTION

ZONE	CLASSIFICATION
1A	Impervious earth fill
1B	Radom fill
2A	Fine filter
2B	Crusher run
3A	Selected small rock
3B	Rock fill(Lime stone)
3C	Rock fill(schist)
3D	Rock fill(Excavated rock)
3E	Selected large rock

SCALE A 0 200m

FEASIBILITY STUDY  
ON THE DEVELOPMENT OF MUNDA DAM MULTIPURPOSE PROJECT  
IN ISLAMIC REPUBLIC OF PAKISTAN  
JAPAN INTERNATIONAL COOPERATION AGENCY

図面 S5  
メインダム正面図及び標準断面図

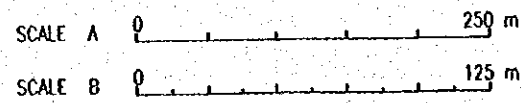
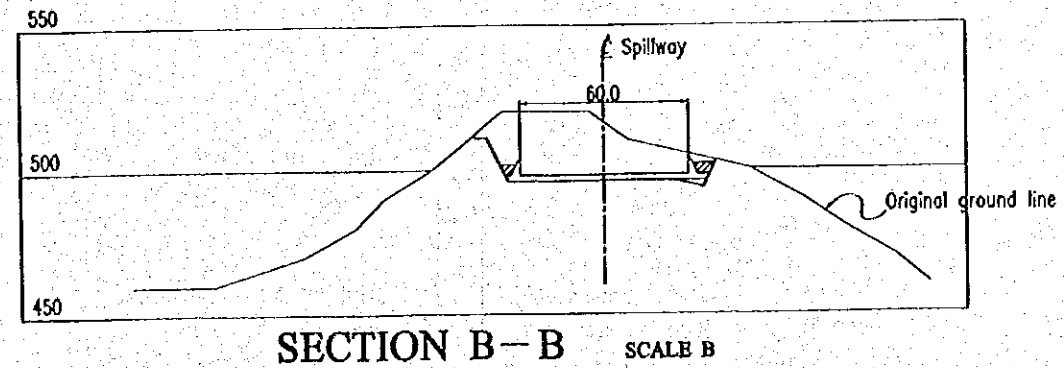
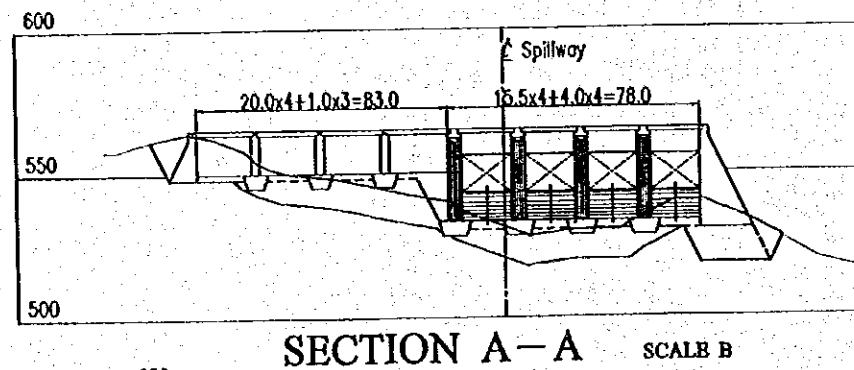
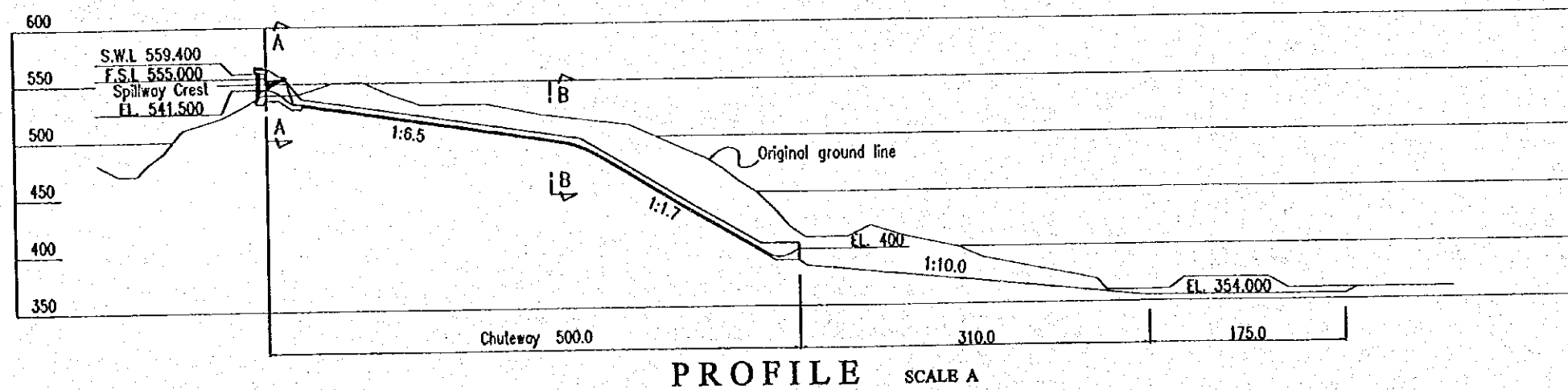
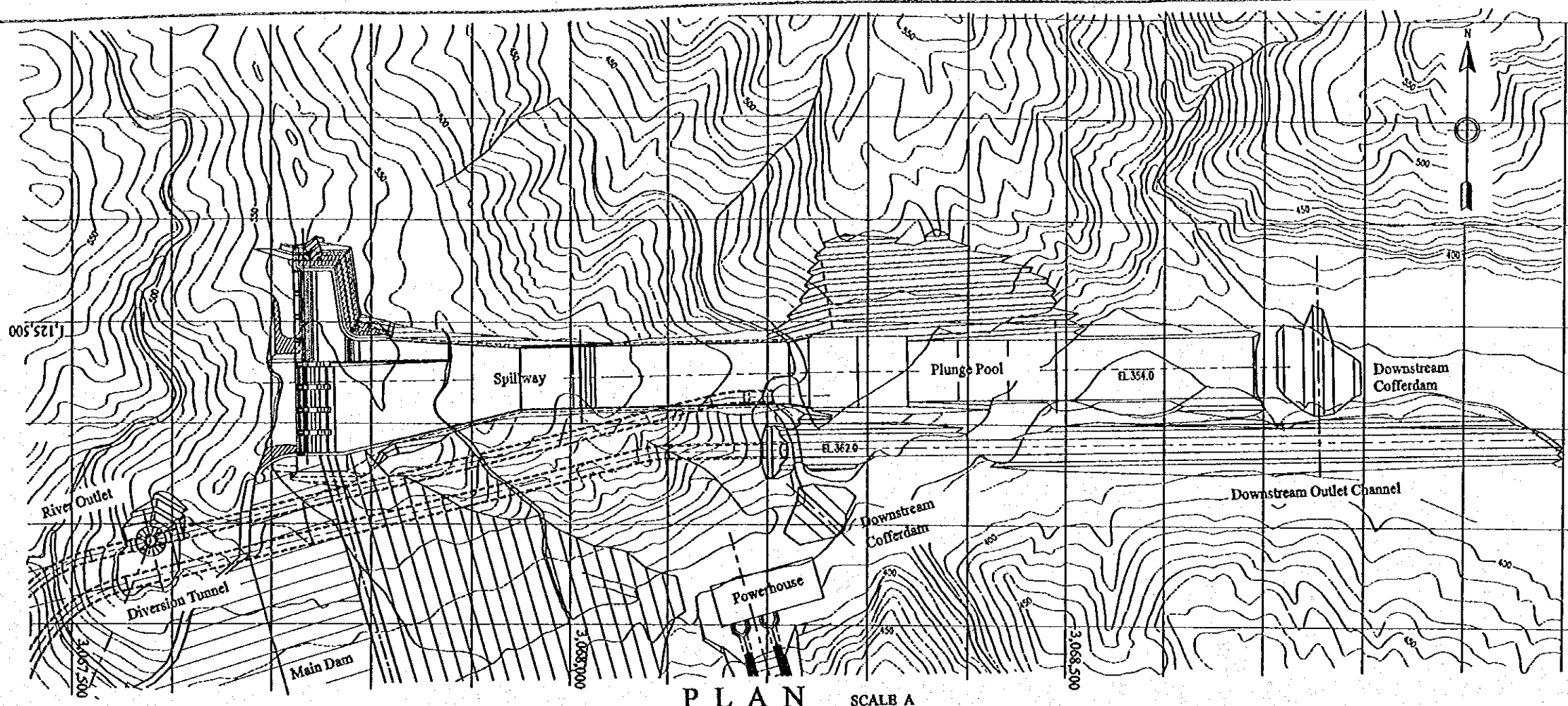

FEASIBILITY STUDY  
ON THE DEVELOPMENT OF MUNDA DAM MULTIPURPOSE PROJECT  
IN ISLAMIC REPUBLIC OF PAKISTAN  
JAPAN INTERNATIONAL COOPERATION AGENCY

図面 S6  
スピルウェイ計画図





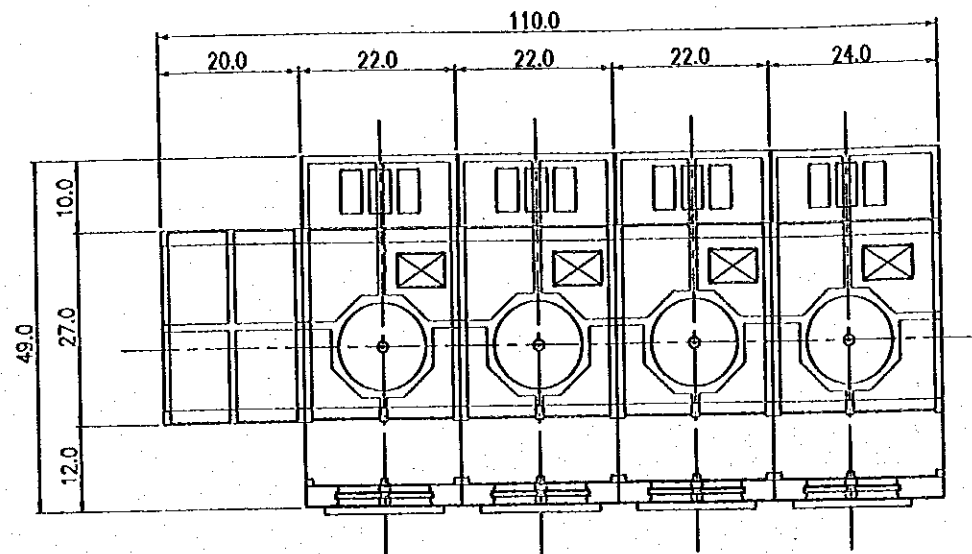

PLAN SCALE A

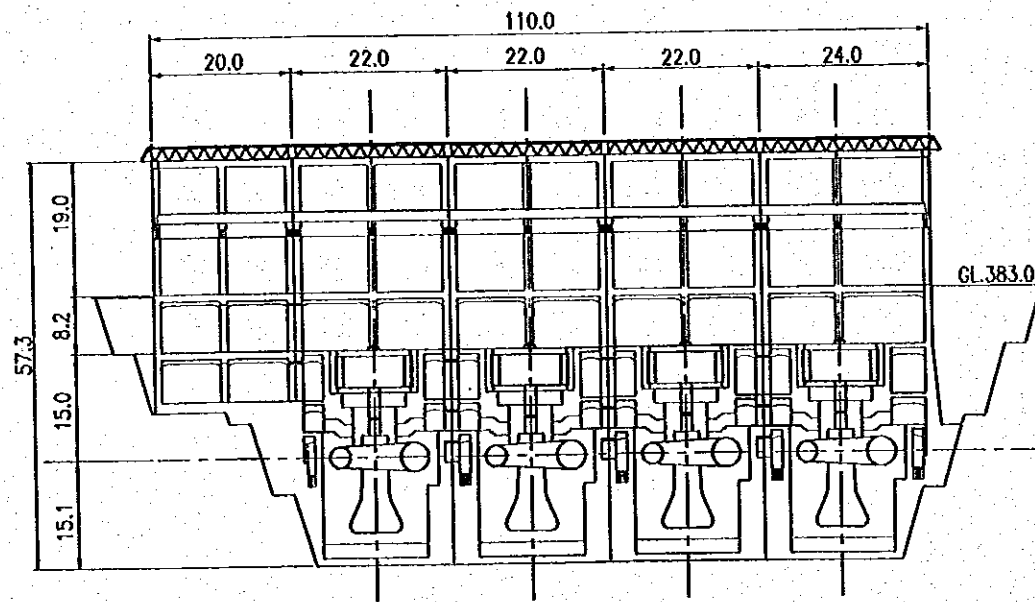

LONGITUDINAL SECTION SCALE A

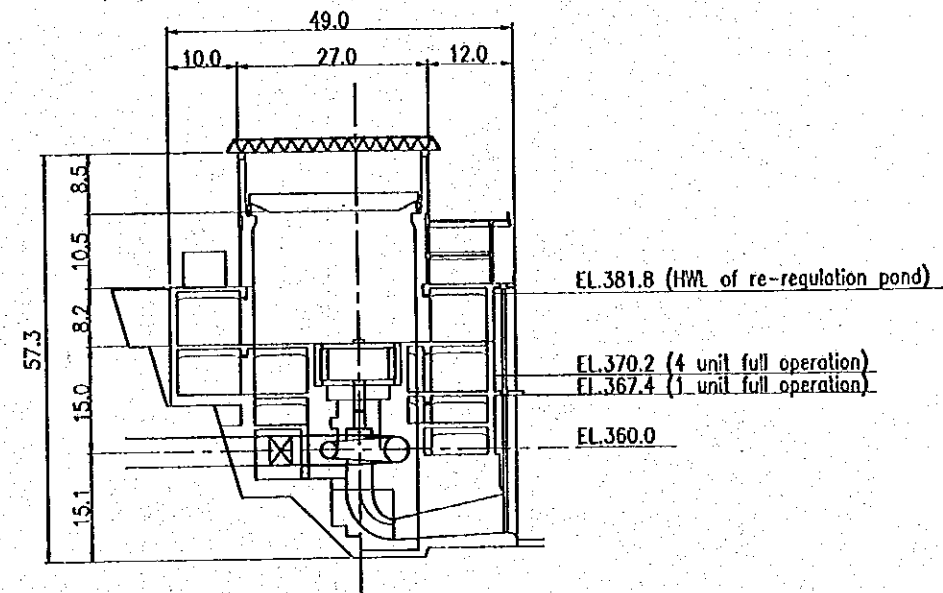

TRANSVERSE SECTION SCALE A

SCALE A 0 50 m

FEASIBILITY STUDY  
ON THE DEVELOPMENT OF MUNDA DAM MULTIPURPOSE PROJECT  
IN ISLAMIC REPUBLIC OF PAKISTAN  
JAPAN INTERNATIONAL COOPERATION AGENCY

図面 S8

発電所計画図

SD8

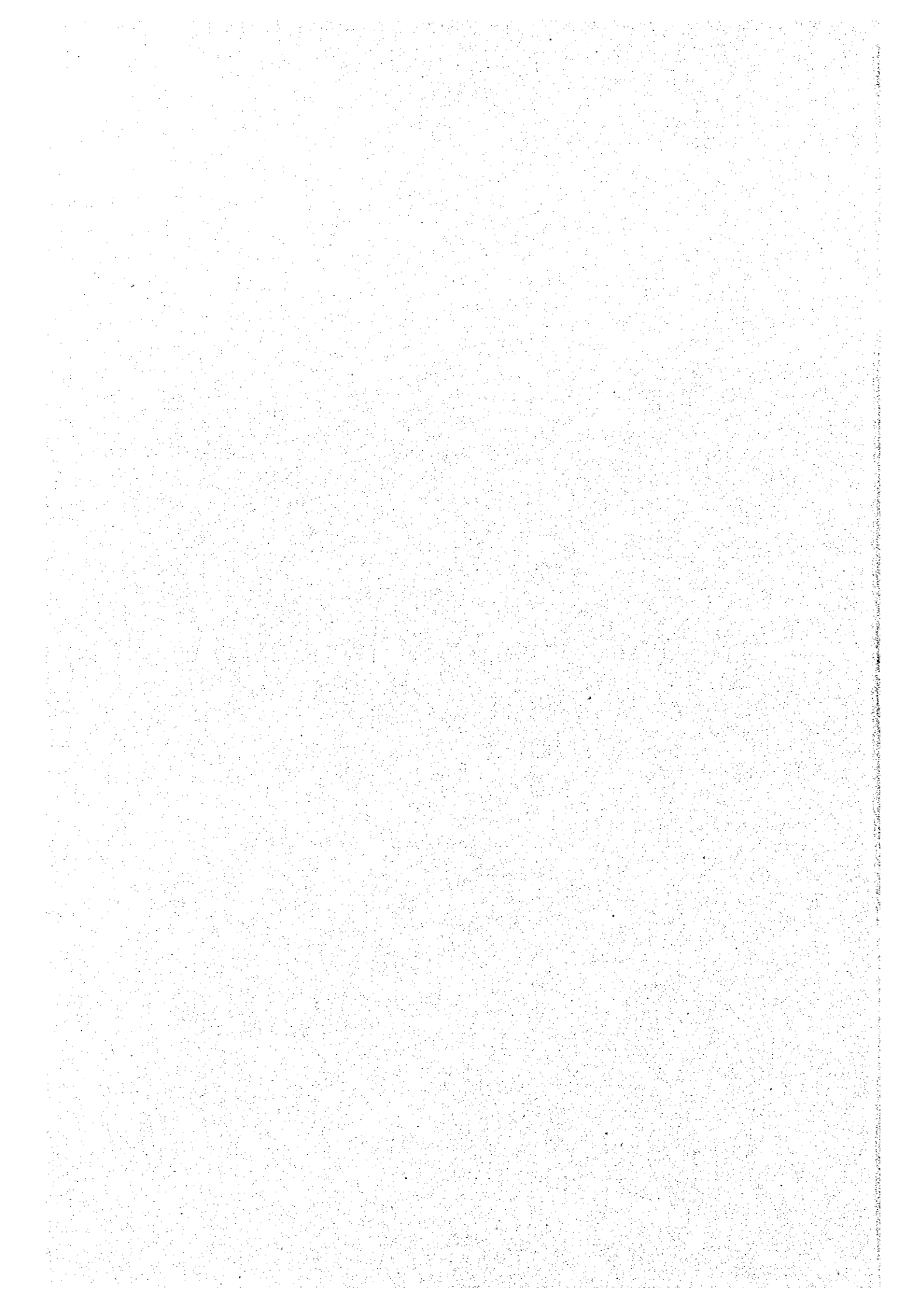



Year	Number of people
2000	1000
2001	1200
2002	1500
2003	1800
2004	2000



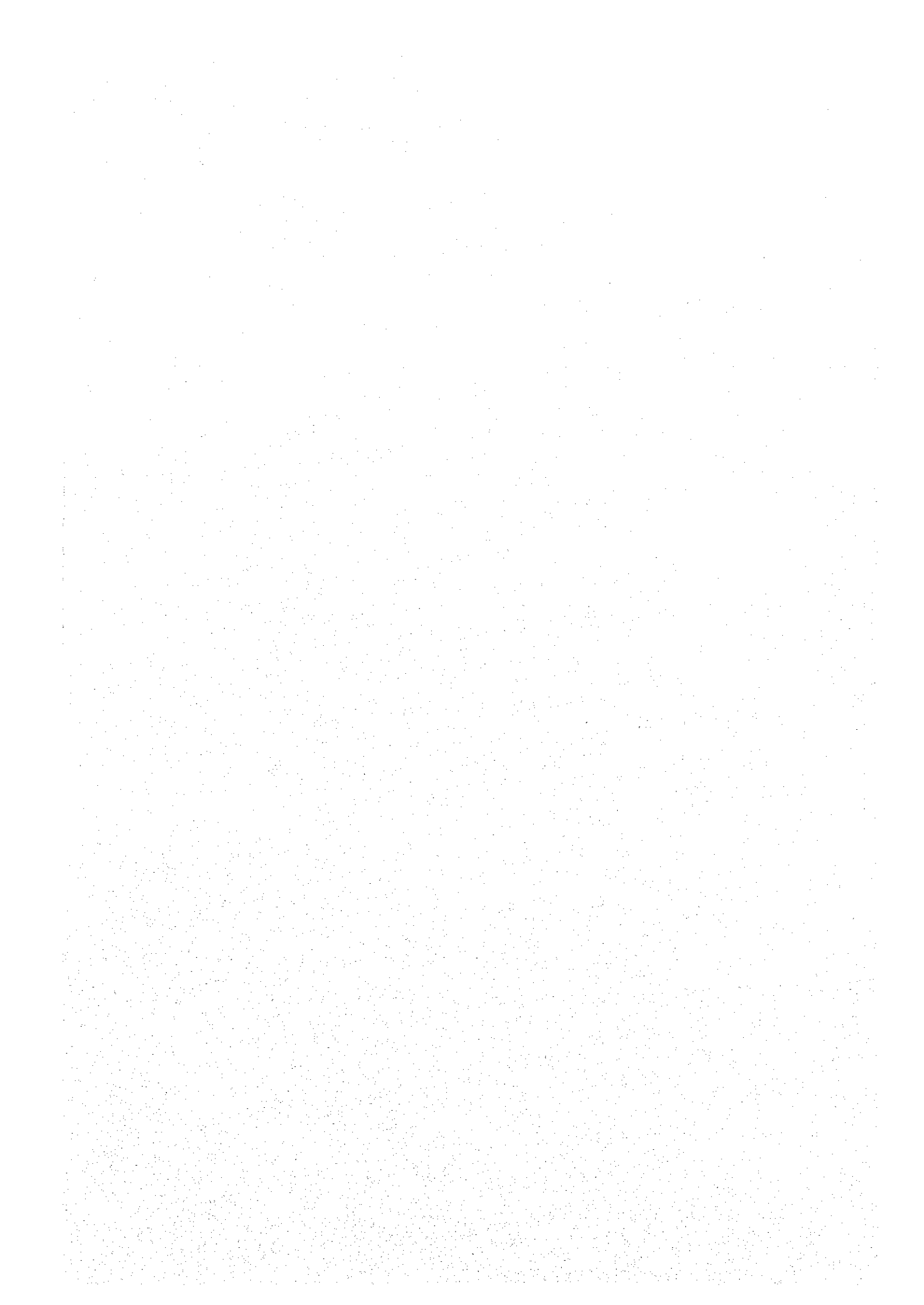



JICA

