

The Study on Drainage Improvement and Flood Control  
 in the Municipality of Phnom Penh  
 JICA - CTIE International Co., Ltd. - Nippon Koei Co., Ltd.

Figure 12-25  
 Digital Mapping Sheet Index

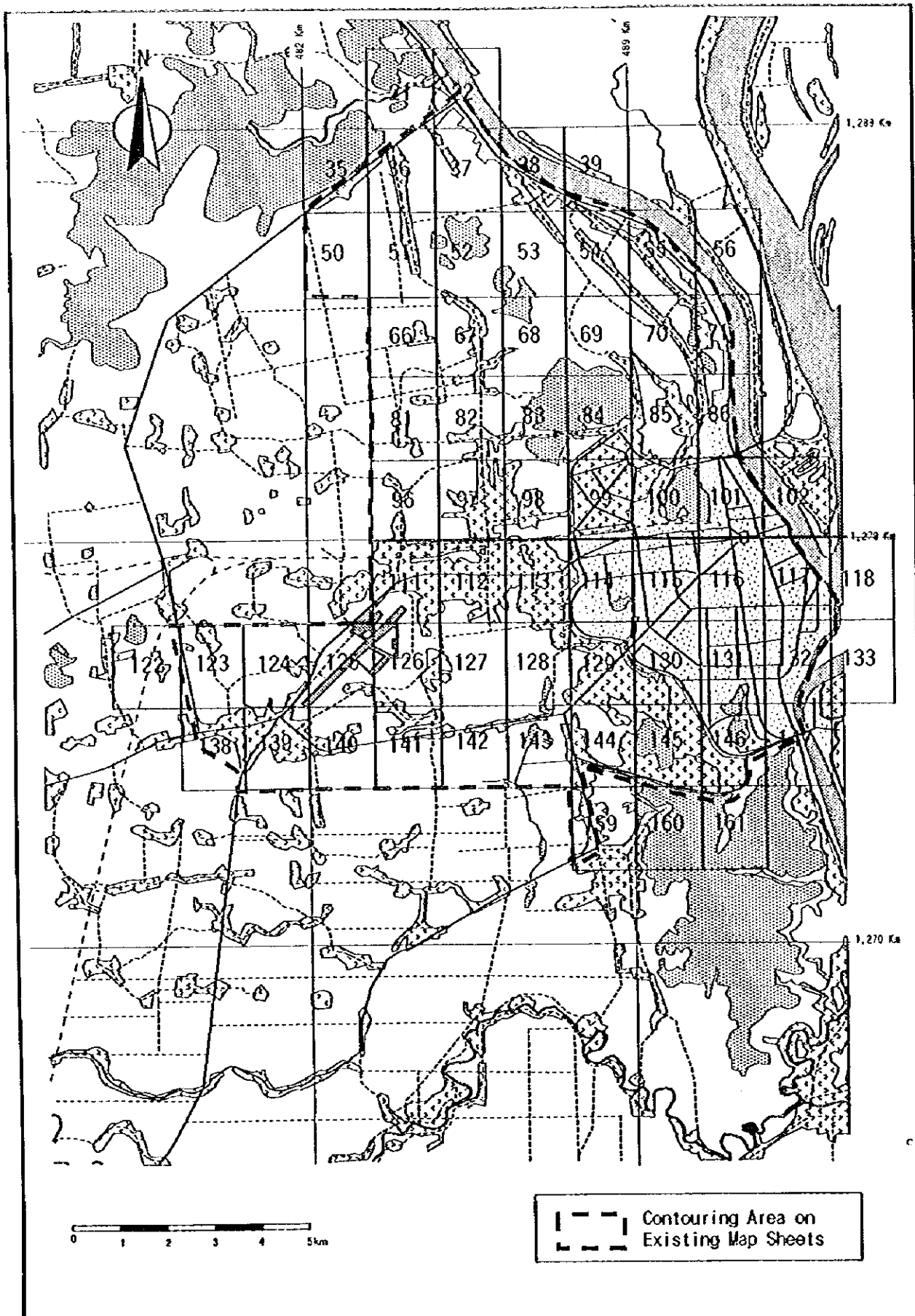

The Study on Drainage Improvement and Flood Control  
in the Municipality of Phnom Penh  
JICA - CTIE International Co., Ltd. - Nippon Koei Co., Ltd.

Figure 12-26  
Contour Line Map Sheet Index on Existing Map

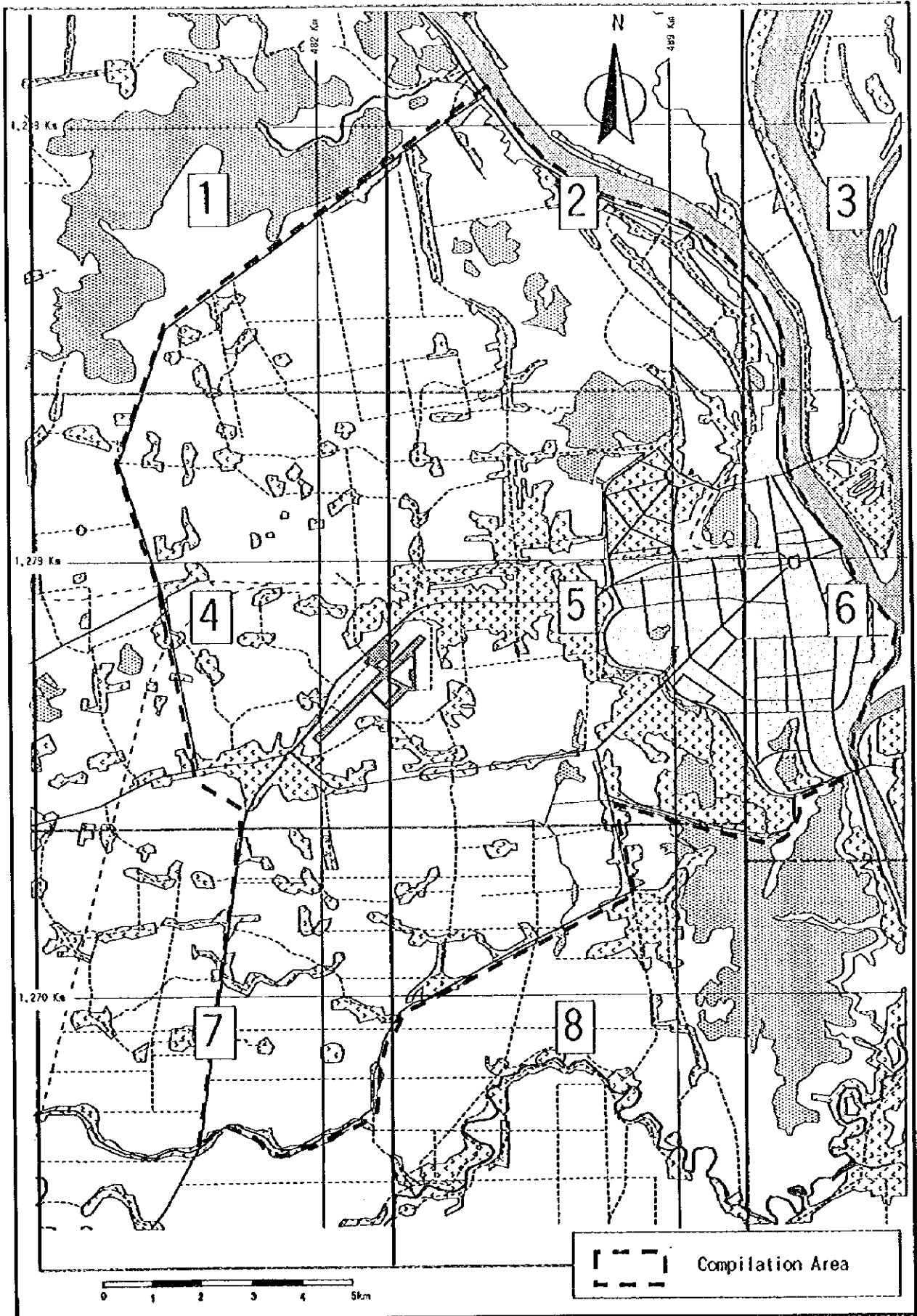

The Study on Drainage Improvement and Flood Control  
 in the Municipality of Phnom Penh  
 JICA - CTIE International Co., Ltd. - Nippon Koei Co., Ltd.

Figure 12-27  
 1/10,000 Compilation Map Sheet Index

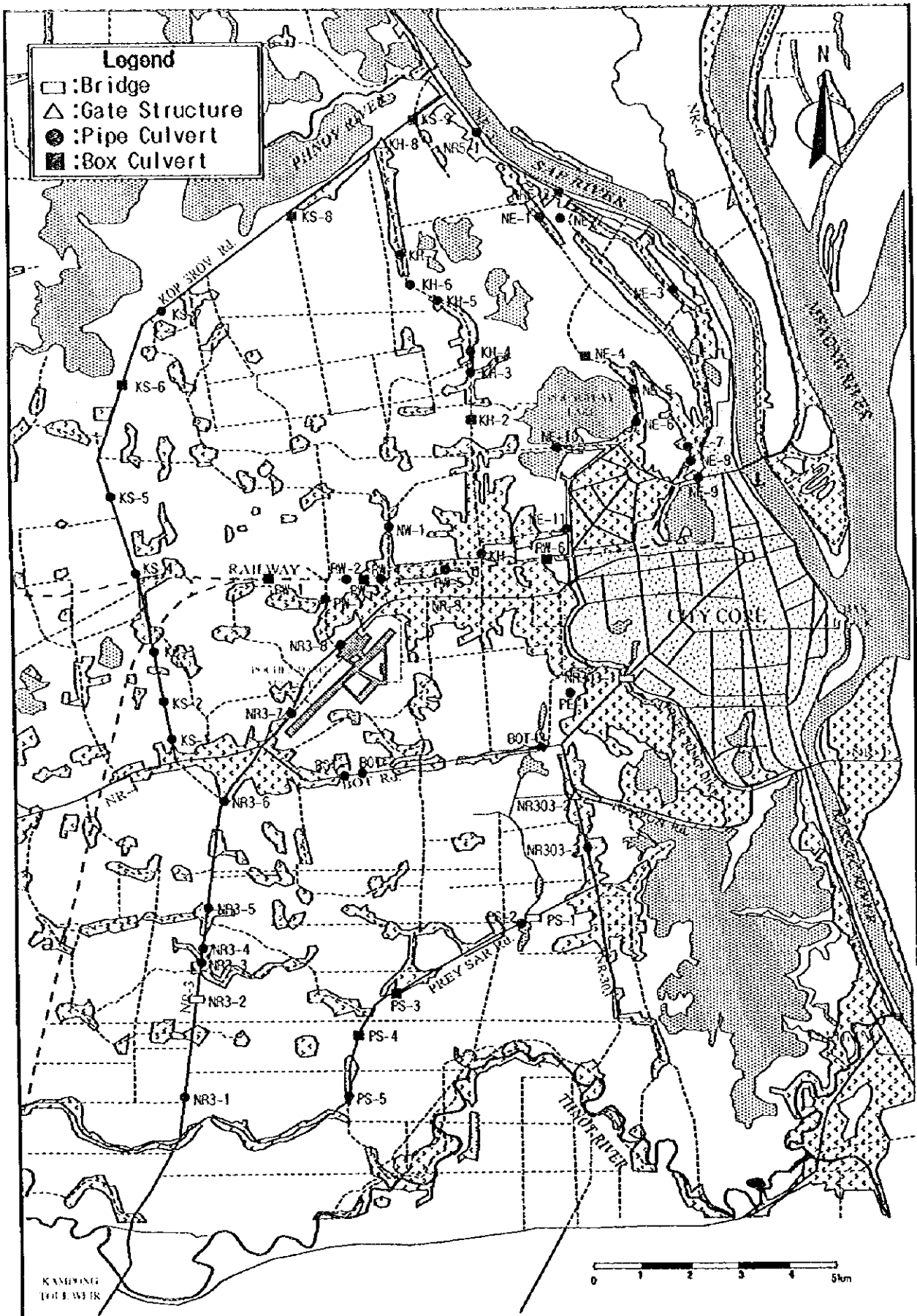

The Study on Drainage Improvement and Flood Control  
 in the Municipality of Phnom Penh  
 JICA - CTIE International Co., Ltd. - Nippon Koei Co., Ltd.

Figure 12-28  
 Ring Dikes, Roads and Crossings

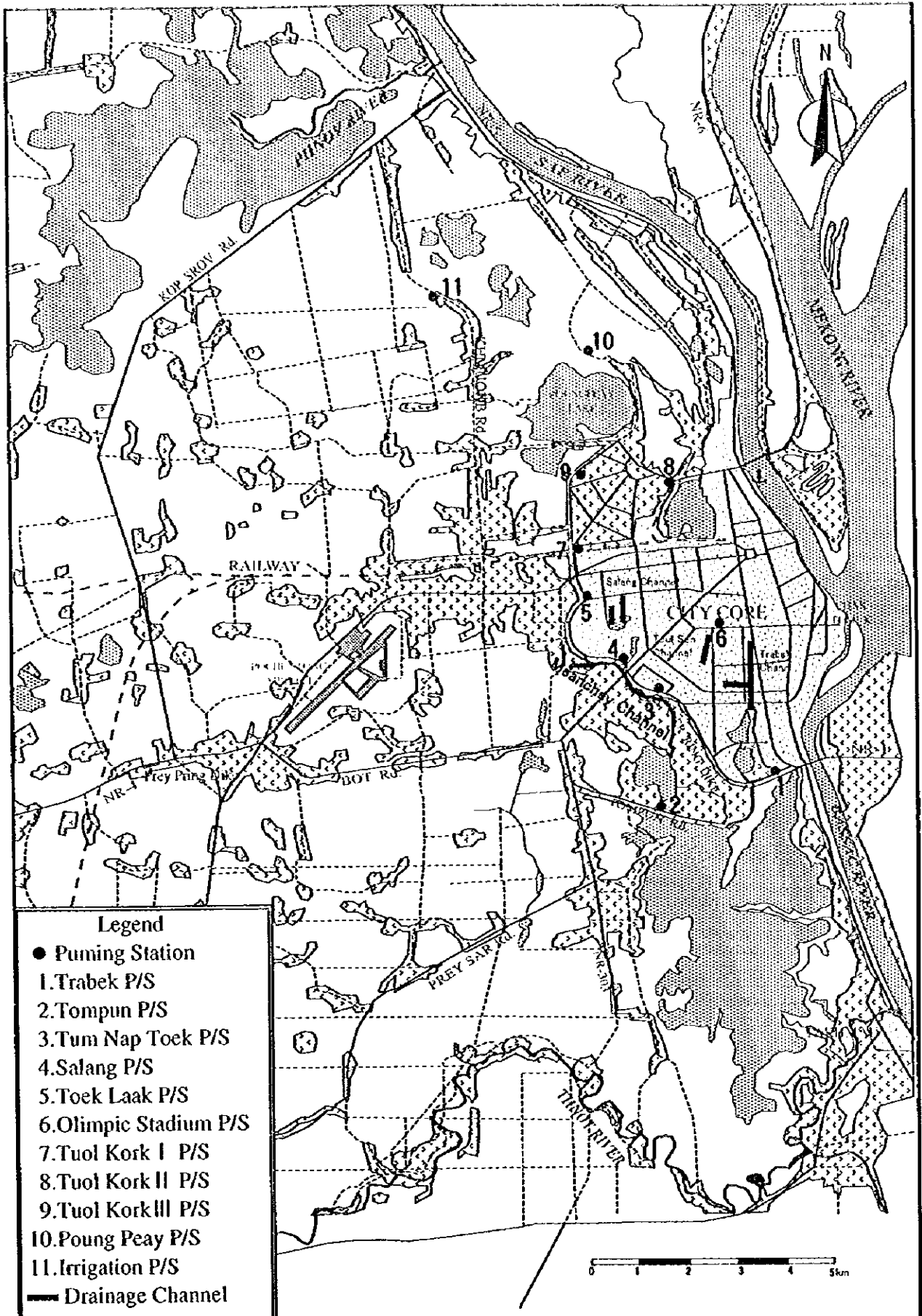

The Study on Drainage Improvement and Flood Control  
 in the Municipality of Phnom Penh  
 JICA - CHIE International Co., Ltd. - Nippon Koei Co., Ltd.

Figure 12-29  
 Pumping Stations and Drainage Channels

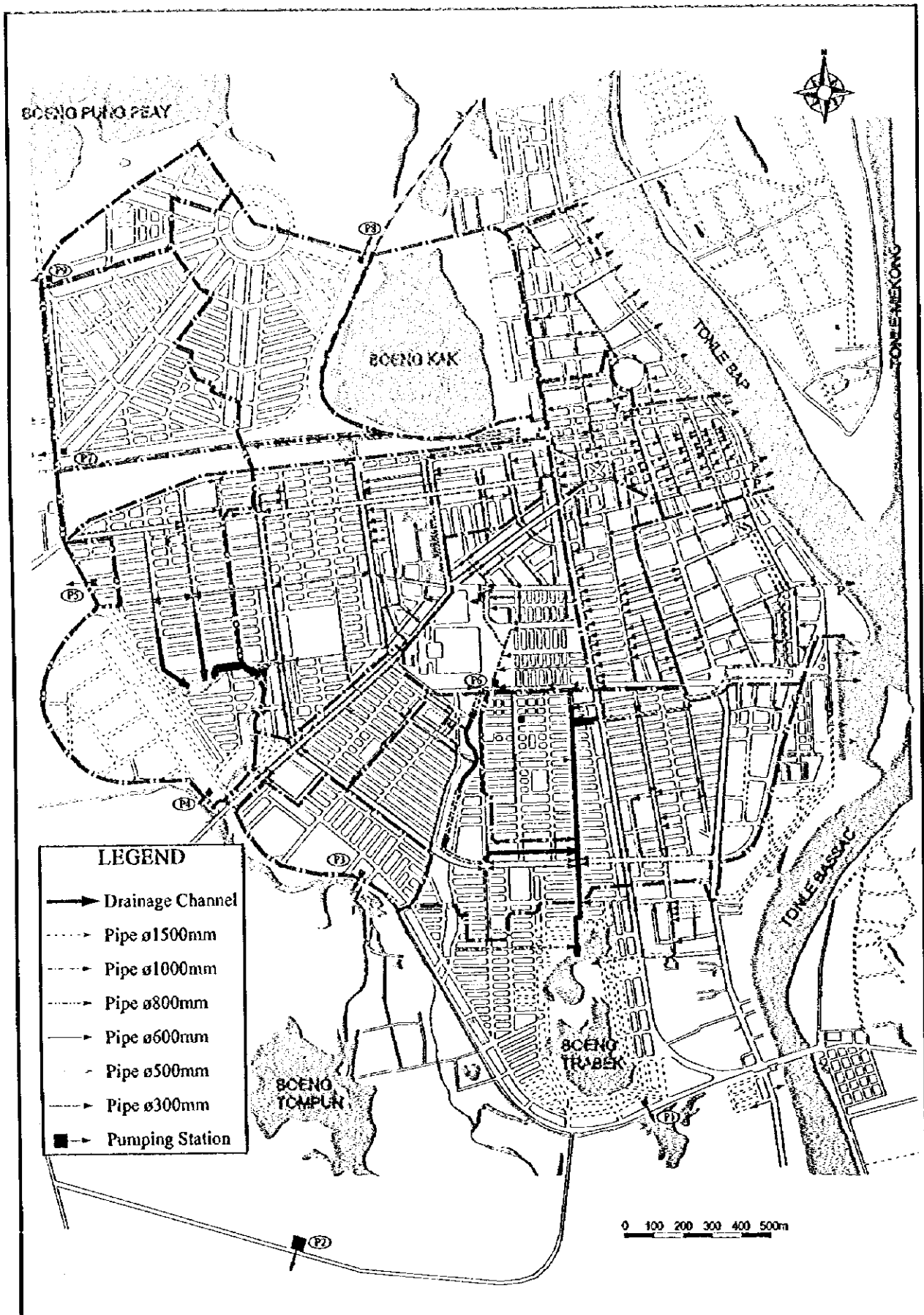

The Study on Drainage Improvement and Flood Control  
 in the Municipality of Phnom Penh  
 JICA - CTIE International Co., Ltd. - Nippon Koei Co., Ltd.

Figure 12-30  
 Existing Sewer Network

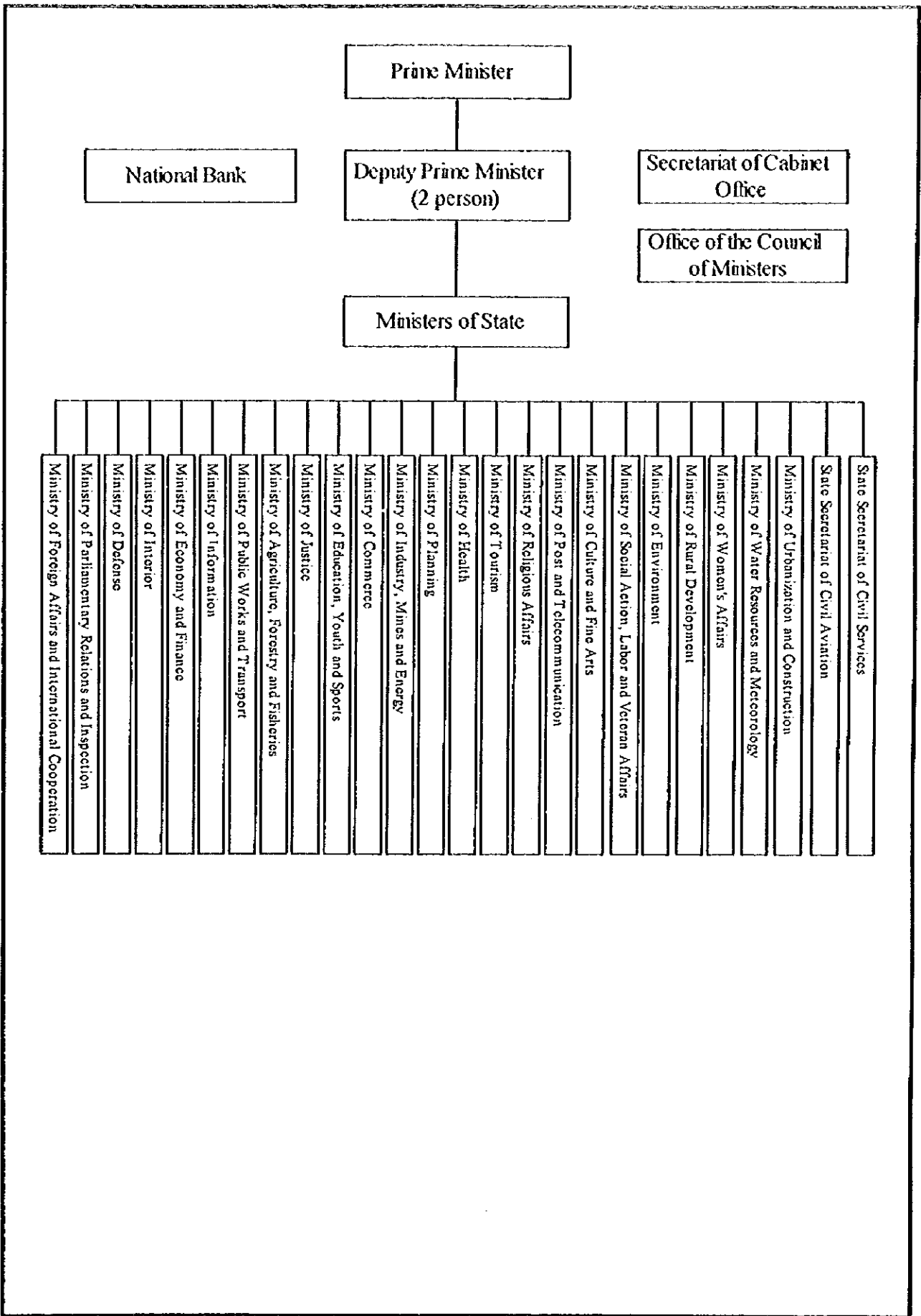

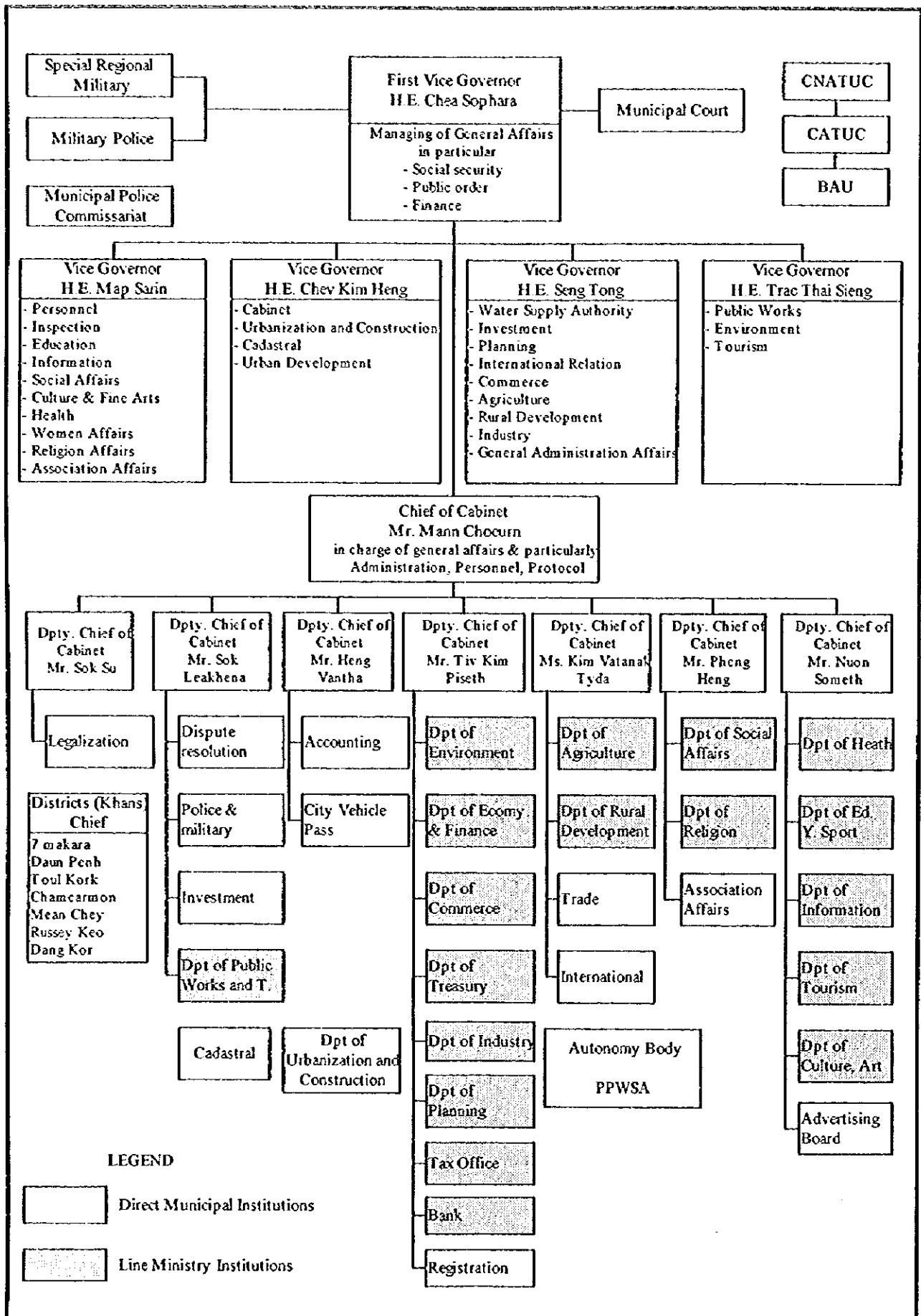



## Organizational Structure of Department of Public Works and Transport

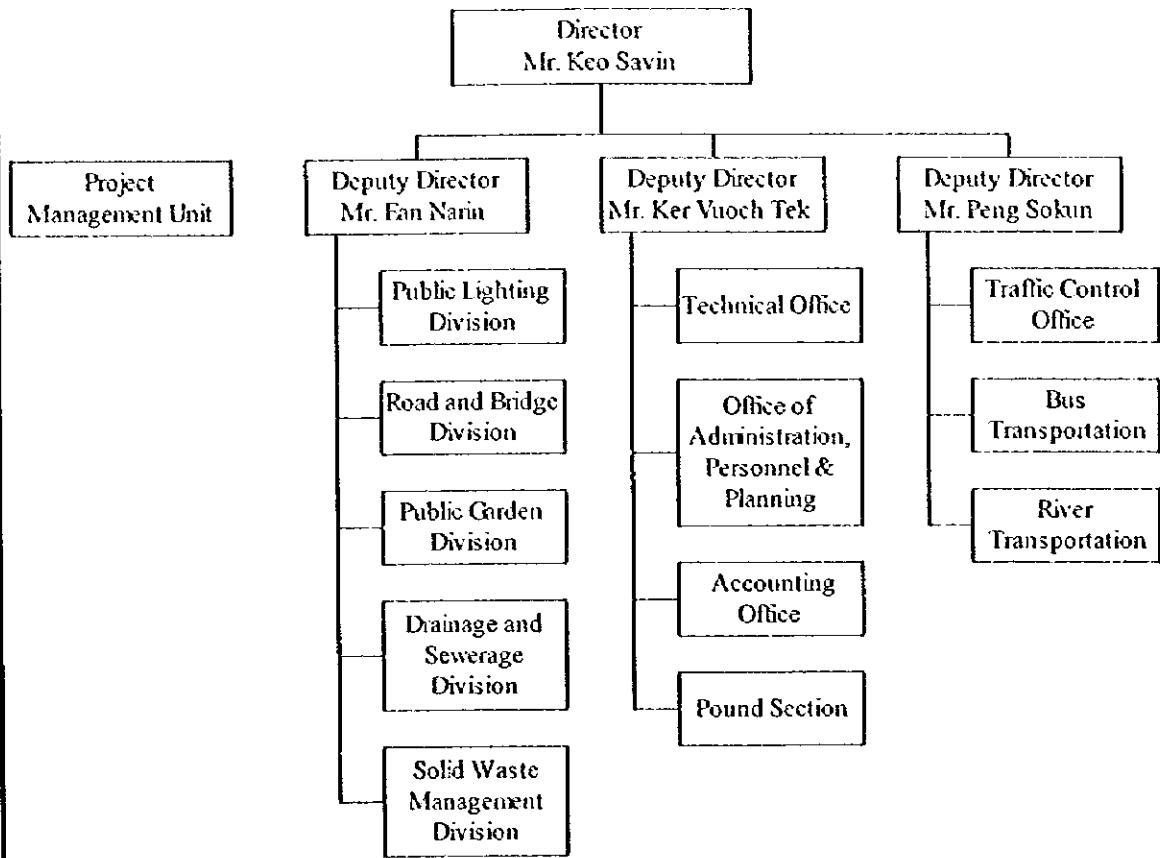

## Organizational Structure of Drainage and Sewage Division

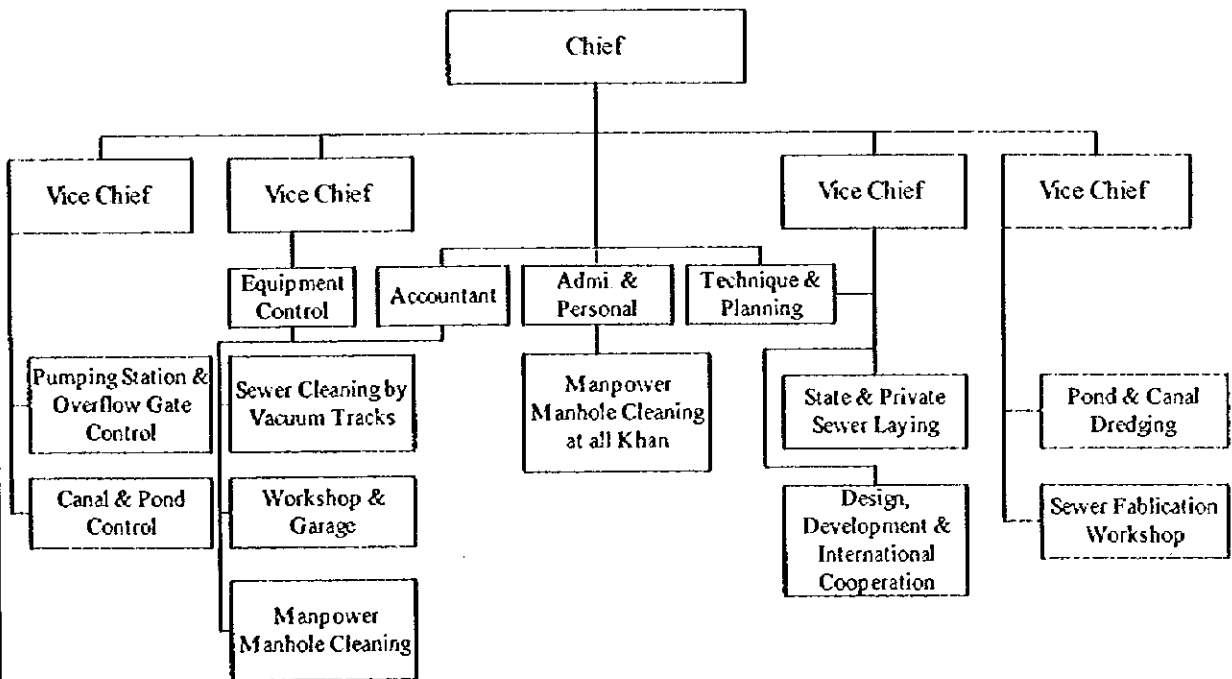

The Study on Drainage Improvement and Flood Control  
in the Municipality of Phnom Penh  
JICA-CTIE International Co., Ltd. -Nippon Koei Co., Ltd.

Figure 12-33  
Organizational Chart of Department of Public Works and  
Transport (DPWT) and Drainage and Sewage Division (DSD)

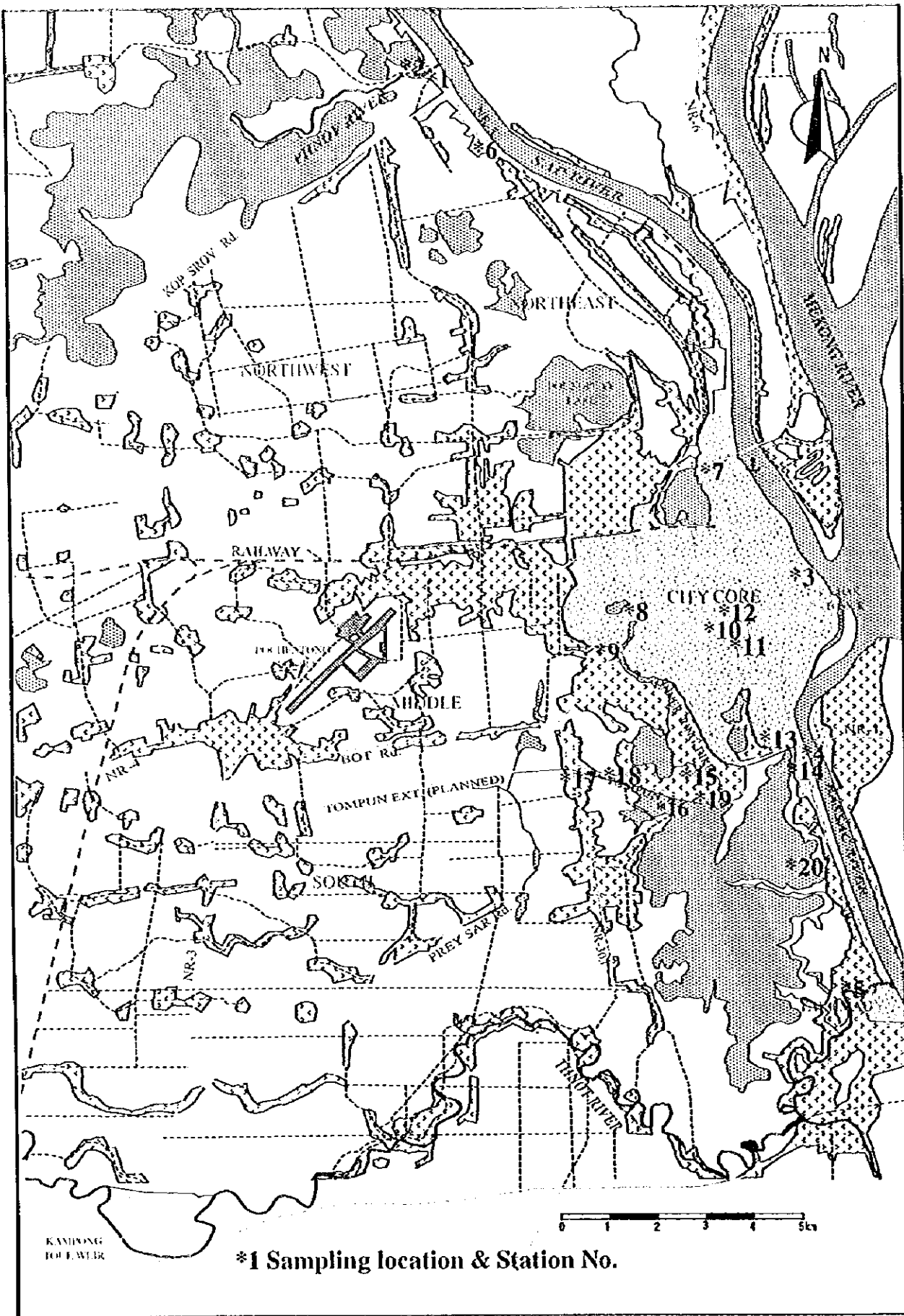

The Study on Drainage Improvement and Flood Control  
 in the Municipality of Phnom Penh  
 JICA-CTIE International Co., Ltd. -Nippon Koei Co., Ltd.

Figure I2-34  
 Location of Water Quality and Benthic Material Quality  
 Sampling

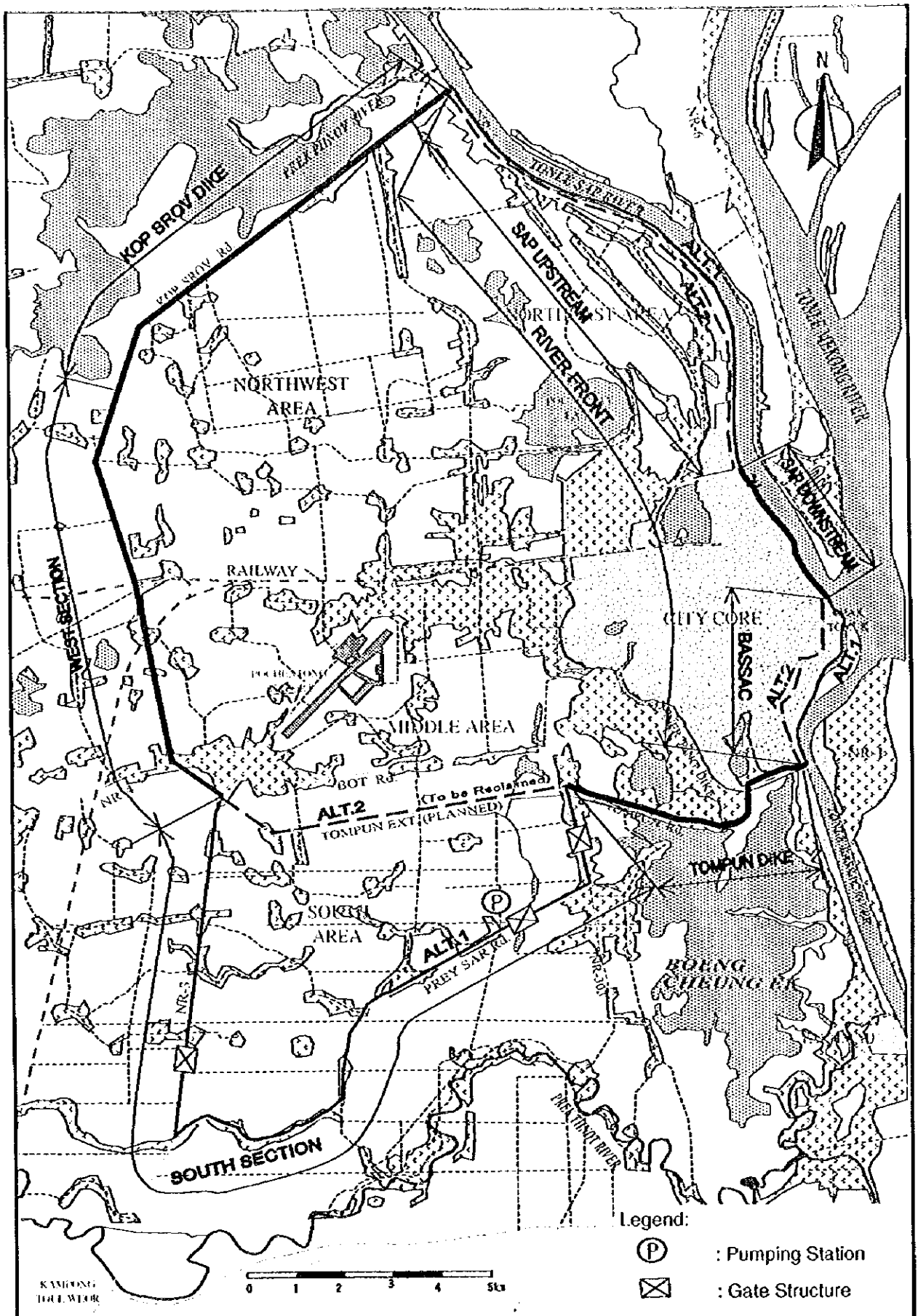

The Study on Drainage Improvement and Flood Control  
 in the Municipality of Phnom Penh  
 JICA - CTIE International Co., Ltd. - Nippon Koei Co., Ltd.

Figure I3-1  
 Protection Line against Flood

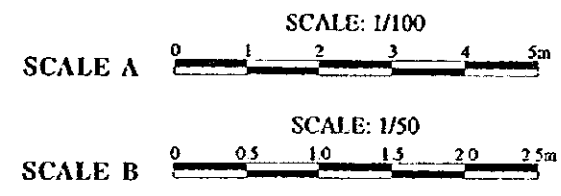
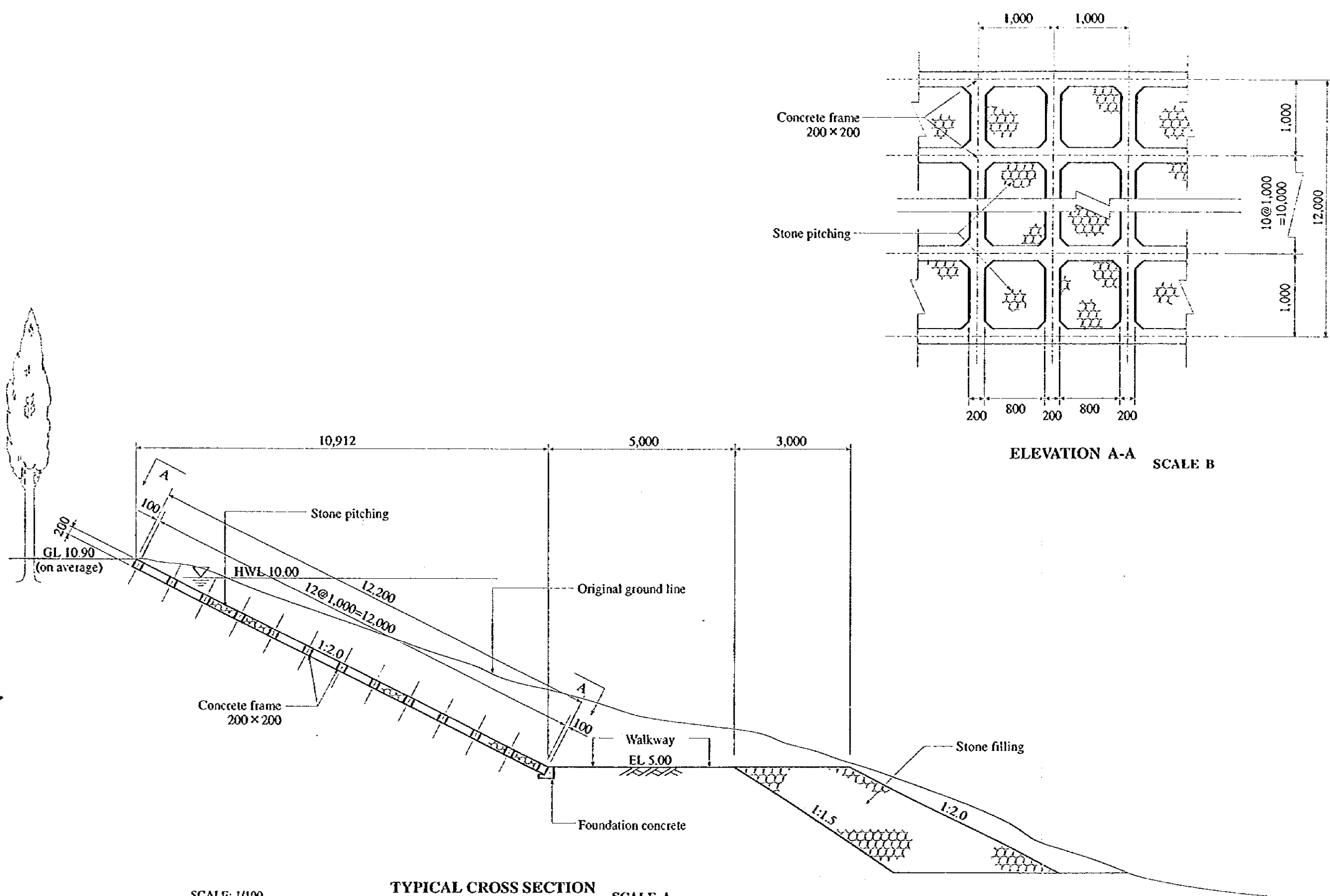
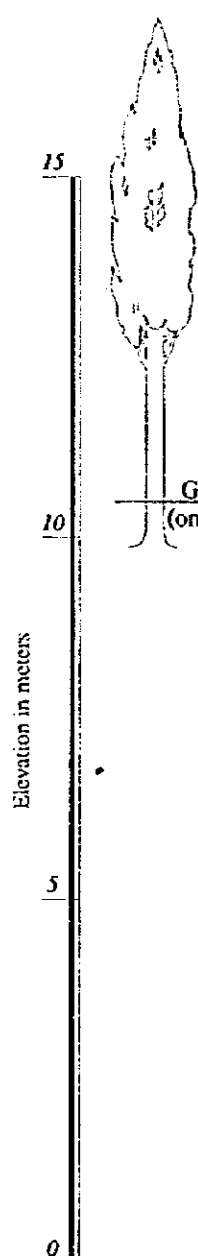

**TYPICAL CROSS SECTION** SCALE A  
**ALTERNATIVE 1 : STONE PITCHING TYPE**

The Study on Drainage Improvement and Flood Control  
 in the Municipality of Phnom Penh  
 JICA - CTIE International Co., Ltd. - Nippon Koei Co., Ltd.

Figure. I3-2  
 Riverfront Protection in Sap Downstream  
 Middle Section (1/2)

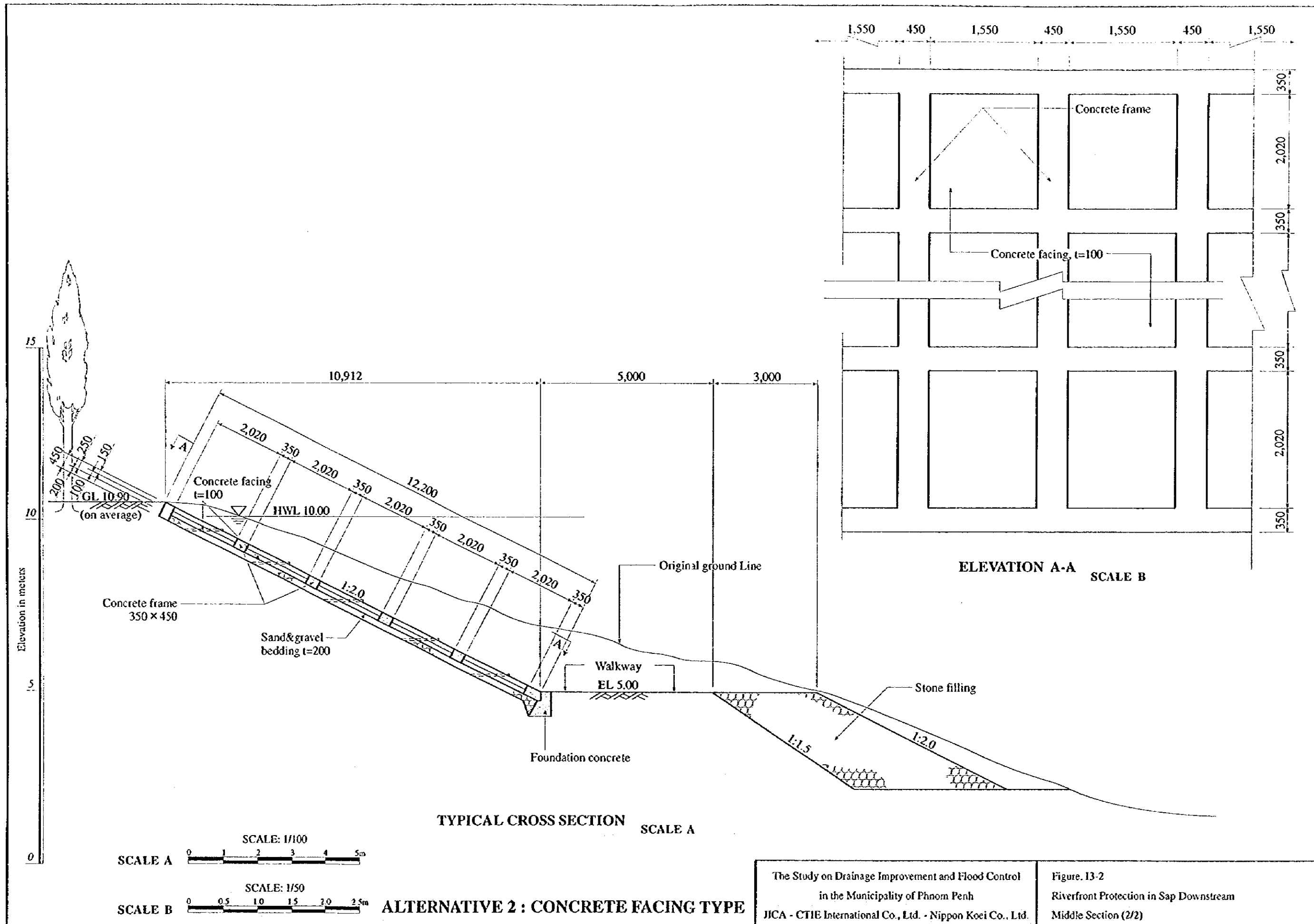

TYPICAL CROSS SECTION SCALE A

ELEVATION A-A SCALE B

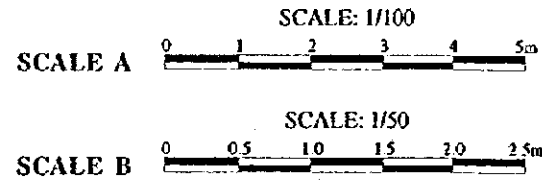

ALTERNATIVE 2 : CONCRETE FACING TYPE

The Study on Drainage Improvement and Flood Control  
 in the Municipality of Phnom Penh  
 JICA - CTIE International Co., Ltd. - Nippon Koei Co., Ltd.

Figure. 13-2  
 Riverfront Protection in Sap Downstream  
 Middle Section (2/2)

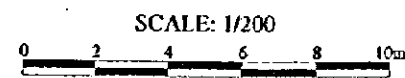
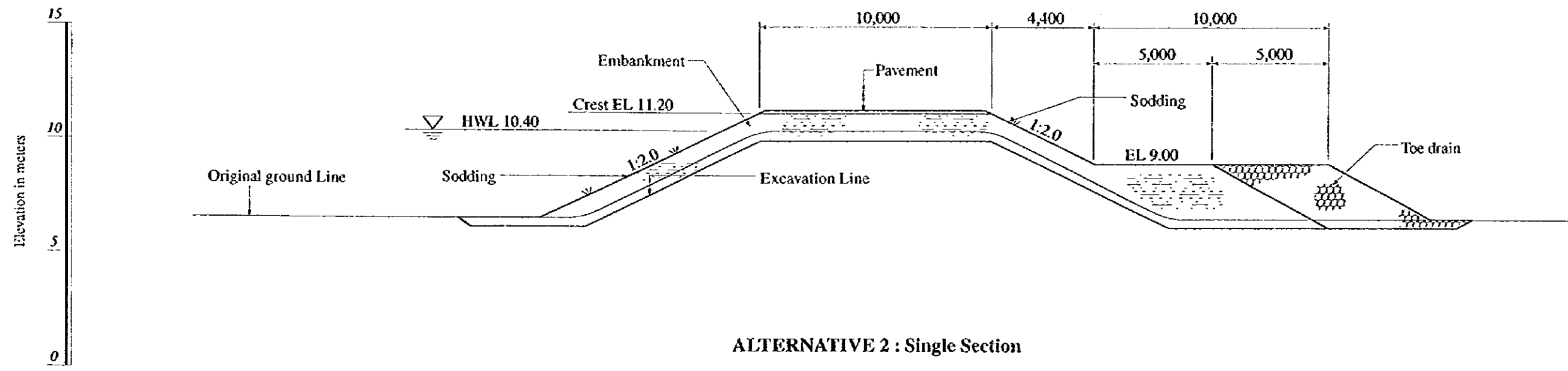
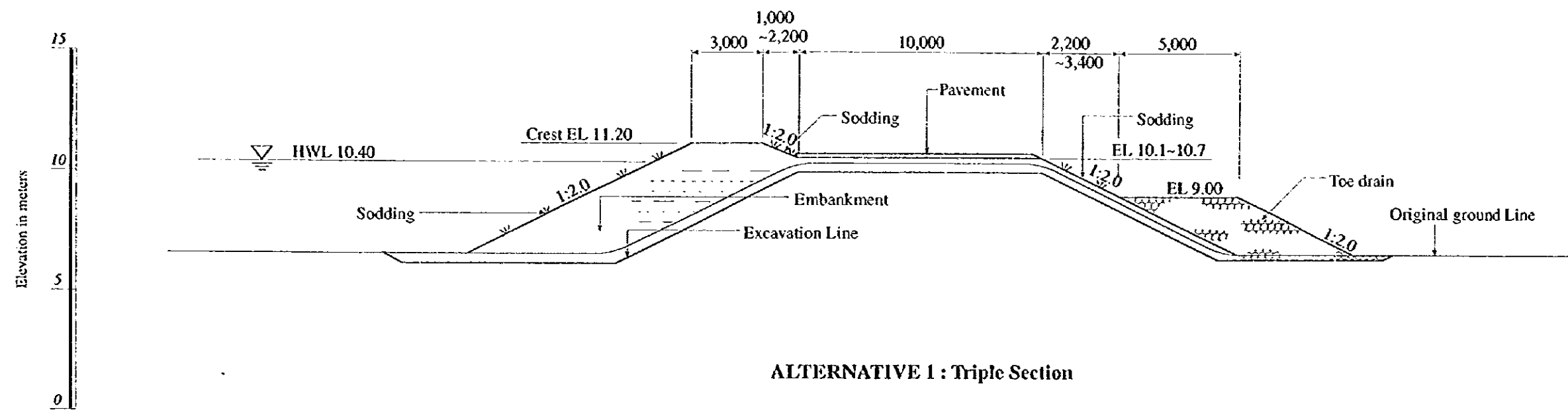

The Study on Drainage Improvement and Flood Control  
 in the Municipality of Phnom Penh  
 JICA - CHIE International Co., Ltd. - Nippon Koei Co., Ltd.

Figure. 13-3  
 Reinforcement of Kop Srov Dike



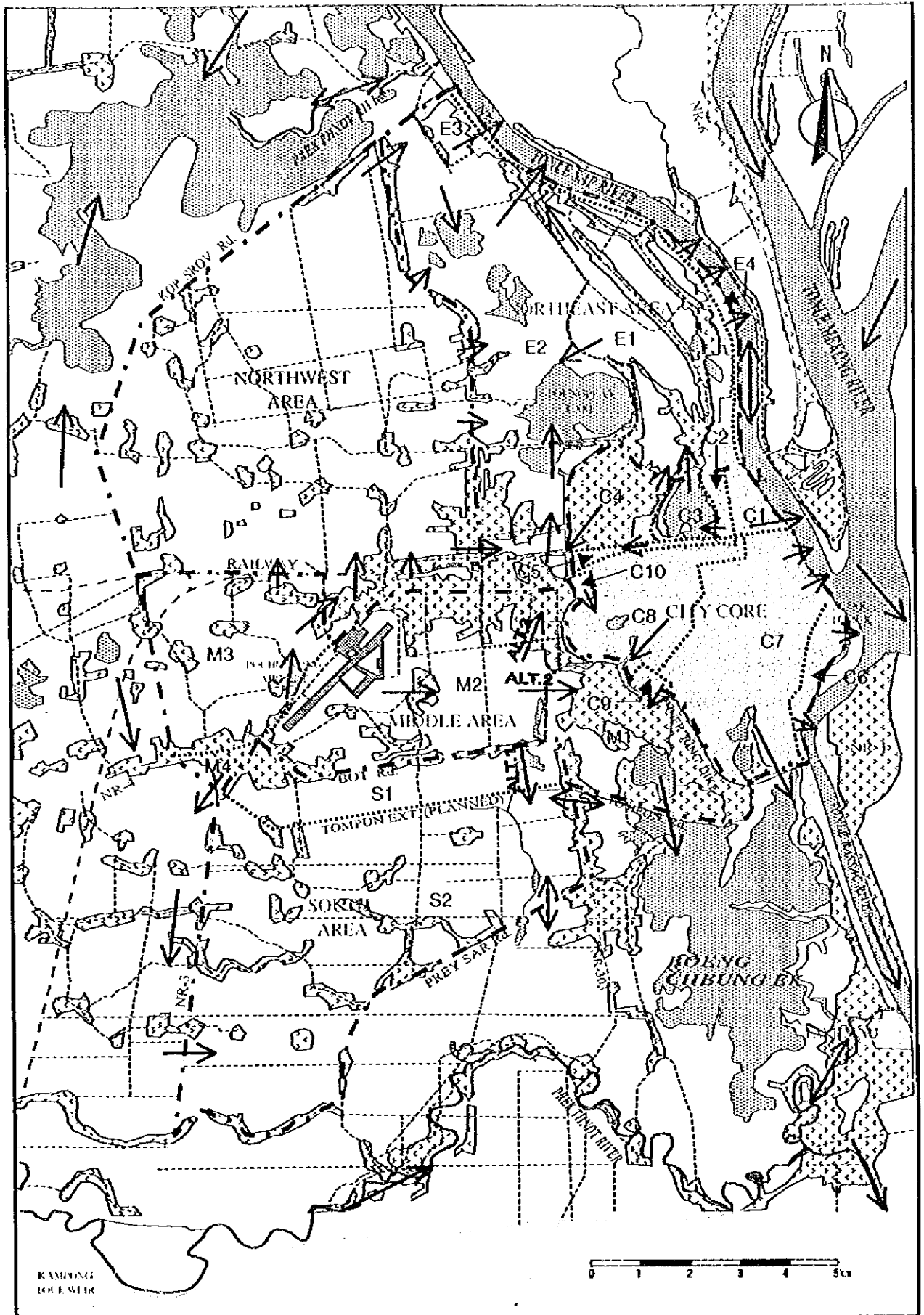

The Study on Drainage Improvement and Flood Control  
 in the Municipality of Phnom Penh  
 JICA - CTIE International Co., Ltd. - Nippon Koei Co., Ltd.

Figure B-4  
 Drainage Direction of Each Basin



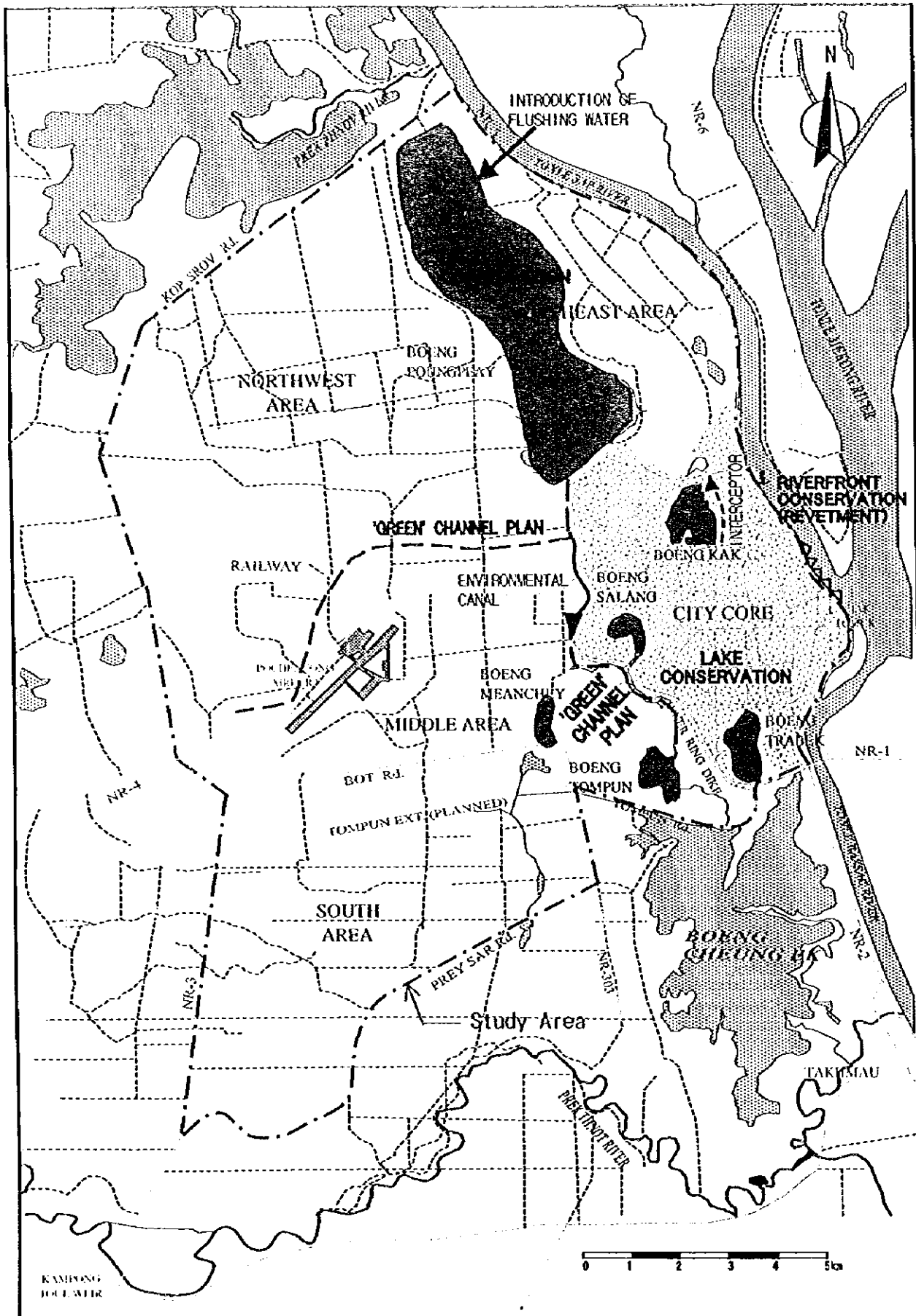

The Study on Drainage Improvement and Flood Control  
 in the Municipality of Phnom Penh  
 JICA - CTIB International Co., Ltd. - Nippon Koei Co., Ltd.

Figure 13-5  
 Environmental Enhancement

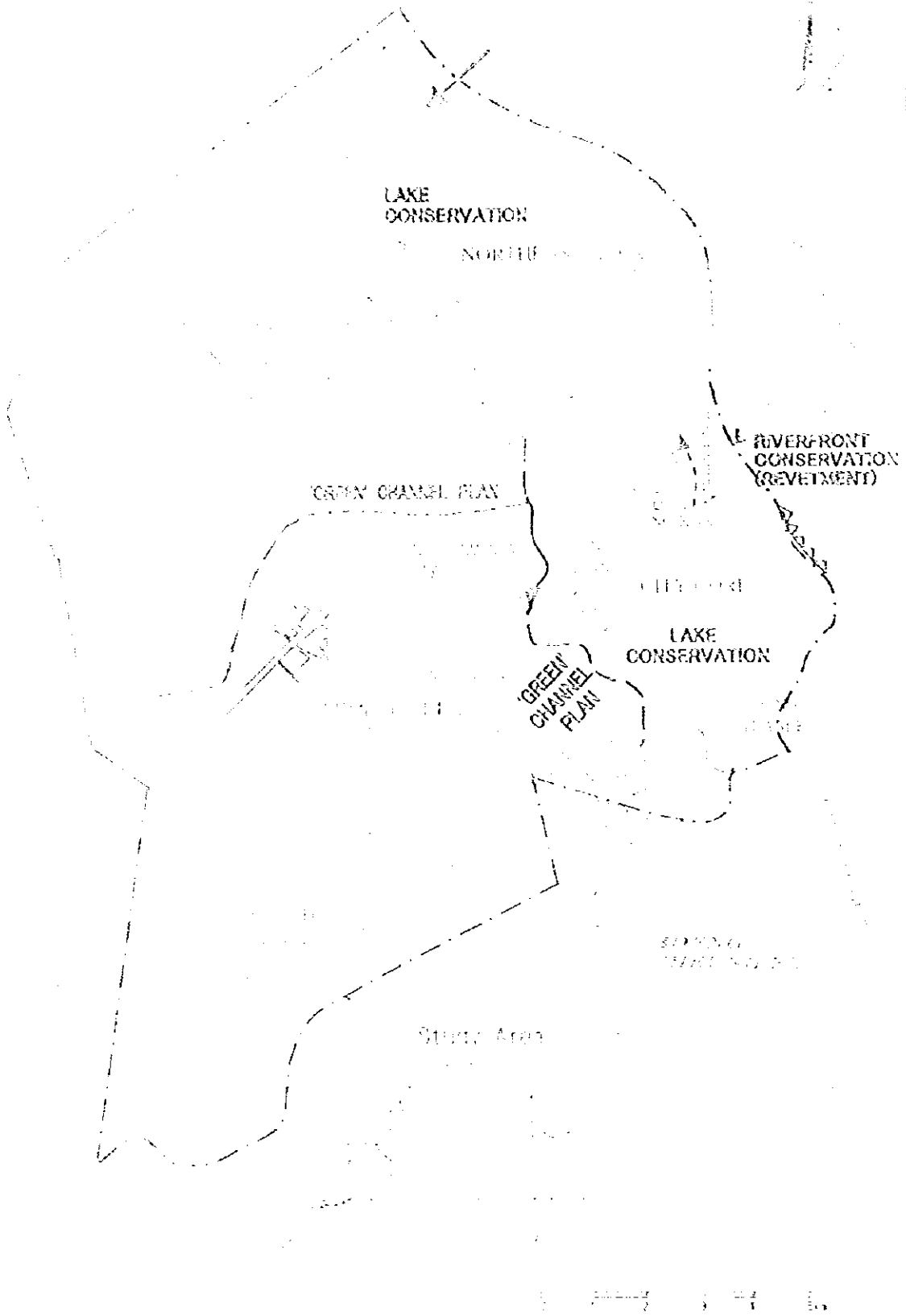

City of...  
 Municipal...  
 North...

Figure 1.5  
 Environmental Enhancement

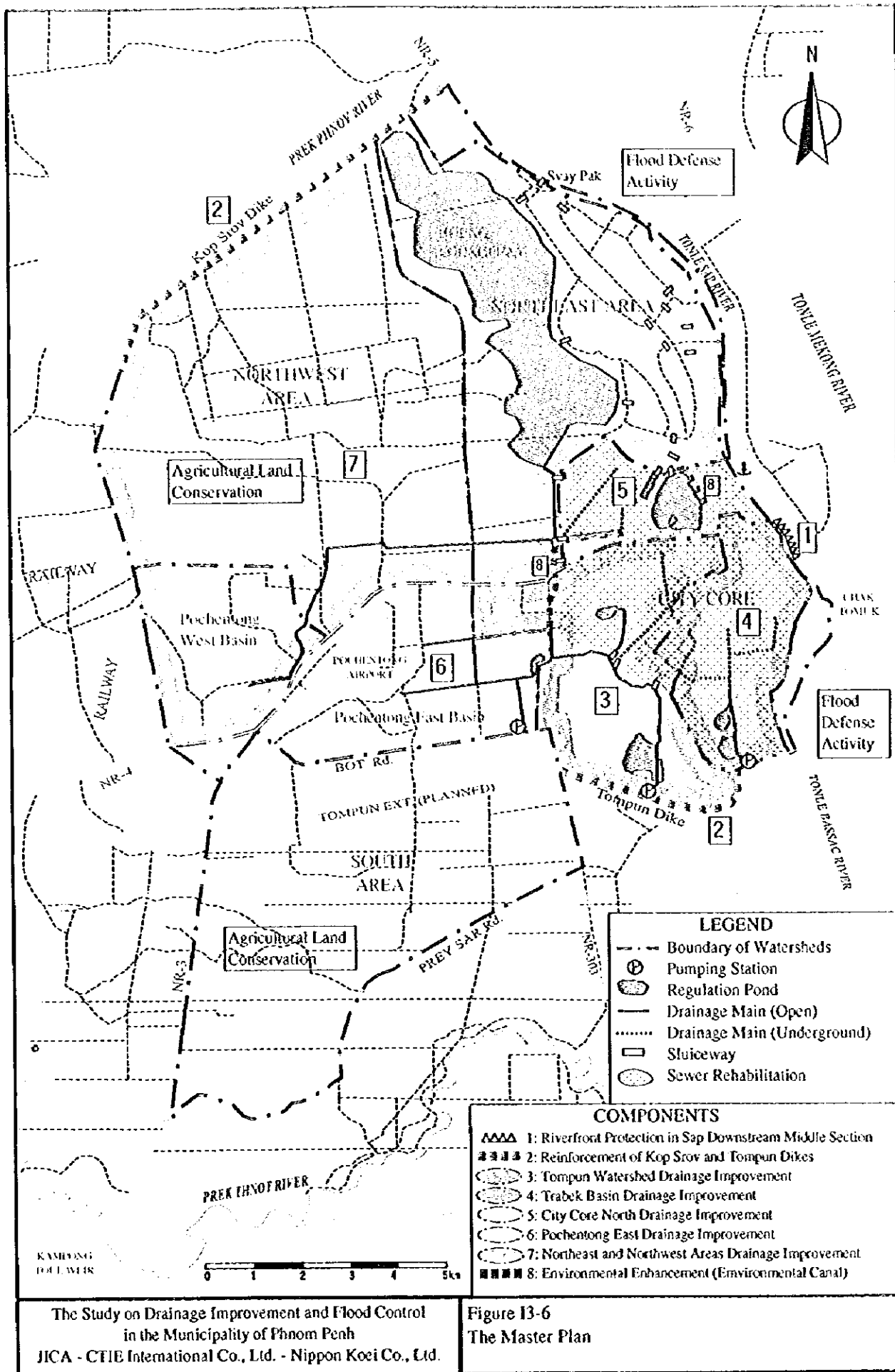

The Study on Drainage Improvement and Flood Control  
in the Municipality of Phnom Penh  
JICA - CTIE International Co., Ltd. - Nippon Koei Co., Ltd.

Figure 13-6  
The Master Plan

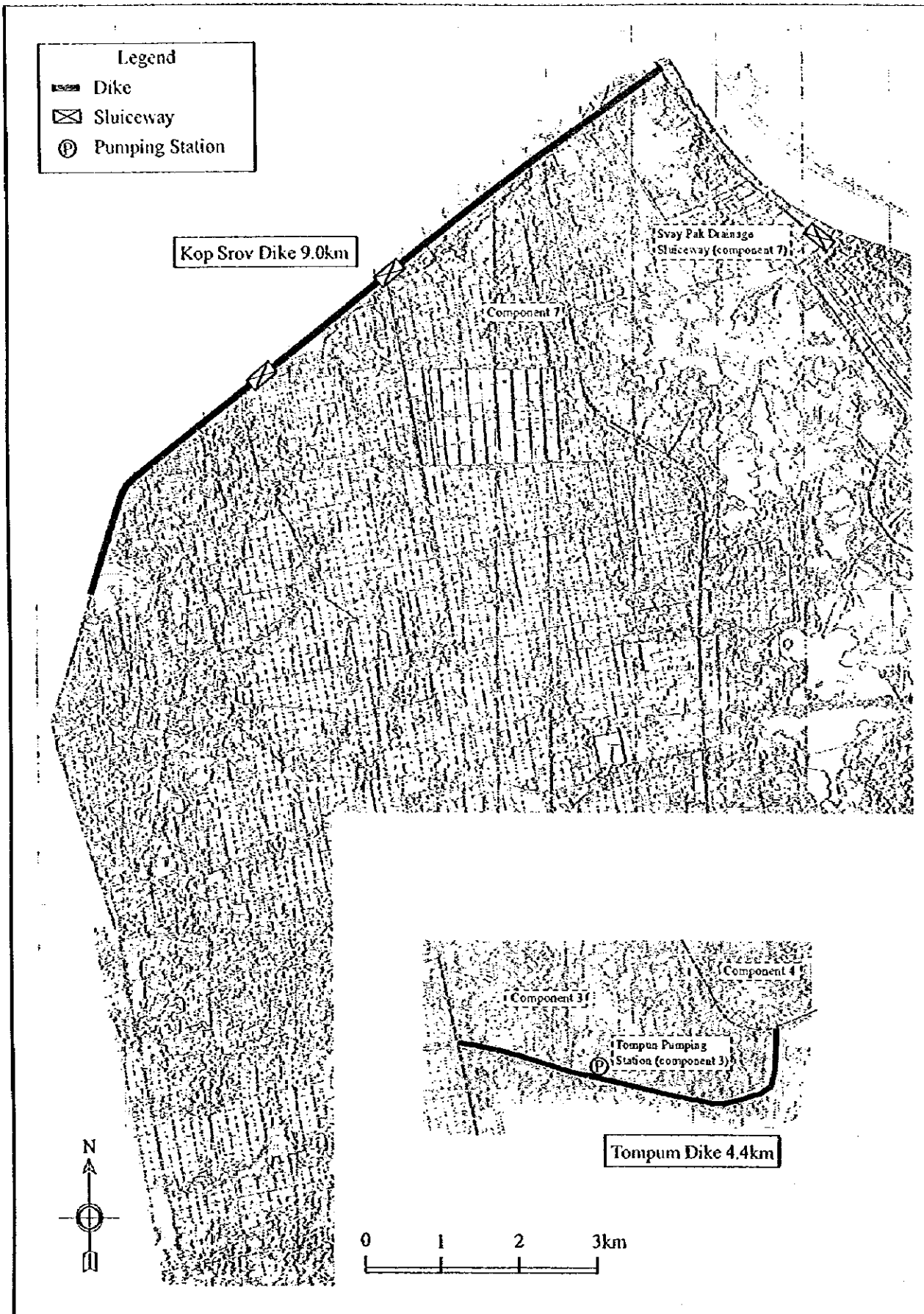

The Study on Drainage Improvement and Flood Control  
 in the Municipality of Phnom Penh  
 JICA - CHE International Co., Ltd. - Nippon Koei Co., Ltd.

Figure 13-7  
 Facility Layout for Component 2: Reinforcement of  
 Kop Srov and Tompum Dikes

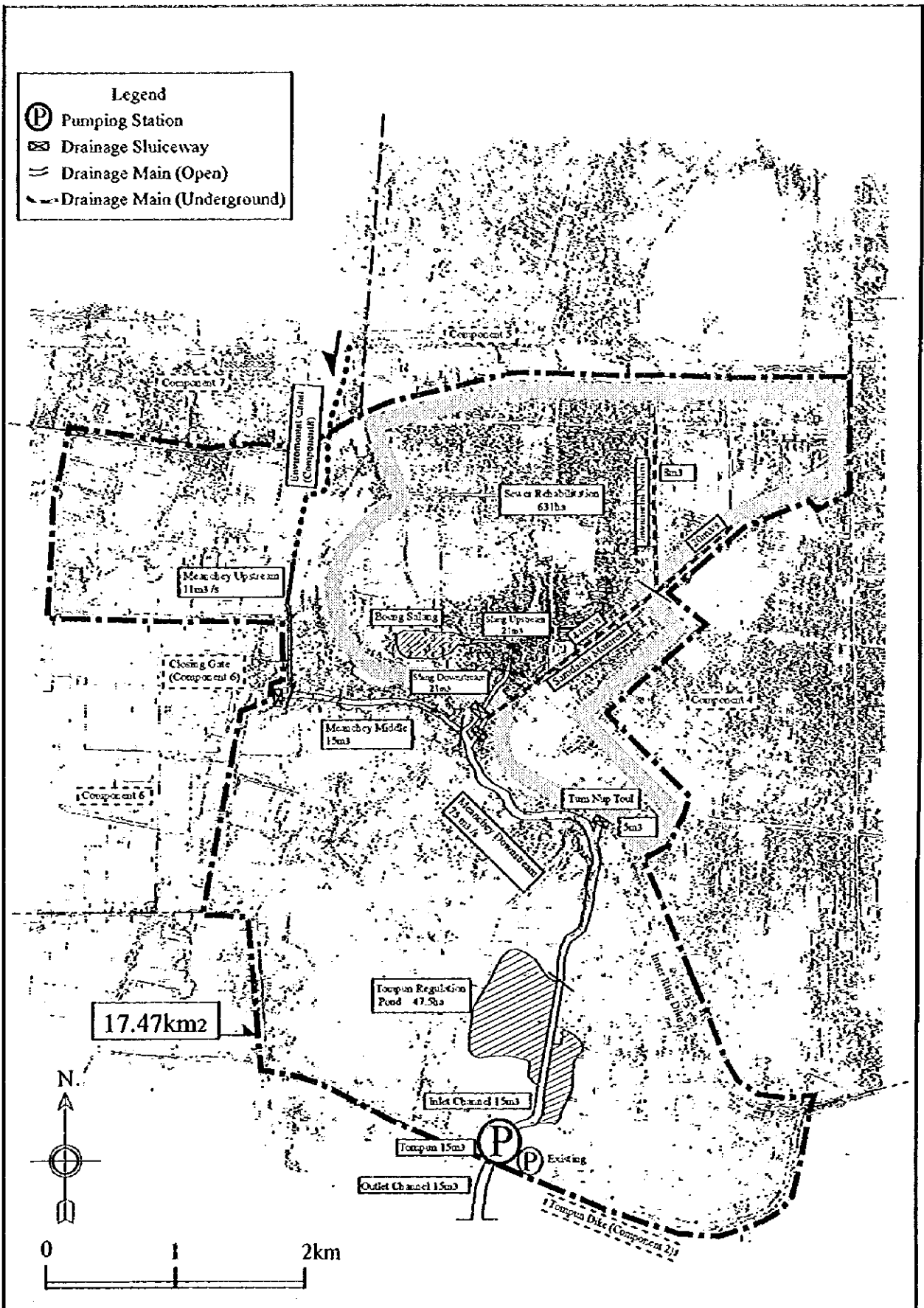

The Study on Drainage Improvement and Flood Control  
 in the Municipality of Phnom Penh  
 JICA - CTIE International Co., Ltd. - Nippon Koei Co., Ltd.

Figure 13-8  
 Facility Layout for Component 3: Tompun  
 Watershed Drainage Improvement

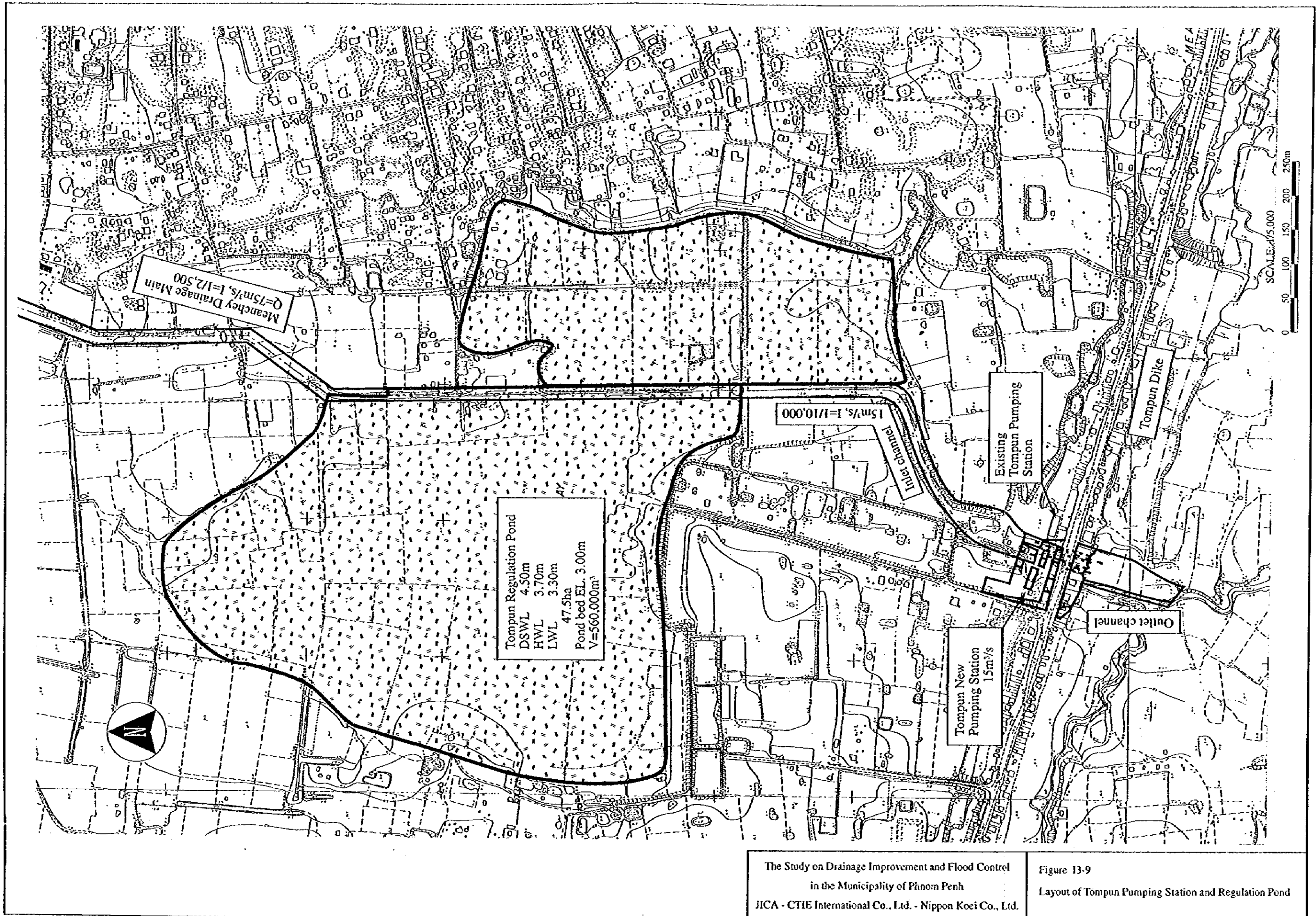



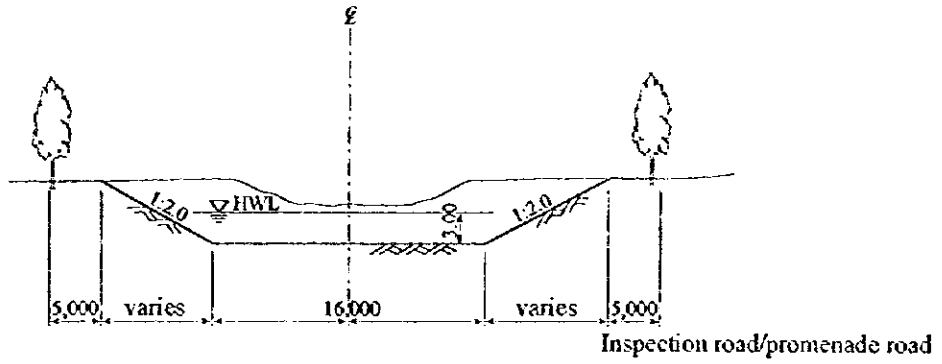

Sta. 30 ~ Sta. 60

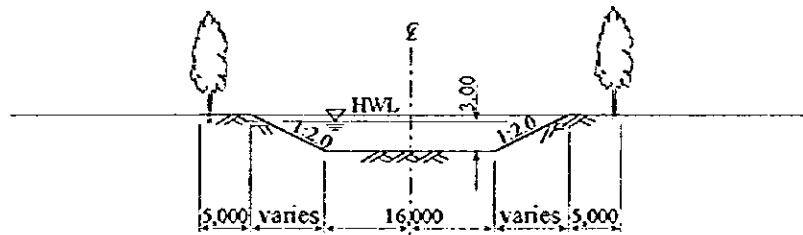

Sta. 120 ~ Sta. 275

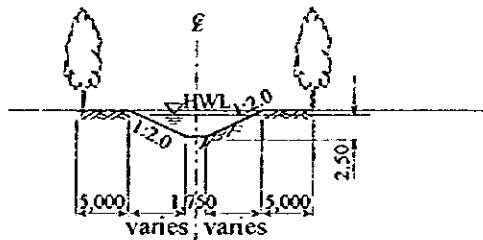

Sta. 275+10.0 ~ Sta. 395+5.0

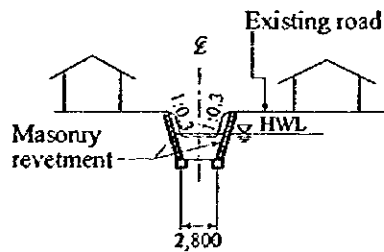

Sta. 395+5.0 ~ Sta. 420



The Study on Drainage Improvement and Flood Control  
in the Municipality of Phnom Penh  
JICA - CTIE International Co., Ltd. - Nippon Koei Co., Ltd.

Figure I3-10  
Standard Cross-sections of Meanchey Drainage Main



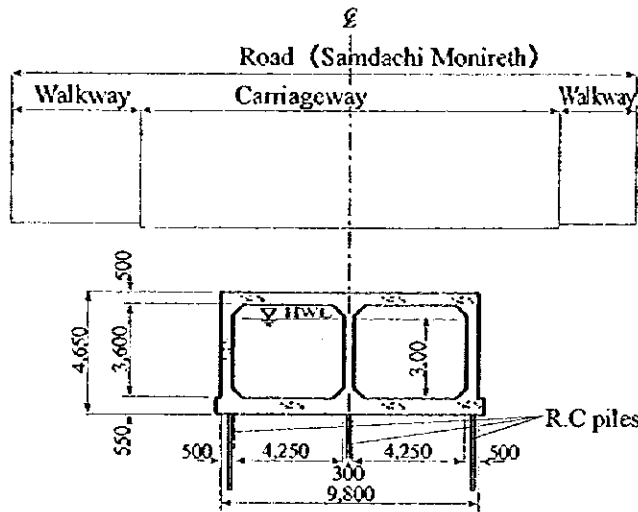

Sandachi Monireth-1&2(Sta.0 ~ Sta.145+15.0)

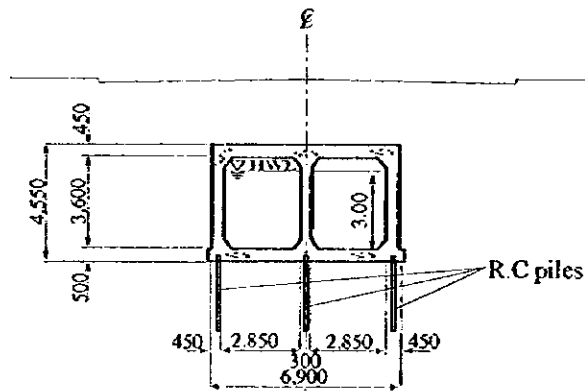

Sandachi Monireth-3(Sta.145+15.0 ~ Sta.210+40.0)

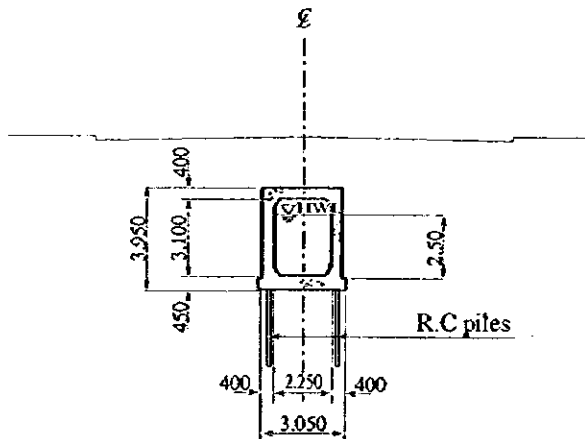

Jawaharlal Nehru Drainage Main



The Study on Drainage Improvement and Flood Control  
in the Municipality of Phnom Penh  
JICA - CTIE International Co., Ltd. - Nippon Koei Co., Ltd.

Figure I3-11  
Standard Cross-sections of Sandachi Monireth and  
Jawaharlal Nehru Drainage Mains

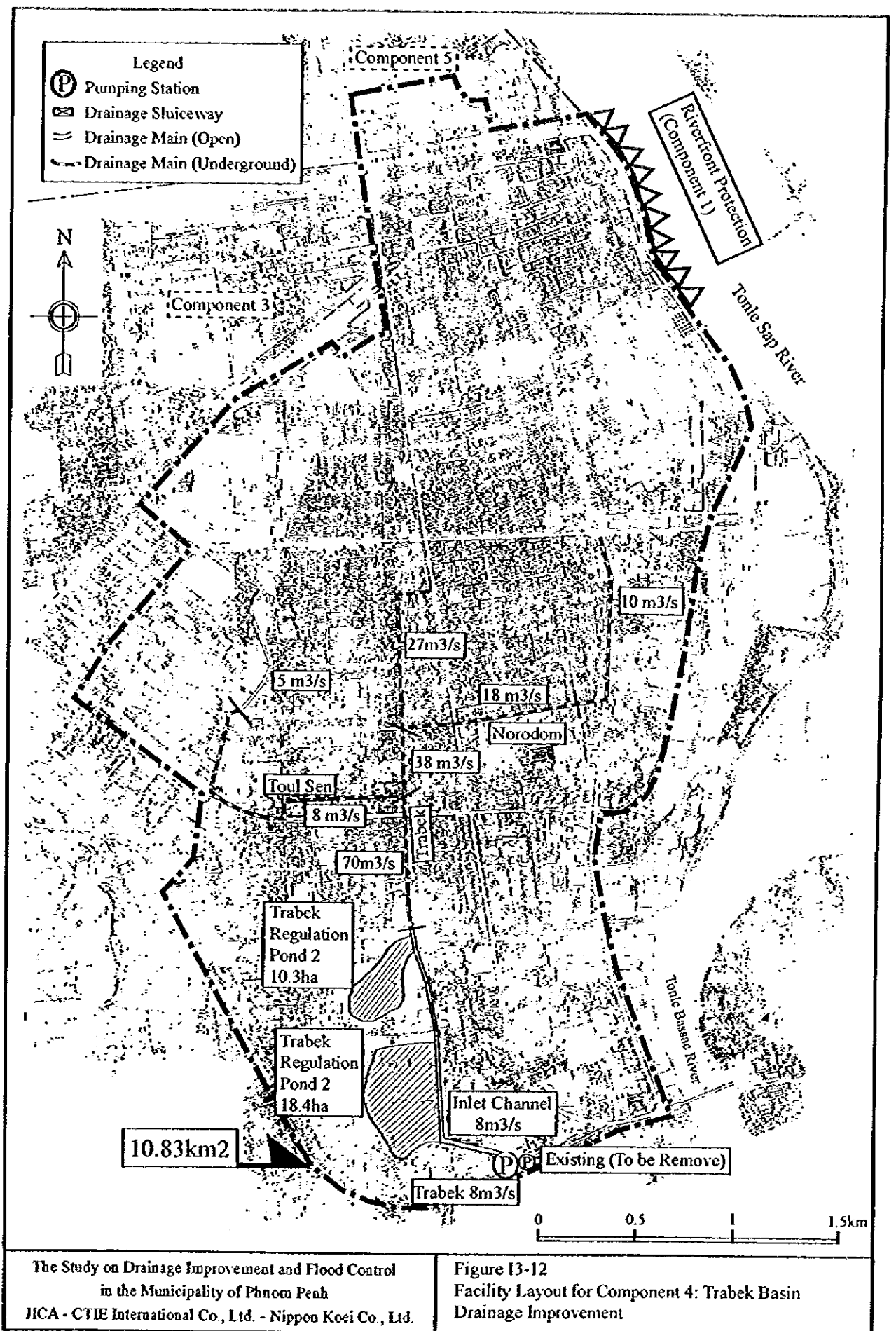

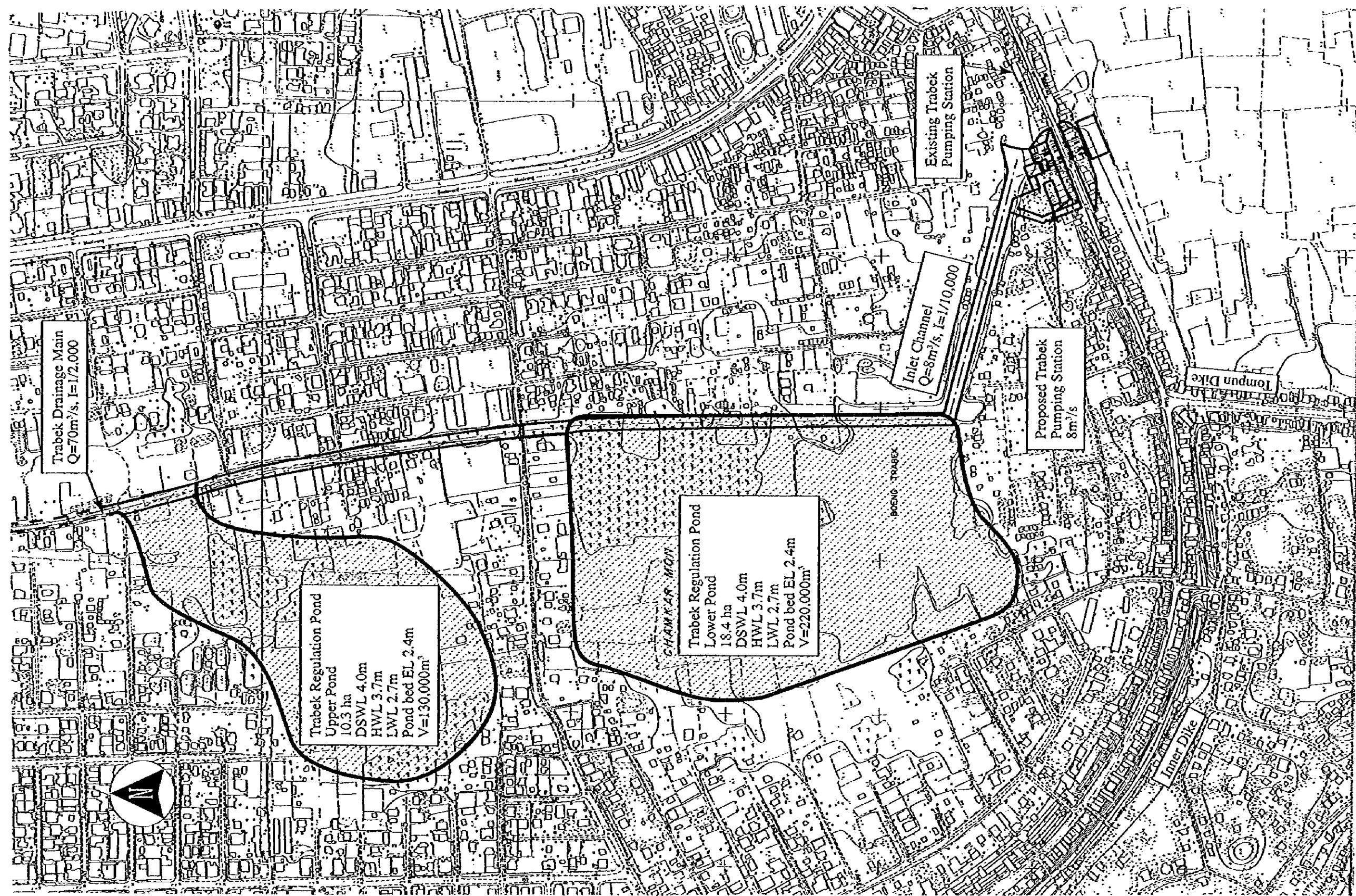

The Study on Drainage Improvement and Flood Control  
 in the Municipality of Phnom Penh  
 JICA - CTIE International Co., Ltd. - Nippon Koei Co., Ltd.

Figure 13-13  
 Layout of Trabek Pumping Station and Regulation Pond



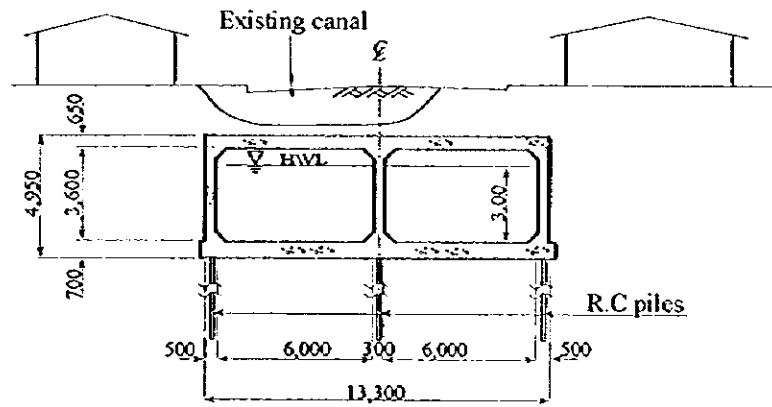

Trabek-1 Sta.0 ~ Sta.65+20.0

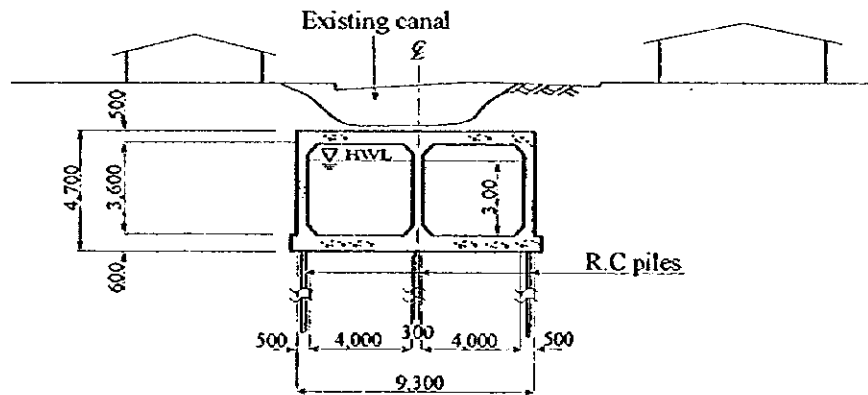

Trabek-2 Sta.65+20.0 ~ Sta.100+11.0

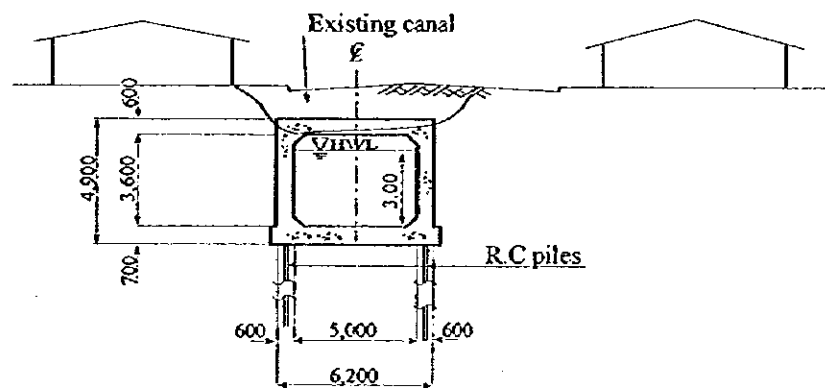

Trabek-3 Sta.100+11.0 ~ Sta.160+4.0



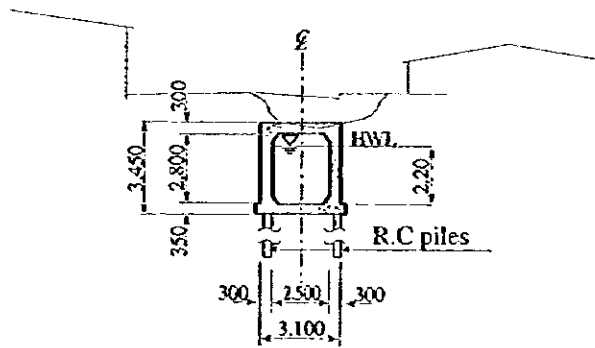

Toul Sen-1 Sta.0 ~ Sta.60

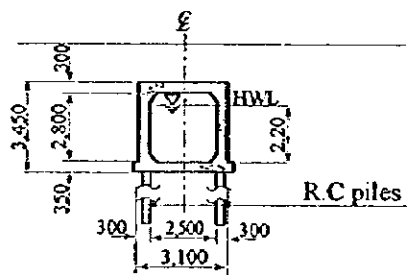

Toul Sen-2 Sta.60 ~ Sta.145+40

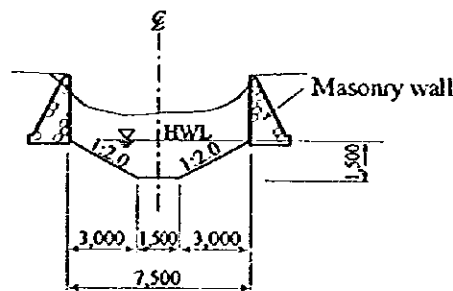

Toul Sen-3 Sta.145+40.0 ~ Sta.205



The Study on Drainage Improvement and Flood Control  
in the Municipality of Phnom Penh  
JICA - CTIE International Co., Ltd. - Nippon Koei Co., Ltd.

Figure 13-15  
Standard Cross-sections of Toul Sen Drainage Main

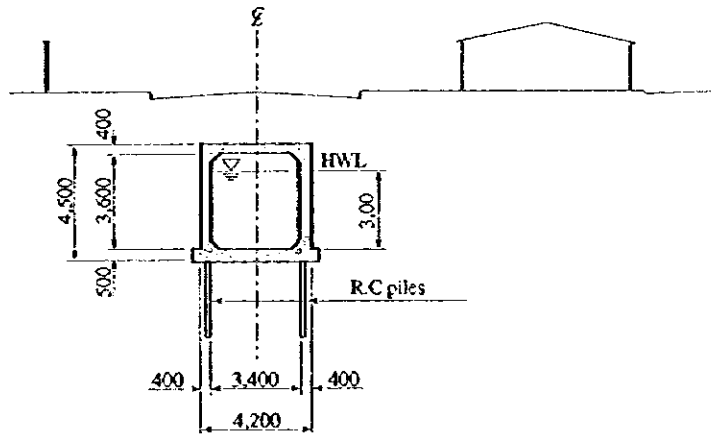

Norodom-1 Sta.0~Sta.85+3.0

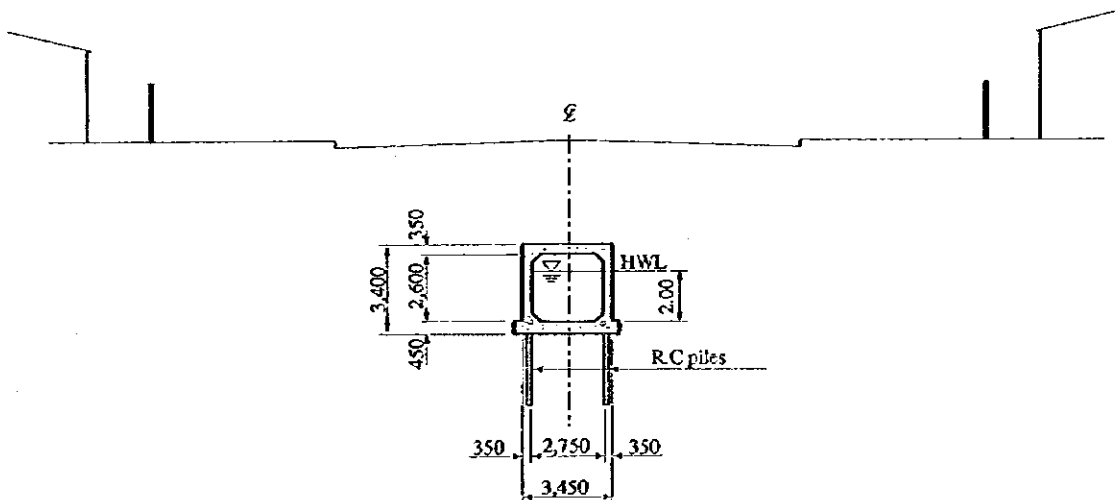

Norodom-2 Sta.85+3.0~Sta.175+18.0



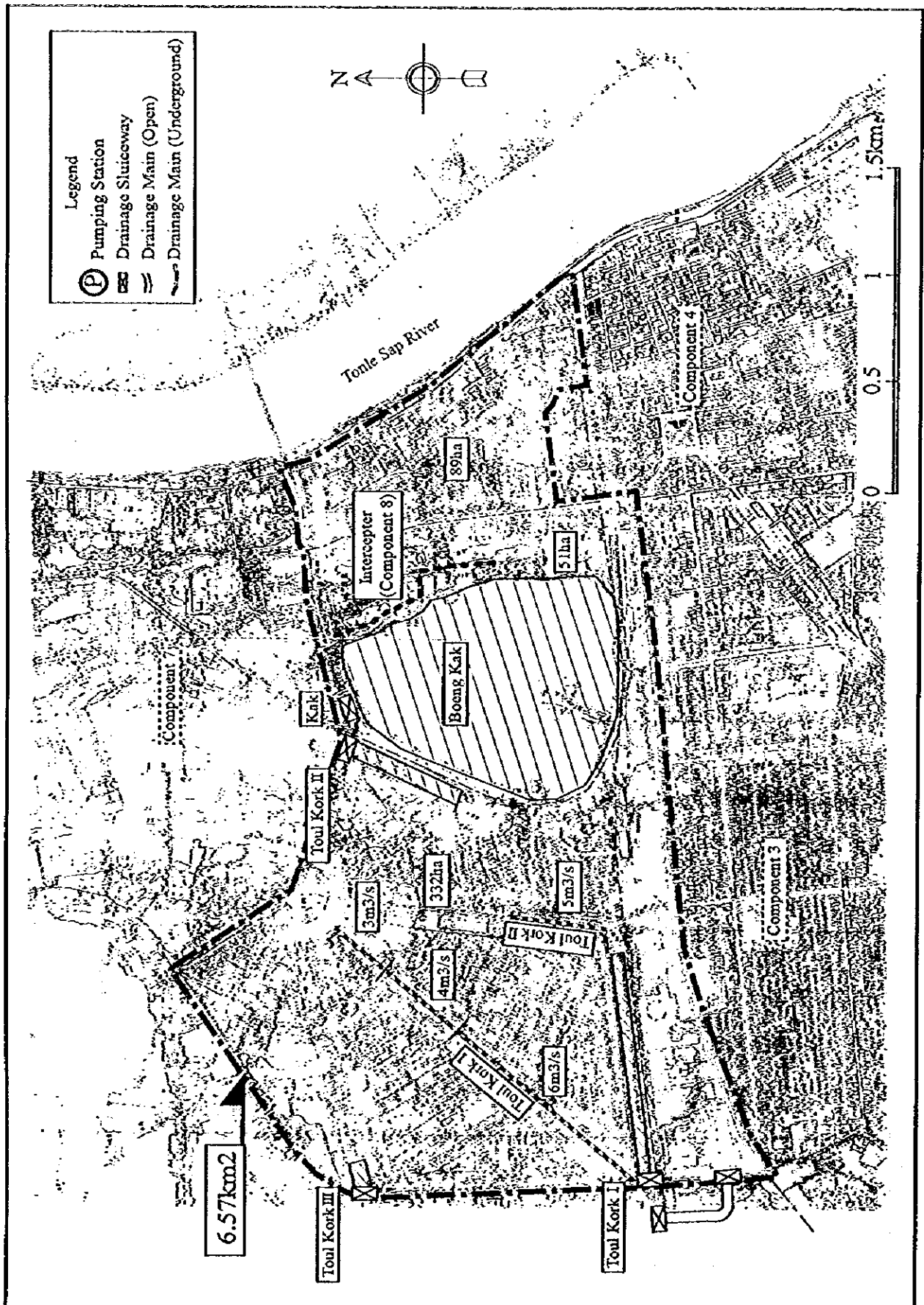

The Study on Drainage Improvement and Flood Control  
 in the Municipality of Phnom Penh  
 JICA - CTIE International Co., Ltd. - Nippon Koei Co., Ltd.

Figure 13-17  
 Facility Layout for Components 5: City Core North  
 Area Drainage Improvement



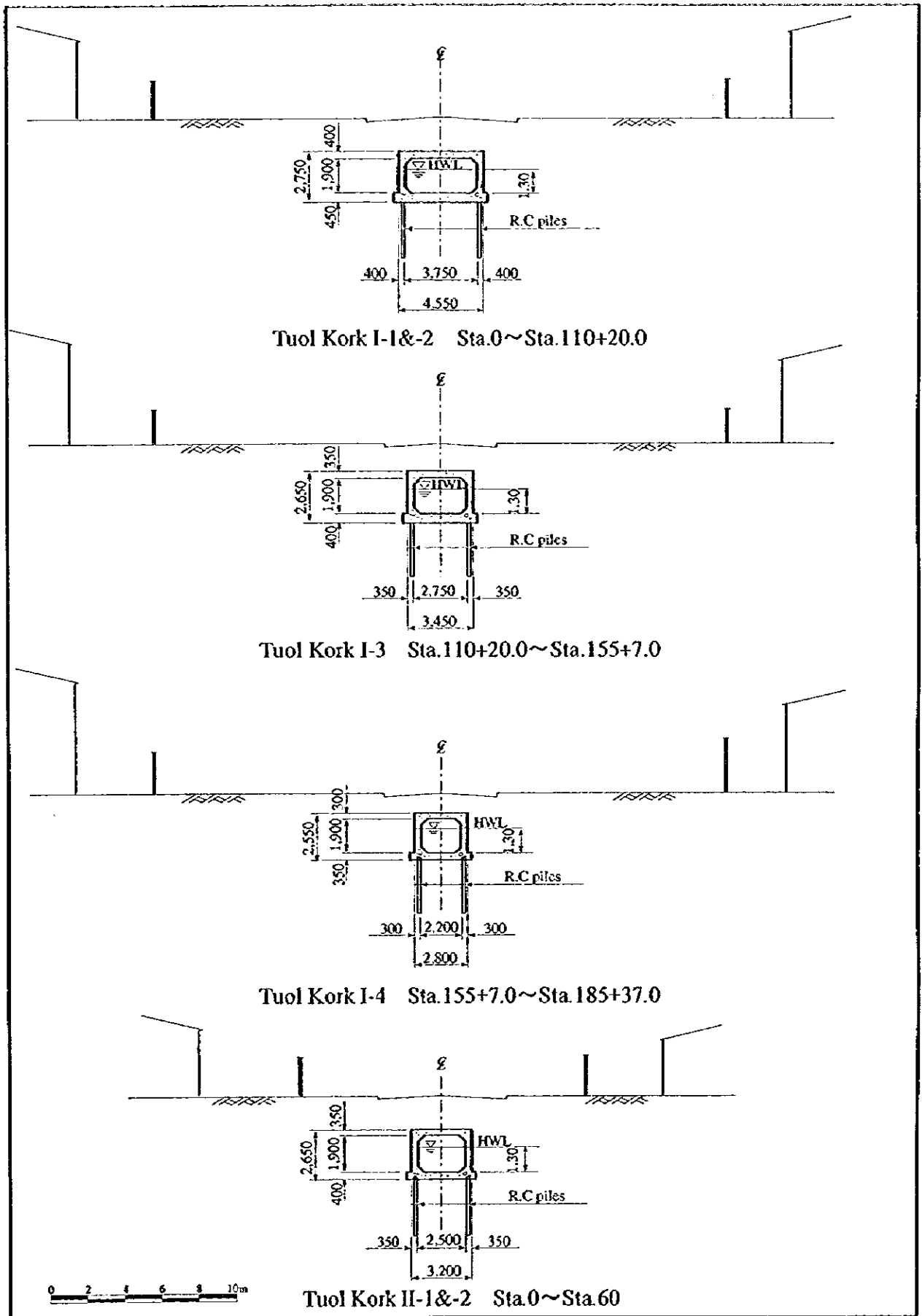

The Study on Drainage Improvement and Flood Control  
in the Municipality of Phnom Penh  
JICA - CTIE International Co., Ltd. - Nippon Koei Co., Ltd.

Figure 13-18  
Standard Cross-sections of Tuol Kork Drainage Mains

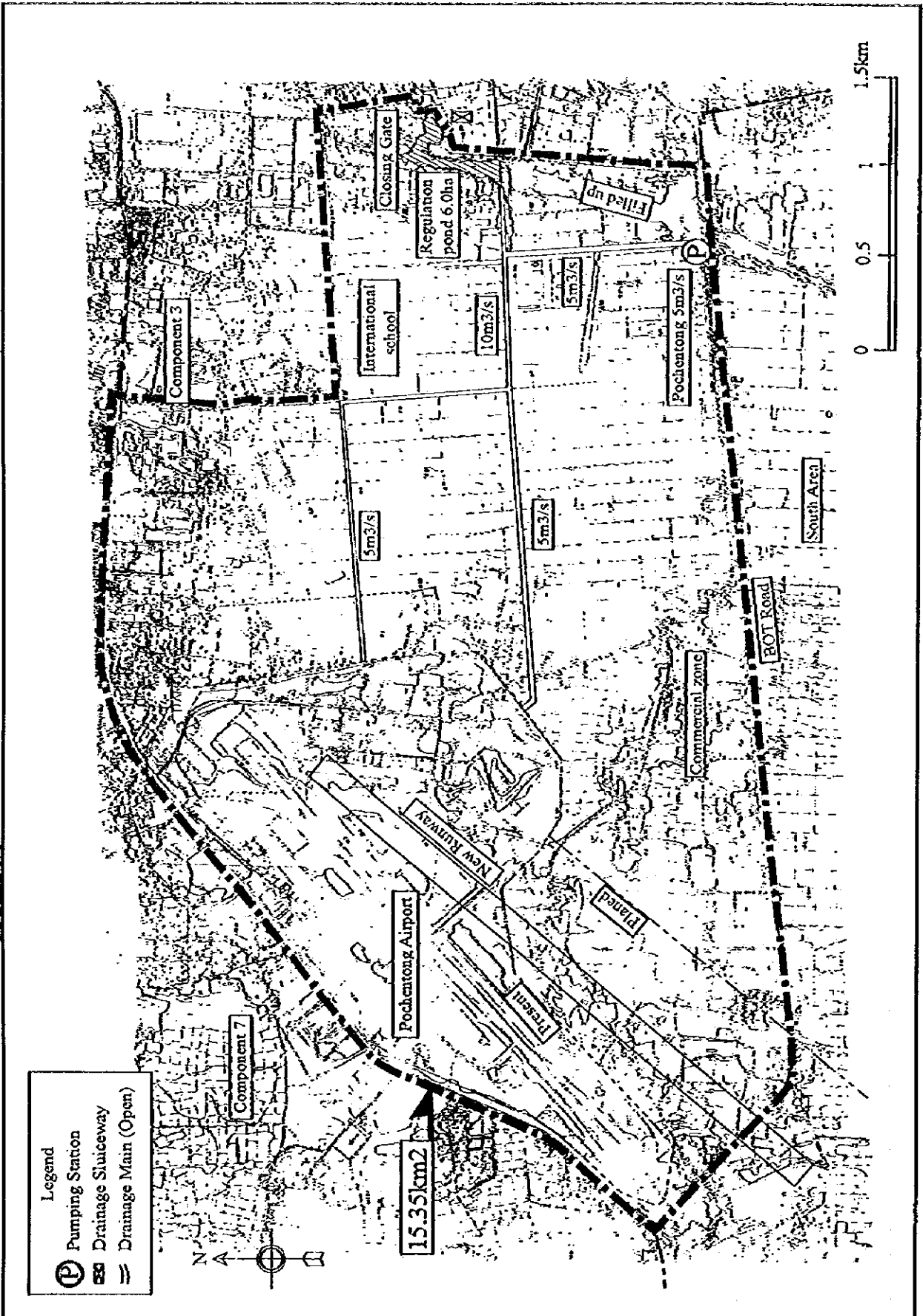

The Study on Drainage Improvement and Flood Control  
 in the Municipality of Phnom Penh  
 JICA - CTIE International Co., Ltd. - Nippon Koei Co., Ltd.

Figure I3-19  
 Facility Layout for Component 6: Pochentong  
 East Basin Drainage Improvement

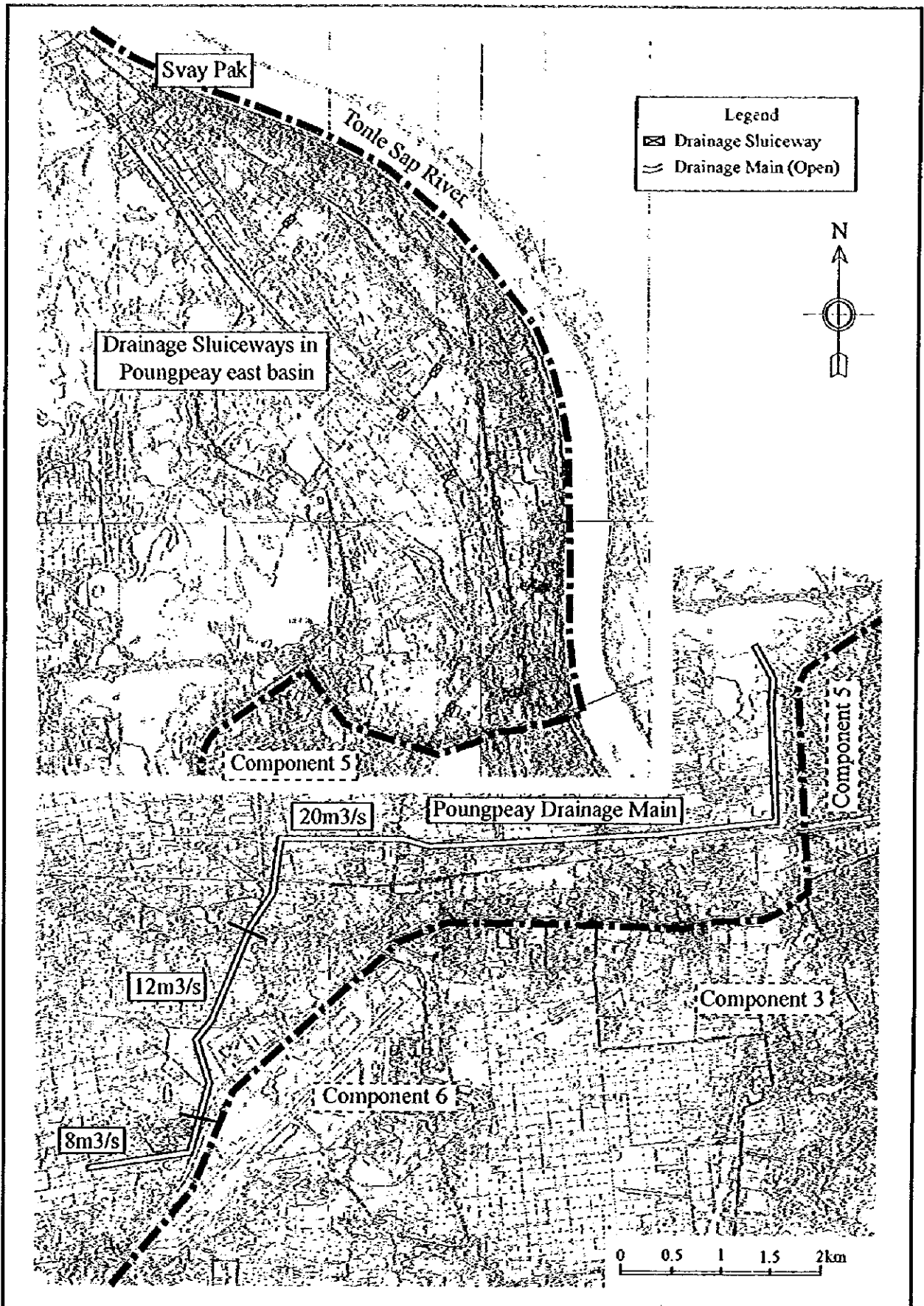

The Study on Drainage Improvement and Flood Control  
 in the Municipality of Phnom Penh  
 JICA - CTIE International Co., Ltd. - Nippon Koei Co., Ltd.

Figure 13-20  
 Facility Layout for Component 7: Northeast and  
 Northwest areas Drainage Improvement

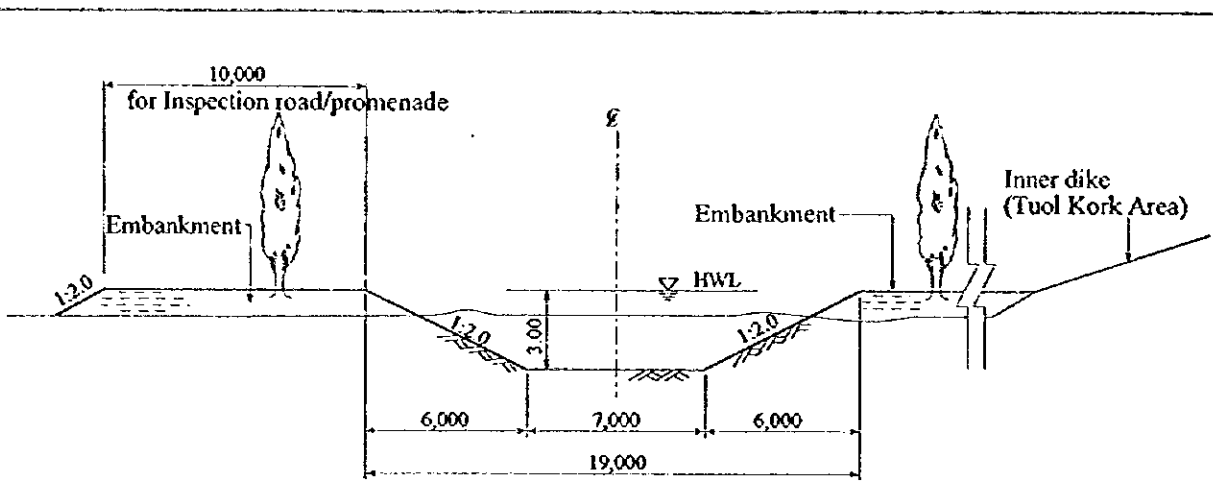

Sta. 13 ~ Sta. 20

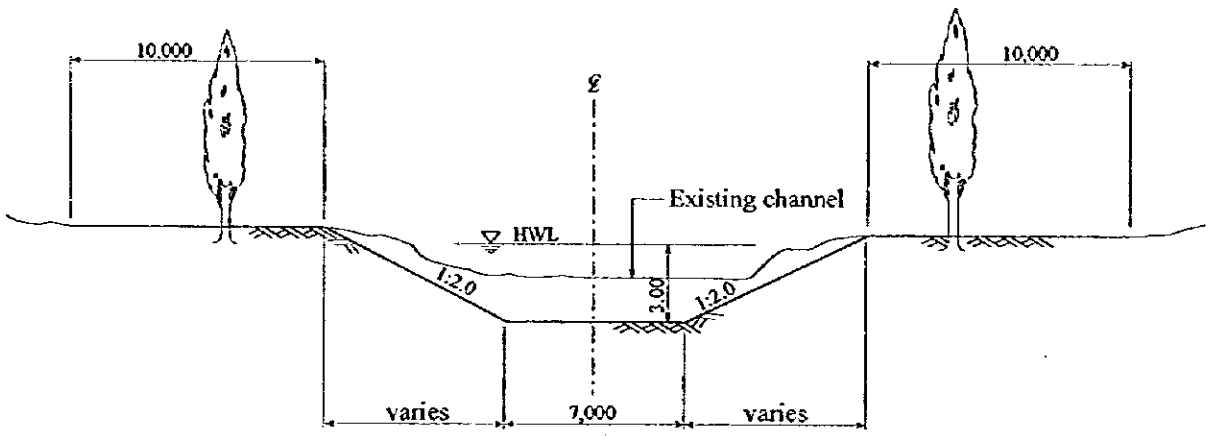

Sta. 37 ~ Sta. 45

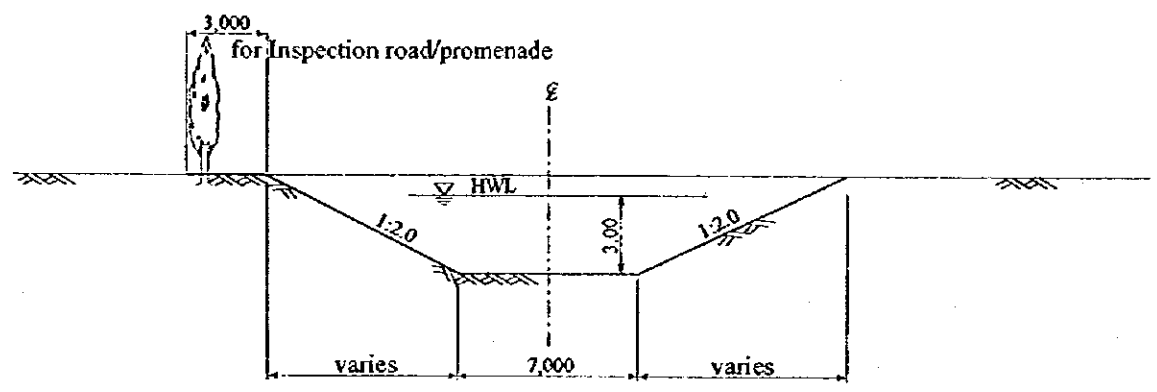

Sta. 53 ~ Sta. 80



The Study on Drainage Improvement and Flood Control  
in the Municipality of Phnom Penh  
JICA - CTIE International Co., Ltd. - Nippon Koei Co., Ltd.

Figure. 13-21  
Standard Cross-sections of Pongpeay Drainage Main (1/2)

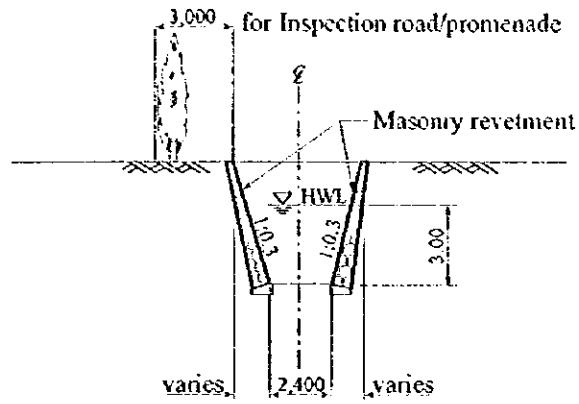

Sta. 80 ~ Sta. 97

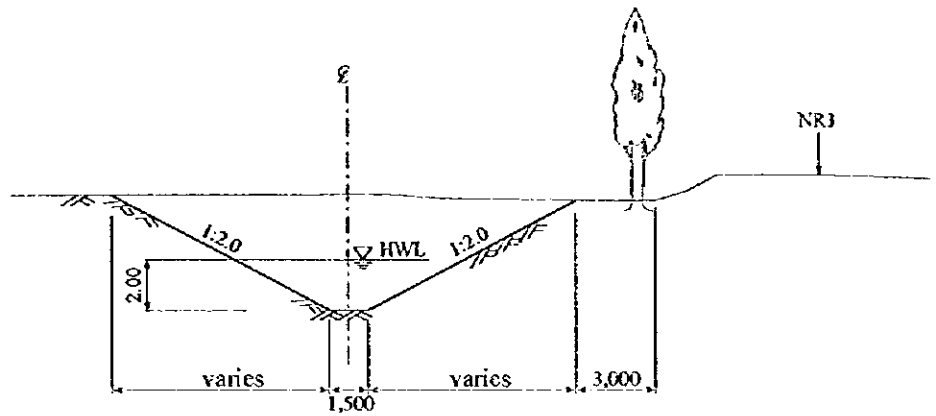

Sta. 97 ~ Sta. 104+17.0

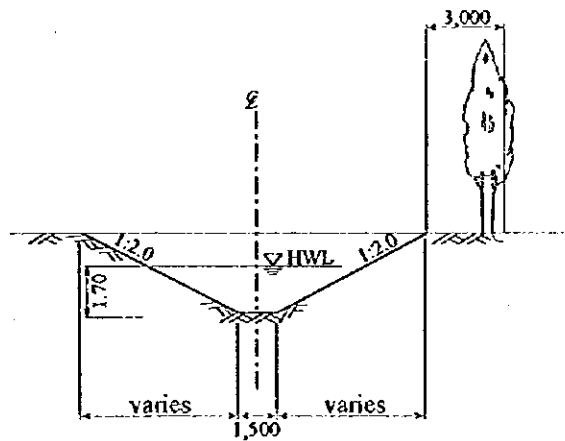

Sta. 104+17.0 ~ Sta. 119+20.0



The Study on Drainage Improvement and Flood Control  
in the Municipality of Phnom Penh  
JICA - CTIE International Co., Ltd. - Nippon Koei Co., Ltd.

Figure I3-21  
Standard Cross-sections of Pongpeay Drainage Main (2/2)

# Flood Defense Activities

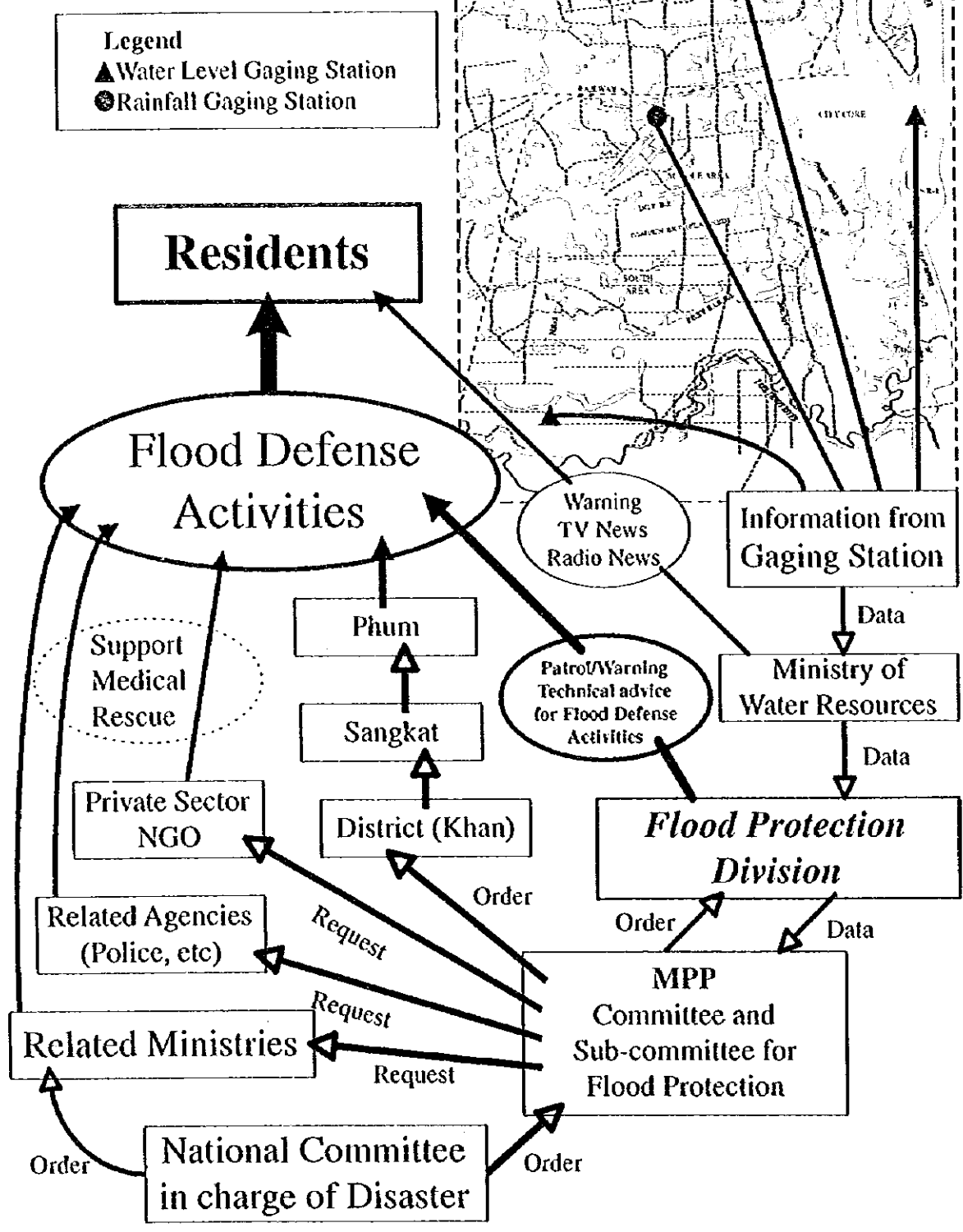

The Study on Drainage Improvement and Flood Control  
 in the Municipality of Phnom Penh  
 JICA - CTIE International Co., Ltd. - Nippon Koei Co., Ltd.

Figure 13-22  
 Flow of Flood Defense Activity

## Organizational Structure of Department of Public Works and Transport

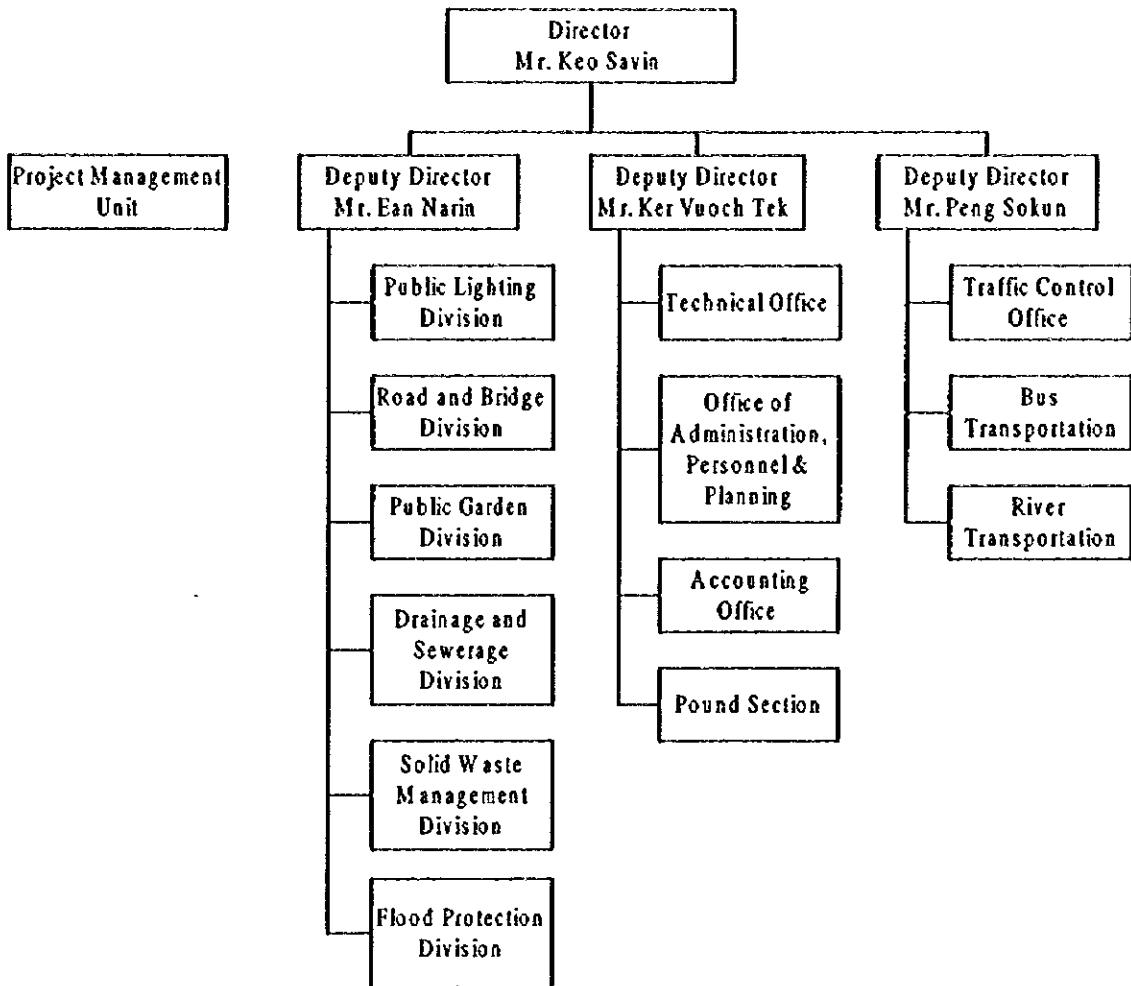

## Organizational Structure of Flood Protection Division

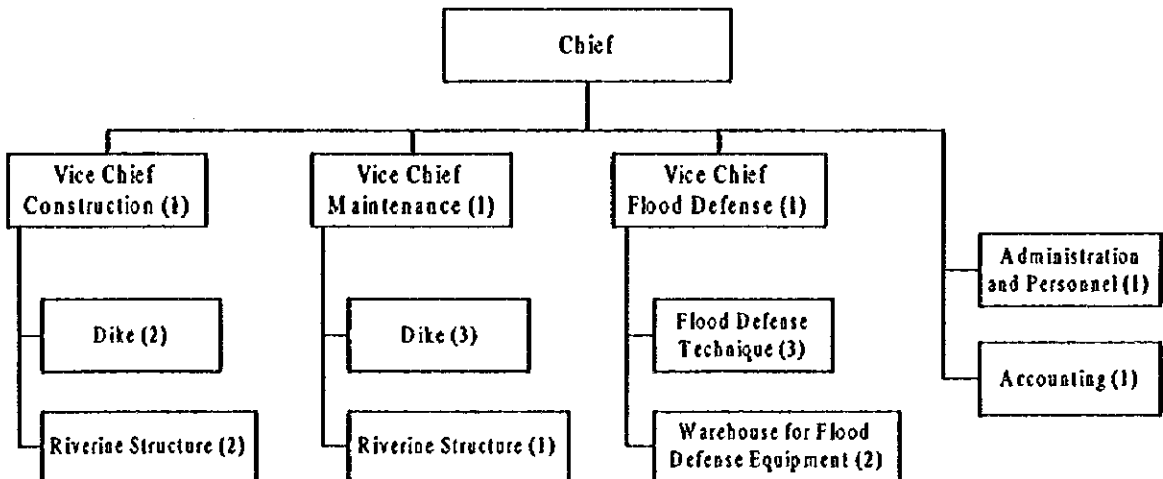

The Study on Drainage Improvement and Flood Control  
in the Municipality of Phnom Penh  
JICA-CTIE International Co., Ltd. - Nippon Koei Co., Ltd.

Figure I3-23  
Proposed Organizational Chart of Department of Public Works  
and Transport (DPWT) and Flood Protection Division