

圓子灣溝 典型区 黄草湾II号橋計画図 (B-2)

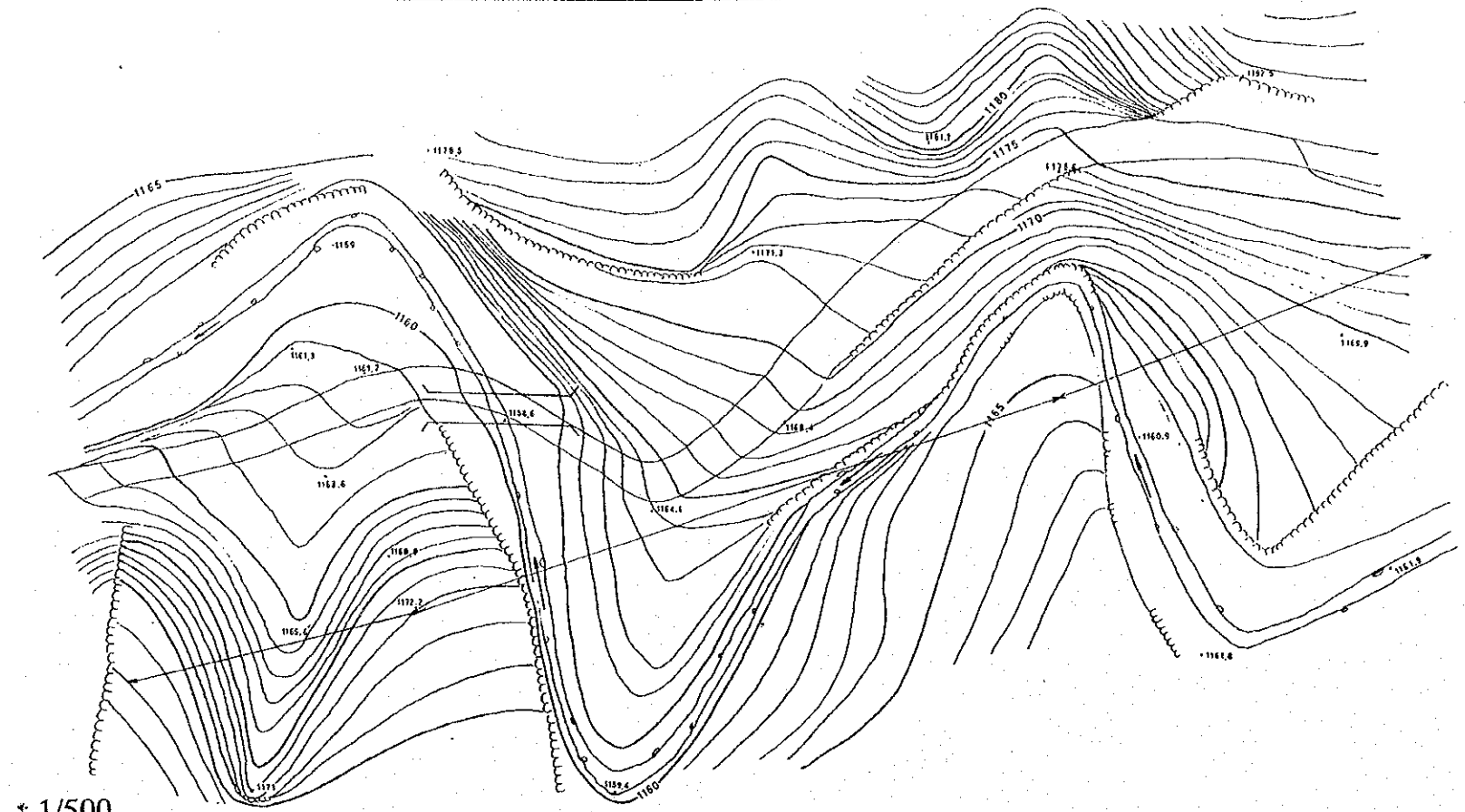

1/500

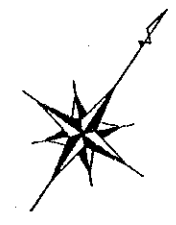
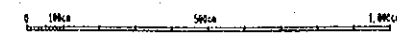
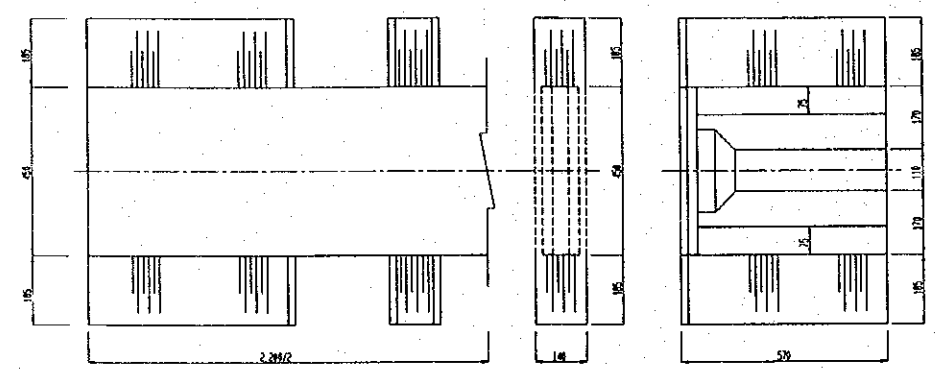
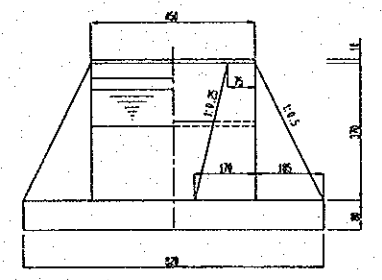
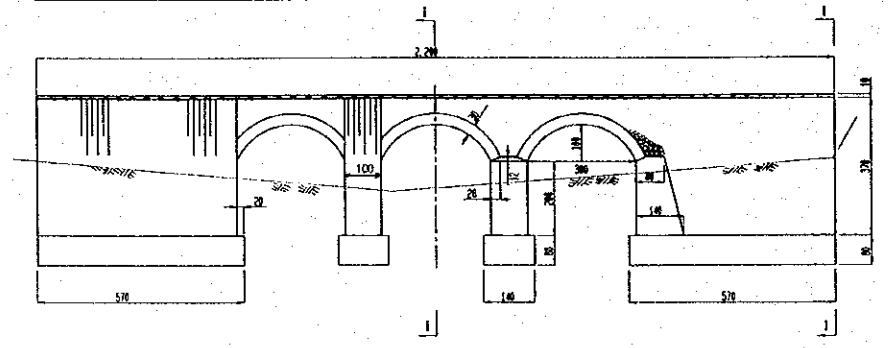

大西溝 典型区 龍泉寺 I号橋計画図 (B-3)

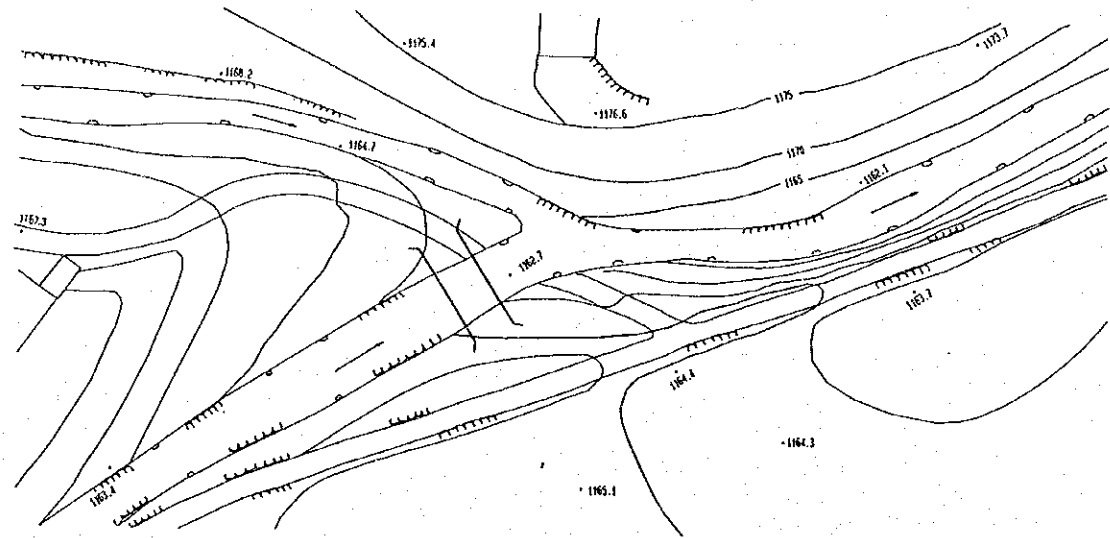

1/500

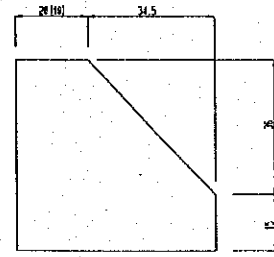
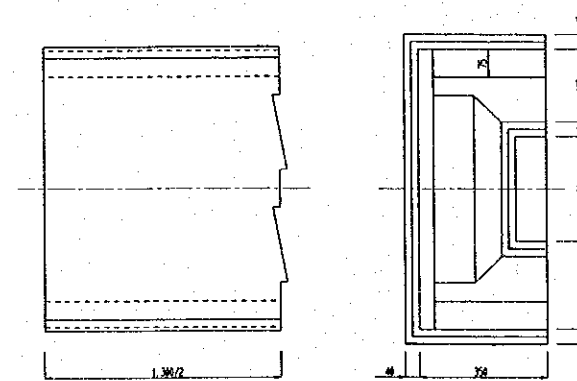
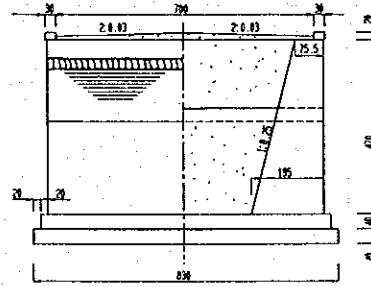
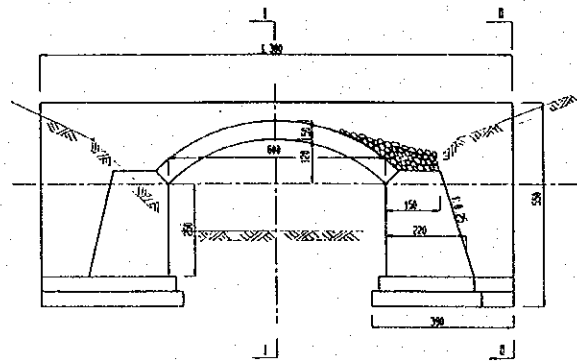
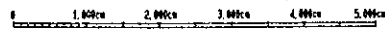

1:10

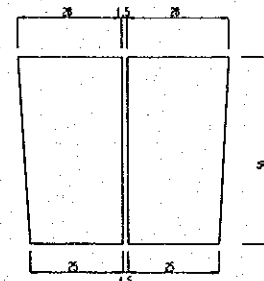

1:10

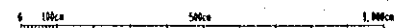

大西溝 典型区 龍泉寺II号橋計画図 (B-4)

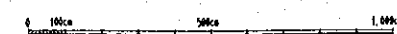
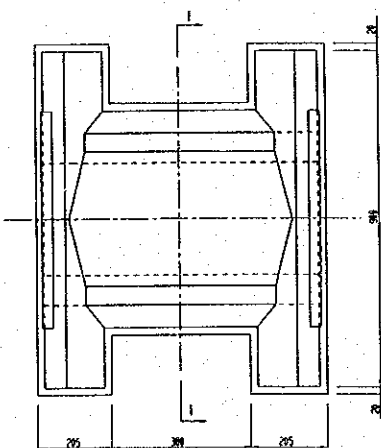
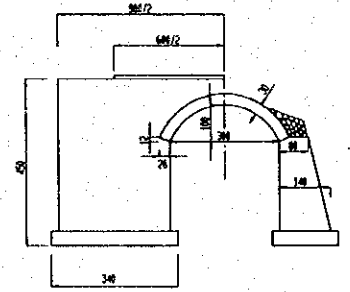
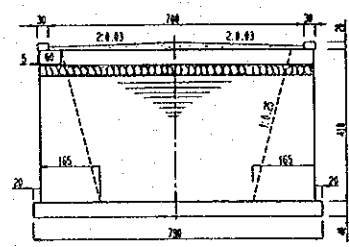
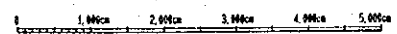
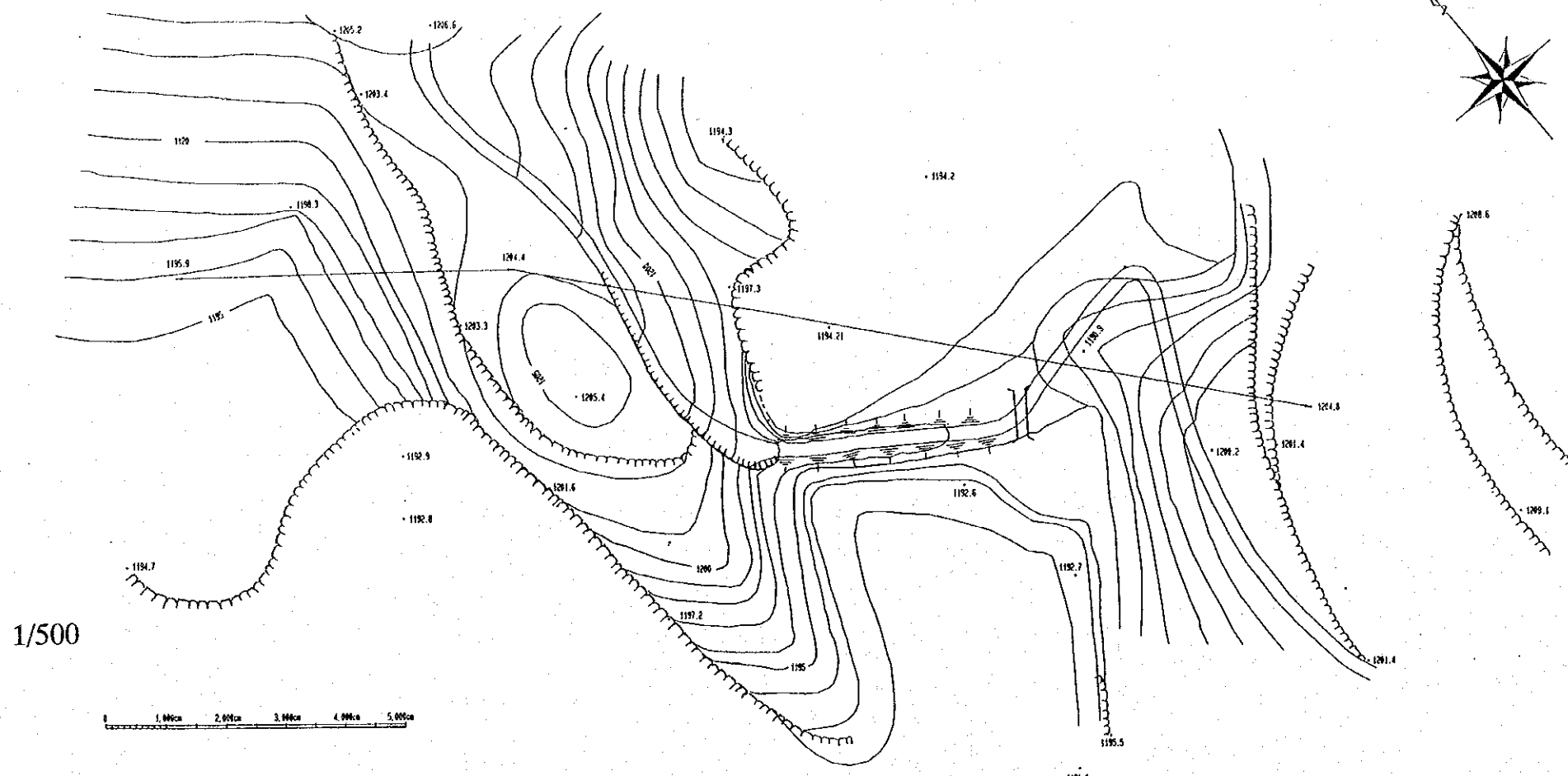
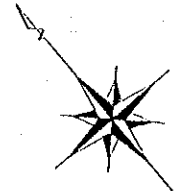



大西溝 典型区 任塌溝II号橋計画図 (B-6)

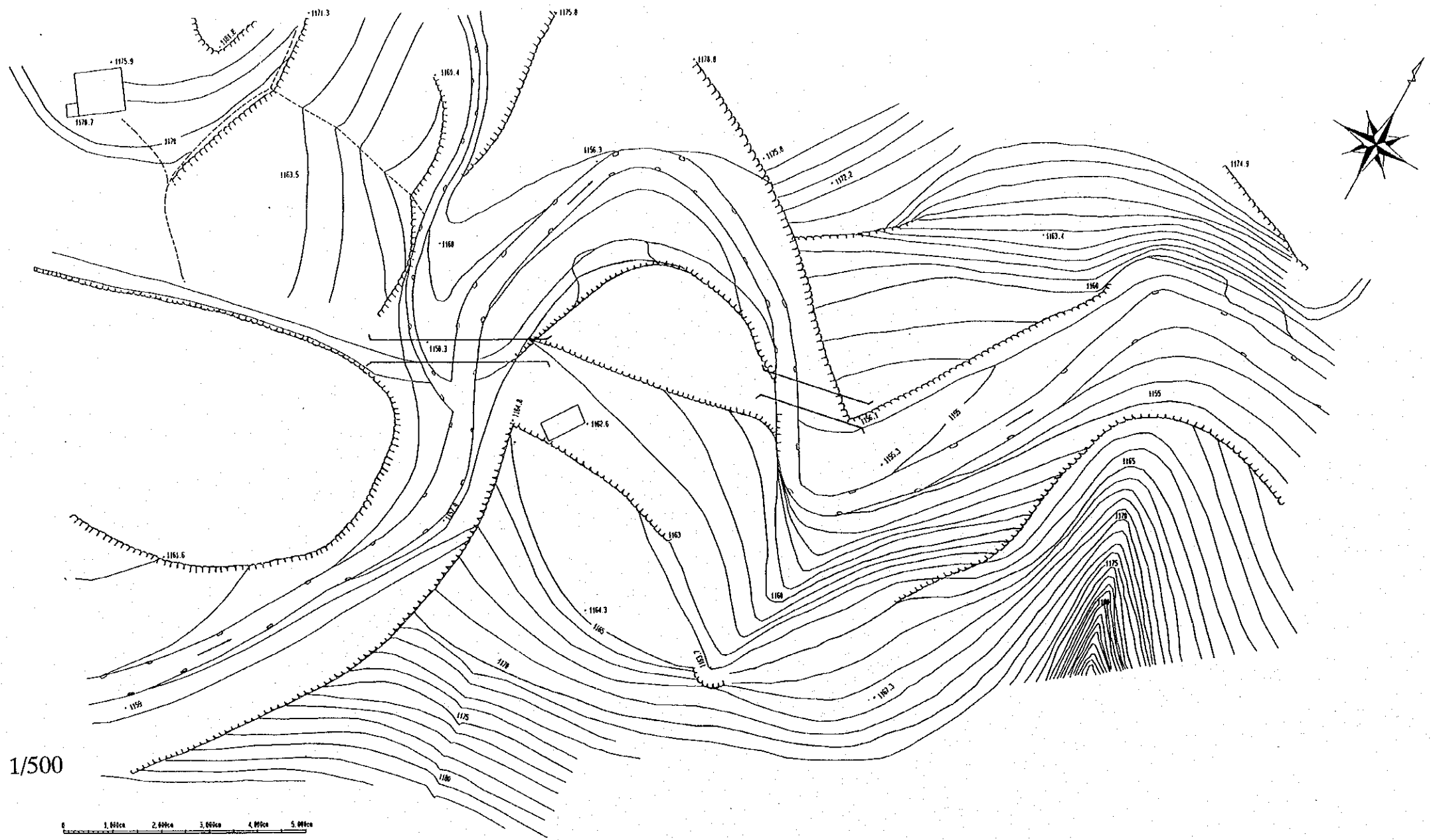

1/500

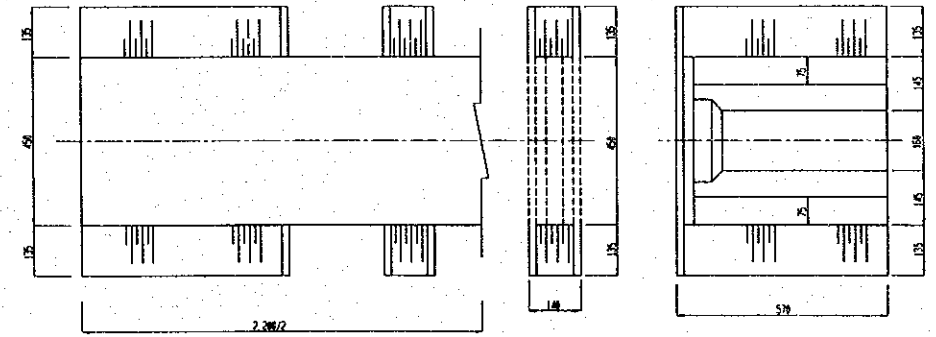
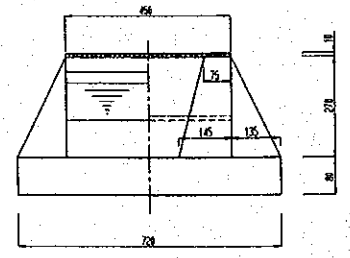
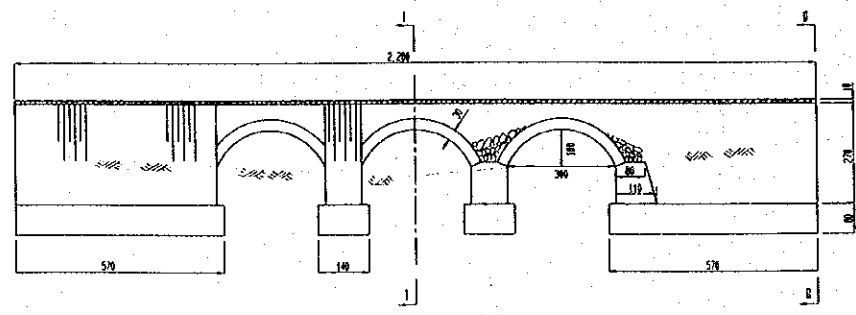
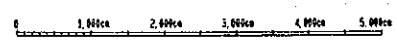

大西溝 典型区 任塌溝III号橋計画図 (B-7)

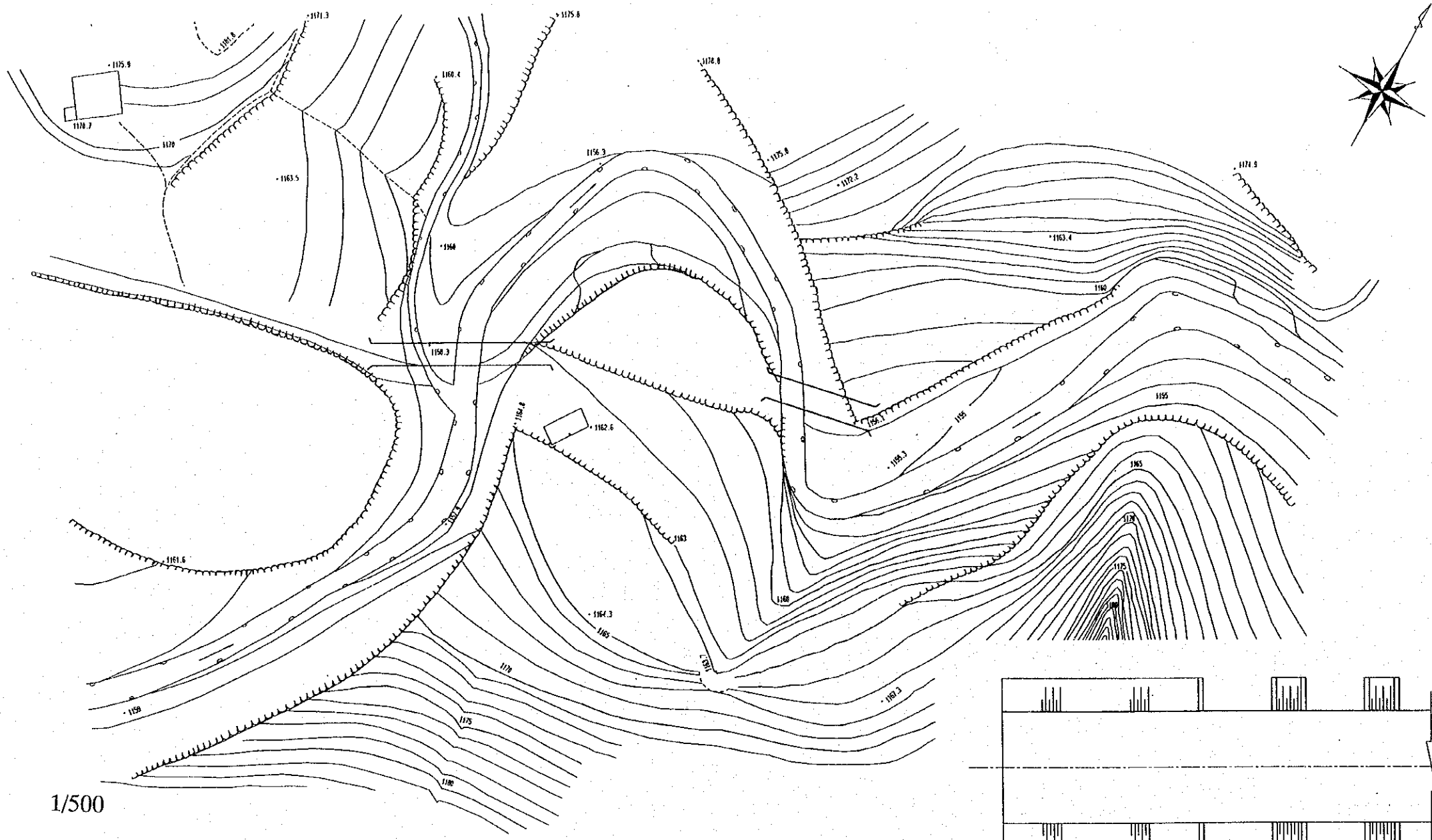

1/500

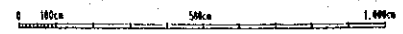
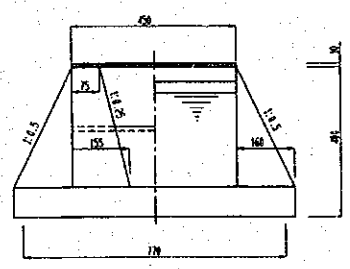
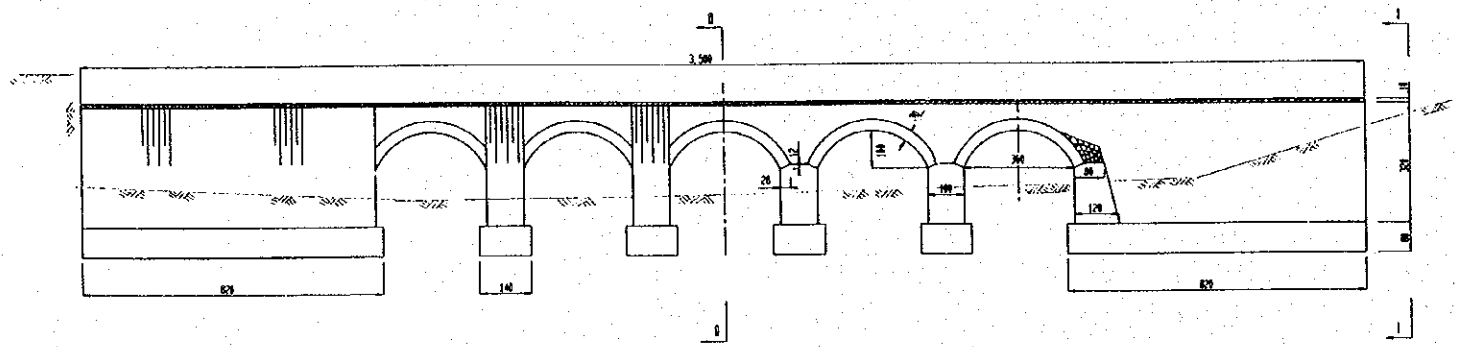
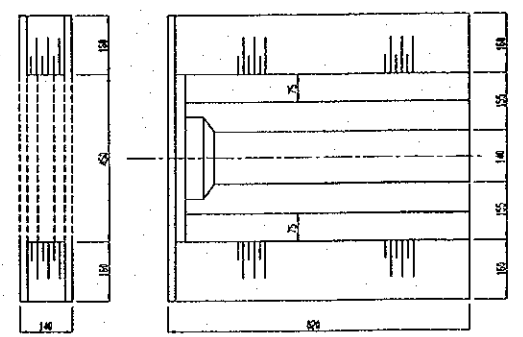
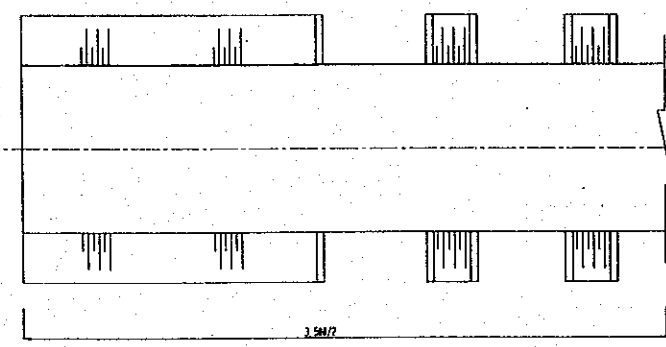
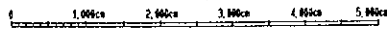



延河·杏子河 典型区 温室適地位置图 (T-1)

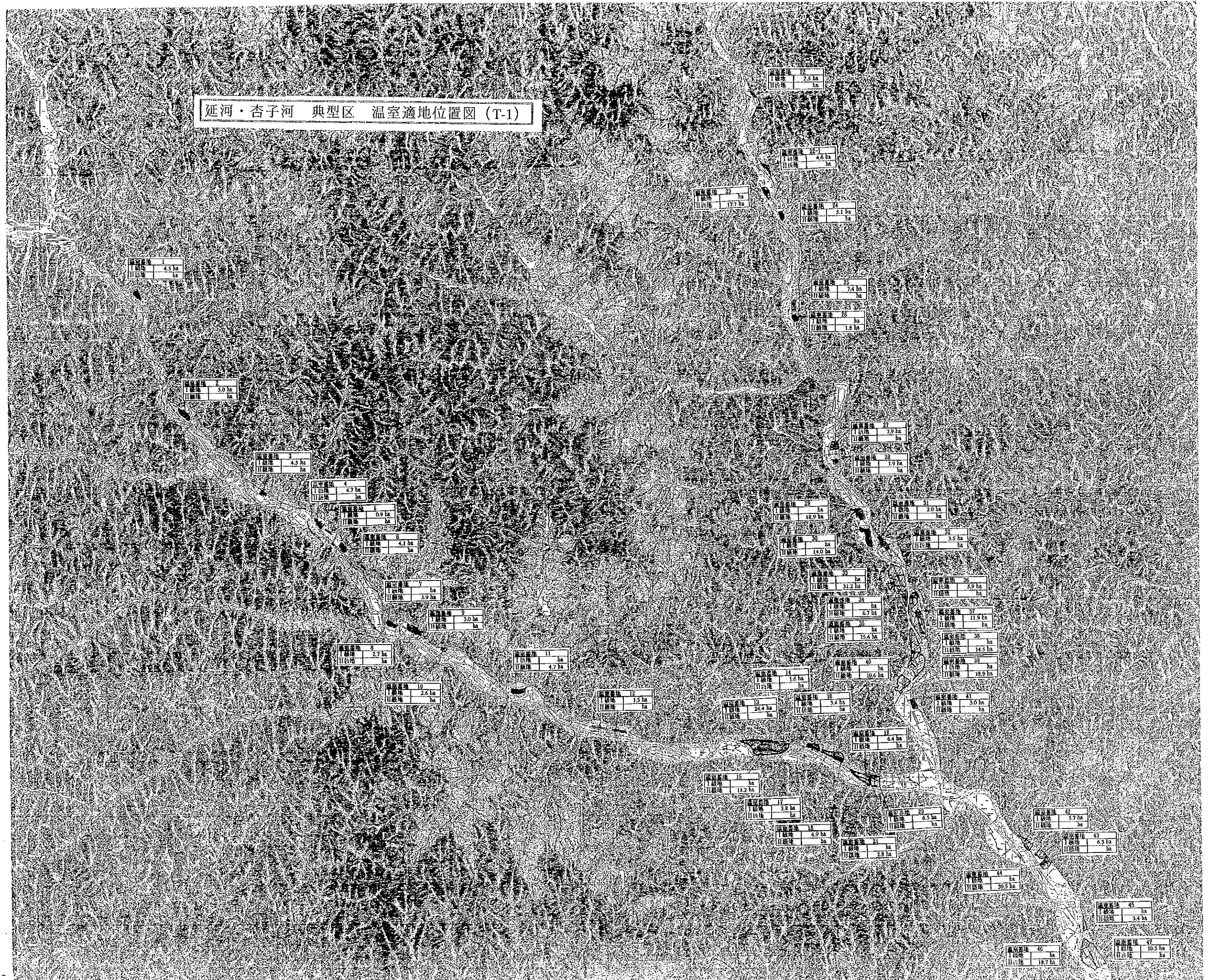





JICA