

Table F-21d IRRIGATION WATER DEMAND SHARED BY GROUNDWATER IN 2010 TO 2025 (2/2)

(UNIT: MCM)

Water Resources Region/Province	JAN		FEB		MAR		APR		MAY		JUN		JUL		AUG		SEP		OCT		NOV		DEC		TOTAL							
	WET	DRY	1	2	3	1	2	3	1	2	3	1	2	3	1	2	3	1	2	3	1	2	3									
VI	790.50	790.50																														
BOHOL	1038.00	1038.00	0.74	0.83	0.52	0.00	0.00	0.00	0.00	0.00	0.00	1.89	1.77	0.78	0.30	1.05	0.94	1.20	1.26	1.00	0.77	0.23	0.07	0.35	0.06	1.15	0.72	0.03	0.59	0.42	0.72	0.91
CEBU	44.00	44.00	0.04	0.00	0.00	0.00	0.00	0.00	0.00	0.00	0.00	0.05	0.05	0.05	0.04	0.03	0.03	0.03	0.03	0.03	0.03	0.03	0.04	0.04	0.03	0.03	0.03	0.04	0.04	0.04	0.04	
NEGROS OCC.	699.00	699.00	0.60	0.72	0.43	0.00	0.00	0.00	0.00	0.00	0.00	0.91	0.81	0.40	0.18	0.41	0.53	0.50	0.77	0.24	0.20	0.06	0.79	0.46	0.56	0.72	0.46	0.74	0.46	0.56	0.56	0.56
NEGROS OR/ISD/LAN	2539.20	2539.20	2.96	2.96	2.01	0.00	0.00	0.00	0.00	0.00	0.00	3.40	3.40	1.54	0.97	1.51	1.93	2.34	2.88	0.50	0.18	0.66	2.12	3.57	2.49	0.66	2.12	3.57	2.49	2.87	2.86	2.86
VIII	962.00	962.00																														
N. LEYTE/BUAN	0.00	0.00	0.00	0.00	0.00	0.00	0.00	0.00	0.00	0.00	0.00	0.00	0.00	0.00	0.00	0.00	0.00	0.00	0.00	0.00	0.00	0.00	0.00	0.00	0.00	0.00	0.00	0.00	0.00	0.00	0.00	
SOUTHERN LEYTE	353.00	353.00	0.00	0.01	0.00	0.00	0.00	0.00	0.00	0.00	0.00	0.44	0.46	0.30	0.21	0.34	0.34	0.29	0.14	0.07	0.22	0.30	0.22	0.24	0.17	0.00	0.01	0.16	0.00	0.05	0.05	0.05
EASTERN SAMAR	713.00	713.00	0.00	0.00	0.00	0.00	0.00	0.00	0.00	0.00	0.00	0.40	0.33	0.32	0.34	0.33	0.28	0.41	0.16	0.28	0.09	0.62	0.14	0.00	0.13	0.00	0.00	0.00	0.00	0.00	0.00	0.00
NORTHERN SAMAR	74.00	74.00	0.23	0.26	0.17	0.04	0.00	0.00	0.00	0.00	0.00	0.00	0.00	0.00	0.00	0.00	0.00	0.00	0.00	0.00	0.00	0.00	0.00	0.00	0.00	0.00	0.00	0.00	0.00	0.00	0.00	0.00
WESTERN SAMAR	2752.80	2750.10	1.95	1.59	0.59	0.07	0.00	0.00	0.00	0.00	0.00	2.87	3.42	4.43	4.43	3.33	3.33	2.66	1.14	0.85	0.85	0.90	0.71	1.33	0.24	0.43	0.19	0.97	0.71	0.84	0.84	0.84
IX	0.00	0.00																														
BASILAN	310.00	310.00	0.22	0.15	0.07	0.01	0.00	0.00	0.00	0.00	0.00	0.05	0.05	0.05	0.05	0.05	0.05	0.05	0.05	0.05	0.05	0.05	0.05	0.05	0.05	0.05	0.05	0.05	0.05	0.05	0.05	0.05
MISAMIS OCC.	0.00	0.00	0.00	0.00	0.00	0.00	0.00	0.00	0.00	0.00	0.00	0.00	0.00	0.00	0.00	0.00	0.00	0.00	0.00	0.00	0.00	0.00	0.00	0.00	0.00	0.00	0.00	0.00	0.00	0.00	0.00	0.00
SULU	0.00	0.00	0.00	0.00	0.00	0.00	0.00	0.00	0.00	0.00	0.00	0.00	0.00	0.00	0.00	0.00	0.00	0.00	0.00	0.00	0.00	0.00	0.00	0.00	0.00	0.00	0.00	0.00	0.00	0.00	0.00	0.00
TAWI-TAWI	1334.00	1334.00	0.95	0.65	0.36	0.00	0.00	0.00	0.00	0.00	0.00	0.68	0.75	1.68	0.21	0.22	0.00	0.00	0.00	0.00	0.00	0.00	0.00	0.00	0.00	0.00	0.00	0.00	0.00	0.00	0.00	0.00
ZAMBOANGA NORTE	191.40	1351.30	1.35	1.02	0.51	0.09	0.00	0.00	0.00	0.00	0.00	1.32	1.24	0.87	0.87	1.57	1.58	1.00	0.49	0.16	0.54	1.03	1.60	1.07	0.83	0.76	0.65	1.24	0.65	1.24	0.65	0.65
ZAMBOANGA SUR	3025.40	2995.30	2.56	2.51	1.68	0.01	0.00	0.00	0.00	0.00	0.00	4.25	4.48	2.68	2.74	3.11	2.63	3.24	2.42	2.88	1.79	1.26	3.42	1.40	2.67	2.82	1.91	2.59	2.54	2.54	2.54	
X	2788.00	2788.00																														
AGUSAN DEL N.	2667.00	2667.00	2.00	2.33	1.77	1.05	0.53	0.05	0.00	0.00	0.00	2.14	2.90	3.83	3.02	2.74	3.16	2.74	3.04	2.26	2.14	0.89	0.35	1.36	2.47	3.75	2.74	2.37	2.37	2.37	2.37	2.37
AGUSAN DEL S.	272.00	166.00	0.04	0.11	0.02	0.01	0.00	0.00	0.00	0.00	0.00	0.00	0.00	0.00	0.00	0.00	0.00	0.00	0.00	0.00	0.00	0.00	0.00	0.00	0.00	0.00	0.00	0.00	0.00	0.00	0.00	0.00
BUKIDNON	1602.40	1600.00	1.91	1.23	0.84	0.07	0.00	0.00	0.00	0.00	0.00	2.27	2.83	3.97	3.04	2.28	2.61	2.53	2.09	0.21	0.41	0.61	0.50	1.59	1.59	1.37	1.79	1.60	1.34	1.21	1.21	1.21
MISAMIS OR/CARAGA	1401.40	1399.00	1.23	1.23	1.23	0.00	0.00	0.00	0.00	0.00	0.00	0.00	0.00	0.00	0.00	0.00	0.00	0.00	0.00	0.00	0.00	0.00	0.00	0.00	0.00	0.00	0.00	0.00	0.00	0.00	0.00	0.00
DAVAO DEL NORTE	2564.00	2564.00	0.47	0.00	0.00	0.00	0.00	0.00	0.00	0.00	0.00	2.02	2.10	2.77	2.28	1.77	2.36	1.42	2.36	1.31	1.47	2.04	1.56	1.15	0.55	0.73	1.11	0.91	2.10	1.48	1.20	1.20
SURIGAO DEL NORTE	1124.00	1118.00	0.00	0.39	0.00	0.00	0.00	0.00	0.00	0.00	0.00	0.00	4.27	3.72	13.86	15.70	10.20	14.28	12.82	13.50	10.78	9.50	7.27	3.29	0.89	3.19	2.30	2.03	2.03	2.03	2.03	2.03
XI	14.40	12.37																														
DAVAO DEL NORTE	1569.00	1569.00	0.28	0.00	0.00	0.00	0.00	0.00	0.00	0.00	0.00	1.78	3.29	1.68	1.38	0.72	0.99	0.46	0.86	1.46	0.80	0.67	0.95	0.70	0.34	0.45	0.68	0.68	0.68	0.68	0.68	0.68
DAVAO ORIENTAL	1776.40	1772.00	0.78	0.49	0.20	0.00	0.00	0.00	0.00	0.00	0.00	1.76	1.77	2.55	1.77	1.81	1.54	1.89	1.99	1.08	0.54	0.23	1.36	1.77	1.41	1.01	1.46	1.41	1.46	1.46	1.46	1.46
DAVAO SUR	33.20	24.90	0.00	0.00	0.00	0.00	0.00	0.00	0.00	0.00	0.00	0.02	0.04	0.02	0.02	0.00	0.00	0.00	0.00	0.00	0.00	0.00	0.00	0.00	0.00	0.00	0.00	0.00	0.00	0.00	0.00	0.00
SO. COTABATO/SAR	2650.00	2650.00	0.30	4.14	4.05	0.00	0.00	0.00	0.00	0.00	0.00	0.00	0.00	0.00	0.00	0.00	0.00	0.00	0.00	0.00	0.00	0.00	0.00	0.00	0.00	0.00	0.00	0.00	0.00	0.00	0.00	0.00
SURIGAO DEL SUR	6045.00	6034.07	0.00	0.00	0.00	0.00	0.00	0.00	0.00	0.00	0.00	1.57	3.60	5.58	3.71	3.03	2.58	3.78	4.70	4.20	3.02	1.98	0.50	0.00	0.00	0.00	0.00	0.00	0.00	0.00	0.00	0.00
XII	0.00	0.00																														
BUKIDNON	5702.00	5702.00	0.00	0.00	0.00	0.00	0.00	0.00	0.00	0.00	0.00	0.00	0.00	0.00	0.00	0.00	0.00	0.00	0.00	0.00	0.00	0.00	0.00	0.00	0.00	0.00	0.00	0.00	0.00	0.00	0.00	0.00
LANAO DEL NORTE	5747.10	5747.60	6.99	9.19	7.90	6.27	3.06	2.70	0.00	0.00	0.00	6.67	6.64	7.54	6.34	6.24	6.30	40.63	44.44	45.44	56.00	60.00	3.94	0.46	3.81	6.11	7.93	7.04	6.95	5.45	6.90	6.90
MAGUINDANAO	778.00	775.10	9.60	6.33	2.93	0.13	0.00	0.00	0.00	0.00	0.00	4.77	6.48	6.44	5.72	10.41	7.48	5.12	5.58	3.76	2.21	1.81	1.24	0.07	4.27	7.00	6.87	6.87	6.87	6.87	6.87	6.87
NORTH COTABATO	1751.00	1781.00	1.59	0.82	0.11	0.00	0.00	0.00	0.00	0.00	0.00	2.27	2.44	2.34	2.23	2.14	1.80	2.30	2.31	1.80	0.82	0.32	1.37	1.59	1.27	1.27	1.84	2.01	1.97	2.01	1.95	1.95
SOUTH COTABATO	1618.20	1603.90	2.61	2.51	2.45	2.44	1.87	1.95	0.25	0.00	0.00	1.25	1.22	2.00	2.07	2.00	1.85	3.19	2.60	3.08	2.70	3.08	0.46	0.21	1.27	1.47	2.47	2.81	2.46	2.54	2.54	
SULTAN KUDARAT	2262.40	2250.60	29.98	20.65	10.32	0.97	0.00	0.00	0.00	0.00	0.00	27.23	30.30	22.68	27.68	29.19	28.99	30.88	29.20	32.30	15.34	6.58	12.85	23.26	31.34	24.14	20.05	25.11	26.09	26.06	26.06	
Total																																

Table F-23 PROJECTED POPULATION OF LIVESTOCK & POULTRY (High Economic Growth Scenario) (1/3)

WATER RESOURCES REGION/PROVINCE	1995		2000		2005		2010		2015		2020		2025	
	LIVESTOCK	CHICKEN	LIVESTOCK	CHICKEN	LIVESTOCK	CHICKEN	LIVESTOCK	CHICKEN	LIVESTOCK	CHICKEN	LIVESTOCK	CHICKEN	LIVESTOCK	CHICKEN
II														
Abra	93,060	277,200	112,597	1,409,957	112,541	1,409,911	138,939	2,408,981	167,765	3,219,410	207,347	4,397,878	268,480	6,083,793
Benguet***	36,341	154,462	44,150	988,415	45,262	1,293,545	58,079	1,689,954	69,465	2,258,488	87,971	3,085,209	116,714	4,267,917
Ilocos Norte	174,629	978,356	222,059	4,972,803	229,653	6,507,943	277,954	8,502,313	336,668	11,362,659	417,407	15,521,969	500,696	21,472,276
Ilocos Sur	137,798	1,092,714	172,483	5,554,064	178,106	7,268,643	212,470	9,496,130	294,400	12,690,816	311,457	17,336,300	398,771	23,982,126
La Union	142,895	810,131	173,609	4,117,747	177,991	5,388,924	219,608	7,040,369	271,024	9,408,888	342,033	12,853,019	452,246	17,780,191
TOTAL	584,636	3,352,863	724,898	17,041,985	746,542	22,302,987	905,071	29,137,747	1,099,622	39,940,261	1,368,219	53,194,375	1,776,306	73,586,302
Batanes		3,181		16,168		21,160		27,644		36,944		50,468		69,814
Cagayan	338,365	1,760,467	392,403	8,946,129	399,501	11,710,481	484,623	15,299,176	590,279	20,446,722	737,003	27,930,441	965,962	38,637,503
Iligao	79,234	394,855	96,604	2,008,975	99,113	2,626,543	122,053	3,431,491	150,369	4,585,959	189,438	6,264,516	250,014	8,666,002
Isabela	351,307	3,003,313	420,500	15,266,287	430,630	19,977,789	519,383	26,100,015	628,827	34,880,576	779,651	47,648,639	1,013,236	65,914,622
Kalinga	85,016	229,022	98,805	1,138,663	100,492	1,490,176	124,581	1,946,843	154,566	2,001,789	196,541	3,554,189	261,697	4,916,679
Mt. Province	82,614	182,170	100,381	525,937	102,752	1,211,780	129,972	1,583,132	163,730	2,115,728	210,567	2,890,192	288,559	3,998,140
Nueva Vizcaya	106,864	591,185	129,955	2,801,470	133,117	3,666,304	166,862	4,789,849	206,654	6,401,248	266,543	8,744,431	356,623	12,090,585
Quirino	61,175	481,343	74,847	2,446,578	76,797	3,201,854	93,325	4,183,087	118,216	5,590,333	149,833	7,636,679	198,900	10,564,181
TOTAL	1,104,595	6,600,516	1,313,500	33,549,207	1,342,404	43,908,096	1,642,800	57,361,177	2,014,642	76,658,610	2,529,375	104,719,558	3,329,890	143,863,527
III														
Aurora	34,186	144,483	40,725	734,380	41,652	961,089	50,610	1,265,616	61,682	1,678,030	76,980	2,292,275	100,730	3,171,012
Bataan	38,816	327,818	46,856	1,666,238	47,993	2,180,618	59,088	2,848,872	72,804	3,807,289	91,762	5,200,950	121,203	7,194,721
Benguet***	36,341	194,462	44,151	998,415	45,262	1,203,545	56,079	1,689,954	69,466	2,258,488	87,972	3,085,209	116,715	4,267,917
Bulacan	745,734	6,017,579	909,790	30,586,245	928,051	40,028,437	1,249,597	92,295,216	1,650,956	60,888,560	2,213,337	95,471,051	3,092,168	132,069,632
Nueva Ecija	342,621	5,721,163	413,249	29,079,617	422,666	38,058,703	531,081	48,719,240	665,549	66,445,775	852,120	90,768,305	1,142,901	125,564,100
Pampanga	139,082	5,974,675	163,764	30,368,172	172,347	39,743,043	223,126	51,922,363	290,861	69,390,872	382,469	94,790,364	525,871	131,128,005
Pangasinan	339,901	2,772,976	477,191	14,094,526	441,643	18,445,607	521,329	24,098,293	618,183	32,205,434	749,371	43,994,260	949,228	60,859,346
Tarlac	295,135	1,929,482	249,838	9,807,202	256,601	12,834,754	311,968	16,767,986	379,373	22,409,067	472,654	30,611,325	616,887	42,346,927
Zambales	84,735	800,571	101,697	4,069,156	104,215	5,326,332	125,300	6,937,289	151,270	9,297,858	187,013	12,701,346	242,299	17,570,375
TOTAL	1,966,551	23,883,209	2,422,261	121,393,951	2,460,320	158,860,129	3,129,779	207,584,829	3,960,133	277,380,374	5,112,277	378,915,684	6,908,000	524,172,035
IV														
Batangas	391,088	11,753,410	485,253	59,740,416	497,694	78,182,710	644,436	102,141,928	826,521	136,504,490	1,079,290	186,472,069	1,473,429	257,955,665
Cebu	167,662	582,129	207,147	2,958,654	212,078	3,872,274	279,138	5,058,938	362,549	6,760,865	473,661	9,235,886	660,173	12,776,162
Laguna	211,027	3,849,235	256,659	19,594,932	261,841	25,604,792	349,298	33,451,422	458,406	44,706,142	610,817	61,069,495	849,833	84,480,328
Marikinae	82,017	243,121	99,601	1,235,739	100,775	1,617,221	127,418	2,112,821	160,505	2,823,615	206,481	3,857,202	278,234	5,335,850
Mindoro Occidental	107,361	466,338	128,682	2,370,310	131,890	3,102,042	155,742	4,053,667	184,873	5,416,065	224,765	7,398,620	286,175	10,234,862
Mindoro Oriental	92,868	580,443	112,431	2,886,091	115,480	3,781,236	137,001	4,940,002	163,384	6,601,916	199,499	9,018,552	255,058	10,302,810
Palaian	156,200	469,434	194,132	342,999	199,597	3,122,636	249,960	4,079,573	312,139	5,452,022	397,948	7,447,739	531,018	12,427,791
Quezon	269,015	2,577,366	246,494	13,100,297	349,882	17,144,439	438,814	22,398,379	549,337	29,933,637	703,043	40,890,688	943,116	56,566,278
Rizal	202,816	3,066,428	246,494	15,586,969	251,218	20,397,625	339,475	26,648,510	443,714	35,613,596	603,917	48,649,981	946,049	67,299,326
Romblon	79,865	641,766	100,335	79,865	103,585	4,268,974	124,952	1,577,208	151,088	7,453,491	188,758	10,181,846	241,500	14,085,033
TOTAL	1,779,919	24,217,672	2,172,753	123,093,965	2,274,140	161,263,949	2,846,234	210,461,449	3,616,515	281,264,838	4,691,167	384,272,260	6,364,565	531,512,595

Table F-23 PROJECTED POPULATION OF LIVESTOCK & POULTRY (High Economic Growth Scenario) (2/3)

WATER RESOURCES REGION/PROVINCE	1996		2000		2005		2010		2015		2020		2025	
	LIVESTOCK	CHICKEN	LIVESTOCK	CHICKEN	LIVESTOCK	CHICKEN	LIVESTOCK	CHICKEN	LIVESTOCK	CHICKEN	LIVESTOCK	CHICKEN	LIVESTOCK	CHICKEN
V														(unit : head)
Albay	176,439	682,586	208,200	3,469,459	212,438	4,540,506	251,113	5,931,951	321,482	7,027,576	405,238	10,829,472	535,770	14,980,322
Camarines Norte	100,732	346,259	118,684	1,759,971	121,015	2,303,286	149,313	3,009,132	184,438	4,021,463	233,221	5,493,523	309,315	7,599,451
Camarines Sur	270,795	1,708,995	320,988	8,696,507	327,567	11,368,093	404,953	14,851,864	500,816	19,848,324	653,845	27,113,819	841,193	37,537,832
Catanduanes	55,113	186,031	63,960	945,361	69,004	1,237,463	80,647	1,616,685	100,086	2,160,570	127,176	2,951,449	169,570	4,007,879
Mabato	170,941	935,323	206,712	4,754,074	212,403	6,221,691	249,519	8,126,338	294,504	10,862,872	356,829	14,839,235	451,832	20,527,816
Sorsogon	134,284	478,557	161,733	2,432,417	165,564	3,183,322	204,390	4,156,866	252,426	5,557,977	318,879	7,592,479	422,170	10,603,006
TOTAL	908,306	4,337,731	1,060,257	22,047,869	1,104,122	28,854,360	1,349,935	37,690,826	1,654,154	50,378,763	2,075,188	68,819,977	2,729,850	95,201,937
VI														
Aklan	96,539	744,965	118,935	3,786,520	121,934	4,955,445	153,745	6,474,050	193,113	8,652,048	247,593	11,819,137	332,297	16,343,373
Antique	124,124	898,922	154,226	4,569,055	199,096	5,979,555	188,775	7,811,999	224,983	10,440,170	274,249	14,261,720	343,630	19,128,914
Capiz	118,563	823,313	139,680	4,184,748	142,477	5,476,610	175,373	7,154,926	216,190	9,561,984	272,848	13,062,156	361,190	18,569,500
Iloilo & Cuyayanon	415,932	4,936,615	501,278	25,091,905	513,478	32,837,954	628,663	42,901,198	770,951	37,304,009	967,444	78,321,169	1,272,345	108,345,387
Negros Occ.***	384,328	3,960,853	459,811	20,132,286	468,832	26,347,266	586,523	34,421,428	731,286	46,001,477	932,182	62,840,395	1,245,376	86,930,043
Negros Cr.***	1,139,456	11,364,668	1,323,831	57,764,514	1,405,816	75,596,831	1,733,080	98,763,601	2,136,523	131,989,627	2,694,323	180,304,537	3,560,839	249,423,817
TOTAL	326,884	2,192,084	404,232	11,145,009	415,715	14,585,552	513,277	19,055,318	633,509	25,465,904	799,077	34,787,719	1,055,319	48,123,501
Davao	455,932	4,753,485	574,600	24,161,068	592,270	31,619,789	740,619	41,309,724	923,381	56,207,131	1,174,968	75,415,746	1,564,208	106,326,178
Negros Occ.**	344,463	1,671,352	433,715	6,495,174	447,101	11,117,635	555,427	14,542,731	688,737	19,411,137	872,016	26,516,599	1,155,232	36,681,669
Negros Cr.***	59,755	351,604	76,570	1,797,128	79,067	2,336,841	99,955	3,056,582	125,683	4,063,540	161,090	5,578,324	215,837	7,176,760
Siquip	1,187,064	8,909,125	1,489,267	45,588,410	1,534,152	59,661,877	1,909,278	77,949,355	2,331,310	104,167,712	3,007,152	142,298,388	3,940,617	146,848,108
TOTAL	542,576	3,065,361	645,792	15,580,665	657,676	20,390,528	862,347	26,639,238	1,096,120	35,601,203	1,434,096	48,633,053	1,965,480	67,276,408
IX														
Biliran & Northern Leyte	93,100	500,138	112,428	2,694,594	114,826	3,526,434	147,707	4,607,115	188,611	6,157,040	245,559	8,410,830	334,594	11,035,100
Southern Leyte	79,474	413,462	91,845	2,101,551	92,214	2,750,315	117,878	3,593,153	148,672	4,801,961	191,728	6,559,723	759,305	9,074,376
Eastern Samar	103,416	296,050	122,156	1,504,768	124,450	1,969,300	157,163	2,572,795	197,882	3,438,334	294,611	4,696,640	343,361	6,497,490
Northern Samar	100,538	334,376	116,896	1,699,572	116,648	2,224,241	151,796	2,905,864	193,204	3,883,454	251,130	5,304,995	342,095	7,388,687
Western Samar	919,104	4,639,367	1,099,107	23,581,149	1,108,813	30,860,818	1,426,891	40,318,166	1,823,488	53,851,993	2,327,124	73,905,940	3,244,835	101,822,034
TOTAL	21,778	229,436	25,776	1,166,181	26,232	1,526,189	33,489	1,983,892	42,504	2,664,877	56,078	3,640,094	74,768	5,035,500
Basilan	171,104	1,582,926	215,356	8,045,721	222,264	10,529,493	275,414	13,756,273	340,786	18,384,155	430,601	25,113,689	569,302	34,740,957
Misamis Occ.	14,910	408,522	21,746	2,076,442	23,110	2,717,465	24,880	3,500,223	26,756	4,744,588	28,847	6,481,348	31,565	8,955,956
Sulu	2,898	64,489	4,073	327,786	4,295	426,975	4,822	560,499	5,428	748,977	5,194	1,023,141	7,260	1,415,360
Tawi-Tawi	237,663	1,071,974	280,744	6,498,336	265,362	11,121,833	354,939	14,530,136	440,089	19,418,301	558,367	25,526,468	742,924	36,699,321
Zamboanga Norte	408,311	2,876,643	600,421	14,367,306	614,378	18,802,593	764,513	24,564,681	950,484	32,828,725	1,208,128	44,845,706	1,609,118	67,037,192
Zamboanga Sur	946,654	6,783,990	1,148,316	34,481,771	1,176,661	45,126,540	1,458,056	58,955,641	1,806,043	78,789,483	2,287,214	107,630,437	3,034,755	148,890,267
TOTAL														

Table F-23 PROJECTED POPULATION OF LIVESTOCK & POULTRY (High Economic Growth Scenario) (3/3)

WATER RESOURCES REGION/PROVINCE	1996*		2000		2005		2010		2015		2020		2025	
	LIVESTOCK	CHICKEN	LIVESTOCK	CHICKEN	LIVESTOCK	CHICKEN	LIVESTOCK	CHICKEN	LIVESTOCK	CHICKEN	LIVESTOCK	CHICKEN	LIVESTOCK	CHICKEN
	(unit : head)													
X														
Agusan Norte	146,888	845,968	174,943	4,299,899	178,132	5,627,309	229,501	7,351,807	293,322	9,826,100	362,848	13,421,586	522,785	18,566,716
Agusan Sur	88,860	470,099	104,824	2,392,476	106,255	3,131,051	134,892	4,066,714	170,516	5,466,714	220,263	7,467,809	298,195	10,330,574
Bukidnon***	140,980	912,061	175,756	4,638,888	181,327	6,070,946	216,668	7,331,396	259,843	10,599,675	318,686	14,479,694	428,866	20,030,448
Caraga**	23,550	256,428	29,741	1,303,376	36,929	1,705,738	49,194	2,228,464	63,558	2,978,163	83,358	4,068,322	85,331	5,627,903
Misamis Oriental	194,027	1,510,144	255,211	7,675,784	265,305	10,046,363	321,841	13,123,767	390,590	17,538,862	483,800	23,958,977	625,887	33,143,569
Davao del Norte***	82,946	256,085	97,148	1,311,799	88,709	1,716,760	126,827	2,242,864	162,160	2,997,408	211,423	4,034,611	288,745	5,664,270
Surigao del Norte	677,250	4,233,985	837,123	21,622,222	860,353	28,297,156	1,068,736	36,969,365	1,325,835	49,405,922	1,680,378	67,490,999	2,229,809	93,353,500
TOTAL	266,558	2,441,474	319,487	12,400,563	326,069	16,240,483	416,479	21,217,405	529,843	28,355,359	685,536	38,704,651	930,364	53,583,771
Davao del Norte***	150,258	932,002	180,285	4,737,194	184,025	6,199,600	235,207	8,099,478	298,874	10,824,302	387,510	14,786,546	526,036	20,454,931
Davao del Sur	472,191	5,412,638	573,478	27,511,442	586,859	36,094,420	744,706	47,038,032	940,570	62,862,566	1,212,468	85,873,445	1,636,456	118,792,908
Sarangani & So. Cotabato	263,921	1,046,619	324,375	5,310,772	332,835	6,962,023	417,915	9,095,546	523,158	12,155,467	662,728	16,604,986	894,950	22,970,465
Surigao del Sur	110,517	524,095	129,793	2,653,878	131,895	3,466,237	170,527	4,554,599	218,771	6,086,887	286,243	8,314,955	392,166	11,502,472
TOTAL	1,263,445	10,356,829	1,527,418	52,841,849	1,561,684	68,897,762	1,984,834	90,005,060	2,510,321	120,284,541	3,240,455	154,314,794	4,380,002	227,304,442
XII														
Bukidnon***	140,980	912,661	175,756	4,638,888	181,327	6,070,945	216,668	7,591,396	259,843	10,599,675	318,686	14,479,694	408,966	20,030,448
Lanao del Norte	127,461	630,414	153,946	4,729,123	157,995	6,189,037	188,900	8,085,677	226,875	10,805,859	278,990	14,761,352	389,385	20,420,378
Lanao del Sur	77,245	429,349	96,766	2,182,502	103,080	2,855,994	108,232	3,731,218	113,605	4,986,473	119,419	6,811,775	126,115	9,423,053
Maguindanao	103,136	961,584	116,058	4,836,726	116,987	6,329,858	128,750	8,269,653	143,101	11,051,728	162,629	15,097,222	192,509	20,864,703
North Cotabato	259,010	1,325,886	307,274	6,739,234	313,743	8,819,684	387,182	11,522,490	478,240	15,398,884	604,557	21,035,657	801,364	29,599,622
South Cotabato***	174,513	541,638	216,927	2,753,046	222,920	3,602,931	281,497	4,707,055	353,913	6,290,602	454,004	8,583,281	602,448	11,887,494
Sultan Kudarat	246,977	863,811	281,355	4,390,592	285,764	5,745,999	341,905	7,506,870	411,658	10,032,309	508,639	13,704,672	660,074	18,958,322
TOTAL	1,129,922	5,955,343	1,349,092	50,269,911	1,381,816	39,614,449	1,653,134	51,754,360	1,967,241	69,165,549	2,446,924	94,483,654	3,157,761	130,703,220
PHILIPPINES	13,606,340	114,715,337	16,507,823	563,076,923	16,907,827	763,076,923	21,107,827	996,923,076	26,507,827	1,337,307,692	33,507,827	1,870,000,000	44,707,827	2,517,692,308

Table F-24 PROJECTED POPULATION OF LIVESTOCK & POULTRY (Low Economic Growth Scenario) (1/3)

WATER RESOURCES REGION/PROVINCE	1990*		2000		2005		2010		2015		2020		2025	
	LIVESTOCK	CHICKEN	LIVESTOCK	CHICKEN	LIVESTOCK	CHICKEN	LIVESTOCK	CHICKEN	LIVESTOCK	CHICKEN	LIVESTOCK	CHICKEN	LIVESTOCK	CHICKEN
Abra	93,063	277,200	112,697	1,353,193	114,608	1,616,999	115,341	1,871,792	127,250	2,154,327	139,959	2,435,003	150,668	2,676,526
Batangas	36,341	194,462	44,150	949,295	44,957	1,135,764	45,292	1,313,104	50,665	1,511,308	56,079	1,708,209	61,492	1,879,032
Benguet**	174,629	978,356	222,059	4,775,991	226,928	5,714,131	229,653	6,606,346	253,804	7,003,530	277,954	8,594,156	302,109	9,453,579
Ilocos Norte	137,708	1,092,714	172,483	5,334,246	176,051	6,392,044	178,105	7,378,848	196,288	8,492,291	212,470	9,596,709	229,653	10,558,588
Ilocos Sur	142,895	610,131	172,609	3,964,775	176,790	4,731,006	177,991	5,470,407	198,799	6,296,129	219,008	7,116,420	240,416	7,828,068
La Union	584,636	3,352,863	724,898	16,367,500	739,324	19,582,545	746,542	22,640,198	825,906	26,057,586	905,070	29,482,498	984,334	32,397,771
TOTAL	3,368,365	17,604,667	3,924,408	6,593,982	3,968,008	10,292,095	3,999,501	11,887,949	4,420,662	13,681,895	4,894,023	15,464,441	5,271,184	17,010,897
Batangas	338,365	1,760,467	392,408	6,593,982	396,008	10,292,095	399,501	11,887,949	442,662	13,681,895	484,023	15,464,441	527,184	17,010,897
Cagayan	79,234	394,855	98,604	1,027,543	99,996	2,306,168	99,113	2,666,257	110,583	3,068,711	122,093	3,468,518	133,523	3,815,373
Iligao	351,307	3,003,313	420,500	14,661,120	427,634	17,540,962	430,630	20,279,863	475,007	23,340,974	519,383	26,381,952	503,760	29,027,168
Isabela	85,016	224,022	98,805	1,003,597	100,238	1,308,410	100,492	1,512,708	112,537	1,741,041	124,581	1,967,873	136,626	2,164,062
Kalinga Apayao	82,614	122,170	100,381	899,290	102,220	1,063,972	102,752	1,230,102	116,392	1,415,778	129,972	1,600,233	143,582	1,760,297
Mt. Province	108,884	551,165	129,955	2,690,594	132,341	3,219,104	133,117	4,099,899	149,899	4,263,512	168,862	4,841,589	183,734	5,326,752
Nueva Vizcaya	61,175	481,343	74,847	2,349,746	76,258	2,811,305	76,797	3,250,267	86,061	3,740,874	95,325	4,226,253	104,590	4,651,062
Quirino	1,104,595	6,600,516	1,313,500	39,721,422	1,335,095	36,550,606	1,342,404	44,589,865	1,492,691	51,297,587	1,642,799	57,980,801	1,799,999	63,778,828
TOTAL	34,186	144,483	40,725	705,315	41,400	840,859	41,682	975,621	46,131	1,122,885	50,610	1,269,180	55,089	1,366,099
Aurora	38,816	327,818	46,856	1,600,292	47,687	1,914,636	47,993	2,213,590	53,540	2,547,717	59,038	2,879,646	64,636	3,167,613
Bataan	36,341	194,462	44,151	949,295	44,957	1,135,764	45,292	1,313,104	50,665	1,511,308	56,079	1,708,209	61,493	1,879,032
Benguet**	745,734	6,017,579	909,790	29,375,708	926,902	35,145,936	939,051	40,633,686	1,089,824	46,767,071	1,249,597	52,860,118	1,410,370	58,146,171
Bulacan	342,621	5,721,165	413,249	27,928,709	420,563	33,414,706	422,665	38,632,138	476,874	44,463,403	531,081	50,256,316	585,289	55,281,987
Nueva Ecija	139,082	5,974,675	163,764	29,168,260	171,850	34,895,354	172,347	40,343,977	198,756	46,433,032	225,126	52,483,237	251,515	57,791,602
Pampanga	339,901	2,772,976	427,191	13,536,695	436,133	16,195,689	441,643	18,724,513	481,486	21,550,894	521,329	24,386,006	561,173	26,794,486
Pangasinan	205,135	1,979,482	249,838	9,419,054	254,443	11,269,225	256,501	13,028,822	284,024	14,995,436	311,568	16,949,116	339,101	18,644,041
Tarlac	84,735	800,571	101,687	3,908,107	103,445	4,675,770	104,215	5,405,953	114,758	6,221,881	125,300	7,032,442	135,842	7,735,692
Zambales	1,966,651	23,883,209	2,407,261	116,589,441	2,447,380	139,490,939	2,460,370	161,271,304	2,795,049	185,614,138	3,129,778	209,796,870	3,464,508	230,776,721
TOTAL	391,666	11,743,410	469,253	57,375,021	486,008	68,646,311	497,694	79,364,869	571,065	91,344,470	644,436	103,245,281	717,807	113,569,891
Batangas	167,662	589,129	207,147	2,841,749	211,415	3,399,950	212,078	3,930,824	246,608	4,574,156	279,138	5,113,586	312,668	3,624,949
Cavite	211,027	3,849,235	256,659	18,790,614	261,475	22,491,627	261,841	25,991,949	305,570	29,915,261	349,236	33,812,770	393,027	37,194,074
Laguna	62,017	243,121	88,621	1,186,891	100,342	1,419,959	100,775	1,641,674	114,026	1,889,474	127,418	2,135,644	140,789	2,342,210
Marikina	107,361	466,336	128,682	2,276,458	130,874	2,723,669	131,990	3,148,946	143,866	3,624,259	155,742	4,096,445	167,618	4,506,093
Mindoro Occidental	92,868	568,443	114,431	1,144,411	114,441	3,320,016	115,480	3,836,410	126,240	4,417,792	137,001	4,993,864	147,762	5,492,705
Mindoro Oriental	156,200	469,434	184,132	2,291,612	196,046	2,741,750	199,597	3,169,852	224,779	3,648,646	249,560	4,123,041	275,142	4,536,009
Palaivan	288,015	2,577,368	342,999	12,581,806	348,600	15,053,232	349,882	17,403,670	394,348	23,030,639	438,814	22,640,330	483,279	24,604,381
Quezon	202,616	3,066,428	246,494	14,969,225	251,054	17,908,608	251,218	20,706,047	295,347	23,931,487	339,475	26,906,372	363,603	29,630,030
Rizal	79,865	641,768	100,335	3,132,876	102,436	3,748,263	103,585	4,333,523	114,268	4,907,640	124,952	5,637,454	135,636	6,291,204
Romblon	1,776,919	24,217,672	2,172,753	116,222,172	2,213,464	141,444,385	2,224,140	163,529,764	2,335,187	189,213,498	2,446,234	212,734,888	2,572,262	234,009,545
TOTAL	1,776,919	24,217,672	2,172,753	116,222,172	2,213,464	141,444,385	2,224,140	163,529,764	2,335,187	189,213,498	2,446,234	212,734,888	2,572,262	234,009,545

Table F-24 PROJECTED POPULATION OF LIVESTOCK & POULTRY (Low Economic Growth Scenario) (2/3)

WATER RESOURCES REGION / PROVINCE	(UNIT: head)													
	1996*		2000		2005		2010		2015		2020		2025	
	LIVESTOCK	CHICKEN	LIVESTOCK	CHICKEN	LIVESTOCK	CHICKEN	LIVESTOCK	CHICKEN	LIVESTOCK	CHICKEN	LIVESTOCK	CHICKEN	LIVESTOCK	CHICKEN
V														
Albay	178,439	687,586	208,200	3,332,145	211,488	3,966,874	212,438	4,693,160	296,776	5,304,882	261,113	5,936,079	285,451	6,595,636
Camarines Norte	170,732	346,259	118,664	1,690,315	120,522	2,022,341	121,015	2,338,113	135,164	2,691,036	149,313	3,041,637	163,461	3,245,803
Camarines Sur	270,795	1,705,995	320,988	8,342,714	326,186	9,981,461	327,667	11,339,984	366,310	13,281,868	404,953	15,012,296	443,585	16,513,537
Catanduanes	55,113	185,031	63,960	908,138	64,880	1,086,522	65,034	1,296,174	72,841	1,445,785	80,647	1,634,149	88,453	1,797,565
Catanduanes	170,841	935,323	206,712	4,565,919	210,385	5,462,795	212,403	6,315,766	290,961	7,269,069	249,519	8,216,142	268,077	9,037,763
Masbate	134,284	478,557	161,733	7,336,147	164,570	2,795,032	165,564	3,231,455	184,977	3,719,222	204,390	4,203,780	273,803	4,624,162
Sorsogon	908,304	4,337,751	1,080,257	21,175,377	1,098,031	25,334,827	1,104,122	29,260,652	1,227,029	33,711,827	1,345,935	38,104,033	1,477,840	41,914,466
TOTAL														
VI														
Aklan	96,539	744,965	118,836	3,636,658	121,141	4,351,001	121,934	5,030,374	137,840	5,789,676	153,745	6,543,983	169,651	7,198,397
Antique	124,124	898,927	154,225	4,388,222	157,314	5,250,194	159,096	6,069,968	173,936	6,980,190	189,775	7,996,385	203,615	8,686,030
Cebu	118,533	823,313	139,680	4,019,125	141,871	4,806,596	142,477	5,589,419	158,925	6,398,576	175,373	7,232,214	191,821	7,955,442
Iloilo & Guimaras	415,932	4,936,615	501,278	24,096,821	510,087	28,832,518	513,476	33,334,479	571,069	38,266,098	623,663	42,364,624	656,256	47,791,121
Negros Occ.***	384,328	3,950,843	459,811	19,335,494	467,629	23,133,537	469,832	26,745,649	528,178	30,782,728	586,623	34,793,254	644,869	36,272,507
Negros Cr.***	1,189,456	11,364,668	1,373,831	55,478,319	1,388,042	66,375,846	1,406,816	76,739,890	1,589,948	86,329,267	1,733,079	96,830,461	1,896,212	109,813,587
TOTAL														
VII														
Bohol	326,884	2,192,684	404,292	10,703,913	412,270	12,806,468	415,715	14,806,093	455,555	17,940,974	513,277	19,261,157	562,069	21,137,288
Cebu	455,992	4,753,485	574,690	23,204,845	585,921	21,762,939	592,270	32,097,894	666,444	36,942,859	740,619	41,755,958	814,793	45,931,587
Negros Occ.***	344,463	1,671,352	433,715	8,158,954	442,906	9,761,605	447,101	11,285,800	501,204	12,889,316	555,427	14,681,629	609,590	16,149,804
Negros Cr.***	59,755	351,604	76,570	1,716,407	79,302	2,053,559	79,067	2,374,205	89,511	2,732,576	98,955	3,089,589	110,399	3,397,450
Siquijor	1,187,094	8,969,125	1,469,267	43,784,119	1,520,400	52,384,571	1,534,132	60,563,992	1,712,774	69,705,725	1,808,278	78,787,333	2,096,841	86,666,129
TOTAL														
VIII														
Bulacan & Northern Leyte	542,576	3,065,361	645,792	14,964,016	656,544	17,903,377	657,676	20,698,842	755,011	23,823,195	852,247	26,928,969	949,622	29,619,720
Southern Leyte	93,160	530,138	112,428	2,587,948	114,429	3,096,294	114,826	3,579,755	131,267	4,120,096	147,707	4,656,882	164,148	5,122,574
Eastern Samar	79,414	413,462	91,845	2,018,376	93,143	2,414,843	93,214	2,791,901	105,546	3,213,320	117,878	3,631,967	130,210	3,995,167
Northern Samar	103,416	296,050	122,156	1,445,212	124,103	1,729,093	124,450	1,999,077	140,806	2,300,824	157,163	2,600,587	173,520	2,860,648
Western Samar	100,538	334,376	116,886	1,636,305	118,593	1,932,938	118,648	2,257,873	135,222	2,598,684	151,796	2,937,253	166,370	3,230,981
TOTAL	919,104	4,539,287	1,089,107	22,647,858	1,106,812	27,096,545	1,108,813	31,327,448	1,267,852	36,058,119	1,426,691	40,753,689	1,585,930	44,829,090
IX														
Basian	21,778	229,435	25,776	1,120,026	26,192	1,340,031	26,252	1,549,266	29,870	1,783,117	33,489	2,015,431	37,107	2,216,975
Misamis Occ.	171,104	1,692,975	215,556	7,727,289	220,132	9,245,149	222,264	10,688,703	248,839	12,302,092	275,414	13,904,870	301,990	15,295,368
Sulu	14,910	408,522	21,746	1,994,261	22,439	2,385,991	23,110	2,758,544	23,995	3,174,928	24,880	3,588,573	25,764	3,947,433
Tawi-Tawi	2,898	64,489	4,073	314,813	4,192	376,651	4,295	435,462	4,559	501,192	4,822	566,490	5,085	623,139
Zamboanga Norte	237,663	1,671,974	280,744	8,161,900	285,210	9,765,238	286,362	11,290,000	320,650	12,994,151	354,839	14,687,093	389,227	16,155,814
Zamboanga Sur	496,311	2,826,643	600,421	13,796,679	610,983	16,509,133	614,378	19,066,899	689,445	21,867,940	764,513	24,800,032	839,580	27,313,055
TOTAL	946,564	5,783,990	1,148,316	33,117,957	1,169,148	39,622,194	1,176,661	45,808,874	1,317,358	52,723,420	1,458,057	59,592,489	1,598,753	65,551,785

Table F-24 PROJECTED POPULATION OF LIVESTOCK & POULTRY (Low Economic Growth Scenario) (3/3)

(UNIT: head)

WATER RESOURCES	1996*		2000		2005		2010		2015		2020		2025	
	LIVESTOCK	CHICKEN	LIVESTOCK	CHICKEN	LIVESTOCK	CHICKEN	LIVESTOCK	CHICKEN	LIVESTOCK	CHICKEN	LIVESTOCK	CHICKEN	LIVESTOCK	CHICKEN
X														
Agusan Norte	146,888	845,988	174,843	4,120,719	177,753	4,840,814	178,132	5,712,397	203,817	6,574,645	229,501	7,431,222	255,185	8,174,351
Agusan Sur	88,880	470,690	104,424	2,297,787	106,044	2,749,138	106,255	3,178,394	120,559	3,658,151	134,862	4,134,753	149,166	4,548,232
Bukidnon***	140,980	912,661	175,786	4,456,291	179,325	5,330,437	181,327	6,162,741	198,988	7,092,966	216,688	8,017,073	234,339	8,818,786
Camiguin	23,550	255,428	29,741	1,251,791	30,381	1,497,679	30,629	1,731,529	34,782	1,987,892	38,825	2,252,536	43,089	2,477,792
Misamis Oriental	184,027	1,510,144	255,211	7,371,990	261,480	8,820,063	265,305	10,197,243	295,573	11,736,450	321,841	13,265,532	350,110	14,592,096
Surigao del Norte**	82,945	258,085	97,148	1,259,880	98,630	1,507,357	98,709	1,742,718	112,818	2,005,770	126,827	2,267,092	141,056	2,493,803
TOTAL	677,250	4,253,085	837,123	20,766,461	853,613	24,845,588	860,358	28,725,022	964,547	33,060,874	1,068,734	37,368,209	1,172,975	41,105,059
XI														
Davao del Norte**	266,558	2,441,474	319,487	11,918,419	324,984	14,259,537	326,069	16,480,047	371,274	18,974,505	416,479	21,446,599	461,653	23,589,170
Davao del Oriental	150,298	932,002	180,285	4,549,707	183,400	5,443,399	184,025	6,293,341	209,616	7,243,279	235,207	8,186,969	260,798	9,005,673
Davao del Sur	472,191	5,412,638	573,478	26,422,598	583,970	31,612,752	588,859	36,548,823	665,783	42,065,626	744,706	47,546,145	873,629	52,300,797
Sarangani & So. Cotabato	263,921	1,046,619	324,375	5,109,227	330,822	6,112,825	332,835	7,067,292	375,375	8,134,053	417,915	9,193,798	460,455	10,113,185
Surigao del Sur	110,517	524,095	128,793	2,558,448	131,806	3,061,000	131,895	3,538,950	151,211	4,073,131	170,527	4,603,799	189,842	5,064,182
TOTAL	1,283,445	10,356,828	1,527,418	50,538,388	1,554,785	60,982,512	1,561,684	68,934,453	1,773,259	80,490,595	1,984,834	90,977,310	2,196,407	100,075,113
XII														
Bukidnon**	140,980	912,661	175,786	4,456,291	179,325	5,330,437	181,327	6,162,741	198,988	7,092,966	216,688	8,017,073	234,339	8,818,786
Lanao del Norte	127,461	930,414	153,696	4,541,954	156,683	5,434,124	157,935	6,282,618	173,448	7,230,938	188,800	8,173,020	204,352	9,990,378
Lanao del Sur	77,245	429,349	98,786	2,095,931	100,945	2,507,632	103,080	2,899,178	105,656	3,336,790	108,232	3,771,523	110,808	4,148,678
Misquindano	103,136	951,584	115,058	4,645,299	116,281	5,557,768	116,987	6,425,568	122,868	7,395,465	128,750	8,358,983	134,632	9,194,899
North Cotabato	299,010	1,325,886	367,274	6,472,510	312,271	7,749,896	313,745	8,963,042	350,463	10,304,444	387,182	11,846,958	423,902	12,811,663
South Cotabato***	174,513	541,638	216,927	2,644,087	221,307	3,163,461	222,920	3,667,409	252,209	4,209,471	281,497	4,757,902	310,786	5,233,695
Sultan Kudarat	246,977	863,811	281,335	4,216,822	284,921	5,045,126	285,764	5,832,881	313,834	6,713,316	341,905	7,587,960	368,975	8,346,762
TOTAL	1,129,327	5,955,343	1,349,092	29,811,894	1,371,723	34,782,444	1,381,816	40,213,437	1,517,476	46,283,389	1,653,134	50,313,419	1,788,784	57,544,803
PHILIPPINES	13,606,340	114,715,337	16,507,823	560,000,000	16,807,827	670,000,000	16,907,827	774,615,000	18,998,886	891,538,000	21,107,823	1,007,692,000	23,207,625	1,106,462,000

Table F-25 WATER DEMAND FOR LIVESTOCK & POULTRY (High Economic Growth Scenario) (1/2)

(UNIT: MCM)

WATER RESOURCES REGION/PROVINCE	1996		2000		2005		2010		2015		2020		2025		TOTAL
	LIVESTOCK	CHICKEN	TOTAL	LIVESTOCK	CHICKEN	TOTAL	LIVESTOCK	CHICKEN	TOTAL	LIVESTOCK	CHICKEN	TOTAL	LIVESTOCK	CHICKEN	
I															
Abra	0.70	0.01	0.71	0.85	0.05	0.91	0.87	0.09	1.14	1.27	0.12	1.39	1.57	0.17	1.74
Banguet***	0.78	0.01	0.79	0.33	0.04	0.37	0.34	0.05	0.49	0.53	0.09	0.62	0.78	0.12	0.90
Ilocos Norte	1.32	0.04	1.36	1.68	0.19	1.87	1.74	0.25	2.43	2.43	0.43	2.98	3.16	0.59	3.75
Ilocos Sur	1.04	0.04	1.08	1.31	0.21	1.52	1.35	0.28	1.97	1.93	0.48	2.41	2.36	0.66	3.01
La Union	1.08	0.03	1.11	1.31	0.16	1.47	1.35	0.20	1.55	1.53	0.36	2.41	2.39	0.38	3.42
TOTAL	4.97	0.13	5.10	6.49	0.64	7.13	6.65	1.10	7.93	8.32	1.47	9.80	10.34	2.01	12.35
II															
Batanes	0.00	0.00	0.00	0.00	0.00	0.00	0.00	0.00	0.00	0.00	0.00	0.00	0.00	0.00	0.00
Capayan	2.56	0.07	2.63	2.97	0.34	3.31	3.07	0.58	4.25	4.47	0.77	5.24	5.58	1.06	6.64
Iligao	0.00	0.01	0.01	0.73	0.08	0.81	0.75	0.10	1.05	1.14	0.17	1.31	1.43	0.24	1.67
Isabela	2.68	0.11	2.77	3.18	0.58	3.76	3.26	0.76	4.02	4.70	1.32	6.08	5.90	1.80	7.70
Kalinga Apayao	0.64	0.01	0.65	0.75	0.04	0.79	0.76	0.05	1.02	1.17	0.10	1.27	1.49	0.13	1.62
Mt. Province	0.63	0.01	0.63	0.76	0.04	0.79	0.78	0.05	1.04	1.24	0.08	1.32	1.50	0.11	1.70
Nueva Vizcaya	0.81	0.02	0.83	0.98	0.11	1.09	1.01	0.14	1.44	1.58	0.24	1.82	2.02	0.33	2.35
Quirino	0.46	0.02	0.48	0.57	0.09	0.66	0.58	0.12	0.70	0.88	0.21	1.11	1.13	0.29	1.42
TOTAL	8.36	0.25	8.61	9.94	1.27	11.21	10.16	1.68	11.82	15.25	2.90	18.15	19.14	3.96	23.11
III															
Aurora	0.26	0.01	0.26	0.31	0.03	0.34	0.32	0.04	0.35	0.47	0.06	0.53	0.58	0.09	0.67
Bataan	0.29	0.01	0.31	0.35	0.06	0.42	0.36	0.08	0.45	0.55	0.14	0.70	0.69	0.20	0.89
Benguet***	0.28	0.01	0.29	0.33	0.04	0.37	0.34	0.05	0.39	0.53	0.09	0.61	0.67	0.12	0.78
Bulacan	5.64	0.23	5.87	6.99	1.16	8.15	7.02	1.51	8.54	12.50	2.64	15.14	16.74	3.61	20.35
Nueva Ecija	2.59	0.22	2.81	3.13	1.10	4.23	3.20	1.44	4.64	5.04	2.51	7.55	6.45	3.43	9.88
Pampanga	1.05	0.23	1.28	1.28	1.15	2.43	1.30	1.50	2.81	2.20	2.63	4.83	2.89	3.68	6.48
Pangasinan	2.57	0.10	2.68	3.23	0.53	3.77	3.34	0.70	4.04	4.68	1.22	5.90	5.67	1.66	7.34
Tarlac	1.55	0.07	1.63	1.89	0.37	2.26	1.94	0.49	2.43	2.87	0.85	3.72	3.58	1.16	4.74
Zambales	0.64	0.03	0.67	0.77	0.15	0.92	0.79	0.20	0.99	1.14	0.35	1.50	1.42	0.48	1.90
TOTAL	14.88	0.90	15.79	18.38	4.59	22.78	18.69	7.95	31.54	39.97	10.50	40.47	38.69	14.34	53.03
IV															
Batangas	2.96	0.44	3.40	3.67	2.26	5.93	3.77	2.95	6.73	6.26	5.17	11.42	8.17	7.06	15.23
Cavite	1.27	0.02	1.29	1.57	0.11	1.68	1.61	0.15	1.76	2.74	0.26	3.00	3.62	0.36	3.97
Laguna	1.60	0.15	1.74	1.94	0.74	2.68	1.98	0.97	2.95	3.47	1.89	5.16	4.62	2.31	6.93
Marikina	0.62	0.01	0.63	0.75	0.05	0.79	0.76	0.06	0.82	1.04	0.11	1.32	1.56	0.15	1.71
Mindoro Occidental	0.81	0.02	0.83	0.97	0.09	1.05	1.00	0.12	1.12	1.24	0.20	1.60	1.70	0.28	1.98
Mindoro Oriental	0.70	0.02	0.72	0.85	0.11	0.90	0.87	0.14	1.02	1.24	0.25	1.49	1.51	0.34	1.85
Palaivan	1.18	0.10	1.28	1.47	0.09	1.56	1.51	0.12	1.63	2.26	0.25	2.57	3.01	0.28	3.29
Quezon	2.19	0.10	2.28	2.60	0.50	3.09	2.65	0.85	3.50	4.16	1.13	5.29	5.32	1.55	6.87
Rizal	1.54	0.12	1.65	1.87	0.59	2.46	1.90	0.77	2.67	3.40	1.35	4.75	4.57	1.64	6.41
Romblon	0.60	0.02	0.63	0.76	0.12	0.88	0.78	0.16	0.95	1.14	0.28	1.43	1.41	0.39	1.80
TOTAL	13.47	0.99	14.39	16.44	4.66	21.10	16.83	8.10	22.93	27.39	10.64	38.03	35.51	14.54	50.05
V															
Abay	1.34	0.03	1.36	1.56	0.13	1.71	1.61	0.17	1.78	2.43	0.30	2.73	3.07	0.41	3.48
Camarines Norte	0.76	0.01	0.78	0.90	0.07	0.96	0.92	0.09	1.00	1.40	0.15	1.55	1.77	0.21	1.97
Camarines Sur	2.06	0.06	2.11	2.43	0.33	2.76	2.48	0.43	3.63	3.79	0.75	4.54	4.80	1.03	5.82
Catanduanes	0.42	0.01	0.42	0.48	0.04	0.52	0.49	0.05	0.54	0.76	0.08	0.84	0.96	0.11	1.04
Masbate	1.39	0.04	1.33	1.56	0.18	1.74	1.61	0.24	1.84	2.23	0.41	2.64	2.70	0.56	3.26
Sorsogon	1.02	0.02	1.03	1.22	0.09	1.32	1.25	0.12	1.37	1.91	0.21	2.12	2.41	0.29	2.70
TOTAL	6.87	0.16	7.04	8.18	0.83	9.01	8.36	1.06	9.45	11.64	1.91	14.43	15.71	2.60	16.31
VI															
Adian	0.73	0.03	0.76	0.90	0.14	1.04	0.92	0.19	1.11	1.46	0.33	1.79	1.87	0.45	2.32
Antique	0.94	0.03	0.97	1.17	0.17	1.34	1.20	0.23	1.43	1.70	0.40	2.10	2.08	0.54	2.62
Capiz	0.90	0.03	0.93	1.06	0.16	1.22	1.08	0.21	1.29	1.64	0.36	2.00	2.07	0.49	2.56
Iloilo & Guimaras	3.15	0.19	3.33	3.79	0.95	4.74	3.89	1.24	5.13	5.84	2.17	8.00	7.32	2.96	10.29
Negros Occ***	2.91	0.15	3.06	3.48	0.76	4.24	3.56	1.00	4.44	5.53	1.74	7.28	7.06	2.38	9.43
Negros Or***	0.62	0.43	0.95	1.04	0.19	1.25	1.06	0.24	1.30	1.67	0.49	2.17	2.03	0.82	2.95
TOTAL	8.62	0.43	9.05	10.40	2.19	12.58	10.65	2.86	13.51	16.17	4.99	21.17	20.39	8.82	27.22

Table F-25 WATER DEMAND FOR LIVESTOCK & POULTRY (High Economic Growth Scenario) (2/2)

WATER RESOURCES REGION/PROVINCE	1996		2000		2005		2010		2015		2020		2025		TOTAL
	LIVESTOCK	CHICKEN	TOTAL	LIVESTOCK	CHICKEN	TOTAL	LIVESTOCK	CHICKEN	TOTAL	LIVESTOCK	CHICKEN	TOTAL	LIVESTOCK	CHICKEN	
VII															
Bohol	2.47	0.08	2.56	3.06	0.42	3.48	3.15	3.70	3.88	4.79	0.96	5.76	6.05	1.32	7.36
Cebu	3.45	0.18	3.63	4.35	0.91	5.26	4.48	5.68	5.61	6.99	2.09	7.93	8.69	2.85	11.54
Negros Occ.***	2.81	0.06	2.87	3.28	0.32	3.60	3.38	3.80	4.20	5.21	0.73	5.95	6.60	1.00	7.60
Negros Or.***	0.45	0.01	0.47	0.55	0.07	0.62	0.60	0.69	0.76	0.95	0.15	1.11	1.22	0.21	1.43
Siquior	8.98	0.34	9.32	11.27	1.73	13.00	11.61	13.87	14.45	17.95	3.84	21.89	22.76	5.39	28.15
TOTAL	20.98	0.66	21.64	25.61	3.43	29.04	26.99	31.54	33.87	41.85	7.81	49.66	53.52	10.56	64.08
VIII															
Biliran & Northern Ley	4.11	0.12	4.23	4.99	0.59	5.48	4.98	5.75	6.45	7.46	1.35	8.81	9.85	1.84	10.69
Southern Leyte	0.71	0.02	0.73	0.85	0.10	0.95	0.87	1.00	1.12	1.29	0.23	1.52	1.66	0.32	1.98
Eastern Samar	0.60	0.02	0.62	0.70	0.08	0.78	0.71	0.81	0.89	1.03	0.18	1.31	1.45	0.25	1.70
Northern Samar	0.78	0.01	0.79	0.92	0.06	0.98	0.94	1.02	1.19	1.29	0.13	1.63	1.73	0.18	2.10
Western Samar	0.76	0.01	0.77	0.88	0.06	0.95	0.90	0.98	1.15	1.26	0.15	1.61	1.70	0.20	2.10
TOTAL	6.96	0.18	7.13	8.24	0.89	9.14	8.39	9.56	10.62	12.33	2.04	14.37	15.84	2.79	17.63
IX															
Basilan	0.16	0.01	0.17	0.20	0.04	0.24	0.20	0.26	0.25	0.32	0.10	0.42	0.42	0.14	0.55
Misamis Occ.	1.30	0.06	1.35	1.63	0.30	1.94	1.66	2.08	2.06	2.52	0.40	3.28	3.26	0.86	4.21
Sulu	0.11	0.02	0.13	0.16	0.03	0.24	0.17	0.10	0.19	0.32	0.16	0.38	0.22	0.25	0.46
Tawi-Tawi	0.02	0.00	0.02	0.03	0.01	0.04	0.03	0.05	0.04	0.05	0.03	0.07	0.05	0.04	0.09
Zamboanga Norte	1.80	0.06	1.86	2.12	0.32	2.45	2.17	2.59	2.69	3.33	0.73	4.07	4.23	1.00	5.23
Zamboanga Sur	3.77	0.11	3.88	4.54	0.54	5.09	4.65	5.36	5.79	7.19	1.24	8.44	9.14	1.70	10.84
TOTAL	7.16	0.26	7.42	8.69	1.30	10.00	8.91	10.91	11.04	13.27	2.98	16.25	17.31	4.07	20.38
X															
Agusan Norte	1.11	0.03	1.14	1.32	0.16	1.49	1.35	1.56	1.74	2.22	0.37	2.59	2.90	0.51	3.41
Agusan Sur	0.67	0.02	0.69	0.79	0.09	0.88	0.80	0.92	1.02	1.18	0.21	1.50	1.67	0.28	2.26
Bukidnon**	1.07	0.03	1.10	1.33	0.18	1.51	1.37	1.60	1.64	1.94	0.40	2.37	2.41	0.59	2.96
Carigunt	0.18	0.01	0.19	0.23	0.05	0.27	0.23	0.30	0.29	0.38	0.11	0.49	0.48	0.15	0.63
Misamis Oriental	1.47	0.06	1.53	1.93	0.29	2.22	2.01	2.39	2.44	2.93	0.66	3.62	3.66	0.91	4.57
Davao del Norte***	0.63	0.01	0.64	0.74	0.05	0.79	0.75	0.81	0.96	1.05	0.11	1.34	1.60	0.15	1.76
TOTAL	5.13	0.16	5.29	6.34	0.82	7.16	6.51	7.58	8.09	10.03	1.87	11.90	12.72	2.55	15.27
XI															
Davao del Norte***	2.02	0.09	2.11	2.42	0.47	2.89	2.47	3.08	3.15	3.96	1.07	5.06	5.19	1.47	6.65
Davao del Oriental	1.14	0.04	1.17	1.36	0.18	1.54	1.39	1.63	1.78	2.09	0.41	2.67	2.93	0.56	3.49
Davao del Sur	3.57	0.20	3.78	4.34	1.04	5.38	4.44	5.80	5.64	7.42	2.38	9.50	9.18	3.25	12.43
Sarangani & So. Coti	2.00	0.04	2.04	2.46	0.20	2.66	2.52	2.78	3.16	3.51	0.46	4.42	5.06	0.63	5.69
Surigao del Sur	0.84	0.02	0.86	0.98	0.10	1.08	1.00	1.13	1.29	1.46	0.23	1.89	2.17	0.31	2.48
TOTAL	9.56	0.39	9.95	11.56	1.99	13.55	11.82	14.43	15.02	18.43	4.55	23.55	24.53	6.22	30.74
XII															
Quezon***	1.07	0.03	1.10	1.33	0.18	1.51	1.37	1.60	1.64	1.94	0.40	2.37	2.41	0.55	2.96
Lenao del Norte	0.96	0.04	1.00	1.17	0.18	1.34	1.20	1.43	1.43	1.74	0.31	2.13	2.11	0.56	2.67
Lenao del Sur	0.58	0.02	0.60	0.75	0.06	0.83	0.78	0.91	0.96	1.14	0.26	1.36	1.36	0.36	1.72
Maguindanao	0.78	0.04	0.82	0.87	0.16	1.05	0.89	1.12	0.97	1.08	0.42	1.50	1.23	0.57	1.80
North Cotabato	1.98	0.05	2.01	2.33	0.26	2.58	2.37	2.71	2.93	3.37	0.68	4.20	4.58	0.80	5.37
South Cotabato***	1.32	0.02	1.34	1.64	0.10	1.75	1.69	1.82	2.13	2.31	0.38	2.92	3.44	0.33	3.76
Sultan Kudarat	1.87	0.03	1.90	2.13	0.17	2.30	2.16	2.38	2.59	2.87	0.24	3.50	3.85	0.52	4.37
TOTAL	8.55	0.23	8.77	10.21	1.15	11.36	10.46	11.96	12.51	14.47	2.62	17.65	18.52	3.58	22.10
PHILIPPINES	102.98	4.34	107.32	124.94	22.07	147.01	127.97	156.85	159.76	194.45	49.11	243.53	253.61	68.87	312.48

Table F-26 WATER DEMAND FOR LIVESTOCK & POULTRY (Low Economic Growth Scenario) (1/2)

(UNIT: MCM)

WATER RESOURCES REGION/PROVINCE	1995		2000		2005		2010		2015		2020		2025		
	LIVESTOCK	CHICKEN	TOTAL	LIVESTOCK	CHICKEN	TOTAL	LIVESTOCK	CHICKEN	TOTAL	LIVESTOCK	CHICKEN	TOTAL	LIVESTOCK	CHICKEN	TOTAL
I															
Abra	0.70	0.01	0.71	0.85	0.05	0.90	0.87	0.06	0.93	0.87	0.07	0.94	0.98	0.09	1.07
Banguiat***	0.78	0.01	0.79	0.93	0.04	0.97	0.94	0.06	1.00	0.96	0.04	1.00	1.04	0.06	1.10
Ilocos Norte	1.32	0.04	1.36	1.68	0.18	1.86	1.72	0.27	1.99	1.92	0.29	2.21	2.21	0.33	2.54
Ilocos Sur	1.04	0.04	1.08	1.31	0.20	1.51	1.33	0.24	1.57	1.35	0.28	1.63	1.80	0.32	2.12
La Union	1.08	0.13	1.21	1.31	0.15	1.46	1.34	0.18	1.52	1.35	0.21	1.56	1.74	0.27	2.01
TOTAL	4.42	0.23	4.65	5.49	0.62	6.11	5.60	0.74	6.34	5.65	0.86	6.51	7.24	1.11	8.35
II															
Batanes	0.00	0.00	0.00	0.00	0.00	0.00	0.00	0.00	0.00	0.00	0.00	0.00	0.00	0.00	0.00
Cagayan	2.56	0.07	2.63	2.97	0.33	3.30	3.01	0.06	3.07	3.02	0.45	3.47	3.86	0.52	4.38
Iligan	0.60	0.01	0.61	0.73	0.07	0.80	0.74	0.09	0.83	0.63	0.10	0.73	0.95	0.13	1.08
Isabela	2.66	0.11	2.77	3.13	0.55	3.74	3.24	0.66	3.90	3.26	0.77	4.03	4.48	0.90	5.38
Kalinga Apayao	0.64	0.01	0.65	0.75	0.04	0.79	0.76	0.06	0.81	0.76	0.05	0.82	0.85	0.07	0.92
Mt. Province	0.63	0.01	0.63	0.76	0.03	0.79	0.77	0.04	0.81	0.78	0.05	0.82	0.85	0.05	0.90
Nueva Vizcaya	0.81	0.02	0.83	0.96	0.10	1.09	1.00	0.12	1.12	1.01	0.14	1.15	1.30	0.18	1.48
Quirino	0.46	0.02	0.48	0.57	0.09	0.66	0.56	0.11	0.68	0.58	0.12	0.70	0.84	0.16	0.99
TOTAL	8.36	0.25	8.61	9.94	1.22	11.16	10.10	1.46	11.56	10.16	1.69	11.85	13.24	2.19	15.43
III															
Aurora	0.26	0.01	0.26	0.31	0.03	0.33	0.31	0.03	0.35	0.32	0.04	0.35	0.39	0.05	0.44
Bataan	0.29	0.01	0.31	0.35	0.06	0.42	0.36	0.06	0.43	0.36	0.08	0.45	0.50	0.11	0.56
Benguet***	0.28	0.01	0.28	0.33	0.04	0.37	0.34	0.04	0.38	0.34	0.05	0.39	0.44	0.06	0.49
Bulacan	5.64	0.23	5.87	6.89	1.11	8.00	7.02	1.33	8.35	7.02	1.54	8.56	10.01	2.00	12.01
Nueva Ecija	2.59	0.22	2.81	3.13	1.05	4.18	3.18	1.26	4.45	3.20	1.46	4.66	5.29	1.00	6.29
Pampanga	1.05	0.23	1.28	1.28	1.10	2.38	1.30	1.32	2.62	1.30	1.53	2.83	3.26	1.70	4.99
Pangasinan	2.57	0.10	2.68	3.23	0.51	3.75	3.30	0.61	3.91	3.34	0.71	4.05	4.46	0.82	5.26
Tarlac	1.55	0.07	1.63	1.89	0.36	2.25	1.93	0.43	2.35	1.94	0.49	2.43	2.72	0.64	3.37
Zambales	0.64	0.03	0.67	0.77	0.15	0.92	0.78	0.18	0.96	0.70	0.20	0.99	1.10	0.27	1.32
TOTAL	14.88	0.90	15.79	18.18	4.41	22.59	18.52	6.10	24.72	21.15	7.02	28.18	31.63	7.94	36.57
IV															
Batangas	2.96	0.44	3.40	3.67	2.17	5.84	3.75	2.80	6.34	3.77	3.00	6.77	7.78	4.88	12.66
Cavite	1.27	0.02	1.29	1.57	0.11	1.68	1.60	0.13	1.73	1.61	0.15	1.75	2.03	0.21	2.26
Laguna	1.80	0.15	1.94	1.94	0.71	2.65	1.98	0.85	2.83	1.98	0.98	2.97	3.44	1.28	4.72
Manila	0.62	0.01	0.63	0.75	0.04	0.79	0.76	0.06	0.81	0.76	0.05	0.82	0.94	0.08	1.02
Manila Occidental	0.81	0.02	0.83	0.97	0.09	1.06	0.99	0.10	1.09	1.00	0.12	1.12	1.23	0.16	1.39
Manila Oriental	0.70	0.02	0.72	0.85	0.11	0.96	0.87	0.13	0.90	0.87	0.15	1.02	1.12	0.19	1.31
Palawan	1.18	0.10	1.28	1.47	0.09	1.56	1.50	0.10	1.60	1.51	0.12	1.63	1.84	0.16	2.00
Quezon	2.19	0.10	2.28	2.60	0.48	3.07	2.64	0.68	3.21	2.65	0.66	3.31	3.74	0.86	4.60
Rizal	1.54	0.12	1.66	1.87	0.57	2.43	1.90	0.78	2.68	2.24	0.90	3.14	3.59	1.02	4.61
Romblon	0.60	0.02	0.63	0.76	0.12	0.88	0.78	0.14	0.92	0.78	0.16	0.95	1.05	0.21	1.26
TOTAL	13.47	0.92	14.39	16.44	4.47	20.92	16.75	5.35	22.11	16.83	6.19	23.02	26.31	8.05	34.36
V															
Albay	1.34	0.03	1.36	1.58	0.10	1.70	1.60	0.15	1.75	1.61	0.17	1.78	1.99	0.23	2.21
Camarinon Norte	0.76	0.01	0.78	0.90	0.06	0.96	0.91	0.08	0.99	0.93	0.09	1.00	1.12	0.12	1.24
Camarinon Sur	2.05	0.06	2.11	2.43	0.32	2.75	2.47	0.38	2.85	2.48	0.44	2.92	3.28	0.57	3.85
Compostela	0.42	0.01	0.42	0.48	0.04	0.52	0.49	0.04	0.53	0.49	0.05	0.54	0.61	0.06	0.67
Marikina	1.29	0.04	1.33	1.56	0.11	1.74	1.59	0.21	1.80	1.61	0.24	1.85	2.02	0.28	2.33
Sorsogon	1.02	0.02	1.03	1.22	0.09	1.31	1.25	0.11	1.35	1.25	0.14	1.38	1.54	0.16	1.70
TOTAL	6.87	0.16	7.04	8.18	0.80	8.98	8.31	1.11	9.47	8.36	1.11	9.47	10.56	1.44	12.00
VI															
Aklan	0.73	0.03	0.76	0.90	0.14	1.04	0.92	0.16	1.08	0.92	0.19	1.11	1.26	0.25	1.51
Antique	0.94	0.03	0.97	1.17	0.13	1.33	1.19	0.20	1.39	1.20	0.23	1.43	1.58	0.30	1.87
Capiz	0.90	0.03	0.93	1.06	0.15	1.21	1.07	0.18	1.26	1.08	0.21	1.29	1.44	0.27	1.71
Iloilo & Guimaras	3.15	0.19	3.33	3.79	0.91	4.71	3.66	1.09	4.95	3.89	1.26	5.15	5.77	1.64	7.41
Negros Occ***	2.91	0.15	3.06	3.48	0.73	4.21	3.54	0.88	4.41	3.56	1.01	4.57	5.16	1.32	6.53
Negros Ori***	8.62	0.43	9.05	10.40	2.10	12.50	10.58	2.51	13.09	10.85	2.90	13.55	15.22	3.78	19.03
TOTAL	31.51	1.51	33.02	37.51	9.54	47.05	40.51	11.88	52.39	43.34	13.94	57.33	65.89	14.35	80.24

Table F-26 WATER DEMAND FOR LIVESTOCK & POULTRY (Low Economic Growth Scenario) (2/2)

(UNIT: MCM)

WATER RESOURCES REGION/PROVINCE	1995		2000		2005		2010		2015		2020		TOTAL
	LIVESTOCK	CHICKEN	TOTAL LIVESTOCK	CHICKEN	TOTAL LIVESTOCK	CHICKEN	TOTAL LIVESTOCK	CHICKEN	TOTAL LIVESTOCK	CHICKEN	TOTAL LIVESTOCK	CHICKEN	
VII													
Bohol	2.47	0.08	2.56	3.06	3.47	3.12	4.44	3.15	3.60	3.45	4.09	3.88	4.61
Cebu	3.45	0.18	3.63	4.35	5.23	4.44	1.05	4.46	5.49	5.04	6.44	1.58	7.19
Negros Occ.***	2.61	0.06	2.67	3.28	3.31	3.35	0.37	3.72	3.72	3.79	4.79	4.20	4.75
Negros Ori.***	0.45	0.01	0.47	0.58	0.64	0.59	0.08	0.60	0.69	0.68	0.78	0.76	0.87
Siquior	8.98	0.34	9.32	11.27	12.93	11.51	1.98	13.49	13.99	12.96	15.60	14.45	17.43
TOTAL	21.57	0.75	22.32	27.24	27.90	25.22	2.49	30.38	32.51	30.77	36.60	33.67	40.48
VIII													
Basilan & Northern Leyte	4.11	0.12	4.23	4.89	5.57	4.97	0.68	5.65	5.76	5.71	6.62	6.45	7.47
Southern Leyte	0.71	0.02	0.73	0.85	1.00	0.95	0.05	0.98	1.00	0.99	1.15	1.12	1.29
Eastern Samar	0.60	0.02	0.62	0.70	0.82	0.77	0.05	0.80	0.81	0.80	0.92	0.89	1.03
Northern Samar	0.78	0.01	0.79	0.92	1.05	0.96	0.09	1.00	1.02	1.07	1.15	1.19	1.31
Western Samar	0.76	0.01	0.77	0.88	1.00	0.95	0.05	0.97	0.98	1.02	1.12	1.15	1.26
TOTAL	6.96	0.18	7.13	8.24	9.26	8.24	1.03	9.40	9.58	9.60	10.96	10.84	12.32
IX													
Basilan	0.16	0.01	0.17	0.20	0.24	0.20	0.05	0.25	0.26	0.23	0.29	0.25	0.33
Misamis Occ.	1.30	0.06	1.35	1.63	2.29	1.67	0.35	2.02	2.08	1.88	2.35	2.08	2.61
Culu	0.11	0.02	0.13	0.16	0.24	0.17	0.09	0.26	0.28	0.18	0.30	0.19	0.32
Tawi-Tawi	0.02	0.00	0.02	0.03	0.04	0.03	0.01	0.05	0.05	0.03	0.05	0.02	0.06
Zamboanga Norte	1.80	0.06	1.86	2.12	3.31	2.43	0.37	2.53	2.59	2.43	2.82	2.69	3.24
Zamboanga Sur	3.77	0.11	3.88	4.54	5.52	5.07	0.62	5.25	5.37	5.22	6.05	5.79	6.73
TOTAL	7.16	0.26	7.42	8.69	12.5	8.85	1.50	10.35	10.64	9.97	11.97	11.04	13.29
X													
Agusan Norte	1.11	0.03	1.14	1.32	1.48	1.35	0.19	1.53	1.56	1.54	1.79	1.74	1.93
Agusan Sur	0.67	0.02	0.69	0.79	0.98	0.80	0.12	0.91	0.97	0.91	1.05	1.02	1.16
Bukidnon***	1.34	0.03	1.37	1.33	1.50	1.36	0.20	1.56	1.61	1.51	1.77	1.64	1.94
Camiguin	0.18	0.01	0.19	0.23	0.27	0.23	0.06	0.29	0.30	0.26	0.34	0.29	0.38
Misamis Oriental	1.47	0.05	1.53	1.93	2.21	1.98	0.33	2.31	2.39	2.22	2.67	2.44	2.94
Davao del Norte***	0.53	0.01	0.54	0.74	0.85	0.75	0.06	0.80	0.81	0.85	0.93	0.95	1.05
Davao del Sur	5.13	0.16	5.29	6.34	7.12	6.45	0.94	7.40	7.60	7.30	8.55	8.09	9.50
TOTAL	12.02	0.45	12.47	14.84	17.21	15.46	2.29	17.75	18.47	17.42	20.27	19.21	22.43
XI													
Davao del Norte***	2.02	0.09	2.11	2.42	2.87	2.46	0.54	3.00	3.09	2.81	3.53	3.15	3.96
Davao del Oriental	1.14	0.04	1.17	1.36	1.54	1.39	0.21	1.59	1.63	1.59	1.86	1.78	2.09
Davao del Sur	3.57	0.20	3.78	4.34	5.34	4.42	1.20	5.62	5.82	5.04	6.63	5.64	7.44
Sarangani & Soc. Coti	2.00	0.04	2.04	2.46	2.85	2.50	0.23	2.73	2.79	2.84	3.15	3.16	3.51
Surigao del Sur	0.84	0.02	0.86	0.98	1.08	1.00	0.12	1.11	1.13	1.14	1.30	1.29	1.46
TOTAL	9.56	0.39	9.95	11.56	13.47	11.77	2.29	14.06	14.47	13.42	16.47	15.02	18.47
XII													
Bukidnon***	1.07	0.03	1.10	1.33	1.47	1.36	0.20	1.56	1.61	1.51	1.77	1.64	1.94
Lanao del Norte	0.96	0.04	1.00	1.17	1.34	1.19	0.21	1.39	1.43	1.31	1.59	1.43	1.74
Lanao del Sur	0.58	0.02	0.60	0.75	0.88	0.83	0.11	0.96	0.99	0.80	1.03	0.92	1.16
Maguindanao	0.78	0.04	0.82	0.87	1.05	0.95	0.24	1.09	1.13	0.93	1.21	0.97	1.29
North Cotabato	1.96	0.05	2.01	2.33	2.84	2.37	0.29	2.66	2.71	2.65	3.04	2.93	3.37
South Cotabato***	1.32	0.02	1.34	1.64	1.94	1.67	0.14	1.79	1.83	1.91	2.07	2.13	2.35
Sultan Kudarat	1.87	0.03	1.90	2.13	2.29	2.10	0.19	2.35	2.38	2.38	2.63	2.59	2.80
TOTAL	8.35	0.23	8.57	10.21	11.91	10.38	1.52	11.70	11.98	11.49	13.24	12.51	14.29
PHILIPPINES	102.98	4.34	107.32	124.94	148.13	127.71	20.35	147.07	151.28	143.80	177.53	159.76	197.89

Table F-27 WATER DEMAND FOR LIVESTOCK & POULTRY BY BASIN (High Economic Scenario)

(UNIT: MCM)

WATER RESOURCES REGION/PROVINCE	1998		2000		2006		2010		2015		2020		TOTAL LIVESTOCK CHICKEN	TOTAL LIVESTOCK CHICKEN	TOTAL LIVESTOCK CHICKEN	TOTAL	
	LIVESTOCK	CHICKEN	LIVESTOCK	CHICKEN	LIVESTOCK	CHICKEN	LIVESTOCK	CHICKEN	LIVESTOCK	CHICKEN	LIVESTOCK	CHICKEN					
I	0.70	0.01	0.71	0.65	0.91	0.87	0.84	1.05	1.14	1.27	1.39	1.57	0.17	1.74	2.03	0.43	2.26
ABRA	1.32	0.04	1.36	1.63	1.87	1.74	1.94	2.10	2.43	2.55	2.94	3.16	0.54	3.75	4.99	0.81	4.90
LAGOAG	0.64	0.01	0.65	0.75	0.79	0.76	0.82	0.94	1.02	1.17	1.27	1.49	0.13	1.62	1.96	0.19	2.17
ABULOG	7.72	0.24	7.66	4.19	10.47	9.80	11.00	11.49	13.56	14.04	16.84	17.66	3.43	21.44	23.72	5.29	24.92
CAGAYAN	4.13	0.16	4.30	5.12	6.03	5.28	6.47	6.30	7.46	7.55	9.62	9.25	2.42	12.07	11.65	3.91	15.79
II	9.29	0.67	9.06	11.29	14.70	11.63	15.18	15.18	21.01	19.75	27.57	26.09	10.64	36.75	36.03	14.71	50.74
PAMPANGA	0.81	0.02	0.83	0.97	1.06	1.00	1.12	1.15	1.33	1.40	1.60	1.70	0.28	1.88	2.17	0.39	2.56
ANAY-PATRICK	1.60	0.15	1.74	1.94	2.68	1.98	2.95	2.64	3.91	3.42	4.69	4.16	1.21	5.90	6.43	1.20	8.63
PASIG-LAGUNA BAY	3.38	0.09	3.48	4.01	4.47	4.09	4.69	5.94	6.43	6.77	7.77	7.44	1.44	8.90	10.42	1.99	12.41
V	0.15	0.19	0.33	3.79	4.74	3.89	5.13	4.76	6.36	5.84	7.32	7.32	2.96	10.29	9.63	4.10	13.73
JALAJUR	2.91	0.15	3.06	3.48	4.24	3.66	4.44	4.44	5.74	5.53	7.28	7.05	2.38	9.43	9.43	3.29	12.72
ILOG-MABANGAL	0.95	0.03	0.93	1.06	1.22	1.08	1.29	1.33	1.60	1.64	2.00	2.07	0.48	2.48	2.75	0.44	3.42
PANAY	1.78	0.05	1.83	2.11	2.37	2.15	2.46	2.76	3.19	3.61	4.09	4.56	0.79	5.36	6.21	1.09	7.31
AGUSAN	1.07	0.03	1.10	1.32	1.51	1.37	1.60	1.64	1.94	1.97	2.37	2.41	0.55	2.96	3.09	0.76	3.85
CAGAYAN DE ORO	1.47	0.06	1.53	1.93	2.22	2.01	2.39	2.44	2.93	2.66	3.67	3.65	0.91	4.57	4.74	1.25	5.99
TAGBILARAN	2.00	0.04	2.04	2.46	2.66	2.02	2.78	3.18	3.51	3.96	4.42	5.00	0.63	5.69	6.77	0.87	7.64
BUAYAN-MALUNCON	3.57	0.20	3.78	4.24	4.44	4.44	5.60	5.64	7.42	7.12	9.50	9.18	3.25	12.43	12.39	4.90	16.88
DAVAO	2.02	0.09	2.11	2.42	2.89	2.47	3.08	3.15	3.96	4.03	4.94	5.19	1.27	6.55	7.04	2.03	9.07
TACUMILIBUGANON	1.55	0.05	1.60	1.91	2.17	1.96	2.32	2.25	2.70	2.58	3.17	3.02	0.82	3.83	3.67	1.13	4.80
AGUS	5.91	0.14	6.07	6.97	7.84	7.11	8.63	8.63	9.43	10.50	12.12	13.09	2.21	14.30	17.13	3.26	20.19
IMPANGAN																	

Table F-28 WATER DEMAND FOR LIVESTOCK & POULTRY BY BASIN (Low Economic Growth Scenario)

(UNIT: MCM)

WATER RESOURCES REGION/PROVINCE	1996		2000		2006		2010		2016		2020		2025		TOTAL					
	LIVESTOCK	CHICKEN	LIVESTOCK	CHICKEN	LIVESTOCK	CHICKEN	LIVESTOCK	CHICKEN	LIVESTOCK	CHICKEN	LIVESTOCK	CHICKEN	LIVESTOCK	CHICKEN						
I																				
ABRA	0.70	0.01	0.71	0.85	0.85	0.87	0.95	0.87	0.87	0.95	0.95	0.86	1.04	1.05	0.09	1.14	1.14	0.10	1.24	
LAOAG	1.92	0.04	1.96	1.86	1.72	1.90	1.99	1.74	1.74	1.99	1.99	1.92	2.21	2.10	0.33	2.43	2.20	0.36	2.64	
II																				
ABULOG	0.64	0.01	0.65	0.76	0.76	0.81	0.85	0.78	0.78	0.85	0.82	0.85	0.92	0.94	0.07	1.02	1.03	0.08	1.12	
CAGAYAN	7.72	0.24	7.96	9.19	1.16	10.37	9.35	1.41	10.75	9.40	1.63	11.03	10.45	1.87	12.32	11.49	2.12	13.61	12.54	14.87
III																				
AGNO	4.13	0.16	4.30	5.12	5.98	5.23	1.04	6.27	5.28	1.20	6.49	5.79	1.38	7.16	6.30	1.50	7.87	6.81	1.72	8.53
PAMPANGA	9.29	0.87	9.96	11.29	3.27	14.58	11.50	3.92	15.41	11.53	4.53	16.05	13.35	5.21	18.56	15.18	5.89	21.07	17.01	23.49
IV																				
ANNAN/PATRICK	0.81	0.02	0.83	0.87	0.09	1.06	0.99	0.10	1.09	1.00	0.12	1.12	1.09	0.14	1.23	1.18	0.16	1.33	1.27	1.44
PASIG-LAGUNA BAY	1.80	0.15	1.74	1.94	0.71	2.65	1.98	0.85	2.83	1.98	0.96	2.97	2.31	1.13	3.44	2.64	1.28	3.90	2.97	4.38
V																				
BICOL	0.35	0.09	3.48	4.01	0.44	4.45	4.07	0.53	4.60	4.09	0.81	4.70	4.56	0.70	5.27	5.04	0.80	5.84	5.52	6.39
VI																				
JALUR	3.15	0.19	3.33	3.78	0.91	4.71	3.86	1.09	4.95	3.89	1.26	5.15	4.32	1.45	5.77	4.78	1.64	6.40	5.19	7.00
ILOCOS-NABANGAN	0.71	0.04	0.75	0.85	0.18	1.00	0.87	0.21	1.08	0.87	0.25	1.12	0.98	0.29	1.27	1.09	0.32	1.41	1.20	1.55
PANAY	0.90	0.03	0.93	1.06	0.15	1.21	1.07	0.16	1.26	1.08	0.21	1.29	1.20	0.24	1.44	1.33	0.27	1.60	1.45	1.75
X																				
AGUSAN	1.78	0.05	1.83	2.11	0.24	2.36	2.15	0.29	2.44	2.15	0.34	2.49	2.46	0.39	2.84	2.78	0.44	3.20	3.06	3.54
CAGAYAN DE ORO	1.07	0.03	1.10	1.33	0.17	1.50	1.36	0.20	1.56	1.37	0.23	1.61	1.51	0.27	1.77	1.64	0.30	1.94	1.77	2.11
TAGOLOAN	1.47	0.06	1.53	1.93	0.26	2.21	1.98	0.33	2.31	2.01	0.39	2.39	2.22	0.44	2.67	2.44	0.50	2.94	2.65	3.20
XI																				
BUAYAN-MALUNSON	2.00	0.04	2.04	2.46	0.19	2.65	2.50	0.23	2.73	2.52	0.27	2.79	2.84	0.31	3.15	3.16	0.35	3.51	3.49	3.87
DAVAO	3.57	0.20	3.78	4.34	1.00	5.34	4.42	1.20	5.62	4.44	1.36	5.82	5.04	1.59	6.63	5.64	1.80	7.44	6.23	8.21
TAGUMILIBANON	2.07	0.09	2.11	2.42	0.45	2.87	2.46	0.54	3.00	2.47	0.62	3.09	2.83	0.72	3.53	3.15	0.81	3.96	3.40	4.39
XII																				
AGUS	1.55	0.05	1.60	1.91	0.25	2.16	1.95	0.30	2.25	1.98	0.36	2.32	2.11	0.40	2.51	2.25	0.45	2.70	2.39	2.80
MINDANAO	5.30	0.14	6.07	6.97	0.68	7.65	7.08	0.81	7.89	7.11	0.94	8.05	7.87	1.08	8.95	8.02	1.22	9.85	8.38	10.73

**Table F-29 WATER DEMAND FOR FISHERIES
(High Economic Growth Scenario) (1/3)**

(UNIT: MCM)

WATER RESOURCES							
REGION / PROVINCE	1996	2000	2005	2010	2015	2020	2025
I							
Abra	0.23	0.30	0.32	0.33	0.34	0.35	0.38
Benguet***	0.02	0.03	0.03	0.03	0.03	0.03	0.04
Ilocos Norte	6.20	8.13	8.70	9.09	9.42	9.54	10.50
Ilocos Sur	16.99	22.26	23.82	24.88	25.79	26.09	28.73
Ia Union	24.23	33.10	35.42	37.00	38.34	38.80	42.72
TOTAL	47.67	63.83	68.29	71.34	73.93	74.81	82.37
II							
Batanes	0.00	0.00	0.00	0.00	0.00	0.00	0.00
Cagayan	44.60	61.90	66.24	69.20	71.72	72.55	79.88
Ifugao	0.50	0.66	0.70	0.73	0.76	0.77	0.85
Isabela	5.10	6.66	7.13	7.45	7.72	7.81	8.60
Kalinga Apayao	0.63	0.82	0.88	0.92	0.95	0.96	1.06
Mt. Province	0.14	0.18	0.19	0.20	0.21	0.21	0.23
Nueva Vizcaya	0.67	0.88	0.94	0.98	1.02	1.03	1.13
Quirino	3.56	4.65	4.98	5.20	5.39	5.45	6.00
TOTAL	55.20	75.75	81.06	84.68	87.77	88.78	97.75
III							
Aurora	4.70	6.77	7.23	7.56	7.84	7.93	8.72
Bataan	269.11	383.69	410.60	428.93	444.54	449.77	495.19
Benguet***	0.00	0.00	0.00	0.00	0.00	0.00	0.00
Bulacan	475.63	654.77	700.70	732.00	758.62	767.54	845.05
Nueva Ecija	23.46	30.62	32.77	34.24	35.48	35.90	39.52
Pampanga	1060.74	1549.30	1657.98	1732.02	1795.01	1816.13	1999.54
Pangasinan	241.13	319.46	341.87	357.14	370.13	374.48	412.30
Tarlac	8.62	11.25	12.04	12.57	13.03	13.18	14.52
Zambales	12.82	16.79	17.96	18.77	19.45	19.67	21.66
TOTAL	2096.21	2972.64	3181.16	3323.22	3444.09	3484.59	3836.51
IV							
Batangas	11.57	16.89	18.07	18.88	19.56	19.80	21.79
Cavite	4.31	6.17	6.60	6.90	7.15	7.24	7.96
Laguna	0.27	0.36	0.38	0.40	0.41	0.42	0.46
Metro Manila	85.65	112.60	120.49	125.88	130.46	131.99	145.32
Marinduque	8.36	12.04	12.89	13.47	13.95	14.12	15.55
Mindoro Occidental	65.31	86.43	92.49	96.62	100.14	101.32	111.54
Mindoro Oriental	67.34	95.90	102.63	107.22	111.12	112.42	123.78
Palawan	1.98	2.58	2.76	2.89	2.99	3.03	3.33
Quezon	195.43	257.70	275.77	288.10	298.57	302.08	332.59
Rizal	0.00	0.00	0.00	0.00	0.00	0.00	0.00
Romblon	4.58	5.97	6.39	6.68	6.92	7.00	7.71
TOTAL	444.81	596.64	638.47	667.03	691.27	699.41	770.03

**Table F-29 WATER DEMAND FOR FISHERIES
(High Economic Growth Scenario) (2/3)**

(UNIT: MCM)

WATER RESOURCES							
REGION / PROVINCE	1996	2000	2005	2010	2015	2020	2025
V							
Albay	10.26	14.01	14.99	15.65	16.23	16.42	18.08
Camarines Norte	30.25	44.30	47.40	49.52	51.32	51.93	57.17
Camarines Sur	49.52	69.24	74.10	77.41	80.23	81.17	89.36
Catanduanes	2.01	2.90	3.11	3.24	3.36	3.40	3.75
Masbate	63.49	89.55	95.83	100.10	103.75	104.97	115.58
Sorsogon	34.31	49.43	52.90	55.26	57.27	57.95	63.79
TOTAL	189.83	269.43	288.35	301.20	312.16	315.83	347.73
VI							
Aklan	199.37	272.07	291.15	304.15	315.21	318.92	351.13
Antique	9.50	13.53	14.48	15.12	15.67	15.86	17.46
Capiz	203.21	275.84	295.19	308.38	319.59	323.35	356.01
Guimaras &	94.03	130.02	139.13	145.35	150.63	152.40	167.79
Iloilo	244.68	337.54	351.21	377.35	391.07	395.67	435.63
Negros Occ.***	710.47	1036.19	1108.87	1158.39	1200.52	1214.64	1337.31
Negros Or.***	0.00	0.00	0.00	0.00	0.00	0.00	0.00
TOTAL	1461.26	2065.19	2210.03	2308.73	2392.70	2420.84	2665.32
VII							
Bohol	82.40	113.71	121.68	127.12	131.74	133.29	146.75
Cebu	195.49	289.21	309.50	323.32	335.08	339.02	373.26
Negros Occ.***	0.00	0.00	0.00	0.00	0.00	0.00	0.00
Negros Or.***	66.53	92.23	98.70	103.11	106.86	108.12	119.03
Siquijor	0.84	1.23	1.32	1.38	1.43	1.45	1.60
TOTAL	345.26	496.39	531.20	554.93	575.11	581.88	640.64
VIII							
Biliran &	0.00	0.00	0.00	0.00	0.00	0.00	0.00
Northern Leyte	32.11	43.95	47.03	49.13	50.92	51.52	56.72
Southern Leyte	1.46	1.98	2.13	2.22	2.30	2.33	2.57
Eastern Samar	0.73	0.95	1.02	1.07	1.10	1.12	1.23
Northern Samar	8.66	12.25	13.10	13.68	14.18	14.35	15.80
Western Samar	41.57	58.74	62.86	65.67	68.05	68.86	75.81
TOTAL	84.52	117.87	126.15	131.78	136.56	138.18	152.14
IX							
Basilan	1.22	1.70	1.82	1.90	1.97	1.99	2.19
Misamis Occ.	58.99	88.48	94.69	98.92	102.51	103.71	114.19
Sulu	0.00	0.00	0.00	0.00	0.00	0.00	0.00
Tawi-Tawi	0.00	0.00	0.00	0.00	0.00	0.00	0.00
Zamboanga Norte	12.29	17.63	18.86	19.70	20.42	20.66	22.74
Zamboanga Sur	1324.47	1921.92	2056.73	2148.58	2226.71	2252.91	2480.43
TOTAL	1396.97	2029.72	2172.10	2269.10	2351.61	2379.27	2619.56

**Table F-29 WATER DEMAND FOR FISHERIES
(High Economic Growth Scenario) (3/3)**

(UNIT: MCM)

WATER RESOURCES							
REGION / PROVINCE	1996	2000	2005	2010	2015	2020	2025
X							
Agusan Norte	66.20	94.16	100.77	105.27	109.10	110.38	121.54
Agusan Sur	0.11	0.14	0.15	0.16	0.17	0.17	0.19
Bukidnon***	1.23	1.60	1.71	1.79	1.85	1.87	2.06
Camiguin	0.00	0.00	0.00	0.00	0.00	0.00	0.00
Misamis Oriental	27.04	39.82	42.60	44.51	46.13	46.67	51.38
Davao del Norte***	0.00	0.00	0.00	0.00	0.00	0.00	0.00
Surigao del Norte	53.18	79.40	84.95	88.76	91.98	93.06	102.47
TOTAL	147.76	215.12	230.19	240.49	249.23	252.16	277.64
XI							
Davao del Norte***	54.99	71.78	76.82	80.25	83.17	84.14	92.64
Davao del Oriental	18.23	23.80	25.47	26.60	27.57	27.89	30.71
Davao del Sur	74.23	105.71	113.12	118.18	122.47	123.91	136.43
Sarangani	145.21	216.32	231.49	241.83	250.63	253.58	279.18
South Cotabato***	3.40	4.44	4.75	4.97	5.15	5.21	5.73
Surigao del Sur	64.93	92.91	99.43	103.88	107.65	108.92	119.92
TOTAL	360.98	514.96	551.09	575.70	596.63	603.65	664.60
XII							
Bukidnon***	0.00	0.00	0.00	0.00	0.00	0.00	0.00
Lanao del Norte	227.91	332.56	355.90	371.78	385.30	389.84	429.21
Lanao del Sur	0.29	0.40	0.43	0.45	0.47	0.47	0.51
Maguindanao	32.69	45.10	48.26	50.41	52.25	52.87	58.21
North Cotabato	0.49	0.63	0.68	0.71	0.73	0.74	0.82
South Cotabato***	0.00	0.00	0.00	0.00	0.00	0.00	0.00
Sultan Kudarat	6.85	9.06	9.69	10.13	10.50	10.62	11.69
TOTAL	268.24	387.76	414.96	433.48	449.25	454.53	500.44
GRAND TOTAL	6898.70	9805.29	10493.04	10961.68	11360.30	11493.93	12654.72

**Table F-30 WATER DEMAND FOR FISHERIES
(Low Economic Growth Scenario) (1/3)**

(UNIT: MCM)

WATER RESOURCES REGION / PROVINCE	1996	2000	2005	2010	2015	2020	2025
I							
Abra	0.23	0.29	0.30	0.31	0.32	0.32	0.33
Benguet***	0.02	0.03	0.03	0.03	0.03	0.03	0.03
Ilocos Norte	6.20	7.81	8.17	8.47	8.70	8.87	8.97
Ilocos Sur	16.99	21.37	22.38	23.19	23.81	24.27	24.53
La Union	24.23	31.77	33.27	34.49	35.40	36.09	36.48
TOTAL	47.67	61.27	64.15	66.49	68.26	69.58	70.34
II							
Batanes	0.00	0.00	0.00	0.00	0.00	0.00	0.00
Cagayan	44.60	59.42	62.21	64.49	66.21	67.48	68.22
Iligao	0.50	0.63	0.66	0.68	0.70	0.72	0.72
Isabela	5.10	6.40	6.70	6.94	7.13	7.26	7.34
Kalinga Apayao	0.63	0.79	0.83	0.86	0.88	0.90	0.91
Mt. Province	0.14	0.17	0.18	0.19	0.19	0.20	0.20
Nueva Vizcaya	0.67	0.84	0.88	0.92	0.94	0.96	0.97
Quirino	3.56	4.47	4.68	4.85	4.93	5.07	5.13
TOTAL	55.20	72.72	76.14	78.93	81.03	82.59	83.49
III							
Aurora	4.70	6.49	6.80	7.04	7.23	7.37	7.45
Balaan	269.11	368.32	385.64	399.78	410.40	418.29	422.83
Benguet***	0.00	0.00	0.00	0.00	0.00	0.00	0.00
Bulacan	475.63	628.58	658.13	682.26	700.40	713.85	721.60
Nueva Ecija	23.46	29.40	30.78	31.91	32.76	33.39	33.75
Pampanga	1060.74	1487.20	1557.11	1614.20	1657.11	1688.94	1707.26
Pangasinan	241.13	306.71	321.12	332.89	341.74	348.31	352.09
Tarlac	8.62	10.80	11.31	11.72	12.03	12.26	12.40
Zambales	12.82	16.11	16.87	17.49	17.95	18.30	18.50
TOTAL	2096.21	2853.61	2987.75	3097.30	3179.62	3240.79	3275.88
IV							
Batangas	11.57	16.21	16.97	17.59	18.06	18.41	18.60
Cavite	4.31	5.92	6.21	6.43	6.60	6.72	6.80
Laguna	0.27	0.34	0.36	0.37	0.38	0.39	0.39
Metro Manila	85.65	108.10	113.18	117.33	120.45	122.76	124.09
Marinduque	8.36	11.56	12.10	12.55	12.88	13.13	13.27
Mindoro Occidental	65.31	82.97	86.88	90.07	92.46	94.23	95.26
Mindoro Oriental	67.34	92.06	96.39	99.92	102.58	104.56	105.68
Palawan	1.98	2.48	2.60	2.69	2.76	2.82	2.85
Quezon	195.43	247.41	259.04	268.54	275.67	280.97	284.02
Rizal	0.00	0.00	0.00	0.00	0.00	0.00	0.00
Romblon	4.58	5.74	6.01	6.23	6.39	6.51	6.58
TOTAL	444.81	572.81	599.74	621.72	638.21	650.51	657.55

**Table F-30 WATER DEMAND FOR FISHERIES
(Low Economic Growth Scenario) (2/3)**

(UNIT: MCM)

WATER RESOURCES REGION/PROVINCE	1996	2000	2005	2010	2015	2020	2025
V							
Albay	10.26	13.45	14.08	14.59	14.98	15.28	15.44
Camarines Norte	30.25	42.52	44.52	46.15	47.37	48.28	48.81
Camarines Sur	49.52	66.48	69.59	72.15	74.07	75.49	76.31
Calanduanes	2.01	2.79	2.92	3.02	3.11	3.16	3.20
Masbate	63.49	85.97	90.00	93.31	95.78	97.62	98.68
Sorsogon	34.31	47.45	49.68	51.50	52.87	53.89	54.47
TOTAL	189.83	258.65	270.80	280.72	288.19	293.72	296.92
VI							
Aklan	199.37	261.19	273.46	283.49	291.02	296.62	299.84
Antique	9.50	12.98	13.59	14.10	14.47	14.74	14.90
Capiz	203.21	264.81	277.27	287.42	295.07	300.74	304.01
Guimaras &	94.03	124.81	130.68	135.47	139.07	141.74	143.28
Iloilo	244.68	324.03	339.27	351.70	361.06	368.00	371.99
Negros Occ.***	710.47	994.66	1041.42	1079.60	1108.29	1129.59	1141.84
Negros Or.***	0.00	0.00	0.00	0.00	0.00	0.00	0.00
TOTAL	1451.26	1932.49	2075.89	2151.78	2208.99	2251.42	2275.86
VII							
Bohol	82.40	109.16	114.29	118.48	121.63	123.97	125.32
Cebu	195.49	277.61	290.66	301.32	309.33	315.27	318.69
Negros Occ.***	0.00	0.00	0.00	0.00	0.00	0.00	0.00
Negros Or.***	66.53	88.54	92.70	96.10	98.65	100.55	101.64
Siquijor	0.84	1.19	1.25	1.29	1.32	1.34	1.37
TOTAL	345.25	476.51	498.90	517.20	530.94	541.14	547.02
VIII							
Biliran &	0.00	0.00	0.00	0.00	0.00	0.00	0.00
Northern Leyte	32.11	42.20	44.18	45.80	47.01	47.91	48.44
Southern Leyte	1.46	1.91	2.00	2.07	2.13	2.16	2.19
Eastern Samar	0.73	0.91	0.96	0.99	1.02	1.04	1.05
Northern Samar	8.66	11.75	12.30	12.75	13.10	13.35	13.49
Western Samar	41.57	56.39	59.04	61.21	62.83	64.03	64.73
TOTAL	84.52	113.15	118.47	122.82	126.09	128.50	129.90
IX							
Basilan	1.22	1.63	1.71	1.77	1.82	1.86	1.88
Misamis Occ.	58.99	84.92	88.92	92.18	94.63	96.44	97.49
Sulu	0.00	0.00	0.00	0.00	0.00	0.00	0.00
Tawi-Tawi	0.00	0.00	0.00	0.00	0.00	0.00	0.00
Zamboanga Norte	12.29	16.92	17.72	18.36	18.85	19.21	19.42
Zamboanga Sur	1324.47	1844.90	1931.61	2002.44	2055.67	2095.16	2117.89
TOTAL	1396.97	1948.33	2039.96	2114.75	2170.97	2212.67	2236.69
X							
Agusan Norte	66.20	90.40	94.64	98.12	100.72	102.66	103.78
Agusan Sur	0.11	0.14	0.14	0.15	0.15	0.16	0.16
Bukidnon***	1.23	1.54	1.61	1.67	1.71	1.74	1.76
Comiguin	0.00	0.00	0.00	0.00	0.00	0.00	0.00
Misamis Oriental	27.04	38.22	40.02	41.48	42.58	43.40	43.87
Davao del Norte***	0.00	0.00	0.00	0.00	0.00	0.00	0.00
Surigao del Norte	53.18	76.21	79.79	82.72	84.91	86.54	87.49
TOTAL	147.76	206.50	216.20	224.15	230.08	234.50	237.05

**Table F-30 WATER DEMAND FOR FISHERIES
(Low Economic Growth Scenario) (3/3)**

(UNIT: MCM)

WATER RESOURCES							
REGION/PROVINCE	1996	2000	2005	2010	2015	2020	2025
XI							
Davao del Norte***	54.99	68.92	72.16	74.80	76.79	78.26	79.11
Davao del Oriental	18.23	22.85	23.92	24.80	25.46	25.95	26.23
Davao del Sur	74.23	101.47	106.24	110.14	113.06	115.23	116.49
Sarangani	145.21	207.64	217.40	225.38	231.36	235.81	238.37
South Cotabato***	3.40	4.27	4.47	4.63	4.75	4.84	4.90
Surigao del Sur	64.93	69.19	93.39	96.82	99.38	101.29	102.40
TOTAL	360.93	494.35	517.58	535.56	550.81	561.38	567.49
XII							
Bukidnon***	0.00	0.00	0.00	0.00	0.00	0.00	0.00
Lanao del Norte	227.91	319.23	334.24	346.50	355.70	362.54	366.47
Lanao del Sur	0.29	0.39	0.40	0.42	0.43	0.44	0.44
Maguindanao	32.69	43.30	45.33	47.00	48.24	49.17	49.70
North Cotabato	0.49	0.61	0.64	0.66	0.68	0.69	0.70
South Cotabato***	0.00	0.00	0.00	0.00	0.00	0.00	0.00
Sultan Kudarat	6.85	8.70	9.10	9.44	9.69	9.88	9.99
TOTAL	268.24	372.22	389.72	404.01	414.75	422.72	427.31
GRAND TOTAL	6893.70	9412.66	9355.10	10216.43	10487.97	10689.44	10805.49

**Table F-31 WATER DEMAND FOR FISHERIES BY BASIN
(High Economic Growth Scenario)**

(UNIT: MCM)

WATER RESOURCES REGION / PROVINCE	1996	2000	2005	2010	2015	2020	2025
I							
ABRA	0.23	0.30	0.32	0.33	0.34	0.35	0.38
LAOAG	6.20	8.13	8.70	9.09	9.42	9.51	10.50
II							
CAGAYAN	54.57	74.93	80.18	83.76	86.82	87.82	96.69
ABULOG	0.63	0.82	0.83	0.92	0.95	0.96	1.06
III							
AGNO	249.75	330.71	353.91	369.71	383.16	387.66	426.82
PAMPANGA	1559.83	2234.69	2391.45	2498.26	2589.11	2619.56	2884.11
IV							
PASIG-LAGUNA BAY	85.92	112.96	120.87	126.28	130.87	132.41	145.78
AMNAY-PATRICK	65.31	86.43	92.49	96.62	100.14	101.32	111.51
V							
BICOL	59.78	83.25	89.10	93.07	96.46	97.58	107.44
VI							
JALAUAR	244.68	337.54	361.21	377.35	391.07	395.67	435.63
ILOG-HILABANGAN	173.35	254.28	272.12	284.27	294.61	298.07	328.18
PANAY	203.21	275.84	295.19	308.38	319.59	323.35	356.01
X							
AGUSAN	66.31	94.30	100.92	105.43	109.27	110.55	121.73
CAGAYAN DE ORO	1.23	1.60	1.71	1.79	1.85	1.87	2.06
TAGOLOAN	27.04	39.82	42.60	44.51	46.13	46.67	51.38
XI							
TAGUM-LIBUGANON	54.99	71.78	76.82	80.25	83.17	84.14	92.64
DAVAO	74.23	105.71	113.12	118.18	122.47	123.91	136.43
BUAYAN-MALUNGON	3.40	4.44	4.75	4.97	5.15	5.21	5.73
XII							
AGUS	228.21	332.96	356.33	372.23	385.77	390.31	429.72
MINDANAO	40.03	54.79	58.63	61.26	63.47	64.22	70.72

**Table F-32 WATER DEMAND FOR FISHERIES BY BASIN
(Low Economic Growth Scenario)**

(UNIT: MCM)

WATER RESOURCES REGION/PROVINCE	1996	2000	2005	2010	2015	2020	2025
I							
ABRA	0.23	0.29	0.30	0.31	0.32	0.32	0.33
LAOAG	6.20	7.81	8.17	8.47	8.70	8.87	8.97
II							
ABULOG	0.63	0.79	0.83	0.86	0.88	0.90	0.91
CAGAYAN	51.57	71.93	75.31	78.07	80.15	81.69	82.58
III							
PAMPANGA	1559.83	2145.18	2246.02	2328.38	2390.27	2436.18	2462.62
AGNO	249.75	317.51	332.43	344.61	353.77	360.57	364.49
IV							
PASIG-LAGUNA BAY	85.92	108.44	113.54	117.70	120.83	123.15	124.48
AMNAY-PATRICK	65.31	82.97	86.88	90.07	92.46	94.23	95.26
V							
BICOL	59.78	79.93	83.67	86.74	89.05	90.77	91.75
VI							
JALAU	244.68	324.03	339.27	351.70	361.06	368.00	371.99
ILOG-HILABANGAN	173.28	242.60	254.00	263.31	270.31	275.51	278.49
PANAY	203.21	264.81	277.27	287.42	295.07	300.74	304.01
X							
AGUSAN	66.31	90.54	94.78	98.27	100.87	102.82	103.94
CAGAYAN DE ORO	1.23	1.54	1.61	1.67	1.71	1.74	1.76
TAGOLOAN	27.04	38.22	40.02	41.48	42.58	43.40	43.87
XI							
BUAYAN-MALUNGON	3.40	4.27	4.47	4.63	4.75	4.84	4.90
DAVAO	74.23	101.47	106.24	110.14	113.06	115.23	116.49
TAGUM-LIBUGANON	54.99	68.92	72.16	74.80	76.79	78.26	79.11
XII							
AGUS	228.21	319.62	334.64	346.91	356.13	362.98	366.92
MINDANAO	40.03	52.60	55.08	57.09	58.61	59.73	60.39

**Table F-33 AGRICULTURAL WATER DEMAND
(High Economic Growth Scenario) (1/2)**

(Unit: MCM)

Water Resources Region/Province	1996	2000	2005	2010	2015	2020	2025
I	1484.55	1966.56	2447.17	2548.95	2670.71	2707.14	2751.58
ABRA	199.87	227.40	263.61	274.38	280.99	283.84	286.88
BENGUET	52.97	56.03	56.32	56.42	60.12	60.29	60.56
ILOCOS NORTE	734.41	934.92	1145.72	1231.87	1302.83	1334.23	1366.84
ILOCOS SUR	236.86	489.55	709.03	711.83	736.99	737.89	741.45
LA UNION	200.43	258.66	272.49	274.45	289.77	290.90	295.84
II	4203.65	6067.55	6946.88	8065.50	9648.45	10968.20	12298.51
BATANES	0.01	5.19	5.22	5.22	5.25	5.25	5.25
CAGAYAN	1063.81	1684.92	1914.41	2326.41	2968.99	3530.10	4098.44
IFUGAO	62.57	85.14	117.63	145.82	183.00	214.85	246.97
ISABELA	1738.09	2255.88	2422.64	2799.53	3440.83	3970.71	4502.13
KALINGA APAYAO	509.07	922.54	1010.07	1098.36	1260.06	1372.23	1484.68
MT. PROVINCE	194.88	252.96	259.67	261.18	261.47	261.85	262.47
NUEVA VIZCAYA	520.48	624.53	835.40	990.92	1046.00	1091.44	1137.26
QUIRINO	54.73	236.37	381.86	438.05	482.85	521.75	561.33
III	6194.57	9996.33	12474.76	13328.37	14596.90	15328.33	16455.10
AURORA	125.60	199.07	227.65	240.58	266.91	280.51	294.88
BATAAN	406.37	578.93	634.78	653.22	669.46	674.88	720.60
BENGUET	37.52	37.61	37.63	37.73	38.73	38.90	39.16
BULACAN	1012.99	1309.08	1396.95	1470.62	1568.73	1634.63	1771.96
NUEVA ECHJA	1748.63	2567.13	3604.21	3818.10	4093.02	4201.12	4313.61
PAMPANGA	1280.86	2330.46	2472.91	2550.96	2657.40	2684.92	2875.55
PANGASINAN	1277.44	2017.54	2952.69	3153.59	3483.35	3659.50	3879.84
TARLAC	220.84	687.77	784.49	990.25	1337.99	1637.57	1938.85
ZAMBALES	84.32	268.75	364.46	413.33	491.33	555.00	620.64
IV	1799.11	2633.28	2953.91	3343.08	3951.67	4452.66	5022.33
BATANGAS	119.41	167.84	268.74	281.97	296.17	308.64	324.74
CAVITE	199.75	330.88	358.72	401.35	478.67	534.10	590.69
LAGUNA	265.05	385.69	406.77	432.81	474.47	503.84	546.17
MARINDUQUE	11.92	24.88	32.90	35.39	36.85	37.55	39.72
MINDORO OCC.	221.91	379.37	412.46	521.11	698.77	852.56	1015.57
MINDORO ORIENTAL	307.70	420.21	451.53	538.02	680.88	800.24	929.85
PALAWAN	80.75	187.37	213.59	237.34	277.32	308.45	340.23
QUEZON	501.21	3600.49	629.57	685.05	757.40	820.87	912.17
RIZAL	55.67	75.73	96.02	117.74	148.94	176.27	204.47
ROMBLON	35.71	66.73	83.61	92.30	102.19	110.03	118.70
V	1326.03	1919.65	2302.11	2673.60	3135.97	3485.07	3864.46
ALBAY	592.12	644.26	731.85	806.59	941.83	1033.36	1126.74
CAMARINES N.	67.25	122.93	152.56	177.34	206.54	232.63	263.59
CAMARINES SUR	478.70	735.74	907.35	1125.46	1358.82	1543.10	1735.33
CATANDUANES	14.23	61.66	63.57	64.98	68.97	70.98	73.44
MASBATE	80.05	174.72	222.62	262.69	311.10	353.17	404.96
SORSOGON	93.69	180.34	224.14	236.53	248.71	251.83	260.41
VI	2601.91	3775.68	4555.73	5250.64	5685.81	5975.91	6485.51
AKLAN	341.13	476.81	510.94	526.63	544.77	549.01	562.03
ANTIQUE	218.99	297.74	366.08	387.00	405.43	415.93	428.10
CAPIZ	252.36	427.19	515.95	552.65	582.21	599.23	645.45
ILOILO/GUIMARAS	826.10	1172.33	1356.32	1605.03	1808.02	1948.63	2139.38
NEGROS OCC.	916.82	1376.77	1810.51	2153.40	2319.41	2437.17	2664.63
NEGROS OR.	16.54	24.84	25.93	25.93	25.93	25.93	25.93
VII	617.20	1031.61	1293.24	6468.63	1459.23	1513.88	1623.76
BOHOL	210.98	396.76	542.08	573.49	615.05	643.17	684.05
CEBU	233.78	384.84	439.18	454.49	472.50	479.11	517.39
NEGROS OCC.	1.44	10.53	14.95	20.59	29.85	38.36	46.88
NEGROS OR./SIQUOR	171.02	239.45	297.04	322.07	341.83	352.22	375.45

**Table F-33 AGRICULTURAL WATER DEMAND
(High Economic Growth Scenario) (2/2)**

(Unit: MCM)

Water Resources Region/Province	1996	2000	2005	2010	2015	2020	2025
VIII	582.97	1004.44	1235.89	1297.74	1397.62	1453.15	1523.72
N. LEYTE/BILIRAN	432.27	636.29	720.96	770.17	850.66	896.96	949.54
SOUTHERN LEYTE	71.54	80.08	83.30	84.71	88.48	89.03	90.06
EASTERN SAMAR	15.71	89.34	101.05	102.59	104.86	105.27	105.99
NORTHERN SAMAR	15.42	79.38	165.65	169.75	172.62	173.26	175.45
WESTERN SAMAR	48.04	119.35	155.92	170.52	180.99	188.62	202.66
IX	2022.56	2782.43	3056.78	3286.76	3560.91	3742.67	4139.55
BASILAN	2.68	3.27	3.43	3.90	4.58	5.21	6.11
MISAMIS OCC.	145.01	160.69	187.31	191.80	196.06	198.19	210.08
SULU	0.13	1.15	1.27	1.31	1.45	1.53	1.65
TAWI-TAWI	0.02	0.11	0.12	0.13	0.15	0.17	0.19
ZAMBOANGA NORTE	96.90	145.83	206.57	290.02	306.83	497.10	599.83
ZAMBOANGA SUR	1777.81	2451.38	2658.53	2799.60	2961.84	3040.47	3321.70
X	586.01	1007.12	1530.01	1827.60	2223.25	2583.89	2968.85
AGUSAN DEL N.	144.26	316.76	548.72	656.62	807.10	944.03	1091.28
AGUSAN DEL S.	179.98	250.15	380.04	492.10	647.37	798.85	948.60
BUKIDNON	11.34	47.98	68.37	76.13	273.04	101.57	113.72
MISAMIS OR./Comiguin	55.22	118.52	159.53	191.26	226.93	259.17	296.05
DAVAO DEL NORTE	86.20	103.23	135.54	161.99	192.52	221.40	250.29
SURIGAO DEL NORTE	108.01	161.48	237.80	249.51	257.36	258.86	268.91
XI	1333.66	1646.44	1820.98	2163.27	2660.34	3111.14	3619.70
DAVAO DEL NORTE	460.06	486.40	500.50	626.60	816.23	1000.47	1193.08
DAVAO ORIENTAL	78.55	137.01	179.69	216.93	261.50	303.38	348.22
DAVAO SUR	369.27	458.55	516.53	557.25	616.75	659.56	714.96
SO.COTABATO/SARANG	322.90	407.80	440.49	538.65	689.25	822.57	979.68
SURIGAO DEL SUR	102.90	156.69	163.75	223.86	276.63	325.17	383.77
XII	2780.97	4335.63	6016.47	7262.66	9012.37	10594.74	12220.05
BUKIDNON	302.54	432.25	581.58	695.92	866.93	1025.79	1184.95
LANAO DEL NORTE	499.40	728.18	750.60	791.58	825.47	840.55	870.74
LANAO DEL SUR	25.87	171.47	419.03	594.23	811.97	1022.76	1233.64
MAGUINDANAO	150.45	458.00	901.97	1117.46	1416.16	1702.26	1993.22
NORTH COTABATO	626.49	1098.18	1770.39	2081.78	2523.67	2929.09	3335.21
SOUTH COTABATO	945.39	1147.47	1225.09	1511.43	1970.94	2379.63	2788.77
SULTAN KUDARAT	230.81	300.03	343.75	470.28	597.23	704.66	813.51
TOTAL	25533.23	38166.71	46663.94	52418.81	60003.17	65955.45	72973.11

**Table F-34 AGRICULTURAL WATER DEMAND BY BASIN
(High Economic Growth Scenario)**

(UNIT: MCM)

REGION	RIVER BASIN	1995	2000	2005	2010	2015	2020	2025
I	ABRA	216.36	249.03	285.56	296.34	307.60	310.45	313.50
	LAOAG	409.66	492.87	684.92	771.08	821.26	852.67	885.30
II	ABULOG	193.37	517.21	528.41	602.55	708.97	820.76	932.56
	CAGAYAN	4374.92	6739.16	7793.81	9092.83	11007.32	12631.85	14266.68
III	AGNO	1531.96	2650.99	3630.72	4054.62	4722.04	5232.87	5779.60
	PAMPANGA	3775.01	6108.03	7380.43	7752.95	8250.23	8459.26	8907.22
IV	AMNAY-PATRICK	119.33	203.19	227.63	336.28	499.00	652.78	815.79
	PASIG-LAGUNA BAY	236.59	370.45	402.24	430.59	473.30	502.78	545.02
V	BICOL	681.67	882.06	1091.01	1268.55	1501.05	1876.63	1862.03
VI	JALAUUR	464.36	661.76	821.95	976.92	1144.90	1263.74	10459.08
	ILOG-HILABANGAN	175.87	257.39	346.32	478.23	590.60	696.07	828.48
	PANAY	256.00	433.15	552.35	559.04	589.04	606.60	651.61
X	AGUSAN	378.08	591.98	962.17	1207.31	1534.04	1846.15	2168.84
	CAGAYAN DE ORO	4.98	41.69	76.49	93.38	125.63	152.73	180.30
	TAGOLOAN	36.02	81.89	103.35	117.01	132.20	144.76	161.96
XI	BUAYAN-MALUNGON	62.48	68.59	80.29	169.22	303.77	434.12	565.62
	DAVAO	94.85	161.16	209.59	250.32	296.57	339.74	394.78
	TAGUM-LIBUGANON	280.84	304.71	317.56	443.65	631.34	815.57	1008.18
XII	AGUS	300.96	650.10	912.00	1090.26	1309.09	1508.30	1742.68
	MINDANAO	2433.19	4144.36	6269.79	7684.44	9733.61	11636.60	13547.05

**Table F-35 AGRICULTURAL WATER DEMAND BY BASIN
(Low Economic Growth Scenario)**

(UNIT: MCM)

REGION	RIVER BASIN	1996	2000	2005	2010	2015	2020	2025
I	ABRA	216.36	249.03	285.56	294.68	303.45	303.81	304.36
	LAOAG	409.66	492.87	684.92	750.84	770.50	771.39	773.50
II	ABULOG	194.65	518.82	530.11	530.35	554.40	554.76	555.41
	CAGAYAN	4374.92	6739.16	7793.81	8093.79	8389.36	8394.96	8410.87
III	AGNO	1534.96	2650.99	3630.72	3720.40	3883.94	3890.89	3933.74
	PAMPANGA	3775.01	6108.03	7380.43	7640.61	7968.52	8008.17	8286.75
IV	AMNAY-PATRICK	119.33	203.19	227.63	235.30	245.80	247.36	258.15
	PASIG-LAGUNA BAY	236.59	370.45	402.24	413.25	429.79	433.10	449.17
V	BICOL	681.67	882.06	1091.01	1198.17	1258.25	1261.40	1274.37
VI	JALAUUR	464.36	661.76	821.95	976.92	1012.95	1019.84	1063.24
	ILOG-HILABANGAN	175.87	257.39	346.32	410.91	421.78	425.76	456.68
	PANAY	256.00	433.15	552.35	550.63	567.93	572.25	605.77
X	AGUSAN	378.08	591.98	962.17	1002.00	1019.14	1021.69	1034.82
	CAGAYAN DE ORO	4.98	41.69	76.49	80.81	81.57	82.18	83.26
	TAGOLOAN	36.02	81.89	103.35	109.68	113.80	115.29	121.42
XI	BUAYAN-MALUNGON	62.48	68.59	80.29	82.53	88.06	89.39	91.86
	DAVAO	94.85	161.16	209.59	224.82	232.63	237.00	253.97
	TAGUM-LIBUGANON	280.84	304.71	317.56	323.14	329.13	331.67	342.59
XII	AGUS	300.96	650.10	912.00	961.59	986.41	991.61	1031.99
	MINDANAO	2433.19	4144.36	6269.79	6424.77	6574.88	6578.81	6590.20

Part - F

Figures



LEGEND

- Existing Irrigation Schemes
- Proposed Irrigation Schemes
- Existing Diversion Dam
- Proposed Diversion Dam
- Existing Dam
- Proposed Dam
- Existing Weir
- Proposed Weir
- Existing Barrage
- Proposed Barrage
- Existing Canal
- Proposed Canal
- Existing Pipeline
- Proposed Pipeline
- Existing Road
- Proposed Road
- Existing River
- Proposed River
- Existing Stream
- Proposed Stream
- Existing Lake
- Proposed Lake
- Existing Reservoir
- Proposed Reservoir
- Existing Pond
- Proposed Pond
- Existing Wetland
- Proposed Wetland
- Existing Forest
- Proposed Forest
- Existing Urban
- Proposed Urban
- Existing Rural
- Proposed Rural
- Existing Agricultural
- Proposed Agricultural
- Existing Industrial
- Proposed Industrial
- Existing Commercial
- Proposed Commercial
- Existing Residential
- Proposed Residential
- Existing Public
- Proposed Public
- Existing Private
- Proposed Private
- Existing Other
- Proposed Other
- Existing Unknown
- Proposed Unknown

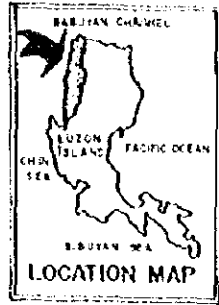
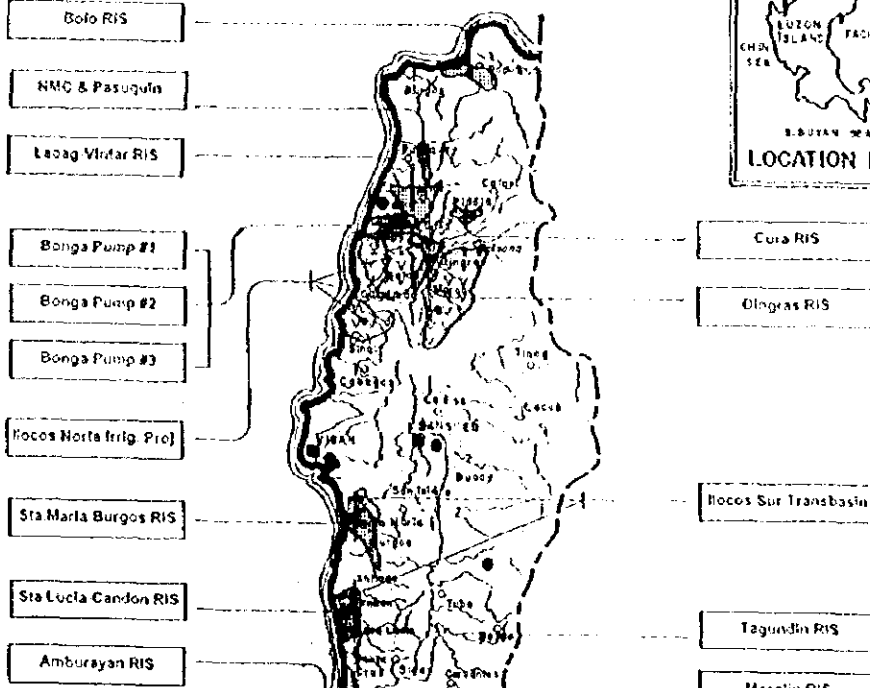

RIS	Source	Service Area (Ha)
Existing		
Ilocos Norte		
1 Laog Vinar RIS	Vinar River	2182.0
2 Bolo RIS	Bolo River	425.0
3 Curo RIS	Barbarra R.	431.0
4 Dingras RIS	Bonga River	1047.0
5 NMC & Pasuquin	Vinar River	748.0
6 Bonga Pump #1	Bonga River	245.0
7 Bonga Pump #2	Bonga River	874.0
8 Bonga Pump #3	Bonga River	202.0
Ilocos Sur		
9 Tagudin RIS	Chico River	1348.0
10 Sta. Maria Burgos RIS	Sta. Maria River	813.0
11 Sta. Lucia Candon RIS	Buya River	1558.0
Ia Union		
12 Amburayan RIS	Amburayan River	3420.0
13 Masalip RIS	Aringay River	1268.0
TOTAL		11028.0
Proposed NIP		
1. Ilocos Norte Irrig. Project (Pasuquin) Phase 2		
2. Ilocos Sur Transbasin		

Province	No. of Schemes	Service Area (Ha)
Existing		
Ilocos Norte	2	110.0
Ilocos Sur	31	1224.0
Ia Union	21	2341.0
Ia Abana	20	910.0
TOTAL	78	2985.0

Province	No. of Schemes	Service Area (Ha)
Existing		
Ilocos Norte	2	110.0
Ilocos Sur	29	970.0
Ia Union	19	1018.0
TOTAL	50	2108.0

POTENTIAL IRRIGABLE AREA (Ha)	: 11028.00
TOTAL SERVICE AREA (Ha)	: 2985.00
IRRIGATION DEVELOPMENT (%)	: 26.98

Province	No. of RIS	Service Area (Ha)
Existing		
Ilocos Norte	273	12925.8
Ilocos Sur	738	6180.0
Ia Union	748	30011.0
Ia Abana	212	12960.0
Ia Ateneo	208	8473.0
TOTAL	1228	27229.8

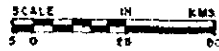

Note
The latest data which were collected by the Study Team from the NIA regional offices during the Study period in 1997 were used to prepare this map.

Figure F-1 LOCATION MAP OF IRRIGATION DEVELOPMENT SCHEMES: WATER RESOURCES REGION I

Note
The latest data which were collected by the Study Team from the NIA regional offices during the Study period in 1997 were used to prepare this map.

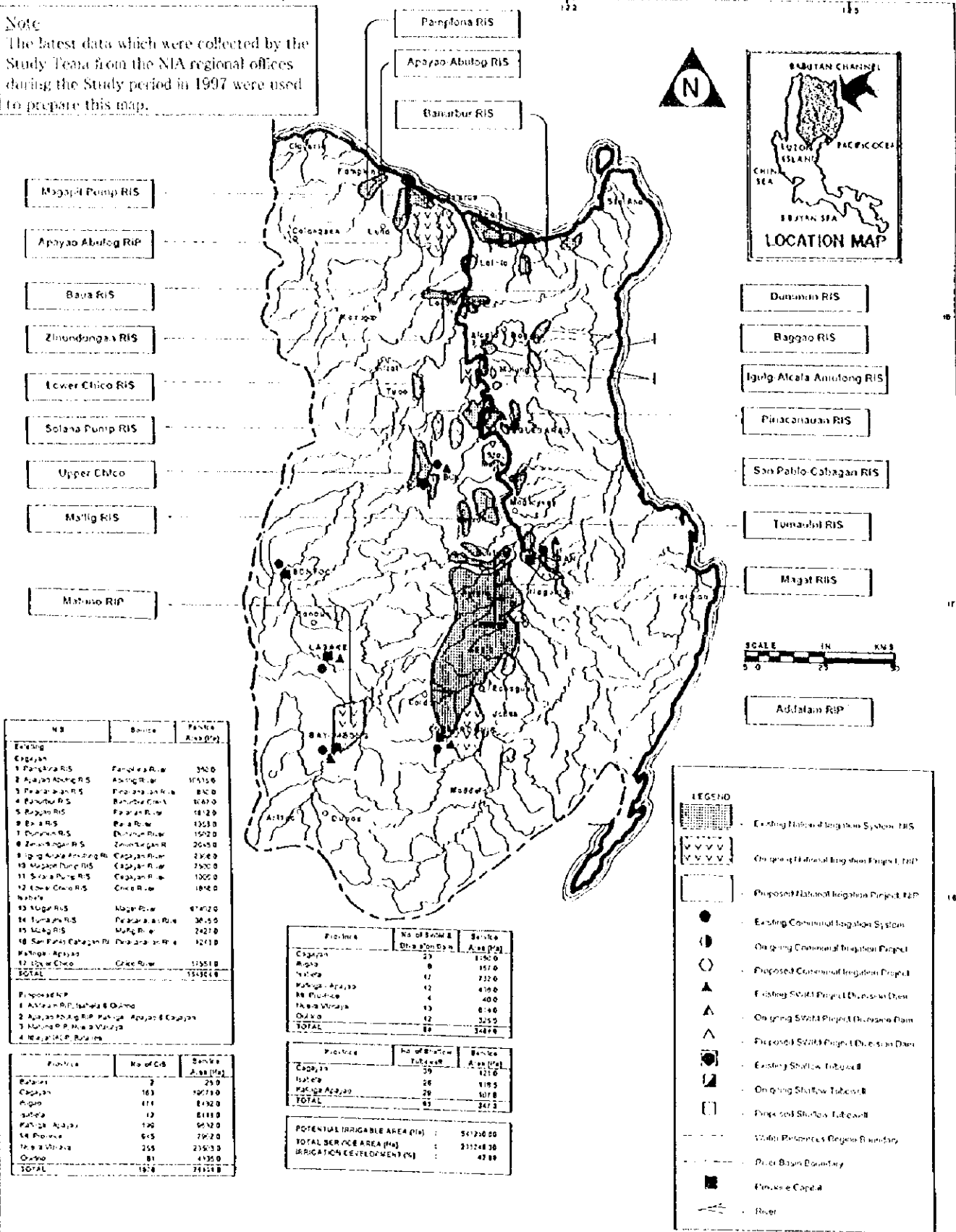
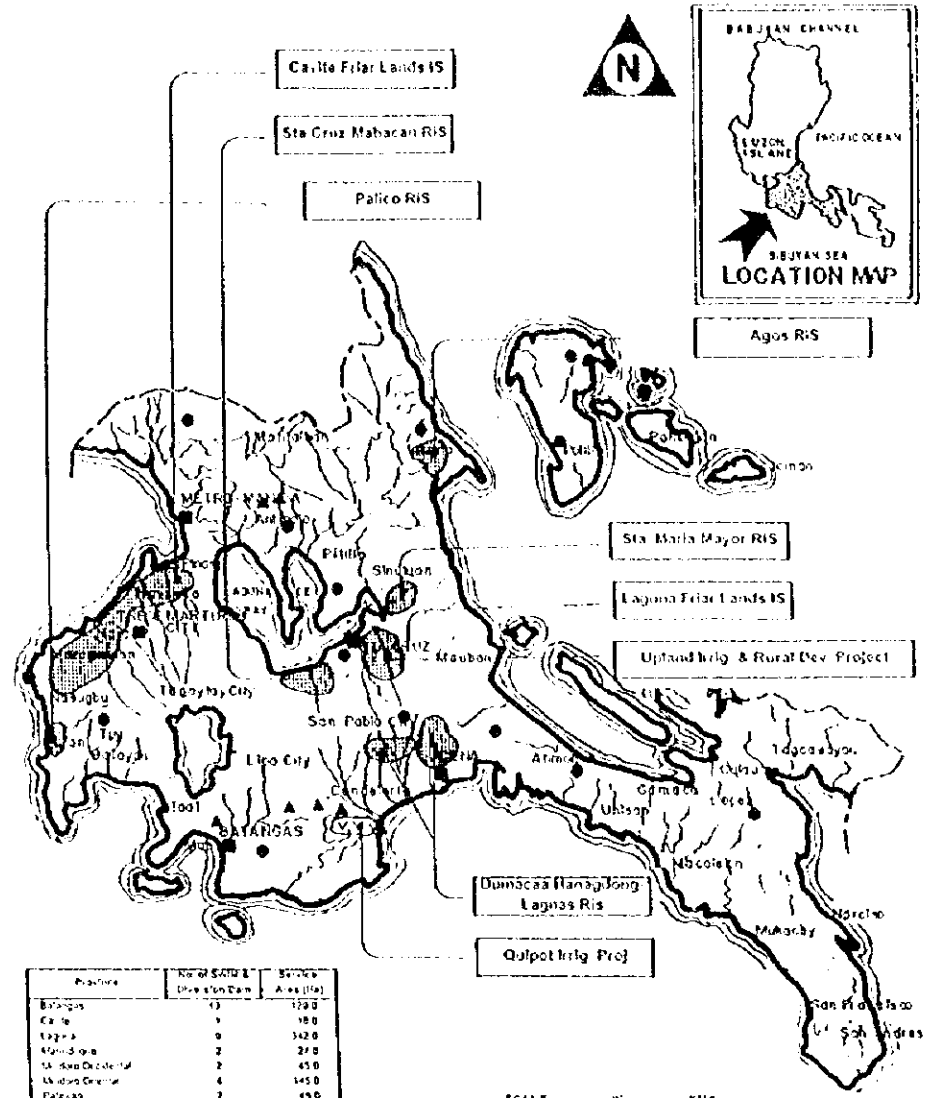

Figure F-2 LOCATION MAP OF IRRIGATION DEVELOPMENT SCHEMES: WATER RESOURCES REGION II

LEGEND

- Existing National Irrigation System, NIS
- Ongoing National Irrigation Project, NIP
- Proposed National Irrigation Project, NIP
- Existing Communal Irrigation System
- Ongoing Communal Irrigation Project
- Proposed Communal Irrigation Project
- Existing SWM Project/Diversion Dam
- Ongoing SWM Project/Diversion Dam
- Proposed SWM Project/Diversion Dam
- Existing Shallow Tubewell
- Ongoing Shallow Tubewell
- Proposed Shallow Tubewell
- Water Resources Region Boundary
- River Basin Boundary
- Provincial Capital
- Major Road



IRIS	Source	Service Area (ha)
Existing		
1 Carile Frías Lands IS		13960.0
2 Carile Frías RIS		2140.0
3 Palico RIS	Fañaluyan	8950.0
4 Orton		
5 Dumocao Mangrove Lagoon RIS	Amburayan	3300.0
6 Agus RIS	Ag. 1 River	11100.0
7 Mindao Oriental		
8 Balaog Mangrove Lagoon RIS	Balaog Bay	8020.0
9 Fila-Balunan RIS	Fila-Maraing R.	2530.0
10 Mindao Occidental		
11 Pagayan RIS	Pagayan River	1065.0
12 Cebu RIS	Encomienda River	1504.0
13 Sta Cruz Mahabun RIS	San Juan River	2280.0
14 Cagway RIS	Cagway River	3380.0
15 Papanan		
16 Balaog Mangrove RIS		618.0
17 Maligay RIS		2592.0
Laguna		
18 Laguna Frías Lands IS	Sto. Niño River	3210.0
19 Sta Cruz Mahabun RIS	Sta Cruz River	4072.0
20 Sta Maria Mayor RIS	Sta Maria Mayor	1733.0
TOTAL		112418.0

Province	No. of SWM & Diversion Dam	Service Area (ha)
Butuan	1	1200
Cebu	5	180
Laguna	0	1420
Mindanao	2	240
Mindao Occidental	2	450
Mindao Oriental	4	1450
Papanan	2	450
Orton	20	610
Rice	3	1200
Rizal	1	220
TOTAL	58	1270

Province	No. of Shallow Tubewell	Service Area (ha)
Butuan	0	145
Mindao Occidental	45	800
TOTAL	45	945

POTENTIAL IRRIGABLE AREA (ha) : 245950.00
 TOTAL SERVICE AREA (ha) : 110182.00
 IRRIGATION DEVELOPMENT (%) : 44.82

Proposed NIP
 1 Papanan Mangrove Area Dev. Proj. B. C. Papanan
 2 Upland Irrig. & Rural Dev. Proj. Laguna
 3 Output Irrig. Butuan

Province	No. of IRIS	Service Area (ha)
Butuan	61	27140
Cebu	5	3100
Laguna	101	45140
Mindanao	24	6930
Mindao Occidental	70	14200
Mindao Oriental	59	87250
Papanan	68	111200
Orton	220	94320
Rice	58	3192
Rizal	50	1710
TOTAL	537	36770

Note
 The latest data which were collected by the Study Team from the NIA regional offices during the Study period in 1997 were used to prepare this map.

Figure F-4 LOCATION MAP OF IRRIGATION DEVELOPMENT SCHEMES: WATER RESOURCES REGION IV (1/3)

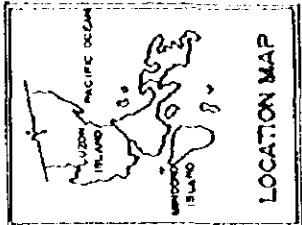

Note
The latest data which were collected by the Study Team from the NIA regional offices during the Study period in 1997 were used to prepare this map.



LEGEND

- Existing National Irrigation System, NIS
- On-going National Irrigation Project, NIP
- Proposed National Irrigation Project, NIP
- Existing Communal Irrigation System
- On-going Communal Irrigation Project
- Proposed Communal Irrigation Project
- Existing SWM Project/Diversion Dam
- On-going SWM Project/Diversion Dam
- Proposed SWM Project/Diversion Dam
- Existing Shallow Tubewell
- On-going Shallow Tubewell
- Proposed Shallow Tubewell
- Water Resources Region Boundary
- River Basin Boundary
- Province Capital
- River

Category	NIS	Source	Service Area (HA)
1. Central Agri. Land RI			13046.0
2. Casangas RIS			248.0
3. Pula - Bansud RIS			694.0
4. Pagbanan RIS			3009.0
5. Annay - Patrick RIS			1118.0
6. Baco-Bucayal/Maq-Asawang Tubig RI			6027.0
7. Pula - Bansud RIS			3009.0
8. Pagbanan RIS			1005.0
9. Lumintao RIS			104.0
10. Annay-Patrick RIS			2513.0
11. Casangas RIS			3008.0
12. Baco-Bucayal RIS			624.0
13. Lumintao RIS			2872.0
14. Luzon Agri. Land RI			3210.0
15. Luzon Agri. Land RI			4877.0
16. Luzon Agri. Land RI			1775.0
TOTAL			31742.0

Proposed NIP	No. of CDR	Service Area (HA)
1. Pula - Bansud RIS	64	2724.0
2. Casangas RIS	5	310.0
3. Pula - Bansud RIS	101	4874.0
4. Pagbanan RIS	34	983.0
5. Annay - Patrick RIS	70	3297.0
6. Baco-Bucayal/Maq-Asawang Tubig RI	46	11189.0
7. Pula - Bansud RIS	20	9832.0
8. Pagbanan RIS	50	3182.0
9. Lumintao RIS	30	1775.0
TOTAL	327	68774.0

Proposed	No. of SWM & Diversion Dams	Service Area (HA)
1. Luzon Agri. Land RI	1	18.0
2. Casangas RIS	8	342.0
3. Pula - Bansud RIS	2	77.0
4. Annay - Patrick RIS	2	45.0
5. Baco-Bucayal/Maq-Asawang Tubig RI	4	165.0
6. Pagbanan RIS	2	48.0
7. Pula - Bansud RIS	10	953.0
8. Lumintao RIS	3	127.0
TOTAL	24	1525.0

Proposed	No. of Shallow Tubewells	Service Area (HA)
1. Luzon Agri. Land RI	4	18.0
2. Casangas RIS	45	80.0
TOTAL	49	98.0

Category	Area (HA)
POTENTIAL IRRIGABLE AREA (HA)	24884.0
TOTAL SERVICE AREA (HA)	110124.0
IRRIGATION DEVELOPMENT (%)	22.5

Figure F-4 LOCATION MAP OF IRRIGATION DEVELOPMENT SCHEMES: WATER RESOURCES REGION IV (2/3)

No.	Source	Total Area (Ha)
Existing		
1	Canal Irrigation System	18420
2	Canal RIS	2580
3	Patubong	8500
4	Shallow Tubewell	3400
5	Agri RIS	11500
6	Patubong	8070
7	Patubong	1840
8	Patubong	1050
9	Patubong	1040
10	Patubong	2030
11	Patubong	3340
12	Patubong	680
13	Patubong	2070
Proposed		
14	Patubong	3260
15	Patubong	4070
16	Patubong	1770
TOTAL		97000

- Proposed NIP
 1. Patubong
 2. Shallow Tubewell
 3. Existing Patubong

Province	No. of RIS	Service Area (Ha)
Palawan	74	27240
Compostela	5	3100
Agri	103	45740
Patubong	74	6050
Shallow Tubewell	70	11700
Patubong	10	8250
Patubong	15	11000
Patubong	226	47320
Patubong	40	3490
Patubong	50	1910
TOTAL	237	58770

Province	No. of RIS	Service Area (Ha)
Palawan	11	1000
Compostela	1	180
Agri	8	3420
Patubong	2	270
Shallow Tubewell	2	450
Patubong	4	1450
Patubong	2	450
Patubong	20	6830
Patubong	3	2200
Patubong	2	270
TOTAL	58	19170

Province	No. of Shallow Tubewell	Service Area (Ha)
Palawan	0	0
Compostela	45	820
TOTAL	45	820

POTENTIAL IRRIGABLE AREA (Ha)	2169500
TOTAL SERVICE AREA (Ha)	1108250
IRRIGATION DEVELOPMENT (%)	44.82

LEGEND

- Existing National Irrigation System (NIS)
- Ongoing National Irrigation Project (NIP)
- Proposed National Irrigation Project (NIP)
- Existing Communal Irrigation System
- Ongoing Communal Irrigation Project
- Proposed Communal Irrigation Project
- Existing SWM Project/Division Dam
- Ongoing SWM Project/Division Dam
- Proposed SWM Project/Division Dam
- Existing Shallow Tubewell
- Ongoing Shallow Tubewell
- Proposed Shallow Tubewell
- Water Resources Region Boundary
- River Basin Boundary
- Province Capital
- River

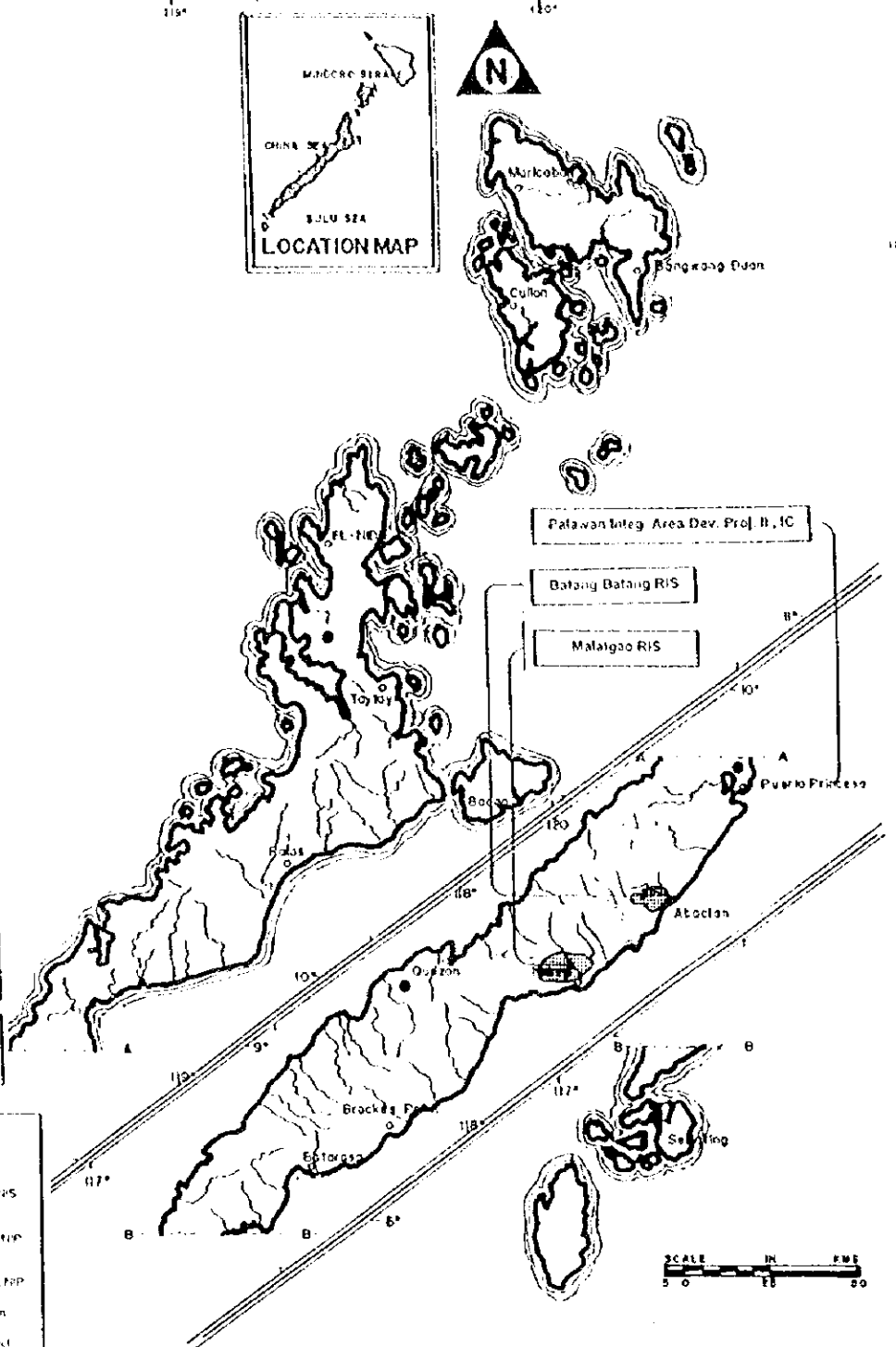

Note
 The latest data which were collected by the Study Team from the NIA regional offices during the Study period in 1997 were used to prepare this map.

Figure F-4 LOCATION MAP OF IRRIGATION DEVELOPMENT SCHEMES: WATER RESOURCES REGION IV (3/3)

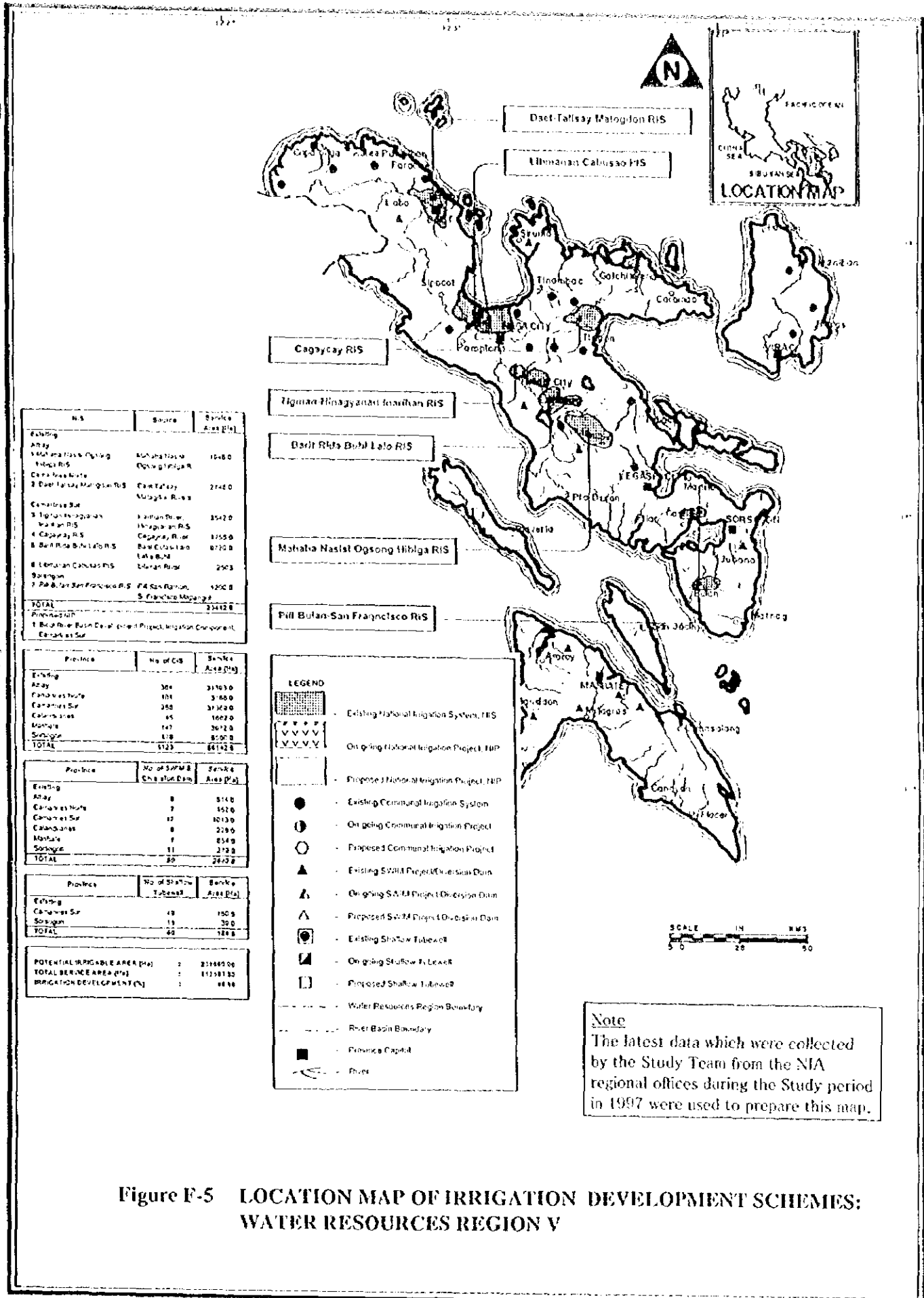

IRIS	Source	Service Area (Ha)
Existing		
Atay	Muhambayon	10400
Canawesthute	Opagan Pilihan	
Canawesthute		
2 Daet-Talsay Matagdon RIS	Canawesthute	27400
Canawesthute	Mulaga River	
3 Tigman Hinagyanan	San Juan River	35420
4 Cagaycay RIS	San Juan River	11550
5 Buhi-Buhil Lalo RIS	San Juan River	8720
6 Liriohan Calusao RIS	Liriohan River	2503
7 Pili-Bulan San Francisco RIS	San Francisco River	12000
8 Pili-Bulan San Francisco RIS	San Francisco River	12000
TOTAL		134120

Province	No. of CIR	Service Area (Ha)
Existing		
Atay	304	311030
Canawesthute	101	31600
Canawesthute	250	371000
Canawesthute	65	10020
Manila	147	30720
Sorsogon	178	81000
TOTAL	1123	661420

Province	No. of SPM & Check Dam	Service Area (Ha)
Existing		
Atay	0	0
Canawesthute	7	1550
Canawesthute	12	10130
Canawesthute	0	2290
Manila	1	0
Sorsogon	11	2120
TOTAL	20	2970

Province	No. of Shallow Tubewell	Service Area (Ha)
Existing		
Canawesthute	19	1500
Sorsogon	11	320
TOTAL	30	1820

POTENTIAL IRRIGABLE AREA (Ha)	2	23188500
TOTAL SERVICE AREA (Ha)	2	11218130
IRRIGATION DEVELOPMENT (%)	2	48.50

LEGEND

- Existing National Irrigation System, NIS
- Ongoing National Irrigation Project, NIP
- Proposed National Irrigation Project, NIP
- Existing Communal Irrigation System
- Ongoing Communal Irrigation Project
- Proposed Communal Irrigation Project
- Existing SWM Project/Division Dam
- Ongoing SWM Project/Division Dam
- Proposed SWM Project/Division Dam
- Existing Shallow Tubewell
- Ongoing Shallow Tubewell
- Proposed Shallow Tubewell
- Water Resources Region Boundary
- River Basin Boundary
- Province Capital
- River

Note
The latest data which were collected by the Study Team from the NIA regional offices during the Study period in 1997 were used to prepare this map.

Figure F-5 LOCATION MAP OF IRRIGATION DEVELOPMENT SCHEMES: WATER RESOURCES REGION V

No.	Service	Service Area (Ha)
Existing		
1	Atan RIS	36,800
2	Panukayan RIS	6,000
Proposed		
3	Sibafom-San Jose	5,000
4	Man-lusao RIS	14,200
5	Sibafom-Tigbaan RIS	7,200
6	Jafaur Suage RIS	14,400
7	Aganan-Sa. Barbara RIS	4,200
8	Man-lusao RIS	14,200
9	Bagas RIS	12,000
10	Pangipilan RIS	11,700
TOTAL		122,100

Province	No. of CIR	Service Area (Ha)
Existing	28	27,400
Atan	10	6,800
Man-lusao	28	24,100
Bagas	10	7,600
Man-lusao	25	21,100
Man-lusao	4	2,100
TOTAL	115	123,300

Province	No. of SMM & Diversion Dam	Service Area (Ha)
Existing	11	3,300
Atan	8	10,800
Man-lusao	14	35,700
Man-lusao	28	14,100
Man-lusao	4	10,100
Man-lusao	4	500
TOTAL	69	74,500

Province	No. of Shallow Tubewell	Service Area (Ha)
Existing	24	495
Atan	6	145
Man-lusao	87	1,100
Man-lusao	34	1,250
TOTAL	151	2,990

POTENTIAL IRRIGABLE AREA (Ha)	181,338.00
TOTAL SERVICE AREA (Ha)	284,932.40
IRRIGATION DEVELOPMENT (%)	40.67

- Sibafom-San Jose
- Sibafom-San Jose Res. Proj
- Sibafom-Tigbaan RIS
- Aganan-Sa. Barbara RIS
- Jafaur Multi Purpose Proj

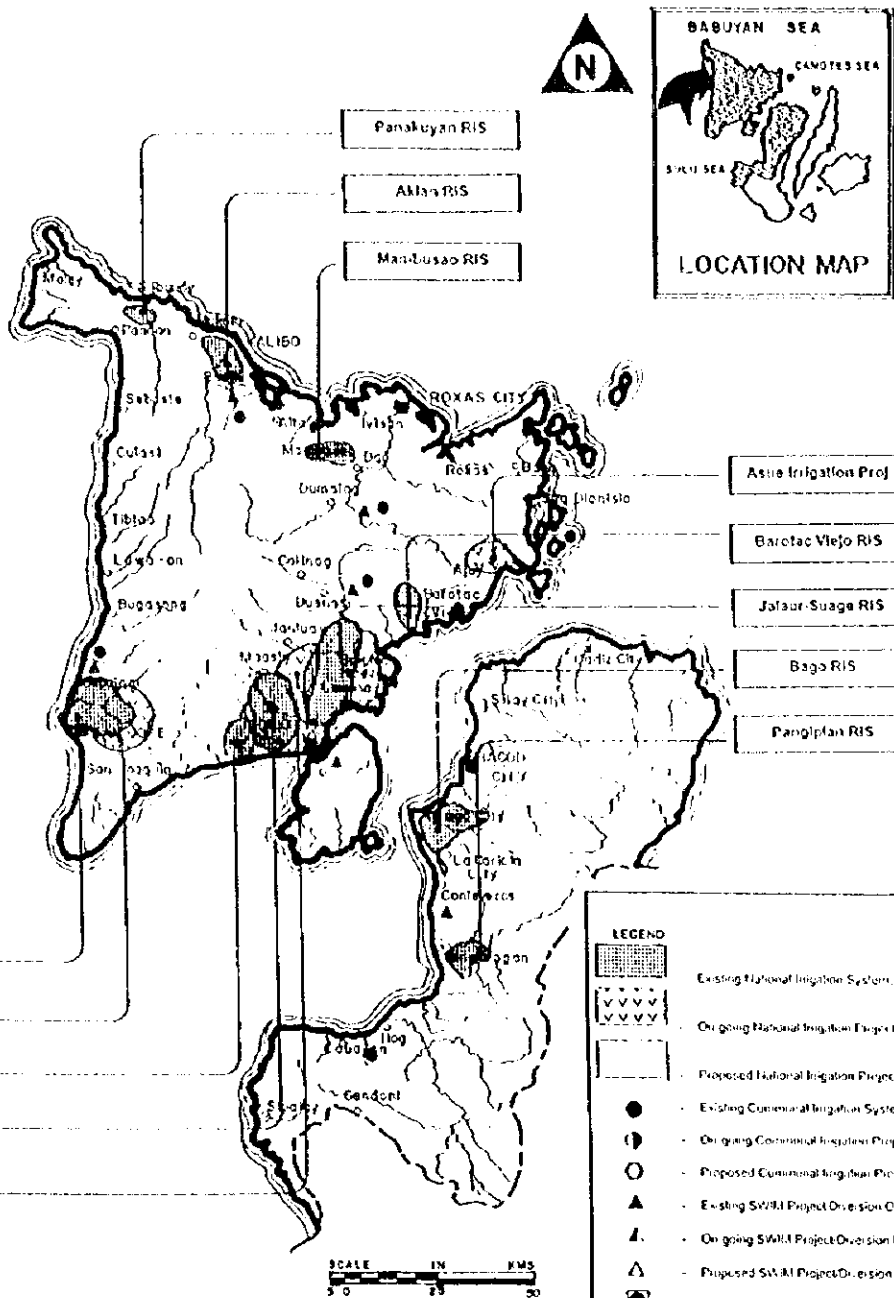

Note
The latest data which were collected by the Study Team from the NIA regional offices during the Study period in 1997 were used to prepare this map.

LEGEND

- Existing National Irrigation System, NIS
- Ongoing National Irrigation Project, NIP
- Proposed National Irrigation Project, NIP
- Existing Commercial Irrigation System
- Ongoing Commercial Irrigation Project
- Proposed Commercial Irrigation Project
- Existing SWRI Project Diversion Dam
- Ongoing SWRI Project Diversion Dam
- Proposed SWRI Project Diversion Dam
- Existing Shallow Tubewell
- Ongoing Shallow Tubewell
- Proposed Shallow Tubewell
- Water Resources Region Boundary
- River Basin Boundary
- Province Capital
- River

Figure F-6 LOCATION MAP OF IRRIGATION DEVELOPMENT SCHEMES: WATER RESOURCES REGION VI

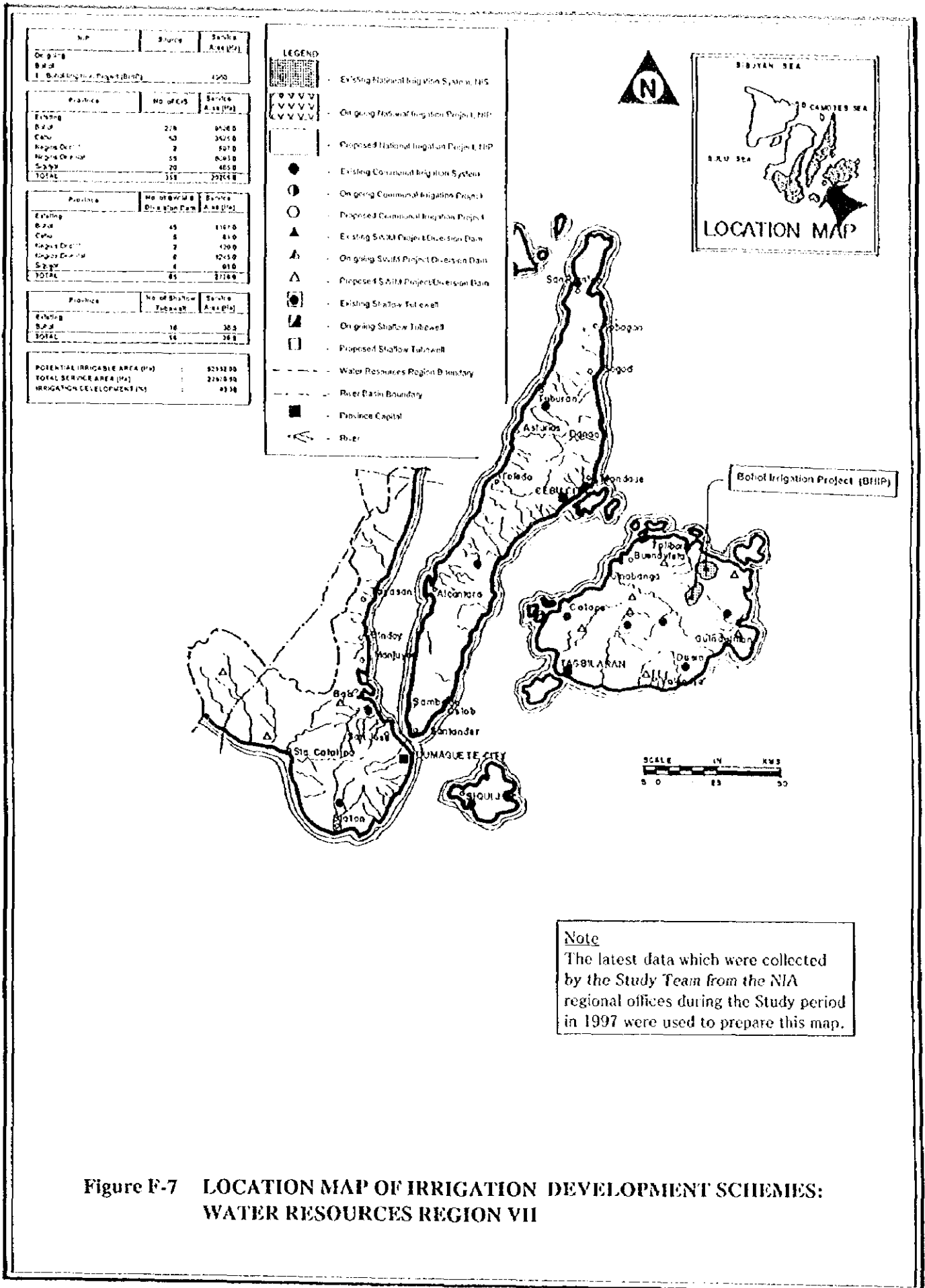

Figure F-7 LOCATION MAP OF IRRIGATION DEVELOPMENT SCHEMES: WATER RESOURCES REGION VII

NO	Source	Service Area (Ha)
Existing		
1	Banatuan	10170
2	Catagan Man R	14110
3	Catagan Guara R	14060
4	Sungay River	6420
5	Pulungan	17150
6	Catagan	6740
7	Maguindanao	2180
8	Compostela	7000
TOTAL		100720

Province	No. of RIS	Service Area (Ha)
Existing		
Maguindanao	147	226710
Sarangani	123	42010
Davao del Norte	89	29560
Davao del Sur	45	20560
Compostela	23	18330
TOTAL	427	519530

Province	No. of RIS	Service Area (Ha)
Existing		
Maguindanao	9	2450
Sarangani	17	3150
Davao del Norte	0	2120
Davao del Sur	0	1710
Compostela	0	530
TOTAL	26	10360

Province	No. of RIS	Service Area (Ha)
Existing		
Maguindanao	2	135
TOTAL	2	135

POTENTIAL IRRIGABLE AREA (Ha)	810000
TOTAL SERVICE AREA (Ha)	519530
IRRIGATION DEVELOPMENT (%)	63.2

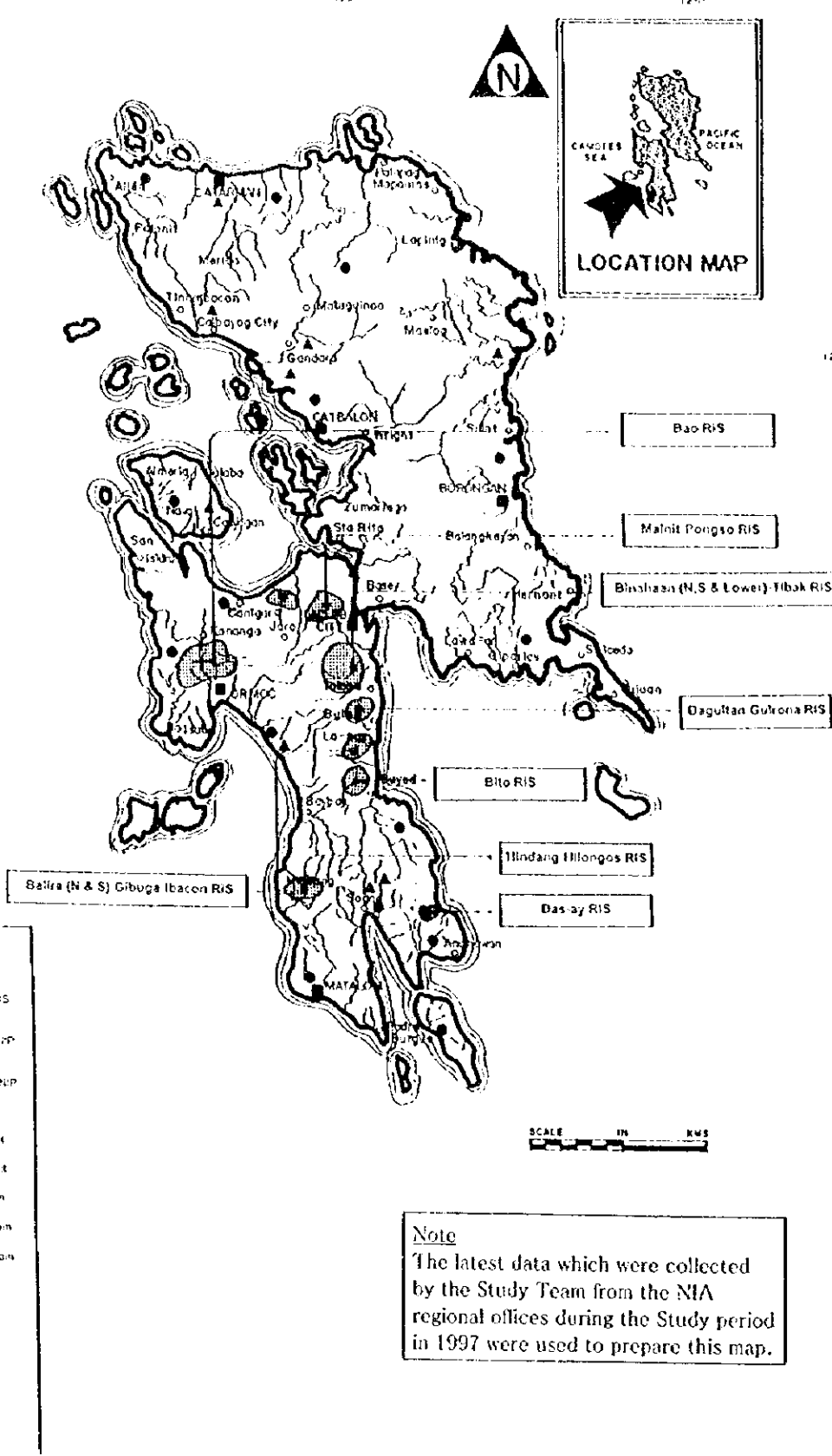

Figure F-8 LOCATION MAP OF IRRIGATION DEVELOPMENT SCHEMES: WATER RESOURCES REGION VIII

Note
The latest data which were collected by the Study Team from the NIA regional offices during the Study period in 1997 were used to prepare this map.

WIS	Source	Service Area (Ha)
Existing		
Zamboanga del Sur		
1. Labangan RIS	Labangan River	31650
2. Salug RIS	Salug-Cahu Salu	72240
3. Dipolo RIS	Dipolo-Tunayan	10760
4. Sibuguey Valley RIS	Sibuguey & Cayan	31430
TOTAL		146080

Province	No. of CIS	Service Area (Ha)
Existing		
Palawan	2	2500
Misamis Occidental	45	63180
Zamboanga del Norte	51	53440
Zamboanga del Sur	128	128000
TOTAL	312	213120

Province	No. of SHM & Dike/Diversion Dam	Service Area (Ha)
Existing		
Misamis Occidental	8	1340
SAAR	3	1800
Tawi-Tawi	2	110
Zamboanga del Norte	13	1500
Zamboanga del Sur	23	10780
TOTAL	49	14530

Province	No. of Shallow Tubewells	Service Area (Ha)
Existing		
Zamboanga del Sur	30	1500
TOTAL	30	1500

POTENTIAL IRRIGABLE AREA (Ha)	821400
TOTAL SERVICE AREA (Ha)	451800
IRRIGATION DEVELOPMENT (%)	55.00

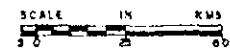
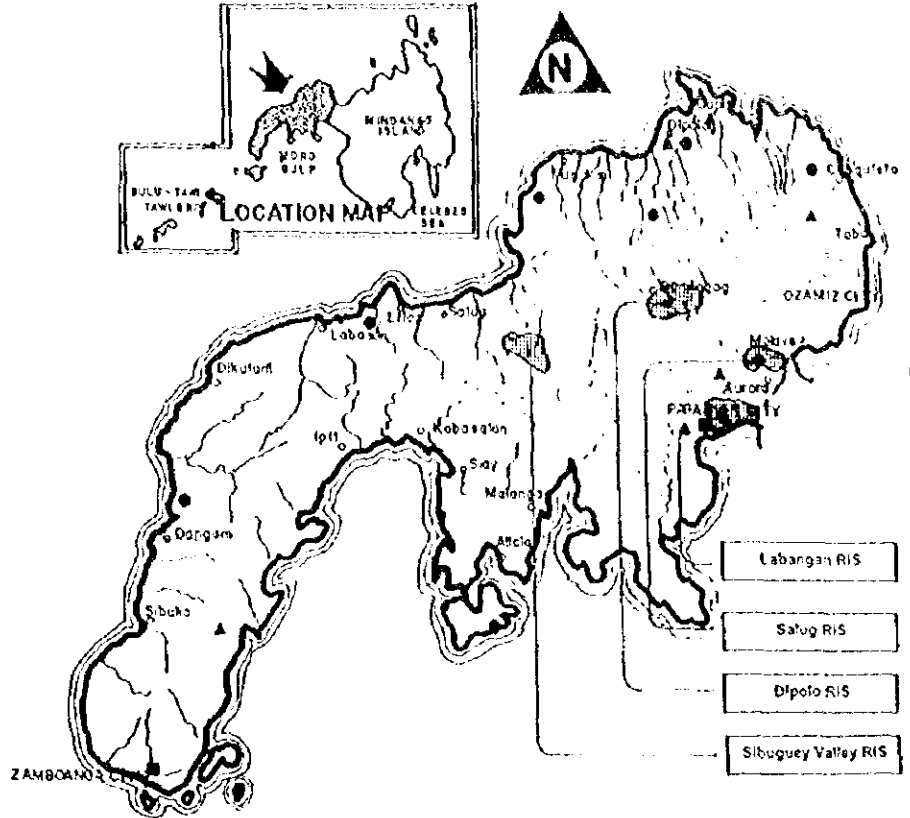

Note
The latest data which were collected by the Study Team from the NIA regional offices during the Study period in 1997 were used to prepare this map.

LEGEND

- Existing National Irrigation Systems (NIS)
- Ongoing National Irrigation Project (NIP)
- Proposed National Irrigation Project (NIP)
- Existing Communal Irrigation System
- Ongoing Communal Irrigation Project
- Proposed Communal Irrigation Project
- Existing SWM Project/Diversion Dam
- Ongoing SWM Project/Diversion Dam
- Proposed SWM Project/Diversion Dam
- Existing Shallow Tubewell
- Ongoing Shallow Tubewell
- Proposed Shallow Tubewell
- Water Resources Region Boundary
- River Basin Boundary
- Provincial Capital
- Port

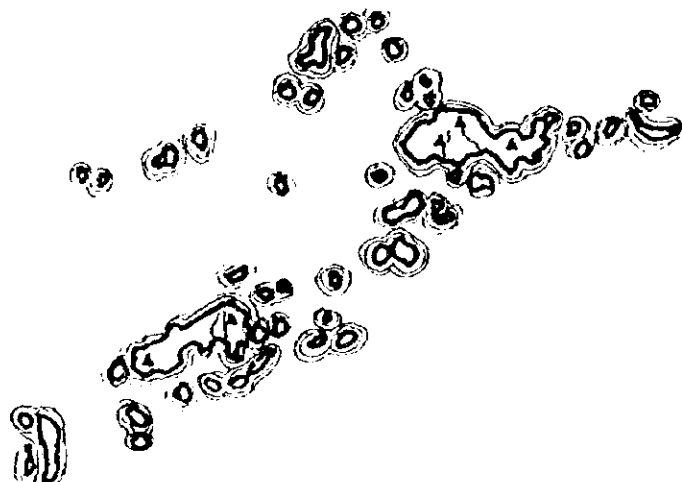

Figure F-9 LOCATION MAP OF IRRIGATION DEVELOPMENT SCHEMES: WATER RESOURCES REGION IX

No.	Source	Service Area (Ha)
Existing		
1	Agusan del Norte	
2	Caladbaran Taguibo RIS	32,170
3	Agusan del Sur	
4	Andanan RIS	34,400
5	Gihong RIS	26,190
6	Lower Agusan Dev. Proj.	2,560
7	Agusan del Norte***	
8	Agusan del Sur	32,690
TOTAL		141,720
Proposed NIP		
1	Laguin Baobo IP	
2	Lower Agusan Dev. Proj. Agusan del Norte	
3	Bukayan-Tumalaang IP, Bukayan	
4	Talakag IP, Bukayan	

Province	No. of RIS	Service Area (Ha)
Existing		
Agusan del Norte	74	55,000
Agusan del Sur	87	56,150
Bukayan***	12	2,180
Campal	53	9,200
Marikina Oriental	52	17,000
Agusan del Norte***	12	27,240
Agusan del Sur	103	56,740
TOTAL	333	217,630

Province	No. of SWSM & Shallow Tubewell	Service Area (Ha)
Existing		
Agusan del Norte	21	8,500
Agusan del Sur	10	2,120
Bukayan***	3	800
Campal	10	14,800
Marikina Oriental	8	3,800
Agusan del Norte***	2	1,200
Agusan del Sur	24	8,140
TOTAL	78	39,360

Province	No. of Shallow Tubewell	Service Area (Ha)
Existing		
Bukayan***	22	2,170
Marikina Oriental	3	800
Agusan del Norte***	5	1,550
TOTAL	30	4,520

POTENTIAL IRRIGABLE AREA (PIA)	1813,730
TOTAL SERVICE AREA (SA)	454,930
IRRIGATION DEVELOPMENT (%)	25.35

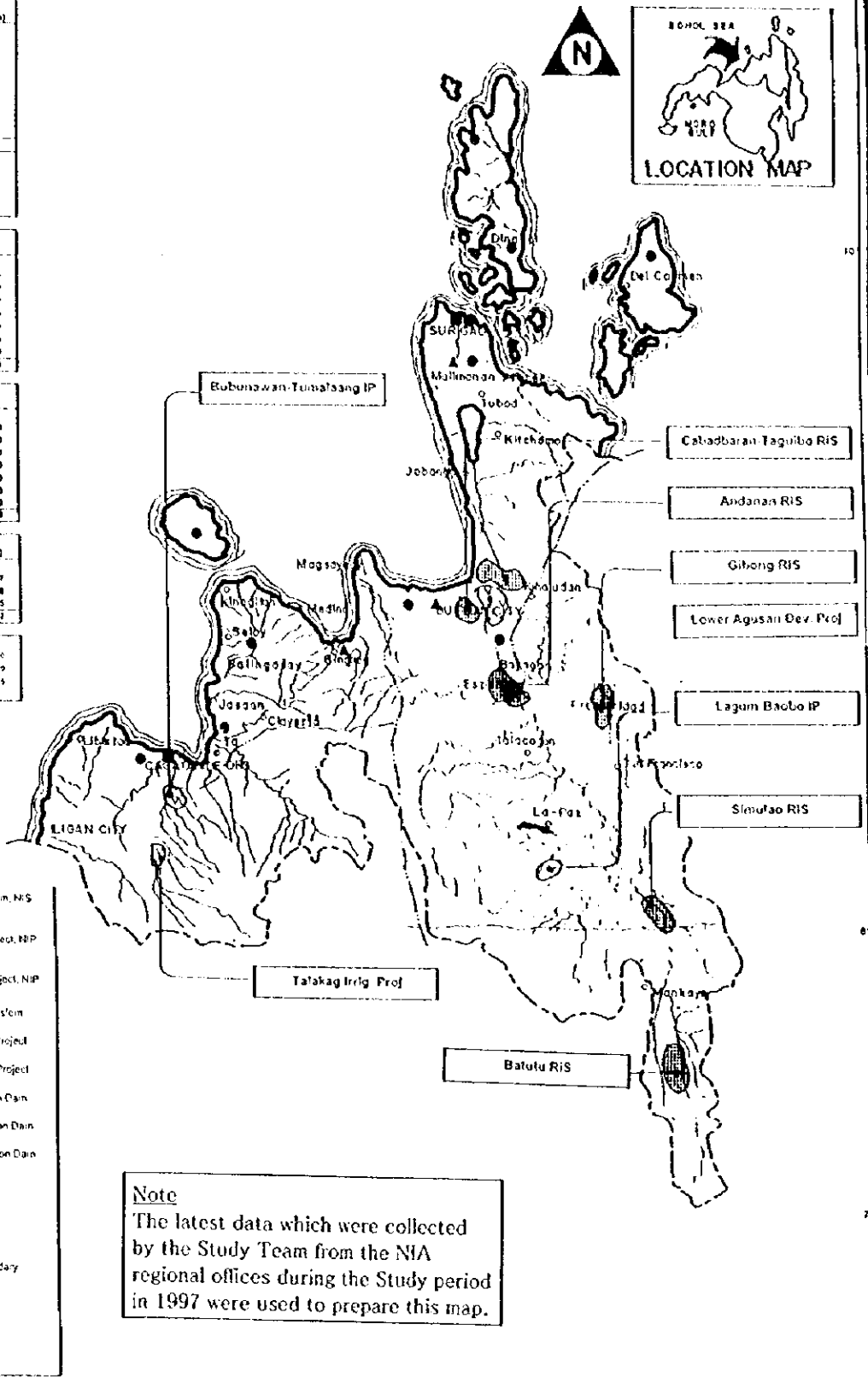

LEGEND

- Existing National Irrigation System, NIS
- Ongoing National Irrigation Project, NIP
- Proposed National Irrigation Project, NIP
- Existing Communal Irrigation System
- Ongoing Communal Irrigation Project
- Proposed Communal Irrigation Project
- Existing SWSM Project/Division Dam
- Ongoing SWSM Project/Division Dam
- Proposed SWSM Project/Division Dam
- Existing Shallow Tubewell
- Ongoing Shallow Tubewell
- Proposed Shallow Tubewell
- Water Resources Region Boundary
- River Basin Boundary
- Province Capital
- River

Note
The latest data which were collected by the Study Team from the NIA regional offices during the Study period in 1997 were used to prepare this map.

Figure F-10 LOCATION MAP OF IRRIGATION DEVELOPMENT SCHEMES: WATER RESOURCES REGION X

IRIS	Source	Service Area (Ha)
Existing		
Divisa del Norte		
1 Saug Saug Libuganon RIS	Saug River	3420.0
2 Saug Saug Libuganon RIS	Saug River	13043.0
3 Divisa Oriental	Lupon River	2431.0
4 Divisa del Sur		2520.0
5 Palala RIS	Palala River	3512.0
6 South Coastal		
7 Siluay Buayan RIS		2418.0
8 Saug Saug Libuganon RIS		
9 Canlan RIS	Canlan Subarea	1288.0
10 Tago RIS		2002.0
TOTAL		30719.0

Province	No. of CIRs	Service Area (Ha)
Existing		
Divisa del Norte	47	8521.0
Divisa del Oriental	22	7360.0
Divisa del Sur	81	12618.0
South Coastal	20	3000.0
Saug Saug Libuganon	25	2618.0
TOTAL	175	30319.0

Province	No. of SWM & Diversion Dams	Service Area (Ha)
Existing		
Divisa del Norte	8	810.0
Divisa del Oriental	3	450.0
Divisa del Sur	13	1400.0
Saug Saug Libuganon	8	1518.0
TOTAL	32	2778.0

Province	No. of Shallow Tubewells	Service Area (Ha)
Existing		
Divisa del Norte	4	18
Divisa del Sur	1	3
South Coastal	14	41.8
TOTAL	19	62.6

POTENTIAL IRRIGABLE AREA (Ha)	:	10451.00
TOTAL SERVICE AREA (Ha)	:	82435.50
IRRIGATION DEVELOPMENT (%)	:	37.14

LEGEND	
	Existing National Irrigation System, NIS
	On-going National Irrigation Project, NIP
	Proposed National Irrigation Project, NIP
	Existing Communal Irrigation System
	On-going Communal Irrigation Project
	Proposed Communal Irrigation Project
	Existing SWM Project/Diversion Dam
	On-going SWM Project/Diversion Dam
	Proposed SWM Project/Diversion Dam
	Existing Shallow Tubewell
	On-going Shallow Tubewell
	Proposed Shallow Tubewell
	Water Resources Region Boundary
	River Basin Boundary
	Province Capital
	River

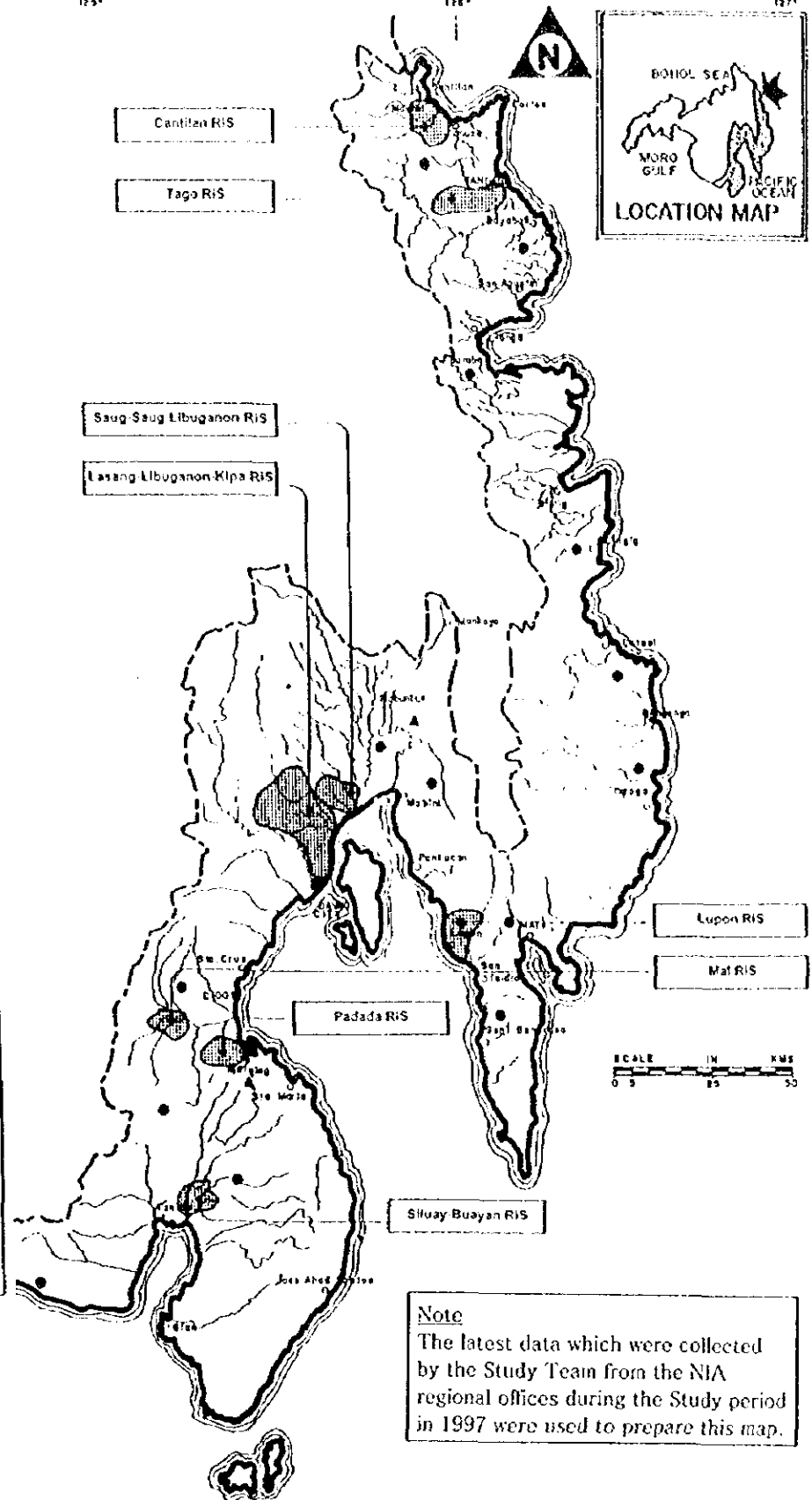

Figure F-11 LOCATION MAP OF IRRIGATION DEVELOPMENT SCHEMES: WATER RESOURCES REGION XI

RIS	Source	Service Area (ha)
Existing		
1 Pulang-Roxas-Kuya RIS	Pulang-Rugan	9700
2 Maranding RIS	Maranding	4300
3 Maling RIS	Maling	4700
4 Marang RIS	Marang	4500
5 Lantad RIS	Lantad	2500
6 Rigan RIS	Rigan	3600
7 Ag-Talayan RIS	Ag-Talayan	3000
8 Bungan RIS (Part)	Bungan	800
9 Eruogan RIS	Eruogan	8500
10 Maranan RIS	Maranan	4800
11 Mlang Malasita RIS	Mlang Malasita	10000
12 Lantad-Dumaguil RIS	Lantad-Dumaguil	10000
13 Alib-Banga-Marbel RIS	Alib-Banga-Marbel	10000
TOTAL		111500

Proposed NIP
 1 Kaban IADP Maguindayao
 2 Kadingitan Sub-Project of Kadingitan RIS Lantad-Dumaguil
 3 Kadingitan Irrigation Project Baidaro

Province	No. of RIS	Service Area (ha)
Existing		
Baidaro	81	28400
Maguindayao	78	83100
Lantad-Dumaguil	8	12100
Maguindayao	54	81500
North Cotabato	72	97400
South Cotabato	47	73600
Surigao	50	126300
TOTAL	324	840400

Province	No. of Shallow Tubewell	Service Area (ha)
Existing		
Maguindayao	20	870
Lantad-Dumaguil	10	450
Maguindayao	8	1400
Maguindayao	7	3000
North Cotabato	14	12100
South Cotabato	9	3000
Surigao	11	810
TOTAL	79	47100

Province	No. of Shallow Tubewell	Service Area (ha)
Existing		
Maguindayao	63	1430
North Cotabato	85	2810
South Cotabato	14	610
TOTAL	162	4850

POTENTIAL IRRIGABLE AREA (ha) : 8138100
 TOTAL SERVICE AREA (ha) : 1058330
 IRRIGATION DEVELOPMENT (%) : 2100

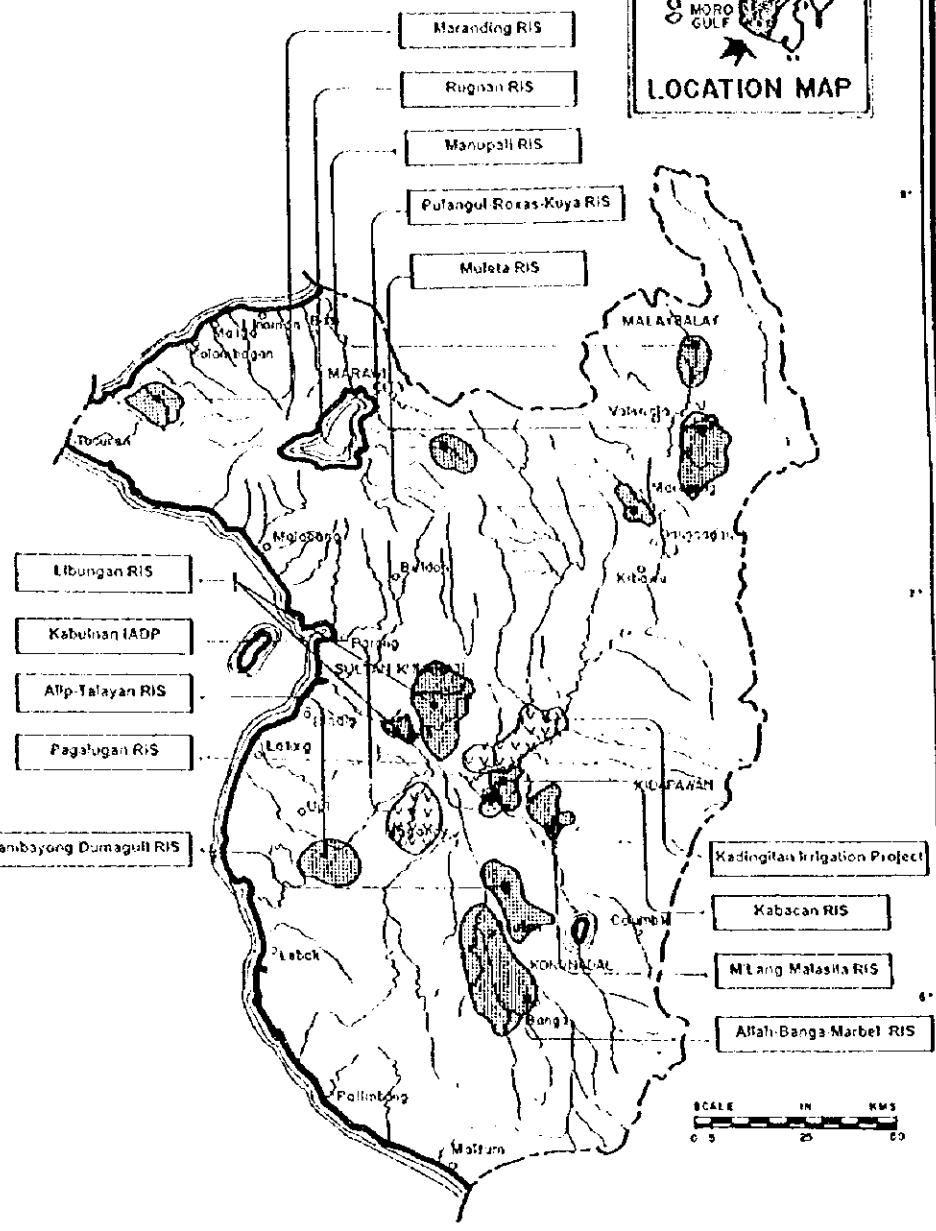
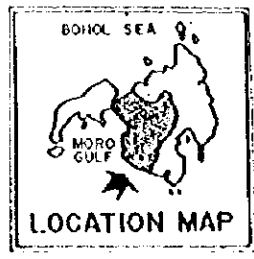

LEGEND

- Existing National Irrigation System (NIS)
- Ongoing National Irrigation Project (NIP)
- Proposed National Irrigation Project (NIP)
- Existing Communal Irrigation System
- Ongoing Communal Irrigation Project
- Proposed Communal Irrigation Project
- Existing SWM Project/Division Dam
- Ongoing SWM Project/Division Dam
- Proposed SWM Project/Division Dam
- Existing Shallow Tubewell
- Ongoing Shallow Tubewell
- Proposed Shallow Tubewell
- Water Resources Region Boundary
- River Basin Boundary
- Province Capital
- River

Note
 The latest data which were collected by the Study Team from the NIA regional offices during the Study period in 1997 were used to prepare this map.

Figure F-12 LOCATION MAP OF IRRIGATION DEVELOPMENTS SCHEMES: WATER RESOURCES REGION XII

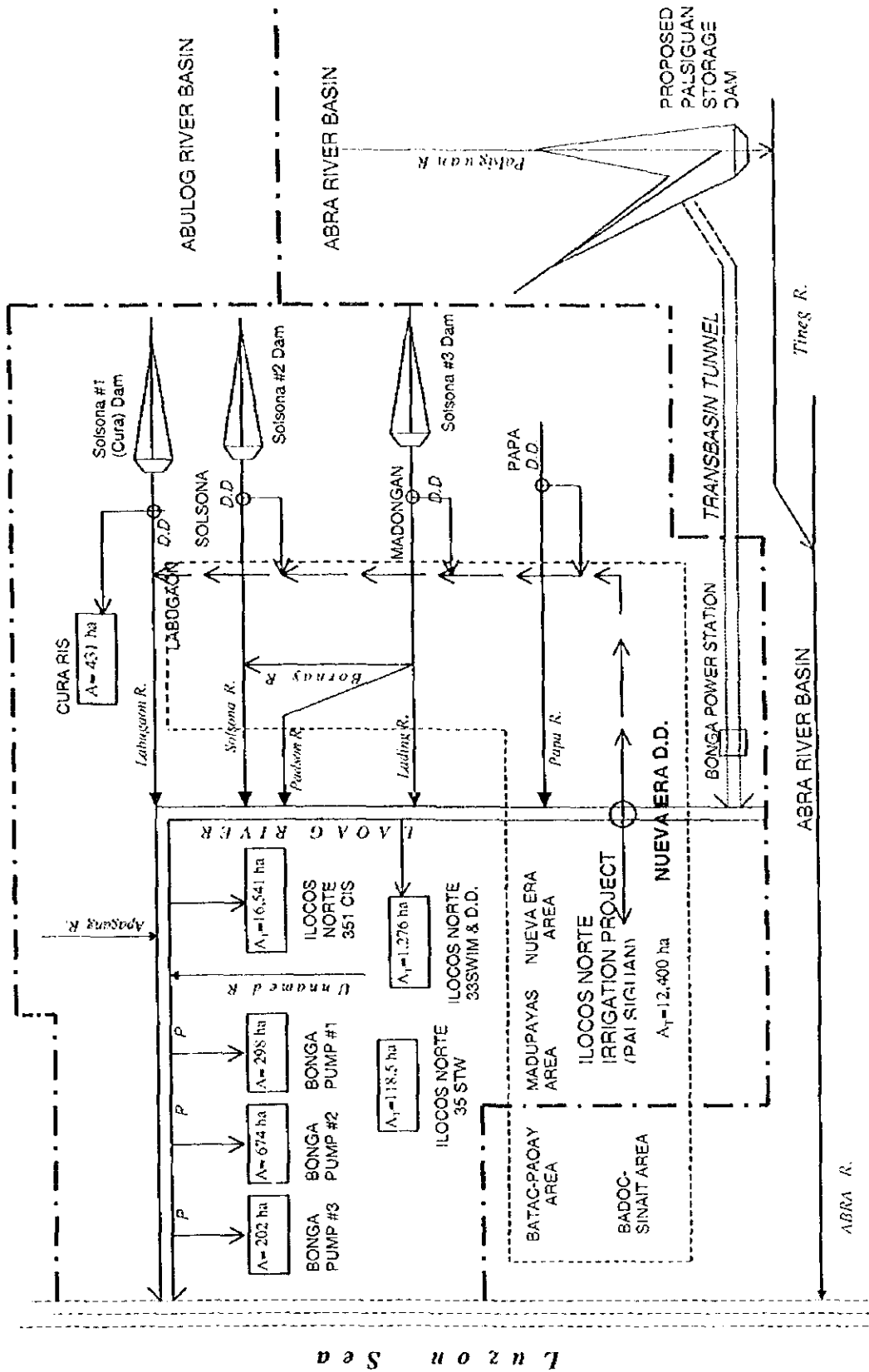

Figure F-13 SCHEMATIC DIAGRAM OF IRRIGATION DEVELOPMENT SCHEMES:
LAOAG RIVER BASIN (WRR 1)

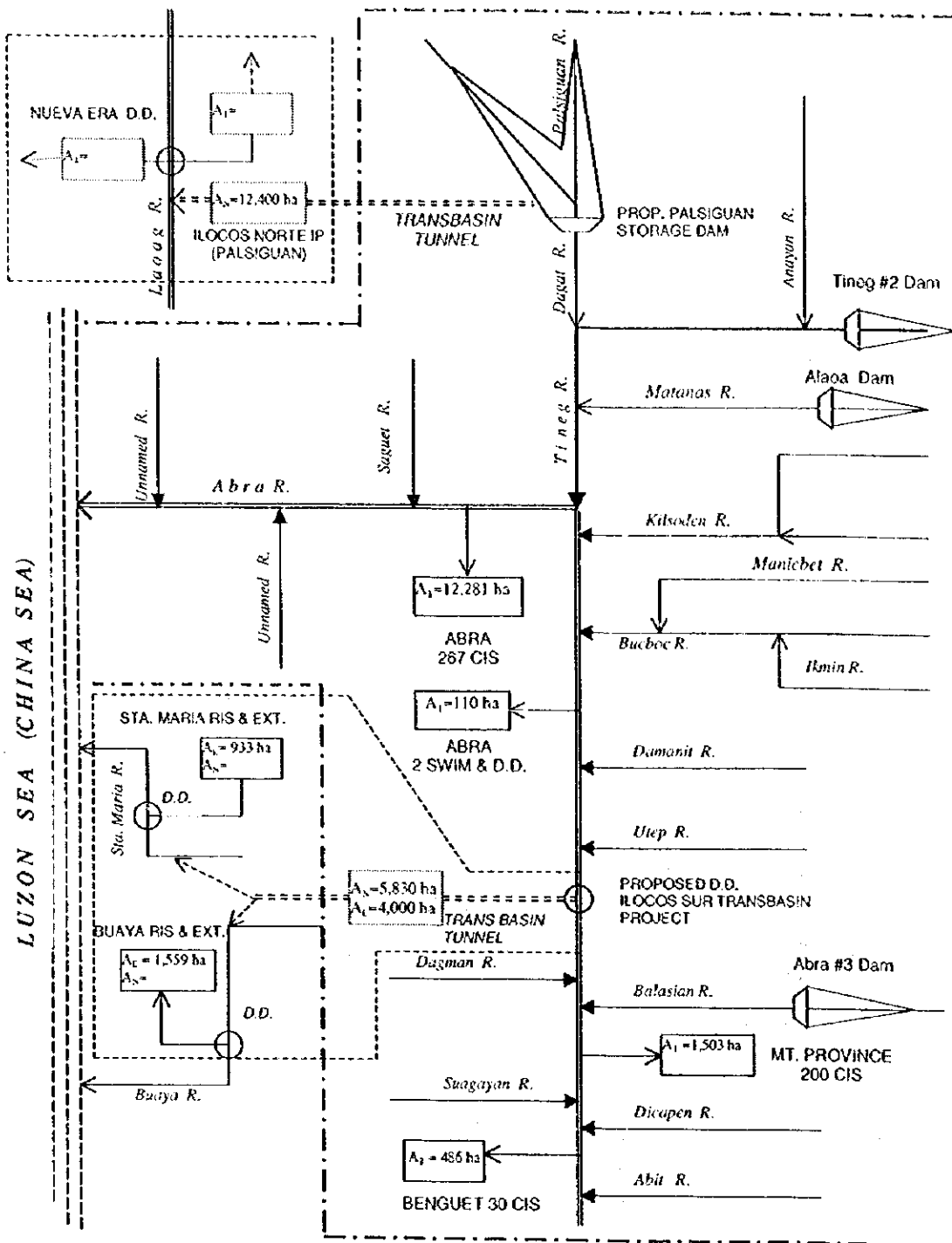

Figure F-14 SCHEMATIC DIAGRAM OF IRRIGATION DEVELOPMENT SCHEMES: ABRA RIVER BASIN (WRR I)

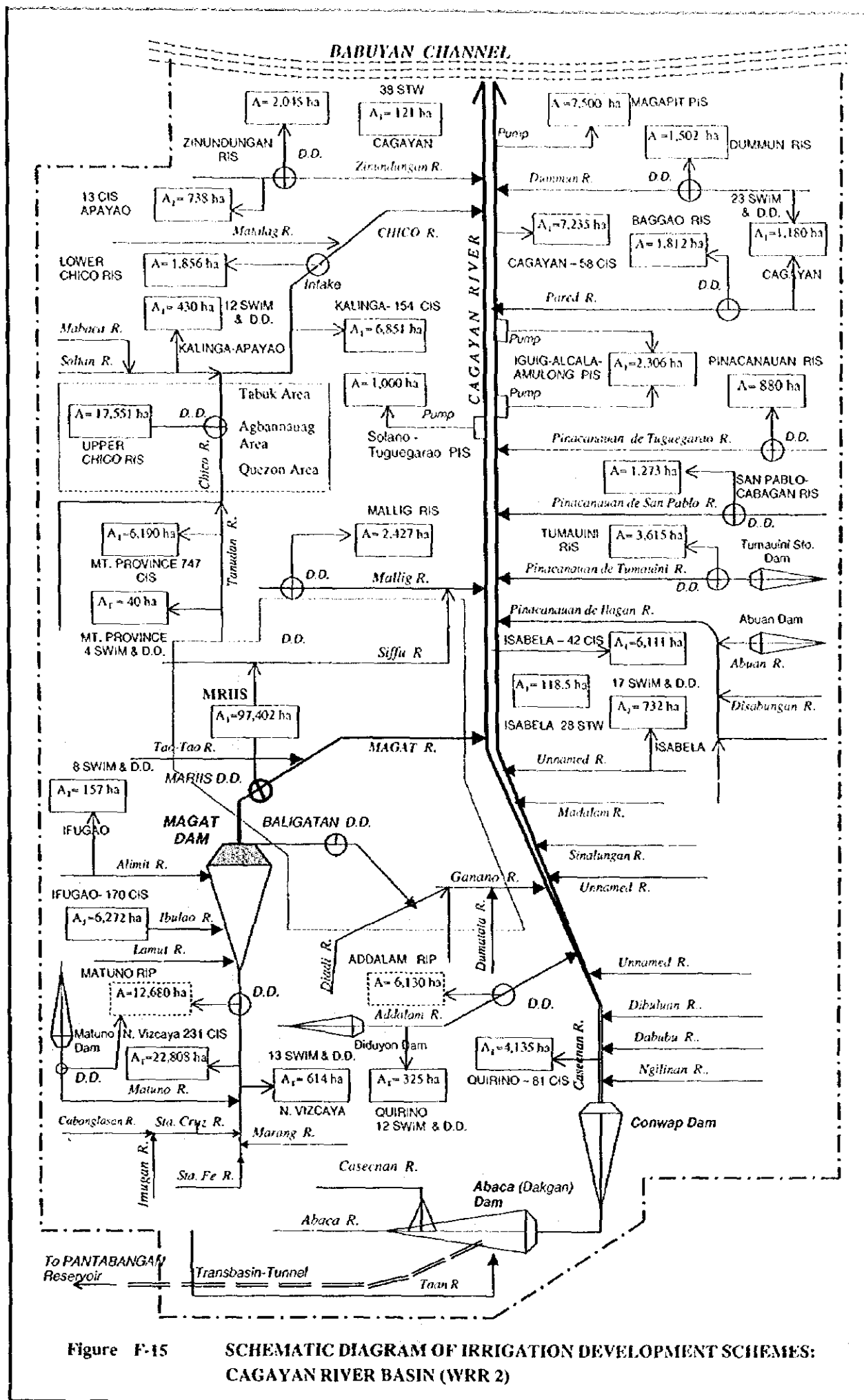

Figure F-15 SCHEMATIC DIAGRAM OF IRRIGATION DEVELOPMENT SCHEMES: CAGAYAN RIVER BASIN (WRR 2)

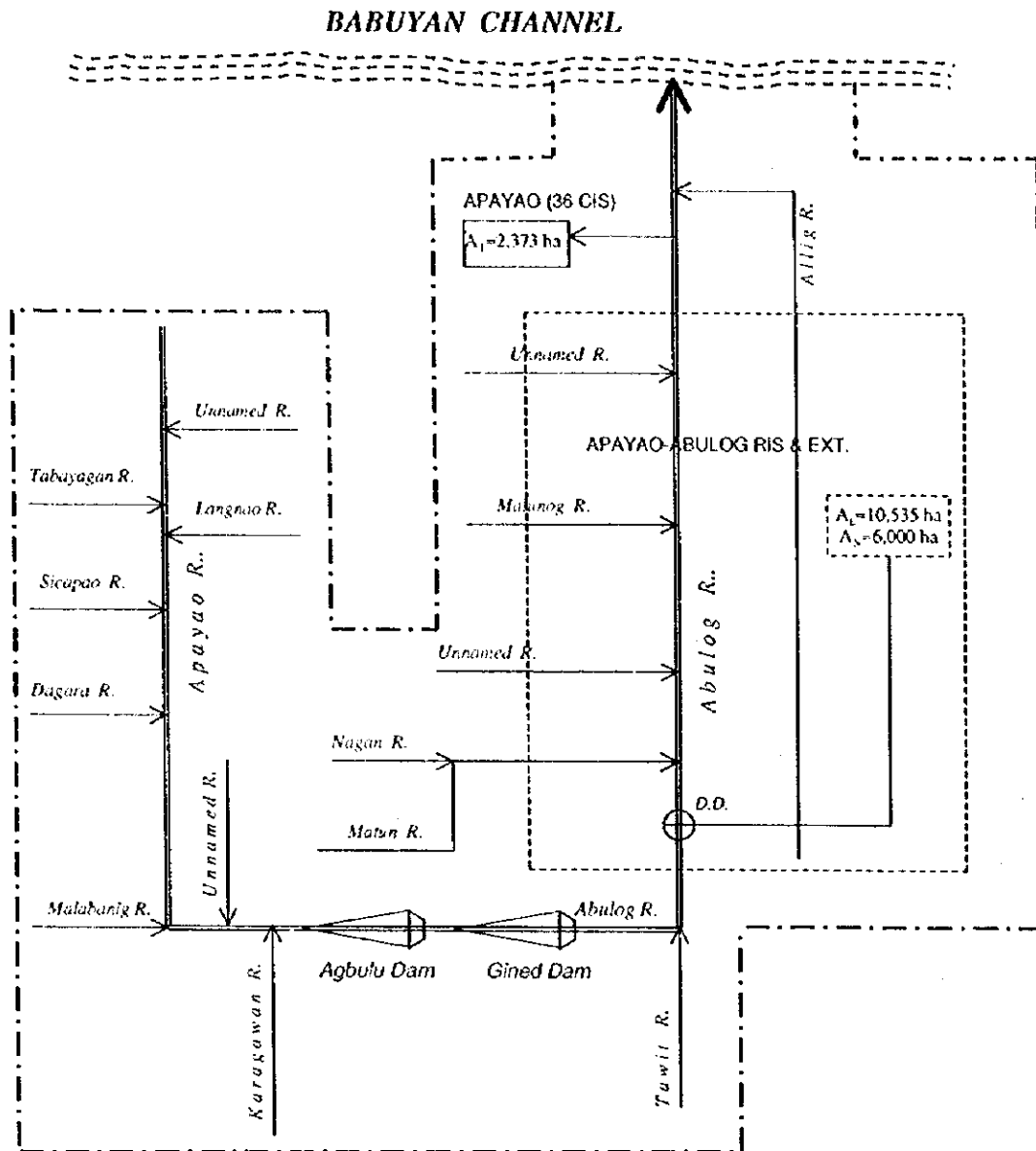

Figure F-16

**SCHEMATIC DIAGRAM OF IRRIGATION DEVELOPMENT SCHEMES:
ABULOG RIVER BASIN (WRR 2)**

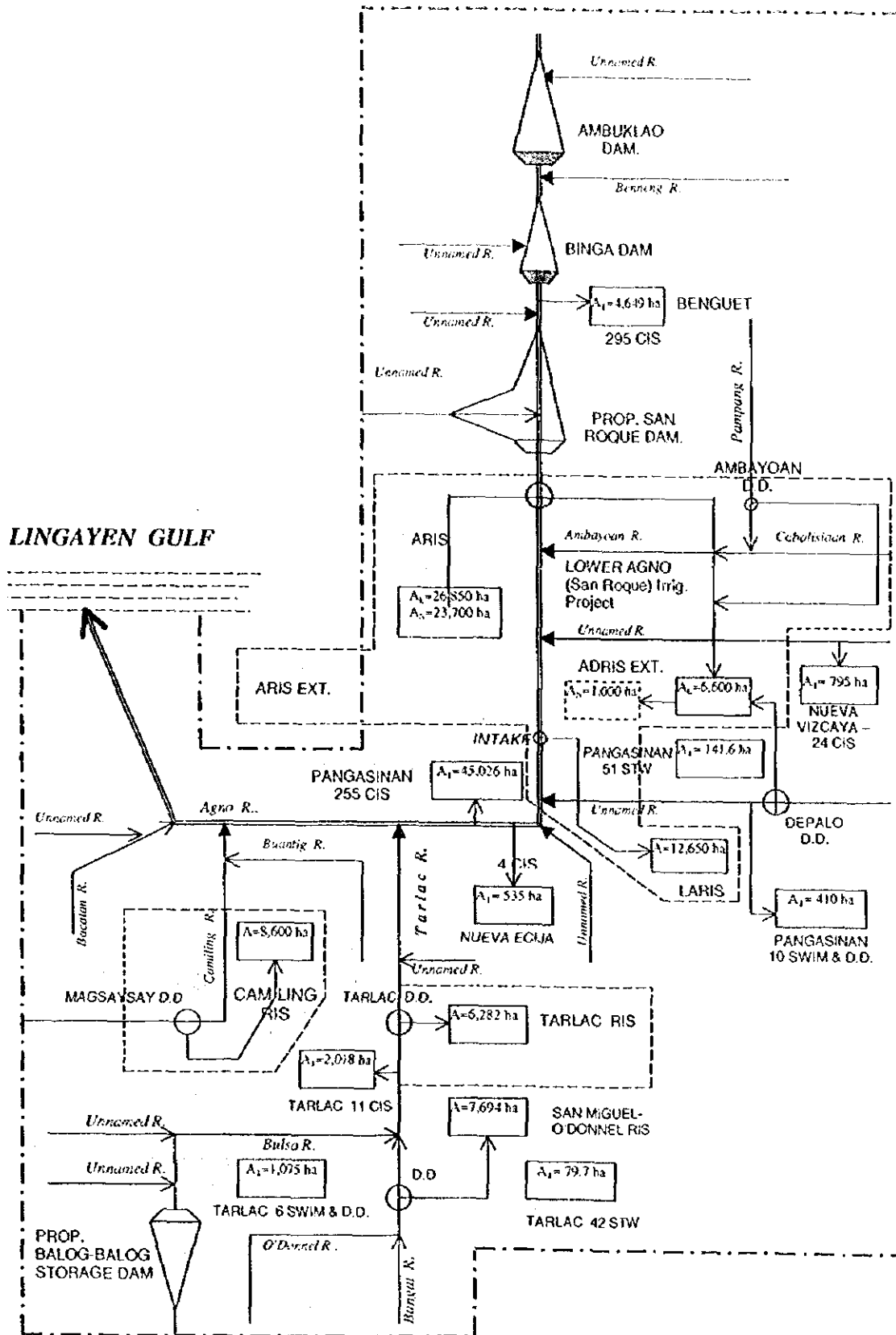

Figure F-17 SCHEMATIC DIAGRAM OF IRRIGATION DEVELOPMENT SCHEMES: AGNO RIVER BASIN (WRR 3)

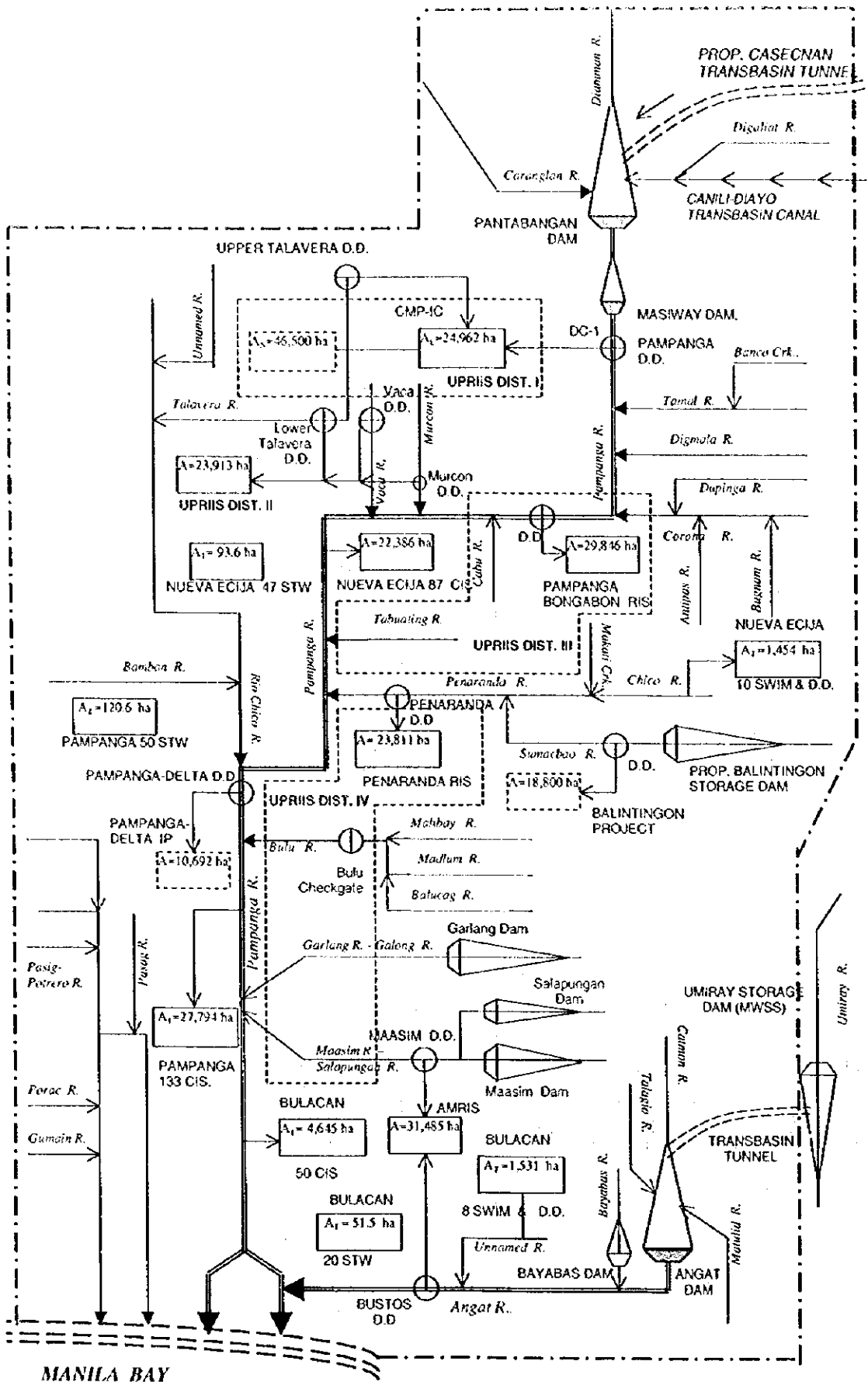

Figure F-18 SCHEMATIC DIAGRAM OF IRRIGATION DEVELOPMENT SCHEMES: PAMPANGA RIVER BASIN (WRR 3)

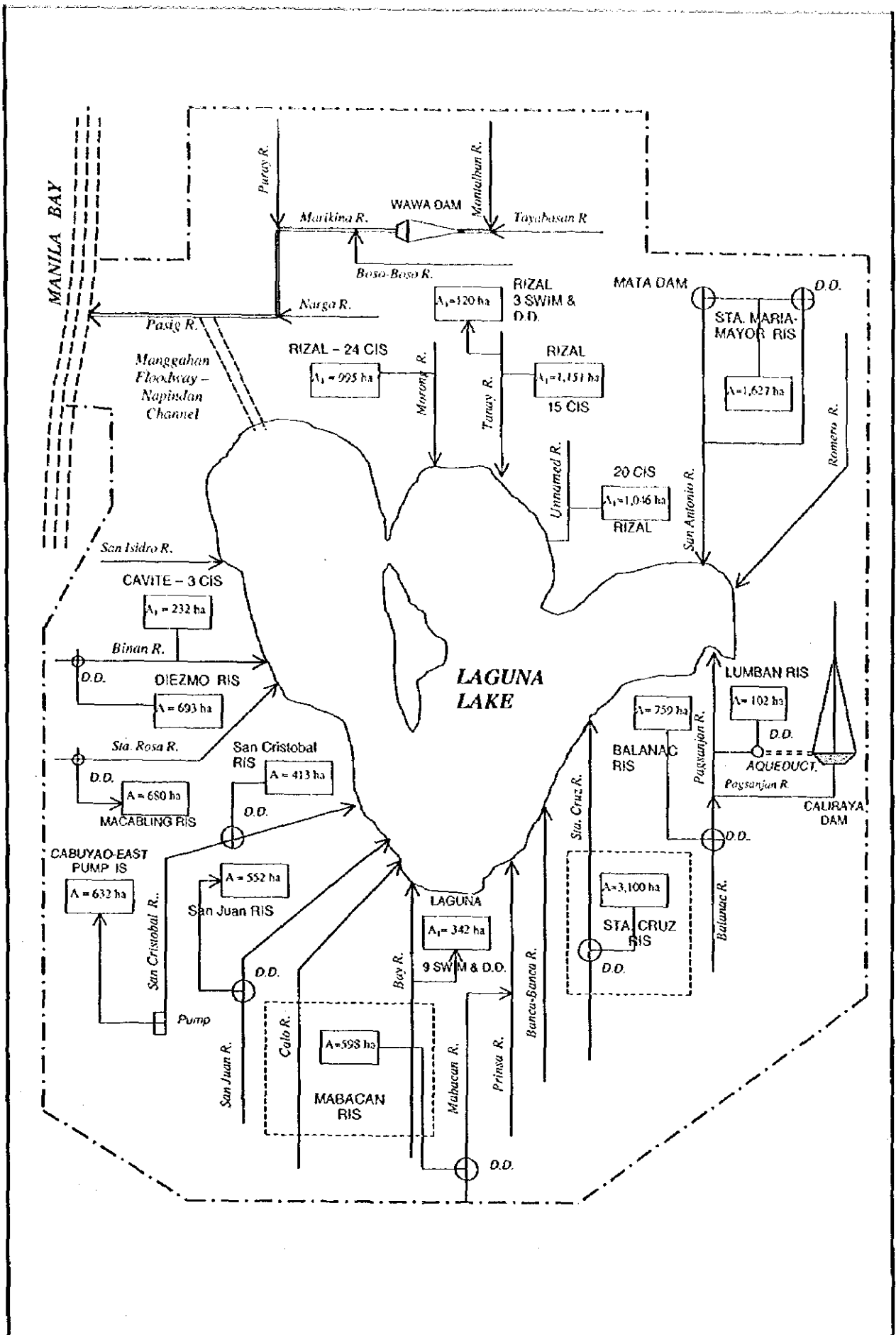

Figure F-19 SCHEMATIC DIAGRAM OF IRRIGATION DEVELOPMENT SCHEMES: PASIG-LAGUNA LAKE RIVER BASIN (WRR 4)

MINDORO STRAIT

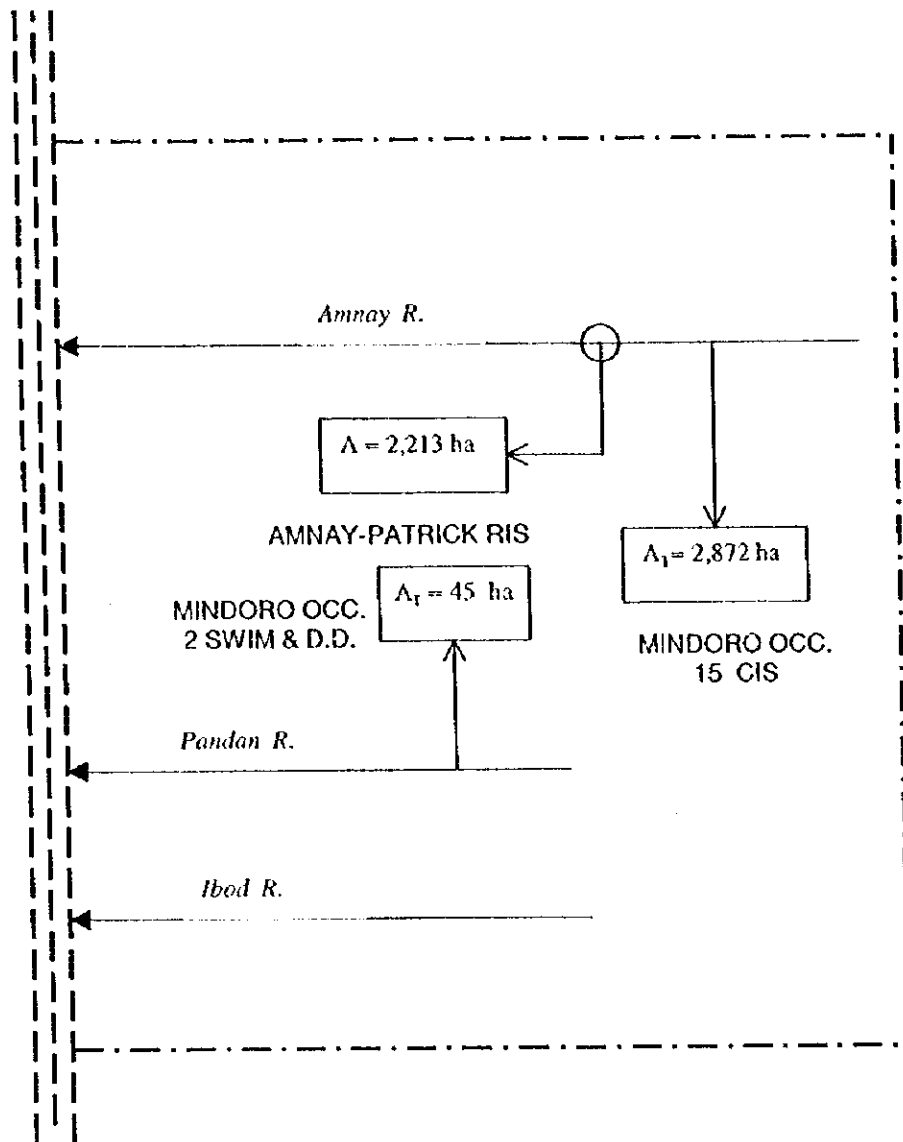

Figure F-20

SCHEMATIC DIAGRAM OF IRRIGATION DEVELOPMENT SCHEMES:
AMNAY-PATRICK RIVER BASIN (WRR 4)

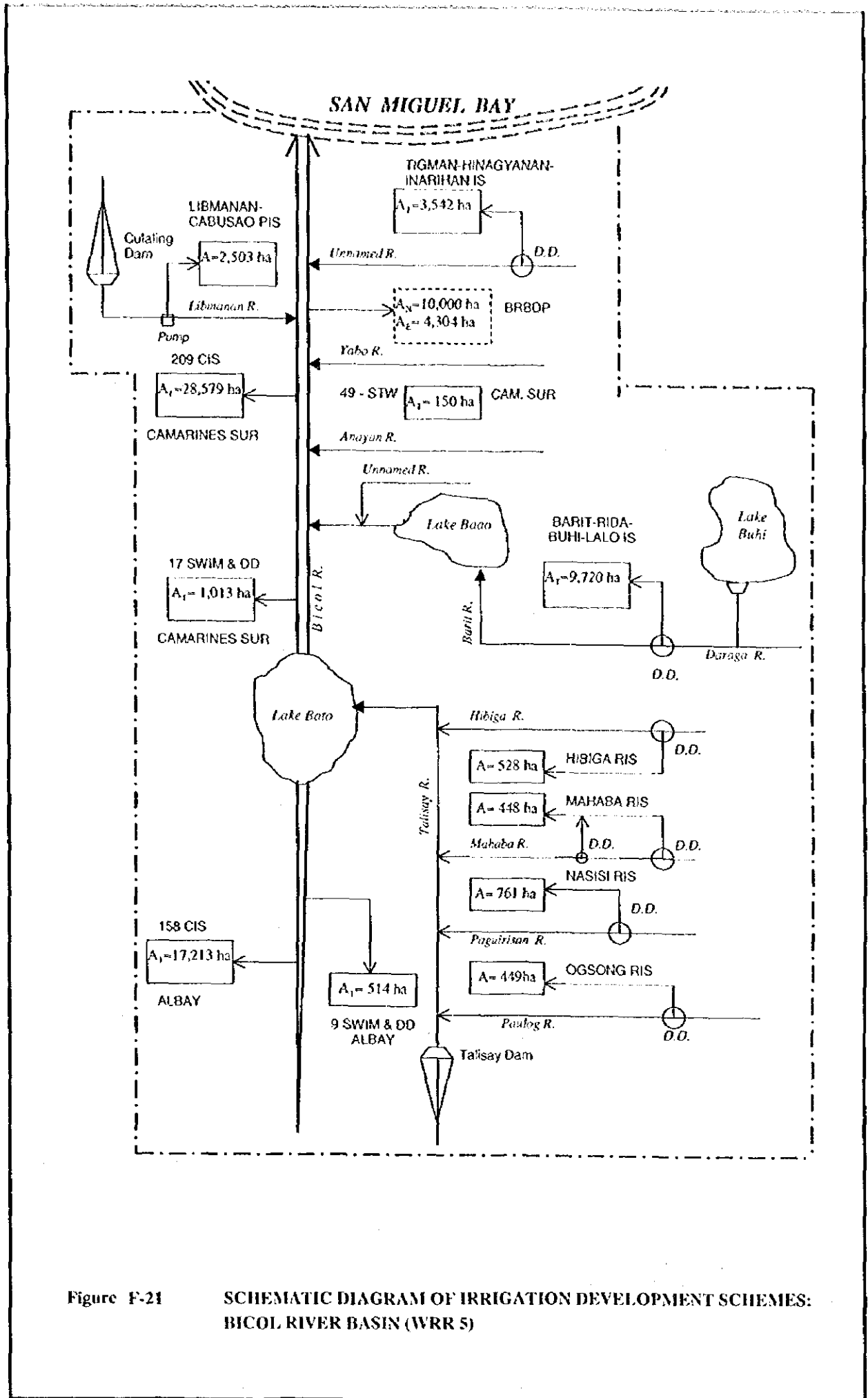

Figure F-21 SCHEMATIC DIAGRAM OF IRRIGATION DEVELOPMENT SCHEMES: BICOL RIVER BASIN (WRR 5)

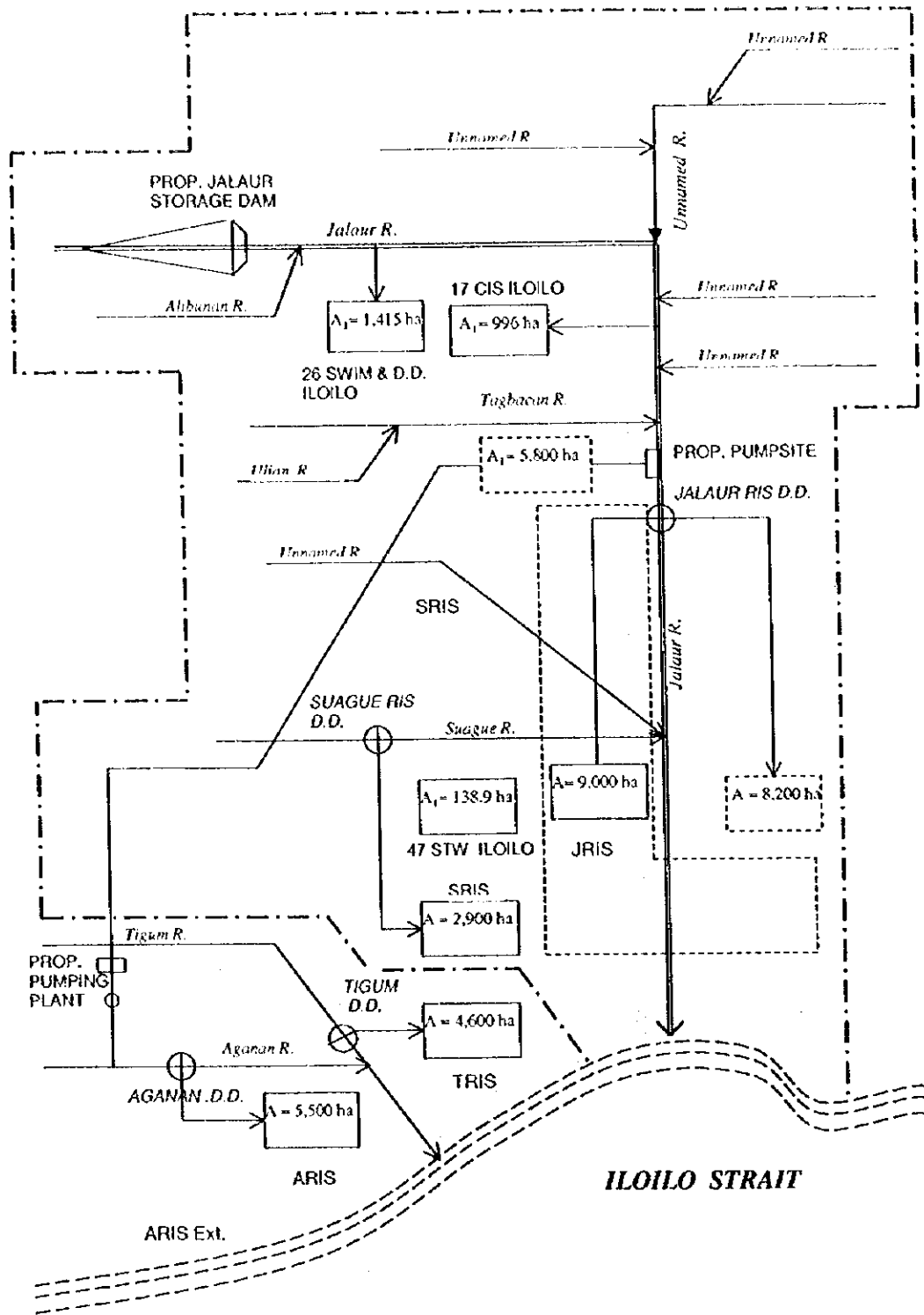

Figure F-22 SCHEMATIC DIAGRAM OF IRRIGATION DEVELOPMENT SCHEMES: JALAUUR RIVER BASIN (WRR 6)

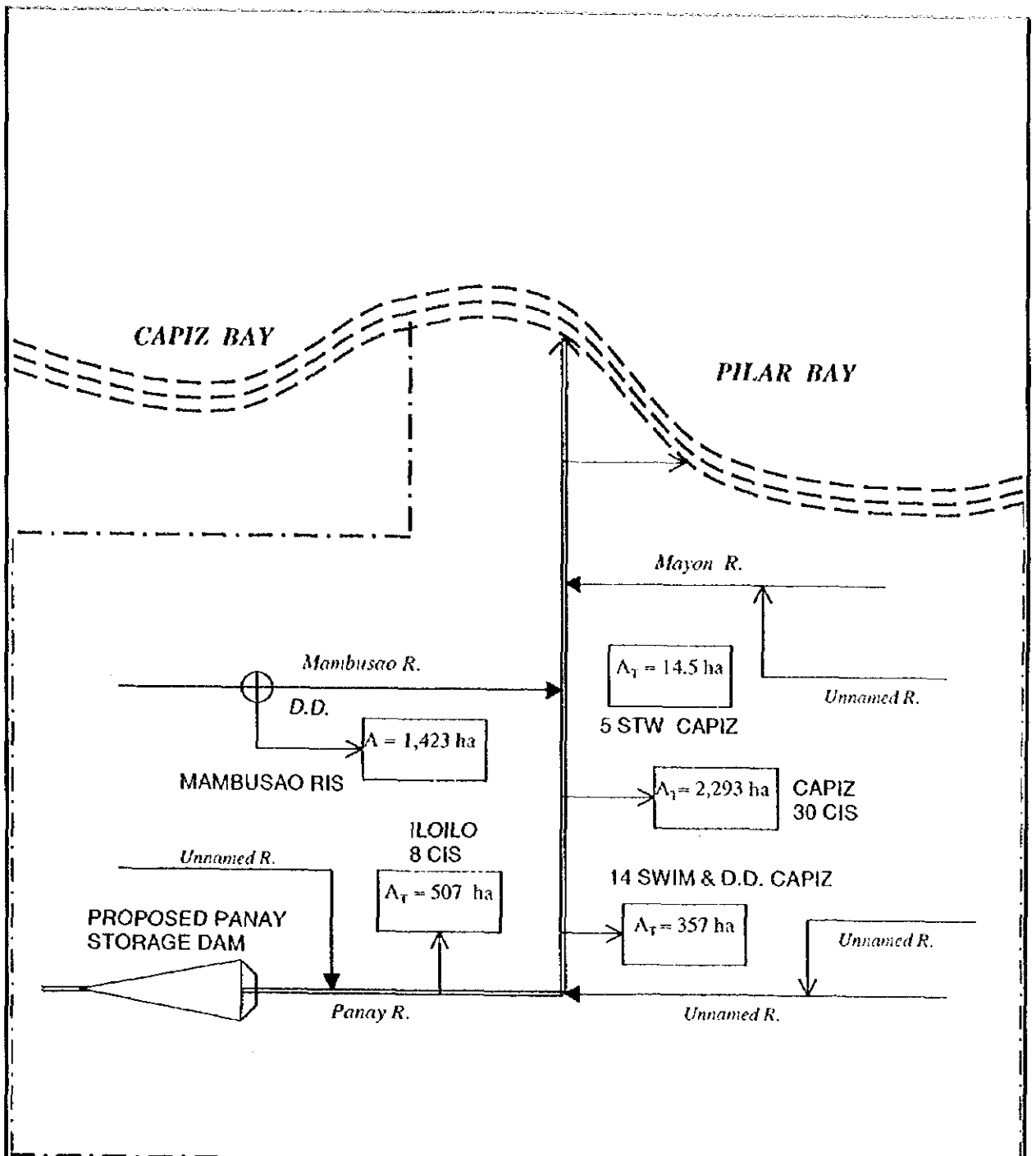

Figure F-23

SCHMATIC DIAGRAM OF IRRIGATION DEVELOPMENT SCHEMES:
PANAY RIVER BASIN (WRR 6)

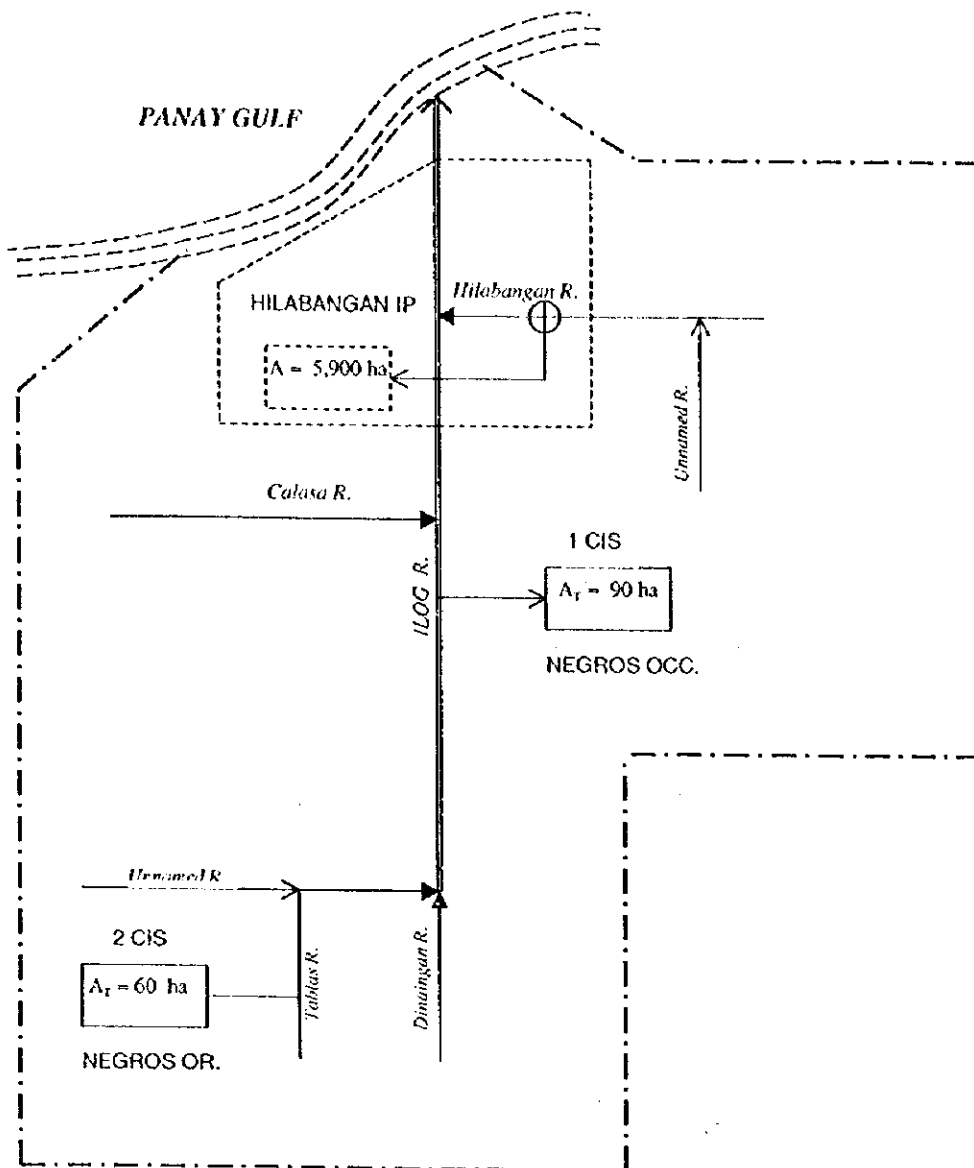

Figure F-24 SCHEMATIC DIAGRAM OF IRRIGATION DEVELOPMENT SCHEMES:
ILOG-HILABANGAN RIVER BASIN (WRR 6)

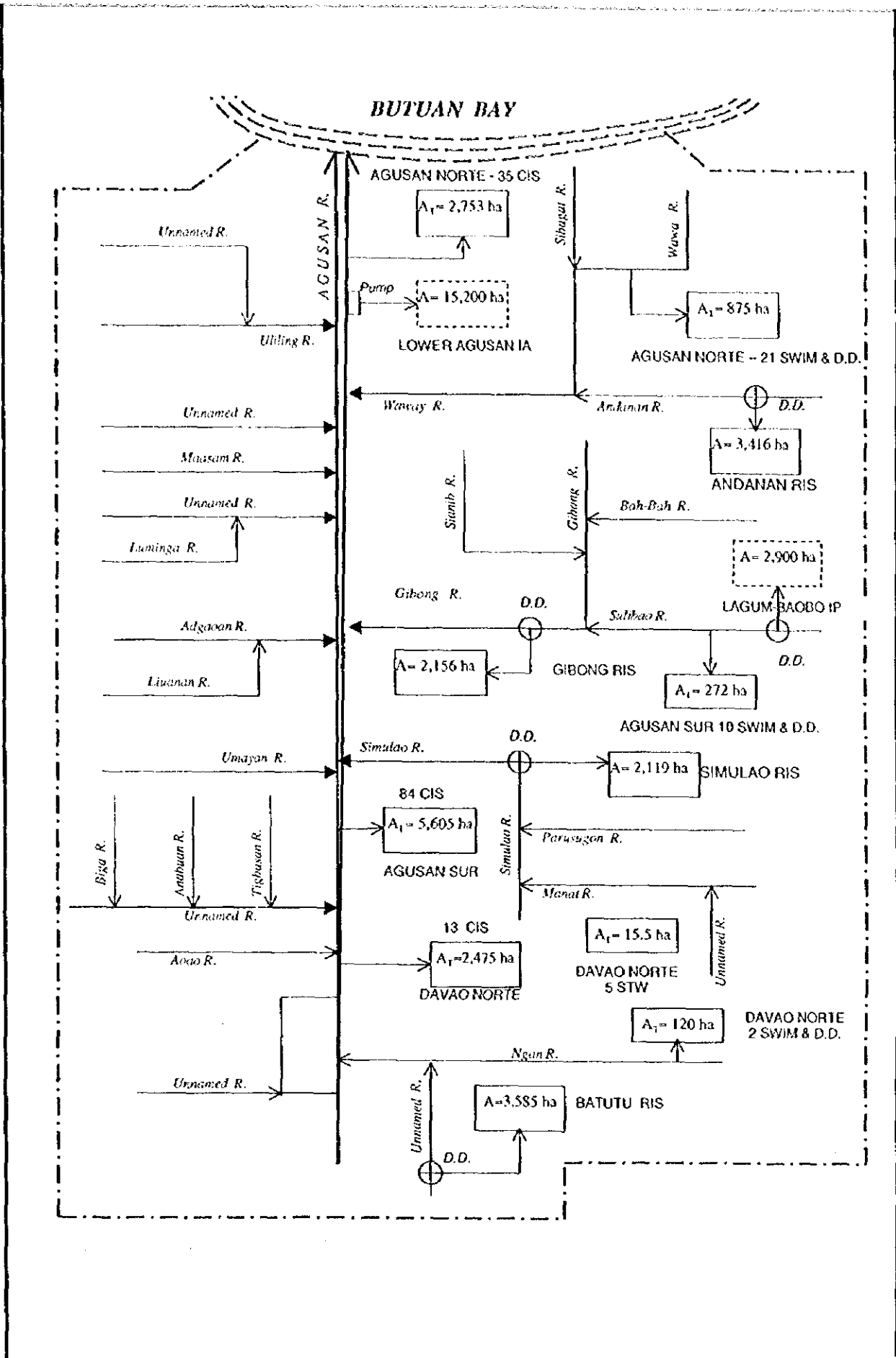

Figure F-25 SCHEMATIC DIAGRAM OF IRRIGATION DEVELOPMENT SCHEMES: AGUSAN RIVER BASIN (WRR 10)

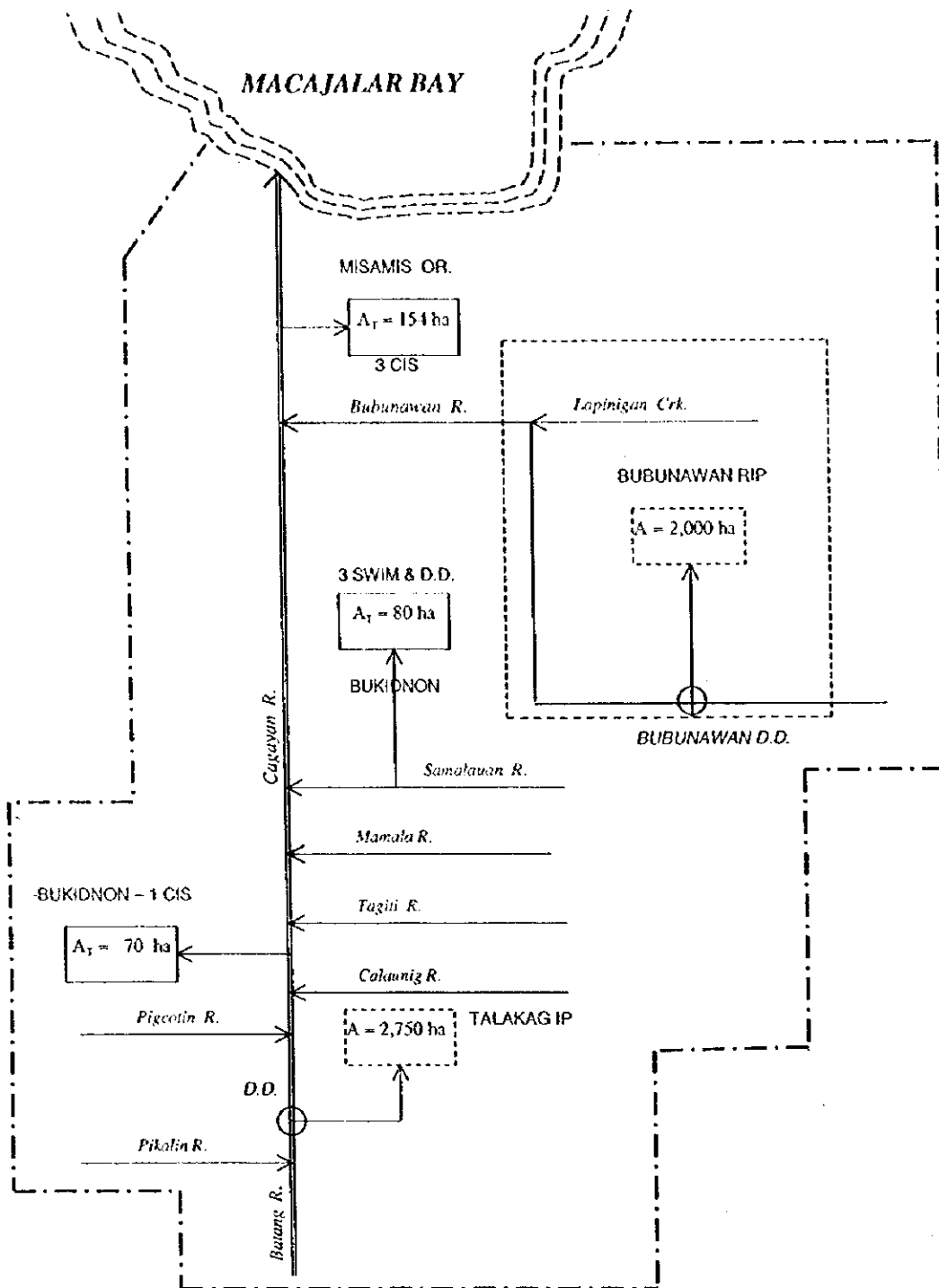

Figure F-26

**SCHEMATIC DIAGRAM OF IRRIGATION DEVELOPMENT SCHEMES:
 CAGAYAN (MINDANAO) RIVER BASIN (WRR 10)**

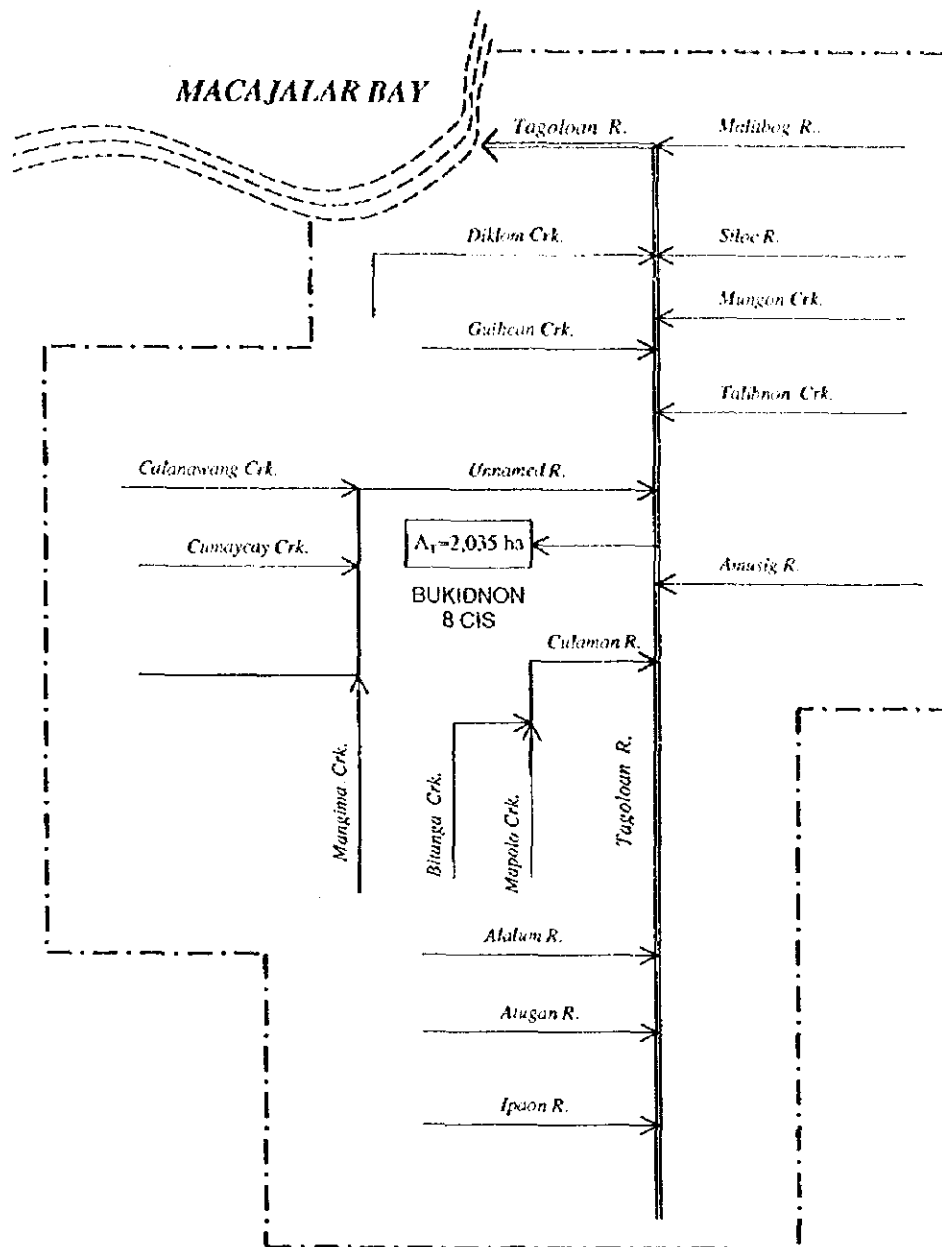

Figure F-27

**SCHEMATIC DIAGRAM OF IRRIGATION DEVELOPMENT SCHEMES:
TAGOLOAN RIVER BASIN (WRR 10)**

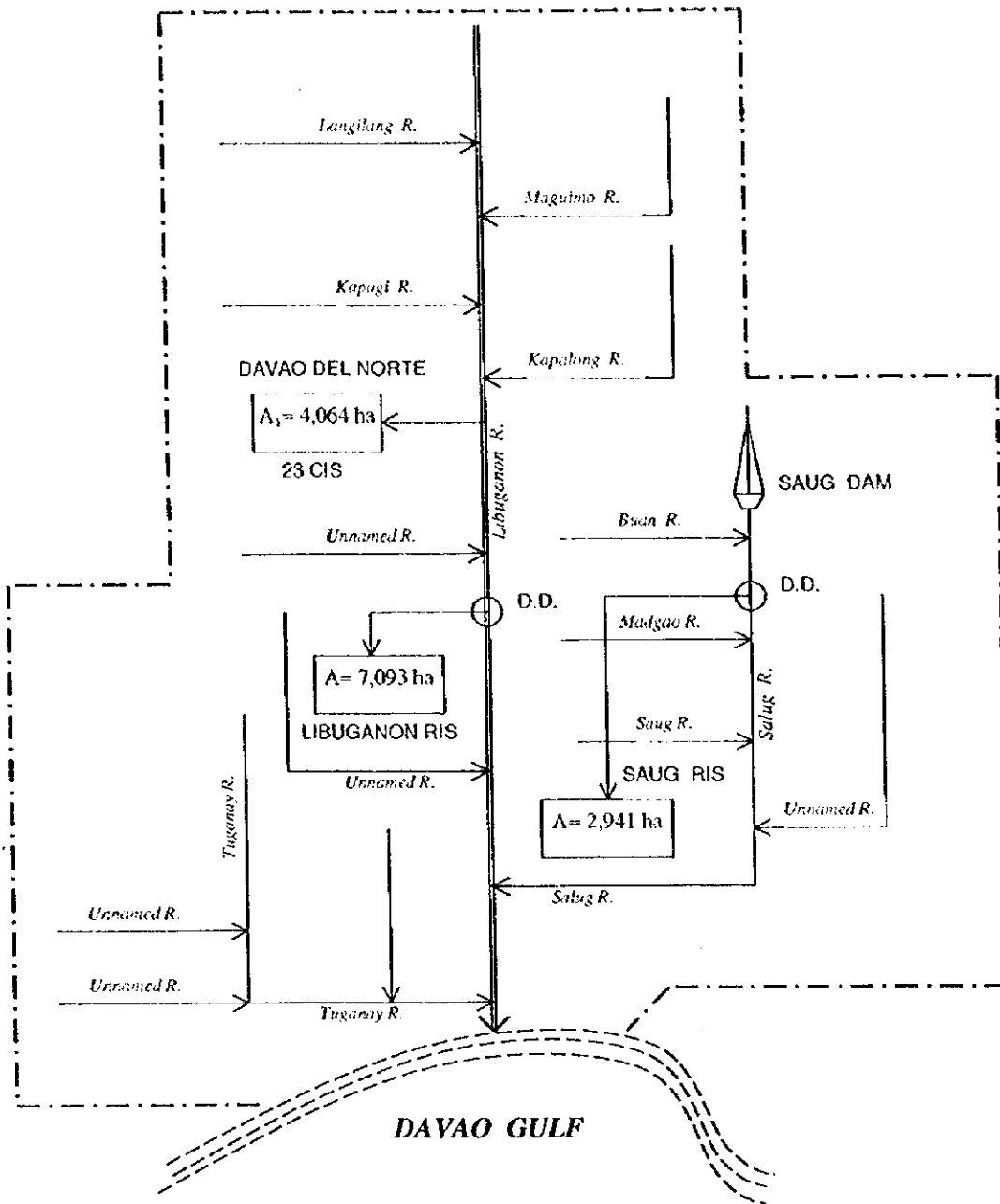

Figure F-28

**SCHEMATIC DIAGRAM OF IRRIGATION DEVELOPMENT SCHEMES:
TAGUM-LIBUGANON RIVER BASIN (WRR 11)**

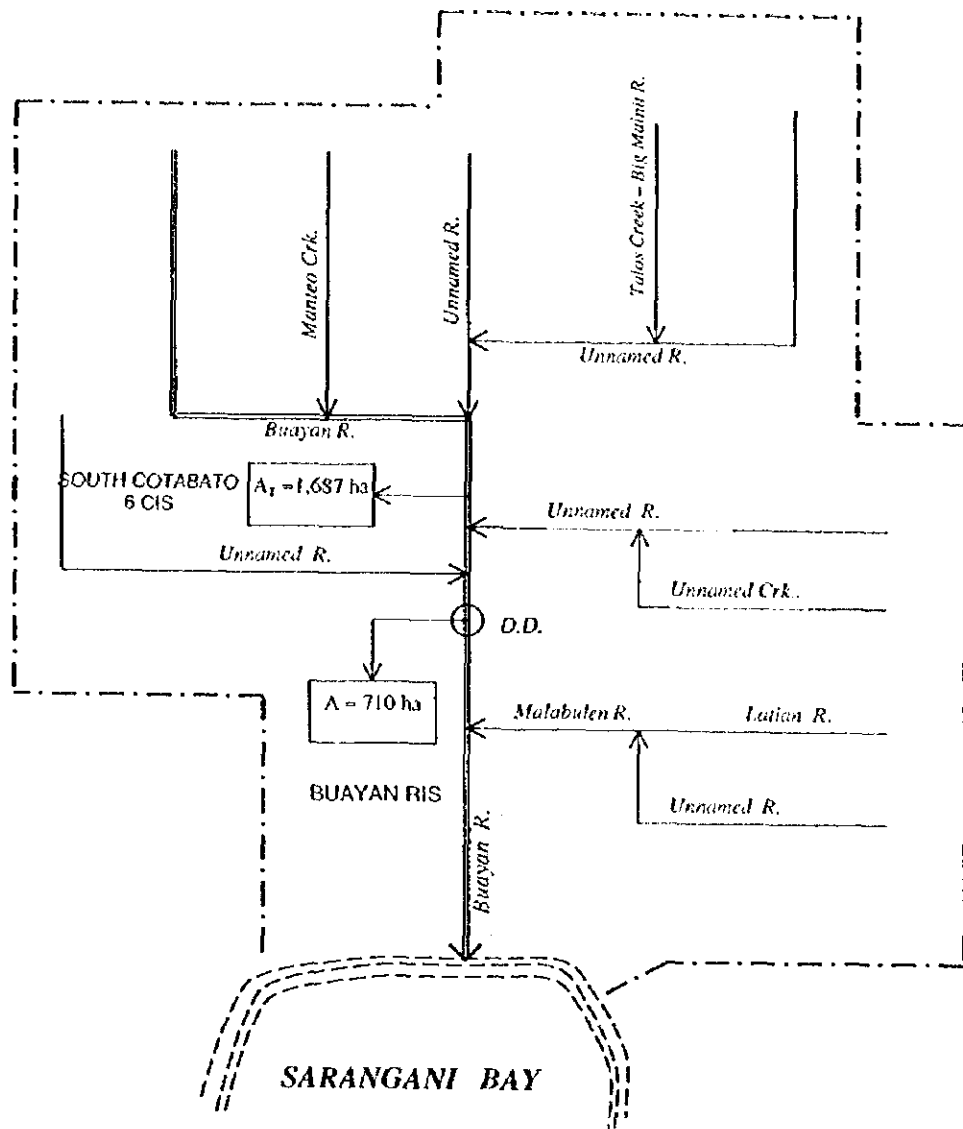

Figure F-29 SCHEMATIC DIAGRAM OF IRRIGATION DEVELOPMENT SCHEMES:
BUAYAN-MALUNGON RIVER BASIN (WRR 11)

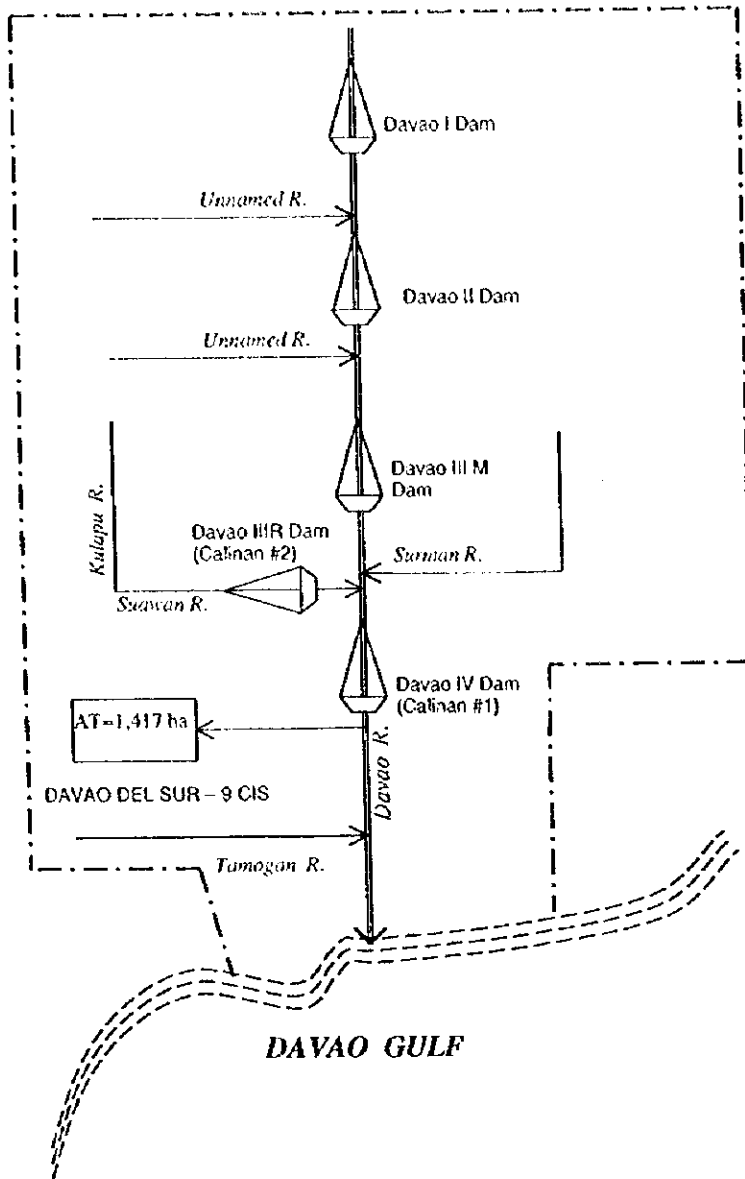

Figure F-30

**SCHEMATIC DIAGRAM OF IRRIGATION DEVELOPMENT SCHEMES:
DAVAO RIVER BASIN (WRR 11)**

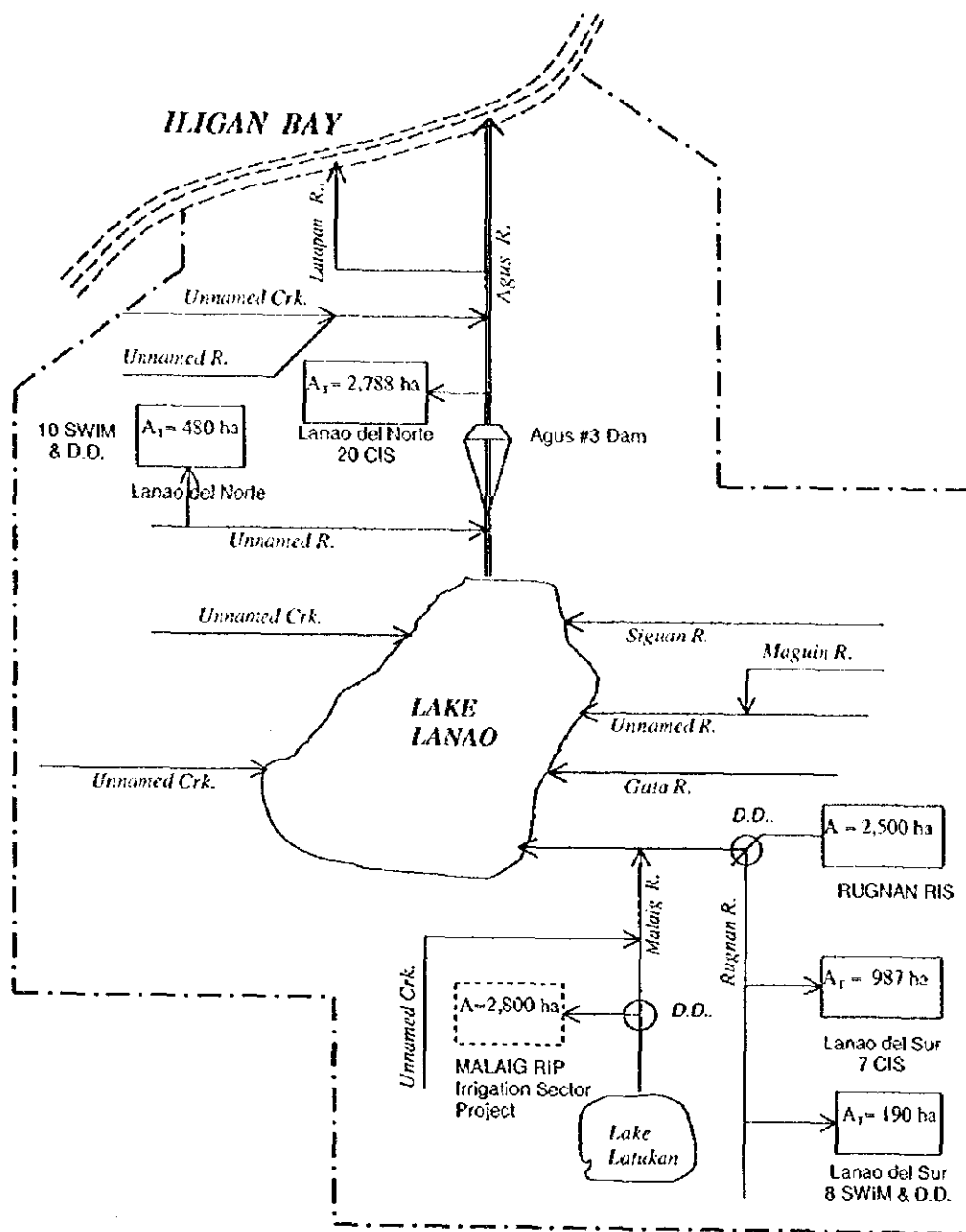

Figure F-31 SCHEMATIC DIAGRAM OF IRRIGATION DEVELOPMENT SCHEMES:
 AGUS RIVER BASIN (WRR 12)

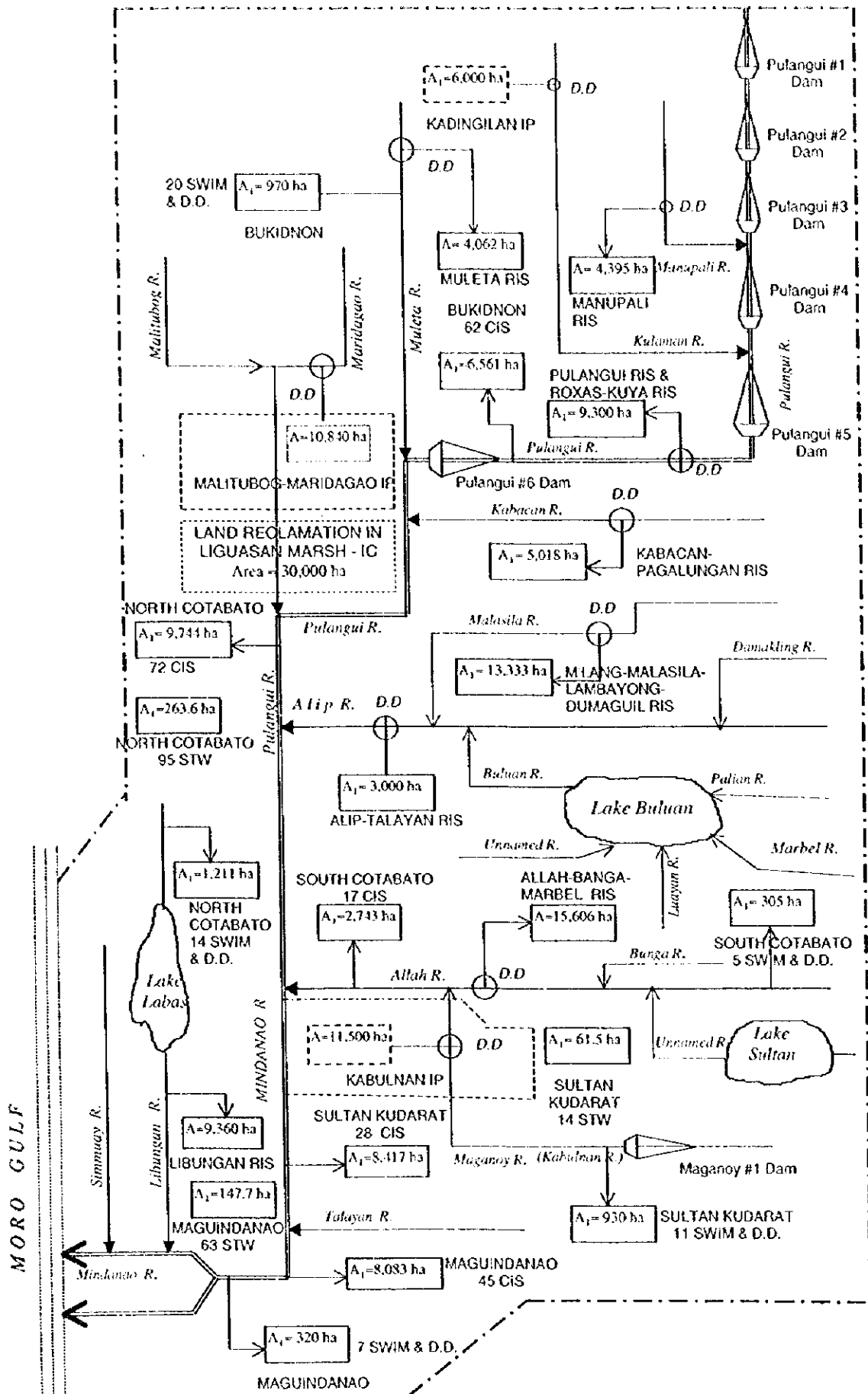

Figure F-32 SCHEMATIC DIAGRAM OF IRRIGATION DEVELOPMENT SCHEMES: MINDANAO RIVER BASIN (WRR 12)