

JAPAN INTERNATIONAL COOPERATION AGENCY (JICA)

MINISTRY OF PUBLIC WORKS
THE REPUBLIC OF CHILE

**THE REHABILITATION AND CONSERVATION
PROGRAM ON THE BRIDGES
IN
THE REPUBLIC OF CHILE
(PHASE 2)**

FINAL REPORT

**APPENDIX II
(VOLUME 4/8)**

JICA LIBRARY



J 1144720(8)

JULY 1998

PACIFIC CONSULTANTS INTERNATIONAL

S S F

J R

98-085

JAPAN INTERNATIONAL COOPERATION AGENCY (JICA)

**MINISTRY OF PUBLIC WORKS
THE REPUBLIC OF CHILE**

**THE REHABILITATION AND CONSERVATION
PROGRAM ON THE BRIDGES
IN
THE REPUBLIC OF CHILE
(PHASE 2)**

FINAL REPORT

**APPENDIX II
(VOLUME 4/8)**

JULY 1998

PACIFIC CONSULTANTS INTERNATIONAL

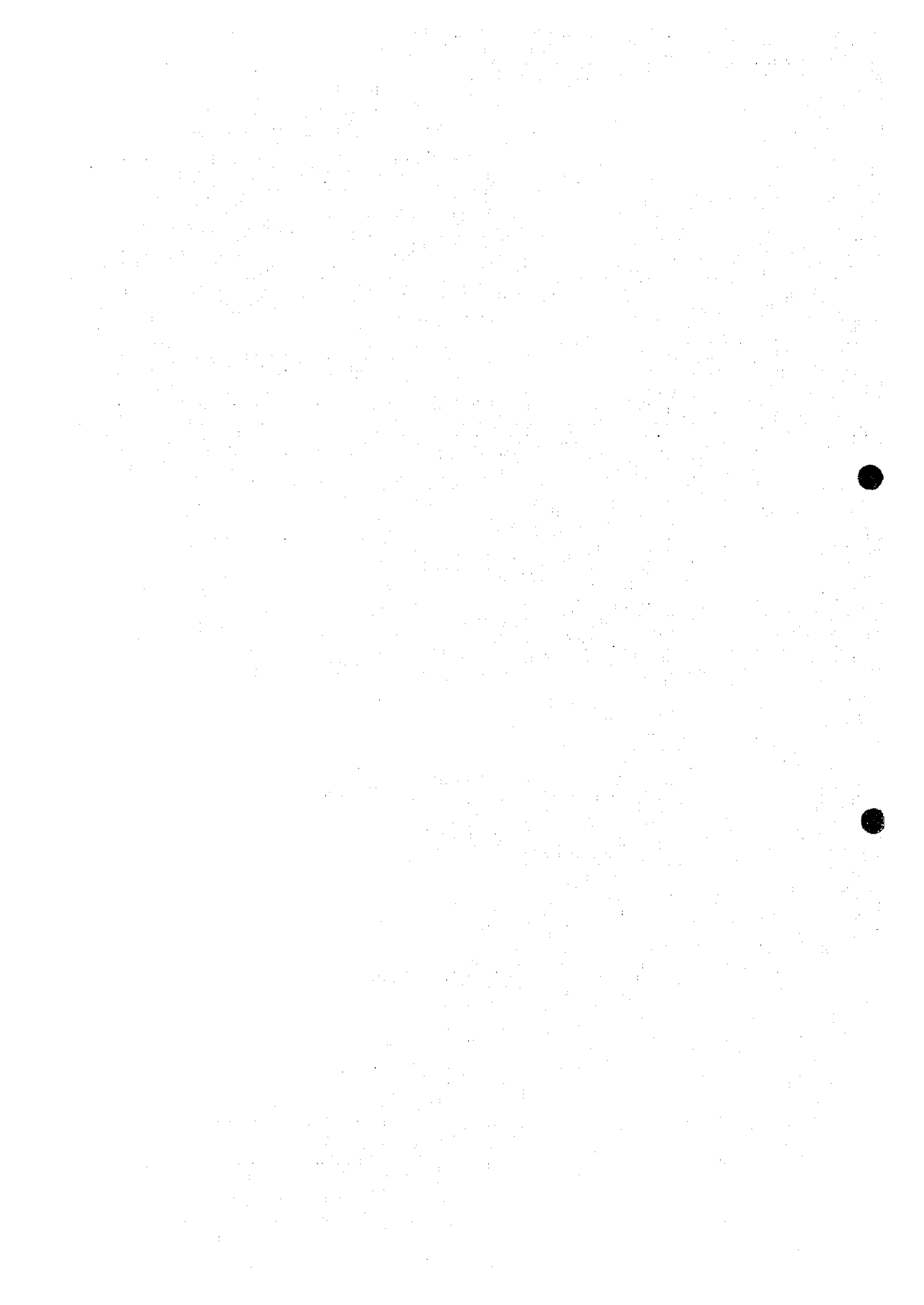

Appendix II (Volume 4/8)

- II-1 Results of General Inspection
- II-2 Reasons of Reconstruction
- II-3 Results of Phenolphthalein Liquid Test
- II-4 Quantities for Repairs
- II-5 Breakdown of Reconstruction Costs
- II-6 Breakdown of Repair Costs
- II-7 Results of Environmental Inspection
- II-8 Strengthening Design for Granallas Bridge

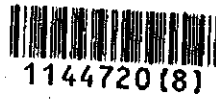

1144720(8)

APPENDIX II-1

RESULTS OF GENERAL INSPECTION

Contents

Bridge No.	Bridge Name	Page
1	Confluencia.....	(II-1)1-1~7
2	David Garcia.....	(II-1)2-1~9
3	Granallas.....	(II-1)3-1~7
4	Ventanas.....	(II-1)4-1~10
5	San Jose.....	(II-1)5-1~6
6	Puangué.....	(II-1)6-1~5
7	San Jose de Marchiue.....	(II-1)7-1~6
8	Antivero No. 2.....	(II-1)8-1~7
9	Los Cardos.....	(II-1)9-1~8
10	Cautin.....	(II-1)10-1~7
11	El Indio.....	(II-1)11-1~4
12	Quillen.....	(II-1)12-1~4
13	Poculon.....	(II-1)13-1~5
14	Malleco.....	(II-1)14-1~5
15	Miraflores.....	(II-1)15-1~8
16	San Juan.....	(II-1)16-1~4
17	Medina.....	(II-1)17-1~5
18	Cautin (88).....	(II-1)18-1~6
19	Salva Tu Alma.....	(II-1)19-1~6
20	Quinchilca.....	(II-1)20-1~6

(1) CONFLUENCIA

BRIDGE NUMBER	YEAR OF BUILT	NOTE
BRIDGE NAME	BRIDGE LENGTH	
REGION	BRIDGE WIDTH	
ROUTE NAME	TRAFFIC VOLUME	

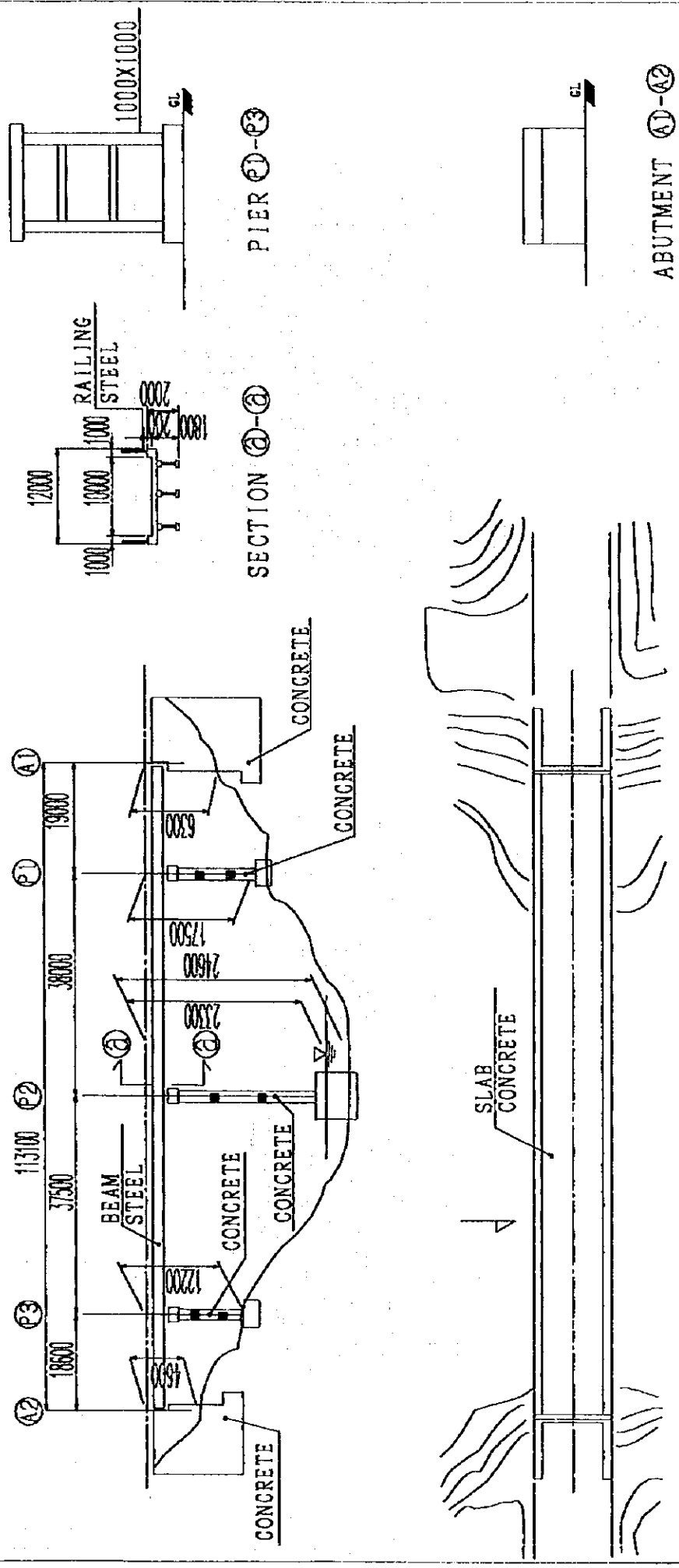

NOTE

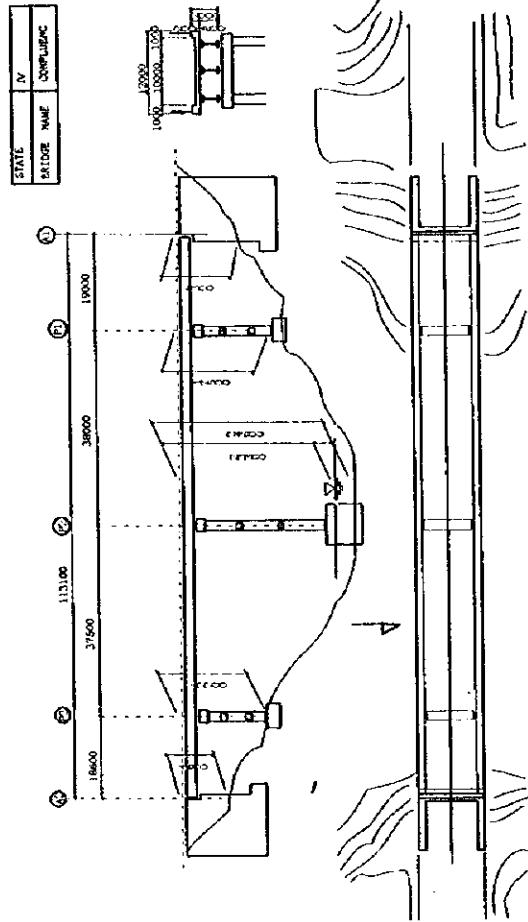
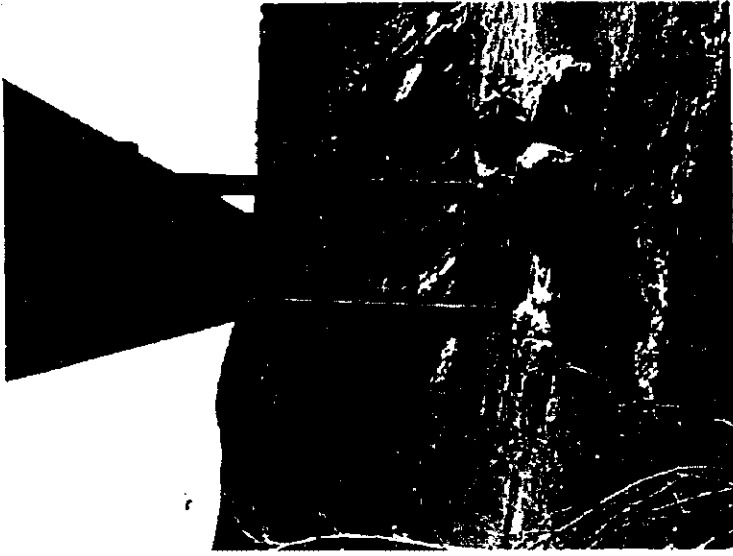
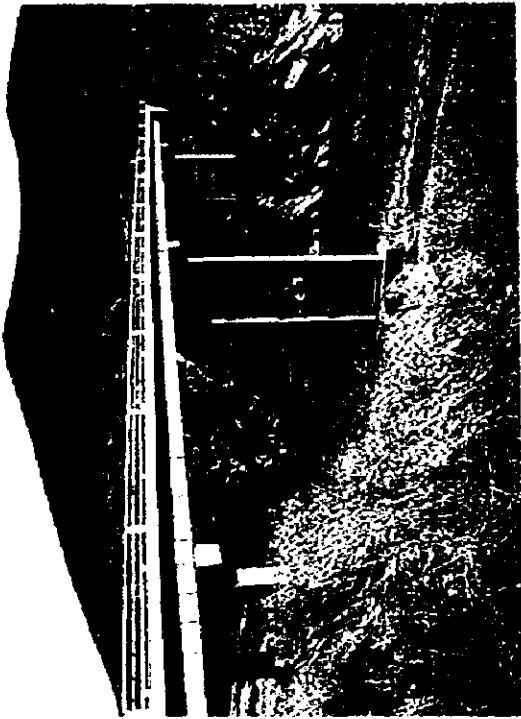

BRIDGE NO. h BRIDGE NAME: CONFLUENCIA



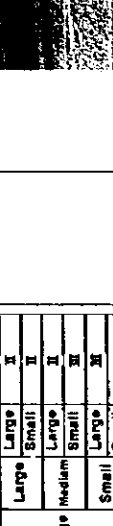

B. DAMAGE RANK AND DECISION ON REHABILITATION

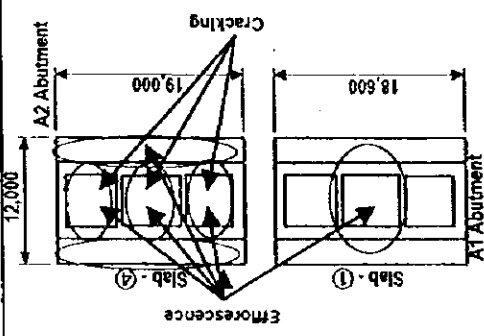
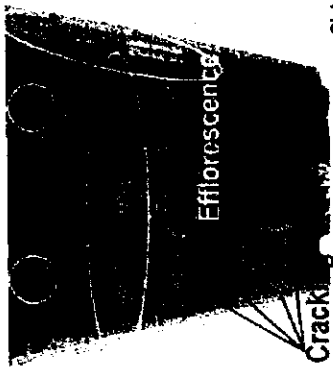
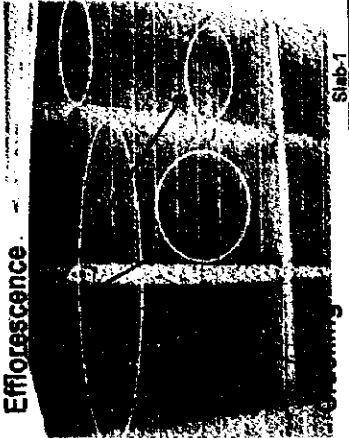
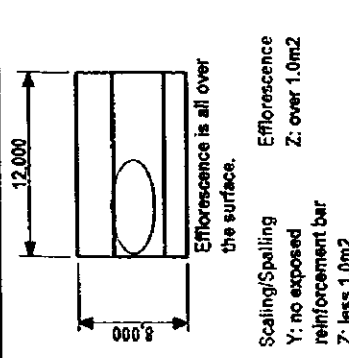
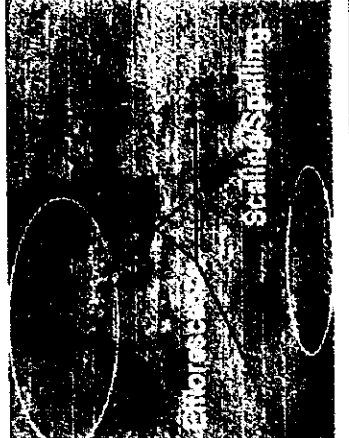
Bridge Component	Location of Damage	Damage	Evaluation of Damage	Damage Rank	Picture																																												
(1) Concrete Materials	 <p>Cracking</p> <p>Scaling/Spalling</p> <p>Scaling/Spalling is distributed over the surface of bridge</p> <p>Cracking</p> <p>X: one direction Y: over 0.3mm Z: less 50cm</p> <p>Scaling/Spalling</p> <p>Y: no exposed reinforcement bar Z: over 0.1m²</p>	Cracking	<table border="1" data-bbox="391 896 526 1153"> <thead> <tr> <th>X</th> <th>Y</th> <th>Z</th> <th>All member</th> </tr> </thead> <tbody> <tr> <td></td> <td>Large</td> <td>Large</td> <td>II</td> </tr> <tr> <td></td> <td>Small</td> <td>Small</td> <td>II</td> </tr> <tr> <td>Large</td> <td>Medium</td> <td>Small</td> <td>III</td> </tr> <tr> <td></td> <td>Large</td> <td>Small</td> <td>III</td> </tr> <tr> <td></td> <td>Small</td> <td>Small</td> <td>IV</td> </tr> <tr> <td></td> <td>Large</td> <td>Large</td> <td>III</td> </tr> <tr> <td></td> <td>Small</td> <td>Large</td> <td>III</td> </tr> <tr> <td>Small</td> <td>Medium</td> <td>Small</td> <td>IV</td> </tr> <tr> <td></td> <td>Large</td> <td>Small</td> <td>IV</td> </tr> <tr> <td></td> <td>Small</td> <td>Small</td> <td>IV</td> </tr> </tbody> </table> <p>Although damage rank is III, degree of crack is serious so that rehabilitation must be needed.</p>	X	Y	Z	All member		Large	Large	II		Small	Small	II	Large	Medium	Small	III		Large	Small	III		Small	Small	IV		Large	Large	III		Small	Large	III	Small	Medium	Small	IV		Large	Small	IV		Small	Small	IV	III*	 <p>Cracking</p>
X	Y	Z	All member																																														
	Large	Large	II																																														
	Small	Small	II																																														
Large	Medium	Small	III																																														
	Large	Small	III																																														
	Small	Small	IV																																														
	Large	Large	III																																														
	Small	Large	III																																														
Small	Medium	Small	IV																																														
	Large	Small	IV																																														
	Small	Small	IV																																														
Slab	<p>Scaling/Spalling</p> <p>Whole area of cantilevering lower-side slab</p> <p>Z: over 0.1m²</p>	Cracking Scaling/Spalling	<table border="1" data-bbox="550 896 734 1153"> <thead> <tr> <th>Y</th> <th>Z</th> <th>Main Member</th> <th>Secondary Member</th> </tr> </thead> <tbody> <tr> <td>Large</td> <td>Large</td> <td>II</td> <td>II</td> </tr> <tr> <td>Small</td> <td>Small</td> <td>IV</td> <td>IV</td> </tr> <tr> <td>Small</td> <td>Large</td> <td>IV</td> <td>IV</td> </tr> <tr> <td></td> <td>Small</td> <td>IV</td> <td>IV</td> </tr> </tbody> </table> <p>Damage was observed, but rehabilitation is not needed. Follow-up inspection must be executed.</p>	Y	Z	Main Member	Secondary Member	Large	Large	II	II	Small	Small	IV	IV	Small	Large	IV	IV		Small	IV	IV	III	<p>Scaling/Spalling</p>																								
Y	Z	Main Member	Secondary Member																																														
Large	Large	II	II																																														
Small	Small	IV	IV																																														
Small	Large	IV	IV																																														
	Small	IV	IV																																														
	<p>Efflorescence</p>	Efflorescence	<table border="1" data-bbox="758 896 941 1153"> <thead> <tr> <th>Z</th> <th>Main Member</th> <th>Secondary Member</th> </tr> </thead> <tbody> <tr> <td>Large</td> <td>II</td> <td>II</td> </tr> <tr> <td>Small</td> <td>III</td> <td>IV</td> </tr> </tbody> </table> <p>Degree of damage is large so that rehabilitation must be needed.</p>	Z	Main Member	Secondary Member	Large	II	II	Small	III	IV	II	<p>Efflorescence</p>																																			
Z	Main Member	Secondary Member																																															
Large	II	II																																															
Small	III	IV																																															

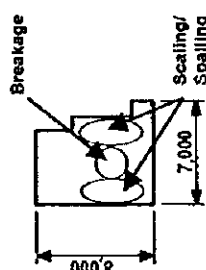
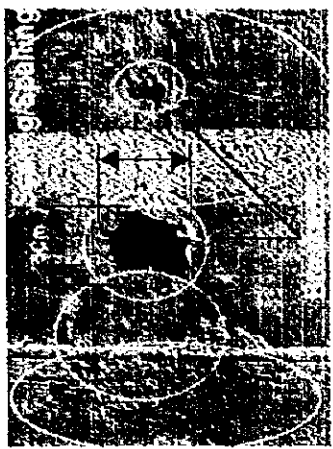
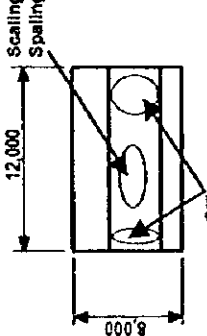
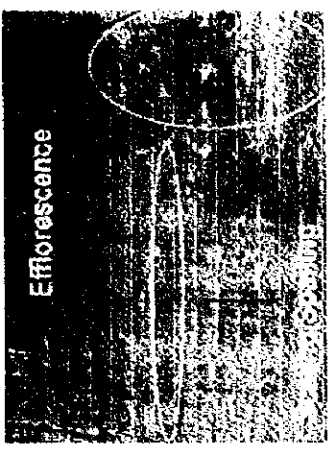
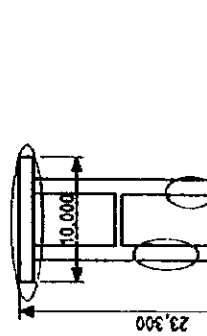
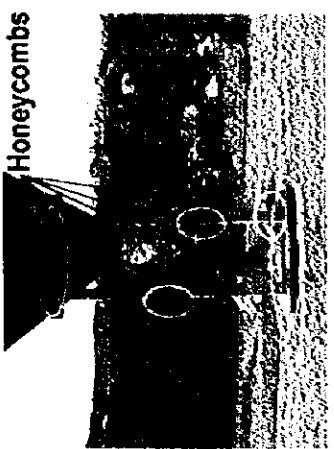
Bridge Component	Location of Damage	Damage	Evaluation of Damage	Damage Rank	Picture																																												
Slab	 <p>Cracking</p> <p>Efflorescence</p> <p>A2 Abutment</p> <p>12,000</p> <p>19,000</p> <p>18,600</p> <p>A1 Abutment</p> <p>Slab-4</p> <p>Slab-1</p>	Cracking	<table border="1"> <thead> <tr> <th>X</th> <th>Y</th> <th>Z</th> <th>All member</th> </tr> </thead> <tbody> <tr> <td></td> <td>Large</td> <td>Large</td> <td>II</td> </tr> <tr> <td></td> <td>Small</td> <td>Small</td> <td>II</td> </tr> <tr> <td>Large</td> <td>Medium</td> <td>Large</td> <td>II</td> </tr> <tr> <td></td> <td>Small</td> <td>Small</td> <td>III</td> </tr> <tr> <td></td> <td>Small</td> <td>Small</td> <td>IV</td> </tr> <tr> <td></td> <td>Large</td> <td>Large</td> <td>III</td> </tr> <tr> <td></td> <td>Large</td> <td>Small</td> <td>III</td> </tr> <tr> <td>Small</td> <td>Medium</td> <td>Large</td> <td>IV</td> </tr> <tr> <td></td> <td>Small</td> <td>Small</td> <td>IV</td> </tr> <tr> <td></td> <td>Small</td> <td>Small</td> <td>IV</td> </tr> </tbody> </table> <p>Damage was observed, but rehabilitation is not needed. Follow-up inspection must be executed.</p>	X	Y	Z	All member		Large	Large	II		Small	Small	II	Large	Medium	Large	II		Small	Small	III		Small	Small	IV		Large	Large	III		Large	Small	III	Small	Medium	Large	IV		Small	Small	IV		Small	Small	IV	III	 <p>Cracking</p> <p>Efflorescence</p> <p>Slab-4</p>
		X	Y	Z	All member																																												
	Large	Large	II																																														
	Small	Small	II																																														
Large	Medium	Large	II																																														
	Small	Small	III																																														
	Small	Small	IV																																														
	Large	Large	III																																														
	Large	Small	III																																														
Small	Medium	Large	IV																																														
	Small	Small	IV																																														
	Small	Small	IV																																														
	<p>Cracking</p> <p>Efflorescence</p> <p>Z: over 0.1m²</p> <p>X: one direction 0.3mm < Y < 0.2mm</p> <p>Z: less 50cm</p>	Efflorescence	<table border="1"> <thead> <tr> <th>Z</th> <th>Main Member</th> <th>Secondary Member</th> </tr> </thead> <tbody> <tr> <td>Large</td> <td></td> <td>II</td> </tr> <tr> <td>Small</td> <td></td> <td>IV</td> </tr> </tbody> </table> <p>Degree of damage was large so that rehabilitation must be needed.</p>	Z	Main Member	Secondary Member	Large		II	Small		IV	II	 <p>Efflorescence</p> <p>Slab-1</p>																																			
Z	Main Member	Secondary Member																																															
Large		II																																															
Small		IV																																															
A1 Abutment	 <p>12,000</p> <p>8,900</p> <p>Efflorescence</p> <p>Scaling/Spalling</p> <p>Efflorescence is all over the surface.</p> <p>Scaling/Spalling</p> <p>Efflorescence</p> <p>Z: over 1.0m²</p> <p>Y: no exposed reinforcement bar</p> <p>Z: less 1.0m²</p>	Scaling/Spalling Efflorescence	<table border="1"> <thead> <tr> <th>Y</th> <th>Z</th> <th>Main Member</th> <th>Secondary Member</th> </tr> </thead> <tbody> <tr> <td>Large</td> <td>Large</td> <td>I</td> <td>II</td> </tr> <tr> <td>Small</td> <td>Small</td> <td>I</td> <td>IV</td> </tr> <tr> <td></td> <td>Large</td> <td>III</td> <td>IV</td> </tr> <tr> <td></td> <td>Small</td> <td>III</td> <td>IV</td> </tr> </tbody> </table> <p>Damage was observed, the degree must be recorded.</p> <table border="1"> <thead> <tr> <th>Z</th> <th>Main Member</th> <th>Secondary Member</th> </tr> </thead> <tbody> <tr> <td>Large</td> <td></td> <td>II</td> </tr> <tr> <td>Small</td> <td></td> <td>IV</td> </tr> </tbody> </table> <p>Degree of damage is large, so that rehabilitation must be needed.</p>	Y	Z	Main Member	Secondary Member	Large	Large	I	II	Small	Small	I	IV		Large	III	IV		Small	III	IV	Z	Main Member	Secondary Member	Large		II	Small		IV	Scaling/Spalling IV Efflorescence II	 <p>Scaling/Spalling</p> <p>Efflorescence</p>															
Y	Z	Main Member	Secondary Member																																														
Large	Large	I	II																																														
Small	Small	I	IV																																														
	Large	III	IV																																														
	Small	III	IV																																														
Z	Main Member	Secondary Member																																															
Large		II																																															
Small		IV																																															

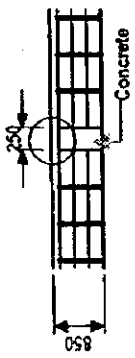
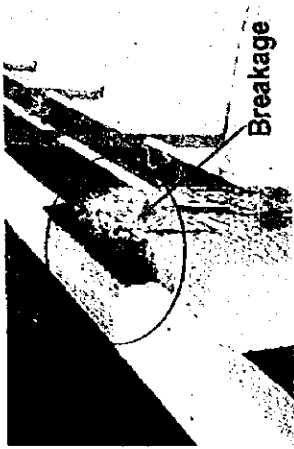
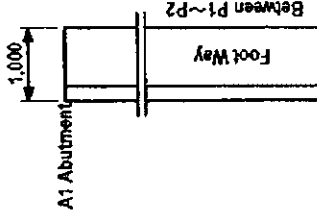
Bridge Component	Location of Damage	Damage	Evaluation of Damage	Damage Rank	Picture																					
A1 Abutment	 <p>Scaling/Spalling Breakage Y: no exposed reinforcement bar Z: over 1.0m²</p>	Scaling/Spalling Breakage	<p>Scaling/Spalling</p> <table border="1"> <tr> <td>Y</td> <td>Z</td> <td>Main Member</td> <td>Secondary Member</td> </tr> <tr> <td>Large</td> <td>Large</td> <td>II</td> <td>II</td> </tr> <tr> <td>Small</td> <td>Small</td> <td>IV</td> <td>IV</td> </tr> </table> <p>Damage was observed, but rehabilitation is not needed. Follow-up inspection must be executed.</p> <p>Breakage</p> <table border="1"> <tr> <td>Y</td> <td>All Members</td> <td>Degree of damage was</td> </tr> <tr> <td>Large</td> <td>Large</td> <td>large so</td> </tr> <tr> <td>Small</td> <td>Small</td> <td>that rehabilitation must be needed.</td> </tr> </table>	Y	Z	Main Member	Secondary Member	Large	Large	II	II	Small	Small	IV	IV	Y	All Members	Degree of damage was	Large	Large	large so	Small	Small	that rehabilitation must be needed.	Scaling/Spalling III Breakage II	
Y	Z	Main Member	Secondary Member																							
Large	Large	II	II																							
Small	Small	IV	IV																							
Y	All Members	Degree of damage was																								
Large	Large	large so																								
Small	Small	that rehabilitation must be needed.																								
A2 Abutment	 <p>Scaling/Spalling Efflorescence Y: no exposed reinforcement bar Z: less 1.0m²</p>	Scaling/Spalling Efflorescence	<p>Scaling/Spalling</p> <table border="1"> <tr> <td>Y</td> <td>Z</td> <td>Main Member</td> <td>Secondary Member</td> </tr> <tr> <td>Large</td> <td>Large</td> <td>II</td> <td>II</td> </tr> <tr> <td>Small</td> <td>Small</td> <td>IV</td> <td>IV</td> </tr> </table> <p>Damage was observed, the degree must be recorded.</p> <p>Efflorescence</p> <table border="1"> <tr> <td>Z</td> <td>Main Member</td> <td>Secondary Member</td> </tr> <tr> <td>Large</td> <td>Large</td> <td>II</td> </tr> <tr> <td>Small</td> <td>Small</td> <td>IV</td> </tr> </table> <p>Degree of damage is large, so that rehabilitation must be needed.</p>	Y	Z	Main Member	Secondary Member	Large	Large	II	II	Small	Small	IV	IV	Z	Main Member	Secondary Member	Large	Large	II	Small	Small	IV	Scaling/Spalling IV Efflorescence II	
Y	Z	Main Member	Secondary Member																							
Large	Large	II	II																							
Small	Small	IV	IV																							
Z	Main Member	Secondary Member																								
Large	Large	II																								
Small	Small	IV																								
P2 Pier and P2 Pier Foundation	 <p>Y: no exposed reinforcement bar Z: less 1.0m²</p>	Honeycombs	<table border="1"> <tr> <td>Y</td> <td>Z</td> <td>Main Member</td> <td>Secondary Member</td> </tr> <tr> <td>Large</td> <td>Large</td> <td>II</td> <td>II</td> </tr> <tr> <td>Small</td> <td>Small</td> <td>IV</td> <td>IV</td> </tr> </table> <p>Damage is observed, the degree must be recorded.</p>	Y	Z	Main Member	Secondary Member	Large	Large	II	II	Small	Small	IV	IV	IV										
Y	Z	Main Member	Secondary Member																							
Large	Large	II	II																							
Small	Small	IV	IV																							

Bridge Component	Location of Damage	Damage	Evaluation of Damage	Damage Rank	Picture																												
Hand Railing - Post	 <p>Y: not remarkable damage (all concrete posts were damaged)</p>	Breakage	<table border="1" data-bbox="279 918 391 1131"> <tr><td>Y</td><td>All Members</td></tr> <tr><td>Large</td><td>II</td></tr> <tr><td>Small</td><td></td></tr> </table> <p>Damage is not remarkable, but rehabilitation must be needed from a point of the appearance.</p>	Y	All Members	Large	II	Small		IV*																							
Y	All Members																																
Large	II																																
Small																																	
FootWay		Cracking Scaling/Spalling	<table border="1" data-bbox="630 907 758 1153"> <tr><th colspan="2">Cracking</th></tr> <tr><th>X</th><th>Z</th></tr> <tr><td>Large</td><td>Large</td></tr> <tr><td>Medium</td><td>Medium</td></tr> <tr><td>Small</td><td>Small</td></tr> <tr><td></td><td>IV</td></tr> <tr><td></td><td>V</td></tr> <tr><td></td><td>V</td></tr> </table> <p>Damage does not affect the strength of structural member, but rehabilitation must be needed because of the appearance.</p> <table border="1" data-bbox="853 907 965 1153"> <tr><th colspan="2">Scaling/Spalling</th></tr> <tr><th>Y</th><th>Z</th></tr> <tr><td>Large</td><td>Large</td></tr> <tr><td>Small</td><td>Small</td></tr> <tr><td></td><td>IV</td></tr> <tr><td></td><td>IV</td></tr> </table> <p>Rehabilitation is not needed.</p>	Cracking		X	Z	Large	Large	Medium	Medium	Small	Small		IV		V		V	Scaling/Spalling		Y	Z	Large	Large	Small	Small		IV		IV	III* IV	
	Cracking																																
X	Z																																
Large	Large																																
Medium	Medium																																
Small	Small																																
	IV																																
	V																																
	V																																
Scaling/Spalling																																	
Y	Z																																
Large	Large																																
Small	Small																																
	IV																																
	IV																																
	<p>Cracking X: not main part Y: over 0.3mm Z: over 50cm</p> <p>Scaling/Spalling Y: no exposed reinforcement bar Z: over 1.0m²</p> <p>Breakage Y: remarkable damage</p>	Breakage	<table border="1" data-bbox="1013 929 1109 1131"> <tr><td>Y</td><td>All Members</td></tr> <tr><td>Large</td><td></td></tr> <tr><td>Small</td><td>IV</td></tr> </table> <p>Although part of damage is at local area, the degree is large so that rehabilitation must be needed.</p>	Y	All Members	Large		Small	IV	II																							
Y	All Members																																
Large																																	
Small	IV																																

() Steel Materials / confluencia

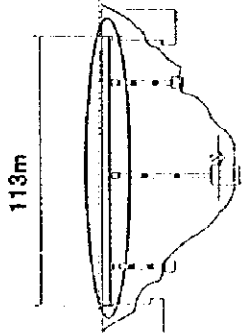
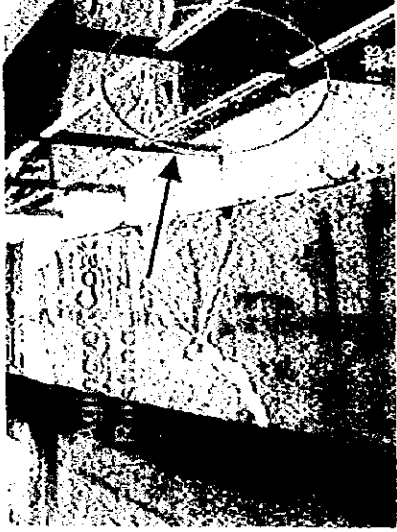
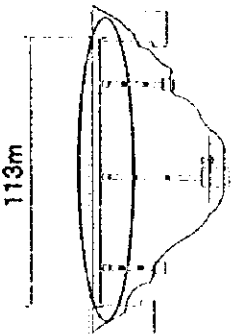
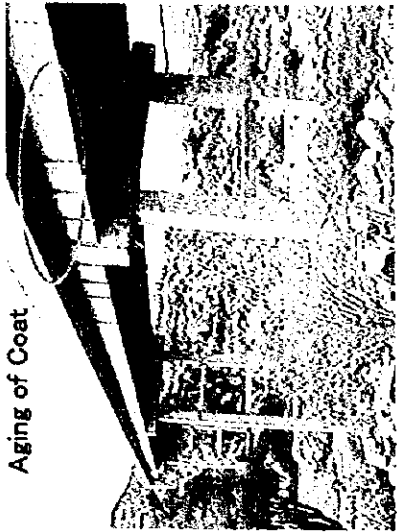
Bridge Component	Location of Damage	Damage	Evaluation of Damage	Damage Rank	Picture												
Railing	 <p>113m</p>	Rusting Aging of Coat	<table border="1"> <tr> <td>Y</td> <td>Z</td> <td>All Members</td> </tr> <tr> <td>Large</td> <td>Small</td> <td>II</td> </tr> <tr> <td>Small</td> <td>Large</td> <td>III</td> </tr> <tr> <td></td> <td>Small</td> <td>IV</td> </tr> </table> <p>Y : Means Depth Z : Means Width</p> <p>Need to paint.</p>	Y	Z	All Members	Large	Small	II	Small	Large	III		Small	IV	III	
Y	Z	All Members															
Large	Small	II															
Small	Large	III															
	Small	IV															
Beam	 <p>113m</p>	Aging of Coat	<table border="1"> <tr> <td>Y</td> <td>Z</td> <td>All Members</td> </tr> <tr> <td>Large</td> <td>Small</td> <td>III</td> </tr> <tr> <td>Small</td> <td>Large</td> <td>IV</td> </tr> <tr> <td></td> <td>Small</td> <td>OK</td> </tr> </table> <p>Y : Means Depth Z : Means Width</p> <p>Need inspection periodically.</p>	Y	Z	All Members	Large	Small	III	Small	Large	IV		Small	OK	IV	 <p>Aging of Coat</p>
Y	Z	All Members															
Large	Small	III															
Small	Large	IV															
	Small	OK															

(2) DAVID GARCIA

NOTE The bridge is located near Los Andes, a city populated with 55,000, and also plays a part of a bypass of an important trunk road. The almost 60-year old bridge was found to be seriously deteriorated not only through a visual inspection but a neutralization test conducted by JICA team. While a heavy vehicle passes the bridge, a considerable vibration is felt.

BRIDGE NUMBER	YEAR OF BUILT	
BRIDGE NAME	BRIDGE LENGTH	93.50m
REGION	BRIDGE WIDTH	8.30m
ROUTE NAME	TRAFFIC VOLUME	

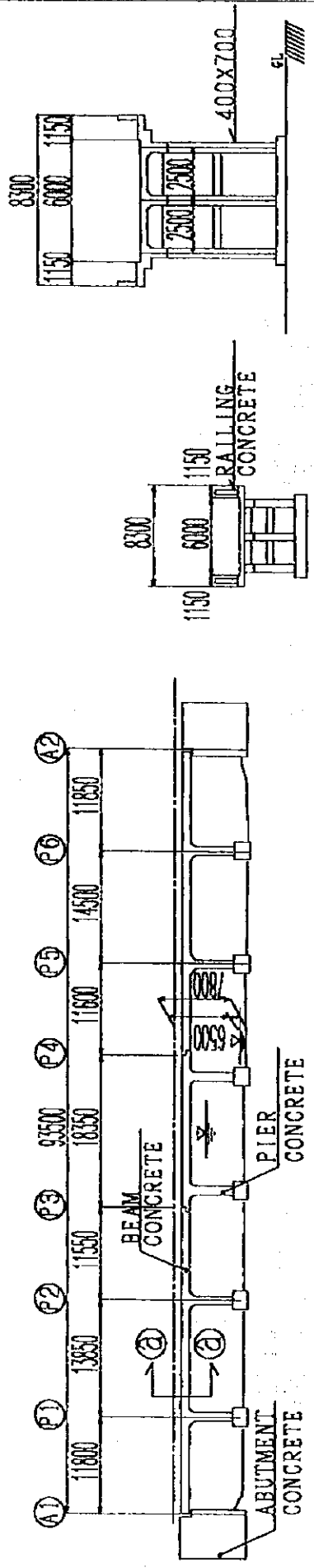

SECTION A1-A2 PIER P1~P6

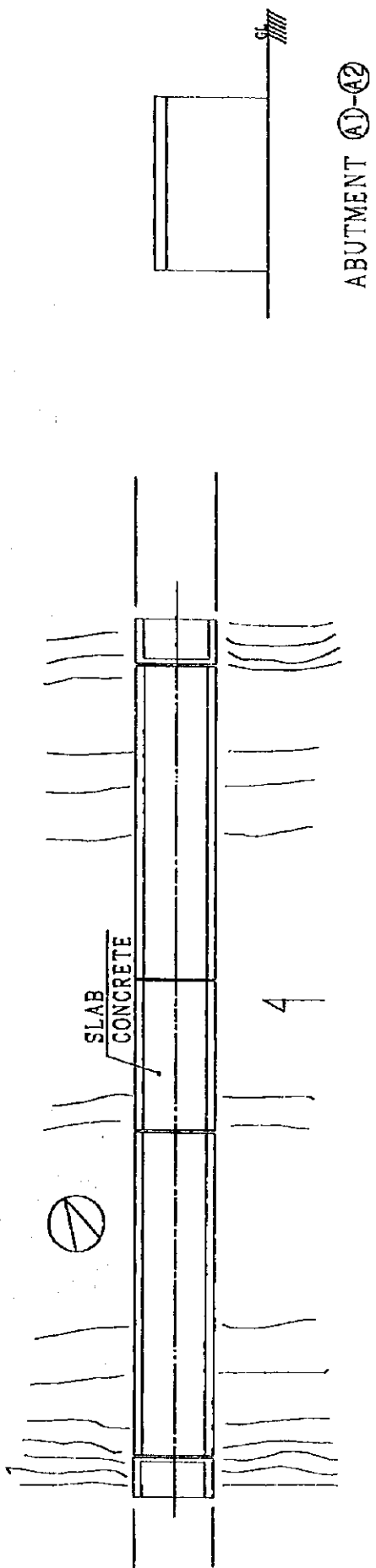

BRIDGE NO.12 BRIDGE NAME: DAVID GARCIA

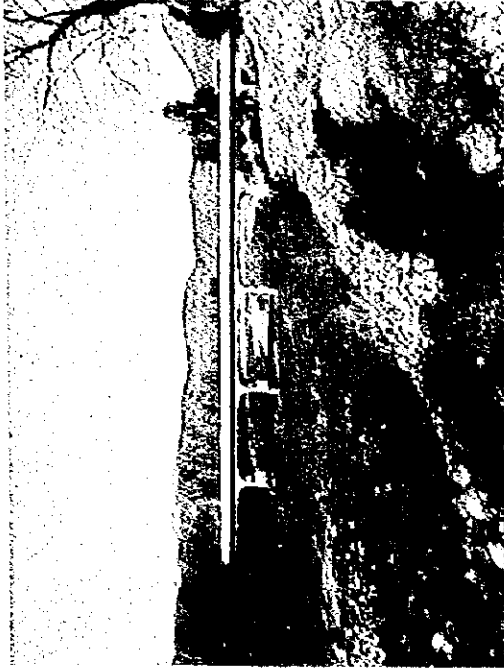



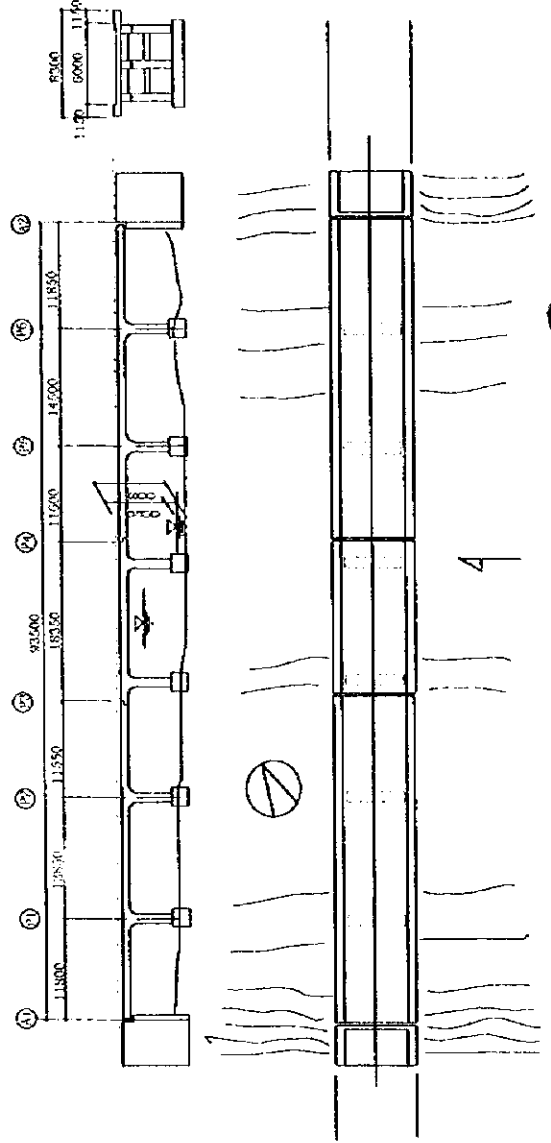

STATE	V
BRIDGE NAME	DAVID GARCIA

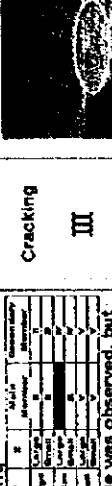
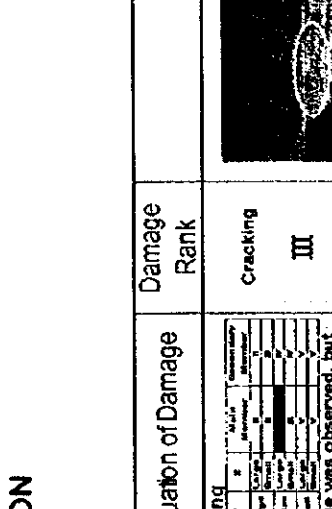
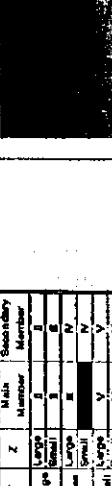
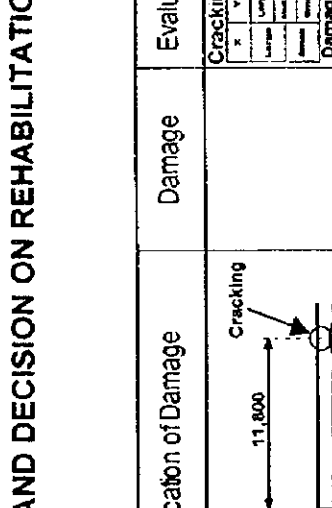
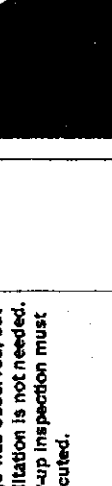
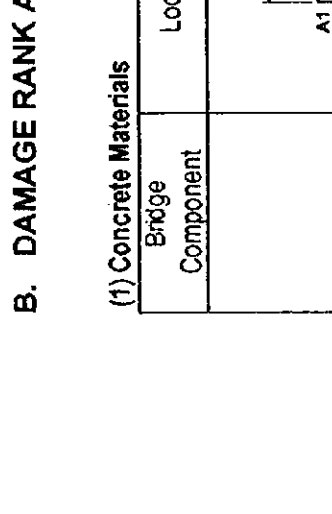

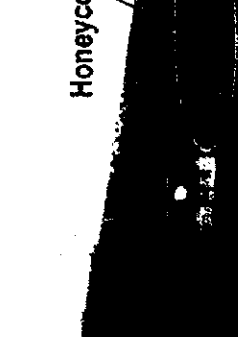
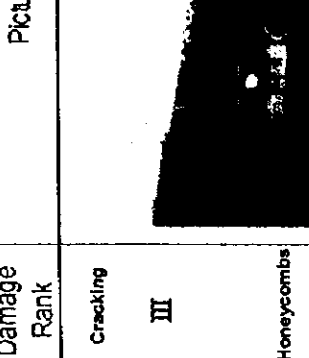
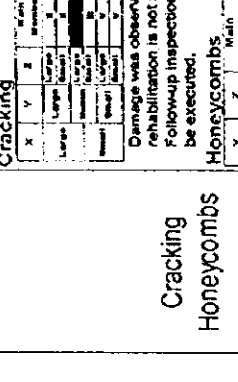
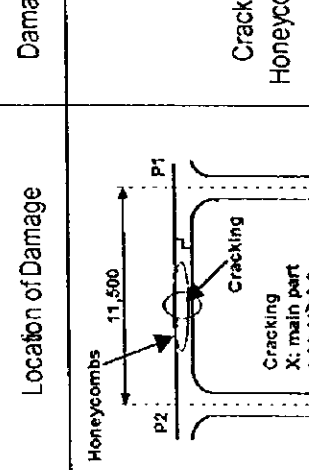
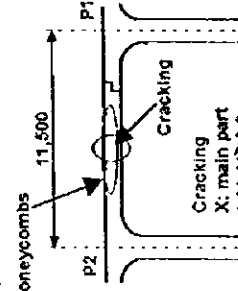

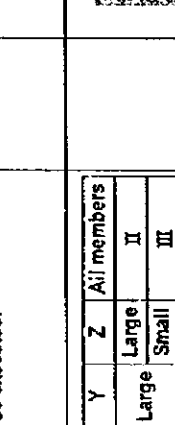
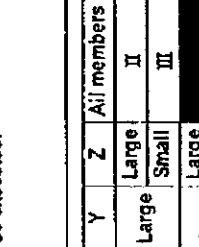

B. DAMAGE RANK AND DECISION ON REHABILITATION

Bridge Component	Location of Damage	Damage	Evaluation of Damage	Damage Rank	Picture																																								
(1) Concrete Materials	 <p>Cracking 11,800 A1 Cracking/Spalling P1</p> <p>Cracking X: main part $0.3 > Y \geq 0.2 \text{ mm}$ Z: over 50cm Scaling/Spalling Y: no exposed reinforcement bar Z: over 0.1 m²</p>	Cracking Scaling/Spalling	<p>Cracking</p> <table border="1" data-bbox="639 584 778 763"> <thead> <tr> <th>X</th> <th>Y</th> <th>Z</th> <th>Main Member</th> <th>Secondary Member</th> </tr> </thead> <tbody> <tr> <td>Large</td> <td>Large</td> <td>Large</td> <td>III</td> <td>III</td> </tr> <tr> <td>Medium</td> <td>Medium</td> <td>Medium</td> <td>IV</td> <td>IV</td> </tr> <tr> <td>Small</td> <td>Small</td> <td>Small</td> <td>V</td> <td>V</td> </tr> </tbody> </table> <p>Damage was observed, but rehabilitation is not needed. Follow-up inspection must be executed.</p> <p>Scaling/ Spalling</p> <table border="1" data-bbox="639 763 778 898"> <thead> <tr> <th>X</th> <th>Y</th> <th>Z</th> <th>Main Member</th> <th>Secondary Member</th> </tr> </thead> <tbody> <tr> <td>Large</td> <td>Large</td> <td>Large</td> <td>III</td> <td>III</td> </tr> <tr> <td>Medium</td> <td>Medium</td> <td>Medium</td> <td>IV</td> <td>IV</td> </tr> <tr> <td>Small</td> <td>Small</td> <td>Small</td> <td>V</td> <td>V</td> </tr> </tbody> </table> <p>Damage was observed, but rehabilitation is not needed. Follow-up inspection must be executed.</p>	X	Y	Z	Main Member	Secondary Member	Large	Large	Large	III	III	Medium	Medium	Medium	IV	IV	Small	Small	Small	V	V	X	Y	Z	Main Member	Secondary Member	Large	Large	Large	III	III	Medium	Medium	Medium	IV	IV	Small	Small	Small	V	V	Cracking III Scaling/ Spalling III	
X	Y	Z	Main Member	Secondary Member																																									
Large	Large	Large	III	III																																									
Medium	Medium	Medium	IV	IV																																									
Small	Small	Small	V	V																																									
X	Y	Z	Main Member	Secondary Member																																									
Large	Large	Large	III	III																																									
Medium	Medium	Medium	IV	IV																																									
Small	Small	Small	V	V																																									
Beam	 <p>13,850 P1 P2</p> <p>X: main part $0.3 > Y \geq 0.2 \text{ mm}$ Z: over 0.1 m²</p>	Cracking	<p>Cracking</p> <table border="1" data-bbox="639 1093 826 1272"> <thead> <tr> <th>X</th> <th>Y</th> <th>Z</th> <th>Main Member</th> <th>Secondary Member</th> </tr> </thead> <tbody> <tr> <td>Large</td> <td>Large</td> <td>Large</td> <td>III</td> <td>III</td> </tr> <tr> <td>Medium</td> <td>Medium</td> <td>Medium</td> <td>IV</td> <td>IV</td> </tr> <tr> <td>Small</td> <td>Small</td> <td>Small</td> <td>V</td> <td>V</td> </tr> </tbody> </table> <p>Damage was observed, but rehabilitation is not needed. Follow-up inspection must be executed.</p>	X	Y	Z	Main Member	Secondary Member	Large	Large	Large	III	III	Medium	Medium	Medium	IV	IV	Small	Small	Small	V	V	III																					
X	Y	Z	Main Member	Secondary Member																																									
Large	Large	Large	III	III																																									
Medium	Medium	Medium	IV	IV																																									
Small	Small	Small	V	V																																									
	 <p>11,500 P2 P3</p> <p>Honeycombs Efflorescence Honeycombs Y: no exposed reinforcement bar Z: over 0.1 m² Efflorescence Z: over 0.1 m²</p>	HoneyCombs Efflorescence	<p>Honeycombs</p> <table border="1" data-bbox="639 1601 826 1758"> <thead> <tr> <th>X</th> <th>Y</th> <th>Z</th> <th>Main Member</th> <th>Secondary Member</th> </tr> </thead> <tbody> <tr> <td>Large</td> <td>Large</td> <td>Large</td> <td>III</td> <td>III</td> </tr> <tr> <td>Medium</td> <td>Medium</td> <td>Medium</td> <td>IV</td> <td>IV</td> </tr> <tr> <td>Small</td> <td>Small</td> <td>Small</td> <td>V</td> <td>V</td> </tr> </tbody> </table> <p>Damage was observed, but rehabilitation is not needed. Follow-up inspection must be executed.</p> <p>Efflorescence</p> <table border="1" data-bbox="639 1758 826 1912"> <thead> <tr> <th>X</th> <th>Y</th> <th>Z</th> <th>Main Member</th> <th>Secondary Member</th> </tr> </thead> <tbody> <tr> <td>Large</td> <td>Large</td> <td>Large</td> <td>III</td> <td>III</td> </tr> <tr> <td>Medium</td> <td>Medium</td> <td>Medium</td> <td>IV</td> <td>IV</td> </tr> <tr> <td>Small</td> <td>Small</td> <td>Small</td> <td>V</td> <td>V</td> </tr> </tbody> </table> <p>Degree of damage is large, so that rehabilitation must be needed.</p>	X	Y	Z	Main Member	Secondary Member	Large	Large	Large	III	III	Medium	Medium	Medium	IV	IV	Small	Small	Small	V	V	X	Y	Z	Main Member	Secondary Member	Large	Large	Large	III	III	Medium	Medium	Medium	IV	IV	Small	Small	Small	V	V	Honeycombs III Efflorescence II	
X	Y	Z	Main Member	Secondary Member																																									
Large	Large	Large	III	III																																									
Medium	Medium	Medium	IV	IV																																									
Small	Small	Small	V	V																																									
X	Y	Z	Main Member	Secondary Member																																									
Large	Large	Large	III	III																																									
Medium	Medium	Medium	IV	IV																																									
Small	Small	Small	V	V																																									

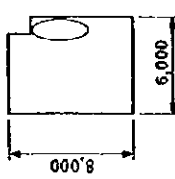
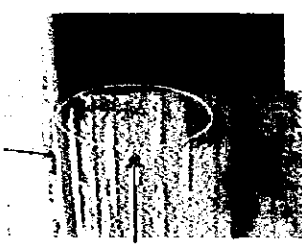
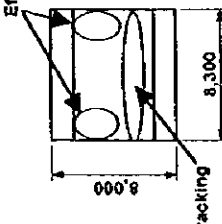
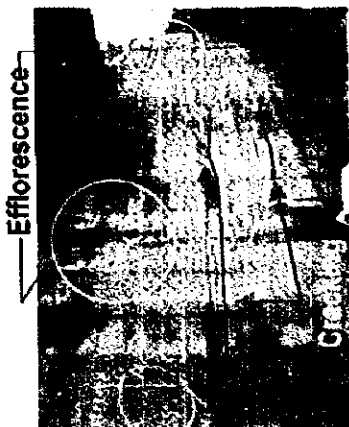
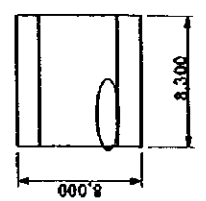
Bridge Component	Location of Damage	Damage	Evaluation of Damage	Damage Rank	Picture																																				
		Cracking Honeycombs	<p>Cracking</p> <table border="1" data-bbox="646 414 758 593"> <tr><th>X</th><th>Y</th><th>Z</th><th>Main Member</th><th>Secondary Member</th></tr> <tr><td>Large</td><td>Large</td><td>Large</td><td>0</td><td>0</td></tr> <tr><td>Medium</td><td>Medium</td><td>Medium</td><td>1</td><td>1</td></tr> <tr><td>Small</td><td>Small</td><td>Small</td><td>2</td><td>2</td></tr> </table> <p>Damage was observed, but rehabilitation is not needed. Follow-up inspection must be executed.</p> <p>Honeycombs</p> <table border="1" data-bbox="646 705 758 884"> <tr><th>Y</th><th>Z</th><th>Main Member</th><th>Secondary Member</th></tr> <tr><td>Large</td><td>Large</td><td>0</td><td>0</td></tr> <tr><td>Medium</td><td>Medium</td><td>1</td><td>1</td></tr> <tr><td>Small</td><td>Small</td><td>2</td><td>2</td></tr> </table> <p>Damage was observed, but rehabilitation is not needed. Follow-up inspection must be executed.</p>	X	Y	Z	Main Member	Secondary Member	Large	Large	Large	0	0	Medium	Medium	Medium	1	1	Small	Small	Small	2	2	Y	Z	Main Member	Secondary Member	Large	Large	0	0	Medium	Medium	1	1	Small	Small	2	2	Cracking III Honeycombs III	
X	Y	Z	Main Member	Secondary Member																																					
Large	Large	Large	0	0																																					
Medium	Medium	Medium	1	1																																					
Small	Small	Small	2	2																																					
Y	Z	Main Member	Secondary Member																																						
Large	Large	0	0																																						
Medium	Medium	1	1																																						
Small	Small	2	2																																						
Beam		Cracking Honeycombs	Damage (cracking and honeycombs) were observed but damage rank was not justified because of inspection by distant view.	No rank																																					
		Cracking Honeycombs	Damage (cracking and honeycombs) were observed but damage rank was not justified because of inspection by distant view.	No rank																																					

Bridge Component	Location of Damage	Damage	Evaluation of Damage	Damage Rank	Picture																																													
Slab	<p>Slab 1 = 11,800 Slab 2 = 13,850</p>  <p>Cracking X: main part 0.3 > Y \geq 0.2mm Z: less 50cm</p> <p>Efflorescence Z: less 1.0m²</p>	Cracking Efflorescence	<p>Cracking</p> <table border="1" data-bbox="646 504 821 772"> <tr> <th>X</th> <th>Y</th> <th>Z</th> <th>All member</th> </tr> <tr> <td>Large</td> <td>Medium</td> <td>Large</td> <td>II</td> </tr> <tr> <td>Small</td> <td>Small</td> <td>Small</td> <td>II</td> </tr> <tr> <td>Large</td> <td>Large</td> <td>Small</td> <td>III</td> </tr> <tr> <td>Small</td> <td>Small</td> <td>Small</td> <td>III</td> </tr> <tr> <td>Large</td> <td>Large</td> <td>Large</td> <td>IV</td> </tr> <tr> <td>Small</td> <td>Small</td> <td>Small</td> <td>IV</td> </tr> <tr> <td>Large</td> <td>Large</td> <td>Large</td> <td>IV</td> </tr> <tr> <td>Small</td> <td>Small</td> <td>Small</td> <td>IV</td> </tr> </table> <p>Degree of damage is large, so that rehabilitation must be needed.</p> <p>Efflorescence</p> <table border="1" data-bbox="646 772 821 907"> <tr> <th>Z</th> <th>Main Member</th> <th>Secondary Member</th> </tr> <tr> <td>Large</td> <td>II</td> <td>II</td> </tr> <tr> <td>Small</td> <td>IV</td> <td>IV</td> </tr> </table> <p>Damage was observed, but rehabilitation is not needed. Follow-up inspection must be executed.</p>	X	Y	Z	All member	Large	Medium	Large	II	Small	Small	Small	II	Large	Large	Small	III	Small	Small	Small	III	Large	Large	Large	IV	Small	Small	Small	IV	Large	Large	Large	IV	Small	Small	Small	IV	Z	Main Member	Secondary Member	Large	II	II	Small	IV	IV	Cracking II	
	X	Y	Z	All member																																														
Large	Medium	Large	II																																															
Small	Small	Small	II																																															
Large	Large	Small	III																																															
Small	Small	Small	III																																															
Large	Large	Large	IV																																															
Small	Small	Small	IV																																															
Large	Large	Large	IV																																															
Small	Small	Small	IV																																															
Z	Main Member	Secondary Member																																																
Large	II	II																																																
Small	IV	IV																																																
	<p>Average = 13,400</p>  <p>Y: no exposed reinforcement bar Z: over 1.0m² (whole area of the bridge surface)</p>	Wear	<p>Efflorescence</p> <table border="1" data-bbox="646 1512 821 1646"> <tr> <th>Z</th> <th>Main Member</th> <th>Secondary Member</th> </tr> <tr> <td>Large</td> <td>II</td> <td>II</td> </tr> <tr> <td>Small</td> <td>IV</td> <td>IV</td> </tr> </table> <p>Damage was observed, but rehabilitation is not needed. Follow-up inspection must be executed.</p>	Z	Main Member	Secondary Member	Large	II	II	Small	IV	IV	Efflorescence III																																					
Z	Main Member	Secondary Member																																																
Large	II	II																																																
Small	IV	IV																																																

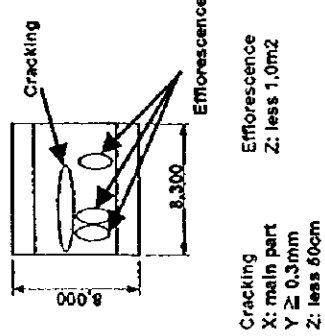
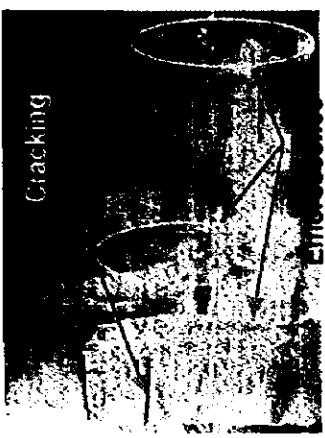
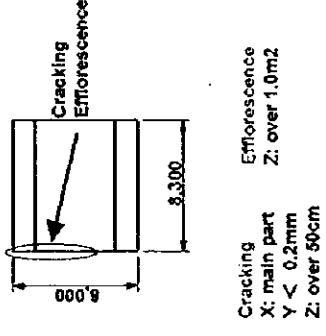
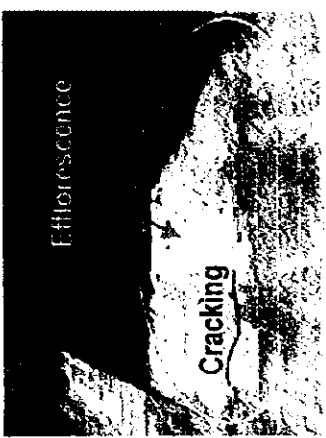
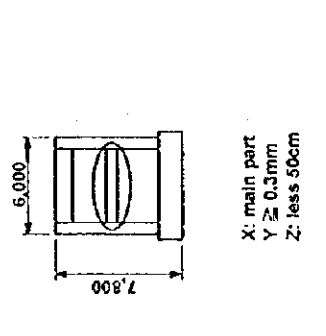
Bridge Component	Location of Damage	Damage	Evaluation of Damage	Damage Rank	Picture																																																																																																																																						
	 <p>X: main part Y: $\geq 0.3\text{mm}$ Z: over 50cm</p>	Cracking	<table border="1" data-bbox="287 896 430 1153"> <thead> <tr> <th rowspan="2">X</th> <th rowspan="2">Y</th> <th rowspan="2">Z</th> <th colspan="2">Main Member</th> <th colspan="2">Secondary Member</th> </tr> <tr> <th>Large</th> <th>Small</th> <th>Large</th> <th>Small</th> </tr> </thead> <tbody> <tr> <td>Large</td> <td>Large</td> <td>Large</td> <td>II</td> <td>III</td> <td>III</td> <td>IV</td> </tr> <tr> <td>Large</td> <td>Large</td> <td>Small</td> <td>III</td> <td>IV</td> <td>IV</td> <td>V</td> </tr> <tr> <td>Large</td> <td>Small</td> <td>Large</td> <td>III</td> <td>IV</td> <td>IV</td> <td>V</td> </tr> <tr> <td>Large</td> <td>Small</td> <td>Small</td> <td>IV</td> <td>V</td> <td>V</td> <td>V</td> </tr> <tr> <td>Small</td> <td>Large</td> <td>Large</td> <td>IV</td> <td>V</td> <td>V</td> <td>V</td> </tr> <tr> <td>Small</td> <td>Large</td> <td>Small</td> <td>V</td> <td>V</td> <td>V</td> <td>V</td> </tr> <tr> <td>Small</td> <td>Small</td> <td>Large</td> <td>V</td> <td>V</td> <td>V</td> <td>V</td> </tr> <tr> <td>Small</td> <td>Small</td> <td>Small</td> <td>V</td> <td>V</td> <td>V</td> <td>V</td> </tr> </tbody> </table> <p>Degree of damage is large, so that rehabilitation must be needed.</p>	X	Y	Z	Main Member		Secondary Member		Large	Small	Large	Small	Large	Large	Large	II	III	III	IV	Large	Large	Small	III	IV	IV	V	Large	Small	Large	III	IV	IV	V	Large	Small	Small	IV	V	V	V	Small	Large	Large	IV	V	V	V	Small	Large	Small	V	V	V	V	Small	Small	Large	V	V	V	V	Small	Small	Small	V	V	V	V	II																																																																				
X	Y	Z	Main Member				Secondary Member																																																																																																																																				
			Large	Small	Large	Small																																																																																																																																					
Large	Large	Large	II	III	III	IV																																																																																																																																					
Large	Large	Small	III	IV	IV	V																																																																																																																																					
Large	Small	Large	III	IV	IV	V																																																																																																																																					
Large	Small	Small	IV	V	V	V																																																																																																																																					
Small	Large	Large	IV	V	V	V																																																																																																																																					
Small	Large	Small	V	V	V	V																																																																																																																																					
Small	Small	Large	V	V	V	V																																																																																																																																					
Small	Small	Small	V	V	V	V																																																																																																																																					
A1 Abutment	 <p>Cracking X: main part Y: $\geq 0.2\text{mm}$ Z: less 50cm</p> <p>Efflorescence X: main part Y: less 1.0m² Z: less 1.0m²</p>	Cracking Efflorescence	<table border="1" data-bbox="606 896 750 1153"> <thead> <tr> <th rowspan="2">X</th> <th rowspan="2">Y</th> <th rowspan="2">Z</th> <th colspan="2">Main Member</th> <th colspan="2">Secondary Member</th> </tr> <tr> <th>Large</th> <th>Small</th> <th>Large</th> <th>Small</th> </tr> </thead> <tbody> <tr> <td>Large</td> <td>Large</td> <td>Large</td> <td>III</td> <td>IV</td> <td>IV</td> <td>V</td> </tr> <tr> <td>Large</td> <td>Large</td> <td>Small</td> <td>IV</td> <td>V</td> <td>V</td> <td>V</td> </tr> <tr> <td>Large</td> <td>Small</td> <td>Large</td> <td>IV</td> <td>V</td> <td>V</td> <td>V</td> </tr> <tr> <td>Large</td> <td>Small</td> <td>Small</td> <td>V</td> <td>V</td> <td>V</td> <td>V</td> </tr> <tr> <td>Small</td> <td>Large</td> <td>Large</td> <td>V</td> <td>V</td> <td>V</td> <td>V</td> </tr> <tr> <td>Small</td> <td>Large</td> <td>Small</td> <td>V</td> <td>V</td> <td>V</td> <td>V</td> </tr> <tr> <td>Small</td> <td>Small</td> <td>Large</td> <td>V</td> <td>V</td> <td>V</td> <td>V</td> </tr> <tr> <td>Small</td> <td>Small</td> <td>Small</td> <td>V</td> <td>V</td> <td>V</td> <td>V</td> </tr> </tbody> </table> <p>Although damage rank is III, cracking is distinct so that rehabilitation must be needed.</p> <table border="1" data-bbox="829 896 973 1153"> <thead> <tr> <th rowspan="2">X</th> <th rowspan="2">Y</th> <th rowspan="2">Z</th> <th colspan="2">Main Member</th> <th colspan="2">Secondary Member</th> </tr> <tr> <th>Large</th> <th>Small</th> <th>Large</th> <th>Small</th> </tr> </thead> <tbody> <tr> <td>Large</td> <td>Large</td> <td>Large</td> <td>III</td> <td>IV</td> <td>IV</td> <td>V</td> </tr> <tr> <td>Large</td> <td>Large</td> <td>Small</td> <td>IV</td> <td>V</td> <td>V</td> <td>V</td> </tr> <tr> <td>Large</td> <td>Small</td> <td>Large</td> <td>IV</td> <td>V</td> <td>V</td> <td>V</td> </tr> <tr> <td>Large</td> <td>Small</td> <td>Small</td> <td>V</td> <td>V</td> <td>V</td> <td>V</td> </tr> <tr> <td>Small</td> <td>Large</td> <td>Large</td> <td>V</td> <td>V</td> <td>V</td> <td>V</td> </tr> <tr> <td>Small</td> <td>Large</td> <td>Small</td> <td>V</td> <td>V</td> <td>V</td> <td>V</td> </tr> <tr> <td>Small</td> <td>Small</td> <td>Large</td> <td>V</td> <td>V</td> <td>V</td> <td>V</td> </tr> <tr> <td>Small</td> <td>Small</td> <td>Small</td> <td>V</td> <td>V</td> <td>V</td> <td>V</td> </tr> </tbody> </table> <p>Damage was observed, but rehabilitation is not needed. Follow-up inspection must be executed.</p>	X	Y	Z	Main Member		Secondary Member		Large	Small	Large	Small	Large	Large	Large	III	IV	IV	V	Large	Large	Small	IV	V	V	V	Large	Small	Large	IV	V	V	V	Large	Small	Small	V	V	V	V	Small	Large	Large	V	V	V	V	Small	Large	Small	V	V	V	V	Small	Small	Large	V	V	V	V	Small	Small	Small	V	V	V	V	X	Y	Z	Main Member		Secondary Member		Large	Small	Large	Small	Large	Large	Large	III	IV	IV	V	Large	Large	Small	IV	V	V	V	Large	Small	Large	IV	V	V	V	Large	Small	Small	V	V	V	V	Small	Large	Large	V	V	V	V	Small	Large	Small	V	V	V	V	Small	Small	Large	V	V	V	V	Small	Small	Small	V	V	V	V	Cracking * III Efflorescence III	
X	Y	Z	Main Member				Secondary Member																																																																																																																																				
			Large	Small	Large	Small																																																																																																																																					
Large	Large	Large	III	IV	IV	V																																																																																																																																					
Large	Large	Small	IV	V	V	V																																																																																																																																					
Large	Small	Large	IV	V	V	V																																																																																																																																					
Large	Small	Small	V	V	V	V																																																																																																																																					
Small	Large	Large	V	V	V	V																																																																																																																																					
Small	Large	Small	V	V	V	V																																																																																																																																					
Small	Small	Large	V	V	V	V																																																																																																																																					
Small	Small	Small	V	V	V	V																																																																																																																																					
X	Y	Z	Main Member		Secondary Member																																																																																																																																						
			Large	Small	Large	Small																																																																																																																																					
Large	Large	Large	III	IV	IV	V																																																																																																																																					
Large	Large	Small	IV	V	V	V																																																																																																																																					
Large	Small	Large	IV	V	V	V																																																																																																																																					
Large	Small	Small	V	V	V	V																																																																																																																																					
Small	Large	Large	V	V	V	V																																																																																																																																					
Small	Large	Small	V	V	V	V																																																																																																																																					
Small	Small	Large	V	V	V	V																																																																																																																																					
Small	Small	Small	V	V	V	V																																																																																																																																					
A2 Abutment	 <p>Y: exposed reinforcement bar Z: less 1.0m²</p>	Delamination	<table border="1" data-bbox="1005 896 1149 1153"> <thead> <tr> <th rowspan="2">Y</th> <th rowspan="2">Z</th> <th colspan="2">Main Member</th> <th colspan="2">Secondary Member</th> </tr> <tr> <th>Large</th> <th>Small</th> <th>Large</th> <th>Small</th> </tr> </thead> <tbody> <tr> <td>Large</td> <td>Large</td> <td>II</td> <td>III</td> <td>III</td> <td>IV</td> </tr> <tr> <td>Large</td> <td>Small</td> <td>III</td> <td>IV</td> <td>IV</td> <td>V</td> </tr> <tr> <td>Small</td> <td>Large</td> <td>III</td> <td>IV</td> <td>IV</td> <td>V</td> </tr> <tr> <td>Small</td> <td>Small</td> <td>IV</td> <td>V</td> <td>V</td> <td>V</td> </tr> </tbody> </table> <p>Although damage rank is III, reinforcement bar is exposed so that rehabilitation must be needed.</p>	Y	Z	Main Member		Secondary Member		Large	Small	Large	Small	Large	Large	II	III	III	IV	Large	Small	III	IV	IV	V	Small	Large	III	IV	IV	V	Small	Small	IV	V	V	V	* III																																																																																																					
Y	Z	Main Member				Secondary Member																																																																																																																																					
		Large	Small	Large	Small																																																																																																																																						
Large	Large	II	III	III	IV																																																																																																																																						
Large	Small	III	IV	IV	V																																																																																																																																						
Small	Large	III	IV	IV	V																																																																																																																																						
Small	Small	IV	V	V	V																																																																																																																																						

Bridge Component	Location of Damage	Damage	Evaluation of Damage	Damage Rank	Picture																																								
A2 Abutment	 <p>Cracking X: main part Y \geq 0.3mm Z: less 60cm</p> <p>Efflorescence Z: less 1.0m²</p>	Cracking Efflorescence	<p>Cracking</p> <table border="1"> <tr><th>X</th><th>Y</th><th>Z</th><th>Main Member</th><th>Secondary Member</th></tr> <tr><td>Large</td><td>Large</td><td>Small</td><td>■</td><td>■</td></tr> <tr><td>Medium</td><td>Medium</td><td>Medium</td><td>■</td><td>■</td></tr> <tr><td>Small</td><td>Small</td><td>Large</td><td>■</td><td>■</td></tr> <tr><td>None</td><td>None</td><td>None</td><td>■</td><td>■</td></tr> </table> <p>Degree of damage is large, so that rehabilitation must be needed.</p> <p>Efflorescence</p> <table border="1"> <tr><th>Z</th><th>Main Member</th><th>Secondary Member</th></tr> <tr><td>Large</td><td>■</td><td>■</td></tr> <tr><td>Medium</td><td>■</td><td>■</td></tr> <tr><td>Small</td><td>■</td><td>■</td></tr> <tr><td>None</td><td>■</td><td>■</td></tr> </table> <p>Degree of damage is large, but rehabilitation is not needed. Follow-up inspection must be executed.</p>	X	Y	Z	Main Member	Secondary Member	Large	Large	Small	■	■	Medium	Medium	Medium	■	■	Small	Small	Large	■	■	None	None	None	■	■	Z	Main Member	Secondary Member	Large	■	■	Medium	■	■	Small	■	■	None	■	■	Cracking II Efflorescence III	
	X	Y	Z	Main Member	Secondary Member																																								
Large	Large	Small	■	■																																									
Medium	Medium	Medium	■	■																																									
Small	Small	Large	■	■																																									
None	None	None	■	■																																									
Z	Main Member	Secondary Member																																											
Large	■	■																																											
Medium	■	■																																											
Small	■	■																																											
None	■	■																																											
	 <p>Cracking X: main part Y < 0.2mm Z: over 50cm</p> <p>Efflorescence Z: over 1.0m²</p>	Cracking Efflorescence	<p>Cracking</p> <table border="1"> <tr><th>X</th><th>Y</th><th>Z</th><th>Main Member</th><th>Secondary Member</th></tr> <tr><td>Large</td><td>Large</td><td>Small</td><td>■</td><td>■</td></tr> <tr><td>Medium</td><td>Medium</td><td>Medium</td><td>■</td><td>■</td></tr> <tr><td>Small</td><td>Small</td><td>Large</td><td>■</td><td>■</td></tr> <tr><td>None</td><td>None</td><td>None</td><td>■</td><td>■</td></tr> </table> <p>Condition is sound</p> <p>Efflorescence</p> <table border="1"> <tr><th>Z</th><th>Main Member</th><th>Secondary Member</th></tr> <tr><td>Large</td><td>■</td><td>■</td></tr> <tr><td>Medium</td><td>■</td><td>■</td></tr> <tr><td>Small</td><td>■</td><td>■</td></tr> <tr><td>None</td><td>■</td><td>■</td></tr> </table> <p>Degree of damage is large, so that rehabilitation must be needed.</p>	X	Y	Z	Main Member	Secondary Member	Large	Large	Small	■	■	Medium	Medium	Medium	■	■	Small	Small	Large	■	■	None	None	None	■	■	Z	Main Member	Secondary Member	Large	■	■	Medium	■	■	Small	■	■	None	■	■	Cracking V Efflorescence II	
X	Y	Z	Main Member	Secondary Member																																									
Large	Large	Small	■	■																																									
Medium	Medium	Medium	■	■																																									
Small	Small	Large	■	■																																									
None	None	None	■	■																																									
Z	Main Member	Secondary Member																																											
Large	■	■																																											
Medium	■	■																																											
Small	■	■																																											
None	■	■																																											
P5 Pier	 <p>X: main part Y \geq 0.3mm Z: less 50cm</p>	Cracking	<table border="1"> <tr><th>X</th><th>Y</th><th>Z</th><th>Main Member</th><th>Secondary Member</th></tr> <tr><td>Large</td><td>Large</td><td>Small</td><td>■</td><td>■</td></tr> <tr><td>Medium</td><td>Medium</td><td>Medium</td><td>■</td><td>■</td></tr> <tr><td>Small</td><td>Small</td><td>Large</td><td>■</td><td>■</td></tr> <tr><td>None</td><td>None</td><td>None</td><td>■</td><td>■</td></tr> </table> <p>Degree of damage is large, so that rehabilitation must be needed.</p>	X	Y	Z	Main Member	Secondary Member	Large	Large	Small	■	■	Medium	Medium	Medium	■	■	Small	Small	Large	■	■	None	None	None	■	■	II																
X	Y	Z	Main Member	Secondary Member																																									
Large	Large	Small	■	■																																									
Medium	Medium	Medium	■	■																																									
Small	Small	Large	■	■																																									
None	None	None	■	■																																									

Bridge Component	Location of Damage	Damage	Evaluation of Damage	Damage Rank	Picture																								
P6 Pier	<p>Cracking X: main part $0.3 > Y: \geq 0.2\text{mm}$ Z: less 50cm Scaling/ Spalling Y: no exposed reinforcement bar Z: over 1.0m²</p>	Cracking Scaling/Spalling	<p>Cracking</p> <table border="1"> <tr><th>Y</th><th>Z</th><th>Main Member</th><th>Secondary Member</th></tr> <tr><td>Large</td><td>Large</td><td>U</td><td>U</td></tr> <tr><td>Small</td><td>Small</td><td>U</td><td>U</td></tr> </table> <p>Although damage rank is III, the cracking is distributed over the surface of pier so that rehabilitation must be needed.</p> <p>Scaling/ Spalling</p> <table border="1"> <tr><th>Y</th><th>Z</th><th>Main Member</th><th>Secondary Member</th></tr> <tr><td>Large</td><td>Large</td><td>U</td><td>U</td></tr> <tr><td>Small</td><td>Small</td><td>U</td><td>U</td></tr> </table> <p>Damage was observed, but rehabilitation is not needed. Followup inspection must be executed.</p>	Y	Z	Main Member	Secondary Member	Large	Large	U	U	Small	Small	U	U	Y	Z	Main Member	Secondary Member	Large	Large	U	U	Small	Small	U	U	Cracking III* Scaling/ Spalling III	
Y	Z	Main Member	Secondary Member																										
Large	Large	U	U																										
Small	Small	U	U																										
Y	Z	Main Member	Secondary Member																										
Large	Large	U	U																										
Small	Small	U	U																										
P5 Pier Foundation	<p>Scaling/ Spalling Y: no exposed reinforcement bar Z: less 1.0m² Honeycombs Y: no exposed reinforcement bar Z: less 1.0m²</p>	Scaling/Spalling Honeycombs	<p>Scaling/ Spalling</p> <table border="1"> <tr><th>Y</th><th>Z</th><th>Main Member</th><th>Secondary Member</th></tr> <tr><td>Large</td><td>Large</td><td>U</td><td>U</td></tr> <tr><td>Small</td><td>Small</td><td>U</td><td>U</td></tr> </table> <p>Damage was observed, but rehabilitation is not needed. Followup inspection must be executed.</p> <p>Honeycombs</p> <table border="1"> <tr><th>Y</th><th>Z</th><th>Main Member</th><th>Secondary Member</th></tr> <tr><td>Large</td><td>Large</td><td>U</td><td>U</td></tr> <tr><td>Small</td><td>Small</td><td>U</td><td>U</td></tr> </table> <p>Damage was observed, but rehabilitation is not needed. Followup inspection must be executed.</p>	Y	Z	Main Member	Secondary Member	Large	Large	U	U	Small	Small	U	U	Y	Z	Main Member	Secondary Member	Large	Large	U	U	Small	Small	U	U	Scaling/ Spalling IV Honeycombs IV	
Y	Z	Main Member	Secondary Member																										
Large	Large	U	U																										
Small	Small	U	U																										
Y	Z	Main Member	Secondary Member																										
Large	Large	U	U																										
Small	Small	U	U																										
P6 Pier Foundation	<p>Efflorescence Z: less 1.0m² Honeycombs Y: no exposed reinforcement bar Z: less 1.0m²</p>	Efflorescence Honeycombs	<p>Efflorescence</p> <table border="1"> <tr><th>Y</th><th>Z</th><th>Main Member</th><th>Secondary Member</th></tr> <tr><td>Large</td><td>Large</td><td>U</td><td>U</td></tr> <tr><td>Small</td><td>Small</td><td>U</td><td>U</td></tr> </table> <p>Damage was observed, but rehabilitation is not needed. Followup inspection must be executed.</p> <p>Honeycombs</p> <table border="1"> <tr><th>Y</th><th>Z</th><th>Main Member</th><th>Secondary Member</th></tr> <tr><td>Large</td><td>Large</td><td>U</td><td>U</td></tr> <tr><td>Small</td><td>Small</td><td>U</td><td>U</td></tr> </table> <p>Damage was observed, the rank must be recorded.</p>	Y	Z	Main Member	Secondary Member	Large	Large	U	U	Small	Small	U	U	Y	Z	Main Member	Secondary Member	Large	Large	U	U	Small	Small	U	U	Efflorescence III Honeycombs IV	
Y	Z	Main Member	Secondary Member																										
Large	Large	U	U																										
Small	Small	U	U																										
Y	Z	Main Member	Secondary Member																										
Large	Large	U	U																										
Small	Small	U	U																										

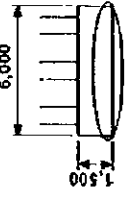
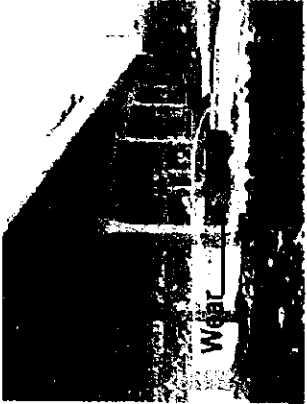
Bridge Component	Location of Damage	Damage	Evaluation of Damage	Damage Rank	Picture
P3 ~ P5 Pier Foundation		Wear	Wear was observed, the rank was not justified because of inspection by distant view.	No rank	

(3) GRANALLAS

NOTE Several damages such as the corrosion of steel structures and the scaling of the concrete were found. Furthermore the road way has only one lane and the footpath is too narrow.

BRIDGE NUMBER	YEAR OF BUILT	TRAFFIC VOLUME
BRIDGE NAME	BRIDGE LENGTH	50.00m
REGION	BRIDGE WIDTH	4.30m
ROUTE NAME	B-533	

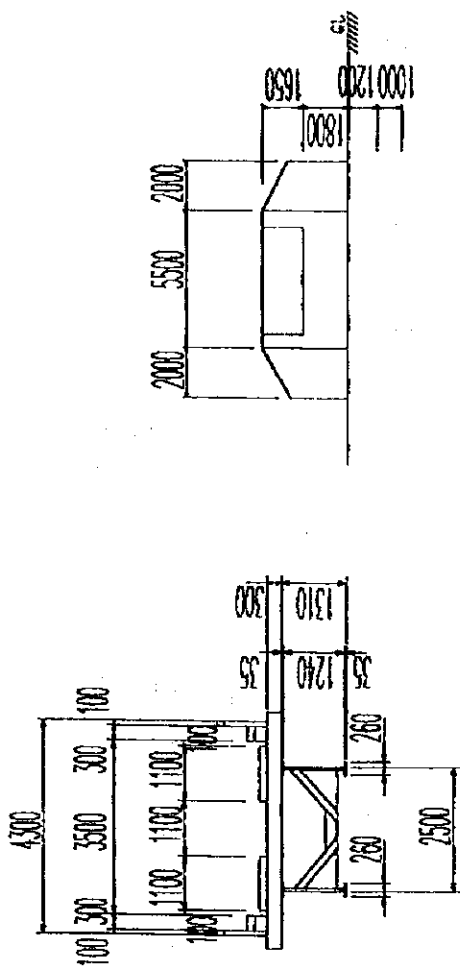

SECTION (A)-(A)

SECTION (B)-(B)

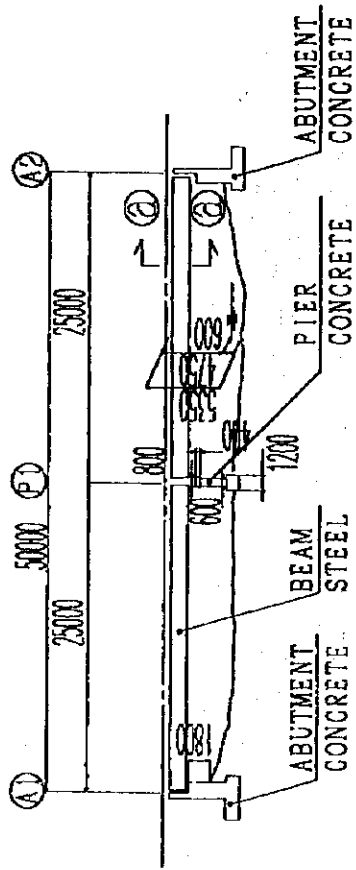

PROFOLE

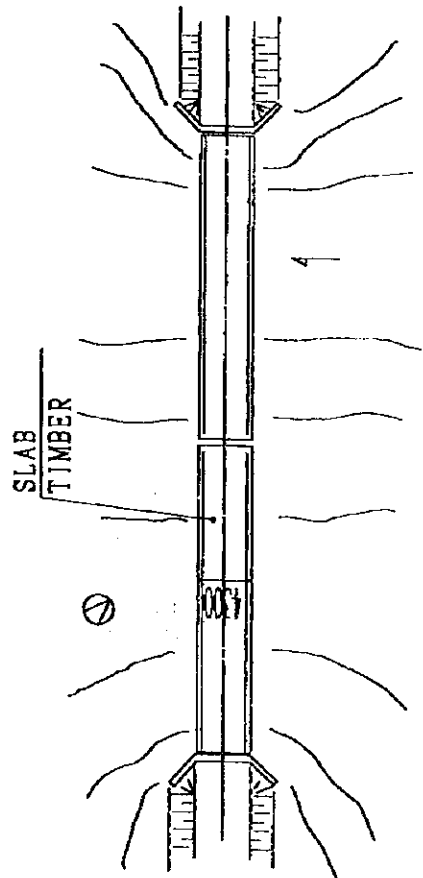

PLAN

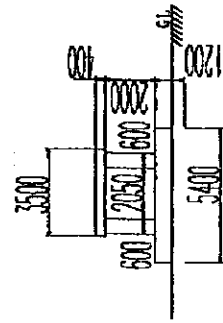

PIER (D)



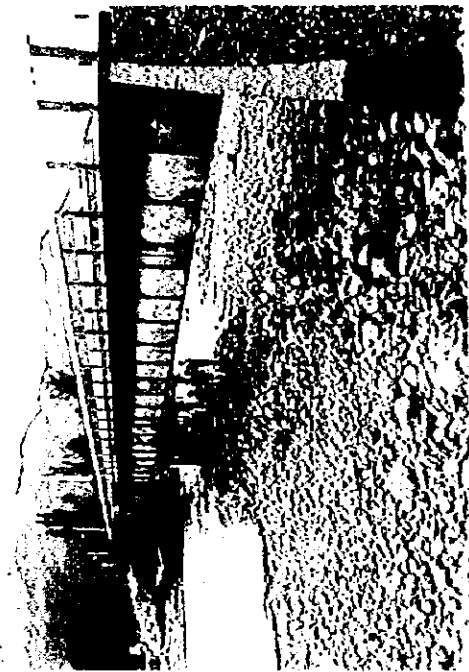

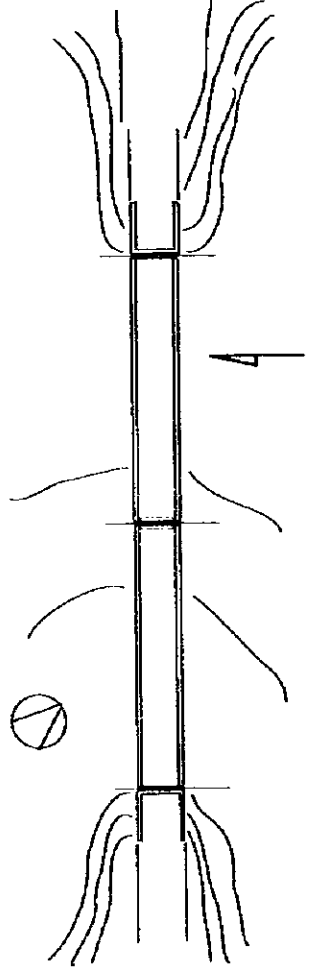
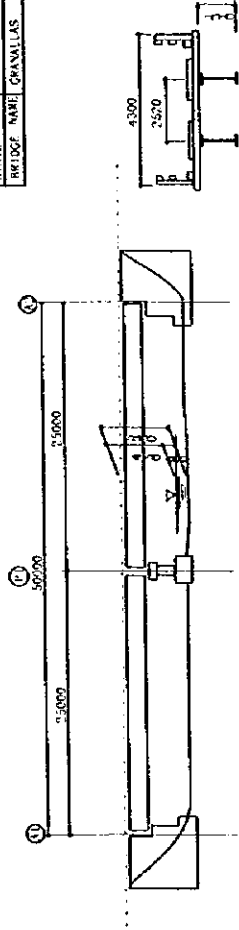

BRIDGE NO.3 BRIDGE NAME: GRANALLAS



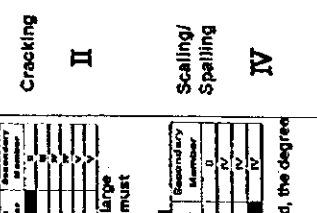

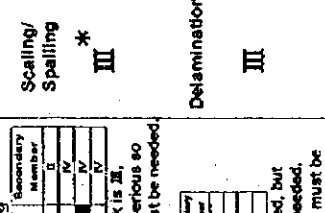

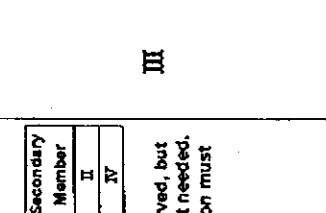
STATE	V
BRIDGE NAME	GRANALLAS



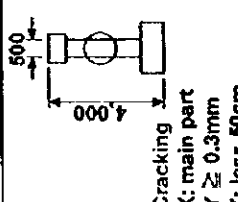

B. DAMAGE RANK AND DECISION ON REHABILITATION

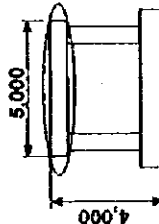
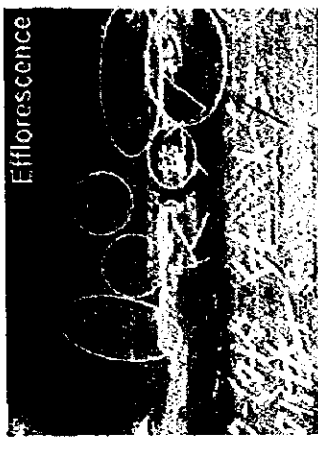
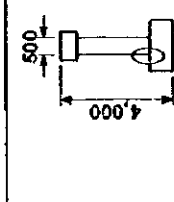
(1) Concrete Materials	Bridge Component	Location of Damage	Damage	Evaluation of Damage	Damage Rank	Picture																																
		 <p>Cracking X: main part Y: over 0.3mm Z: less 50 cm Scalling/ Spalling Y: no exposed reinforcement bar Z: less 1.0m2</p>	<p>Cracking Scalling/Spalling</p>	<p>Cracking</p> <table border="1" style="font-size: small;"> <thead> <tr> <th>Y</th> <th>Z</th> <th>Main Member</th> <th>Secondary Member</th> </tr> </thead> <tbody> <tr> <td>Large</td> <td>Large</td> <td>II</td> <td>III</td> </tr> <tr> <td>Medium</td> <td>Medium</td> <td>III</td> <td>IV</td> </tr> <tr> <td>Small</td> <td>Small</td> <td>IV</td> <td>IV</td> </tr> </tbody> </table> <p>Degree of damage is large so that rehabilitation must be needed.</p> <p>Scalling/ Spalling</p> <table border="1" style="font-size: small;"> <thead> <tr> <th>Y</th> <th>Z</th> <th>Main Member</th> <th>Secondary Member</th> </tr> </thead> <tbody> <tr> <td>Large</td> <td>Large</td> <td>II</td> <td>III</td> </tr> <tr> <td>Medium</td> <td>Medium</td> <td>III</td> <td>IV</td> </tr> <tr> <td>Small</td> <td>Small</td> <td>IV</td> <td>IV</td> </tr> </tbody> </table> <p>Damage was observed, the degree must be recorded.</p>	Y	Z	Main Member	Secondary Member	Large	Large	II	III	Medium	Medium	III	IV	Small	Small	IV	IV	Y	Z	Main Member	Secondary Member	Large	Large	II	III	Medium	Medium	III	IV	Small	Small	IV	IV	<p>Cracking II</p> <p>Scalling/ Spalling IV</p>	
Y	Z	Main Member	Secondary Member																																			
Large	Large	II	III																																			
Medium	Medium	III	IV																																			
Small	Small	IV	IV																																			
Y	Z	Main Member	Secondary Member																																			
Large	Large	II	III																																			
Medium	Medium	III	IV																																			
Small	Small	IV	IV																																			
	A1 Abutment	 <p>Scalling/ Spalling Delamination</p> <p>Scalling/ Spalling Y: no exposed reinforcement bar but deep Z: over 1.0m2 Delamination Y: no exposed reinforcement bar Z: over 1.0m2</p>	<p>Scalling/Spalling Delamination</p>	<p>Scalling/ Spalling</p> <table border="1" style="font-size: small;"> <thead> <tr> <th>Y</th> <th>Z</th> <th>Main Member</th> <th>Secondary Member</th> </tr> </thead> <tbody> <tr> <td>Large</td> <td>Large</td> <td>II</td> <td>III</td> </tr> <tr> <td>Medium</td> <td>Medium</td> <td>III</td> <td>IV</td> </tr> <tr> <td>Small</td> <td>Small</td> <td>IV</td> <td>IV</td> </tr> </tbody> </table> <p>Although damage rank is III, degree of damage is serious so that rehabilitation must be needed.</p> <p>Delamination</p> <table border="1" style="font-size: small;"> <thead> <tr> <th>Y</th> <th>Z</th> <th>Main Member</th> <th>Secondary Member</th> </tr> </thead> <tbody> <tr> <td>Large</td> <td>Large</td> <td>II</td> <td>III</td> </tr> <tr> <td>Medium</td> <td>Medium</td> <td>III</td> <td>IV</td> </tr> <tr> <td>Small</td> <td>Small</td> <td>IV</td> <td>IV</td> </tr> </tbody> </table> <p>Damage was observed, but rehabilitation is not needed. Follow-up inspection must be executed.</p>	Y	Z	Main Member	Secondary Member	Large	Large	II	III	Medium	Medium	III	IV	Small	Small	IV	IV	Y	Z	Main Member	Secondary Member	Large	Large	II	III	Medium	Medium	III	IV	Small	Small	IV	IV	<p>Scalling/ Spalling * III</p> <p>Delamination III</p>	
Y	Z	Main Member	Secondary Member																																			
Large	Large	II	III																																			
Medium	Medium	III	IV																																			
Small	Small	IV	IV																																			
Y	Z	Main Member	Secondary Member																																			
Large	Large	II	III																																			
Medium	Medium	III	IV																																			
Small	Small	IV	IV																																			
		 <p>Efflorescence</p> <p>Z: less 1.0m2</p>	<p>Efflorescence</p>	<p>Efflorescence</p> <table border="1" style="font-size: small;"> <thead> <tr> <th>Z</th> <th>Main Member</th> <th>Secondary Member</th> </tr> </thead> <tbody> <tr> <td>Large</td> <td>II</td> <td>II</td> </tr> <tr> <td>Small</td> <td>IV</td> <td>IV</td> </tr> </tbody> </table> <p>Damage was observed, but rehabilitation is not needed. Follow-up inspection must be executed.</p>	Z	Main Member	Secondary Member	Large	II	II	Small	IV	IV	<p>III</p>																								
Z	Main Member	Secondary Member																																				
Large	II	II																																				
Small	IV	IV																																				

Bridge Component	Location of Damage	Damage	Evaluation of Damage	Damage Rank	Picture																																
A2 Abutment	<p>Cracking</p> <p>Cracking</p> <p>Efflorescence</p> <p>X: main part $0.3 > Y \geq 0.2\text{mm}$ Z: less 50cm Efflorescence Z: over 1.0m²</p>	Cracking	<p>Cracking</p> <table border="1"> <tr><th>X</th><th>Y</th><th>Z</th><th>Main Member</th><th>Secondary Member</th></tr> <tr><td>Large</td><td>Medium</td><td>Small</td><td>III</td><td>IV</td></tr> <tr><td>Medium</td><td>Large</td><td>Medium</td><td>IV</td><td>III</td></tr> <tr><td>Small</td><td>Small</td><td>Large</td><td>IV</td><td>III</td></tr> </table> <p>Damage was observed, but rehabilitation is not needed. Follow-up inspection must be executed.</p> <p>Efflorescence</p> <table border="1"> <tr><th>Z</th><th>Main Member</th><th>Secondary Member</th></tr> <tr><td>Large</td><td>III</td><td>IV</td></tr> <tr><td>Medium</td><td>IV</td><td>III</td></tr> <tr><td>Small</td><td>IV</td><td>III</td></tr> </table> <p>Damage was observed, but rehabilitation is not needed. Follow-up inspection must be executed.</p>	X	Y	Z	Main Member	Secondary Member	Large	Medium	Small	III	IV	Medium	Large	Medium	IV	III	Small	Small	Large	IV	III	Z	Main Member	Secondary Member	Large	III	IV	Medium	IV	III	Small	IV	III	Cracking III Efflorescence III	<p>Cracking Efflorescence</p>
	X	Y	Z	Main Member	Secondary Member																																
Large	Medium	Small	III	IV																																	
Medium	Large	Medium	IV	III																																	
Small	Small	Large	IV	III																																	
Z	Main Member	Secondary Member																																			
Large	III	IV																																			
Medium	IV	III																																			
Small	IV	III																																			
Pier	<p>Efflorescence</p> <p>Efflorescence</p> <p>Breakage</p> <p>Z: less 1.0m²</p> <p>Breakage</p> <p>Y: remarkable damage</p>	Efflorescence Breakage	<p>Efflorescence</p> <table border="1"> <tr><th>Z</th><th>Main Member</th><th>Secondary Member</th></tr> <tr><td>Large</td><td>III</td><td>IV</td></tr> <tr><td>Medium</td><td>IV</td><td>III</td></tr> <tr><td>Small</td><td>IV</td><td>III</td></tr> </table> <p>Damage was observed, but rehabilitation is not needed. Follow-up inspection must be executed.</p> <p>Breakage</p> <table border="1"> <tr><th>Y</th><th>Main Member</th><th>Secondary Member</th></tr> <tr><td>Large</td><td>III</td><td>IV</td></tr> <tr><td>Medium</td><td>IV</td><td>III</td></tr> <tr><td>Small</td><td>IV</td><td>III</td></tr> </table> <p>Degree of damage is large so that rehabilitation must be needed.</p>	Z	Main Member	Secondary Member	Large	III	IV	Medium	IV	III	Small	IV	III	Y	Main Member	Secondary Member	Large	III	IV	Medium	IV	III	Small	IV	III	Efflorescence III Breakage II	<p>Efflorescence</p>								
	Z	Main Member	Secondary Member																																		
Large	III	IV																																			
Medium	IV	III																																			
Small	IV	III																																			
Y	Main Member	Secondary Member																																			
Large	III	IV																																			
Medium	IV	III																																			
Small	IV	III																																			
Pier	<p>X: main part $Y \geq 0.3\text{mm}$ Z: less 50cm</p>	Cracking	<table border="1"> <tr><th>X</th><th>Y</th><th>Z</th><th>Main Member</th><th>Secondary Member</th></tr> <tr><td>Large</td><td>Medium</td><td>Small</td><td>III</td><td>IV</td></tr> <tr><td>Medium</td><td>Large</td><td>Medium</td><td>IV</td><td>III</td></tr> <tr><td>Small</td><td>Small</td><td>Large</td><td>IV</td><td>III</td></tr> </table> <p>Degree of damage is large so that rehabilitation must be needed.</p>	X	Y	Z	Main Member	Secondary Member	Large	Medium	Small	III	IV	Medium	Large	Medium	IV	III	Small	Small	Large	IV	III	II													
X	Y	Z	Main Member	Secondary Member																																	
Large	Medium	Small	III	IV																																	
Medium	Large	Medium	IV	III																																	
Small	Small	Large	IV	III																																	

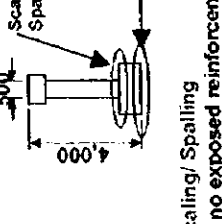
Bridge Component	Location of Damage	Damage	Evaluation of Damage	Damage Rank	Picture																																							
Pier	 <p>Cracking X: main part Y: $\leq 0.3\text{mm}$ Z: less 50cm Scaling/ Spalling Y: no exposed reinforcement bar, but deep Z: less 1.0m²</p>	Cracking Scaling/Spalling	<p>Cracking</p> <table border="1"> <thead> <tr> <th></th> <th>X</th> <th>Y</th> <th>Z</th> <th>Main Member</th> <th>Secondary Member</th> </tr> </thead> <tbody> <tr> <td>Large</td> <td></td> <td></td> <td></td> <td>II</td> <td>III</td> </tr> <tr> <td>Medium</td> <td></td> <td></td> <td></td> <td>III</td> <td>IV</td> </tr> <tr> <td>Small</td> <td></td> <td></td> <td></td> <td>IV</td> <td>IV</td> </tr> </tbody> </table> <p>Degree of damage was large so that rehabilitation must be needed.</p> <p>Scaling/ Spalling</p> <table border="1"> <thead> <tr> <th></th> <th>Y</th> <th>Z</th> <th>Main Member</th> <th>Secondary Member</th> </tr> </thead> <tbody> <tr> <td>Large</td> <td></td> <td></td> <td>II</td> <td>III</td> </tr> <tr> <td>Small</td> <td></td> <td></td> <td>IV</td> <td>IV</td> </tr> </tbody> </table> <p>Degree of damage was observed, the degree must be recorded.</p>		X	Y	Z	Main Member	Secondary Member	Large				II	III	Medium				III	IV	Small				IV	IV		Y	Z	Main Member	Secondary Member	Large			II	III	Small			IV	IV	Cracking II Scaling/ Spalling IV	
		X	Y	Z	Main Member	Secondary Member																																						
	Large				II	III																																						
Medium				III	IV																																							
Small				IV	IV																																							
	Y	Z	Main Member	Secondary Member																																								
Large			II	III																																								
Small			IV	IV																																								
 <p>Scaling/ Spalling Y: no exposed reinforcement bar Z: less 1.0m² Efflorescence Z: less 1.0m²</p>	Scaling/Spalling Efflorescence	<p>Scaling/ Spalling</p> <table border="1"> <thead> <tr> <th></th> <th>Y</th> <th>Z</th> <th>Main Member</th> <th>Secondary Member</th> </tr> </thead> <tbody> <tr> <td>Large</td> <td></td> <td></td> <td>II</td> <td>III</td> </tr> <tr> <td>Small</td> <td></td> <td></td> <td>IV</td> <td>IV</td> </tr> </tbody> </table> <p>Degree of damage was observed, the degree must be recorded.</p> <p>Efflorescence</p> <table border="1"> <thead> <tr> <th></th> <th>Z</th> <th>Main Member</th> <th>Secondary Member</th> </tr> </thead> <tbody> <tr> <td>Large</td> <td></td> <td>II</td> <td>III</td> </tr> <tr> <td>Small</td> <td></td> <td>IV</td> <td>IV</td> </tr> </tbody> </table> <p>Degree of damage was observed, but rehabilitation is not needed. Followup inspection must be executed.</p>		Y	Z	Main Member	Secondary Member	Large			II	III	Small			IV	IV		Z	Main Member	Secondary Member	Large		II	III	Small		IV	IV	Scaling/ Spalling IV Efflorescence III														
	Y	Z	Main Member	Secondary Member																																								
Large			II	III																																								
Small			IV	IV																																								
	Z	Main Member	Secondary Member																																									
Large		II	III																																									
Small		IV	IV																																									
 <p>Z: remarkable damage and exposed reinforcement bar</p>	Breakage	<table border="1"> <thead> <tr> <th></th> <th>Y</th> <th>All Members</th> </tr> </thead> <tbody> <tr> <td>Large</td> <td></td> <td>IV</td> </tr> <tr> <td>Small</td> <td></td> <td>IV</td> </tr> </tbody> </table> <p>Degree of damage is large so that rehabilitation must be needed.</p>		Y	All Members	Large		IV	Small		IV	II																																
	Y	All Members																																										
Large		IV																																										
Small		IV																																										

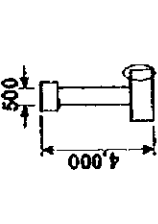
Bridge Component	Location of Damage	Damage	Evaluation of Damage	Damage Rank	Picture																
	 <p>Scaling/ Spalling Y: no exposed reinforcement bar Z: over 1.0m²</p> <p>Wear Y: no exposed reinforcement bar Z: over 1.0m²</p>	Scaling/Spalling Wear	<table border="1" data-bbox="327 918 422 1153"> <tr><th colspan="2">Scaling/ Spalling</th></tr> <tr><th>Y</th><th>Z</th></tr> <tr><td>Large</td><td>Large</td></tr> <tr><td>Small</td><td>Small</td></tr> </table> <p>Damage was observed, but rehabilitation is not needed. Follow-up inspection must be executed.</p> <table border="1" data-bbox="422 918 518 1153"> <tr><th colspan="2">Wear</th></tr> <tr><th>Y</th><th>Z</th></tr> <tr><td>Large</td><td>Large</td></tr> <tr><td>Small</td><td>Small</td></tr> </table> <p>Although damage rank is III, degree of damage is serious so that rehabilitation must be needed.</p>	Scaling/ Spalling		Y	Z	Large	Large	Small	Small	Wear		Y	Z	Large	Large	Small	Small	<p>Scaling /Spalling</p> <p>III</p> <p>Wear</p> <p>* III</p>	
Scaling/ Spalling																					
Y	Z																				
Large	Large																				
Small	Small																				
Wear																					
Y	Z																				
Large	Large																				
Small	Small																				
Pier Foundation	 <p>Z: remarkable damage and exposed reinforcement bar</p>	Breakage	<table border="1" data-bbox="678 918 805 1153"> <tr><th colspan="2">Breakage</th></tr> <tr><th>Y</th><th>Z</th></tr> <tr><td>Large</td><td>Large</td></tr> <tr><td>Small</td><td>Small</td></tr> </table> <p>Degree of damage is large so that rehabilitation must be needed.</p>	Breakage		Y	Z	Large	Large	Small	Small	II									
Breakage																					
Y	Z																				
Large	Large																				
Small	Small																				

(2) Steel Materials

Granallas

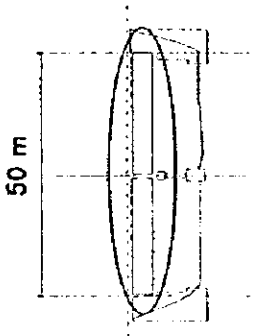
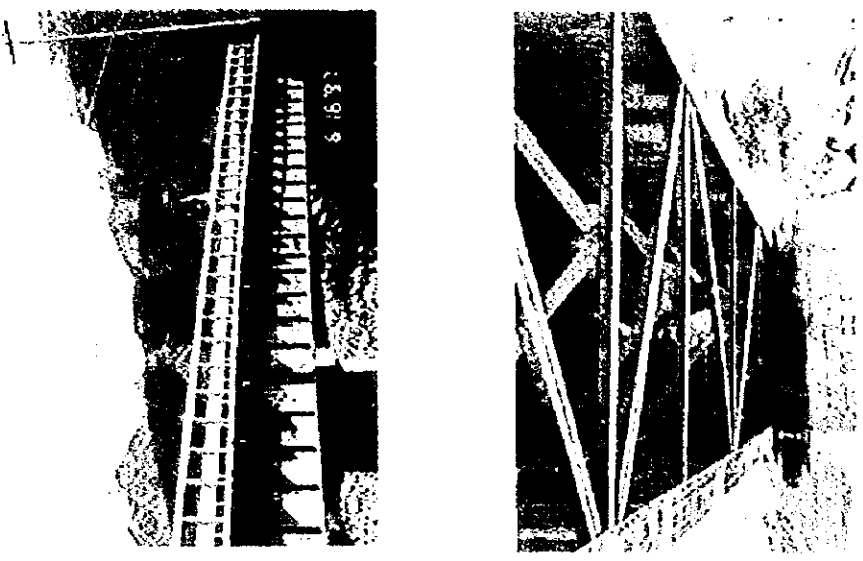
Bridge Component	Location of Damage	Damage	Evaluation of Damage	Damage Rank	Picture															
Beam	 <p>50 m</p>	Aging of Coat and Rusting	<table border="1" data-bbox="422 996 622 1321"> <tr> <td>Y</td> <td>Z</td> <td>All Members</td> </tr> <tr> <td>Large</td> <td>Large</td> <td>II</td> </tr> <tr> <td>Small</td> <td>Small</td> <td>II</td> </tr> <tr> <td>Small</td> <td>Large</td> <td>II</td> </tr> <tr> <td>Small</td> <td>Small</td> <td>III</td> </tr> </table> <p>Y : Means Depth Z : Means Width</p> <ul style="list-style-type: none"> • Must protect against rusting by coating. • Repairing Object is all in all. 	Y	Z	All Members	Large	Large	II	Small	Small	II	Small	Large	II	Small	Small	III	II	
Y	Z	All Members																		
Large	Large	II																		
Small	Small	II																		
Small	Large	II																		
Small	Small	III																		

(4) VENTANAS

BRIDGE NUMBER	YEAR OF BUILT	NOTE
BRIDGE NAME	BRIDGE LENGTH	
REGION	BRIDGE WIDTH	
ROUTE NAME	TRAFFIC VOLUME	

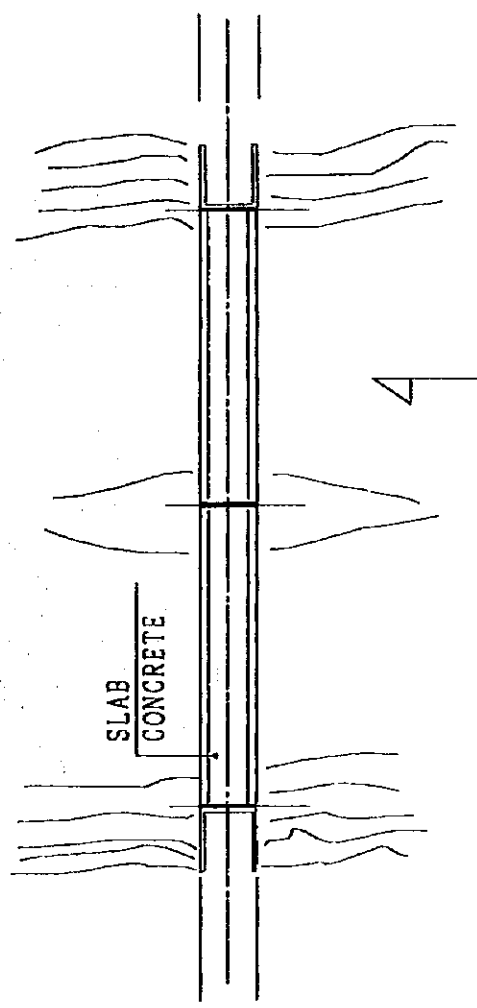
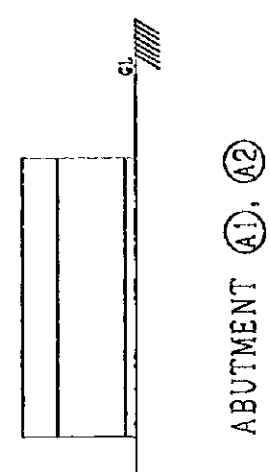
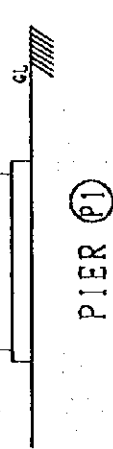
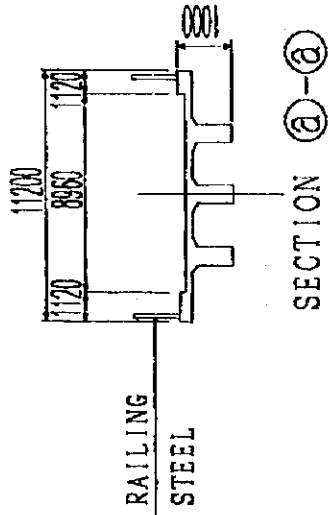
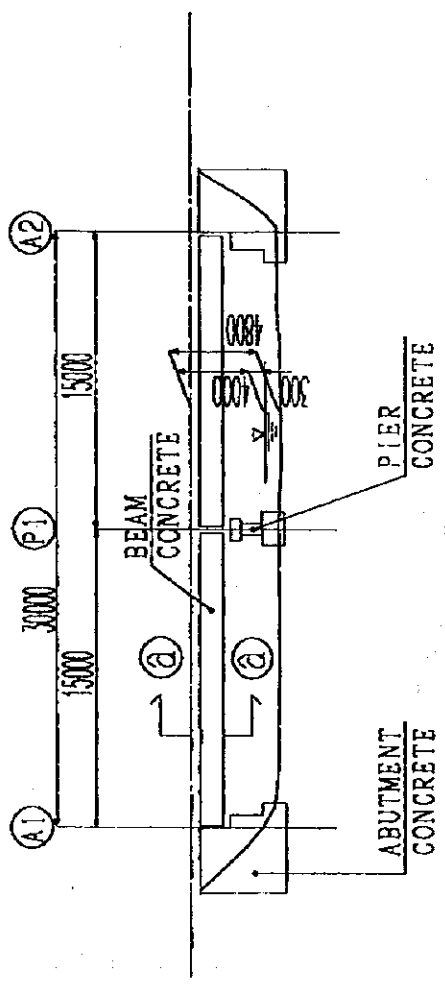

BRIDGE NO.7 BRIDGE NAME: VENTANAS





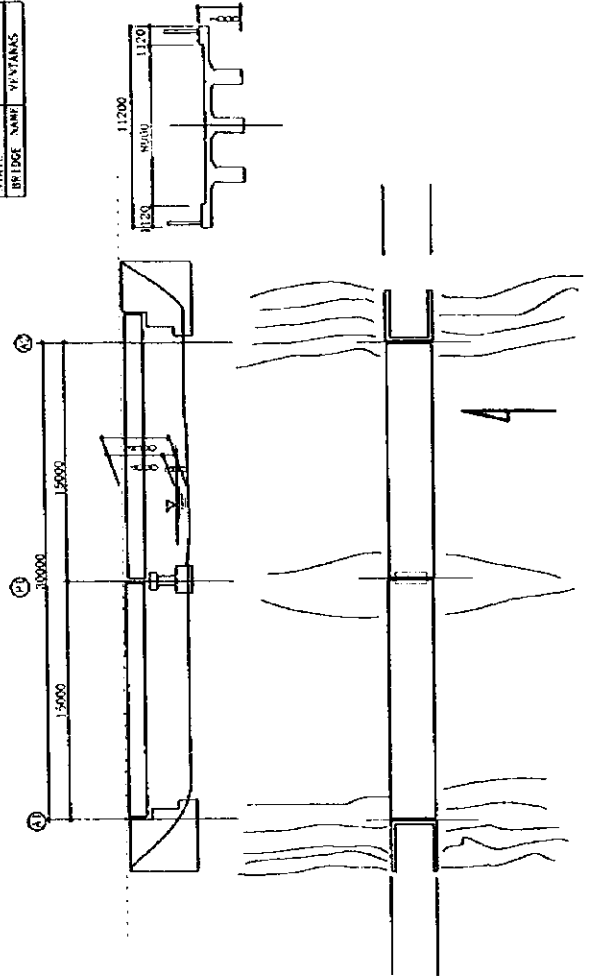



STATE	V
BRIDGE NAME	VENTANAS

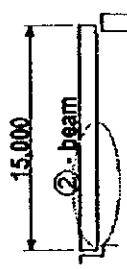

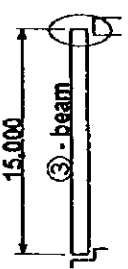

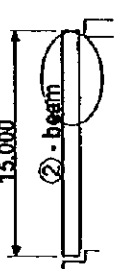

B. DAMAGE RANK AND DECISION ON REHABILITATION



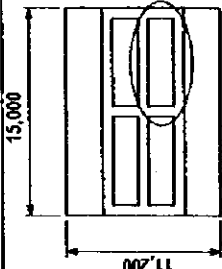
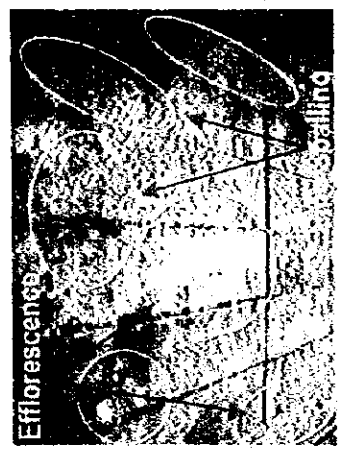
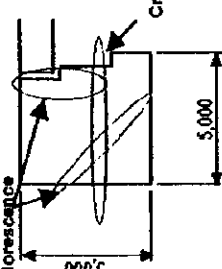
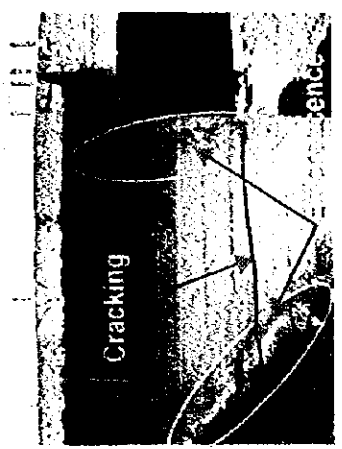
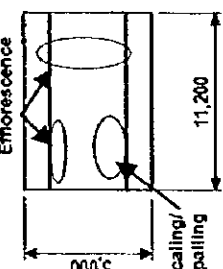
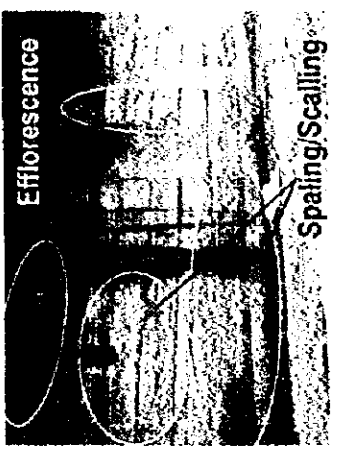

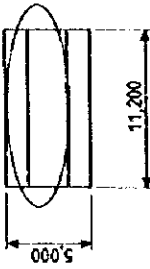
(1) Concrete Materials

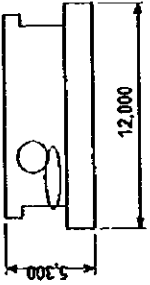

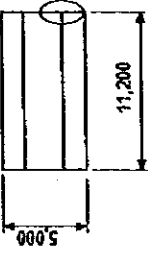
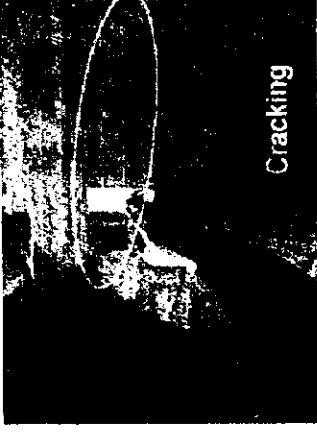
Bridge Component	Location of Damage	Damage	Evaluation of Damage	Damage Rank	Picture																				
Beam	 <p>① ② ③</p> <p>Y: no exposed reinforcement bar Z: over 0.1m²</p>	Scaling/Spalling	<table border="1" style="display: inline-table; margin-right: 10px;"> <tr> <td>Y</td> <td>Z</td> <td>Main Member</td> <td>Secondary Member</td> </tr> <tr> <td>Large</td> <td>Large</td> <td>II</td> <td>II</td> </tr> <tr> <td>Small</td> <td>Small</td> <td>II</td> <td>IV</td> </tr> <tr> <td>Large</td> <td>Small</td> <td>IV</td> <td>IV</td> </tr> <tr> <td>Small</td> <td>Large</td> <td>IV</td> <td>IV</td> </tr> </table> <p>Damage was observed, but rehabilitation is not needed. Follow-up inspection must be executed.</p>	Y	Z	Main Member	Secondary Member	Large	Large	II	II	Small	Small	II	IV	Large	Small	IV	IV	Small	Large	IV	IV	III	 <p style="text-align: center;">Scaling/Spalling</p>
	Y	Z	Main Member	Secondary Member																					
Large	Large	II	II																						
Small	Small	II	IV																						
Large	Small	IV	IV																						
Small	Large	IV	IV																						
	 <p>① ② ③</p> <p>Z: over 0.1m²</p>	Efflorescence	<table border="1" style="display: inline-table; margin-right: 10px;"> <tr> <td>Z</td> <td>Main Member</td> <td>Secondary Member</td> </tr> <tr> <td>Large</td> <td>III</td> <td>II</td> </tr> <tr> <td>Small</td> <td>III</td> <td>IV</td> </tr> </table> <p>Degree of damage is large so that rehabilitation must be needed.</p>	Z	Main Member	Secondary Member	Large	III	II	Small	III	IV	II	 <p style="text-align: center;">Efflorescence</p>											
Z	Main Member	Secondary Member																							
Large	III	II																							
Small	III	IV																							
	 <p>① ② ③</p> <p>Z: over 0.1m²</p>	Efflorescence	<table border="1" style="display: inline-table; margin-right: 10px;"> <tr> <td>Z</td> <td>Main Member</td> <td>Secondary Member</td> </tr> <tr> <td>Large</td> <td>III</td> <td>II</td> </tr> <tr> <td>Small</td> <td>III</td> <td>IV</td> </tr> </table> <p>Degree of damage is large so that rehabilitation must be needed.</p>	Z	Main Member	Secondary Member	Large	III	II	Small	III	IV	II												
Z	Main Member	Secondary Member																							
Large	III	II																							
Small	III	IV																							

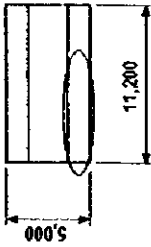

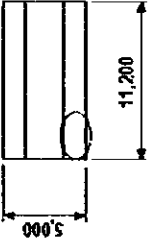
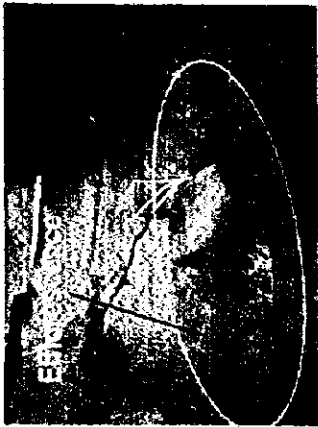
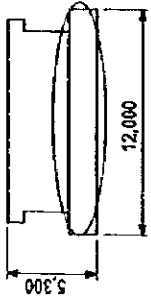
Bridge Component	Location of Damage	Damage	Evaluation of Damage	Damage Rank	Picture												
Beam	<p>15,000</p> <p>① - beam</p> <p>Y: no exposed reinforcement bar Z: over 0.1m²</p>	Honeycombs	<table border="1"> <tr> <th>Y</th> <th>Z</th> <th>Main Member</th> <th>Secondary Member</th> </tr> <tr> <td>Large</td> <td>Small</td> <td>II</td> <td>II</td> </tr> <tr> <td>Small</td> <td>Small</td> <td>IV</td> <td>IV</td> </tr> </table> <p>Damage was observed, but rehabilitation is not needed. Follow-up inspection must be executed.</p>	Y	Z	Main Member	Secondary Member	Large	Small	II	II	Small	Small	IV	IV	III	
	Y	Z	Main Member	Secondary Member													
Large	Small	II	II														
Small	Small	IV	IV														
	<p>15,000</p> <p>② - beam</p> <p>Y: remarkable damage</p>	Breakage	<table border="1"> <tr> <th>Y</th> <th>All Members</th> </tr> <tr> <td>Large</td> <td></td> </tr> <tr> <td>Small</td> <td>IV</td> </tr> </table> <p>Degree of Damage is large so that rehabilitation must be needed.</p>	Y	All Members	Large		Small	IV	II							
Y	All Members																
Large																	
Small	IV																
Slab	<p>15,000</p> <p>Y: no exposed reinforcement bar Z: over 0.1m²</p>	Scaling/Spalling	<table border="1"> <tr> <th>Y</th> <th>Z</th> <th>Main Member</th> <th>Secondary Member</th> </tr> <tr> <td>Large</td> <td>Small</td> <td>II</td> <td>II</td> </tr> <tr> <td>Small</td> <td>Small</td> <td>IV</td> <td>IV</td> </tr> </table> <p>Damage was observed, but rehabilitation is not needed. Follow-up inspection must be executed.</p>	Y	Z	Main Member	Secondary Member	Large	Small	II	II	Small	Small	IV	IV	III	
Y	Z	Main Member	Secondary Member														
Large	Small	II	II														
Small	Small	IV	IV														

Bridge Component	Location of Damage	Damage	Evaluation of Damage	Damage Rank	Picture																																		
Slab	 <p>Scaling/Spalling Efflorescence Y: no exposed reinforcement bar, but deep Z: over 0.1m²</p>	Scaling/Spalling Efflorescence	<p>Scaling/Spalling</p> <table border="1"> <tr><td>Y</td><td>Z</td><td>Main Member</td><td>Secondary Member</td></tr> <tr><td>Large</td><td>Small</td><td>II</td><td>IV</td></tr> <tr><td>Large</td><td>Small</td><td>II</td><td>IV</td></tr> <tr><td>Small</td><td>Small</td><td>IV</td><td>IV</td></tr> </table> <p>Degree of damage is large (deep) so that rehabilitation must be executed.</p> <p>Efflorescence</p> <table border="1"> <tr><td>Z</td><td>Main Member</td><td>Secondary Member</td></tr> <tr><td>Large</td><td>II</td><td>II</td></tr> <tr><td>Small</td><td>II</td><td>IV</td></tr> </table> <p>Damage was observed, but rehabilitation is not needed. Follow-up inspection must be executed.</p>	Y	Z	Main Member	Secondary Member	Large	Small	II	IV	Large	Small	II	IV	Small	Small	IV	IV	Z	Main Member	Secondary Member	Large	II	II	Small	II	IV	Scaling/Spalling II Efflorescence III										
	Y	Z	Main Member	Secondary Member																																			
Large	Small	II	IV																																				
Large	Small	II	IV																																				
Small	Small	IV	IV																																				
Z	Main Member	Secondary Member																																					
Large	II	II																																					
Small	II	IV																																					
A1 Abutment	 <p>Cracking Efflorescence X: main part Y: over 0.3mm Z: over 50cm</p>	Cracking Efflorescence	<p>Cracking</p> <table border="1"> <tr><td>X</td><td>Y</td><td>Z</td><td>Main Member</td><td>Secondary Member</td></tr> <tr><td>Large</td><td>Large</td><td>Small</td><td>II</td><td>II</td></tr> <tr><td>Large</td><td>Medium</td><td>Small</td><td>II</td><td>IV</td></tr> <tr><td>Small</td><td>Large</td><td>Small</td><td>V</td><td>V</td></tr> <tr><td></td><td>Large</td><td>Small</td><td>V</td><td>V</td></tr> </table> <p>Degree of damage is large so that rehabilitation must be executed.</p> <p>Efflorescence</p> <table border="1"> <tr><td>Z</td><td>Main Member</td><td>Secondary Member</td></tr> <tr><td>Large</td><td>II</td><td>II</td></tr> <tr><td>Small</td><td>II</td><td>IV</td></tr> </table> <p>Damage was observed, but rehabilitation is not needed. Follow-up inspection must be executed.</p>	X	Y	Z	Main Member	Secondary Member	Large	Large	Small	II	II	Large	Medium	Small	II	IV	Small	Large	Small	V	V		Large	Small	V	V	Z	Main Member	Secondary Member	Large	II	II	Small	II	IV	Cracking II Efflorescence III	
	X	Y	Z	Main Member	Secondary Member																																		
Large	Large	Small	II	II																																			
Large	Medium	Small	II	IV																																			
Small	Large	Small	V	V																																			
	Large	Small	V	V																																			
Z	Main Member	Secondary Member																																					
Large	II	II																																					
Small	II	IV																																					
A1 Abutment	 <p>Scaling/Spalling Efflorescence Y: no exposed reinforcement bar, but deep Z: over 1.0m²</p>	Scaling/Spalling Efflorescence	<p>Scaling/Spalling</p> <table border="1"> <tr><td>Y</td><td>Z</td><td>Main Member</td><td>Secondary Member</td></tr> <tr><td>Large</td><td>Small</td><td>II</td><td>IV</td></tr> <tr><td>Large</td><td>Small</td><td>II</td><td>IV</td></tr> <tr><td>Small</td><td>Small</td><td>IV</td><td>IV</td></tr> </table> <p>Degree of damage is large (deep) so that rehabilitation must be executed.</p> <p>Efflorescence</p> <table border="1"> <tr><td>Z</td><td>Main Member</td><td>Secondary Member</td></tr> <tr><td>Large</td><td>II</td><td>II</td></tr> <tr><td>Small</td><td>II</td><td>IV</td></tr> </table> <p>Damage was observed, but rehabilitation is not needed. Follow-up inspection must be executed.</p>	Y	Z	Main Member	Secondary Member	Large	Small	II	IV	Large	Small	II	IV	Small	Small	IV	IV	Z	Main Member	Secondary Member	Large	II	II	Small	II	IV	Scaling/Spalling II Efflorescence III										
	Y	Z	Main Member	Secondary Member																																			
Large	Small	II	IV																																				
Large	Small	II	IV																																				
Small	Small	IV	IV																																				
Z	Main Member	Secondary Member																																					
Large	II	II																																					
Small	II	IV																																					

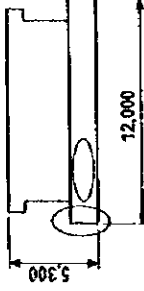
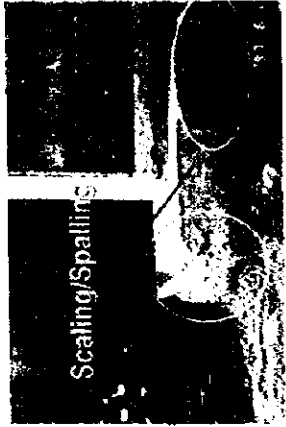
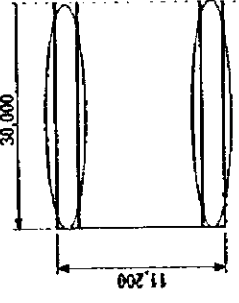
Bridge Component	Location of Damage	Damage	Evaluation of Damage	Damage Rank	Picture															
A2 Abutment	 <p>Y: no exposed reinforcement bar Z: over 1.0m²</p>	Scaling/Spalling Honeycombs	<table border="1" data-bbox="284 907 422 1160"> <thead> <tr> <th>Y</th> <th>Z</th> <th>Main Member</th> <th>Secondary Member</th> </tr> </thead> <tbody> <tr> <td>Large</td> <td>Large</td> <td>III</td> <td>II</td> </tr> <tr> <td>Small</td> <td>Small</td> <td>IV</td> <td>IV</td> </tr> </tbody> </table> <p>Damage was observed, but rehabilitation is not needed. Follow-up inspection must be executed.</p>	Y	Z	Main Member	Secondary Member	Large	Large	III	II	Small	Small	IV	IV	III				
Y	Z	Main Member	Secondary Member																	
Large	Large	III	II																	
Small	Small	IV	IV																	
Pier	 <p>Y: no exposed reinforcement bar, but deep Z: less 1.0m²</p>	Scaling/Spalling	<table border="1" data-bbox="651 907 790 1160"> <thead> <tr> <th>Y</th> <th>Z</th> <th>Main Member</th> <th>Secondary Member</th> </tr> </thead> <tbody> <tr> <td>Large</td> <td>Large</td> <td>II</td> <td>IV</td> </tr> <tr> <td>Small</td> <td>Small</td> <td>IV</td> <td>IV</td> </tr> </tbody> </table> <p>Although exposed reinforcement bar is not observed, the damage is large(wide) so that rehabilitation must be executed.</p>	Y	Z	Main Member	Secondary Member	Large	Large	II	IV	Small	Small	IV	IV	II				
Y	Z	Main Member	Secondary Member																	
Large	Large	II	IV																	
Small	Small	IV	IV																	
A1 Abutment Foundation	 <p>X: main part Y: over 0.3mm Z: less 50cm</p>	Cracking	<table border="1" data-bbox="1002 907 1157 1160"> <thead> <tr> <th>X</th> <th>Y</th> <th>Z</th> <th>Main Member</th> <th>Secondary Member</th> </tr> </thead> <tbody> <tr> <td>Large</td> <td>Large</td> <td>Large</td> <td>II</td> <td>II</td> </tr> <tr> <td>Small</td> <td>Small</td> <td>Small</td> <td>IV</td> <td>IV</td> </tr> </tbody> </table> <p>Degree of damage was large (deep) so that rehabilitation must be executed.</p>	X	Y	Z	Main Member	Secondary Member	Large	Large	Large	II	II	Small	Small	Small	IV	IV	II	
X	Y	Z	Main Member	Secondary Member																
Large	Large	Large	II	II																
Small	Small	Small	IV	IV																

Bridge Component	Location of Damage	Damage	Evaluation of Damage	Damage Rank	Picture												
A1 Abutment Foundation	 <p>Y: no exposed reinforcement bar Z: over 1.0m²</p>	Scaling/Spalling	<table border="1" data-bbox="359 896 502 1153"> <thead> <tr> <th>Y</th> <th>Z</th> <th>Main Member</th> <th>Secondary Member</th> </tr> </thead> <tbody> <tr> <td>Large</td> <td>Small</td> <td>II</td> <td>IV</td> </tr> <tr> <td>Small</td> <td>Large</td> <td>IV</td> <td>IV</td> </tr> </tbody> </table> <p>Damage was observed, but rehabilitation is not needed. Follow-up inspection must be executed.</p>	Y	Z	Main Member	Secondary Member	Large	Small	II	IV	Small	Large	IV	IV	III	
	Y	Z	Main Member	Secondary Member													
Large	Small	II	IV														
Small	Large	IV	IV														
	 <p>Z: less 1.0m²</p>	Efflorescence	<table border="1" data-bbox="726 896 837 1153"> <thead> <tr> <th>Z</th> <th>Main Member</th> <th>Secondary Member</th> </tr> </thead> <tbody> <tr> <td>Large</td> <td>II</td> <td>II</td> </tr> <tr> <td>Small</td> <td>IV</td> <td>IV</td> </tr> </tbody> </table> <p>Damage is observed, but rehabilitation is not needed. Follow-up inspection must be executed.</p>	Z	Main Member	Secondary Member	Large	II	II	Small	IV	IV	III				
Z	Main Member	Secondary Member															
Large	II	II															
Small	IV	IV															
Pier Foundation	 <p>Y: no exposed reinforcement bar Z: over 1.0m²</p>	Honeycombs	<table border="1" data-bbox="1077 896 1220 1153"> <thead> <tr> <th>Y</th> <th>Z</th> <th>Main Member</th> <th>Secondary Member</th> </tr> </thead> <tbody> <tr> <td>Large</td> <td>Small</td> <td>II</td> <td>IV</td> </tr> <tr> <td>Small</td> <td>Large</td> <td>IV</td> <td>IV</td> </tr> </tbody> </table> <p>Damage was observed, but rehabilitation is not needed. Follow-up inspection must be executed.</p>	Y	Z	Main Member	Secondary Member	Large	Small	II	IV	Small	Large	IV	IV	III	
Y	Z	Main Member	Secondary Member														
Large	Small	II	IV														
Small	Large	IV	IV														

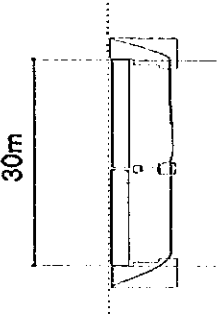
Bridge Component	Location of Damage	Damage	Evaluation of Damage	Damage Rank	Picture																
Pier Foundation	 <p>Y: no exposed reinforcement bar, but deep Z: less 1.0m²</p>	Scaling/Spalling	<table border="1" data-bbox="327 907 470 1153"> <thead> <tr> <th>Y</th> <th>Z</th> <th>Main Member</th> <th>Secondary Member</th> </tr> </thead> <tbody> <tr> <td>Large</td> <td>Small</td> <td>E</td> <td>II</td> </tr> <tr> <td>Large</td> <td>Large</td> <td>III</td> <td>IV</td> </tr> <tr> <td>Small</td> <td>Small</td> <td>IV</td> <td>IV</td> </tr> </tbody> </table> <p>Although exposed reinforcement bar was not observed, the damage is large(deep) so that rehabilitation must be executed.</p>	Y	Z	Main Member	Secondary Member	Large	Small	E	II	Large	Large	III	IV	Small	Small	IV	IV	II	
Y	Z	Main Member	Secondary Member																		
Large	Small	E	II																		
Large	Large	III	IV																		
Small	Small	IV	IV																		
Side Walk (Foot Way)	 <p>Y: no exposed reinforcement bar Z: over 1.0m²</p>	Scaling/Spalling	<table border="1" data-bbox="694 907 837 1153"> <thead> <tr> <th>Y</th> <th>Z</th> <th>Main Member</th> <th>Secondary Member</th> </tr> </thead> <tbody> <tr> <td>Large</td> <td>Small</td> <td>E</td> <td>II</td> </tr> <tr> <td>Large</td> <td>Large</td> <td>III</td> <td>IV</td> </tr> <tr> <td>Small</td> <td>Small</td> <td>IV</td> <td>IV</td> </tr> </tbody> </table> <p>Damage was observed, but rehabilitation is not needed. Follow-up inspection must be executed.</p>	Y	Z	Main Member	Secondary Member	Large	Small	E	II	Large	Large	III	IV	Small	Small	IV	IV	III	
Y	Z	Main Member	Secondary Member																		
Large	Small	E	II																		
Large	Large	III	IV																		
Small	Small	IV	IV																		

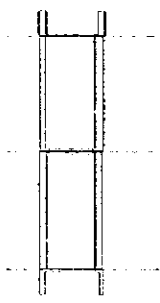
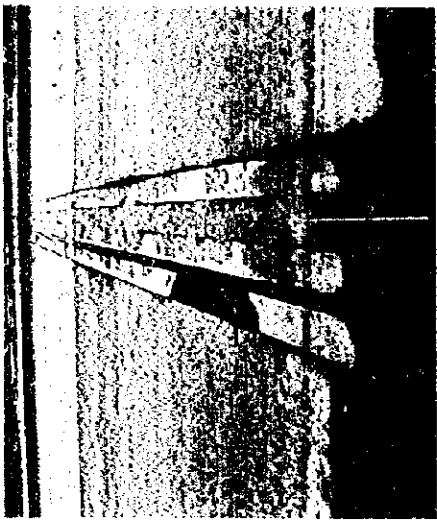
(2) Steel Materials		Ventanas		Picture																
Bridge Component	Location of Damage	Damage	Evaluation of Damage																	
Railing	 <p>30m</p>	Rusting Aging of Coat	<table border="1"> <tr> <td>Y</td> <td>Z</td> <td>Sub Members</td> </tr> <tr> <td>Large</td> <td>Large</td> <td>II</td> </tr> <tr> <td>Small</td> <td>Small</td> <td>III</td> </tr> <tr> <td>Small</td> <td>Large</td> <td>IV</td> </tr> <tr> <td>Small</td> <td>Small</td> <td>IV</td> </tr> </table> <p>Y : Means Depth Z : Means Width</p> <p>Must protect against rusting by coating.</p>	Y	Z	Sub Members	Large	Large	II	Small	Small	III	Small	Large	IV	Small	Small	IV	III	
Y	Z	Sub Members																		
Large	Large	II																		
Small	Small	III																		
Small	Large	IV																		
Small	Small	IV																		
Expansion Joint		Breakage	<table border="1"> <tr> <td>Y</td> <td>All Members</td> </tr> <tr> <td>Large</td> <td>II</td> </tr> </table> <p>Y : Means Depth Must replace.</p>	Y	All Members	Large	II	II												
Y	All Members																			
Large	II																			

(5) SAN JOSE

BRIDGE NUMBER		YEAR OF BUILT	
BRIDGE NAME	SAN JOSE	BRIDGE LENGTH	16.10m
REGION	RM	BRIDGE WIDTH	6.00m
ROUTE NAME	G-155	TRAFFIC VOLUME	3900PASS/DAY (1994)

NOTE The oldest bridge among the bridges inspected. The 16 meter long concrete bridge is of a so-called half-through type, and is heavily deteriorated. The importance of the bridge is raised more by the collapse of other nearby bridges caused by the flood soon after the inspection by JICA team.

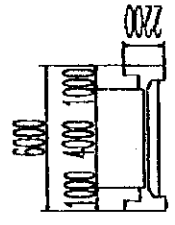
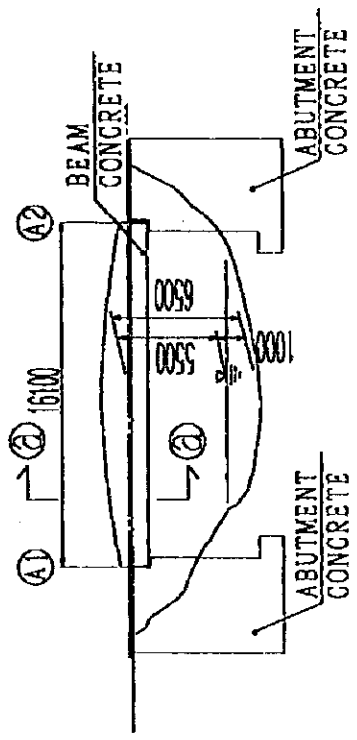

SECTION A1-A2

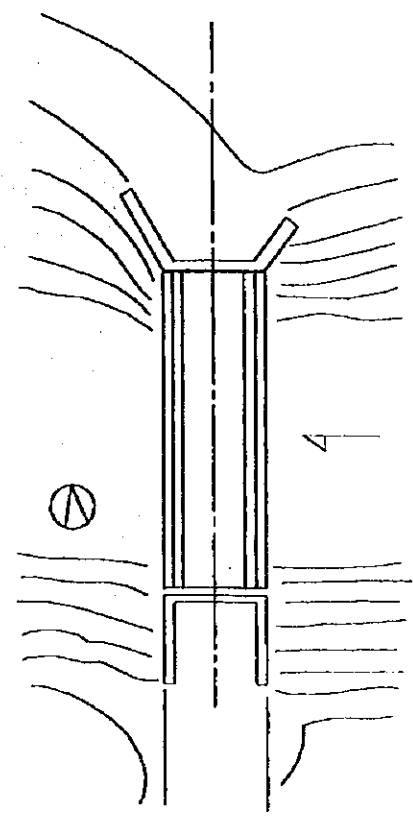

ABUTMENT A1, A2

BRIDGE NO.10 BRIDGE NAME: SAN JOSE





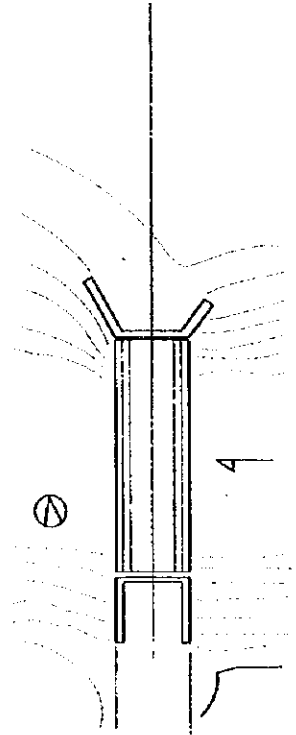
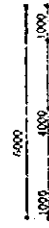
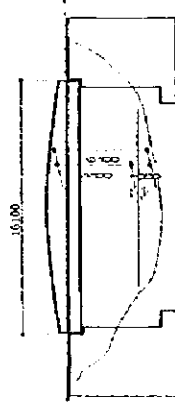

STATE	RM
BRIDGE	SAN JOSE



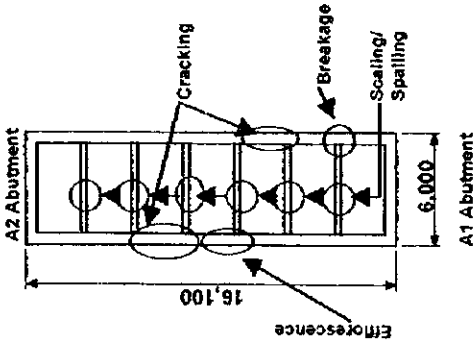
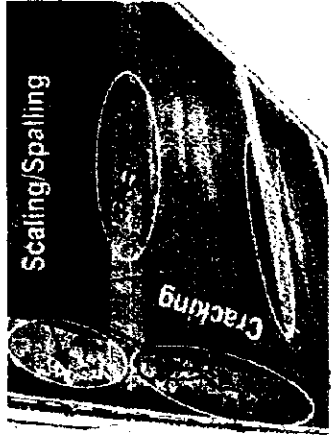

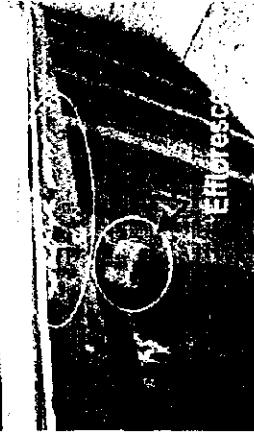
B. DAMAGE RANK AND DECISION ON REHABILITATION

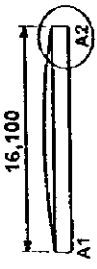
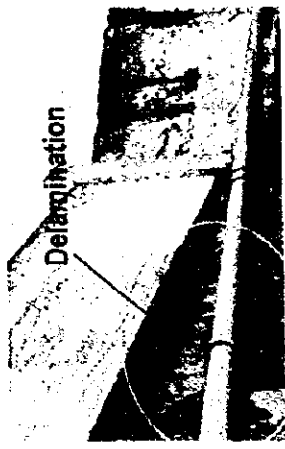
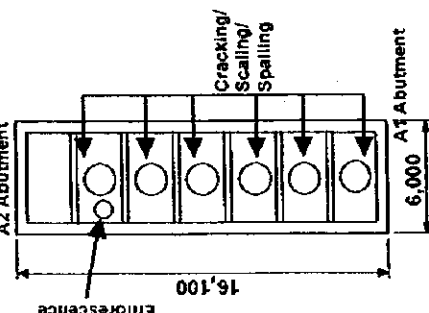
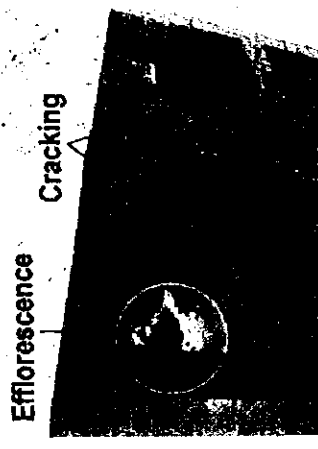
(1) Concrete Materials

Bridge Component	Location of Damage	Damage	Evaluation of Damage	Damage Rank	Picture																								
Beam	 <p>Cracking X: main part 0.3 > Y \geq 0.2mm Z: less 50cm</p> <p>Scaling/ Spalling Y: no exposed reinforcement bar Z: over 0.1m²</p> <p>Breakage Y: remarkable damage</p> <p>Efflorescence Z: over 0.1m²</p>	Cracking Scaling/Spalling	<p>Cracking</p> <table border="1"> <tr> <th>Crack</th> <th>Width</th> <th>Depth</th> <th>Length</th> <th>Number</th> <th>Remarks</th> </tr> <tr> <td> </td> <td> </td> <td> </td> <td> </td> <td> </td> <td> </td> </tr> </table> <p>Although damage rank is III, cracking is caused on important member, so that rehabilitation must be needed.</p> <p>Scaling/ Spalling</p> <table border="1"> <tr> <th>Y</th> <th>Z</th> <th>Member</th> <th>Secondary Member</th> </tr> <tr> <td>Large (Small)</td> <td> </td> <td> </td> <td> </td> </tr> <tr> <td>Small (Small)</td> <td> </td> <td> </td> <td> </td> </tr> </table> <p>Damage was observed, but rehabilitation is not needed. Follow-up inspection must be executed.</p>	Crack	Width	Depth	Length	Number	Remarks							Y	Z	Member	Secondary Member	Large (Small)				Small (Small)				Cracking III*	 <p>Cracking Scaling/Spalling</p>
		Crack	Width	Depth	Length	Number	Remarks																						
Y	Z	Member	Secondary Member																										
Large (Small)																													
Small (Small)																													
Breakage	<table border="1"> <tr> <th>Y</th> <th>All Members</th> </tr> <tr> <td>Large</td> <td> </td> </tr> <tr> <td>Small</td> <td> </td> </tr> <tr> <td> </td> <td>IV</td> </tr> </table> <p>Degree of damage is large so that rehabilitation must be needed.</p>	Y	All Members	Large		Small			IV	II	 <p>Breakage</p>																		
Y	All Members																												
Large																													
Small																													
	IV																												
Efflorescence	<table border="1"> <tr> <th>Z</th> <th>Main Member</th> <th>Secondary Member</th> </tr> <tr> <td>Large</td> <td> </td> <td> </td> </tr> <tr> <td>Small</td> <td> </td> <td> </td> </tr> <tr> <td> </td> <td>III</td> <td>IV</td> </tr> </table> <p>Degree of damage is large so that rehabilitation must be needed.</p>	Z	Main Member	Secondary Member	Large			Small				III	IV	II	 <p>Efflorescence</p>														
Z	Main Member	Secondary Member																											
Large																													
Small																													
	III	IV																											

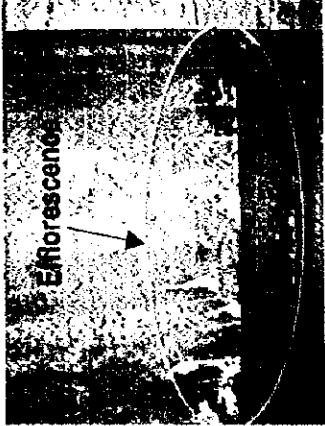
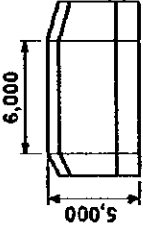
Bridge Component	Location of Damage	Damage	Evaluation of Damage	Damage Rank	Picture																								
Beam	 <p>Y: no exposed reinforcement bar but deep Z: over 0.1m²</p>	Delamination	<table border="1"> <thead> <tr> <th>Y</th> <th>Z</th> <th>Main Member</th> <th>Secondary Member</th> </tr> </thead> <tbody> <tr> <td>Large</td> <td>Small</td> <td>II</td> <td>II</td> </tr> <tr> <td>Small</td> <td>Small</td> <td>IV</td> <td>IV</td> </tr> </tbody> </table> <p>Although damage rank is III, degree of damage is serious so that rehabilitation must be needed.</p>	Y	Z	Main Member	Secondary Member	Large	Small	II	II	Small	Small	IV	IV	III*													
Y	Z	Main Member	Secondary Member																										
Large	Small	II	II																										
Small	Small	IV	IV																										
Slab	 <p>Cracking X: main part 0.3 > Y ≥ 0.2mm Z: less 50cm</p> <p>Efflorescence Z: over 0.1m²</p> <p>Scaling/ Spalling Y: no exposed reinforcement bar but excessive Z: over 0.1m²</p>	Cracking Efflorescence	<p>Cracking</p> <table border="1"> <thead> <tr> <th>X</th> <th>Y</th> <th>Z</th> <th>Main Member</th> <th>Secondary Member</th> </tr> </thead> <tbody> <tr> <td>Large</td> <td>Small</td> <td>Small</td> <td>II</td> <td>II</td> </tr> <tr> <td>Small</td> <td>Small</td> <td>Small</td> <td>IV</td> <td>IV</td> </tr> </tbody> </table> <p>Degree of Damage is large so that rehabilitation must be needed.</p> <p>Efflorescence</p> <table border="1"> <thead> <tr> <th>Z</th> <th>Main Member</th> <th>Secondary Member</th> </tr> </thead> <tbody> <tr> <td>Large</td> <td>II</td> <td>II</td> </tr> <tr> <td>Small</td> <td>IV</td> <td>IV</td> </tr> </tbody> </table> <p>Degree of Damage is large so that rehabilitation must be needed.</p>	X	Y	Z	Main Member	Secondary Member	Large	Small	Small	II	II	Small	Small	Small	IV	IV	Z	Main Member	Secondary Member	Large	II	II	Small	IV	IV	Cracking II Efflorescence II	
		X	Y	Z	Main Member	Secondary Member																							
Large	Small	Small	II	II																									
Small	Small	Small	IV	IV																									
Z	Main Member	Secondary Member																											
Large	II	II																											
Small	IV	IV																											
		Scaling/Spalling	<p>Scaling/ Spalling</p> <table border="1"> <thead> <tr> <th>Y</th> <th>Z</th> <th>Main Member</th> <th>Secondary Member</th> </tr> </thead> <tbody> <tr> <td>Large</td> <td>Small</td> <td>II</td> <td>II</td> </tr> <tr> <td>Small</td> <td>Small</td> <td>IV</td> <td>IV</td> </tr> </tbody> </table> <p>Damage was observed, but rehabilitation is not needed. Follow-up inspection must be needed.</p>	Y	Z	Main Member	Secondary Member	Large	Small	II	II	Small	Small	IV	IV	III													
Y	Z	Main Member	Secondary Member																										
Large	Small	II	II																										
Small	Small	IV	IV																										

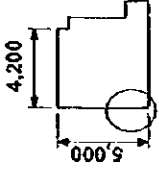
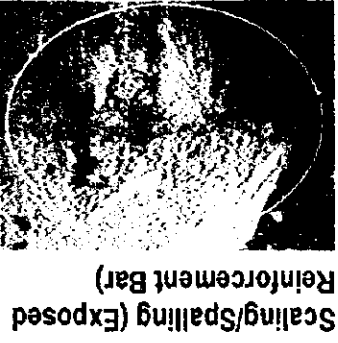
Bridge Component	Location of Damage	Damage	Evaluation of Damage	Damage Rank	Picture																
Slab	See front page Efflorescence Z: over 0.1m ²	Efflorescence	<table border="1"> <tr> <td>Z</td> <td>Main Member</td> <td>Secondary Member</td> </tr> <tr> <td>Large</td> <td>III</td> <td>II</td> </tr> <tr> <td>Small</td> <td>III</td> <td>IV</td> </tr> </table> <p>Degree of damage is large so that rehabilitation must be needed.</p>	Z	Main Member	Secondary Member	Large	III	II	Small	III	IV	II								
Z	Main Member	Secondary Member																			
Large	III	II																			
Small	III	IV																			
A1 Abutment		Scaling/Spalling Efflorescence Honeycombs		No Rank																	
A2 Abutment	 Scaling/ Spalling Y: exposed reinforcement bar Z: less 1.0m ²	Scaling/Spalling	<table border="1"> <tr> <td>Y</td> <td>Z</td> <td>Main Member</td> <td>Secondary Member</td> </tr> <tr> <td>Large</td> <td>Large</td> <td>II</td> <td>II</td> </tr> <tr> <td>Small</td> <td>Small</td> <td>III</td> <td>IV</td> </tr> <tr> <td></td> <td></td> <td>IV</td> <td>IV</td> </tr> </table> <p>Degree of damage is large (exposed reinforcement bar) so that rehabilitation must be needed.</p>	Y	Z	Main Member	Secondary Member	Large	Large	II	II	Small	Small	III	IV			IV	IV	II	
Y	Z	Main Member	Secondary Member																		
Large	Large	II	II																		
Small	Small	III	IV																		
		IV	IV																		

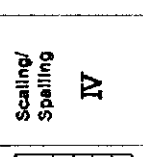
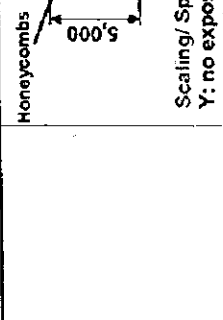
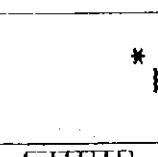
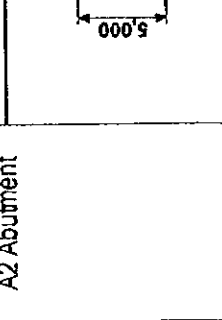
Bridge Component	Location of Damage	Damage	Evaluation of Damage	Damage Link	Picture																																								
A2 Abutment	<p>Honeycombs</p>  <p>Scaling/ Spalling Y: no exposed reinforcement bar Z: less 1.0m2</p>	<p>Scaling/Spalling Honeycombs</p>	<p>Scaling/ Spalling</p> <table border="1" data-bbox="319 1153 454 1422"> <thead> <tr> <th>Y</th> <th>Z</th> <th>Main Member</th> <th>Secondary Member</th> </tr> </thead> <tbody> <tr> <td>Large</td> <td>Large</td> <td>II</td> <td>II</td> </tr> <tr> <td>Small</td> <td>Small</td> <td>IV</td> <td>IV</td> </tr> <tr> <td>Large</td> <td>Small</td> <td>III</td> <td>IV</td> </tr> <tr> <td>Small</td> <td>Large</td> <td>IV</td> <td>III</td> </tr> </tbody> </table> <p>Damage was observed, the degree must be recorded.</p> <p>Honeycombs</p> <table border="1" data-bbox="454 1153 590 1422"> <thead> <tr> <th>Y</th> <th>Z</th> <th>Main Member</th> <th>Secondary Member</th> </tr> </thead> <tbody> <tr> <td>Large</td> <td>Large</td> <td>II</td> <td>II</td> </tr> <tr> <td>Small</td> <td>Small</td> <td>IV</td> <td>IV</td> </tr> <tr> <td>Large</td> <td>Small</td> <td>III</td> <td>IV</td> </tr> <tr> <td>Small</td> <td>Large</td> <td>IV</td> <td>III</td> </tr> </tbody> </table> <p>Damage was observed, the degree must be recorded.</p>	Y	Z	Main Member	Secondary Member	Large	Large	II	II	Small	Small	IV	IV	Large	Small	III	IV	Small	Large	IV	III	Y	Z	Main Member	Secondary Member	Large	Large	II	II	Small	Small	IV	IV	Large	Small	III	IV	Small	Large	IV	III	<p>Scaling/ Spalling IV</p> <p>Honeycombs IV</p>	
	Y	Z	Main Member	Secondary Member																																									
Large	Large	II	II																																										
Small	Small	IV	IV																																										
Large	Small	III	IV																																										
Small	Large	IV	III																																										
Y	Z	Main Member	Secondary Member																																										
Large	Large	II	II																																										
Small	Small	IV	IV																																										
Large	Small	III	IV																																										
Small	Large	IV	III																																										
 <p>X: main part 0.3 > Y ≥ 0.2mm Z: less 50cm</p>	<p>Cracking</p>	<p>Cracking</p> <table border="1" data-bbox="670 1153 805 1422"> <thead> <tr> <th>X</th> <th>Z</th> <th>Main Member</th> <th>Secondary Member</th> </tr> </thead> <tbody> <tr> <td>Large</td> <td>Large</td> <td>II</td> <td>II</td> </tr> <tr> <td>Small</td> <td>Small</td> <td>IV</td> <td>IV</td> </tr> <tr> <td>Large</td> <td>Small</td> <td>III</td> <td>IV</td> </tr> <tr> <td>Small</td> <td>Large</td> <td>IV</td> <td>III</td> </tr> </tbody> </table> <p>Although damage rank is III, cracking area is wide range, so that rehabilitation must be needed.</p>	X	Z	Main Member	Secondary Member	Large	Large	II	II	Small	Small	IV	IV	Large	Small	III	IV	Small	Large	IV	III	<p>* III</p>																						
X	Z	Main Member	Secondary Member																																										
Large	Large	II	II																																										
Small	Small	IV	IV																																										
Large	Small	III	IV																																										
Small	Large	IV	III																																										

(6) PUANGUE

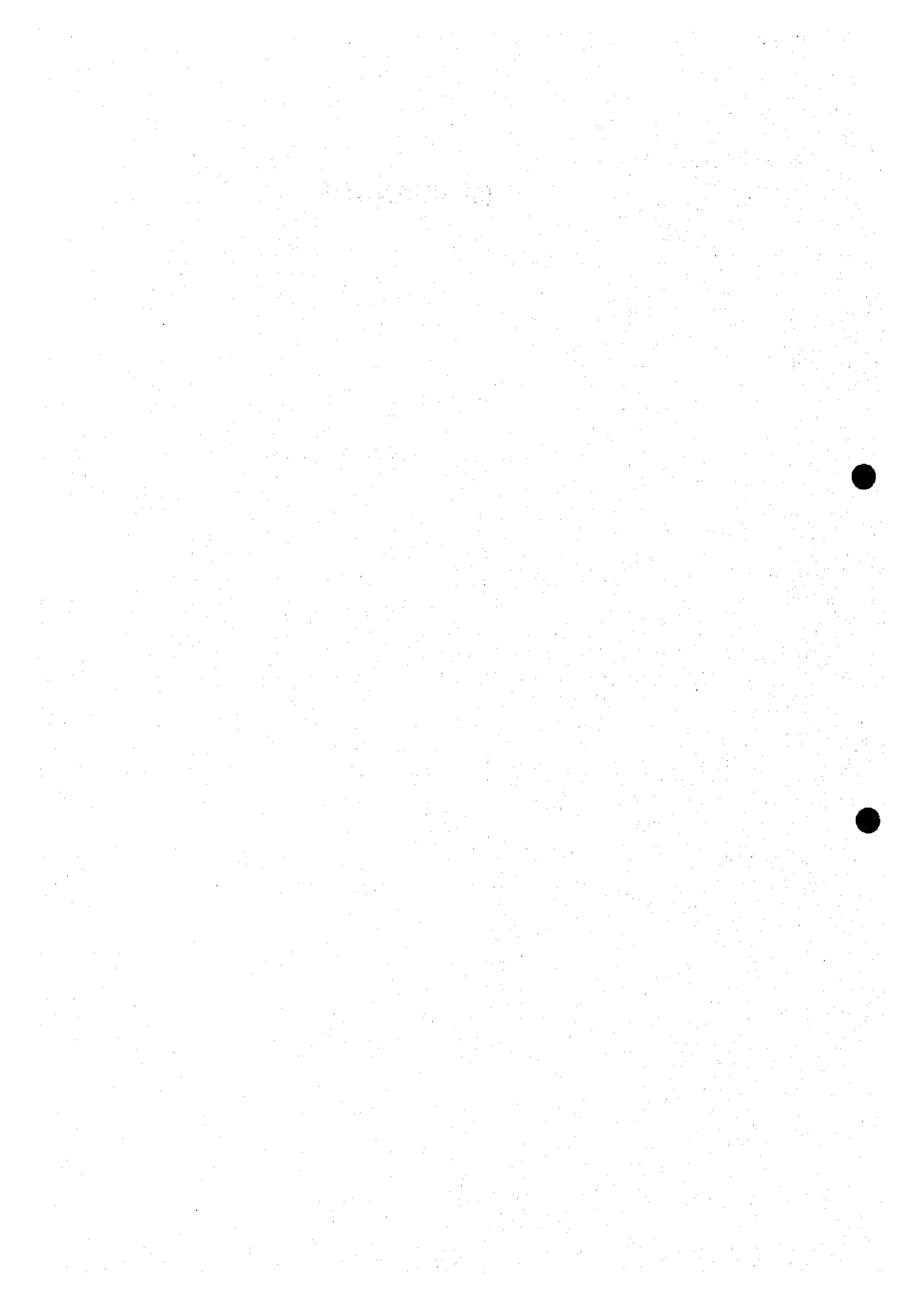

NOTE The bridge is a part of an important road which leads to Santiago and so has much traffic volume. It was initially constructed in 1930 and then extended in length in 1945 to cope with the change of the river flow. According to MOP's suggestion, the design load is too small. MOP injected epoxy resin into unallowable wide cracks, but they know the remedy is not enough.

BRIDGE NUMBER		YEAR OF BUILT	
BRIDGE NAME	PUANGUE	BRIDGE LENGTH	105.10m
REGION	RM	BRIDGE WIDTH	7.60m
ROUTE NAME	G-78	TRAFFIC VOLUME	455 PASS /DAY(1984)

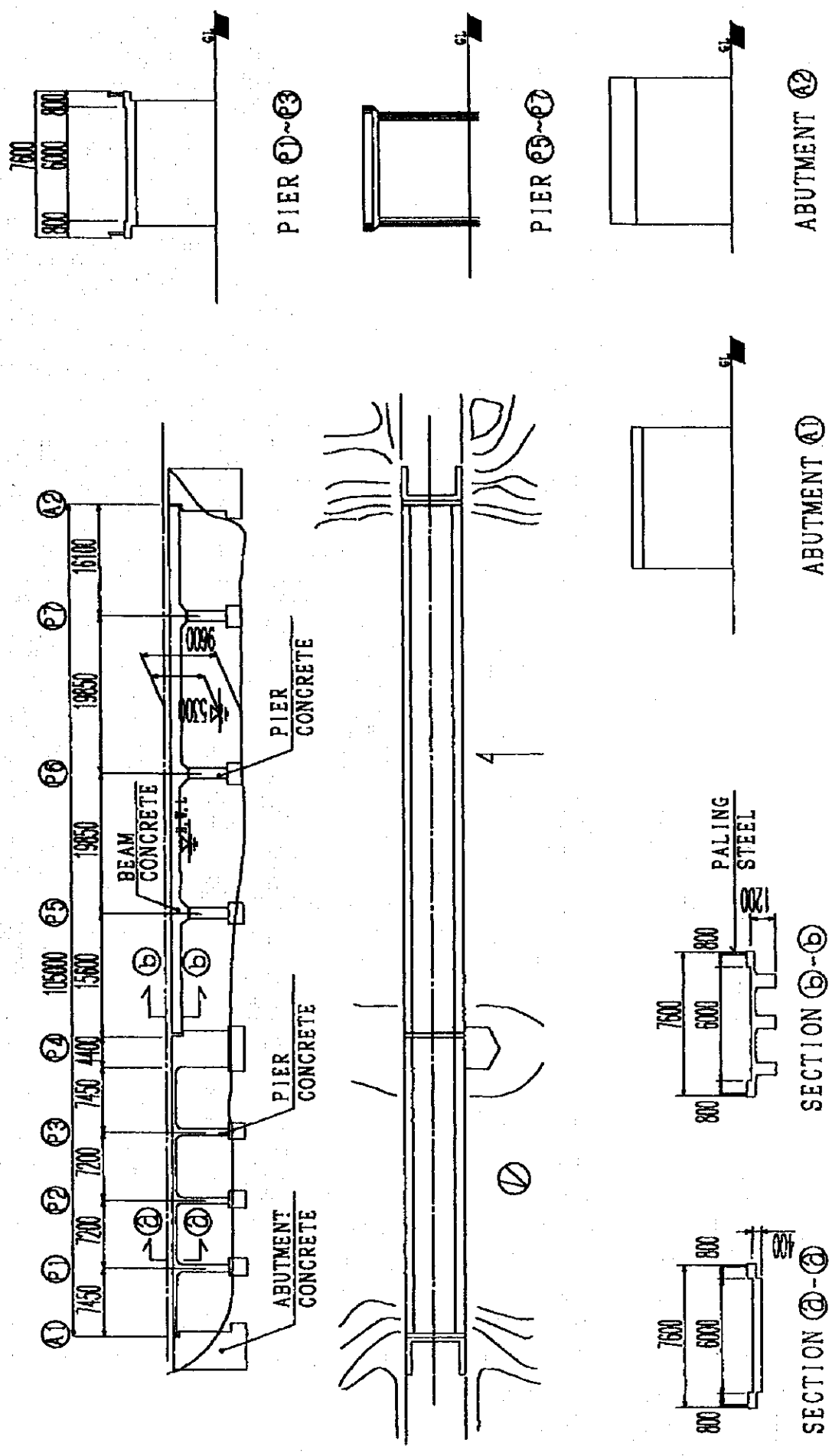

BRIDGE NO. 12 BRIDGE NAME: PUANGE

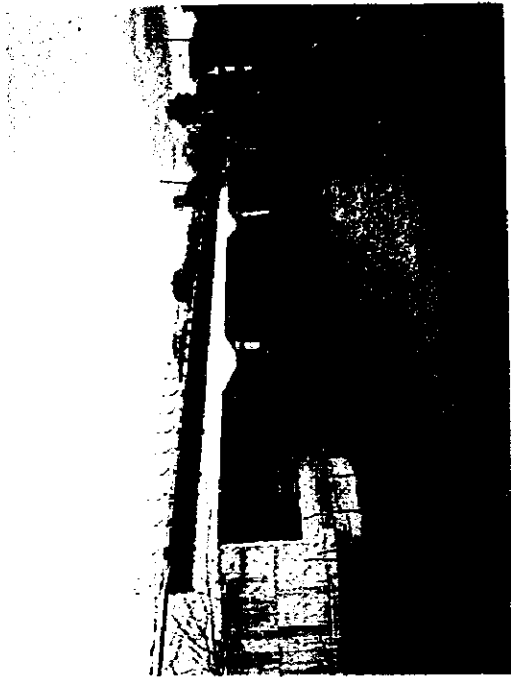

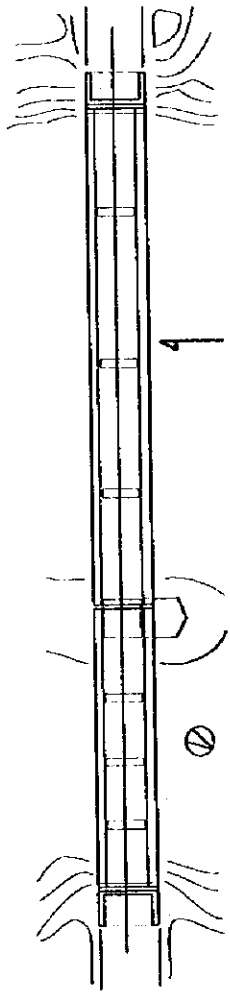
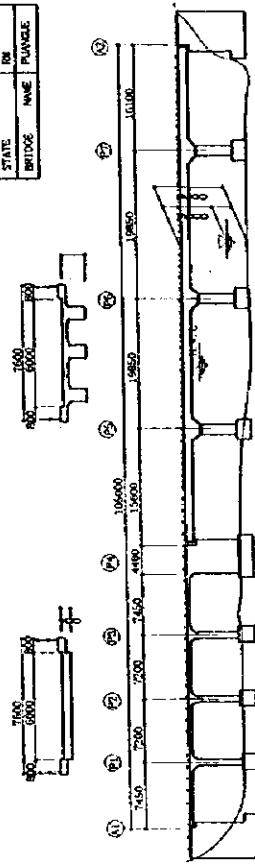

STATE	RM
BRIDGE	NAME
	PUANGE





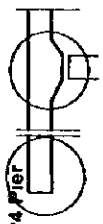
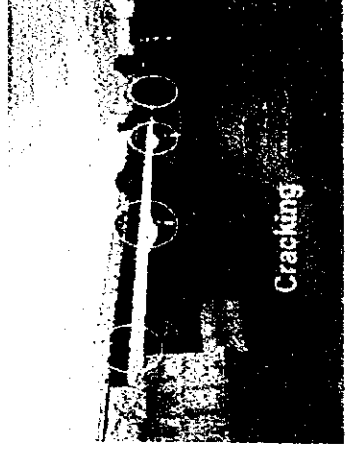
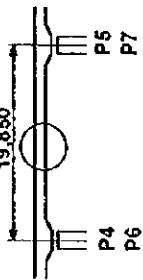
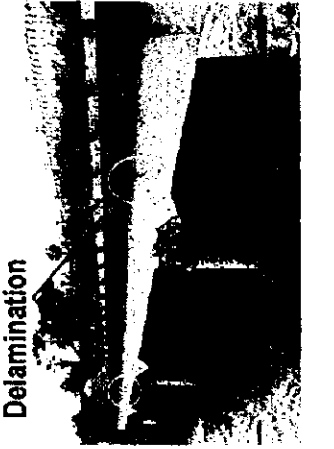
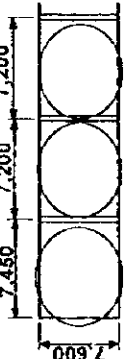
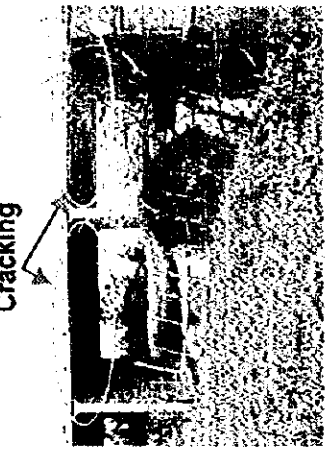

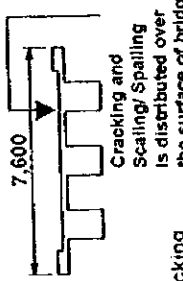
B. DAMAGE RANK AND DECISION ON REHABILITATION

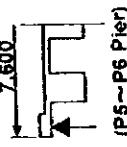
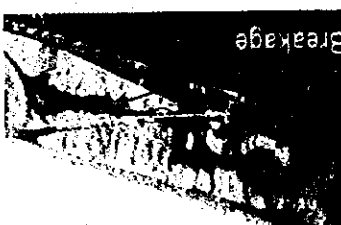
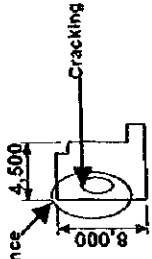
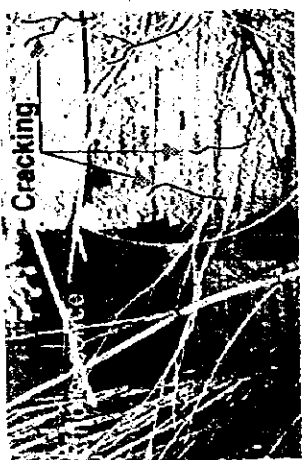
(1) Concrete Materials

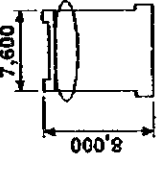
Bridge Component	Location of Damage	Damage	Evaluation of Damage	Damage Rank	Picture																
	 <p>P4 Pier P5~P7 Pier</p>	Cracking	The Damage (Cracking and) were observed, the rank was not justified because of inspection by distant view	No rank																	
Beam	 <p>P4 P5 P6 P7</p> <p>Y: no exposed reinforcement bar Z: over 1.0m²</p>	Delamination	<table border="1" style="margin-left: auto; margin-right: auto;"> <thead> <tr> <th>Y</th> <th>Z</th> <th>Main Member</th> <th>Secondary Member</th> </tr> </thead> <tbody> <tr> <td>Large</td> <td>Small</td> <td>II</td> <td>II</td> </tr> <tr> <td>Large</td> <td>Large</td> <td>III</td> <td>IV</td> </tr> <tr> <td>Small</td> <td>Small</td> <td>IV</td> <td>IV</td> </tr> </tbody> </table> <p>Damage was observed, but rehabilitation is not needed. Follow-up inspection must be executed.</p>	Y	Z	Main Member	Secondary Member	Large	Small	II	II	Large	Large	III	IV	Small	Small	IV	IV	III	
Y	Z	Main Member	Secondary Member																		
Large	Small	II	II																		
Large	Large	III	IV																		
Small	Small	IV	IV																		
Slab		Cracking	The Damage (Cracking and) were observed, the rank was not justified because of inspection by distant view.	No rank																	

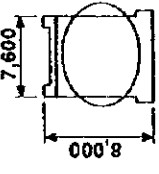
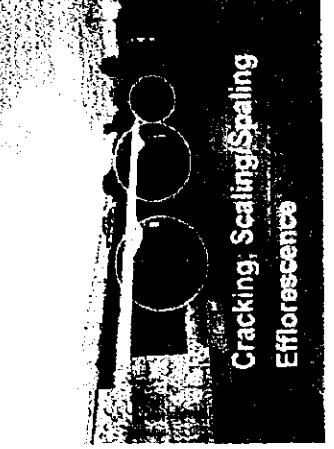
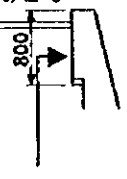
Bridge Component	Location of Damage	Damage	Evaluation of Damage	Damage Link	Picture																														
	 <p>Cracking and Scaling/Spalling is distributed over the surface of bridge.</p> <p>Cracking X: main part $0.3 > Y \geq 0.2\text{mm}$ Z: less 50cm</p> <p>Scaling/Spalling Y: no exposed reinforcement bar Z: over 0.1m²</p>	Cracking Scaling/Spalling	<p>Cracking</p> <table border="1"> <tr><th>Layer</th><th>Large</th><th>Small</th></tr> <tr><td>Top</td><td>II</td><td>III</td></tr> <tr><td>Bottom</td><td>II</td><td>III</td></tr> <tr><td>Side</td><td>II</td><td>III</td></tr> <tr><td>Other</td><td>II</td><td>III</td></tr> </table> <p>Degree of damage was large so that rehabilitation must be needed</p> <p>Scaling/Spalling</p> <table border="1"> <tr><th>Area</th><th>Large</th><th>Small</th></tr> <tr><td>Top</td><td>II</td><td>III</td></tr> <tr><td>Bottom</td><td>II</td><td>III</td></tr> <tr><td>Side</td><td>II</td><td>III</td></tr> <tr><td>Other</td><td>II</td><td>III</td></tr> </table> <p>Degree of damage was large so that Rehabilitation must be needed</p>	Layer	Large	Small	Top	II	III	Bottom	II	III	Side	II	III	Other	II	III	Area	Large	Small	Top	II	III	Bottom	II	III	Side	II	III	Other	II	III	Cracking II Scaling/Spalling II	
Layer	Large	Small																																	
Top	II	III																																	
Bottom	II	III																																	
Side	II	III																																	
Other	II	III																																	
Area	Large	Small																																	
Top	II	III																																	
Bottom	II	III																																	
Side	II	III																																	
Other	II	III																																	
Slab	 <p>(P5~P6 Pier)</p> <p>Y: remarkable damage</p>	Breakage	<table border="1"> <tr><th>Members</th><th>Large</th><th>Small</th></tr> <tr><td>All</td><td>IV</td><td>IV</td></tr> </table> <p>Degree of damage was large so that rehabilitation must be needed.</p>	Members	Large	Small	All	IV	IV	II																									
Members	Large	Small																																	
All	IV	IV																																	
A2 Abutment	 <p>Efflorescence</p> <p>Cracking</p> <p>Cracking X: main part Y < 0.2mm Z: less 50cm</p> <p>Efflorescence Z: over 1.0m²</p>	Cracking Efflorescence	<p>Cracking</p> <table border="1"> <tr><th>Layer</th><th>Large</th><th>Small</th></tr> <tr><td>Top</td><td>II</td><td>III</td></tr> <tr><td>Bottom</td><td>II</td><td>III</td></tr> <tr><td>Side</td><td>II</td><td>III</td></tr> <tr><td>Other</td><td>II</td><td>III</td></tr> </table> <p>Condition is sound</p> <p>Efflorescence</p> <table border="1"> <tr><th>Area</th><th>Large</th><th>Small</th></tr> <tr><td>Main Member</td><td>II</td><td>III</td></tr> <tr><td>Secondary Member</td><td>II</td><td>IV</td></tr> </table> <p>Degree of damage was large so that rehabilitation must be needed.</p>	Layer	Large	Small	Top	II	III	Bottom	II	III	Side	II	III	Other	II	III	Area	Large	Small	Main Member	II	III	Secondary Member	II	IV	Cracking V Efflorescence II							
Layer	Large	Small																																	
Top	II	III																																	
Bottom	II	III																																	
Side	II	III																																	
Other	II	III																																	
Area	Large	Small																																	
Main Member	II	III																																	
Secondary Member	II	IV																																	

Bridge Component	Location of Damage	Damage	Evaluation of Damage	Damage Rank	Picture																																																			
P1-P3 Pier		Cracking Efflorescence	The Damage (Cracking and Efflorescence) were observed, the rank was not justified because of inspection by distant view.	No rank																																																				
P4-P7 Pier		Cracking Scaling/Spalling Efflorescence	The Damages (Cracking, Scaling/Spalling and Efflorescence) were observed, the rank was not justified because of inspection by distant view.	No rank																																																				
Saide Walk (Footway)	 <p>Scaling/Spalling is distributed over the surface.</p> <p>Scaling/Spalling Y: no exposed reinforcement bar Z: over 1,0m²</p> <p>Efflorescence Z: less 1,0m²</p>	Scaling/Spalling Efflorescence	<p>Scaling/Spalling</p> <table border="1" data-bbox="1077 884 1197 1131"> <thead> <tr> <th></th> <th>Main Member</th> <th>Secondary Member</th> </tr> </thead> <tbody> <tr> <td>V</td> <td></td> <td></td> </tr> <tr> <td>Z</td> <td>Large</td> <td>Small</td> </tr> <tr> <td></td> <td>Large</td> <td>Small</td> </tr> <tr> <td></td> <td>Small</td> <td>Large</td> </tr> <tr> <td></td> <td>Small</td> <td>Large</td> </tr> <tr> <td></td> <td>Large</td> <td>Small</td> </tr> <tr> <td></td> <td>Small</td> <td>Large</td> </tr> <tr> <td></td> <td>Large</td> <td>Small</td> </tr> <tr> <td></td> <td>Small</td> <td>Large</td> </tr> </tbody> </table> <p>Damage was observed, but rehabilitation is not needed. Follow-up inspection must be executed.</p> <p>Efflorescence</p> <table border="1" data-bbox="1292 884 1412 1131"> <thead> <tr> <th></th> <th>Main Member</th> <th>Secondary Member</th> </tr> </thead> <tbody> <tr> <td>Z</td> <td>Large</td> <td>Small</td> </tr> <tr> <td></td> <td>Large</td> <td>Small</td> </tr> <tr> <td></td> <td>Small</td> <td>Large</td> </tr> <tr> <td></td> <td>Small</td> <td>Large</td> </tr> <tr> <td></td> <td>Large</td> <td>Small</td> </tr> <tr> <td></td> <td>Small</td> <td>Large</td> </tr> </tbody> </table> <p>Damage was observed, but rehabilitation is not needed. Follow-up inspection must be executed.</p>		Main Member	Secondary Member	V			Z	Large	Small		Large	Small		Small	Large		Small	Large		Large	Small		Small	Large		Large	Small		Small	Large		Main Member	Secondary Member	Z	Large	Small		Large	Small		Small	Large		Small	Large		Large	Small		Small	Large	Scaling/Spalling IV Efflorescence IV	
	Main Member	Secondary Member																																																						
V																																																								
Z	Large	Small																																																						
	Large	Small																																																						
	Small	Large																																																						
	Small	Large																																																						
	Large	Small																																																						
	Small	Large																																																						
	Large	Small																																																						
	Small	Large																																																						
	Main Member	Secondary Member																																																						
Z	Large	Small																																																						
	Large	Small																																																						
	Small	Large																																																						
	Small	Large																																																						
	Large	Small																																																						
	Small	Large																																																						

(7) SAN JOSE DE MARCHIUE

BRIDGE NUMBER	YEAR OF BUILT	NOTE The most fatal problem of the bridge is that the bridge deck sinks down below the water level because of the low elevation during frequent flood, and as the result various parts of the bridge suffers damages and deteriorated.	
BRIDGE NAME	BRIDGE LENGTH	120.00m	
REGION	BRIDGE WIDTH	5.50m	
ROUTE NAME	TRAFFIC VOLUME	151 PASS/DAY (1994)	

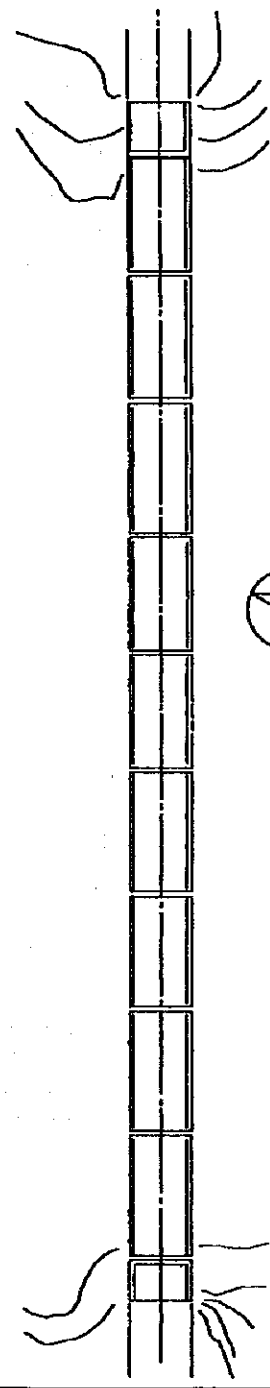
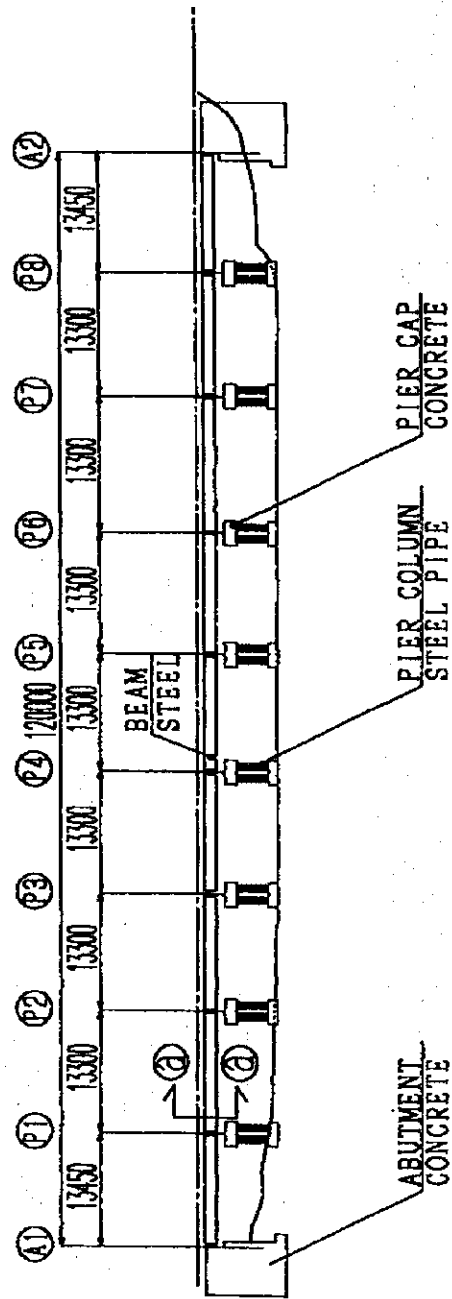
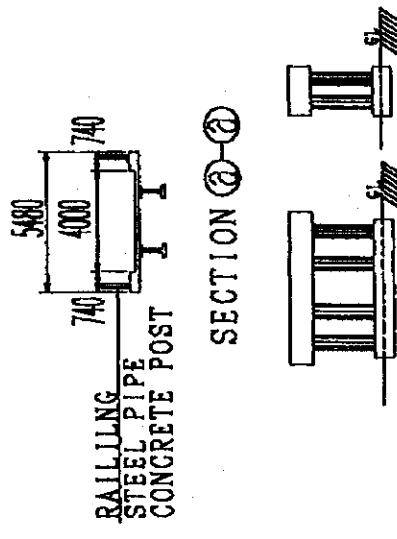

4

BRIDGE NO. 16 BRIDGE NAME: S. JOSE DE MARHUE

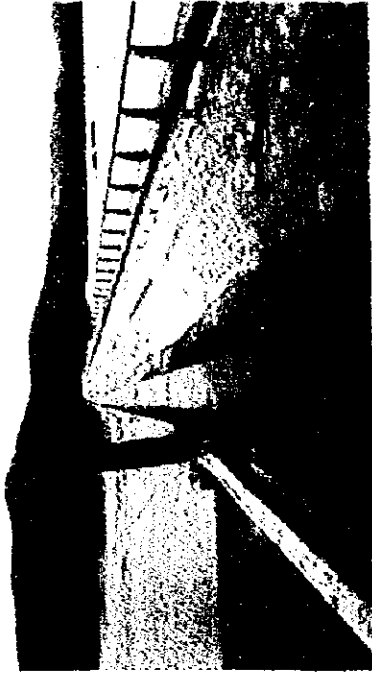
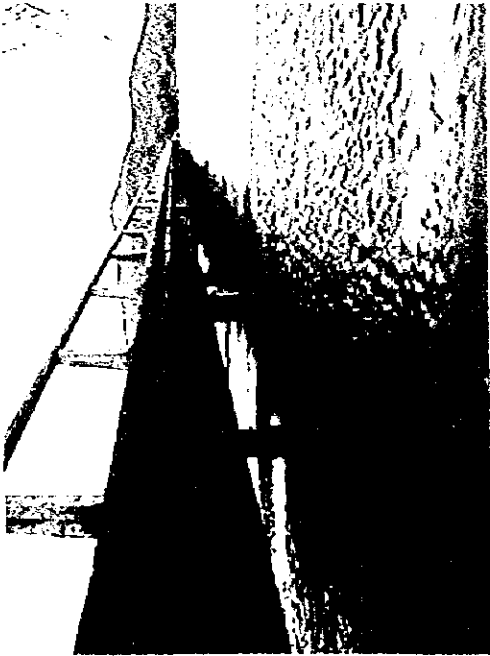

STATE	VI
BRIDGE NAME	SANJOSE DE MARCH

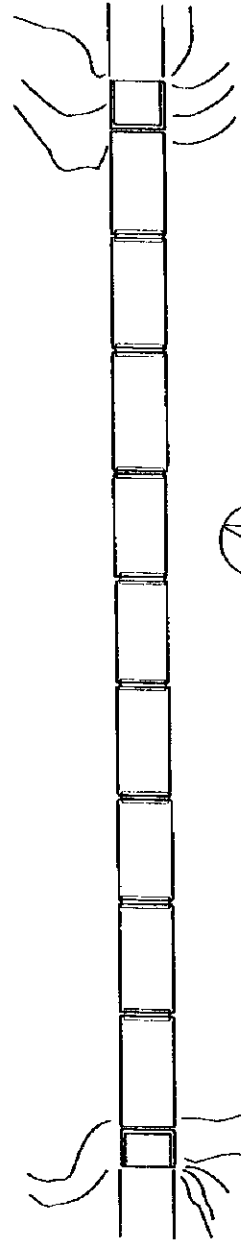
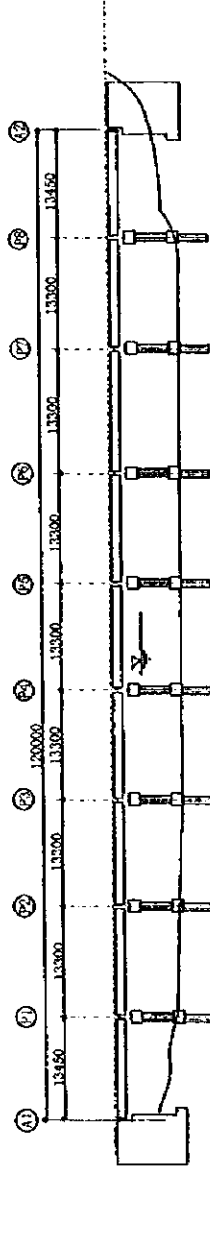
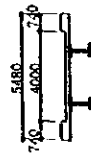

B. DAMAGE RANK AND DECISION ON REHABILITATION

(1) Concrete Materials

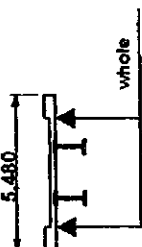
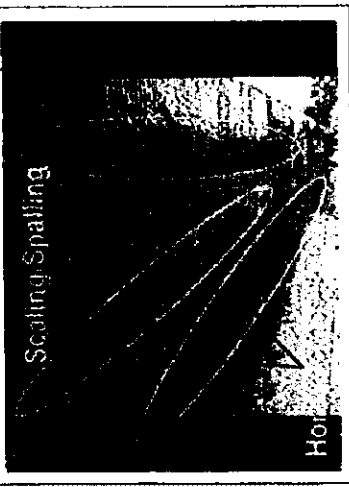
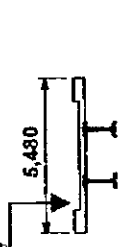
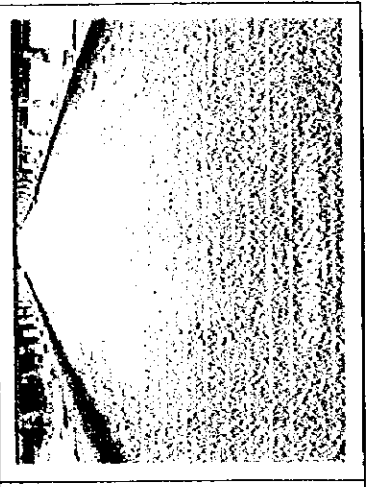
Bridge Component	Location of Damage	Damage	Evaluation of Damage	Damage Rank	Picture																								
<p>Bridge Component</p>	 <p>5.480</p> <p>whole area</p> <p>Scaling/ Spalling (1) Y: no exposed reinforcement bar Z: over 0.1m²</p> <p>Honeycombs Y: no exposed reinforcement bar Z: over 0.1m²</p> <p>Scaling/ Spalling (2) Y: no exposed reinforcement bar but deep Z: over 0.1m²</p> <p>Efflorescence Z: over 0.1m²</p>	<p>Scaling/Spalling Honeycombs</p>	<p>Scaling/ Spalling</p> <table border="1" data-bbox="359 884 550 1142"> <tr><td>Y</td><td>Z</td><td>Main Member</td><td>Secondary Member</td></tr> <tr><td>Large</td><td>Large</td><td>II</td><td>II</td></tr> <tr><td>Small</td><td>Small</td><td>IV</td><td>IV</td></tr> </table> <p>Damage was observed, but rehabilitation is not needed. Follow-up inspection must be executed.</p> <p>Honeycombs</p> <table border="1" data-bbox="550 884 742 1142"> <tr><td>Y</td><td>Z</td><td>Main Member</td><td>Secondary Member</td></tr> <tr><td>Large</td><td>Large</td><td>II</td><td>II</td></tr> <tr><td>Small</td><td>Small</td><td>IV</td><td>IV</td></tr> </table> <p>Damage was observed, but rehabilitation is not needed. Follow-up inspection must be executed.</p>	Y	Z	Main Member	Secondary Member	Large	Large	II	II	Small	Small	IV	IV	Y	Z	Main Member	Secondary Member	Large	Large	II	II	Small	Small	IV	IV	<p>Scaling/ Spalling III</p> <p>Honeycombs III</p>	 <p>Scaling/Spalling</p>
Y	Z	Main Member	Secondary Member																										
Large	Large	II	II																										
Small	Small	IV	IV																										
Y	Z	Main Member	Secondary Member																										
Large	Large	II	II																										
Small	Small	IV	IV																										
<p>Slab</p>	 <p>5.480</p> <p>Whole area</p> <p>Scaling/ Spalling Y: no exposed reinforcement bar Z: over 0.1m² (whole area of bridge surface)</p>	<p>Scaling/Spalling Efflorescence</p>	<p>Scaling/ Spalling</p> <table border="1" data-bbox="1085 884 1276 1142"> <tr><td>Y</td><td>Z</td><td>Main Member</td><td>Secondary Member</td></tr> <tr><td>Large</td><td>Large</td><td>II</td><td>II</td></tr> <tr><td>Small</td><td>Small</td><td>IV</td><td>IV</td></tr> </table> <p>Damage was observed, but rehabilitation is not needed. Follow-up inspection must be executed.</p> <p>Efflorescence</p> <table border="1" data-bbox="1276 884 1460 1142"> <tr><td>Y</td><td>Z</td><td>Main Member</td><td>Secondary Member</td></tr> <tr><td>Large</td><td>Large</td><td>II</td><td>II</td></tr> <tr><td>Small</td><td>Small</td><td>IV</td><td>IV</td></tr> </table> <p>Degree of damage is large so that rehabilitation must be needed.</p>	Y	Z	Main Member	Secondary Member	Large	Large	II	II	Small	Small	IV	IV	Y	Z	Main Member	Secondary Member	Large	Large	II	II	Small	Small	IV	IV	<p>Scaling/ Spalling III *</p> <p>Efflorescence II</p>	 <p>Scaling/Spalling</p>
Y	Z	Main Member	Secondary Member																										
Large	Large	II	II																										
Small	Small	IV	IV																										
Y	Z	Main Member	Secondary Member																										
Large	Large	II	II																										
Small	Small	IV	IV																										

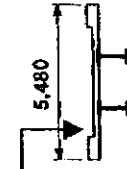
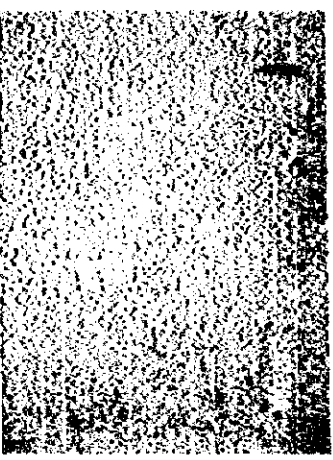
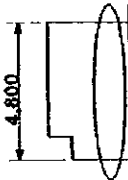
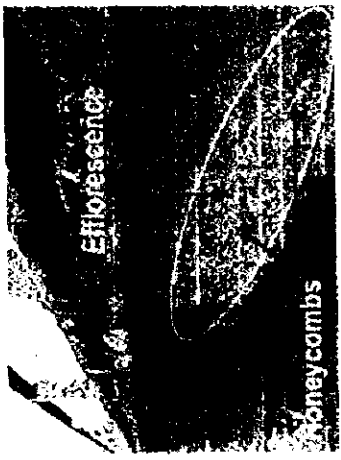
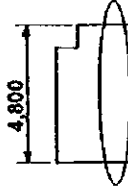
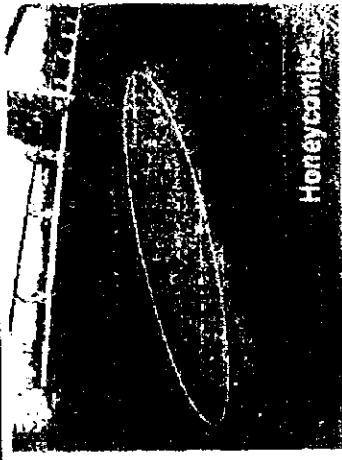
Bridge Component	Location of Damage	Damage	Evaluation of Damage	Damage Rank	Picture																									
Slab	<p>whole area</p>  <p>5,480</p> <p>Y: no exposed reinforcement bar Z: over 1.0m²</p>	Wear	<table border="1"> <tr> <td>Y</td> <td>Z</td> <td>All members</td> </tr> <tr> <td>Large</td> <td></td> <td>II</td> </tr> <tr> <td>Small</td> <td></td> <td>III</td> </tr> <tr> <td>Large</td> <td></td> <td>IV</td> </tr> <tr> <td>Small</td> <td></td> <td>IV</td> </tr> </table> <p>Damage was observed, but rehabilitation is not needed. Follow-up inspection must be executed.</p>	Y	Z	All members	Large		II	Small		III	Large		IV	Small		IV	III											
Y	Z	All members																												
Large		II																												
Small		III																												
Large		IV																												
Small		IV																												
A1 Abutment	 <p>4,800</p> <p>Efflorescence Z: less 1.0m²</p> <p>Honeycombs Y: no exposed reinforcement bar Z: less 1.0m²</p>	Efflorescence Honeycombs	<p>Efflorescence</p> <table border="1"> <tr> <td>Z</td> <td>Main Member</td> <td>Secondary Member</td> </tr> <tr> <td>Large</td> <td>II</td> <td>IV</td> </tr> <tr> <td>Small</td> <td></td> <td>IV</td> </tr> </table> <p>Damage was observed, but rehabilitation is not needed. Follow-up inspection must be executed.</p> <p>Honeycombs</p> <table border="1"> <tr> <td>Y</td> <td>Z</td> <td>Main Member</td> <td>Secondary Member</td> </tr> <tr> <td>Large</td> <td></td> <td>II</td> <td>IV</td> </tr> <tr> <td>Small</td> <td></td> <td>III</td> <td>IV</td> </tr> <tr> <td>Small</td> <td></td> <td>IV</td> <td>IV</td> </tr> </table> <p>Damage was observed, the degree must be recorded.</p>	Z	Main Member	Secondary Member	Large	II	IV	Small		IV	Y	Z	Main Member	Secondary Member	Large		II	IV	Small		III	IV	Small		IV	IV	Efflorescence III Honeycombs IV	
	Z	Main Member	Secondary Member																											
Large	II	IV																												
Small		IV																												
Y	Z	Main Member	Secondary Member																											
Large		II	IV																											
Small		III	IV																											
Small		IV	IV																											
	 <p>4,800</p> <p>Y: no exposed reinforcement bar Z: less 1.0m²</p>	Honeycombs	<table border="1"> <tr> <td>Y</td> <td>Z</td> <td>Main Member</td> <td>Secondary Member</td> </tr> <tr> <td>Large</td> <td></td> <td>II</td> <td>IV</td> </tr> <tr> <td>Small</td> <td></td> <td>I</td> <td>IV</td> </tr> <tr> <td>Large</td> <td></td> <td>III</td> <td>IV</td> </tr> <tr> <td>Small</td> <td></td> <td>IV</td> <td>IV</td> </tr> </table> <p>Damage was observed, the degree must be recorded.</p>	Y	Z	Main Member	Secondary Member	Large		II	IV	Small		I	IV	Large		III	IV	Small		IV	IV	IV						
Y	Z	Main Member	Secondary Member																											
Large		II	IV																											
Small		I	IV																											
Large		III	IV																											
Small		IV	IV																											

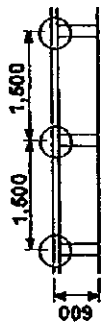
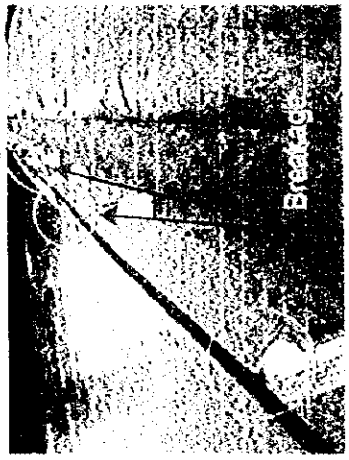
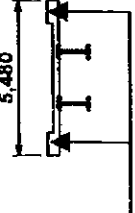
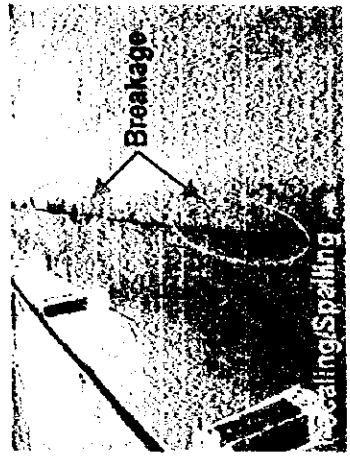
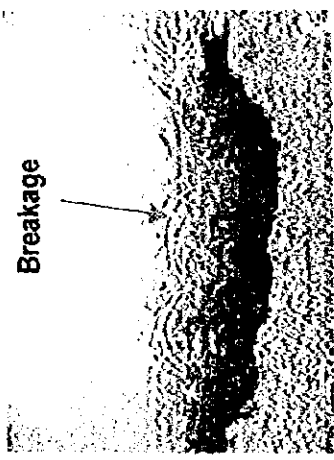
Bridge Component	Location of Damage	Damage	Evaluation of Damage	Damage Rank	Picture																												
Hand Railing (Post)	 <p>Y: remarkable damage</p>	Breakage	<table border="1"> <tr><td>Y</td><td>All Members</td></tr> <tr><td>Large</td><td>IV</td></tr> <tr><td>Small</td><td>IV</td></tr> </table> <p>Degree of damage is large, so that rehabilitation must be needed.</p>	Y	All Members	Large	IV	Small	IV	II																							
Y	All Members																																
Large	IV																																
Small	IV																																
Side Walk (FootWay)	 <p>Scaling/ Spalling Y: no exposed reinforcement bar Z: over 1.0m2</p> <p>Breakage (1) Y: remarkable damage</p> <p>Breakage (2) Y: remarkable damage</p>	Scaling/Spalling Breakage	<table border="1"> <tr><td>Y</td><td>Z</td><td>Main Member</td><td>Secondary Member</td></tr> <tr><td>Large</td><td>Small</td><td>II</td><td>II</td></tr> <tr><td>Small</td><td>Large</td><td>II</td><td>IV</td></tr> <tr><td></td><td>Small</td><td>III</td><td>IV</td></tr> <tr><td></td><td></td><td>IV</td><td>IV</td></tr> </table> <p>Damage was observed, the degree must be recorded.</p> <table border="1"> <tr><td>Breakage</td><td>All Members</td></tr> <tr><td>Y</td><td>Large</td></tr> <tr><td></td><td>Small</td></tr> <tr><td></td><td>IV</td></tr> </table> <p>Degree of damage is large, so that rehabilitation must be needed.</p>	Y	Z	Main Member	Secondary Member	Large	Small	II	II	Small	Large	II	IV		Small	III	IV			IV	IV	Breakage	All Members	Y	Large		Small		IV	Scaling/ Spalling IV Breakage II	
Y	Z	Main Member	Secondary Member																														
Large	Small	II	II																														
Small	Large	II	IV																														
	Small	III	IV																														
		IV	IV																														
Breakage	All Members																																
Y	Large																																
	Small																																
	IV																																
		Breakage	<table border="1"> <tr><td>Y</td><td>All Members</td></tr> <tr><td>Large</td><td>IV</td></tr> <tr><td>Small</td><td>IV</td></tr> </table> <p>Degree of damage is large, so that rehabilitation must be needed.</p>	Y	All Members	Large	IV	Small	IV	II																							
Y	All Members																																
Large	IV																																
Small	IV																																

() Steel Marerials

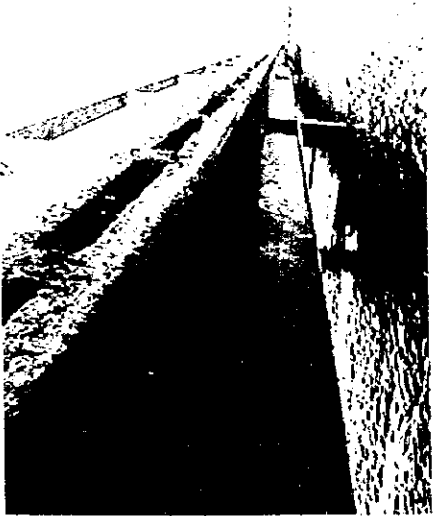
Bridge Component	Location of Damage	Damage	Evaluation of Damage	Damage Rank	Picture															
Beam		Aging of Coat	<table border="1" data-bbox="411 1048 609 1355"> <tr> <td>Y</td> <td>Z</td> <td>All Members</td> </tr> <tr> <td>Large</td> <td>Large</td> <td>III</td> </tr> <tr> <td>Small</td> <td>Small</td> <td>IV</td> </tr> <tr> <td>Large</td> <td>Large</td> <td>IV</td> </tr> <tr> <td>Small</td> <td>Small</td> <td>OK</td> </tr> </table>	Y	Z	All Members	Large	Large	III	Small	Small	IV	Large	Large	IV	Small	Small	OK	IV	
Y	Z	All Members																		
Large	Large	III																		
Small	Small	IV																		
Large	Large	IV																		
Small	Small	OK																		

(8) ANTIVERO N°2

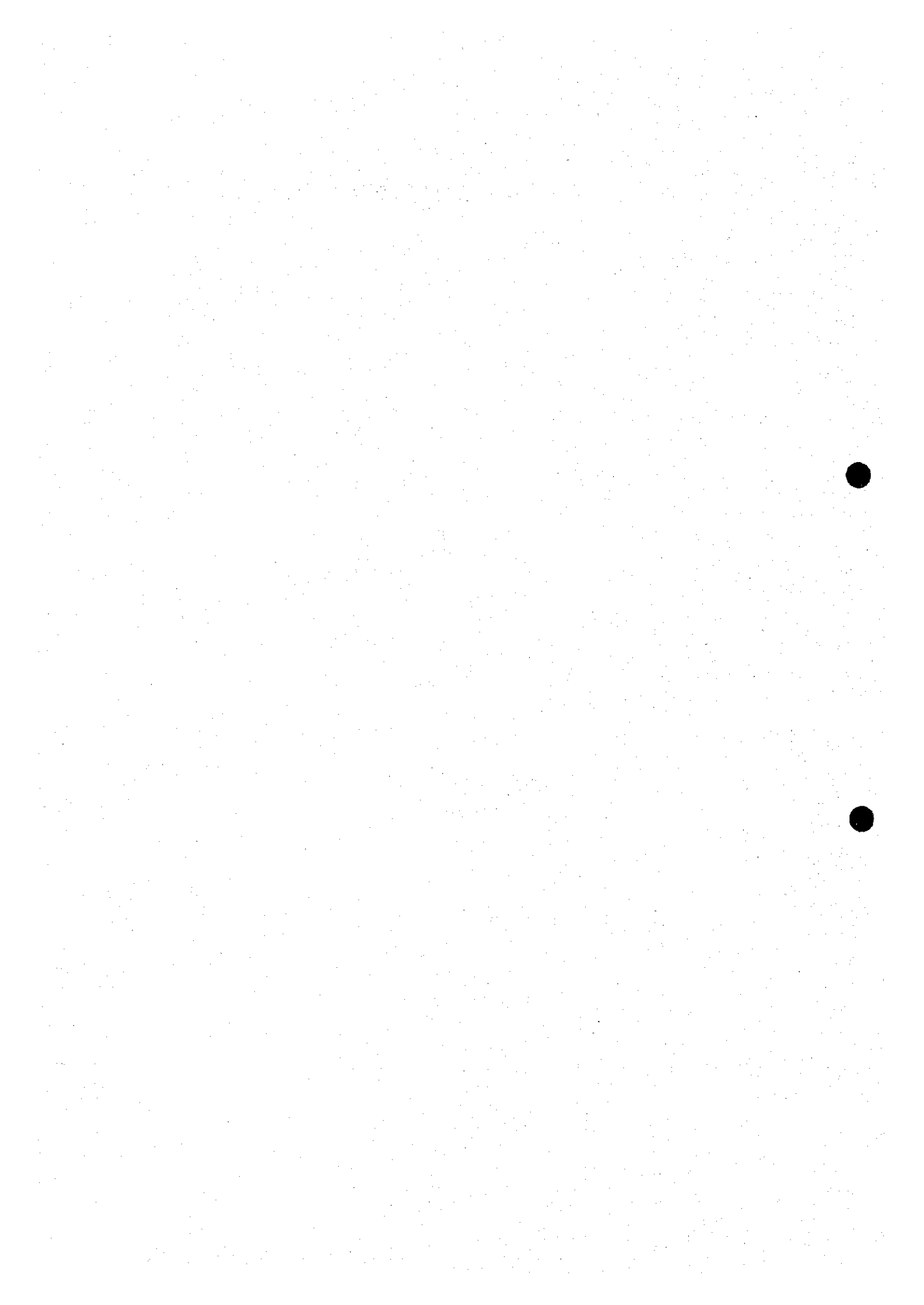

NOTE The bridge is almost fifty years old. The superstructure is of a so-called Gerber girder bridge. The river bed has been scored by the water flow and the foundations are in serious conditions. Several parts of the substructures were repaired. The road way is not wide enough compared with the traffic volume.

BRIDGE NUMBER	YEAR OF BUILT
BRIDGE NAME	ANTIVERO NO. 2
REGION	N
ROUTE NAME	
	BRIDGE LENGTH 102.90m
	BRIDGE WIDTH 8.50m
	TRAFFIC VOLUME

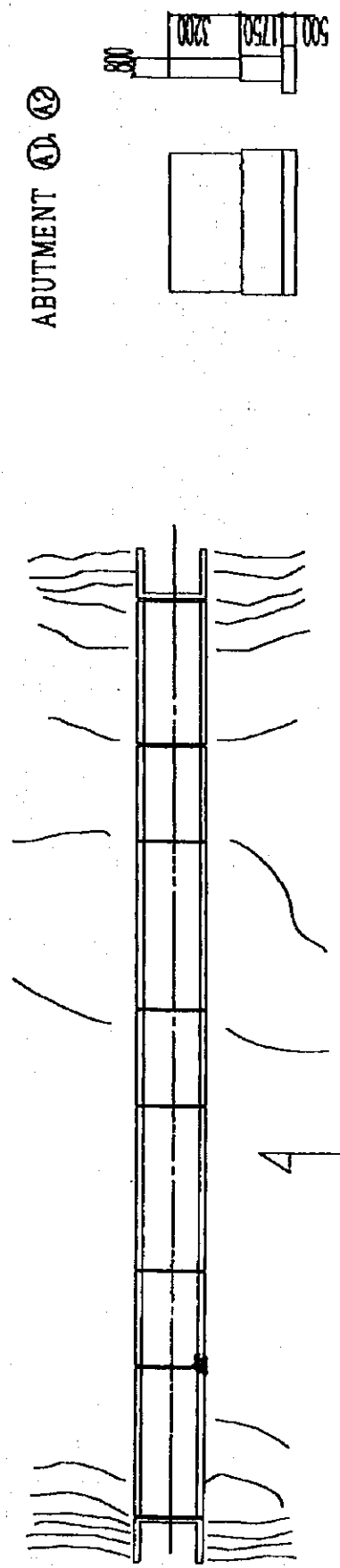
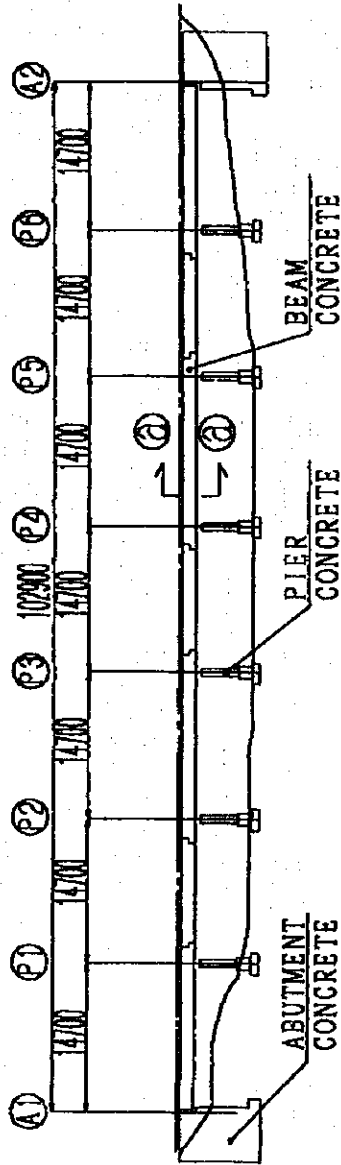
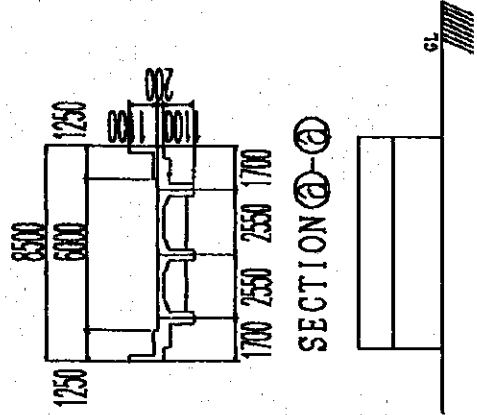

BRIDGE NO. BRIDGE NAME: ANTIVERO NO.2

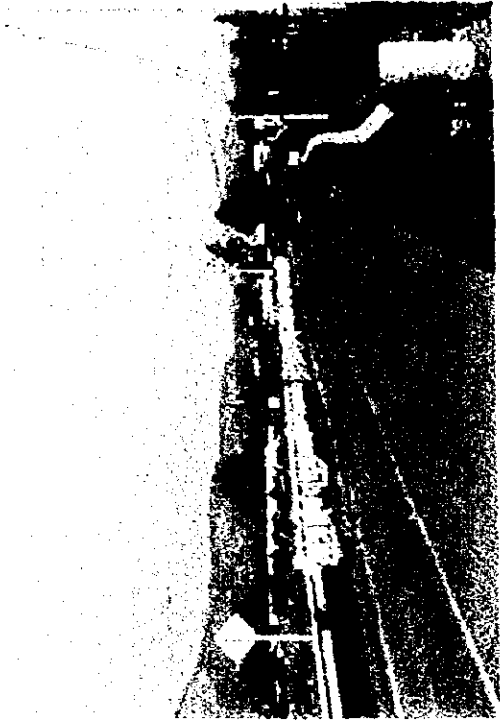

STATE	VI
BRIDGE NAME	ANTIVERO

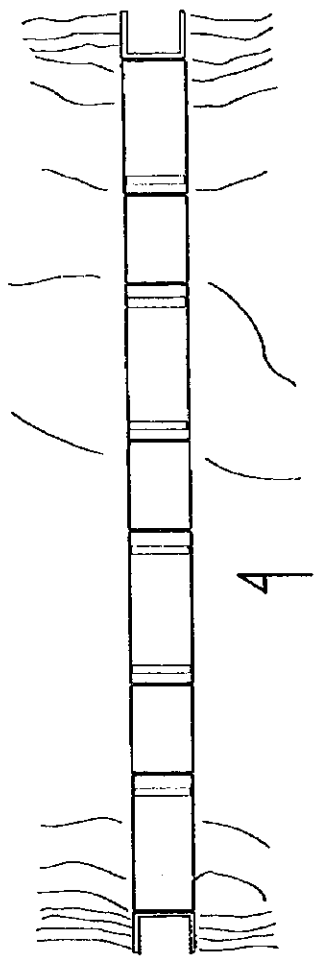
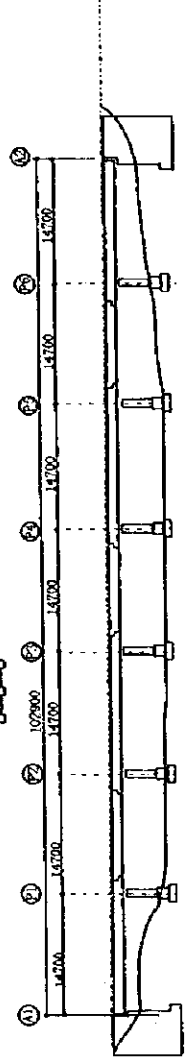
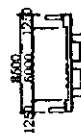





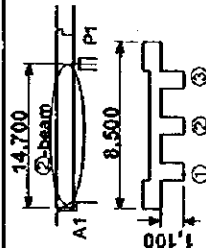
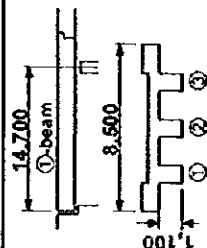
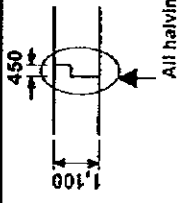

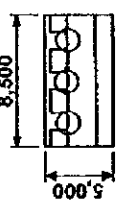

B. DAMAGE RANK AND DECISION ON REHABILITATION

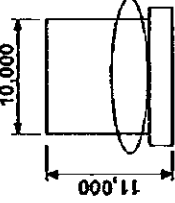

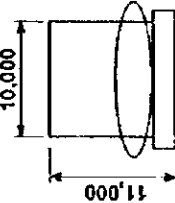
(1) Concrete Materials

Bridge Component	Location of Damage	Damage	Evaluation of Damage	Damage Rank	Picture																									
Beam	 <p style="text-align: center;">X: main part $0.3 > Y \geq 0.2\text{mm}$ Z: over 50cm</p>	Cracking	<table border="1" style="width: 100%; text-align: center;"> <thead> <tr> <th>X</th> <th>Y</th> <th>Z</th> <th>Main Member</th> <th>Secondary Member</th> </tr> </thead> <tbody> <tr> <td>Large</td> <td>Large</td> <td>Small</td> <td>I</td> <td>I</td> </tr> <tr> <td>Medium</td> <td>Large</td> <td>Medium</td> <td>II</td> <td>II</td> </tr> <tr> <td>Small</td> <td>Small</td> <td>Small</td> <td>V</td> <td>V</td> </tr> <tr> <td></td> <td>Small</td> <td>Small</td> <td>V</td> <td>V</td> </tr> </tbody> </table> <p>Although damage rank is III, cracking arouse on the important part, so that rehabilitation must be needed.</p>	X	Y	Z	Main Member	Secondary Member	Large	Large	Small	I	I	Medium	Large	Medium	II	II	Small	Small	Small	V	V		Small	Small	V	V	* III	Cracking
	X	Y	Z	Main Member	Secondary Member																									
Large	Large	Small	I	I																										
Medium	Large	Medium	II	II																										
Small	Small	Small	V	V																										
	Small	Small	V	V																										
	 <p style="text-align: center;">Y: exposed reinforcement bar Z: over 0.1m²</p>	Scaling/Spalling	<table border="1" style="width: 100%; text-align: center;"> <thead> <tr> <th>Y</th> <th>Z</th> <th>Main Member</th> <th>Secondary Member</th> </tr> </thead> <tbody> <tr> <td>Large</td> <td>Small</td> <td>II</td> <td>IV</td> </tr> <tr> <td>Small</td> <td>Large</td> <td>III</td> <td>IV</td> </tr> <tr> <td></td> <td>Small</td> <td>IV</td> <td>IV</td> </tr> </tbody> </table> <p>Degree of damage is large, so that rehabilitation must be needed.</p>	Y	Z	Main Member	Secondary Member	Large	Small	II	IV	Small	Large	III	IV		Small	IV	IV	II	Scaling/Spalling									
Y	Z	Main Member	Secondary Member																											
Large	Small	II	IV																											
Small	Large	III	IV																											
	Small	IV	IV																											
	 <p style="text-align: center;">Z: over 0.1m²</p>	Efflorescence	<table border="1" style="width: 100%; text-align: center;"> <thead> <tr> <th>Z</th> <th>Main Member</th> <th>Secondary Member</th> </tr> </thead> <tbody> <tr> <td>Large</td> <td>III</td> <td>IV</td> </tr> <tr> <td>Small</td> <td>III</td> <td>IV</td> </tr> </tbody> </table> <p>Degree of damage is large, so that rehabilitation must be needed.</p>	Z	Main Member	Secondary Member	Large	III	IV	Small	III	IV	II	Efflorescence																
Z	Main Member	Secondary Member																												
Large	III	IV																												
Small	III	IV																												

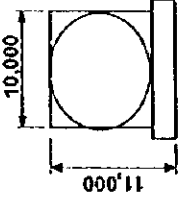
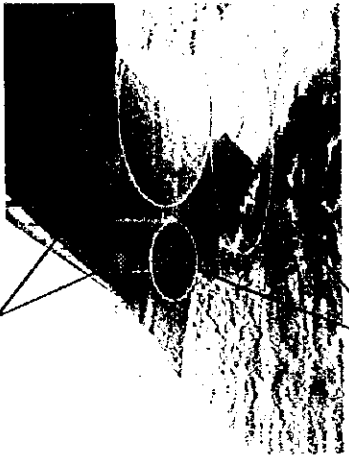
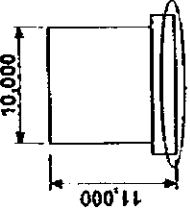
Bridge Component	Location of Damage	Damage	Evaluation of Damage	Damage Rank	Picture																				
	<p>X: main part Y: $\geq 0.3\text{mm}$ Z: less 50cm</p>	Cracking	<table border="1"> <thead> <tr> <th>X</th> <th>Y</th> <th>Z</th> <th>Main Member</th> <th>Secondary Member</th> </tr> </thead> <tbody> <tr> <td>Large</td> <td>Large</td> <td>Large</td> <td>II</td> <td>II</td> </tr> <tr> <td>Medium</td> <td>Medium</td> <td>Medium</td> <td>III</td> <td>III</td> </tr> <tr> <td>Small</td> <td>Small</td> <td>Small</td> <td>IV</td> <td>IV</td> </tr> </tbody> </table> <p>Degree of damage is large, so that rehabilitation must be needed.</p>	X	Y	Z	Main Member	Secondary Member	Large	Large	Large	II	II	Medium	Medium	Medium	III	III	Small	Small	Small	IV	IV	II	
X	Y	Z	Main Member	Secondary Member																					
Large	Large	Large	II	II																					
Medium	Medium	Medium	III	III																					
Small	Small	Small	IV	IV																					
Beam	<p>Y: no exposed reinforcement bar Z: over 0.1m²</p>	Scaling/Spalling	<table border="1"> <thead> <tr> <th>Y</th> <th>Z</th> <th>Main Member</th> <th>Secondary Member</th> </tr> </thead> <tbody> <tr> <td>Large</td> <td>Large</td> <td>II</td> <td>II</td> </tr> <tr> <td>Medium</td> <td>Medium</td> <td>III</td> <td>III</td> </tr> <tr> <td>Small</td> <td>Small</td> <td>IV</td> <td>IV</td> </tr> </tbody> </table> <p>Damage was observed, but rehabilitation is not needed. Follow-up inspection must be executed.</p>	Y	Z	Main Member	Secondary Member	Large	Large	II	II	Medium	Medium	III	III	Small	Small	IV	IV	III					
Y	Z	Main Member	Secondary Member																						
Large	Large	II	II																						
Medium	Medium	III	III																						
Small	Small	IV	IV																						
A1 Abutment	<p>Y: exposed reinforcement bar Z: over 1.0m²</p>	Scaling/Spalling	<table border="1"> <thead> <tr> <th>Y</th> <th>Z</th> <th>Main Member</th> <th>Secondary Member</th> </tr> </thead> <tbody> <tr> <td>Large</td> <td>Large</td> <td>II</td> <td>II</td> </tr> <tr> <td>Medium</td> <td>Medium</td> <td>III</td> <td>III</td> </tr> <tr> <td>Small</td> <td>Small</td> <td>IV</td> <td>IV</td> </tr> </tbody> </table> <p>Degree of damage is serious so that rehabilitation must be needed.</p>	Y	Z	Main Member	Secondary Member	Large	Large	II	II	Medium	Medium	III	III	Small	Small	IV	IV	II					
Y	Z	Main Member	Secondary Member																						
Large	Large	II	II																						
Medium	Medium	III	III																						
Small	Small	IV	IV																						

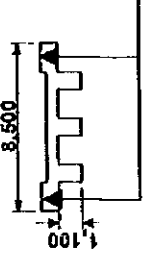
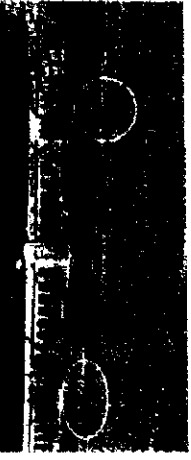
Bridge Component	Location of Damage	Damage	Evaluation of Damage	Damage Rank	Picture																				
A1 Abutment	 <p>Y: remarkable damage</p>	Breakage	<table border="1" data-bbox="359 896 462 1108"> <tr> <td>Y</td> <td>All Members</td> </tr> <tr> <td>Large</td> <td></td> </tr> <tr> <td>Small</td> <td>IV</td> </tr> </table> <p>Degree of damage is large, so that rehabilitation must be needed.</p>	Y	All Members	Large		Small	IV	II															
Y	All Members																								
Large																									
Small	IV																								
P1 Pier	 <p>Scaling/ Spalling and Honeycombs Y: no exposed reinforcement bar but deep Z: over 1.0m2</p>	Scaling/Spalling Honeycombs	<table border="1" data-bbox="710 873 821 1131"> <tr> <th colspan="2">Scaling/ Spalling</th> <th colspan="2">Honeycombs</th> </tr> <tr> <td>Y</td> <td>Z</td> <td>Main Member</td> <td>Secondary Member</td> </tr> <tr> <td>Large</td> <td>Small</td> <td>0</td> <td>0</td> </tr> <tr> <td>Small</td> <td>Small</td> <td>IV</td> <td>IV</td> </tr> <tr> <td>Small</td> <td>Small</td> <td>IV</td> <td>IV</td> </tr> </table> <p>Although damage rank is III, the degree is very deep so that rehabilitation must be needed.</p>	Scaling/ Spalling		Honeycombs		Y	Z	Main Member	Secondary Member	Large	Small	0	0	Small	Small	IV	IV	Small	Small	IV	IV	Scaling/ Spalling * III Honeycombs * III	
Scaling/ Spalling		Honeycombs																							
Y	Z	Main Member	Secondary Member																						
Large	Small	0	0																						
Small	Small	IV	IV																						
Small	Small	IV	IV																						
P6 Pier	 <p>Z: over 1.0m2</p>	Efflorescence	<table border="1" data-bbox="1093 884 1204 1120"> <tr> <td>Z</td> <td>Main Member</td> <td>Secondary Member</td> </tr> <tr> <td>Large</td> <td></td> <td>II</td> </tr> <tr> <td>Small</td> <td>III</td> <td>IV</td> </tr> </table> <p>Degree of damage is large, so that rehabilitation must be needed.</p>	Z	Main Member	Secondary Member	Large		II	Small	III	IV	II												
Z	Main Member	Secondary Member																							
Large		II																							
Small	III	IV																							

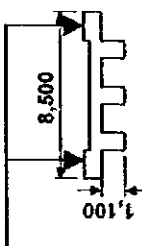
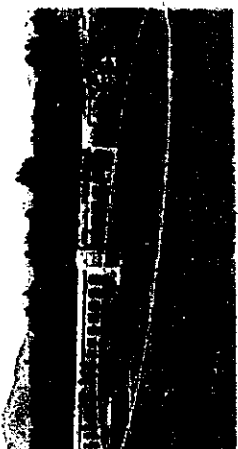
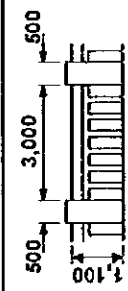
Bridge Component	Location of Damage	Damage	Evaluation of Damage	Damage Rank	Picture															
P3~P5 Pier	 <p>Z: over 1.0m²</p>	Efflorescence	<table border="1" data-bbox="288 902 400 1151"> <tr> <td>Z</td> <td>Main Member</td> <td>Secondary Member</td> </tr> <tr> <td>Large</td> <td>III</td> <td>II</td> </tr> <tr> <td>Small</td> <td>IV</td> <td>IV</td> </tr> </table> <p>Although damage rank is II, degree of efflorescence was not so serious so that rehabilitation is not needed. Follow-up inspection must be executed.</p>	Z	Main Member	Secondary Member	Large	III	II	Small	IV	IV	II							
Z	Main Member	Secondary Member																		
Large	III	II																		
Small	IV	IV																		
P3~P5 Pier Foundation	 <p>Y: no exposed reinforcement bar Z: over 1.0m²</p>	Wear	<table border="1" data-bbox="671 902 836 1151"> <tr> <td>Y</td> <td>Z</td> <td>All members</td> </tr> <tr> <td>Large</td> <td>Large</td> <td>II</td> </tr> <tr> <td>Small</td> <td>Small</td> <td>III</td> </tr> <tr> <td>Small</td> <td>Large</td> <td>IV</td> </tr> <tr> <td>Small</td> <td>Small</td> <td>IV</td> </tr> </table> <p>Although damage rank is III, this wear damage would affect the stability of foundation so that rehabilitation must be needed.</p>	Y	Z	All members	Large	Large	II	Small	Small	III	Small	Large	IV	Small	Small	IV	III*	
Y	Z	All members																		
Large	Large	II																		
Small	Small	III																		
Small	Large	IV																		
Small	Small	IV																		
Side Walk (Curb)	 <p>Y: observed damage</p>	Breakage	<table border="1" data-bbox="1034 902 1166 1151"> <tr> <td>Y</td> <td>All Members</td> </tr> <tr> <td>Large</td> <td>II</td> </tr> <tr> <td>Small</td> <td>IV</td> </tr> </table> <p>Damage was observed, the degree must be recorded.</p>	Y	All Members	Large	II	Small	IV	IV										
Y	All Members																			
Large	II																			
Small	IV																			

Bridge Component	Location of Damage	Damage	Evaluation of Damage	Damage Rank	Picture																																								
Side Walk (FootWay)	 <p>8,500</p> <p>80</p>	Scaling/Spalling	<table border="1"> <thead> <tr> <th>Y</th> <th>Z</th> <th>Main Member</th> <th>Secondary Member</th> </tr> </thead> <tbody> <tr> <td>Large</td> <td>Small</td> <td>II</td> <td>II</td> </tr> <tr> <td>Small</td> <td>Large</td> <td>IV</td> <td>IV</td> </tr> <tr> <td>Small</td> <td>Small</td> <td>IV</td> <td>IV</td> </tr> </tbody> </table> <p>Damage was observed, but rehabilitation is not needed. Follow up inspection must be executed.</p>	Y	Z	Main Member	Secondary Member	Large	Small	II	II	Small	Large	IV	IV	Small	Small	IV	IV	III	 <p>Honeycombs</p>																								
		Y	Z	Main Member	Secondary Member																																								
Large	Small	II	II																																										
Small	Large	IV	IV																																										
Small	Small	IV	IV																																										
Honeycombs	<table border="1"> <thead> <tr> <th>Y</th> <th>Z</th> <th>All members</th> </tr> </thead> <tbody> <tr> <td>Large</td> <td>Large</td> <td>I</td> </tr> <tr> <td>Small</td> <td>Small</td> <td>III</td> </tr> <tr> <td>Small</td> <td>Large</td> <td>IV</td> </tr> <tr> <td>Small</td> <td>Small</td> <td>IV</td> </tr> </tbody> </table> <p>Damage was observed, but rehabilitation is not needed. Follow up inspection must be executed.</p>	Y	Z	All members	Large	Large	I	Small	Small	III	Small	Large	IV	Small	Small	IV	III																												
Y	Z	All members																																											
Large	Large	I																																											
Small	Small	III																																											
Small	Large	IV																																											
Small	Small	IV																																											
Hand Railing	 <p>500</p> <p>3,000</p> <p>500</p>	Scaling/Spalling Breakage	<table border="1"> <thead> <tr> <th colspan="2">Scaling/Spalling</th> <th colspan="2">Breakage</th> </tr> <tr> <th>Y</th> <th>Z</th> <th>Main Member</th> <th>Secondary Member</th> </tr> </thead> <tbody> <tr> <td>Large</td> <td>Small</td> <td>II</td> <td>II</td> </tr> <tr> <td>Small</td> <td>Large</td> <td>IV</td> <td>IV</td> </tr> <tr> <td>Small</td> <td>Small</td> <td>IV</td> <td>IV</td> </tr> </tbody> </table> <p>Damage was observed, the degree must be recorded.</p> <table border="1"> <thead> <tr> <th colspan="2">Breakage</th> <th colspan="2">All Members</th> </tr> <tr> <th>Y</th> <th>Z</th> <th>Large</th> <th>Small</th> </tr> </thead> <tbody> <tr> <td>Large</td> <td>Small</td> <td>IV</td> <td>IV</td> </tr> <tr> <td>Small</td> <td>Large</td> <td>IV</td> <td>IV</td> </tr> <tr> <td>Small</td> <td>Small</td> <td>IV</td> <td>IV</td> </tr> </tbody> </table> <p>Degree of damage is large, so that rehabilitation must be needed.</p>	Scaling/Spalling		Breakage		Y	Z	Main Member	Secondary Member	Large	Small	II	II	Small	Large	IV	IV	Small	Small	IV	IV	Breakage		All Members		Y	Z	Large	Small	Large	Small	IV	IV	Small	Large	IV	IV	Small	Small	IV	IV	Scaling/Spalling IV Breakage II	 <p>Scaling/Spalling Breakage</p>
		Scaling/Spalling		Breakage																																									
Y	Z	Main Member	Secondary Member																																										
Large	Small	II	II																																										
Small	Large	IV	IV																																										
Small	Small	IV	IV																																										
Breakage		All Members																																											
Y	Z	Large	Small																																										
Large	Small	IV	IV																																										
Small	Large	IV	IV																																										
Small	Small	IV	IV																																										
Scaling/Spalling Breakage	<table border="1"> <thead> <tr> <th colspan="2">Scaling/Spalling</th> <th colspan="2">Breakage</th> </tr> <tr> <th>Y</th> <th>Z</th> <th>Main Member</th> <th>Secondary Member</th> </tr> </thead> <tbody> <tr> <td>Large</td> <td>Small</td> <td>II</td> <td>II</td> </tr> <tr> <td>Small</td> <td>Large</td> <td>IV</td> <td>IV</td> </tr> <tr> <td>Small</td> <td>Small</td> <td>IV</td> <td>IV</td> </tr> </tbody> </table> <p>Damage was observed, the degree must be recorded.</p> <table border="1"> <thead> <tr> <th colspan="2">Breakage</th> <th colspan="2">All Members</th> </tr> <tr> <th>Y</th> <th>Z</th> <th>Large</th> <th>Small</th> </tr> </thead> <tbody> <tr> <td>Large</td> <td>Small</td> <td>IV</td> <td>IV</td> </tr> <tr> <td>Small</td> <td>Large</td> <td>IV</td> <td>IV</td> </tr> <tr> <td>Small</td> <td>Small</td> <td>IV</td> <td>IV</td> </tr> </tbody> </table> <p>Degree of damage is large, so that rehabilitation must be needed.</p>	Scaling/Spalling		Breakage		Y	Z	Main Member	Secondary Member	Large	Small	II	II	Small	Large	IV	IV	Small	Small	IV	IV	Breakage		All Members		Y	Z	Large	Small	Large	Small	IV	IV	Small	Large	IV	IV	Small	Small	IV	IV	Scaling/Spalling IV Breakage II			
Scaling/Spalling		Breakage																																											
Y	Z	Main Member	Secondary Member																																										
Large	Small	II	II																																										
Small	Large	IV	IV																																										
Small	Small	IV	IV																																										
Breakage		All Members																																											
Y	Z	Large	Small																																										
Large	Small	IV	IV																																										
Small	Large	IV	IV																																										
Small	Small	IV	IV																																										

(9) LOS CARDOS

BRIDGE NUMBER	YEAR OF BUILT	NOTE	
BRIDGE NAME	BRIDGE LENGTH	_____	
REGION	BRIDGE WIDTH	_____	
ROUTE NAME	TRAFFIC VOLUME	_____	

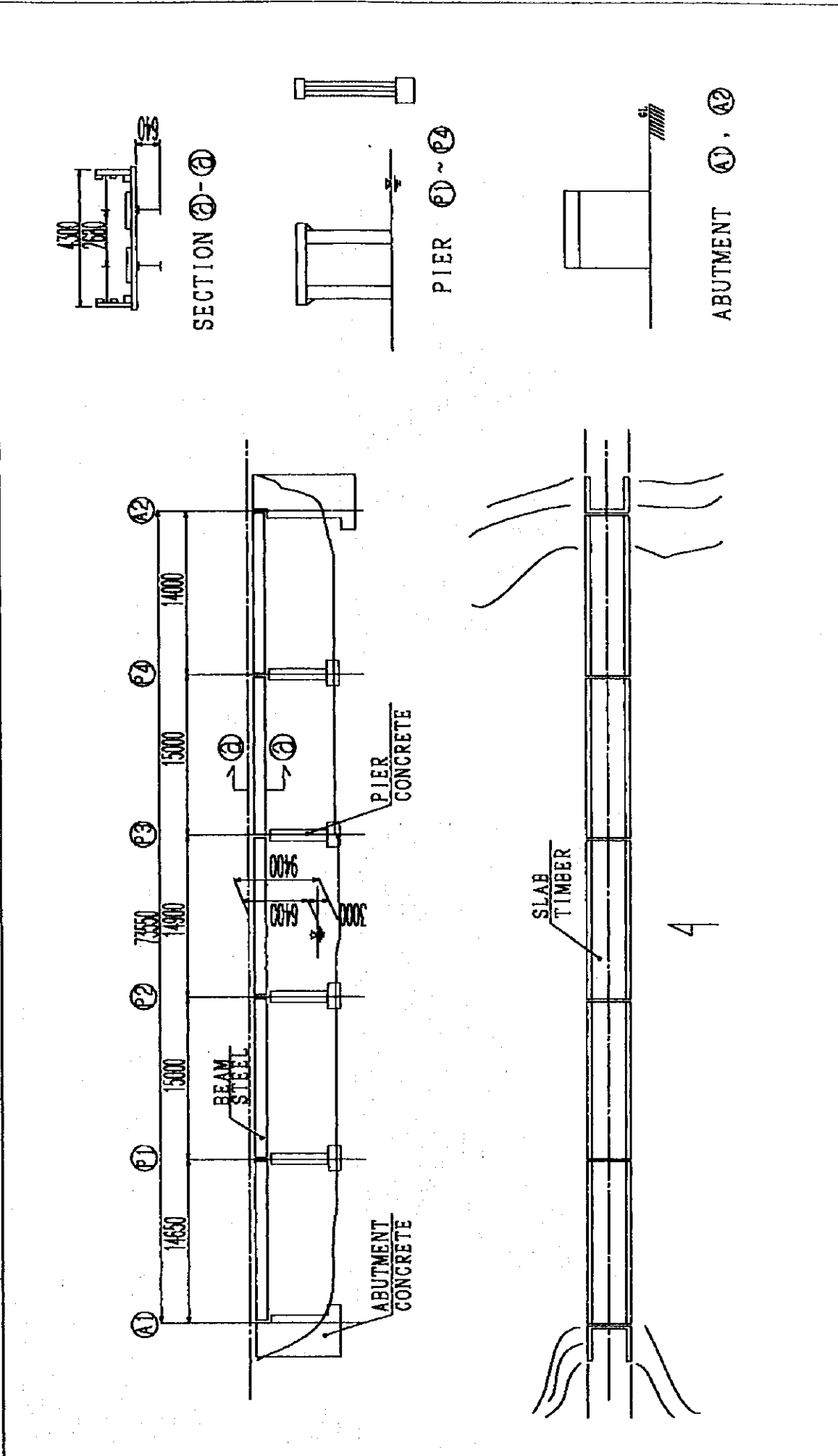

BRIDGE NO.20 BRIDGE NAME: LOS CARDOS

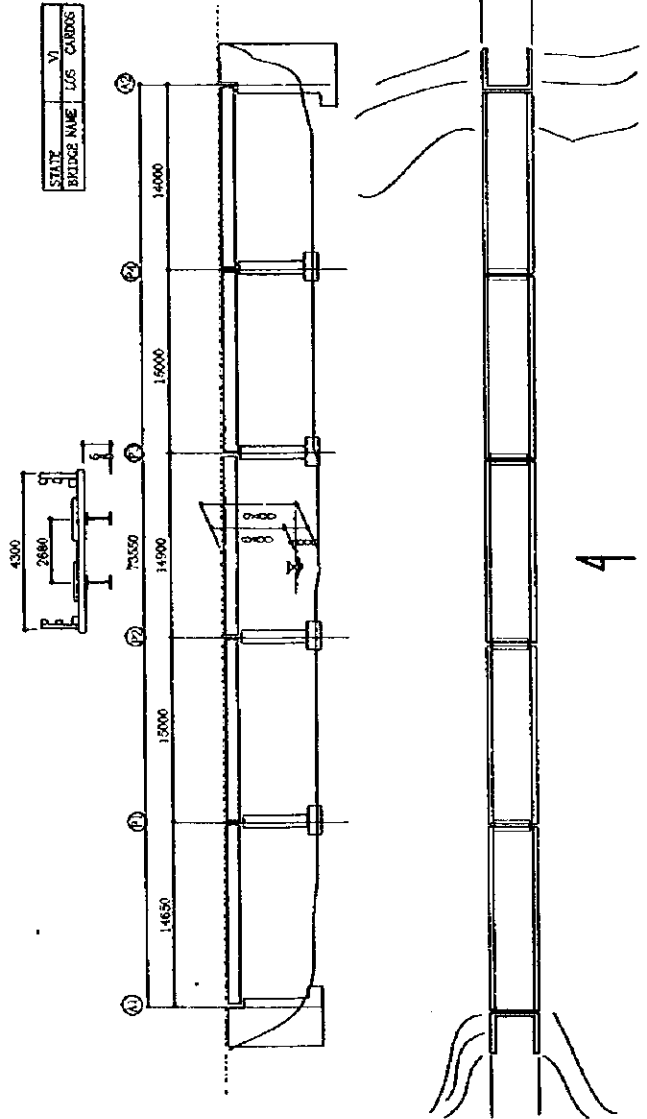

B. DAMAGE RANK AND DECISION ON REHABILITATION

(1) Concrete Materials

Bridge Component	Location of Damage	Damage	Evaluation of Damage	Damage Rank	Picture												
A2 Abutment		Scaling/Spalling	<table border="1" style="margin-bottom: 5px;"> <tr> <td>Y</td> <td>Z</td> <td>Main Member</td> <td>Secondary Member</td> </tr> <tr> <td>Large</td> <td>II</td> <td>II</td> <td>II</td> </tr> <tr> <td>Small</td> <td>IV</td> <td>IV</td> <td>IV</td> </tr> </table> <p>Damage was observed, but rehabilitation is not needed. Follow-up inspection must be executed.</p>	Y	Z	Main Member	Secondary Member	Large	II	II	II	Small	IV	IV	IV	III	
	Y	Z	Main Member	Secondary Member													
	Large	II	II	II													
Small	IV	IV	IV														
Efflorescence	Efflorescence	<table border="1" style="margin-bottom: 5px;"> <tr> <td>Z</td> <td>Main Member</td> <td>Secondary Member</td> </tr> <tr> <td>Large</td> <td>III</td> <td>II</td> </tr> <tr> <td>Small</td> <td>IV</td> <td>IV</td> </tr> </table> <p>Degree of damage is large, so that rehabilitation must be needed.</p>	Z	Main Member	Secondary Member	Large	III	II	Small	IV	IV	II					
Z	Main Member	Secondary Member															
Large	III	II															
Small	IV	IV															
<p>Scaling/ Spalling Y: no exposed reinforcement bar Z: over 1.0m²</p> <p>Efflorescence Z: over 1.0m²</p> <p>Breakage Y: observed damage</p>	Breakage	<table border="1" style="margin-bottom: 5px;"> <tr> <td>Y</td> <td>All Members</td> </tr> <tr> <td>Large</td> <td>II</td> </tr> <tr> <td>Small</td> <td>IV</td> </tr> </table> <p>Damage was observed, the degree must be recorded.</p>	Y	All Members	Large	II	Small	IV	IV								
Y	All Members																
Large	II																
Small	IV																

Bridge Component	Location of Damage	Damage	Evaluation of Damage	Damage Rank	Picture																																			
<p>A1 Abutment</p> <p>Cracking X: main part Y < 0.2mm Z: over 50cm</p> <p>Efflorescence Z: less 1.0m²</p> <p>Breakage Y: observed damage</p>		<p>Cracking</p>	<table border="1"> <tr> <td>X</td> <td>Y</td> <td>Z</td> <td>Main Member</td> <td>Secondary Member</td> </tr> <tr> <td>Large</td> <td>Large</td> <td>Large</td> <td>I</td> <td>I</td> </tr> <tr> <td>Medium</td> <td>Medium</td> <td>Medium</td> <td>II</td> <td>II</td> </tr> <tr> <td>Small</td> <td>Small</td> <td>Small</td> <td>III</td> <td>III</td> </tr> <tr> <td></td> <td></td> <td></td> <td>IV</td> <td>IV</td> </tr> <tr> <td></td> <td></td> <td></td> <td>V</td> <td>V</td> </tr> <tr> <td></td> <td></td> <td></td> <td></td> <td>V</td> </tr> </table> <p>Condition is sound</p>	X	Y	Z	Main Member	Secondary Member	Large	Large	Large	I	I	Medium	Medium	Medium	II	II	Small	Small	Small	III	III				IV	IV				V	V					V	<p>V</p>	
X	Y	Z	Main Member	Secondary Member																																				
Large	Large	Large	I	I																																				
Medium	Medium	Medium	II	II																																				
Small	Small	Small	III	III																																				
			IV	IV																																				
			V	V																																				
				V																																				
		<p>Efflorescence</p>	<table border="1"> <tr> <td>Z</td> <td>Main Member</td> <td>Secondary Member</td> </tr> <tr> <td>Large</td> <td>II</td> <td>II</td> </tr> <tr> <td>Small</td> <td></td> <td>IV</td> </tr> </table> <p>Damage was observed, but rehabilitation is not needed. Follow-up inspection must be executed.</p>	Z	Main Member	Secondary Member	Large	II	II	Small		IV	<p>III</p>																											
Z	Main Member	Secondary Member																																						
Large	II	II																																						
Small		IV																																						
		<p>Breakage</p>	<table border="1"> <tr> <td>Y</td> <td>All Members</td> </tr> <tr> <td>Large</td> <td>II</td> </tr> <tr> <td>Small</td> <td></td> </tr> </table> <p>Damage was observed, the rank must be recorded.</p>	Y	All Members	Large	II	Small		<p>IV</p>																														
Y	All Members																																							
Large	II																																							
Small																																								

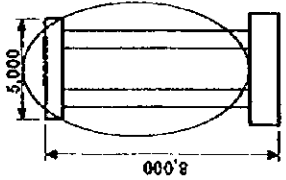
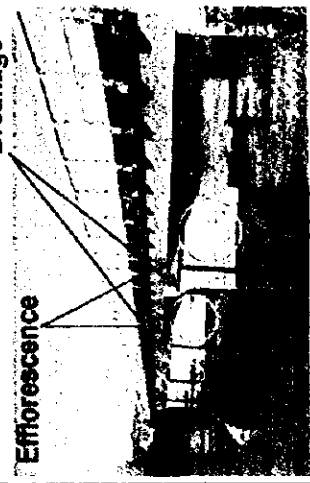
Bridge Component	Location of Damage	Damage	Evaluation of Damage	Damage Rank	Picture
		Cracking	Cracking was observed, the rank was not justified because of inspection by distant view	No rank	
P1~P4 Pier		Efflorescence	Efflorescence was observed, the rank was not justified because of inspection by distant view	No rank	
		Breakage	Cracking was observed, the rank was not justified because of inspection by distant view	No rank	

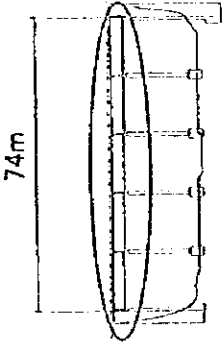
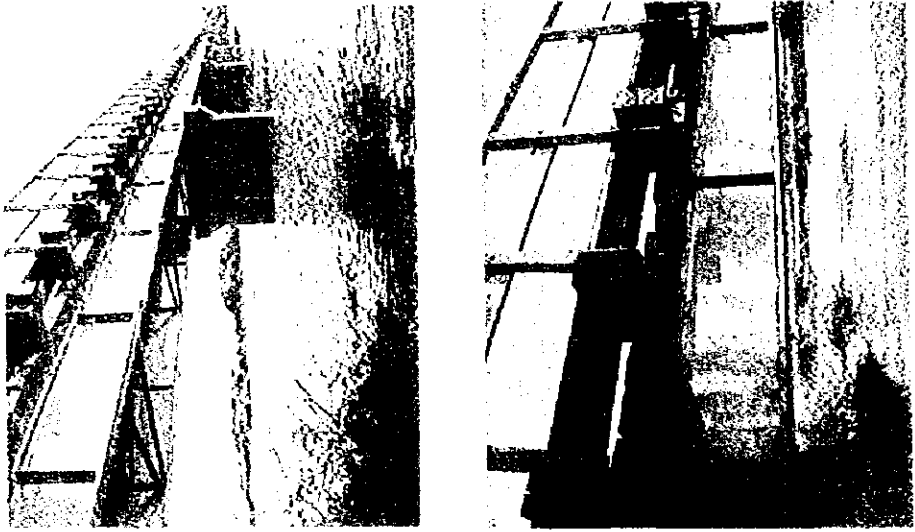
Los Cardos																		
(2) Steel Marerials	Location of Damage	Damage	Evaluation of Damage															
Bridge Compone Beam	 <p>74m</p>	Aging of Coat	<table border="1" data-bbox="660 1021 858 1339"> <tr> <td>Y</td> <td>Z</td> <td>All Members</td> </tr> <tr> <td>Large</td> <td>Large</td> <td>III</td> </tr> <tr> <td>Small</td> <td>Small</td> <td>IV</td> </tr> <tr> <td>Large</td> <td>Large</td> <td>IV</td> </tr> <tr> <td>Small</td> <td>Small</td> <td>OK</td> </tr> </table> <p>Y : Means Depth Z : Means Width No need repairing</p>	Y	Z	All Members	Large	Large	III	Small	Small	IV	Large	Large	IV	Small	Small	OK
Y	Z	All Members																
Large	Large	III																
Small	Small	IV																
Large	Large	IV																
Small	Small	OK																
		Damage Rank V	Picture 															

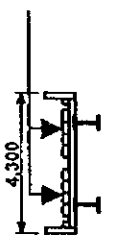
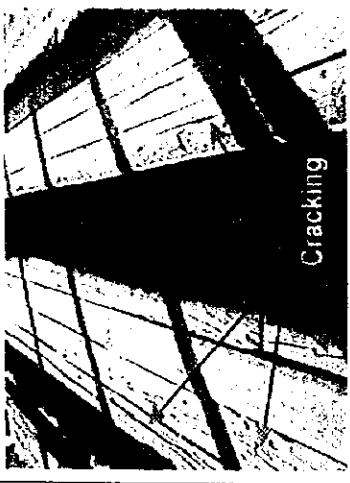
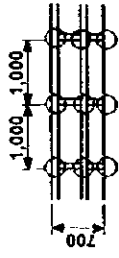
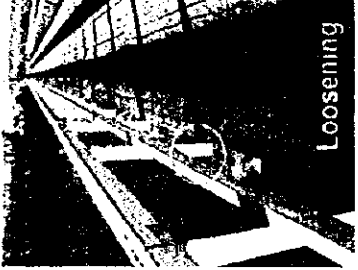
(3) Timber Materials		Bridge Component	Location of Damage	Damage	Evaluation of Damage	Damage Rank	Picture														
Slab1 ~ Slabe5	 <p>X: main part Y: small (observed)</p>	Cracking	<table border="1" data-bbox="438 873 558 1131"> <tr> <td>X</td> <td>Y</td> <td>Main Member</td> <td>Secondary Member</td> </tr> <tr> <td>Large</td> <td>Large</td> <td>II</td> <td>III</td> </tr> <tr> <td>Small</td> <td>Large</td> <td>III</td> <td>IV</td> </tr> <tr> <td></td> <td>Small</td> <td>IV</td> <td>IV</td> </tr> </table> <p>Damage was observed, but rehabilitation is not needed. Follow-up inspection must be executed.</p>	X	Y	Main Member	Secondary Member	Large	Large	II	III	Small	Large	III	IV		Small	IV	IV	III	 <p>Cracking</p>
X	Y	Main Member	Secondary Member																		
Large	Large	II	III																		
Small	Large	III	IV																		
	Small	IV	IV																		
Hand Railing	 <p>Z: whole connections and excessive loosening</p>	Loosening	<table border="1" data-bbox="813 873 925 1131"> <tr> <td>Z</td> <td>All Members</td> </tr> <tr> <td>Large</td> <td></td> </tr> <tr> <td>Small</td> <td>IV</td> </tr> </table> <p>Damage was observed, the degree must be recorded.</p>	Z	All Members	Large		Small	IV	II	 <p>Loosening</p>										
Z	All Members																				
Large																					
Small	IV																				

(2) Steel Marerials

Los Cardos

Bridge Component	Location of Damage	Damage	Evaluation of Damage	Damage Rank	Picture															
Beam		Aging of Coat	<table border="1" data-bbox="643 1016 836 1323"> <tr> <td>Y</td> <td>Z</td> <td>All Members</td> </tr> <tr> <td>Large</td> <td>Large</td> <td>III</td> </tr> <tr> <td>Small</td> <td>Small</td> <td>IV</td> </tr> <tr> <td></td> <td>Large</td> <td>IV</td> </tr> <tr> <td></td> <td>Small</td> <td>OK</td> </tr> </table> <p data-bbox="871 1117 991 1323"> Y : Means Depth Z : Means Width No need repairing </p>	Y	Z	All Members	Large	Large	III	Small	Small	IV		Large	IV		Small	OK	V	
Y	Z	All Members																		
Large	Large	III																		
Small	Small	IV																		
	Large	IV																		
	Small	OK																		