

THE STUDY ON ADDIS ABABA FLOOD CONTROL PROJECT IN THE FEDERAL DEMOCRATIC REPUBLIC OF ETHIOPIA	
JAPAN INTERNATIONAL COOPERATION AGENCY REGION 14 ADMINISTRATION	
DRAWING NO. WAK-PLAN-04	

No.88,98

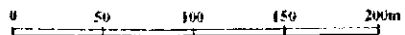
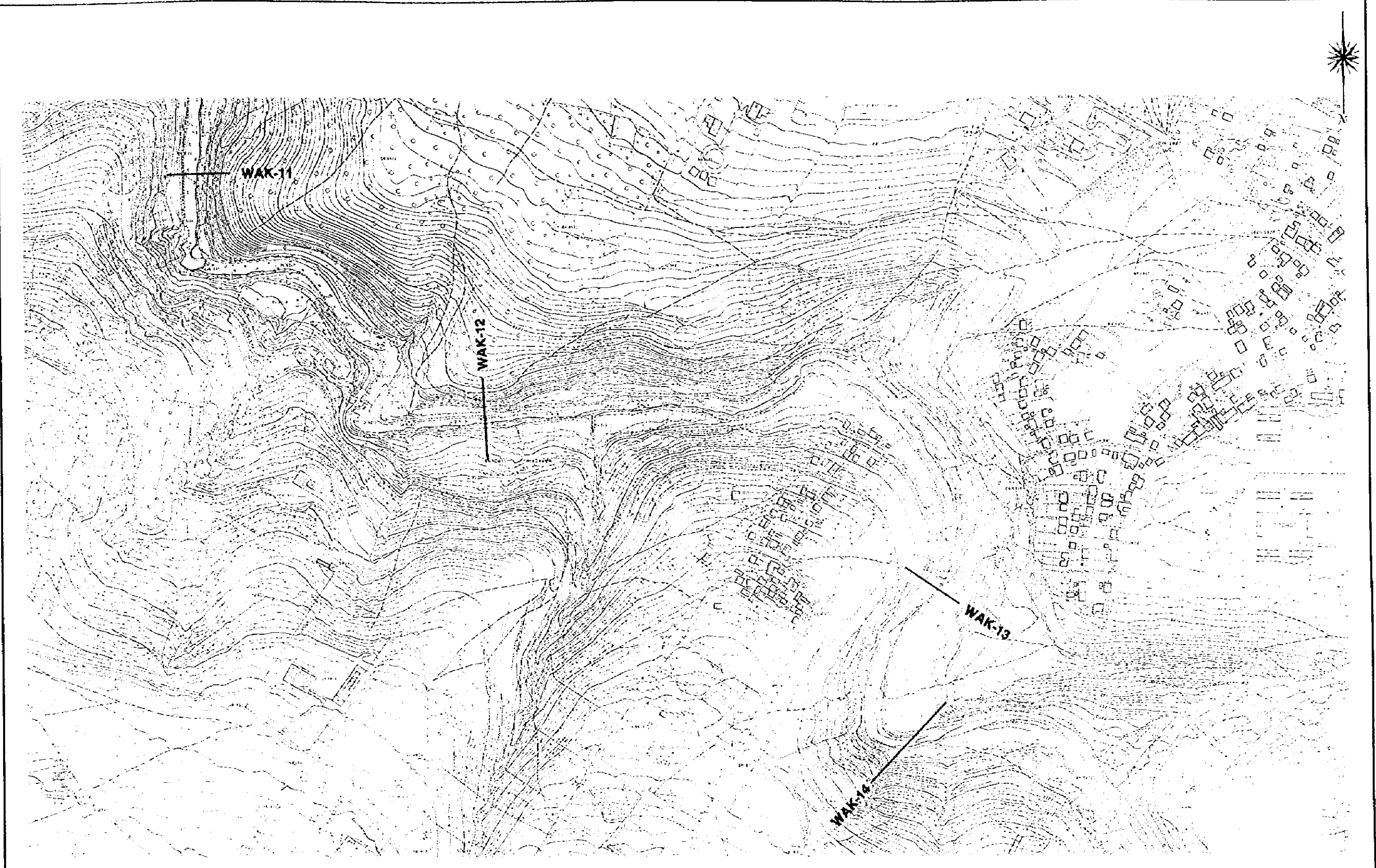

THE STUDY ON ADDIS ABABA FLOOD CONTROL PROJECT
IN THE FEDERAL DEMOCRATIC REPUBLIC OF ETHIOPIA

JAPAN INTERNATIONAL COOPERATION AGENCY
REGION 14 ADMINISTRATION

DRAWING NO.
WAK-PLAN-05

No.87.88

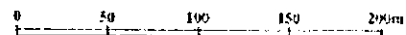
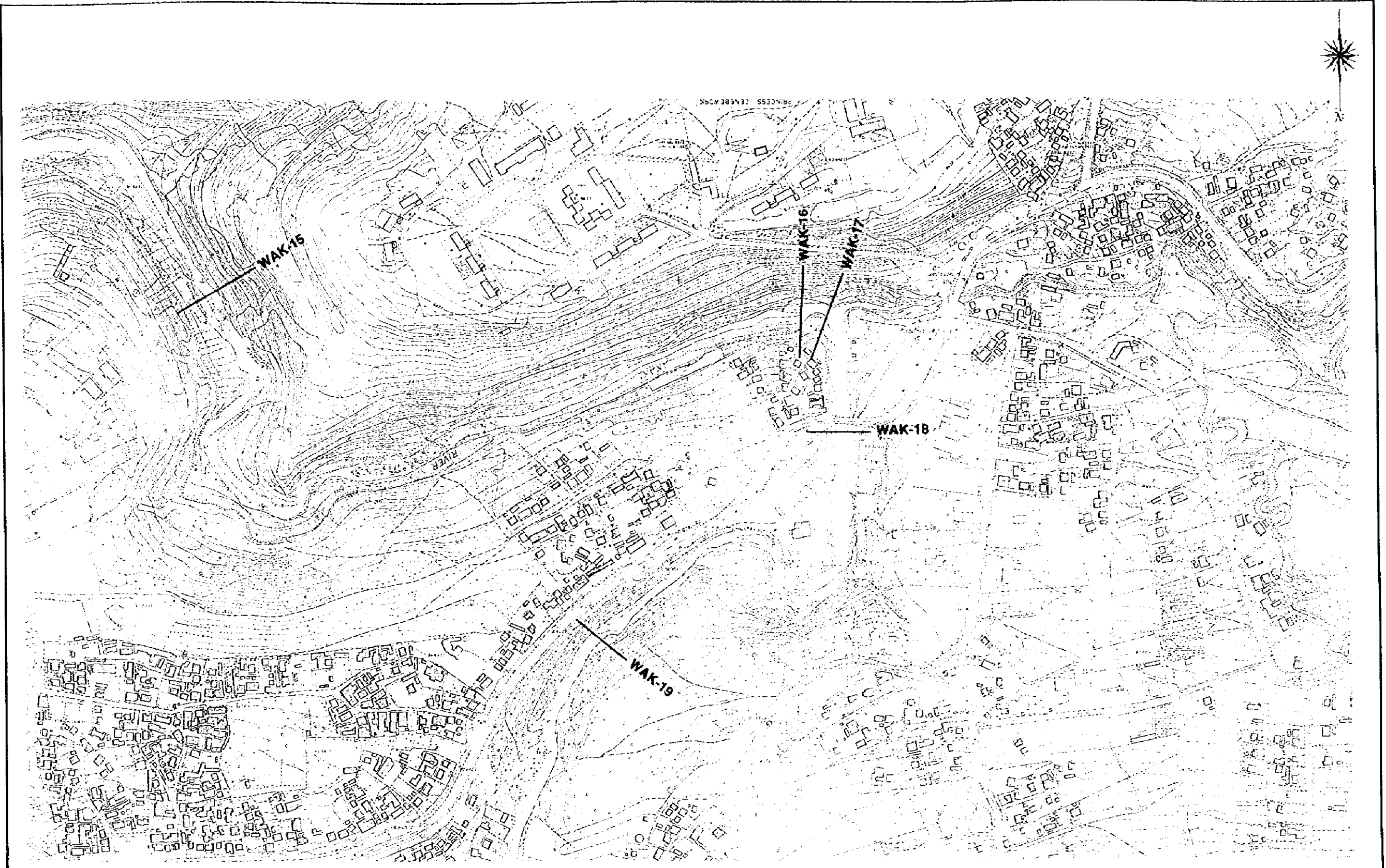

THE STUDY ON ADDIS ABABA FLOOD CONTROL PROJECT
IN THE FEDERAL DEMOCRATIC REPUBLIC OF ETHIOPIA

JAPAN INTERNATIONAL COOPERATION AGENCY
REGION 14 ADMINISTRATION

DRAWING NO.	
WAK-PLAN-06	

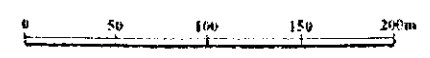
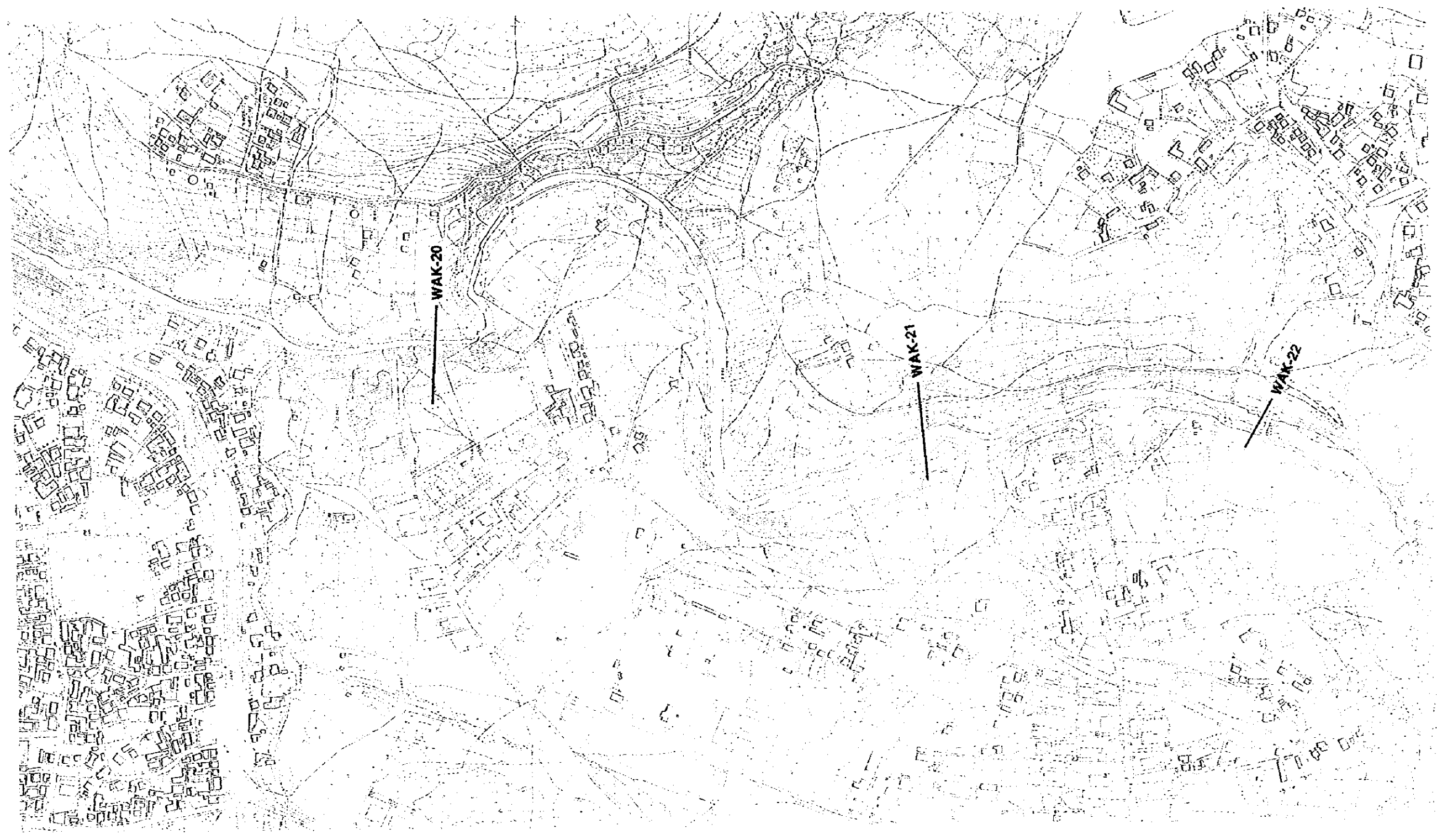

THE STUDY ON ADDIS ABABA FLOOD CONTROL PROJECT IN THE FEDERAL DEMOCRATIC REPUBLIC OF ETHIOPIA	
JAPAN INTERNATIONAL COOPERATION AGENCY REGION 14 ADMINISTRATION	
DRAWING NO.	
WAK-PLAN-07	

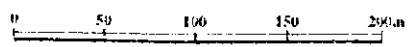
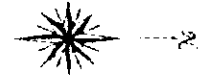

THE STUDY ON ADDIS ABABA FLOOD CONTROL PROJECT
IN THE FEDERAL DEMOCRATIC REPUBLIC OF ETHIOPIA

JAPAN INTERNATIONAL COOPERATION AGENCY
REGION 14 ADMINISTRATION

DRAWING NO.
WAK-PLAN-08



THE STUDY ON ADDIS ABABA FLOOD CONTROL PROJECT
IN THE FEDERAL DEMOCRATIC REPUBLIC OF ETHIOPIA

JAPAN INTERNATIONAL COOPERATION AGENCY
REGION 14 ADMINISTRATION

DRAWING NO.	
WAK-PLAN-09	

Cross Section S=1:200

WAK-00



WAK-01

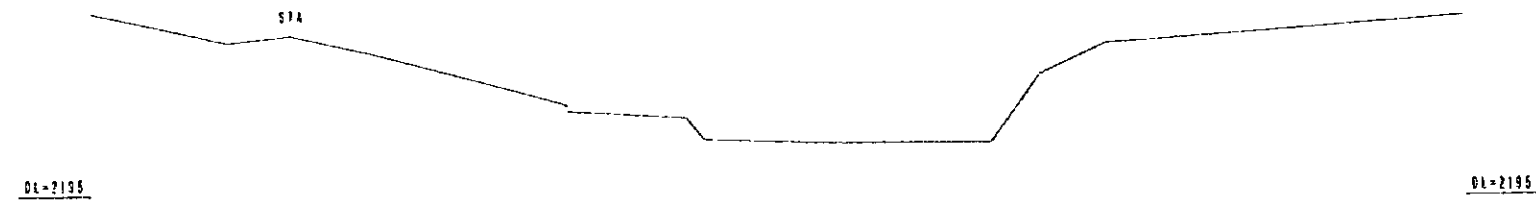

WAK-09



THE STUDY ON ADDIS ABABA FLOOD CONTROL PROJECT IN THE FEDERAL DEMOCRATIC REPUBLIC OF ETHIOPIA	
JAPAN INTERNATIONAL COOPERATION AGENCY REGIONal ADMINISTRATION	
DRAWING NO. WAK-SECT-01	LOCATION OF RIVER CROSS SECTION WEST AKAKI (WAK) RIVER (01/11)

Cross Section S=1:200

WAK-03

STA

DL-2200

DL-2200

WAK-04

STA

DL-2200

DL-2200

WAK-05

STA

DL-2205

DL-2205

THE STUDY ON ADDIS ABABA FLOOD CONTROL PROJECT
IN THE FEDERAL DEMOCRATIC REPUBLIC OF ETHIOPIA

JAPAN INTERNATIONAL COOPERATION AGENCY

REGION 14 ADMINISTRATION

DRAWING NO.
WAK-SECT-02

LOCATION OF RIVER CROSS SECTION
WEST AKAKI (WAK) RIVER (02/11)

Cross Section S=1:200

WAK-06

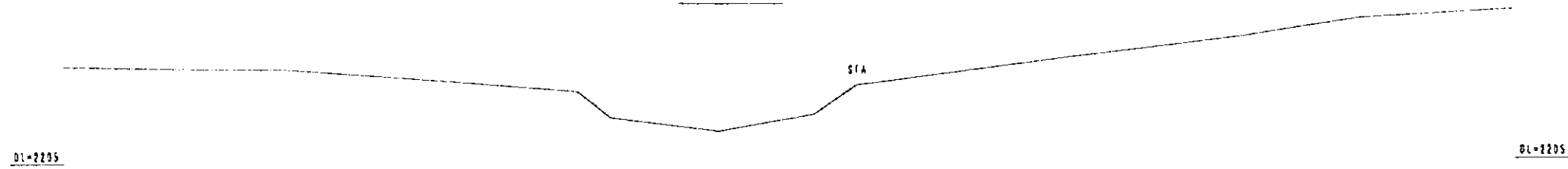

WAK-07

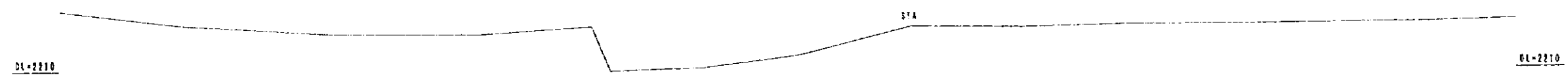

WAK-08

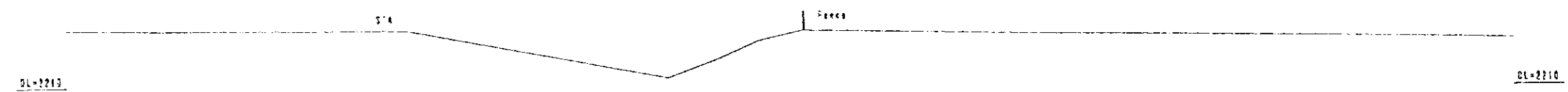

THE STUDY ON ADDIS ABABA FLOOD CONTROL PROJECT IN THE FEDERAL DEMOCRATIC REPUBLIC OF ETHIOPIA	
JAPAN INTERNATIONAL COOPERATION AGENCY REGION 14 ADMINISTRATION	
DRAWING NO. WAK-SECT-03	LOCATION OF RIVER CROSS SECTION WEST AKAKI (WAK) RIVER (03/11)

Cross Section S=1:200

WAK-09

DL-2210

DL-2219

WAK-10

DL-2215

DL-2215

WAK-11

DL-2215

DL-2215

THE STUDY ON ADDIS ABABA FLOOD CONTROL PROJECT IN THE FEDERAL DEMOCRATIC REPUBLIC OF ETHIOPIA	
JAPAN INTERNATIONAL COOPERATION AGENCY REGION 14 ADMINISTRATION	
DRAWING NO. WAK-SECT-04	LOCATION OF RIVER CROSS SECTION WEST AKAKI (WAK) RIVER (04/13)

Cross Section S=1:200

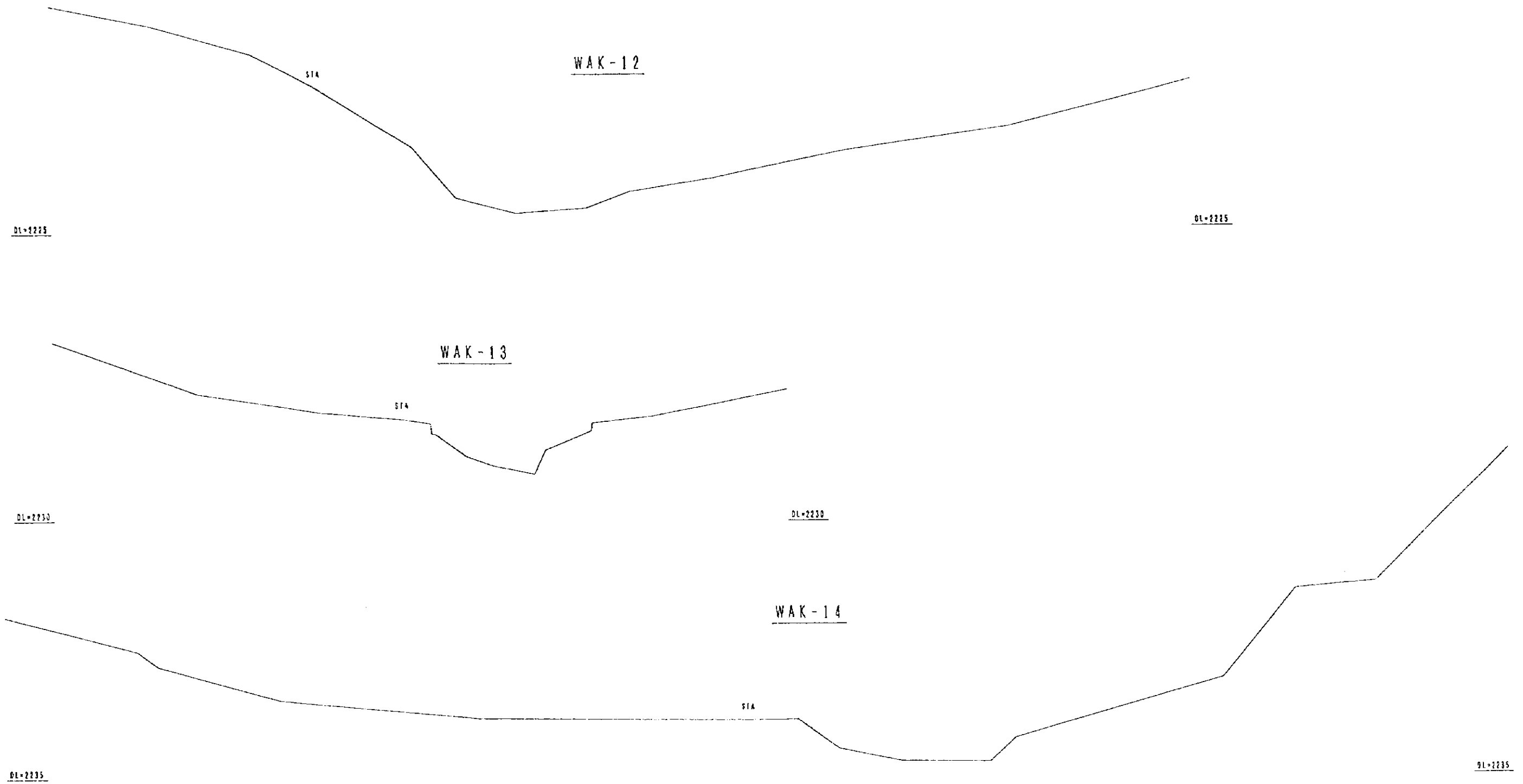

THE STUDY ON ADDIS ABABA FLOOD CONTROL PROJECT IN THE FEDERAL DEMOCRATIC REPUBLIC OF ETHIOPIA	
JAPAN INTERNATIONAL COOPERATION AGENCY REGION 14 ADMINISTRATION	
DRAWING NO. WAK-SECT-05	LOCATION OF RIVER CROSS SECTION WEST AKAKI (WAK) RIVER (05/11)

Cross Section S=1:200

WAK-15

514

DL-2240

DL-2240

WAK-16

DL-2250

DL-2250

THE STUDY ON ADDIS ABABA FLOOD CONTROL PROJECT
IN THE FEDERAL DEMOCRATIC REPUBLIC OF ETHIOPIA

JAPAN INTERNATIONAL COOPERATION AGENCY
REGION 14 ADMINISTRATION

DRAWING NO.
WAK-SECT-06

LOCATION OF RIVER CROSS SECTION
WEST AKAKI (WAK) RIVER (06/11)

Cross Section S=1:200

WAK-17

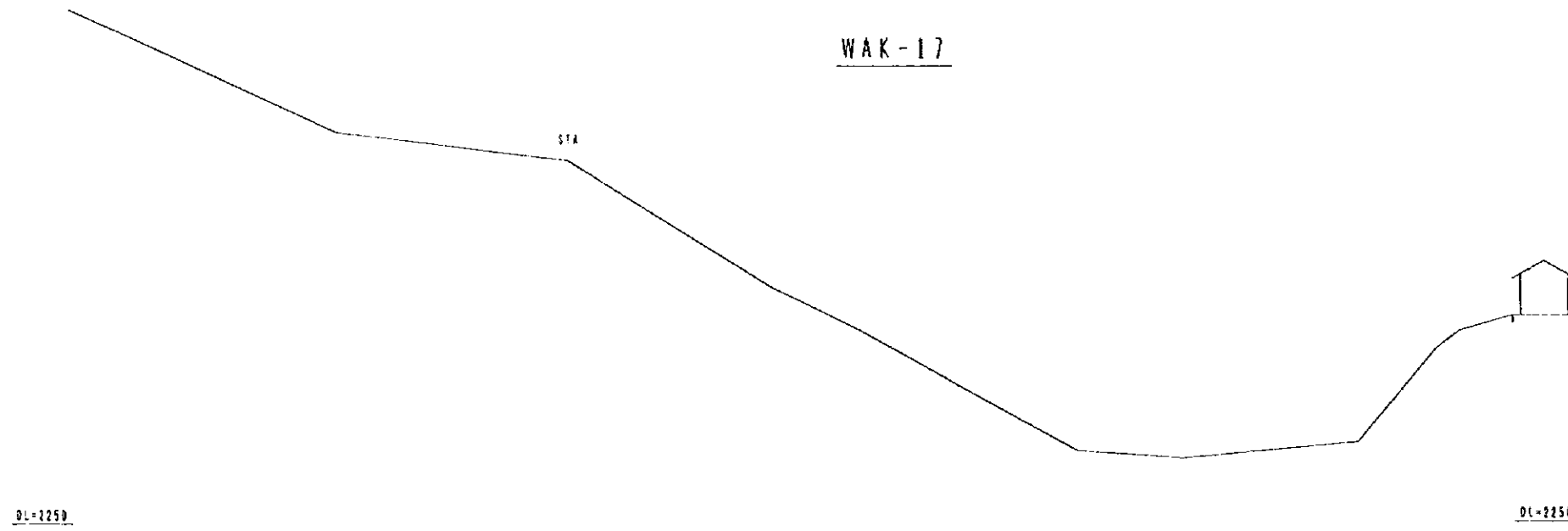

WAK-18

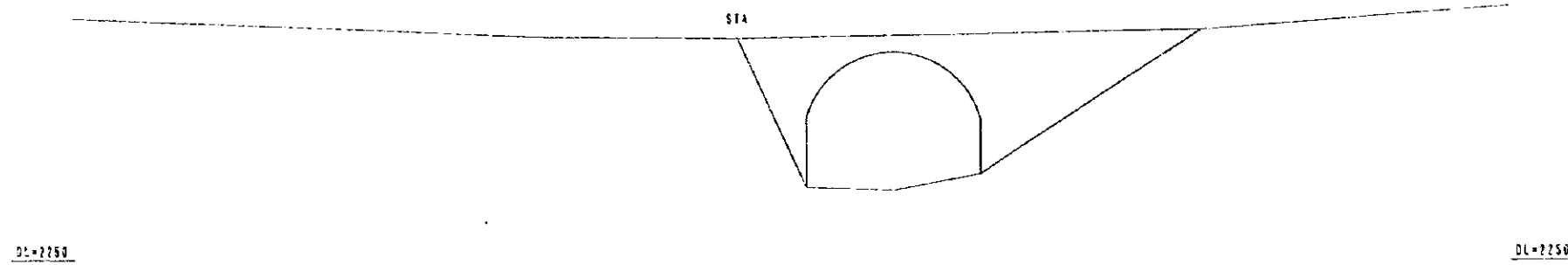

WAK-19



THE STUDY ON ADDIS ABABA FLOOD CONTROL PROJECT IN THE FEDERAL DEMOCRATIC REPUBLIC OF ETHIOPIA	
JAPAN INTERNATIONAL COOPERATION AGENCY REGION 14 ADMINISTRATION	
DRAWING NO. WAK-SECF-07	LOCATION OF RIVER CROSS SECTION WEST AKAKI (WAK) RIVER (07/11)

Cross Section S=1:200

WAK-20

STA

DL-2260

DL-2280

WAK-21

STA

DL-2265

DL-2265

WAK-22

STA

DL-2275

DL-2275

THE STUDY ON ADDIS ABABA FLOOD CONTROL PROJECT
IN THE FEDERAL DEMOCRATIC REPUBLIC OF ETHIOPIA

JAPAN INTERNATIONAL COOPERATION AGENCY

REGION 14 ADMINISTRATION

DRAWING NO.
WAK-SECT-08

LOCATION OF RIVER CROSS SECTION
WEST AKAKI (WAK) RIVER (08/11)

Cross Section S=1:200

WAK-23

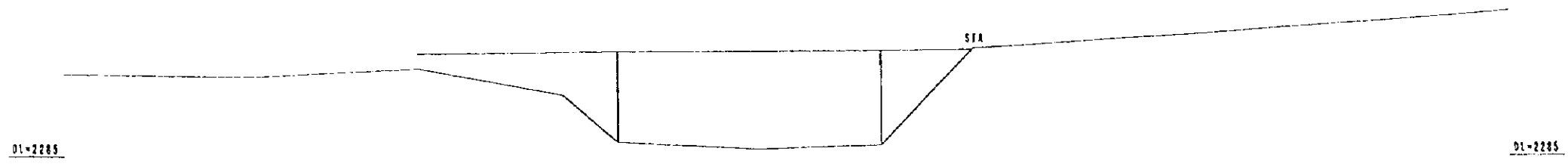

WAK-24

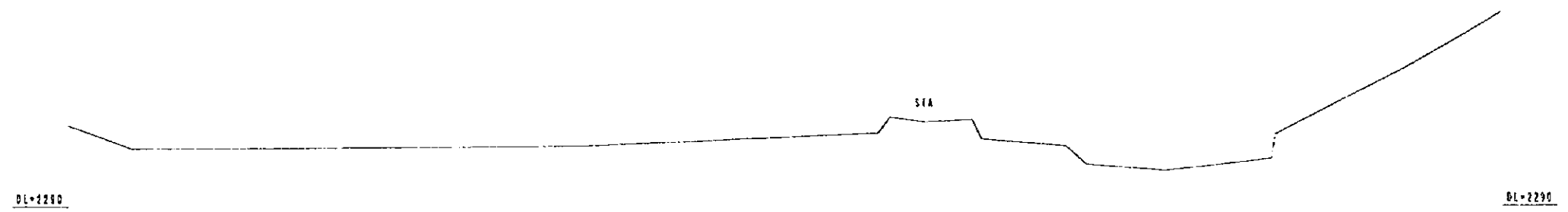

WAK-25

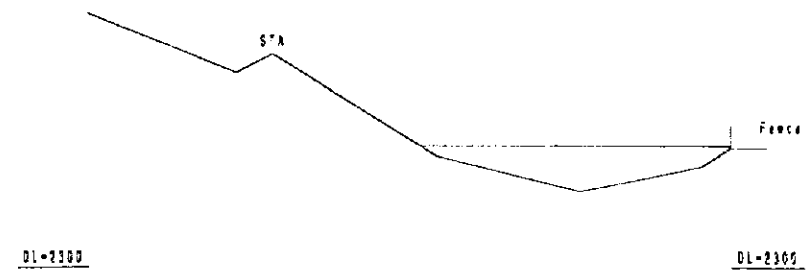

THE STUDY ON ADDIS ABABA FLOOD CONTROL PROJECT IN THE FEDERAL DEMOCRATIC REPUBLIC OF ETHIOPIA	
JAPAN INTERNATIONAL COOPERATION AGENCY REGION 14 ADMINISTRATION	
DRAWING NO. WAK-SECT-09	LOCATION OF RIVER CROSS SECTION WEST AKAKI (WAK) RIVER (09/11)

Cross Section S=1:200

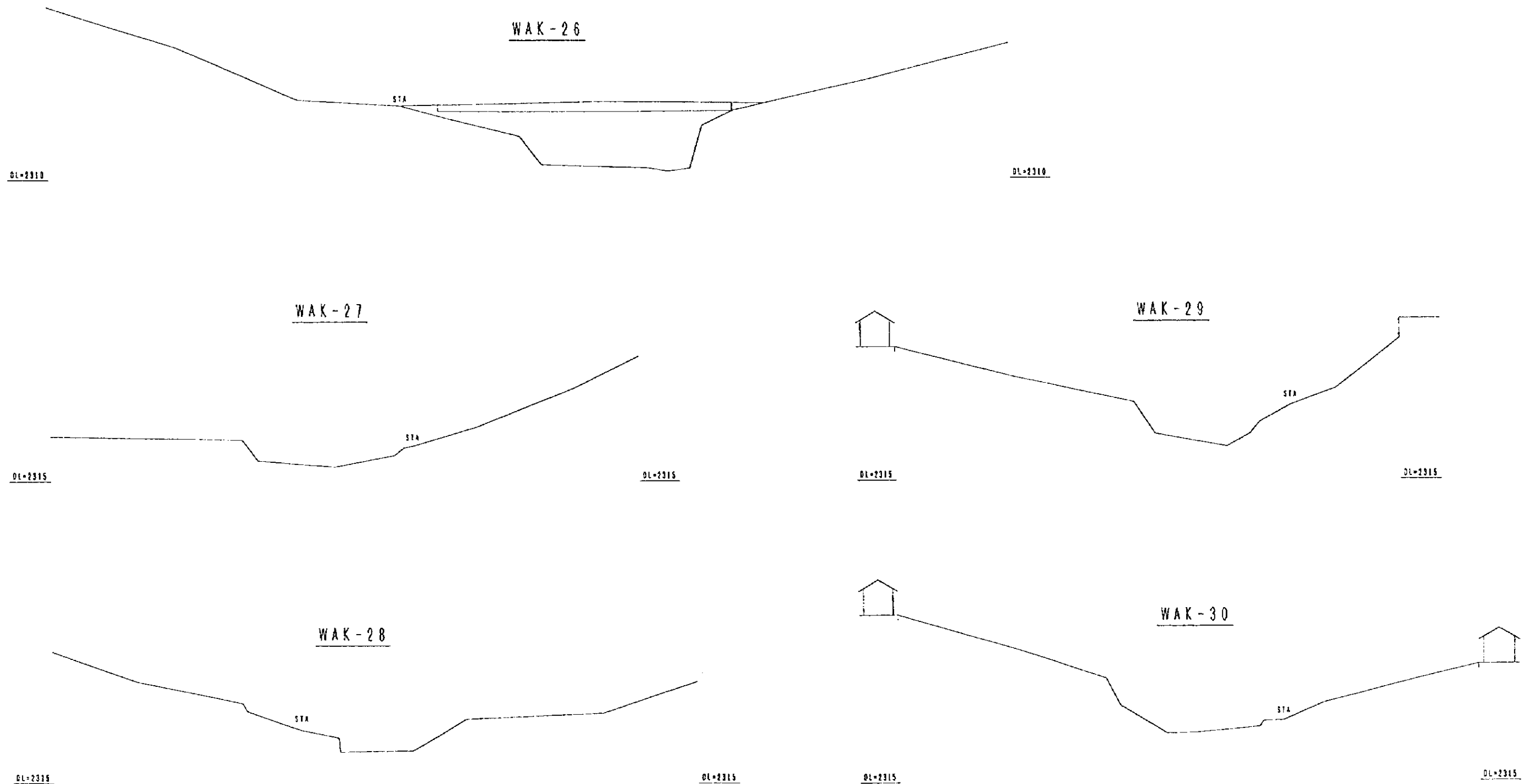

THE STUDY ON ADDIS ABABA FLOOD CONTROL PROJECT IN THE FEDERAL DEMOCRATIC REPUBLIC OF ETHIOPIA	
JAPAN INTERNATIONAL COOPERATION AGENCY REGION 14 ADMINISTRATION	
DRAWING NO. WAK-SECT-10	LOCATION OF RIVER CROSS SECTION WEST AKAKI (WAK) RIVER (10/11)

Cross Section S=1:200

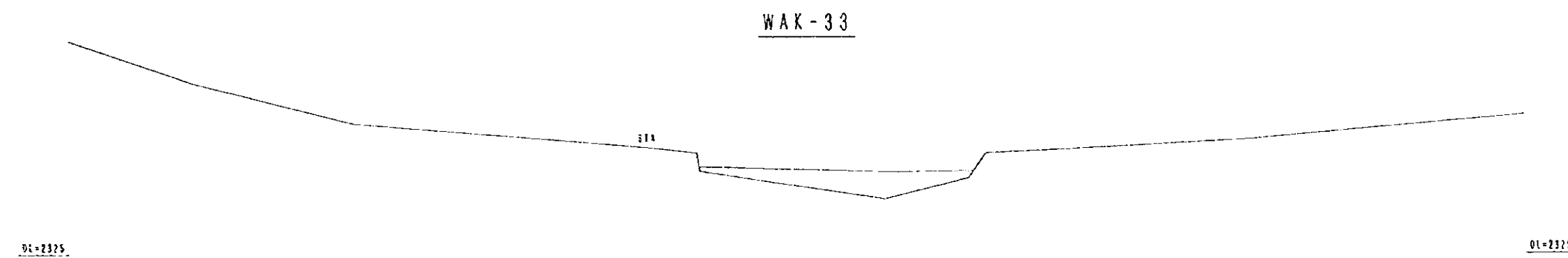
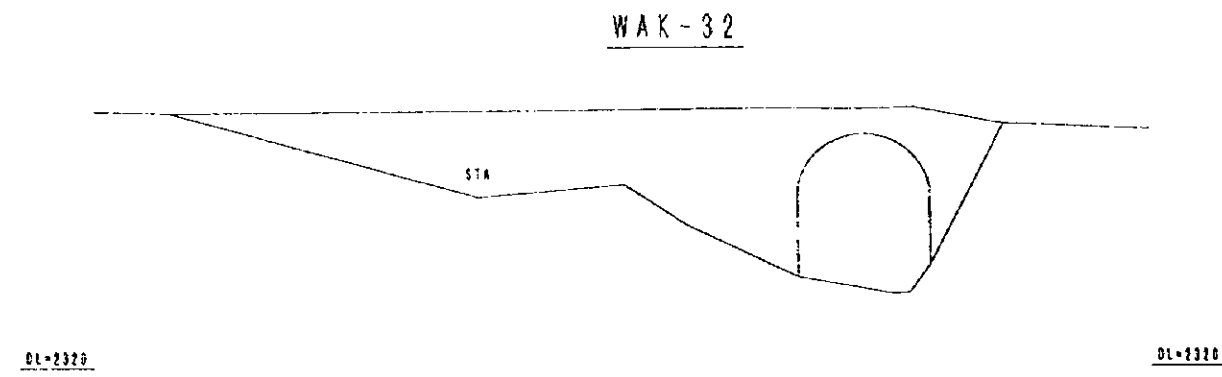
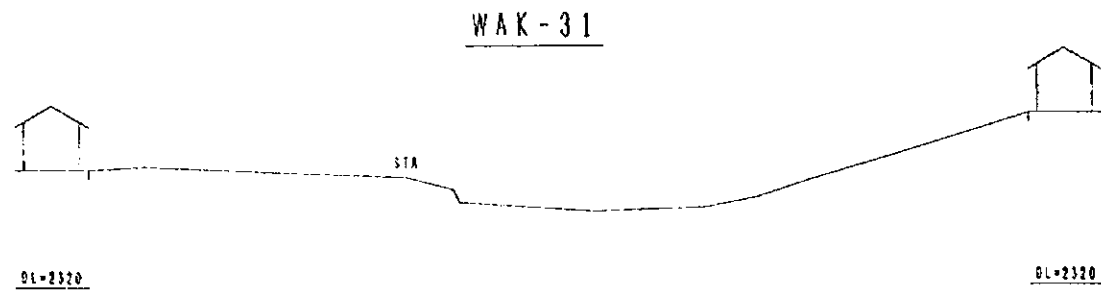

THE STUDY ON ADDIS ABABA FLOOD CONTROL PROJECT IN THE FEDERAL DEMOCRATIC REPUBLIC OF ETHIOPIA	
JAPAN INTERNATIONAL COOPERATION AGENCY REGION 14 ADMINISTRATION	
DRAWING NO. WAK-SECT-13	LOCATION OF RIVER CROSS SECTION WEST AKAKI (WAK) RIVER (13/13)

Profile Section V=1:500
H=1:20000

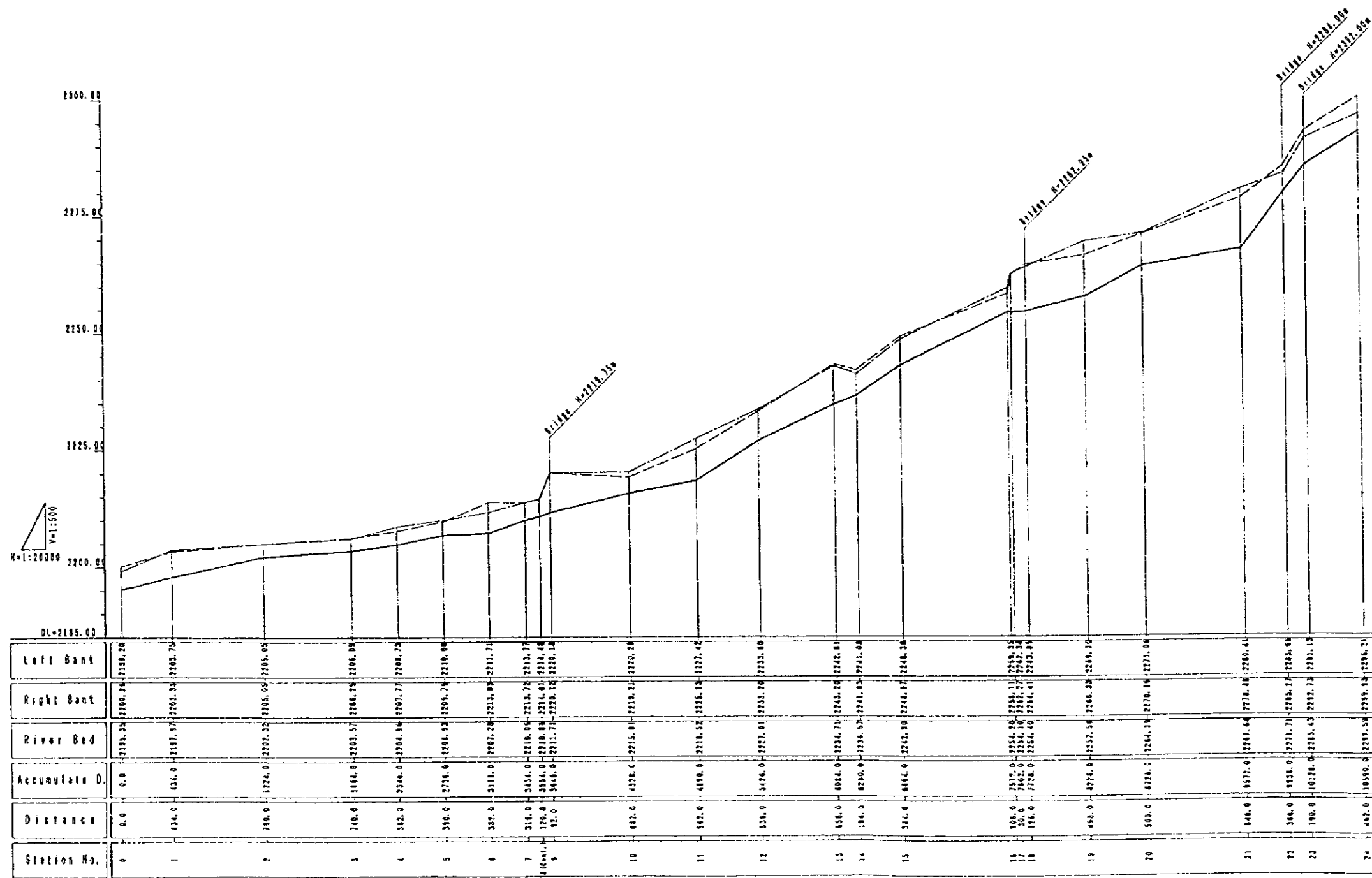

Left Bank	---
Right Bank	----
River Bed	—

THE STUDY ON ADDIS ABABA FLOOD CONTROL PROJECT IN THE FEDERAL DEMOCRATIC REPUBLIC OF ETHIOPIA	
JAPAN INTERNATIONAL COOPERATION AGENCY REGION 14 ADMINISTRATION	
DRAWING NO. WAK-SECT-01	LOCATION OF RIVER PROFILE SECTION WEST AKAKI (WAK) RIVER (01/02)

Profile Section V=1:500
H=1:20000

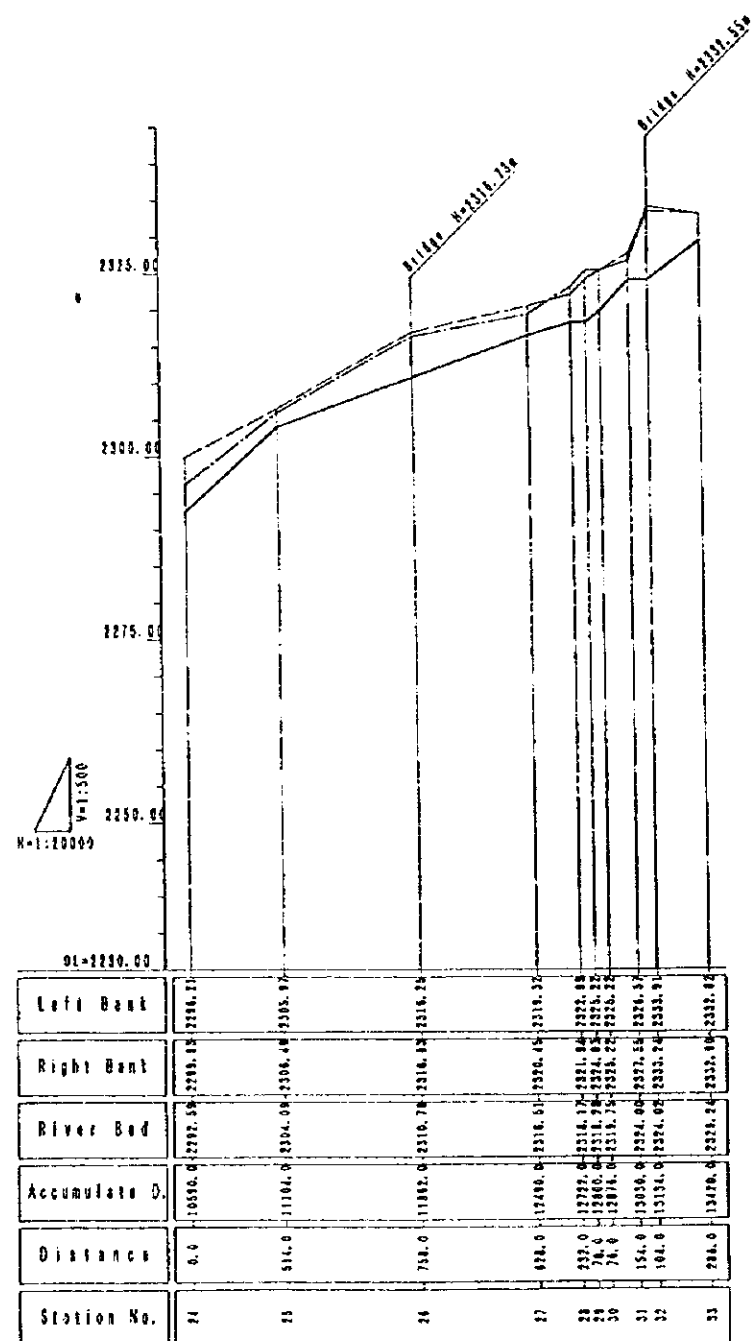

Left Bank	———
Right Bank	-----
River Bed	———

THE STUDY ON ADDIS ABABA FLOOD CONTROL PROJECT
IN THE FEDERAL DEMOCRATIC REPUBLIC OF ETHIOPIA

JAPAN INTERNATIONAL COOPERATION AGENCY
REGION 14 ADMINISTRATION

DRAWING NO. WAK-SECT-02	LOCATION OF RIVER PROFILE SECTION WEST AKAKI (WAK) RIVER (02/02)
----------------------------	---

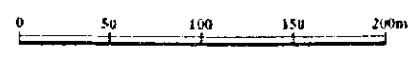
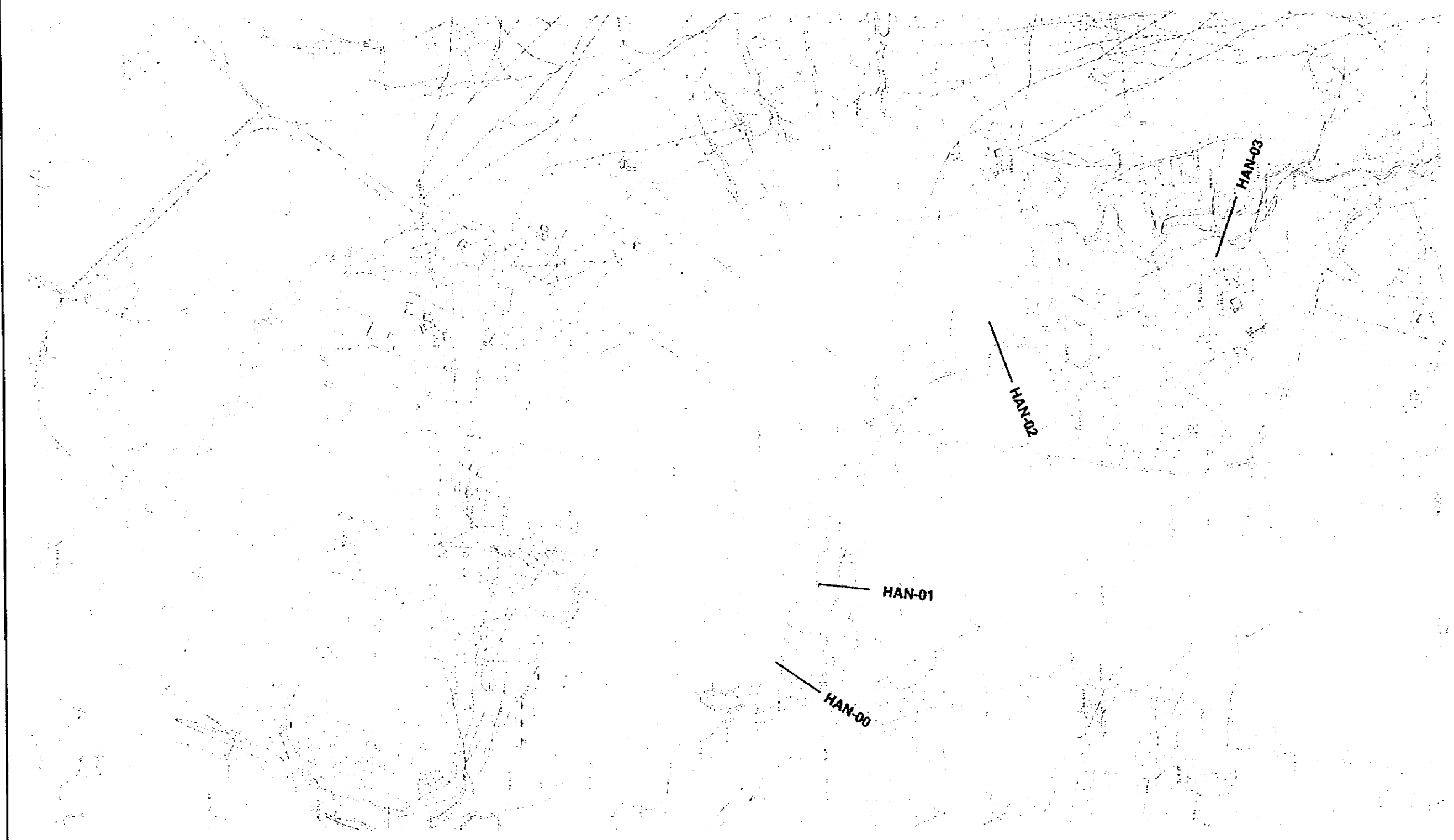

THE STUDY ON ADDIS ABABA FLOOD CONTROL PROJECT IN THE FEDERAL DEMOCRATIC REPUBLIC OF ETHIOPIA	
JAPAN INTERNATIONAL COOPERATION AGENCY REGION 14 ADMINISTRATION	
DRAWING NO. HAN-PLAN-01	

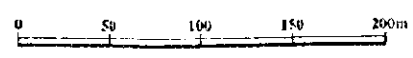
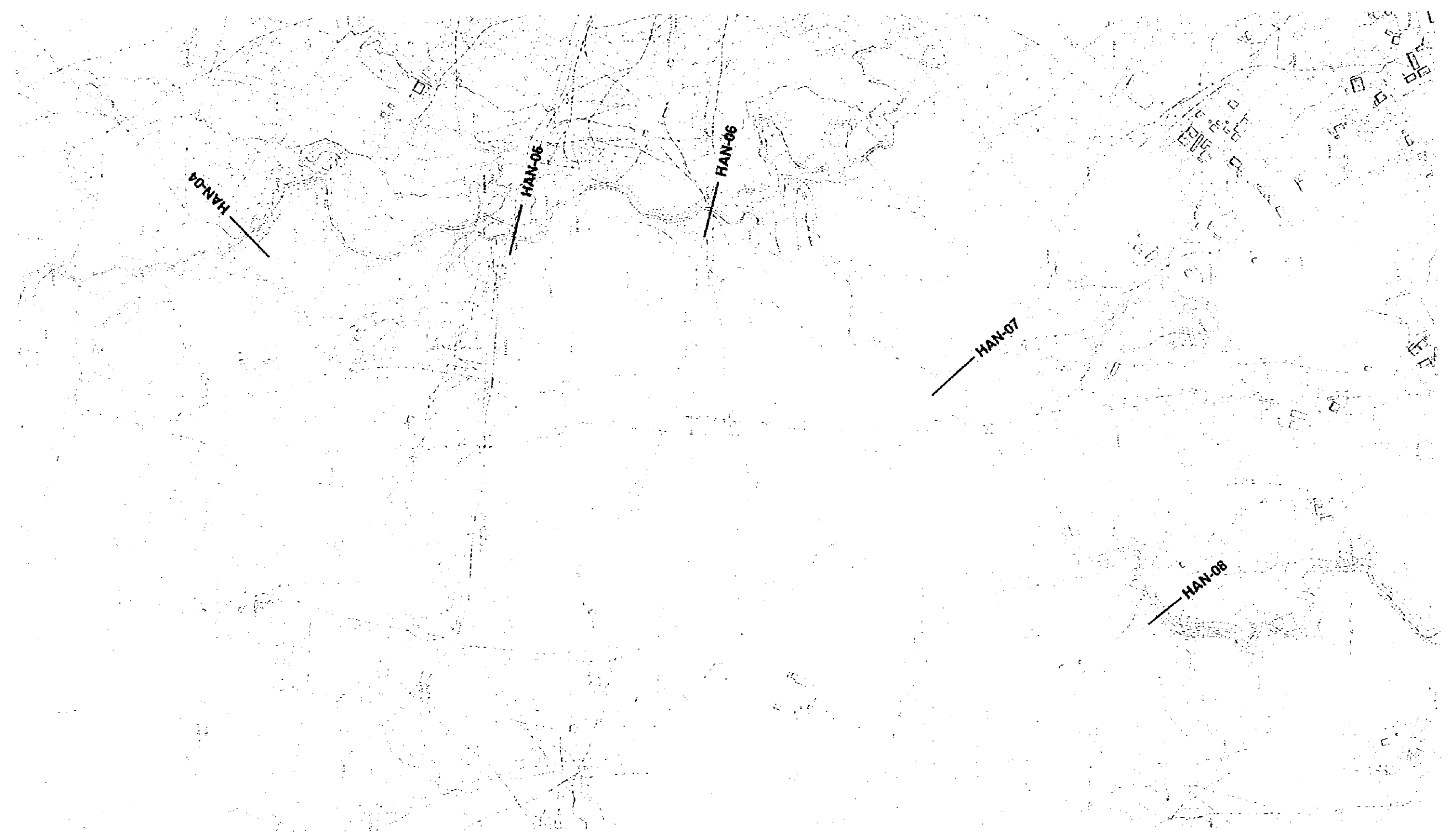

THE STUDY ON ADDIS ABABA FLOOD CONTROL PROJECT IN THE FEDERAL DEMOCRATIC REPUBLIC OF ETHIOPIA	
JAPAN INTERNATIONAL COOPERATION AGENCY REGION 14 ADMINISTRATION	
DRAWING NO. HAN-PLAN-02	

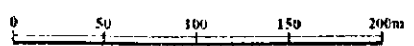

THE STUDY ON ADDIS ABABA FLOOD CONTROL PROJECT IN THE FEDERAL DEMOCRATIC REPUBLIC OF ETHIOPIA	
JAPAN INTERNATIONAL COOPERATION AGENCY REGION 14 ADMINISTRATION	
DRAWING NO.	
HAN-PLAN-03	

No.58,59,70,71

Cross Section S=1:200

HAN-00

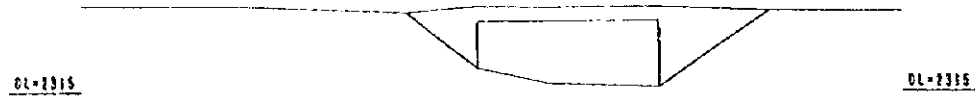

HAN-03

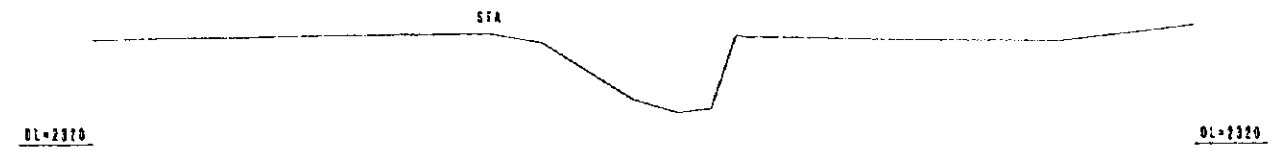

HAN-01

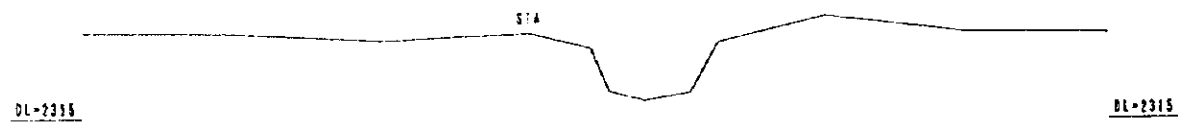

HAN-04



HAN-02

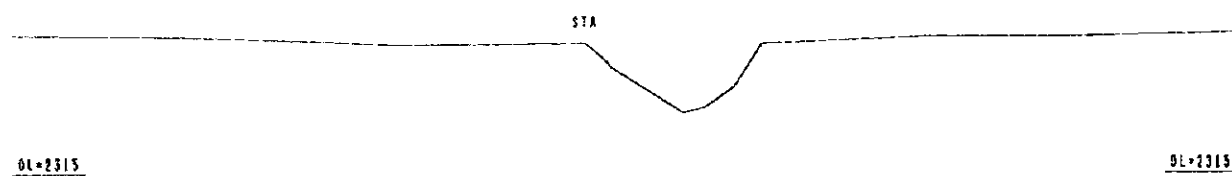

HAN-05



THE STUDY ON ADDIS ABABA FLOOD CONTROL PROJECT IN THE FEDERAL DEMOCRATIC REPUBLIC OF ETHIOPIA	
JAPAN INTERNATIONAL COOPERATION AGENCY REGION 14 ADMINISTRATION	
DRAWING NO. HAN-SECT-01	LOCATION OF RIVER CROSS SECTION HANKU (HAN) RIVER (01/03)

Cross Section S=1:200

HAN-06



HAN-09

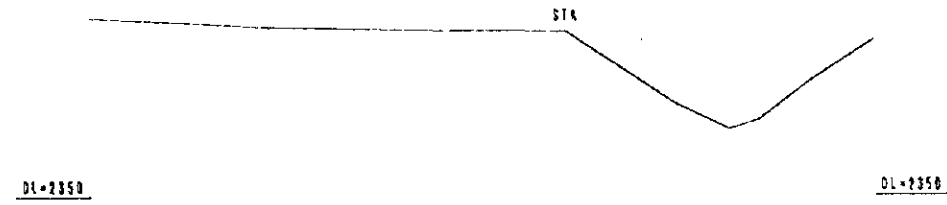

HAN-07



HAN-10



HAN-08

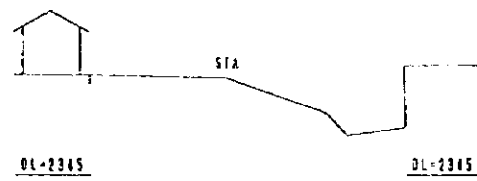

HAN-11

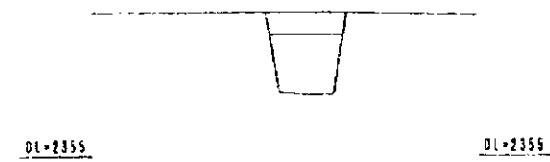

THE STUDY ON ADDIS ABABA FLOOD CONTROL PROJECT
IN THE FEDERAL DEMOCRATIC REPUBLIC OF ETHIOPIA

JAPAN INTERNATIONAL COOPERATION AGENCY
REGION 14 ADMINISTRATION

DRAWING NO.
HAN-SECT-02

LOCATION OF RIVER CROSS SECTION
HANKU (HAN) RIVER (02/03)

Cross Section S=1:200

HAN-12

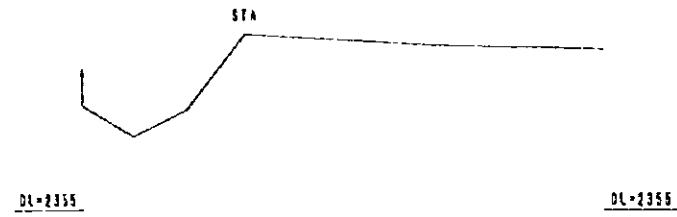

HAN-14

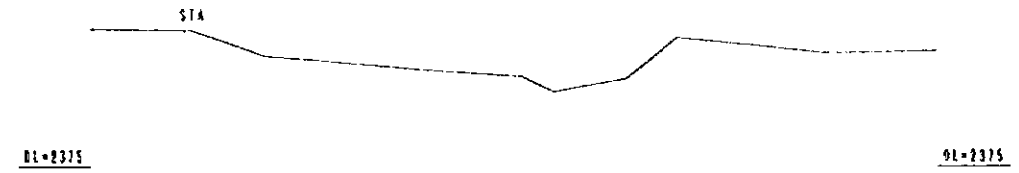

HAN-12 (a)

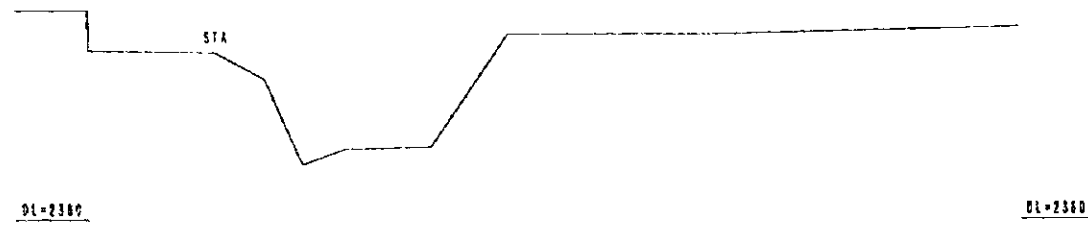

HAN-15

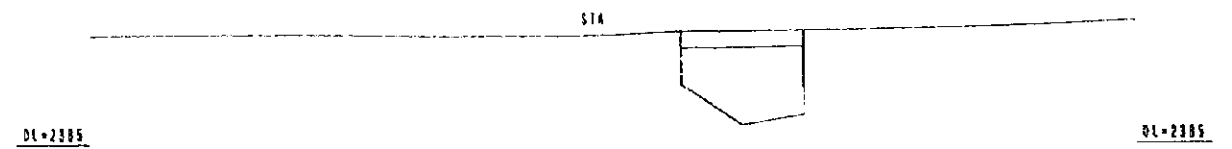

HAN-13

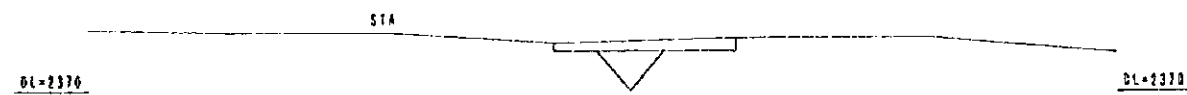

THE STUDY ON ADDIS ABABA FLOOD CONTROL PROJECT IN THE FEDERAL DEMOCRATIC REPUBLIC OF ETHIOPIA	
JAPAN INTERNATIONAL COOPERATION AGENCY REGION 14 ADMINISTRATION	
DRAWING NO. HAN-SECT-03	LOCATION OF RIVER CROSS SECTION HANKU (HAN) RIVER (03/03)

Profile Section V=1:500
H=1:10000

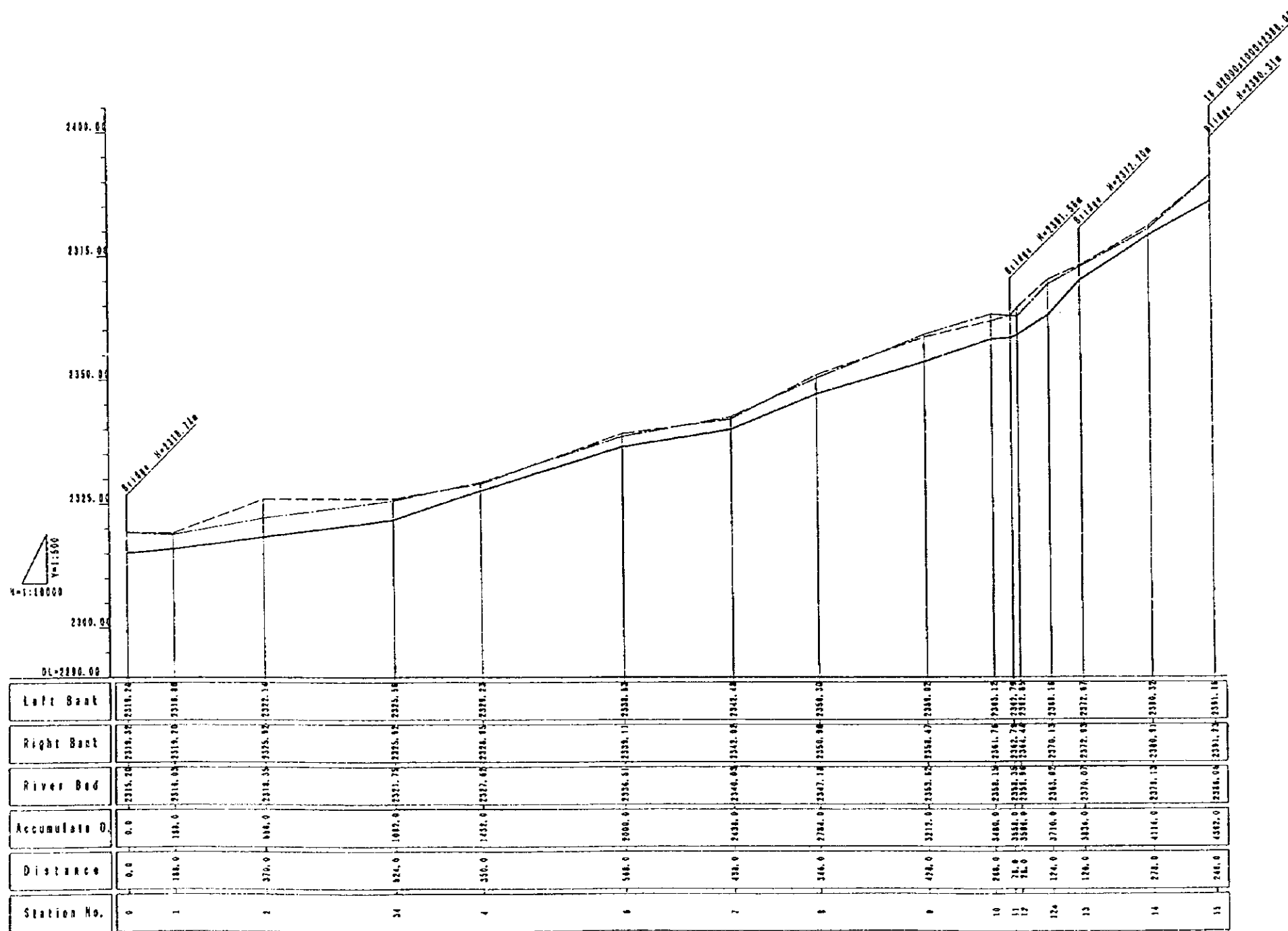

Left Bank	———
Right Bank	-----
River Bed	———

THE STUDY ON ADDIS ABABA FLOOD CONTROL PROJECT
IN THE FEDERAL DEMOCRATIC REPUBLIC OF ETHIOPIA
JAPAN INTERNATIONAL COOPERATION AGENCY
REGION 14 ADMINISTRATION
DRAWING NO. HAN-SECT-01 LOCATION OF RIVER PROFILE SECTION HANKU (HAN) RIVER (01/01)

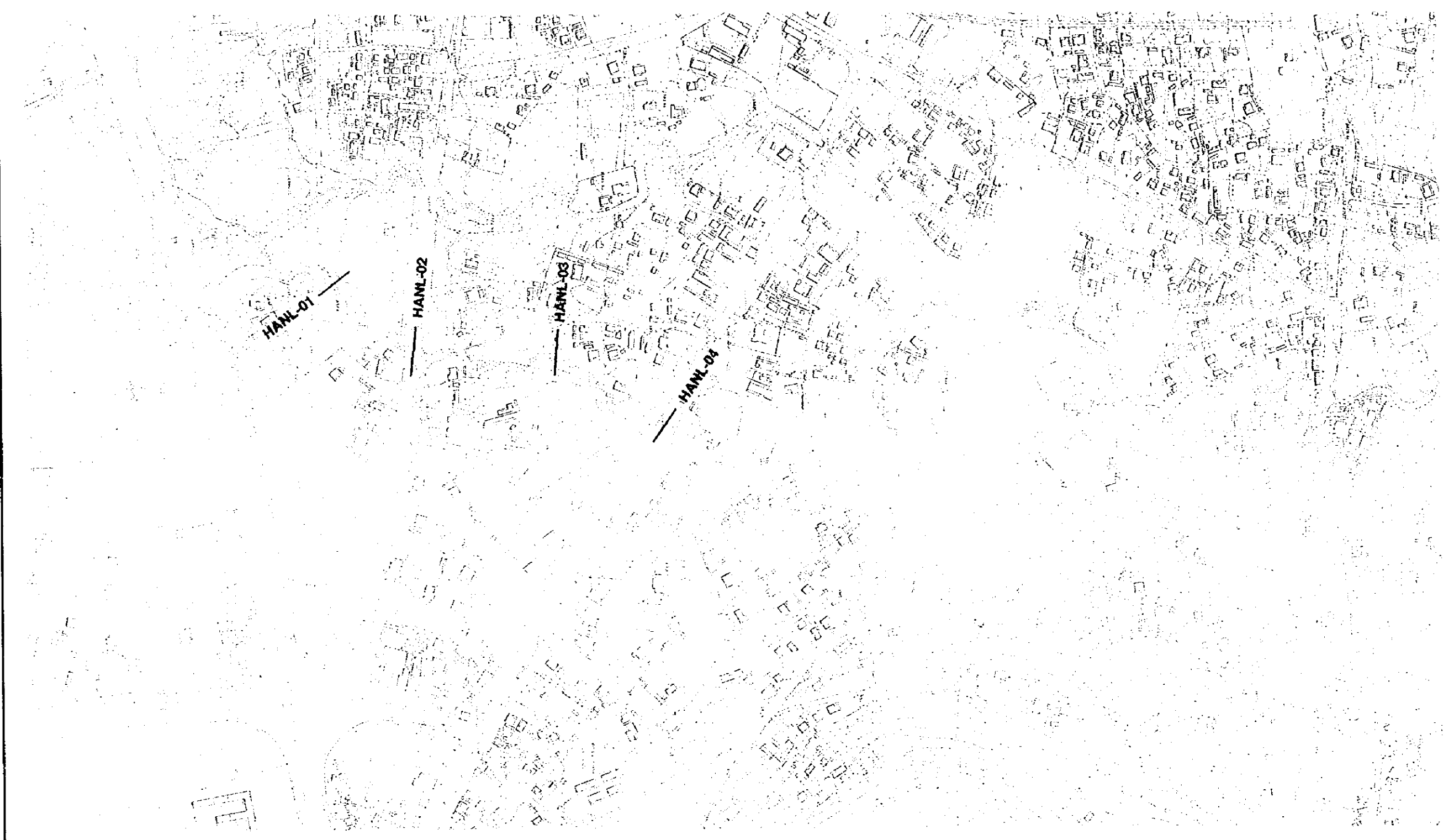

THE STUDY ON ADDIS ABABA FLOOD CONTROL PROJECT IN THE FEDERAL DEMOCRATIC REPUBLIC OF ETHIOPIA	
JAPAN INTERNATIONAL COOPERATION AGENCY REGION 14 ADMINISTRATION	
DRAWING NO.	
HANL-PLAN-01	

Cross Section S=1:200

HANL-01



HANL-04

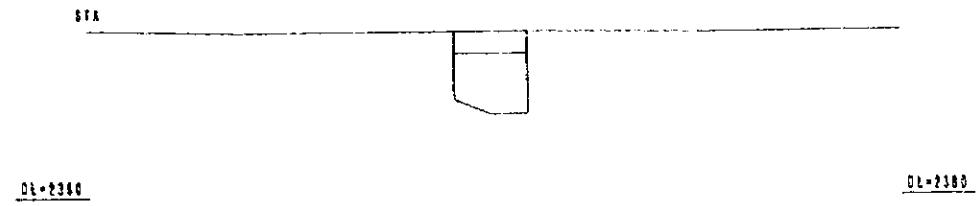

HANL-02

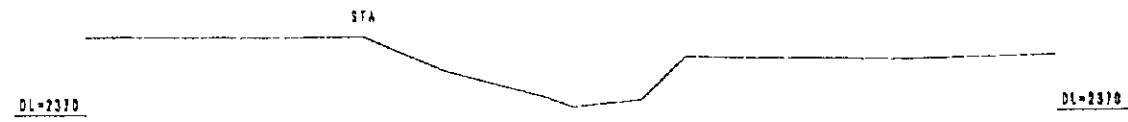

HANL-03



THE STUDY ON ADDIS ABABA FLOOD CONTROL PROJECT
IN THE FEDERAL DEMOCRATIC REPUBLIC OF ETHIOPIA

JAPAN INTERNATIONAL COOPERATION AGENCY
REGION 14 ADMINISTRATION

DRAWING NO.
HANL-SECT-01

LOCATION OF RIVER CROSS SECTION
HANKU (HANL) RIVER (01/01)

Profile Section $Y=1:500$
 $H=1:10000$

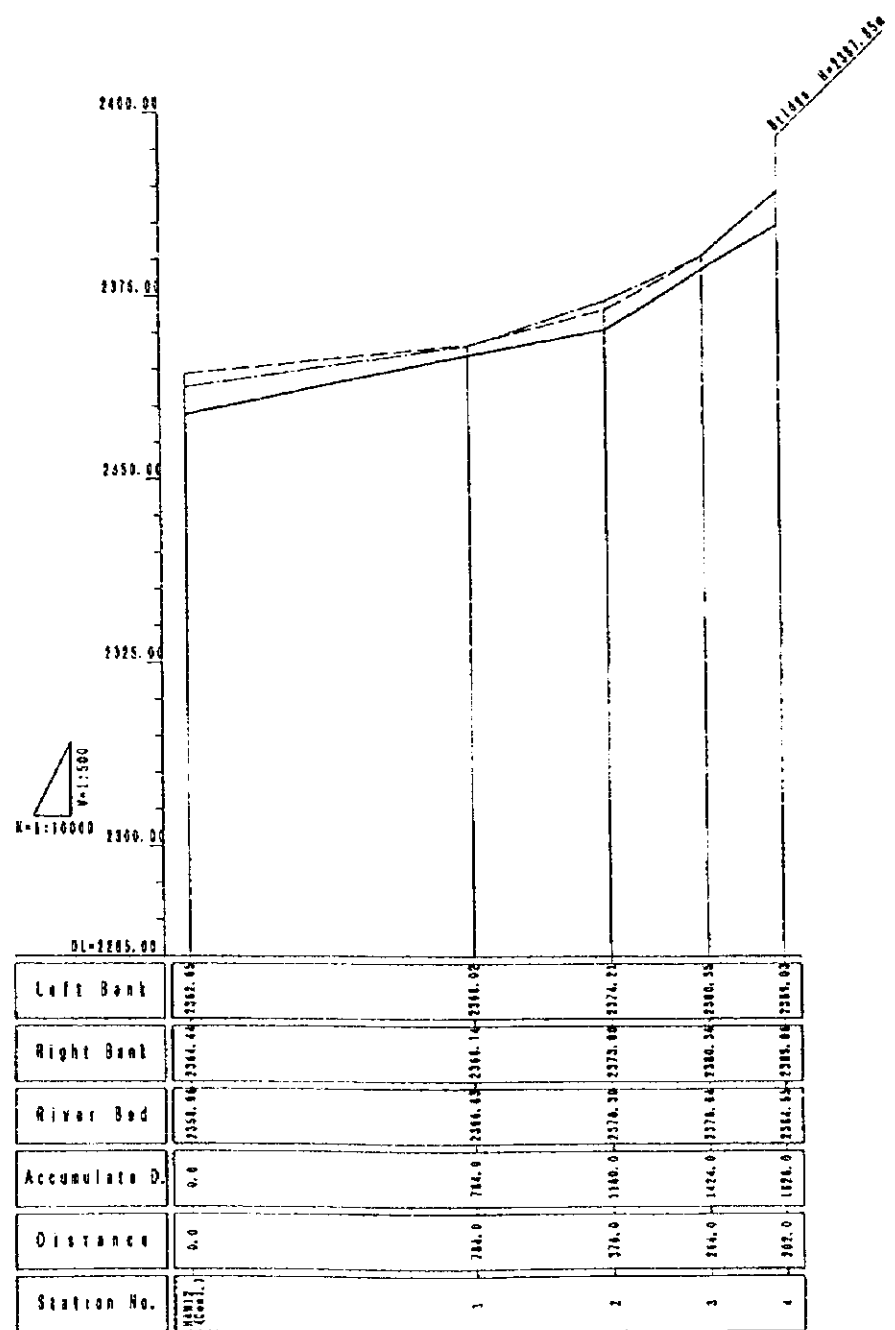

Left Bank	———
Right Bank	-----
River Bed	————

THE STUDY ON ADDIS ABABA FLOOD CONTROL PROJECT IN THE FEDERAL DEMOCRATIC REPUBLIC OF ETHIOPIA	
JAPAN INTERNATIONAL COOPERATION AGENCY REGION 14 ADMINISTRATION	
DRAWING NO. HANL-SECT-01	LOCATION OF RIVER PROFILE SECTION HANKU (HANL) RIVER (01/01)

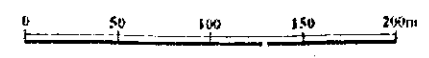
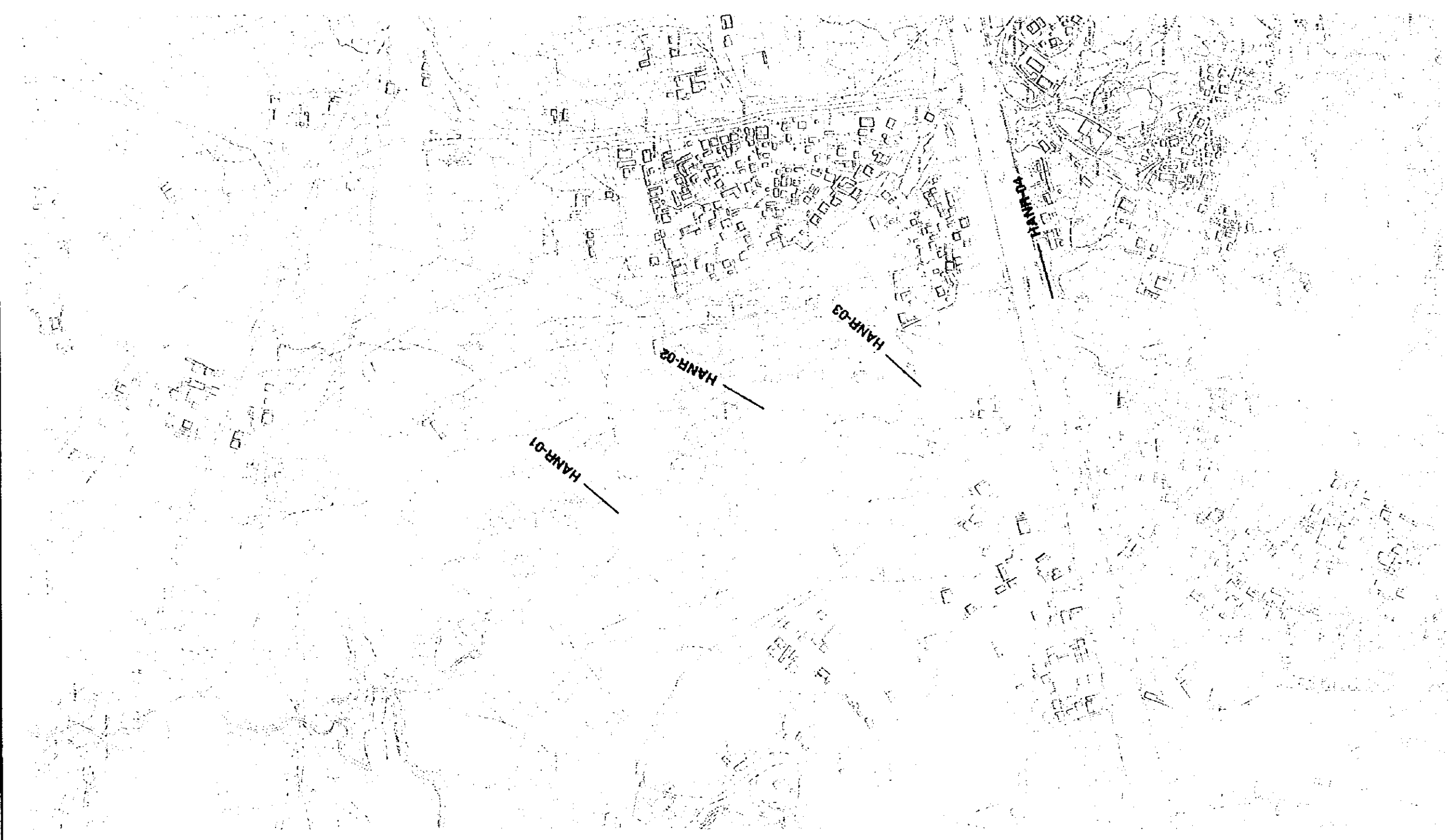

THE STUDY ON ADDIS ABABA FLOOD CONTROL PROJECT
IN THE FEDERAL DEMOCRATIC REPUBLIC OF ETHIOPIA

JAPAN INTERNATIONAL COOPERATION AGENCY
REGION 14 ADMINISTRATION

DRAWING NO.	
HANR-PLAN-01	

Cross Section S=1:200

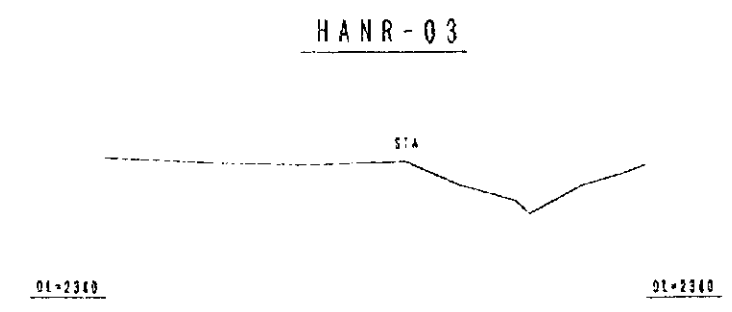
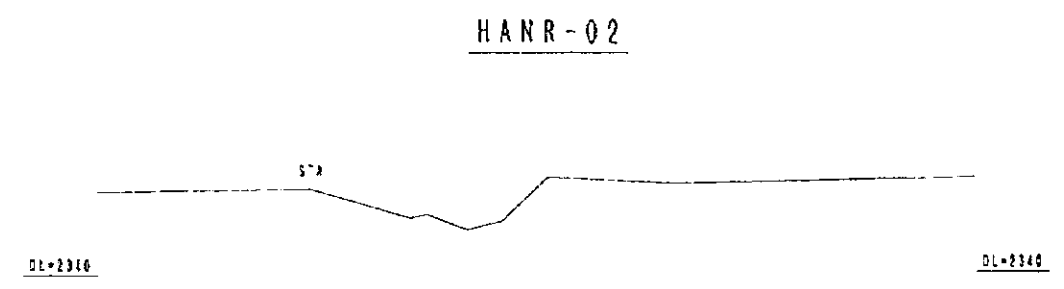
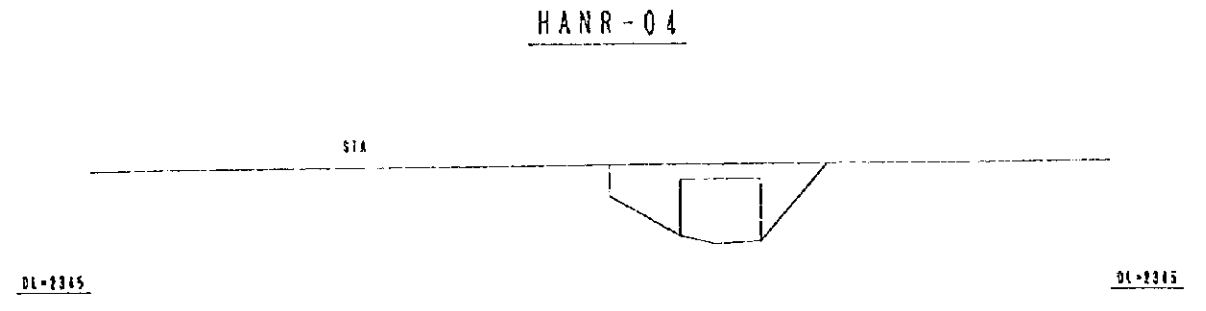
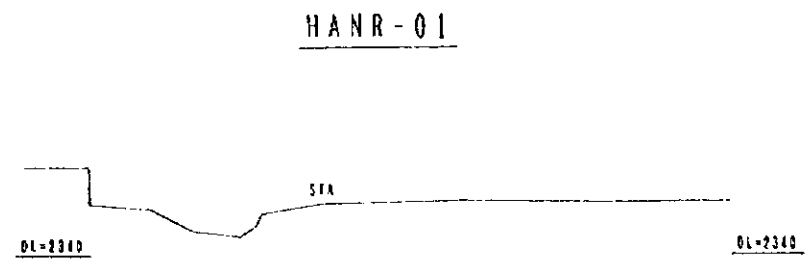

THE STUDY ON ADDIS ABABA FLOOD CONTROL PROJECT IN THE FEDERAL DEMOCRATIC REPUBLIC OF ETHIOPIA	
JAPAN INTERNATIONAL COOPERATION AGENCY REGION II ADMINISTRATION	
DRAWING NO. HANR-SECT-01	LOCATION OF RIVER CROSS SECTION HANKU (HANR) RIVER (01/01)

Profile Section V=1:500
H=1:10000

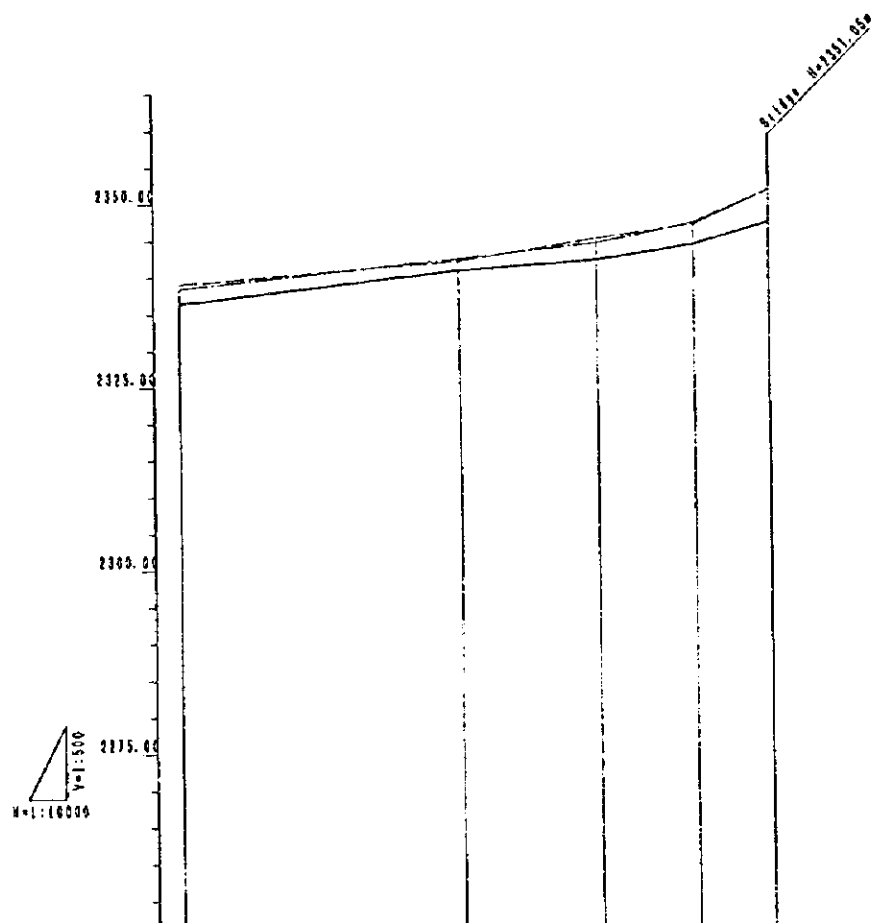

Left Bank	2350.00	2340.00	2330.00	2320.00	2310.00
Right Bank	2330.00	2320.00	2310.00	2300.00	2290.00
River Bed	2310.00	2300.00	2290.00	2280.00	2270.00
Accumulate D.	0.0	76.0	152.0	228.0	304.0
Distance	0.0	76.0	152.0	228.0	304.0
Station No.	0+00	1	2	3	4

Left Bank	---
Right Bank	----
River Bed	_____

THE STUDY ON ADDIS ABABA FLOOD CONTROL PROJECT
IN THE FEDERAL DEMOCRATIC REPUBLIC OF ETHIOPIA
JAPAN INTERNATIONAL COOPERATION AGENCY
REGION 14 ADMINISTRATION

DRAWING NO. HANR-SECT-01	LOCATION OF RIVER PROFILE SECTION HANKU (HANR) RIVER (01/01)
-----------------------------	---

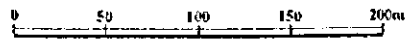
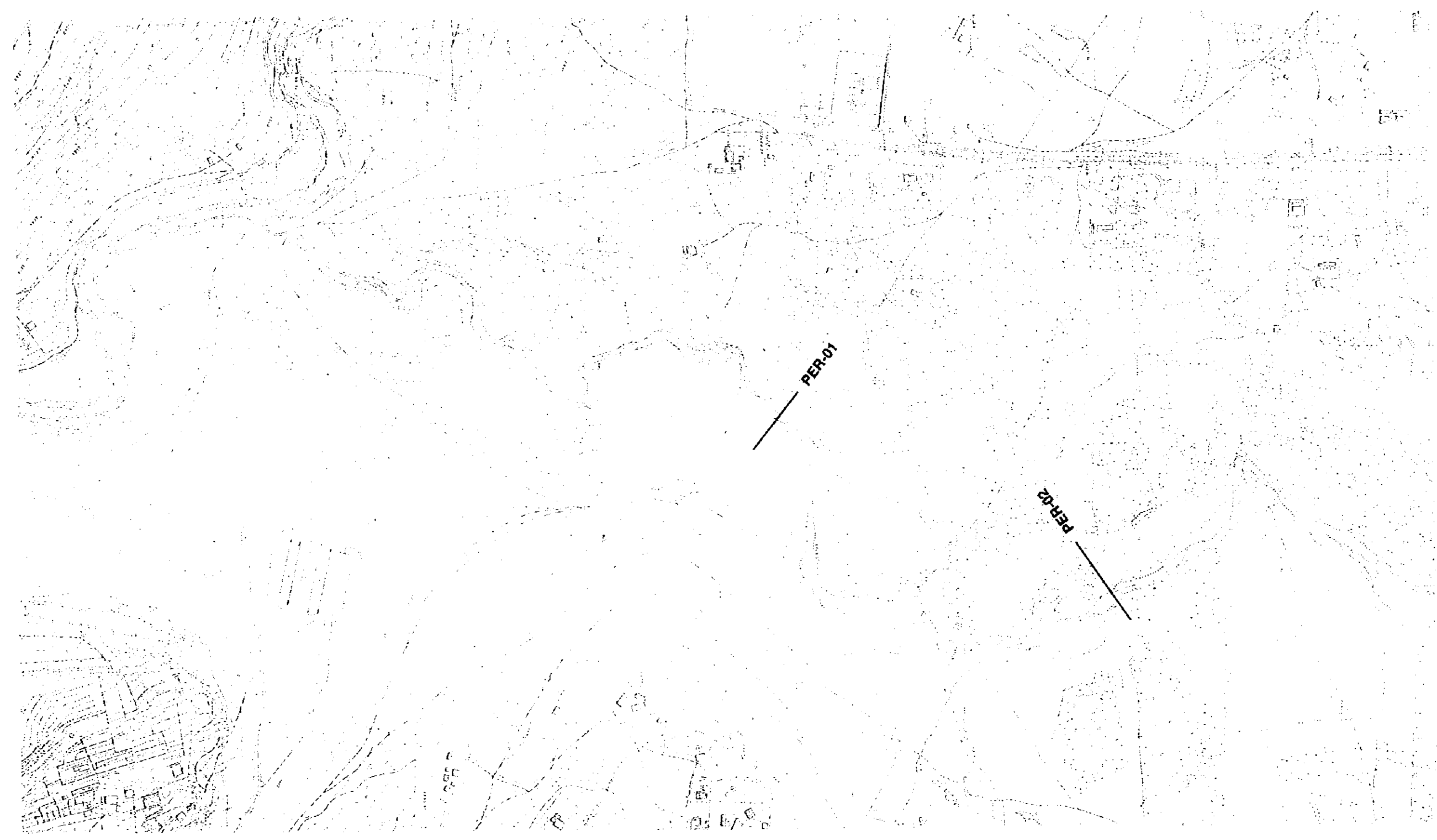

THE STUDY ON ADDIS ABABA FLOOD CONTROL PROJECT IN THE FEDERAL DEMOCRATIC REPUBLIC OF ETHIOPIA	
JAPAN INTERNATIONAL COOPERATION AGENCY REGION 14 ADMINISTRATION	
DRAWING NO. PER-PLAN-01	



THE STUDY ON ADDIS ABABA FLOOD CONTROL PROJECT IN THE FEDERAL DEMOCRATIC REPUBLIC OF ETHIOPIA	
JAPAN INTERNATIONAL COOPERATION AGENCY REGION 14 ADMINISTRATION	
DRAWING NO.	
PER-PLAN-02	

No.90,100

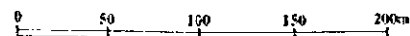
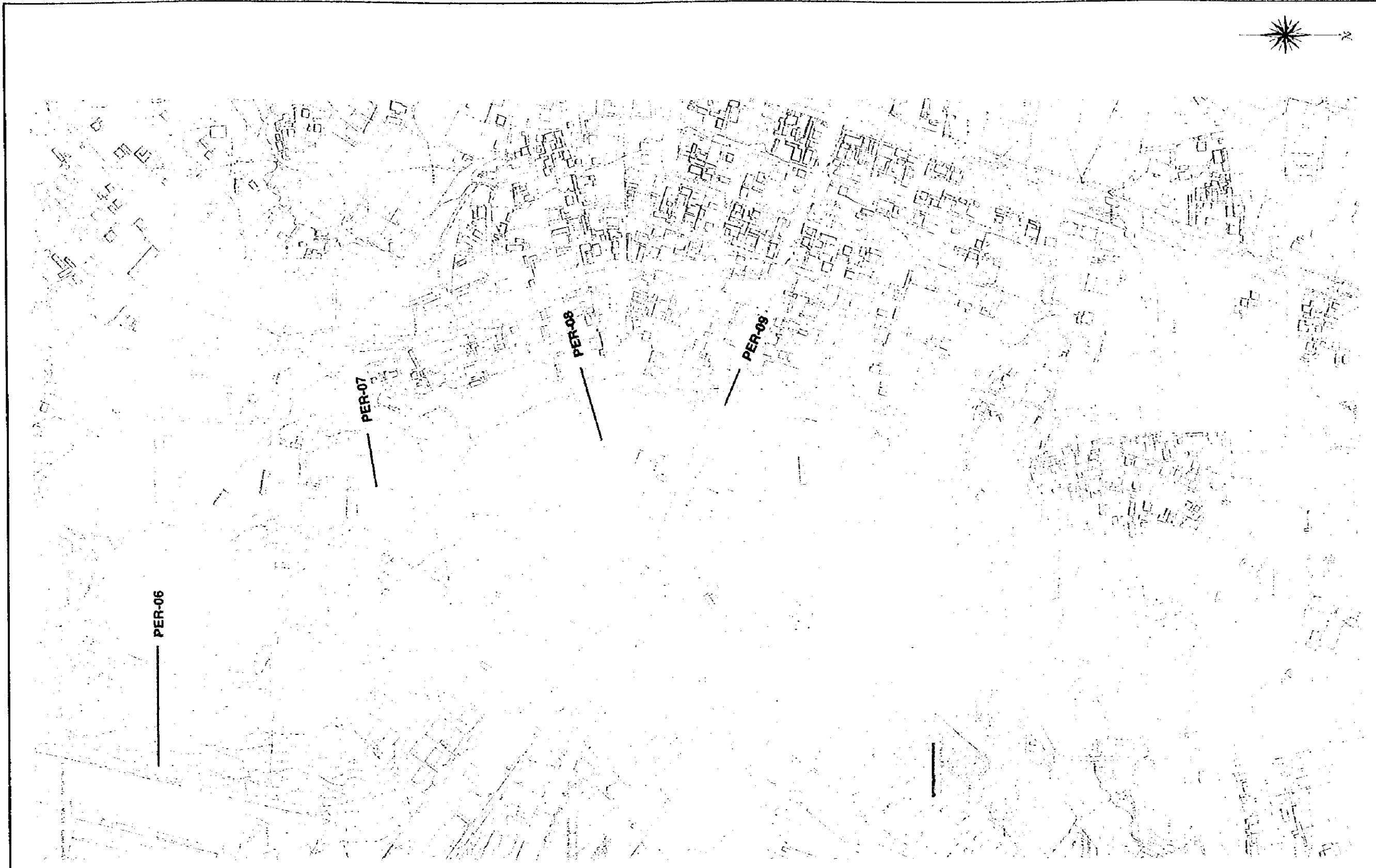

THE STUDY ON ADDIS ABABA FLOOD CONTROL PROJECT IN THE FEDERAL DEMOCRATIC REPUBLIC OF ETHIOPIA	
JAPAN INTERNATIONAL COOPERATION AGENCY REGION 14 ADMINISTRATION	
DRAWING NO.	
PER-PLAN-03	

Cross Section S=1:200

PER-01

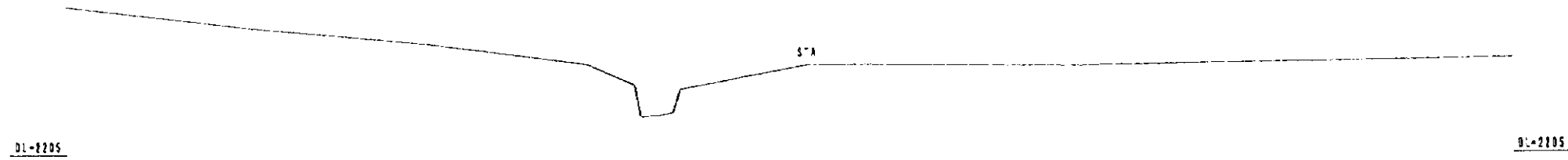

PER-02

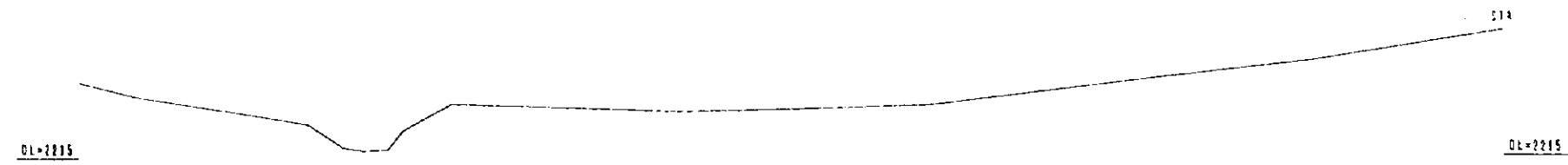

PER-03

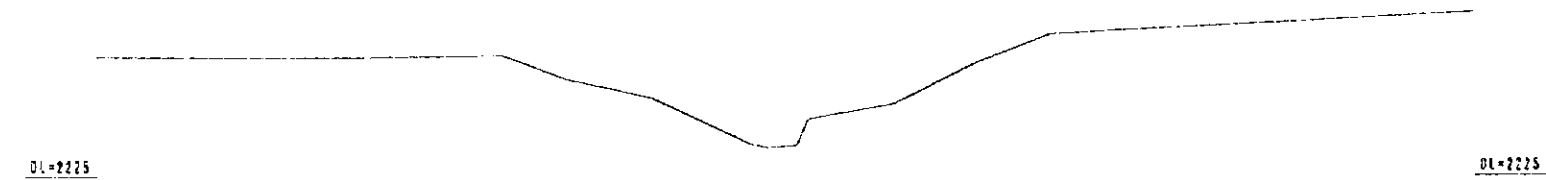

THE STUDY ON ADDIS ABABA FLOOD CONTROL PROJECT IN THE FEDERAL DEMOCRATIC REPUBLIC OF ETHIOPIA	
JAPAN INTERNATIONAL COOPERATION AGENCY REGION 14 ADMINISTRATION	
DRAWING NO. PER-SECT-01	LOCATION OF RIVER CROSS SECTION PERENNIAL (PER) RIVER (01/03)

Cross Section S=1:200

PER-04

STA

DL-2235

DL-2235

PER-05

STA

DL-2245

DL-2245

PER-06

STA

DL-2260

DL-2260

THE STUDY ON ADDIS ABABA FLOOD CONTROL PROJECT
IN THE FEDERAL DEMOCRATIC REPUBLIC OF ETHIOPIA

JAPAN INTERNATIONAL COOPERATION AGENCY
REGION II ADMINISTRATION

DRAWING NO.
PER-SECT-02

LOCATION OF RIVER CROSS SECTION
PERENNIAL (PER) RIVER (02/03)

Cross Section S=1:200

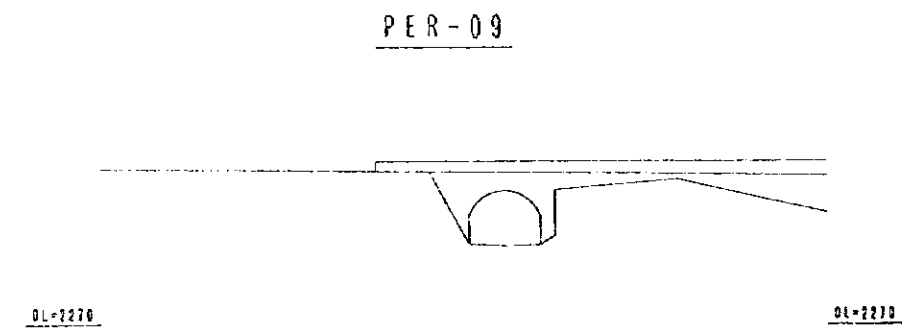
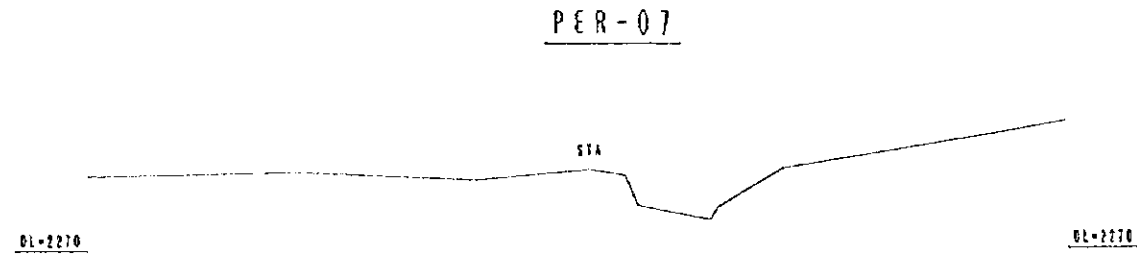

THE STUDY ON ADDIS ABABA FLOOD CONTROL PROJECT IN THE FEDERAL DEMOCRATIC REPUBLIC OF ETHIOPIA	
JAPAN INTERNATIONAL COOPERATION AGENCY REGION 14 ADMINISTRATION	
DRAWING NO. PER-SECT-03	LOCATION OF RIVER CROSS SECTION PERENNIAL (PER) RIVER (03/03)

Profile Section V=1:500
H=1:10000

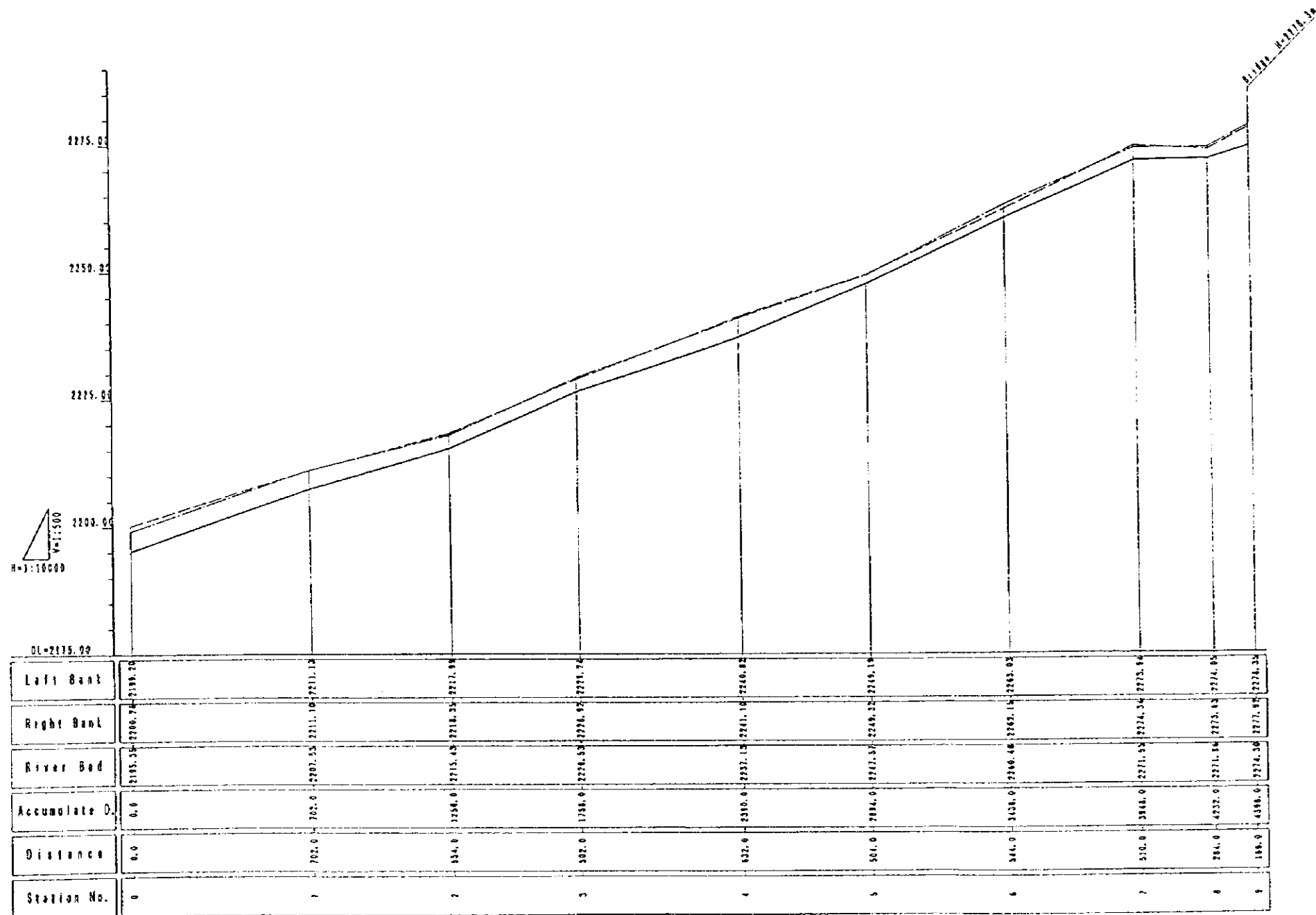

Left Bank	———
Right Bank
River Bed	———

THE STUDY ON ADDIS ABABA FLOOD CONTROL PROJECT
IN THE FEDERAL DEMOCRATIC REPUBLIC OF ETHIOPIA
JAPAN INTERNATIONAL COOPERATION AGENCY
REGION 14 ADMINISTRATION

DRAWING NO. PER-SECT-01	LOCATION OF RIVER PROFILE SECTION PERENNIAL (PER) RIVER (01/01)
----------------------------	--

DRAWINGS
OF
RIVER AND ROAD SURVEY
OF
PHASE II STUDY
(FEASIBILITY STUDY)

Drawing No.	Drawing Title	Page
RV-LM-01	LOCATION OF RIVER CROSS SECTION (1/6)	2-1-1
RV-LM-02	LOCATION OF RIVER CROSS SECTION (2/6)	2-1-2
RV-LM-03	LOCATION OF RIVER CROSS SECTION (3/6)	2-1-3
RV-LM-04	LOCATION OF RIVER CROSS SECTION (4/6)	2-1-4
RV-LM-05	LOCATION OF RIVER CROSS SECTION (5/6)	2-1-5
RV-LM-06	LOCATION OF RIVER CROSS SECTION (6/6)	2-1-6
RV-CS-01	RIVER CROSS SECTION (1/25)	2-1-7
RV-CS-02	RIVER CROSS SECTION (2/25)	2-1-8
RV-CS-03	RIVER CROSS SECTION (3/25)	2-1-9
RV-CS-04	RIVER CROSS SECTION (4/25)	2-1-10
RV-CS-05	RIVER CROSS SECTION (5/25)	2-1-11
RV-CS-06	RIVER CROSS SECTION (6/25)	2-1-12
RV-CS-07	RIVER CROSS SECTION (7/25)	2-1-13
RV-CS-08	RIVER CROSS SECTION (8/25)	2-1-14
RV-CS-09	RIVER CROSS SECTION (9/25)	2-1-15
RV-CS-10	RIVER CROSS SECTION (10/25)	2-1-16
RV-CS-11	RIVER CROSS SECTION (11/25)	2-1-17
RV-CS-12	RIVER CROSS SECTION (12/25)	2-1-18
RV-CS-13	RIVER CROSS SECTION (13/25)	2-1-19
RV-CS-14	RIVER CROSS SECTION (14/25)	2-1-20
RV-CS-15	RIVER CROSS SECTION (15/25)	2-1-21
RV-CS-16	RIVER CROSS SECTION (16/25)	2-1-22
RV-CS-17	RIVER CROSS SECTION (17/25)	2-1-23
RV-CS-18	RIVER CROSS SECTION (18/25)	2-1-24
RV-CS-19	RIVER CROSS SECTION (19/25)	2-1-25
RV-CS-20	RIVER CROSS SECTION (20/25)	2-1-26
RV-CS-21	RIVER CROSS SECTION (21/25)	2-1-27
RV-CS-22	RIVER CROSS SECTION (22/25)	2-1-28
RV-CS-23	RIVER CROSS SECTION (23/25)	2-1-29
RV-CS-24	RIVER CROSS SECTION (24/25)	2-1-30
RV-CS-25	RIVER CROSS SECTION (25/25)	2-1-31
RV-PR-01	LONGITUDINAL PROFILE (1/3) KEBENA RIVER, BANTYIKETU RIVER	2-1-32
RV-PR-02	LONGITUDINAL PROFILE (2/3) BANTYIKETU RIVER	2-1-33
RV-PR-03	LONGITUDINAL PROFILE (3/3) KECHENE RIVER	2-1-34
KW-LM-01	LOCATION OF RIVER CROSS SECTION (1/2)	2-1-35
KW-LM-02	LOCATION OF RIVER CROSS SECTION (2/2)	2-1-36
KW-CS-01	RIVER CROSS SECTION KECHENE WEIR (1/8)	2-1-37
KW-CS-02	RIVER CROSS SECTION KECHENE WEIR (2/8)	2-1-38
KW-CS-03	RIVER CROSS SECTION KECHENE WEIR (3/8)	2-1-39
KW-CS-04	RIVER CROSS SECTION KECHENE WEIR (4/8)	2-1-40
KW-CS-05	RIVER CROSS SECTION KECHENE WEIR (5/8)	2-1-41
KW-CS-06	RIVER CROSS SECTION KECHENE WEIR (6/8)	2-1-42
KW-CS-07	RIVER CROSS SECTION KECHENE WEIR (7/8)	2-1-43
KW-CS-08	RIVER CROSS SECTION KECHENE WEIR (8/8)	2-1-44

Drawing No.	Drawing Title	Page
KW-PR-01	LONGITUDINAL PROFILE KECHENE WEIR (1/1)	2-1-45
KP-CS-01	RIVER CROSS SECTION KOSTRE REGULATING POND	2-1-46
KP-PL-01	KOSTRE REGULATING POND RESERVOIR AREA (1/1)	2-1-47
BP-PL-01	BANTYIKETU REGULATING POND RESERVOIR AREA	2-1-48
RD-LM-01	LOCATION OF ROAD CROSS SECTION (1/3)	2-2-1
RD-LM-02	LOCATION OF ROAD CROSS SECTION (2/3)	2-2-2
RD-LM-03	LOCATION OF ROAD CROSS SECTION (3/3)	2-2-3
RD-CS-01	ROAD CROSS SECTION (1/7)	2-2-4
RD-CS-02	ROAD CROSS SECTION (2/7)	2-2-5
RD-CS-03	ROAD CROSS SECTION (3/7)	2-2-6
RD-CS-04	ROAD CROSS SECTION (4/7)	2-2-7
RD-CS-05	ROAD CROSS SECTION (5/7)	2-2-8
RD-CS-06	ROAD CROSS SECTION (6/7)	2-2-9
RD-CS-07	ROAD CROSS SECTION (7/7)	2-2-10
RD-PR-01	LONGITUDINAL PROFILE OF ROAD (1/2)	2-2-11
RD-PR-02	LONGITUDINAL PROFILE OF ROAD (2/2)	2-2-12



THE MAP IS PROVIDED FOR
YOUR USE ONLY AND NOT TO BE USED

ADDIS ABABA

SHEET 992.472-G

SCALE 1:2000

CONTOUR INTERVAL 1.0 metre

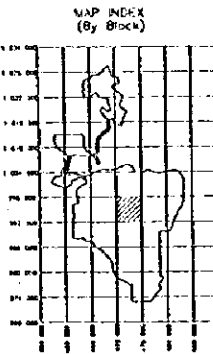

MAP INDEX
(By Sheet)

A	B	C	D
E	F	G	H
I	J	K	L
M	N	O	P

992.472-G

Original Geometric Data from Japanese Topographic Maps (Scale 1:25,000) Revised and Digitized by the Japanese Geomatics Institute (June 2007)

LEGEND

Topographic contour line	▲
Contour line (10m interval)	○
Contour line (5m interval)	○
Contour line (2m interval)	○
Contour line (1m interval)	○
Contour line (0.5m interval)	○
Contour line (0.2m interval)	○
Contour line (0.1m interval)	○
Contour line (0.05m interval)	○
Contour line (0.02m interval)	○
Contour line (0.01m interval)	○
Contour line (0.005m interval)	○
Contour line (0.002m interval)	○
Contour line (0.001m interval)	○
Contour line (0.0005m interval)	○
Contour line (0.0002m interval)	○
Contour line (0.0001m interval)	○
Contour line (0.00005m interval)	○
Contour line (0.00002m interval)	○
Contour line (0.00001m interval)	○
Contour line (0.000005m interval)	○
Contour line (0.000002m interval)	○
Contour line (0.000001m interval)	○
Contour line (0.0000005m interval)	○
Contour line (0.0000002m interval)	○
Contour line (0.0000001m interval)	○
Contour line (0.00000005m interval)	○
Contour line (0.00000002m interval)	○
Contour line (0.00000001m interval)	○

THE STUDY ON ADDIS ABABA FLOOD CONTROL PROJECT
IN THE FEDERAL DEMOCRATIC REPUBLIC OF ETHIOPIA

JAPAN INTERNATIONAL COOPERATION AGENCY
REGION 14 ADMINISTRATION

DRAWING NO.
RV-LM-02

LOCATION OF RIVER
CROSS SECTION (2/6)

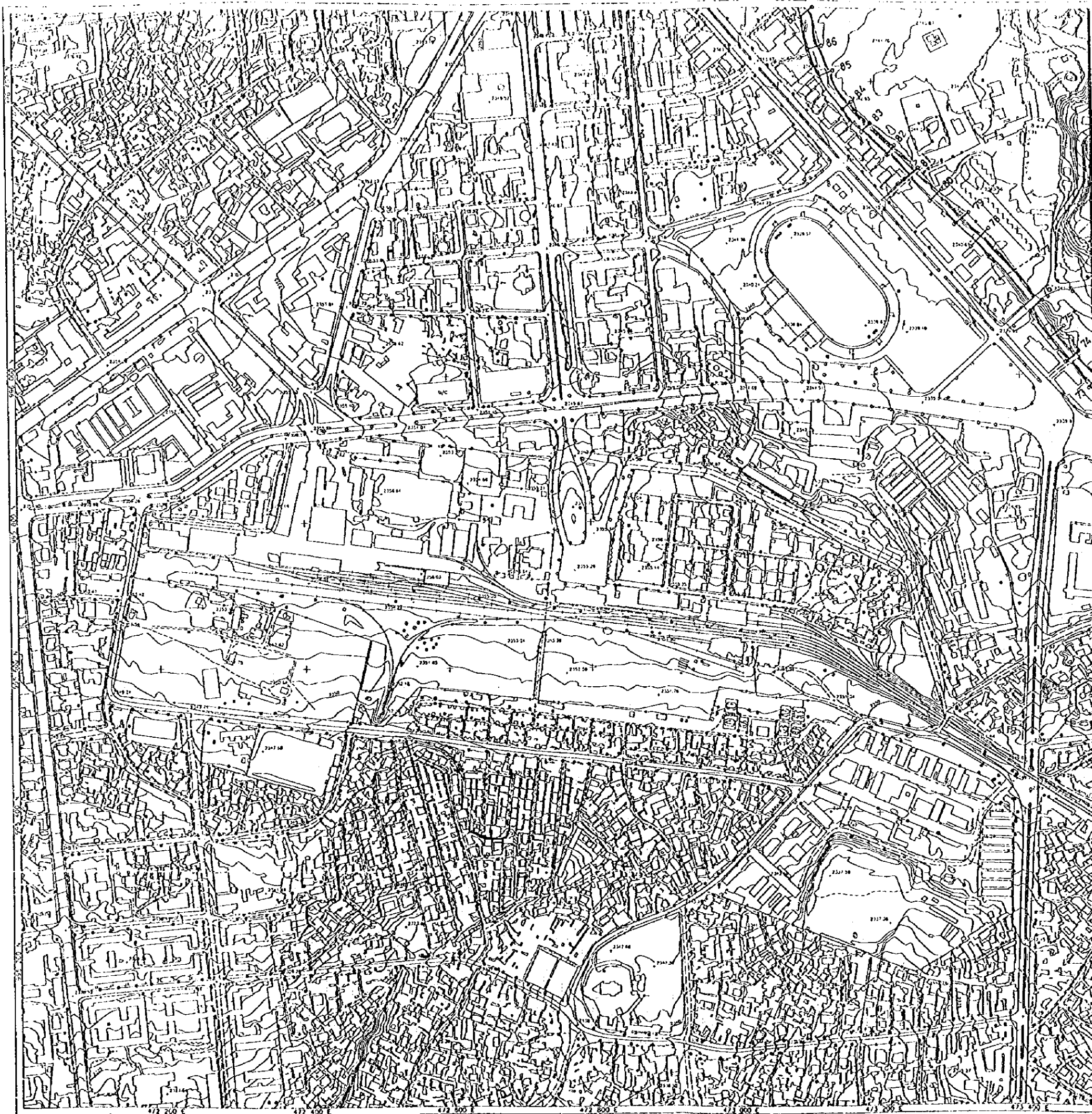

DC 9231 15 47214
 MAP NUMBER OF CONTRACT SHEET

ADDIS ABABA

SHEET 992.472-E

SCALE 1:2000

CONTOUR INTERVAL 1.0 metre

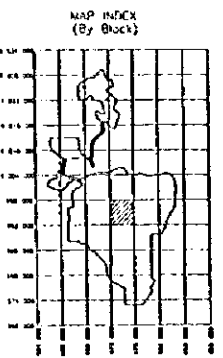

MAP INDEX (By Sheet)

A	B	C	D
E	F	G	H
I	J	K	L
M	N	O	P

992.472-E

Topographic Map Addis Ababa
 Revised Edition 1967 (1964)
 General Survey of the Addis Ababa
 Town of

LEGEND

▲	Major Landmark
△	Public Landmark
○	Public Landmark
—	Major Road
—	Public Road
—	Minor Road
—	Watercourse
—	Drainage
—	Contour
—	Elevation
—	Spot Height
—	Building
—	Open Area
—	Vegetation
—	Other

**THE STUDY ON ADDIS ABABA FLOOD CONTROL PROJECT
 IN THE FEDERAL DEMOCRATIC REPUBLIC OF ETHIOPIA**

JAPAN INTERNATIONAL COOPERATION AGENCY
 REGION 14 ADMINISTRATION

DRAWING NO. RV-LM-04	LOCATION OF RIVER CROSS SECTION (4/6)
-------------------------	--