

JOURNAL OF INTERNATIONAL COOPERATION AGENCY OF JAPAN  
INTERNATIONAL COOPERATION  
JOURNAL OF INTERNATIONAL COOPERATION AGENCY OF JAPAN

FIELD STUDY  
ON  
ADDIS ABABA BLOOD CONTROL PROJECT  
IN  
THE FEDERAL DEMOCRATIC REPUBLIC OF ETHIOPIA

FIELD REPORT  
VOLUME 9  
DATA BOOKS

FIELD STUDY

LIBRARY  
  
J 1144068 (2)

INTERNATIONAL COOPERATION AGENCY OF JAPAN  
INTERNATIONAL COOPERATION AGENCY OF JAPAN



JAPAN INTERNATIONAL COOPERATION AGENCY (JICA)  
REGION 14 ADMINISTRATION  
THE FEDERAL DEMOCRATIC REPUBLIC OF ETHIOPIA

THE STUDY  
ON  
ADDIS ABABA FLOOD CONTROL PROJECT  
IN  
THE FEDERAL DEMOCRATIC REPUBLIC OF ETHIOPIA

FINAL REPORT

VOLUME V  
DATA BOOK

MAY 1998

NIPPON KOEI CO., LTD.  
NIKKEN CONSULTANTS, INC.

## LIST OF REPORTS

- EXECUTIVE SUMMARY (*In Japanese*)
- VOLUME I EXECUTIVE SUMMARY (*In English*)
- VOLUME II MAIN REPORT (*In English*)
- VOLUME III SUPPORTING REPORT OF PHASE I STUDY  
(MASTER PLAN STUDY) (*In English*)
- VOLUME IV SUPPORTING REPORT OF PHASE II STUDY  
(FEASIBILITY STUDY) (*In English*)
- VOLUME V DATA BOOK (*In English*)



1144068 (2)

Applied Exchange Rate  
US\$ 1.0 = Birr 6.8 = Japanese Yen 114.7  
(As of June 1997)

**THE STUDY  
ON  
ADDIS ABABA FLOOD CONTROL PROJECT**

**FINAL REPORT**

**VOLUME V**

**DATA BOOK**

**CONTENTS**

- 1. Drawings of River Survey of Phase I Study (Master Plan Study)**
- 2. Drawings of River and Road Survey of Phase II Study  
(Feasibility Study)**
- 3. Daily Rainfall Data**

<b>No.</b>	<b>Station</b>	<b>Period of Data Available</b>	<b>Page</b>
1	Akaki	1988 ~ 1997	3-1-1 ~ 3-1-10
2	Alem Tena	1987 ~ 1991 1993 ~ 1997	3-2-1 ~ 3-2-10
3	Buye	1987 ~ 1997	3-3-1 ~ 3-3-10
4	Debrezeit Air Force	1977 ~ 1990 1994 ~ 1990	3-4-1 ~ 3-4-17
5	Ginchi	1977 ~ 1996	3-5-1 ~ 3-5-20
6	Holleta R.S. (SHDA)	1981 ~ 1996	3-6-1 ~ 3-6-16
7	Hombolle	1977 ~ 1993, 1997	3-7-1 ~ 3-7-18
8	Koka Dam (SHDA)	1977 ~ 1997	3-8-1 ~ 3-8-20
9	Melka Kuntre	1979 ~ 1994, 1996	3-9-1 ~ 3-9-19
10	Sendafa	1977 ~ 1996	3-10-1 ~ 3-10-20
11	Sululta	1983 ~ 1996	3-11-1 ~ 3-11-14

12	Tulu Bolo	1977 ~ 1996	3-12-1 ~ 3-12-20
13	Addis Ababa Observatory	1986 ~ 1995	3-13-1 ~ 3-13-9
14	Bole International Airport	1986 ~ 1995	3-14-1 ~ 3-14-9
15	ILCA (H.Q.)	1982 ~ 1993	3-15-1 ~ 3-15-8

4. Automatic Recording Chart of Storm Rainfall (19 August 1978)  
at Addis Ababa Observatory and Bole International Airport
5. Monthly Rainfall Data at Bole International Airport (1965 - 1995)
6. Daily Gauge Height and Discharge at Akaki Gauging Station of  
Akaki River (1981 - 1993)

**DRAWINGS**  
**OF**  
**RIVER SURVEY**  
**OF**  
**PHASE I STUDY**  
**(MASTER PLAN STUDY)**

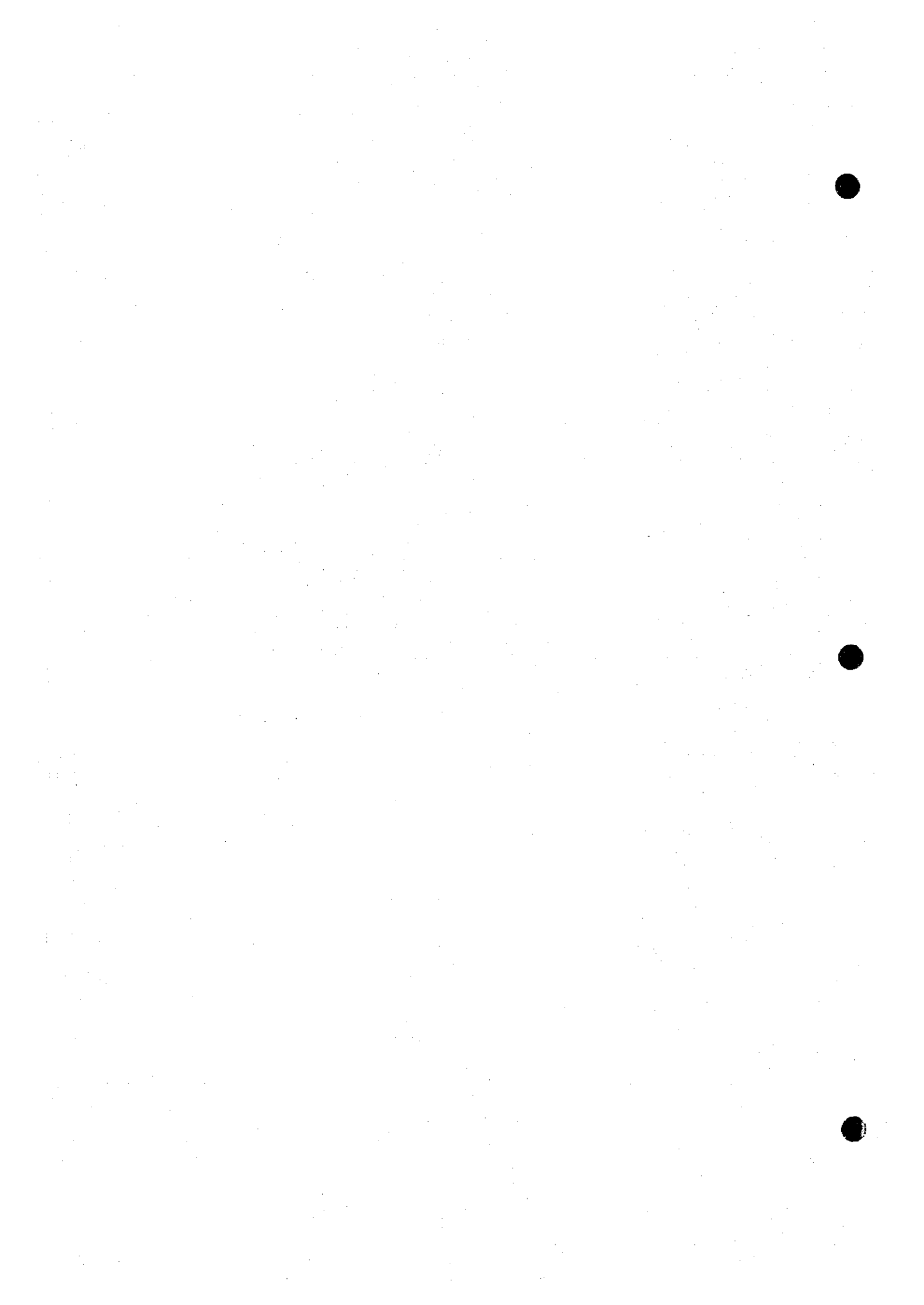



Drawing No.	Drawing Title	Page
KEC-PLAN-01		1-1-1
KEC-PLAN-02		1-1-2
KEC-PLAN-03		1-1-3
KEC-PLAN-04		1-1-4
KEC-PLAN-05		1-1-5
KEC-SECT-01	LOCATION OF RIVER CROSS SECTION KECHENE (KEC) RIVER (01/08)	1-1-6
KEC-SECT-02	LOCATION OF RIVER CROSS SECTION KECHENE (KEC) RIVER (02/08)	1-1-7
KEC-SECT-03	LOCATION OF RIVER CROSS SECTION KECHENE (KEC) RIVER (03/08)	1-1-8
KEC-SECT-04	LOCATION OF RIVER CROSS SECTION KECHENE (KEC) RIVER (04/08)	1-1-9
KEC-SECT-05	LOCATION OF RIVER CROSS SECTION KECHENE (KEC) RIVER (05/08)	1-1-10
KEC-SECT-06	LOCATION OF RIVER CROSS SECTION KECHENE (KEC) RIVER (06/08)	1-1-11
KEC-SECT-07	LOCATION OF RIVER CROSS SECTION KECHENE (KEC) RIVER (07/08)	1-1-12
KEC-SECT-08	LOCATION OF RIVER CROSS SECTION KECHENE (KEC) RIVER (08/08)	1-1-13
KEC-SECT-01	LOCATION OF RIVER PROFILE SECTION KECHENE (KEC) RIVER (01/01)	1-1-14
KECR-PLAN-01		1-1-15
KECR-SECT-01	LOCATION OF RIVER CROSS SECTION KECHENE (KECR) RIVER (01/01)	1-1-16
KECR-SECT-02	LOCATION OF RIVER CROSS SECTION KECHENE (KECR) RIVER (01/02)	1-1-17
KECR-SECT-01	LOCATION OF RIVER PROFILE SECTION KECHENE (KECR) RIVER (01/01)	1-1-18
KUR-PLAN-01		1-2-1
KUR-PLAN-02		1-2-2
KUR-PLAN-03		1-2-3
KUR-PLAN-04		1-2-4
KUR-SECT-01	LOCATION OF RIVER CROSS SECTION KURTUME (KUR) RIVER (01/06)	1-2-5
KUR-SECT-02	LOCATION OF RIVER CROSS SECTION KURTUME (KUR) RIVER (02/06)	1-2-6

Drawing No.	Drawing Title	Page
KUR-SECT-03	LOCATION OF RIVER CROSS SECTION KURTUME (KUR) RIVER (03/06)	1-2-7
KUR-SECT-04	LOCATION OF RIVER CROSS SECTION KURTUME (KUR) RIVER (04/06)	1-2-8
KUR-SECT-05	LOCATION OF RIVER CROSS SECTION KURTUME (KUR) RIVER (05/06)	1-2-9
KUR-SECT-06	LOCATION OF RIVER CROSS SECTION KURTUME (KUR) RIVER (06/06)	1-2-10
KUR-SECT-01	LOCATION OF RIVER PROFILE SECTION KURTUME (KUR) RIVER (01/01)	1-2-11
KURL-PLAN-01		1-2-12
KURL-SECT-01	LOCATION OF RIVER CROSS SECTION KURTUME (KURL) RIVER (01/01)	1-2-13
KURL-SECT-01	LOCATION OF RIVER PROFILE SECTION KURTUME (KURL) RIVER (01/01)	1-2-14
KURR1-PLAN-01		1-2-15
KURR1-SECT-01	LOCATION OF RIVER CROSS SECTION KURTUME (KURR1) RIVER (01/02)	1-2-16
KURR1-SECT-02	LOCATION OF RIVER CROSS SECTION KURTUME (KURR1) RIVER (02/02)	1-2-17
KURR1-SECT-01	LOCATION OF RIVER PROFILE SECTION KURTUME (KURR1) RIVER (01/01)	1-2-18
KURR2-PLAN-01		1-2-19
KURR2-SECT-01	LOCATION OF RIVER CROSS SECTION KURTUME (KURR2) RIVER (01/02)	1-2-20
KURR2-SECT-02	LOCATION OF RIVER CROSS SECTION KURTUME (KURR2) RIVER (02/02)	1-2-21
KURR2-SECT-01	LOCATION OF RIVER PROFILE SECTION KURTUME (KURR2) RIVER (01/01)	1-2-22
KURR3-PLAN-01		1-2-23
KURR3-SECT-01	LOCATION OF RIVER CROSS SECTION KURTUME (KURR3) RIVER (01/03)	1-2-24
KURR3-SECT-02	LOCATION OF RIVER CROSS SECTION KURTUME (KURR3) RIVER (02/03)	1-2-25
KURR3-SECT-03	LOCATION OF RIVER CROSS SECTION KURTUME (KURR3) RIVER (03/03)	1-2-26
KURR3-SECT-01	LOCATION OF RIVER PROFILE SECTION KURTUME (KURR3) RIVER (01/01)	1-2-27
BAN-PLAN-01		1-3-1

Drawing No.	Drawing Title	Page
BAN-PLAN-02		1-3-2
BAN-PLAN-03		1-3-3
BAN-PLAN-04		1-3-4
BAN-SECT-01	LOCATION OF RIVER CROSS SECTION BANTYIKETU (BAN) RIVER (01/06)	1-3-5
BAN-SECT-02	LOCATION OF RIVER CROSS SECTION BANTYIKETU (BAN) RIVER (02/06)	1-3-6
BAN-SECT-03	LOCATION OF RIVER CROSS SECTION BANTYIKETU (BAN) RIVER (03/06)	1-3-7
BAN-SECT-04	LOCATION OF RIVER CROSS SECTION BANTYIKETU (BAN) RIVER (04/06)	1-3-8
BAN-SECT-05	LOCATION OF RIVER CROSS SECTION BANTYIKETU (BAN) RIVER (05/06)	1-3-9
BAN-SECT-06	LOCATION OF RIVER CROSS SECTION BANTYIKETU (BAN) RIVER (06/06)	1-3-10
BAN-SECT-01	LOCATION OF RIVER CROSS SECTION BANTYIKETU (BAN) RIVER (01/01)	1-3-11
BAN-SECT-01	LOCATION OF RIVER PROFILE SECTION BANTYIKETU (BAN) RIVER (01/01)	1-3-12
KEB-PLAN-01		1-4-1
KEB-PLAN-02		1-4-2
KEB-PLAN-03		1-4-3
KEB-PLAN-04		1-4-4
KEB-PLAN-05		1-4-5
KEB-PLAN-06		1-4-6
KEB-PLAN-07		1-4-7
KEB-PLAN-08		1-4-8
KEB-PLAN-09		1-4-9
KEB-SECT-01	LOCATION OF RIVER CROSS SECTION KEBENA (KEB) RIVER (01/15)	1-4-10
KEB-SECT-02	LOCATION OF RIVER CROSS SECTION KEBENA (KEB) RIVER (02/15)	1-4-11
KEB-SECT-03	LOCATION OF RIVER CROSS SECTION KEBENA (KEB) RIVER (03/15)	1-4-12
KEB-SECT-04	LOCATION OF RIVER CROSS SECTION KEBENA (KEB) RIVER (04/15)	1-4-13
KEB-SECT-05	LOCATION OF RIVER CROSS SECTION KEBENA (KEB) RIVER (05/15)	1-4-14
KEB-SECT-06	LOCATION OF RIVER CROSS SECTION KEBENA (KEB) RIVER (06/15)	1-4-15

Drawing No.	Drawing Title	Page
KEB-SECT-07	LOCATION OF RIVER CROSS SECTION KEBENA (KEB) RIVER (07/15)	1-4-16
KEB-SECT-08	LOCATION OF RIVER CROSS SECTION KEBENA (KEB) RIVER (08/15)	1-4-17
KEB-SECT-09	LOCATION OF RIVER CROSS SECTION KEBENA (KEB) RIVER (09/15)	1-4-18
KEB-SECT-10	LOCATION OF RIVER CROSS SECTION KEBENA (KEB) RIVER (10/15)	1-4-19
KEB-SECT-11	LOCATION OF RIVER CROSS SECTION KEBENA (KEB) RIVER (11/15)	1-4-20
KEB-SECT-12	LOCATION OF RIVER CROSS SECTION KEBENA (KEB) RIVER (12/15)	1-4-21
KEB-SECT-13	LOCATION OF RIVER CROSS SECTION KEBENA (KEB) RIVER (13/15)	1-4-22
KEB-SECT-14	LOCATION OF RIVER CROSS SECTION KEBENA (KEB) RIVER (14/15)	1-4-23
KEB-SECT-15	LOCATION OF RIVER CROSS SECTION KEBENA (KEB) RIVER (15/15)	1-4-24
KEB-SECT-01	LOCATION OF RIVER CROSS SECTION KEBENA (KEB) RIVER (01/01)	1-4-25
KEB-SECT-01	LOCATION OF RIVER PROFILE SECTION KEBENA (KEB) RIVER (01/02)	1-4-26
KEB-SECT-02	LOCATION OF RIVER PROFILE SECTION KEBENA (KEB) RIVER (02/02)	1-4-27
KEBL-PLAN-01		1-4-28
KEBL-SECT-01	LOCATION OF RIVER CROSS SECTION KEBENA (KEBL) RIVER (01/01)	1-4-29
KEBL-SECT-01	LOCATION OF RIVER PROFILE SECTION KEBENA (KEBL) RIVER (01/01)	1-4-30
GIN-PLAN-01		1-4-31
GIN-PLAN-02		1-4-32
GIN-PLAN-03		1-4-33
GIN-SECT-01	LOCATION OF RIVER CROSS SECTION KEBENA (GIN) RIVER (01/03)	1-4-34
GIN-SECT-02	LOCATION OF RIVER CROSS SECTION KEBENA (GIN) RIVER (02/03)	1-4-35
GIN-SECT-03	LOCATION OF RIVER CROSS SECTION KEBENA (GIN) RIVER (03/03)	1-4-36

Drawing No.	Drawing Title	Page
GIN-SECT-01	LOCATION OF RIVER PROFILE SECTION KEBENA (GIN) RIVER (01/01)	1-4-37
ABO-PLAN-01		1-4-38
ABO-SECT-01	LOCATION OF RIVER CROSS SECTION KEBENA (ABO) RIVER (01/03)	1-4-39
ABO-SECT-02	LOCATION OF RIVER CROSS SECTION KEBENA (ABO) RIVER (02/03)	1-4-40
ABO-SECT-03	LOCATION OF RIVER CROSS SECTION KEBENA (ABO) RIVER (03/03)	1-4-41
ABO-SECT-01	LOCATION OF RIVER PROFILE SECTION KEBENA (ABO) RIVER (01/01)	1-4-42
ABOR-PLAN-01		1-4-43
ABOR-SECT-01	LOCATION OF RIVER CROSS SECTION KEBENA (ABOR) RIVER (01/01)	1-4-44
ABOR-SECT-01	LOCATION OF RIVER PROFILE SECTION KEBENA (ABOR) RIVER (01/01)	1-4-45
LAK-PLAN-01		1-5-1
LAK-PLAN-02		1-5-2
LAK-PLAN-03		1-5-3
LAK-PLAN-04		1-5-4
LAK-PLAN-05		1-5-5
LAK-PLAN-06		1-5-6
LAK-PLAN-07		1-5-7
LAK-PLAN-08		1-5-8
LAK-PLAN-09		1-5-9
LAK-PLAN-10		1-5-10
LAK-PLAN-11		1-5-11
LAK-SECT-01	LOCATION OF RIVER CROSS SECTION LITTLE AKAKI (LAK) RIVER (01/16)	1-5-12
LAK-SECT-02	LOCATION OF RIVER CROSS SECTION LITTLE AKAKI (LAK) RIVER (02/16)	1-5-13
LAK-SECT-03	LOCATION OF RIVER CROSS SECTION LITTLE AKAKI (LAK) RIVER (03/16)	1-5-14
LAK-SECT-04	LOCATION OF RIVER CROSS SECTION LITTLE AKAKI (LAK) RIVER (04/16)	1-5-15
LAK-SECT-05	LOCATION OF RIVER CROSS SECTION LITTLE AKAKI (LAK) RIVER (05/16)	1-5-16
LAK-SECT-06	LOCATION OF RIVER CROSS SECTION LITTLE AKAKI (LAK) RIVER (06/16)	1-5-17

Drawing No.	Drawing Title	Page
LAK-SECT-07	LOCATION OF RIVER CROSS SECTION LITTLE AKAKI (LAK) RIVER (07/16)	1-5-18
LAK-SECT-08	LOCATION OF RIVER CROSS SECTION LITTLE AKAKI (LAK) RIVER (08/16)	1-5-19
LAK-SECT-09	LOCATION OF RIVER CROSS SECTION LITTLE AKAKI (LAK) RIVER (09/16)	1-5-20
LAK-SECT-10	LOCATION OF RIVER CROSS SECTION LITTLE AKAKI (LAK) RIVER (10/16)	1-5-21
LAK-SECT-11	LOCATION OF RIVER CROSS SECTION LITTLE AKAKI (LAK) RIVER (11/16)	1-5-22
LAK-SECT-12	LOCATION OF RIVER CROSS SECTION LITTLE AKAKI (LAK) RIVER (12/16)	1-5-23
LAK-SECT-13	LOCATION OF RIVER CROSS SECTION LITTLE AKAKI (LAK) RIVER (13/16)	1-5-24
LAK-SECT-14	LOCATION OF RIVER CROSS SECTION LITTLE AKAKI (LAK) RIVER (14/16)	1-5-25
LAK-SECT-15	LOCATION OF RIVER CROSS SECTION LITTLE AKAKI (LAK) RIVER (15/16)	1-5-26
LAK-SECT-16	LOCATION OF RIVER CROSS SECTION LITTLE AKAKI (LAK) RIVER (16/16)	1-5-27
LAK-SECT-01	LOCATION OF RIVER CROSS SECTION LITTLE AKAKI (LAK) RIVER (01/01)	1-5-28
LAK-SECT-01	LOCATION OF RIVER PROFILE SECTION LITTLE AKAKI (LAK) RIVER (01/02)	1-5-29
LAK-SECT-02	LOCATION OF RIVER PROFILE SECTION LITTLE AKAKI (LAK) RIVER (02/02)	1-5-30
LAKLI-PLAN-01		1-5-31
LAKLI-SECT-01	LOCATION OF RIVER CROSS SECTION LITTLE AKAKI (LAKLI) RIVER (01/01)	1-5-32
LAKLI-SECT-01	LOCATION OF RIVER PROFILE SECTION LITTLE AKAKI (LAKLI) RIVER (01/01)	1-5-33
LAKL2-PLAN-01		1-5-34
LAKL2-SECT-01	LOCATION OF RIVER CROSS SECTION LITTLE AKAKI (LAKL2) RIVER (01/01)	1-5-35
LAKL2-SECT-01	LOCATION OF RIVER PROFILE SECTION LITTLE AKAKI (LAKL2) RIVER (01/01)	1-5-36
LAKRI-PLAN-01		1-5-37

Drawing No.	Drawing Title	Page
LAKR1-SECT-01	LOCATION OF RIVER CROSS SECTION LITTLE AKAKI (LAKR1) RIVER (01/01)	1-5-38
LAKR1-SECT-01	LOCATION OF RIVER PROFILE SECTION LITTLE AKAKI (LAKR1) RIVER (01/01)	1-5-39
LAKR2-PLAN-01		1-5-40
LAKR2-SECT-01	LOCATION OF RIVER CROSS SECTION LITTLE AKAKI (LAKR2) RIVER (01/01)	1-5-41
LAKR2-SECT-01	LOCATION OF RIVER PROFILE SECTION LITTLE AKAKI (LAKR2) RIVER (01/01)	1-5-42
FER-PLAN-01		1-5-43
FER-SECT-01	LOCATION OF RIVER CROSS SECTION LITTLE AKAKI (FER) RIVER (01/02)	1-5-44
FER-SECT-02	LOCATION OF RIVER CROSS SECTION LITTLE AKAKI (FER) RIVER (02/02)	1-5-45
FER-SECT-01	LOCATION OF RIVER PROFILE SECTION LITTLE AKAKI (FER) RIVER (01/01)	1-5-46
BUH-PLAN-01		1-5-47
BUH-PLAN-02		1-5-48
BUH-SECT-01	LOCATION OF RIVER CROSS SECTION LITTLE AKAKI (BUH) RIVER (01/02)	1-5-49
BUH-SECT-02	LOCATION OF RIVER CROSS SECTION LITTLE AKAKI (BUH) RIVER (02/02)	1-5-50
BUH-SECT-01	LOCATION OF RIVER PROFILE SECTION LITTLE AKAKI (BUH) RIVER (01/01)	1-5-51
WAK-PLAN-01		1-6-1
WAK-PLAN-02		1-6-2
WAK-PLAN-03		1-6-3
WAK-PLAN-04		1-6-4
WAK-PLAN-05		1-6-5
WAK-PLAN-06		1-6-6
WAK-PLAN-07		1-6-7
WAK-PLAN-08		1-6-8
WAK-PLAN-09		1-6-9
WAK-SECT-01	LOCATION OF RIVER CROSS SECTION WEST AKAKI (WAK) RIVER (01/11)	1-6-10
WAK-SECT-02	LOCATION OF RIVER CROSS SECTION WEST AKAKI (WAK) RIVER (02/11)	1-6-11
WAK-SECT-03	LOCATION OF RIVER CROSS SECTION WEST AKAKI (WAK) RIVER (03/11)	1-6-12

Drawing No.	Drawing Title	Page
WAK-SECT-04	LOCATION OF RIVER CROSS SECTION WEST AKAKI (WAK) RIVER (04/11)	1-6-13
WAK-SECT-05	LOCATION OF RIVER CROSS SECTION WEST AKAKI (WAK) RIVER (05/11)	1-6-14
WAK-SECT-06	LOCATION OF RIVER CROSS SECTION WEST AKAKI (WAK) RIVER (06/11)	1-6-15
WAK-SECT-07	LOCATION OF RIVER CROSS SECTION WEST AKAKI (WAK) RIVER (07/11)	1-6-16
WAK-SECT-08	LOCATION OF RIVER CROSS SECTION WEST AKAKI (WAK) RIVER (08/11)	1-6-17
WAK-SECT-09	LOCATION OF RIVER CROSS SECTION WEST AKAKI (WAK) RIVER (09/11)	1-6-18
WAK-SECT-10	LOCATION OF RIVER CROSS SECTION WEST AKAKI (WAK) RIVER (10/11)	1-6-19
WAK-SECT-11	LOCATION OF RIVER CROSS SECTION WEST AKAKI (WAK) RIVER (11/11)	1-6-20
WAK-SECT-01	LOCATION OF RIVER PROFILE SECTION WEST AKAKI (WAK) RIVER (01/02)	1-6-21
WAK-SECT-02	LOCATION OF RIVER PROFILE SECTION WEST AKAKI (WAK) RIVER (02/02)	1-6-22
HAN-PLAN-01		1-7-1
HAN-PLAN-02		1-7-2
HAN-PLAN-03		1-7-3
HAN-SECT-01	LOCATION OF RIVER CROSS SECTION HANKU (HAN) RIVER (01/03)	1-7-4
HAN-SECT-02	LOCATION OF RIVER CROSS SECTION HANKU (HAN) RIVER (02/03)	1-7-5
HAN-SECT-03	LOCATION OF RIVER CROSS SECTION HANKU (HAN) RIVER (03/03)	1-7-6
HAN-SECT-01	LOCATION OF RIVER PROFILE SECTION HANKU (HAN) RIVER (01/01)	1-7-7
HANL-PLAN-01		1-7-8
HANL-SECT-01	LOCATION OF RIVER CROSS SECTION HANKU (HANL) RIVER (01/01)	1-7-9
HANL-SECT-01	LOCATION OF RIVER PROFILE SECTION HANKU (HANL) RIVER (01/01)	1-7-10
HANR-PLAN-01		1-7-11
HANR-SECT-01	LOCATION OF RIVER CROSS SECTION HANKU (HANR) RIVER (01/01)	1-7-12



Drawing No.	Drawing Title	Page
HANR-SECT-01	LOCATION OF RIVER PROFILE SECTION HANKU (HANR) RIVER (01/01)	1-7-13
PER-PLAN-01		1-8-1
PER-PLAN-02		1-8-2
PER-PLAN-03		1-8-3
PER-SECT-01	LOCATION OF RIVER CROSS SECTION PERENNIAL (PER) RIVER (01/03)	1-8-4
PER-SECT-02	LOCATION OF RIVER CROSS SECTION PERENNIAL (PER) RIVER (02/03)	1-8-5
PER-SECT-03	LOCATION OF RIVER CROSS SECTION PERENNIAL (PER) RIVER (03/03)	1-8-6
PER-SECT-01	LOCATION OF RIVER PROFILE SECTION PERENNIAL (PER) RIVER (01/01)	1-8-7

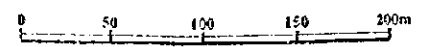

THE STUDY ON ADDIS ABABA FLOOD CONTROL PROJECT  
IN THE FEDERAL DEMOCRATIC REPUBLIC OF ETHIOPIA

JAPAN INTERNATIONAL COOPERATION AGENCY  
REGION 14 ADMINISTRATION

DRAWING NO.	
KEC-PLAN-01	

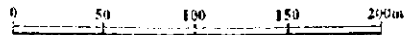

THE STUDY ON ADDIS ABABA FLOOD CONTROL PROJECT IN THE FEDERAL DEMOCRATIC REPUBLIC OF ETHIOPIA	
JAPAN INTERNATIONAL COOPERATION AGENCY REGION 14 ADMINISTRATION	
DRAWING NO.	
KEC-PLAN-02	

No.43,44,55,56

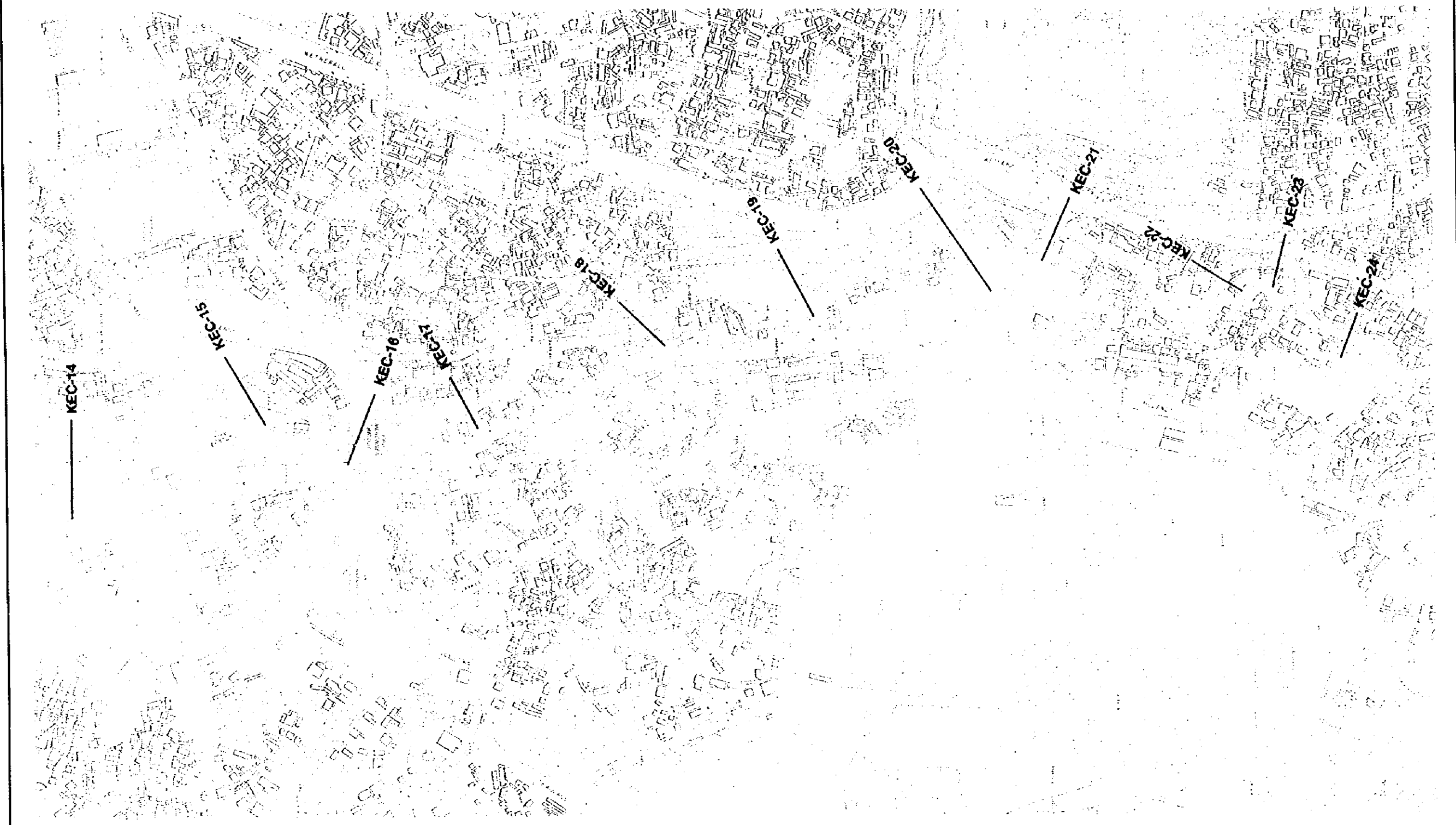

THE STUDY ON ADDIS ABABA FLOOD CONTROL PROJECT  
IN THE FEDERAL DEMOCRATIC REPUBLIC OF ETHIOPIA

JAPAN INTERNATIONAL COOPERATION AGENCY  
REGION 14 ADMINISTRATION

DRAWING NO.  
KEC-PLAN-03

--

No.31,32,43,44

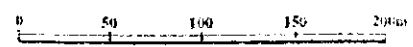

THE STUDY ON ADDIS ABABA FLOOD CONTROL PROJECT  
IN THE FEDERAL DEMOCRATIC REPUBLIC OF ETHIOPIA

JAPAN INTERNATIONAL COOPERATION AGENCY  
REGION 14 ADMINISTRATION

DRAWING NO.  
KEC-PLAN-04

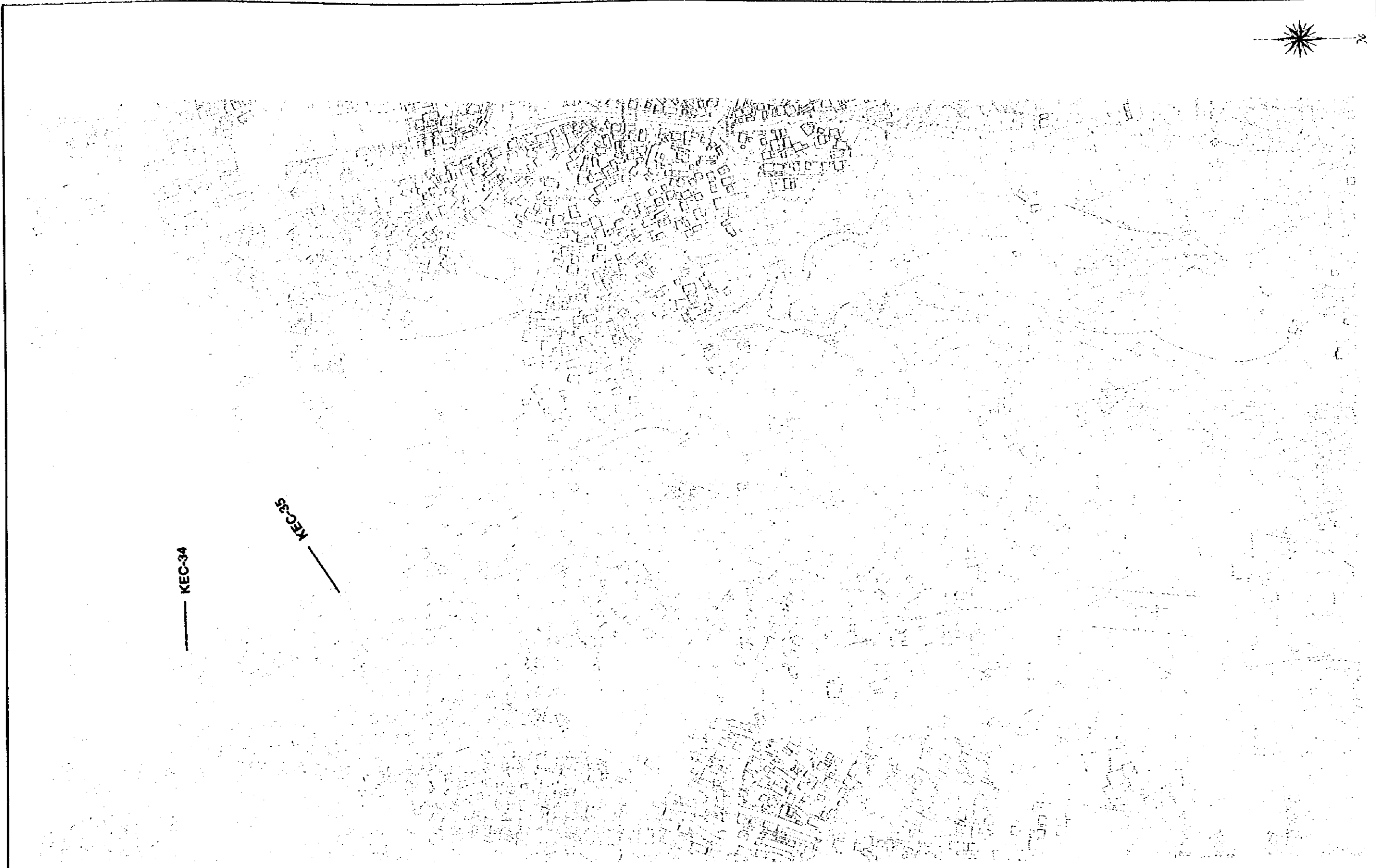

— KEC-34

— KEC-35

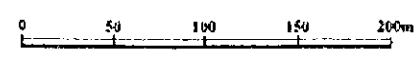

THE STUDY ON ADDIS ABABA FLOOD CONTROL PROJECT  
IN THE FEDERAL DEMOCRATIC REPUBLIC OF ETHIOPIA

JAPAN INTERNATIONAL COOPERATION AGENCY  
REGION 14 ADMINISTRATION

DRAWING NO.	
KEC-PLAN-05	

Cross Section S=1:200

KEC-01

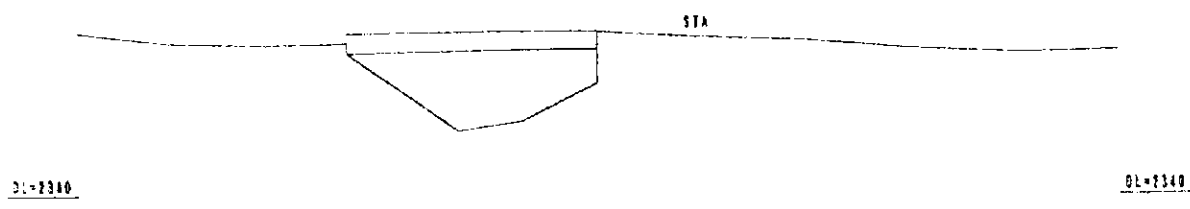

KEC-04

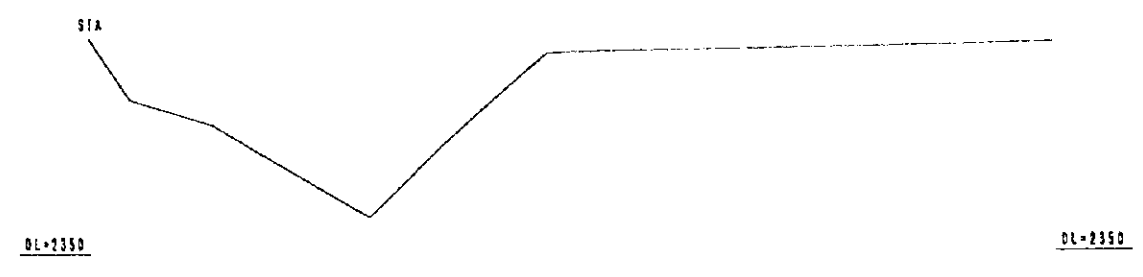

KEC-02

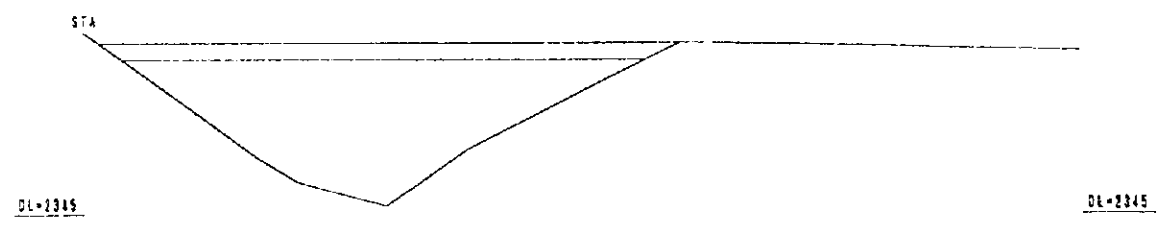

KEC-05

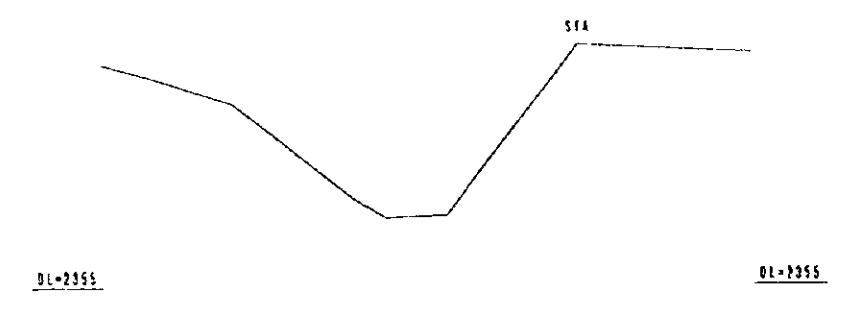

KEC-03

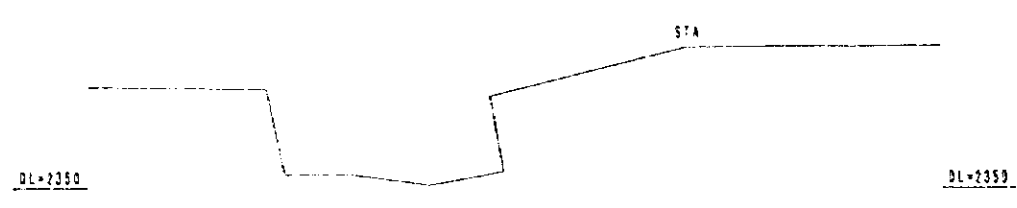

KEC-06

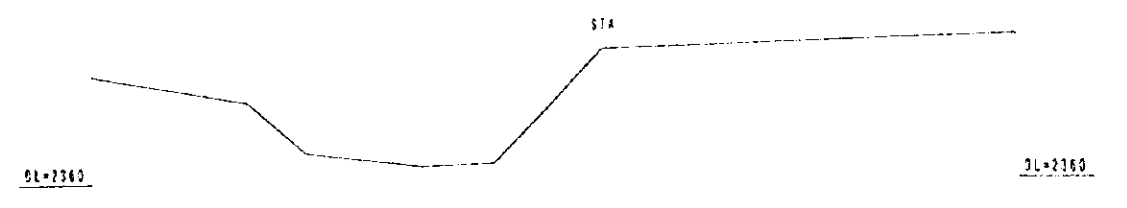

THE STUDY ON ADDIS ABABA FLOOD CONTROL PROJECT IN THE FEDERAL DEMOCRATIC REPUBLIC OF ETHIOPIA	
JAPAN INTERNATIONAL COOPERATION AGENCY REGION 14 ADMINISTRATION	
DRAWING NO. KEC-SECT-01	LOCATION OF RIVER CROSS SECTION KECHENE (KEC) RIVER (01/03)

Cross Section S=1:200

KEC-07

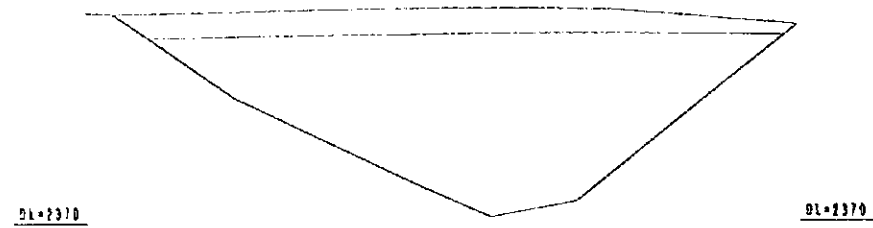

KEC-10



KEC-08

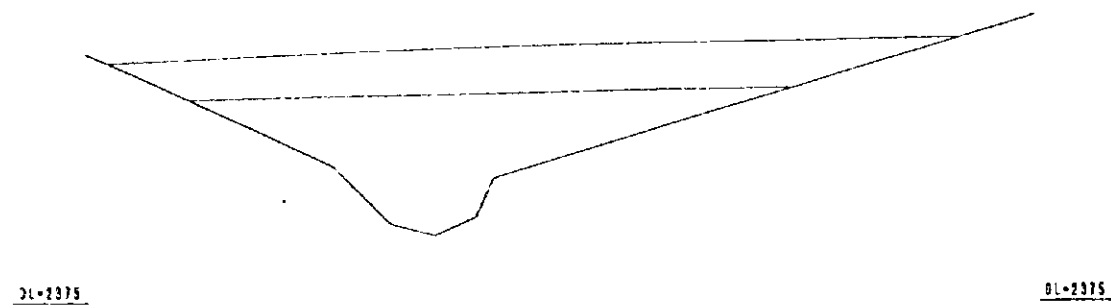

KEC-11

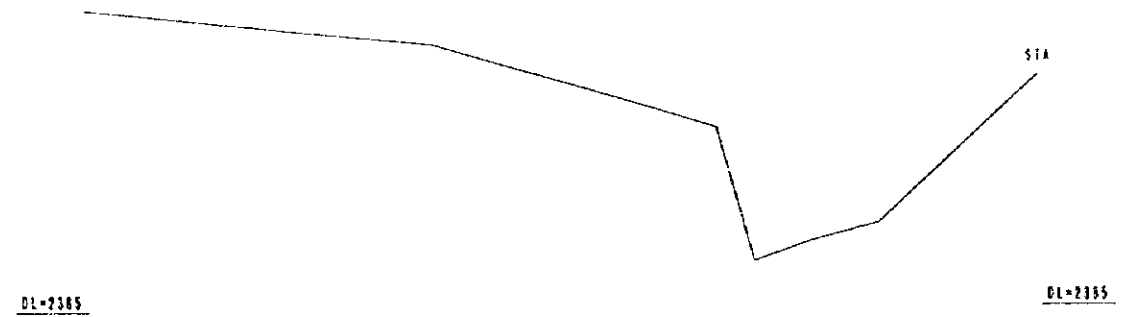

KEC-09



KEC-12

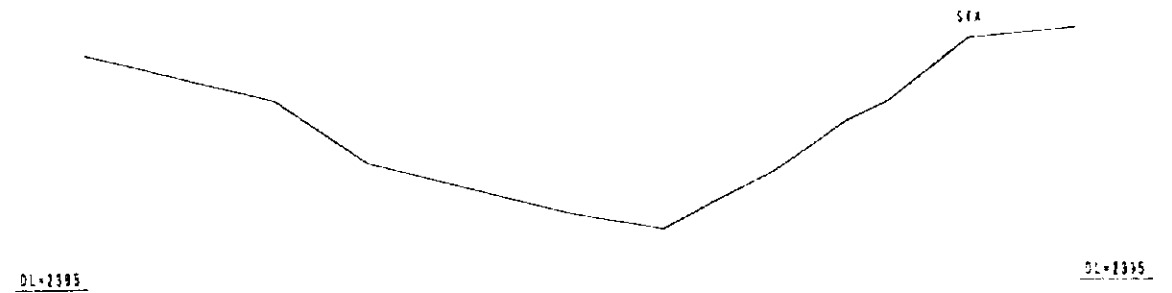

THE STUDY ON ADDIS ABABA FLOOD CONTROL PROJECT IN THE FEDERAL DEMOCRATIC REPUBLIC OF ETHIOPIA	
JAPAN INTERNATIONAL COOPERATION AGENCY REGION 14 ADMINISTRATION	
DRAWING NO. KEC-SECT-02	LOCATION OF RIVER CROSS SECTION KECHENE (KEC) RIVER (02/08)



Cross Section S=1:200

KEC-13

DL-2403

STA

DL-2409

KEC-15

STA

DL-2420

DL-2420

KEC-16

KEC

STA

DL-2439

DL-2439

KEC-14

DL-2410

STA

DL-2410

THE STUDY ON ADDIS ABABA FLOOD CONTROL PROJECT  
IN THE FEDERAL DEMOCRATIC REPUBLIC OF ETHIOPIA

JAPAN INTERNATIONAL COOPERATION AGENCY  
REGION 14 ADMINISTRATION

DRAWING NO.  
KEC-SECT-03

LOCATION OF RIVER CROSS SECTION  
KECHENE (KEC) RIVER (03/03)

Cross Section S=1:200

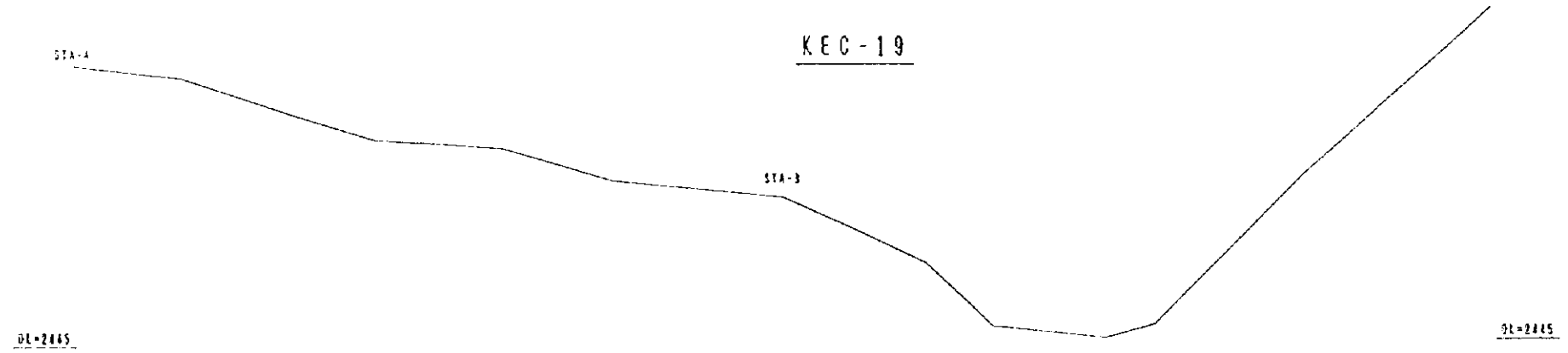
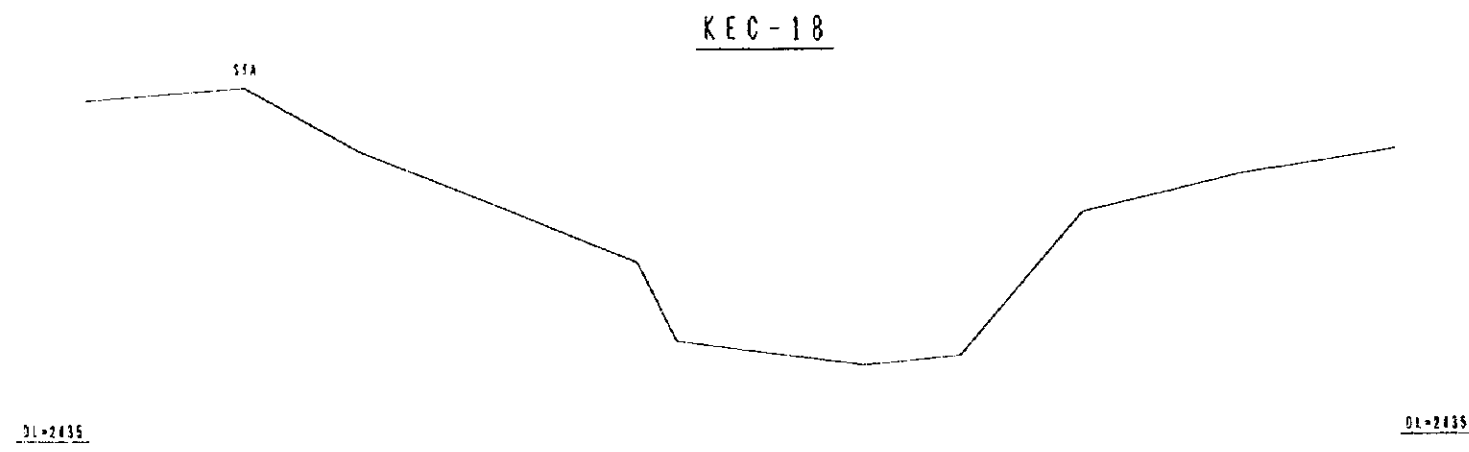
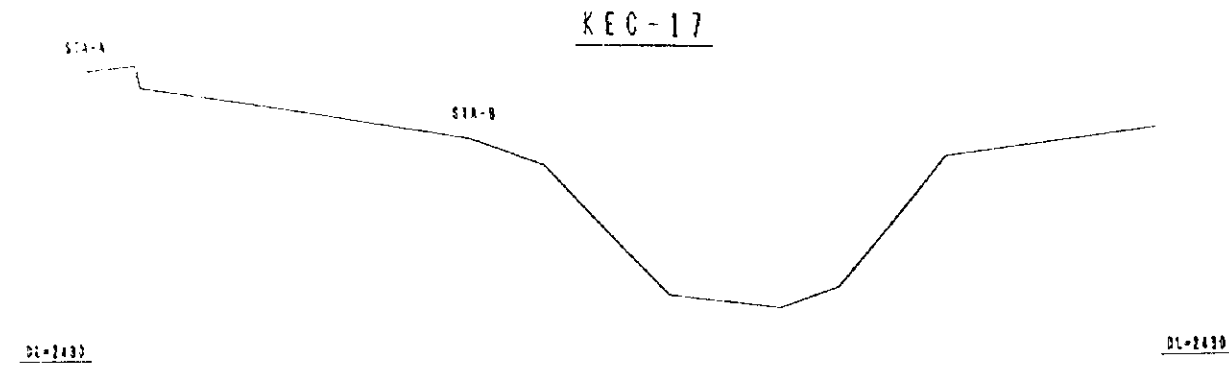

THE STUDY ON ADDIS ABABA FLOOD CONTROL PROJECT IN THE FEDERAL DEMOCRATIC REPUBLIC OF ETHIOPIA	
JAPAN INTERNATIONAL COOPERATION AGENCY REGION 14 ADMINISTRATION	
DRAWING NO. KEC-SECT-04	LOCATION OF RIVER CROSS SECTION KECHENE (KEC) RIVER (04/08)

Cross Section S=1:200

KEC-20

STA

DL-2445

DL-2445

KEC-21

KEC-23

DL-2450

DL-2450

DL-2455

DL-2455

STA

KEC-22

KEC-24

DL-2455

DL-2455

DL-2455

DL-2455

STA

STA

THE STUDY ON ADDIS ABABA FLOOD CONTROL PROJECT  
IN THE FEDERAL DEMOCRATIC REPUBLIC OF ETHIOPIA

JAPAN INTERNATIONAL COOPERATION AGENCY  
REGION 14 ADMINISTRATION

DRAWING NO.  
KEC-SECT-05

LOCATION OF RIVER CROSS SECTION  
KECHENE (KEC) RIVER (05/08)

Cross Section S=1:200

KEC-25

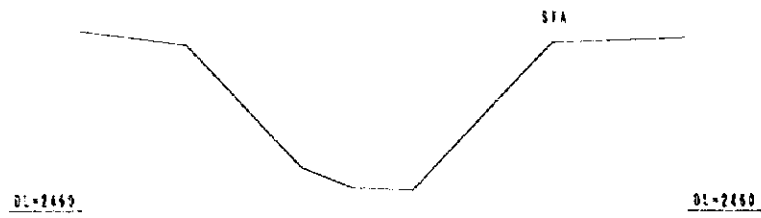

KEC-28

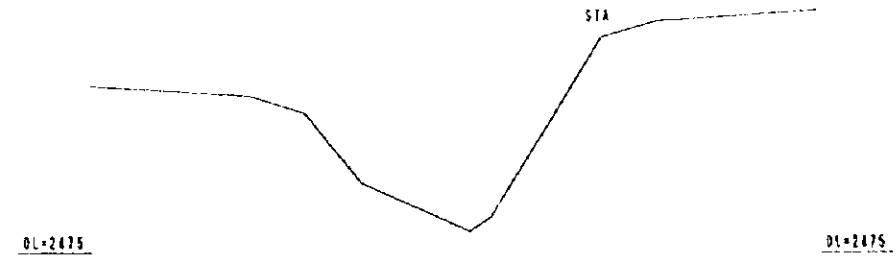

KEC-26

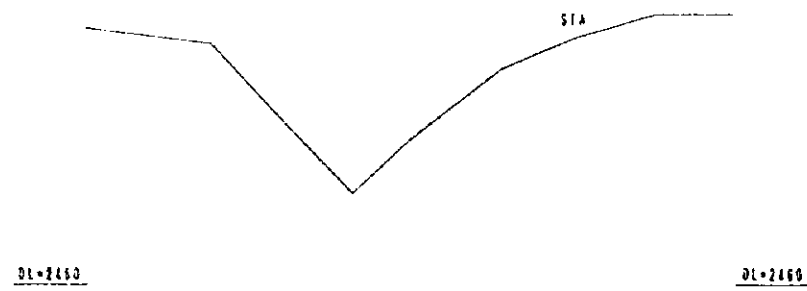

KEC-29

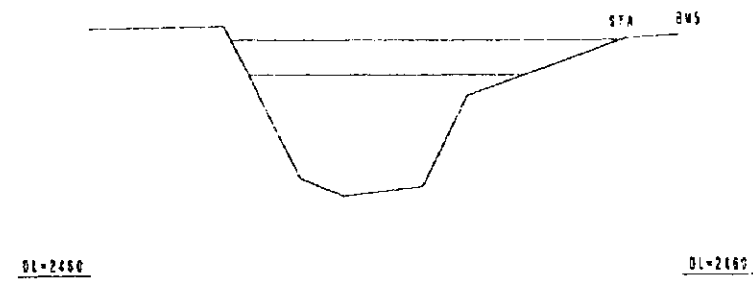

KEC-27

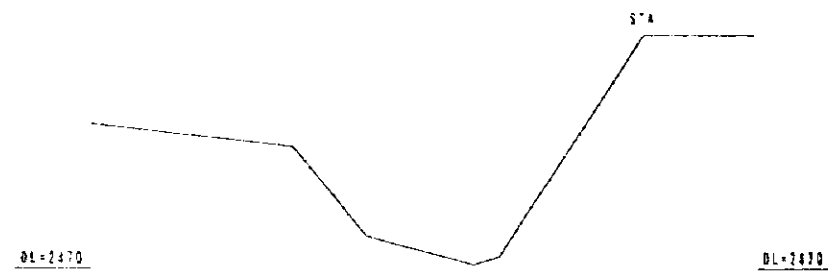

KEC-30

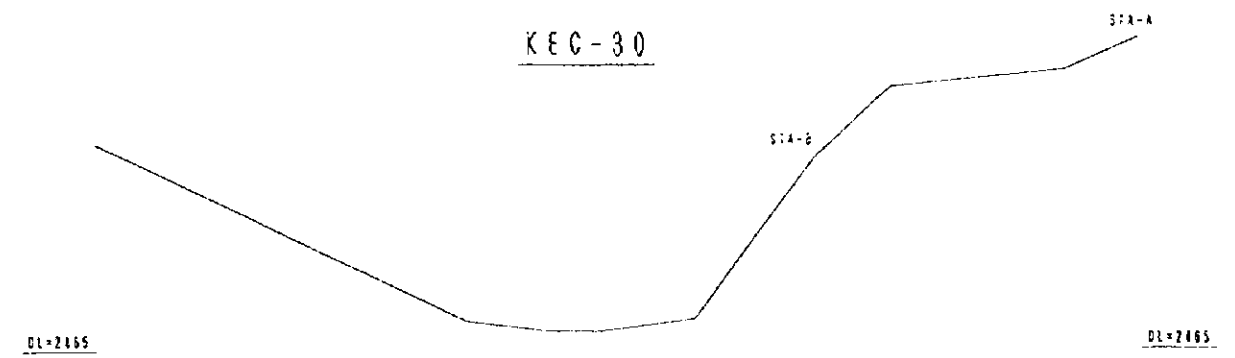

THE STUDY ON ADDIS ABABA FLOOD CONTROL PROJECT  
IN THE FEDERAL DEMOCRATIC REPUBLIC OF ETHIOPIA

JAPAN INTERNATIONAL COOPERATION AGENCY  
REGION 14 ADMINISTRATION

DRAWING NO. KEC-SECT-05	LOCATION OF RIVER CROSS SECTION KECHENE (KEC) RIVER (06/08)
----------------------------	--

Cross Section S=1:200

KEC-31

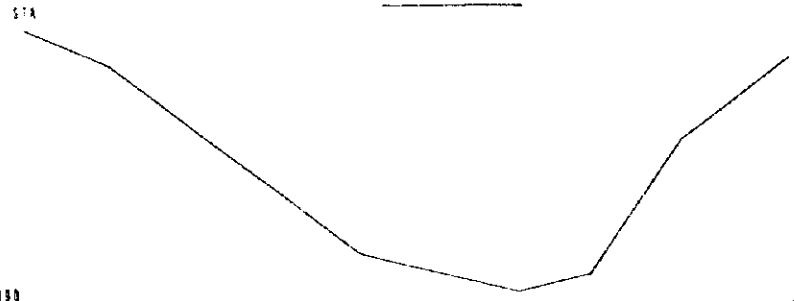

KEC-31 (a)

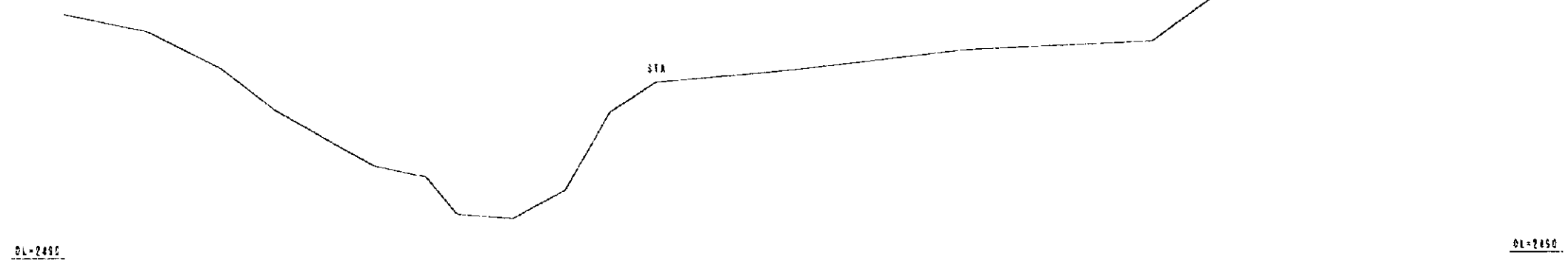

KEC-07

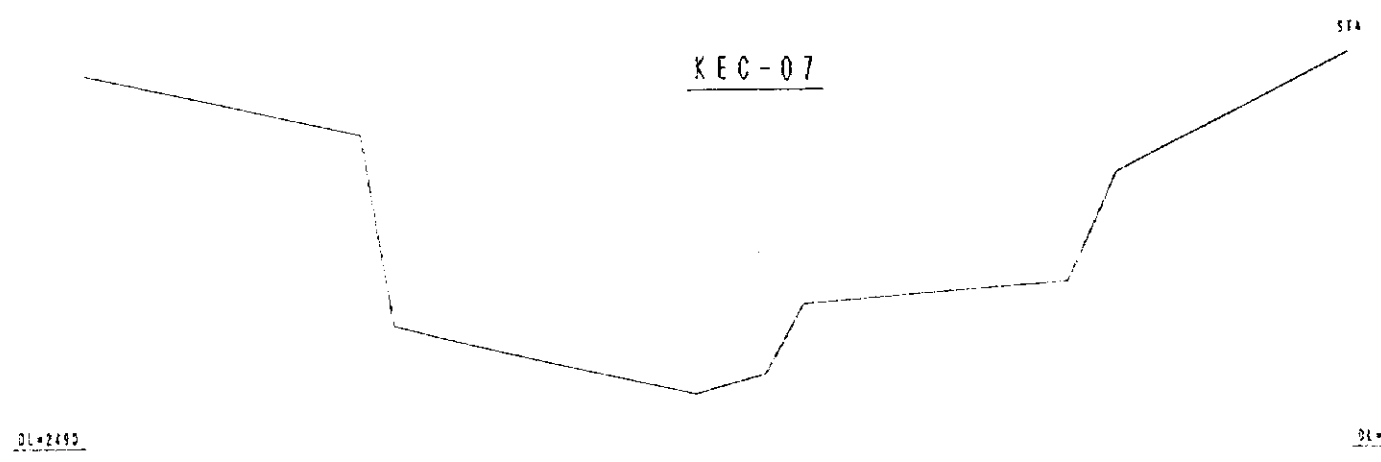

THE STUDY ON ADDIS ABABA FLOOD CONTROL PROJECT IN THE FEDERAL DEMOCRATIC REPUBLIC OF ETHIOPIA	
JAPAN INTERNATIONAL COOPERATION AGENCY	
REGION II ADMINISTRATION	
DRAWING NO. KEC-SECT-07	LOCATION OF RIVER CROSS SECTION KECHENE (KEC) RIVER (07/08)

Cross Section S=1:200

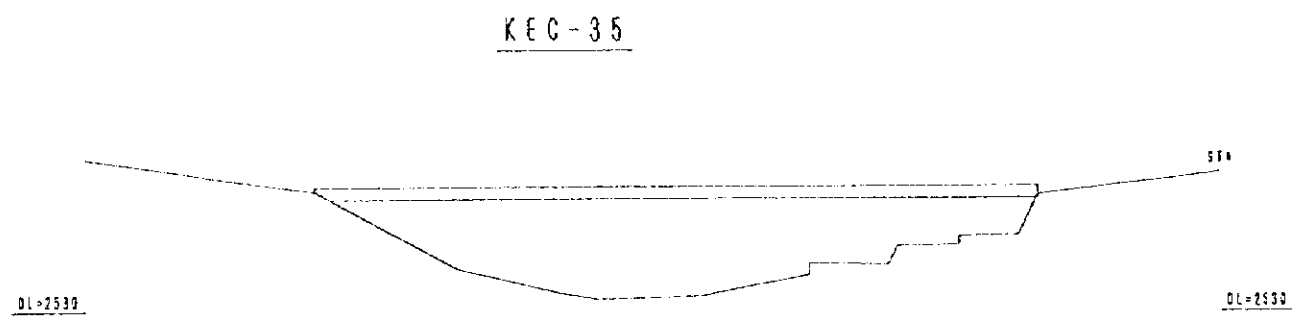
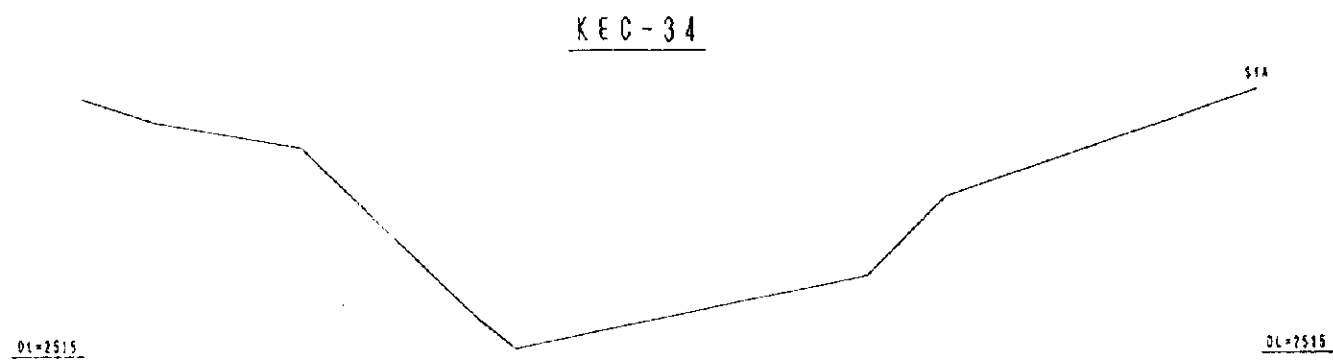
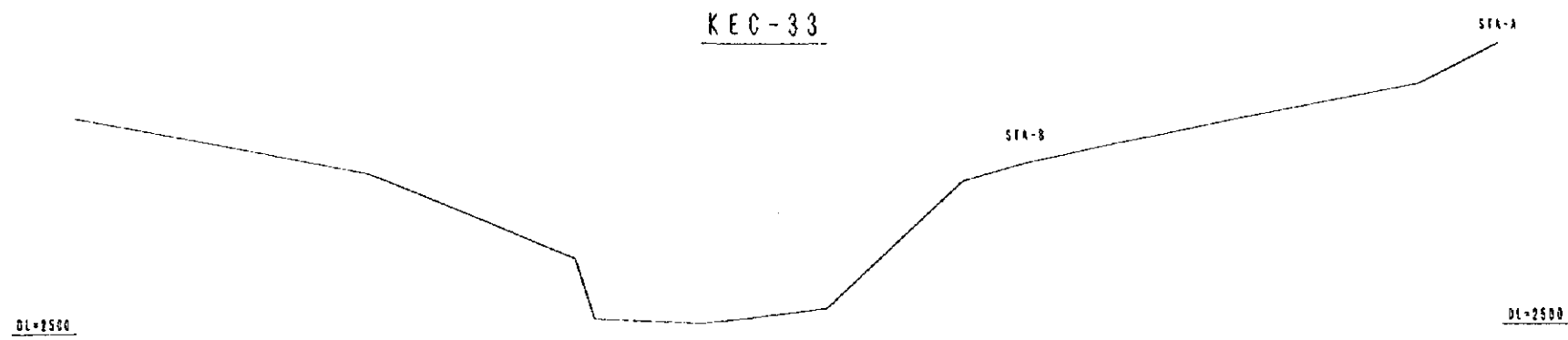

THE STUDY ON ADDIS ABABA FLOOD CONTROL PROJECT IN THE FEDERAL DEMOCRATIC REPUBLIC OF ETHIOPIA	
JAPAN INTERNATIONAL COOPERATION AGENCY REGION 14 ADMINISTRATION	
DRAWING NO. KEC-SECT-08	LOCATION OF RIVER CROSS SECTION KECHENE (KEC) RIVER (08/93)

Profile Section V=1:500  
H=1:20000

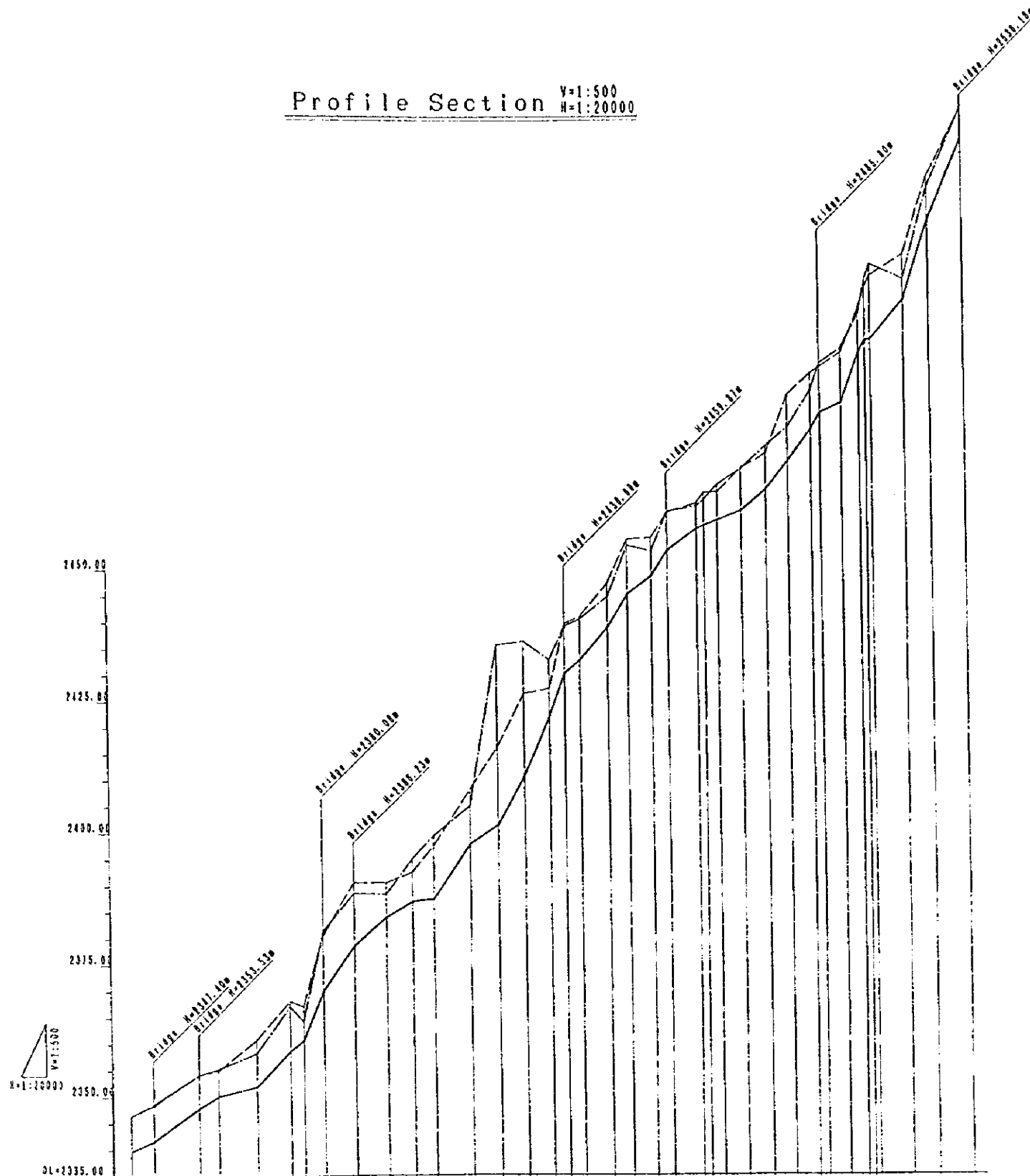

Station No.	Left Bank	Right Bank	River Bed	Accumulate D.	Distance
0	2355.97	2355.56	2355.48	0.0	0.0
1	2356.42	2356.01	2355.93	174.0	174.0
2	2356.87	2356.46	2356.38	348.0	348.0
3	2357.32	2356.91	2356.83	522.0	522.0
4	2357.77	2357.36	2357.28	696.0	696.0
5	2358.22	2357.81	2357.73	870.0	870.0
6	2358.67	2358.26	2358.18	1044.0	1044.0
7	2359.12	2358.71	2358.63	1218.0	1218.0
8	2359.57	2359.16	2359.08	1392.0	1392.0
9	2360.02	2359.61	2359.53	1566.0	1566.0
10	2360.47	2360.06	2359.98	1740.0	1740.0
11	2360.92	2360.51	2360.43	1914.0	1914.0
12	2361.37	2360.96	2360.88	2088.0	2088.0
13	2361.82	2361.41	2361.33	2262.0	2262.0
14	2362.27	2361.86	2361.78	2436.0	2436.0
15	2362.72	2362.31	2362.23	2610.0	2610.0
16	2363.17	2362.76	2362.68	2784.0	2784.0
17	2363.62	2363.21	2363.13	2958.0	2958.0
18	2364.07	2363.66	2363.58	3132.0	3132.0
19	2364.52	2364.11	2364.03	3306.0	3306.0
20	2364.97	2364.56	2364.48	3480.0	3480.0
21	2365.42	2365.01	2364.93	3654.0	3654.0
22	2365.87	2365.46	2365.38	3828.0	3828.0
23	2366.32	2365.91	2365.83	4002.0	4002.0
24	2366.77	2366.36	2366.28	4176.0	4176.0
25	2367.22	2366.81	2366.73	4350.0	4350.0
26	2367.67	2367.26	2367.18	4524.0	4524.0
27	2368.12	2367.71	2367.63	4698.0	4698.0
28	2368.57	2368.16	2368.08	4872.0	4872.0
29	2369.02	2368.61	2368.53	5046.0	5046.0
30	2369.47	2369.06	2368.98	5220.0	5220.0
31	2369.92	2369.51	2369.43	5394.0	5394.0
32	2370.37	2369.96	2369.88	5568.0	5568.0
33	2370.82	2370.41	2370.33	5742.0	5742.0
34	2371.27	2370.86	2370.78	5916.0	5916.0
35	2371.72	2371.31	2371.23	6090.0	6090.0

Left Bank	———
Right Bank	-----
River Bed	———

THE STUDY ON ADDIS ABABA FLOOD CONTROL PROJECT  
IN THE FEDERAL DEMOCRATIC REPUBLIC OF ETHIOPIA  
JAPAN INTERNATIONAL COOPERATION AGENCY  
REGION 14 ADMINISTRATION  
DRAWING NO. LOCATION OF RIVER PROFILE SECTION  
KEC-SECT-31 KECHENE (KEC) RIVER (01/01)

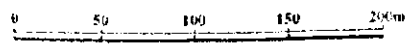

THE STUDY ON ADDIS ABABA FLOOD CONTROL PROJECT  
IN THE FEDERAL DEMOCRATIC REPUBLIC OF ETHIOPIA

JAPAN INTERNATIONAL COOPERATION AGENCY  
REGION 14 ADMINISTRATION

DRAWING NO.  
KECR-PLAN-01



Cross Section S=1:200

KECR-01

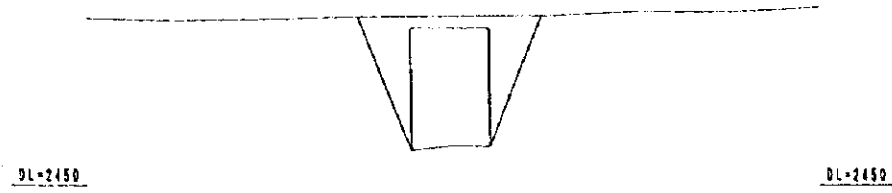

KECR-04

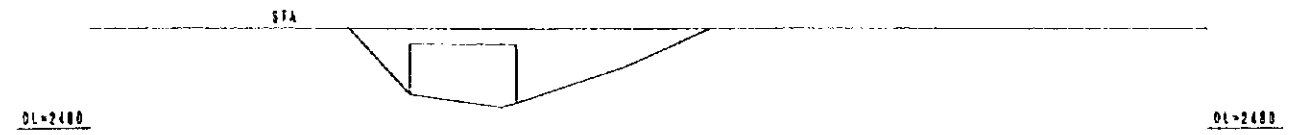

KECR-02

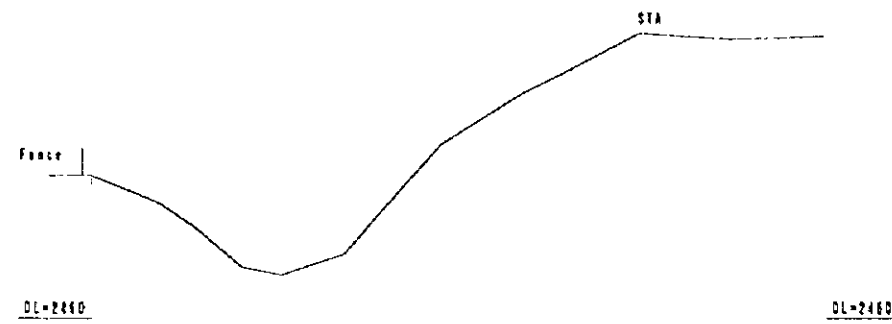

KECR-05

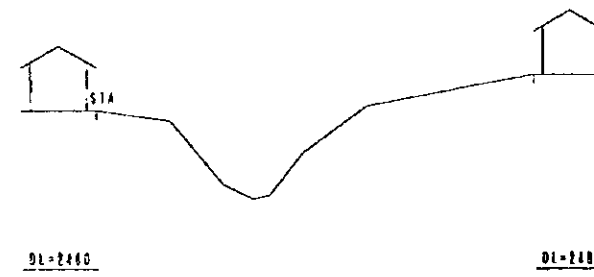

KECR-03

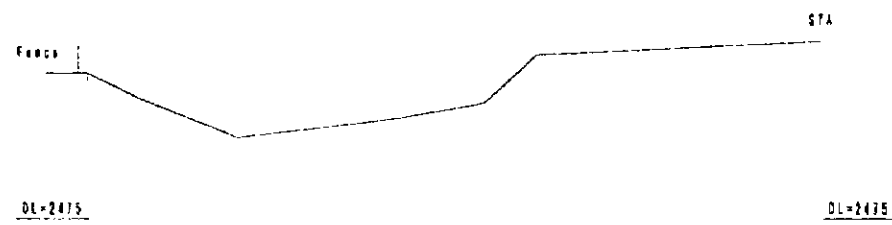

KECR-06



THE STUDY ON ADDIS ABABA FLOOD CONTROL PROJECT IN THE FEDERAL DEMOCRATIC REPUBLIC OF ETHIOPIA	
JAPAN INTERNATIONAL COOPERATION AGENCY REGION 14 ADMINISTRATION	
DRAWING NO. KECR-SECT-01	LOCATION OF RIVER CROSS SECTION KECHENE (KECR) RIVER (01/01)

Cross Section S=1:200

KECR-07

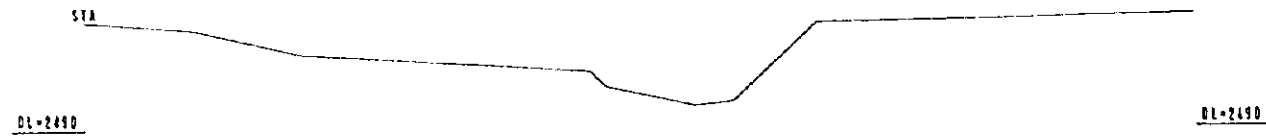

KECR-08

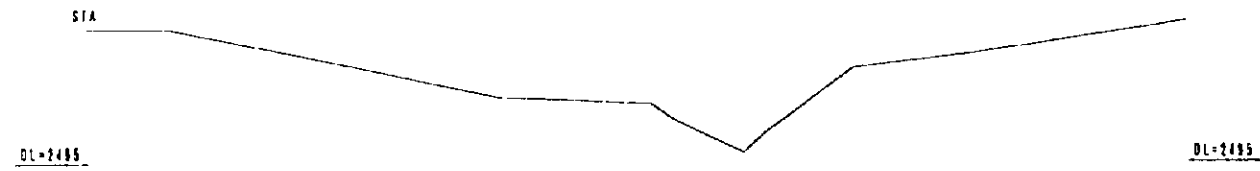

KECR-09

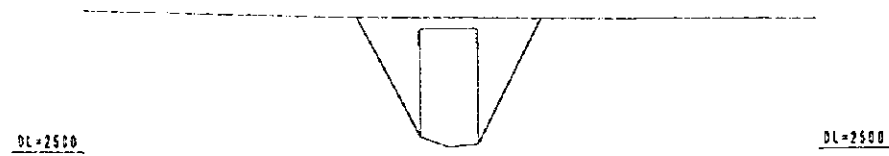

THE STUDY ON ADDIS ABABA FLOOD CONTROL PROJECT IN THE FEDERAL DEMOCRATIC REPUBLIC OF ETHIOPIA	
JAPAN INTERNATIONAL COOPERATION AGENCY REGION 14 ADMINISTRATION	
DRAWING NO. KECR-SECT-02	LOCATION OF RIVER CROSS SECTION KECHENE (KECR) RIVER (01/02)

Profile Section  $V=1:500$   
 $H=1:10000$

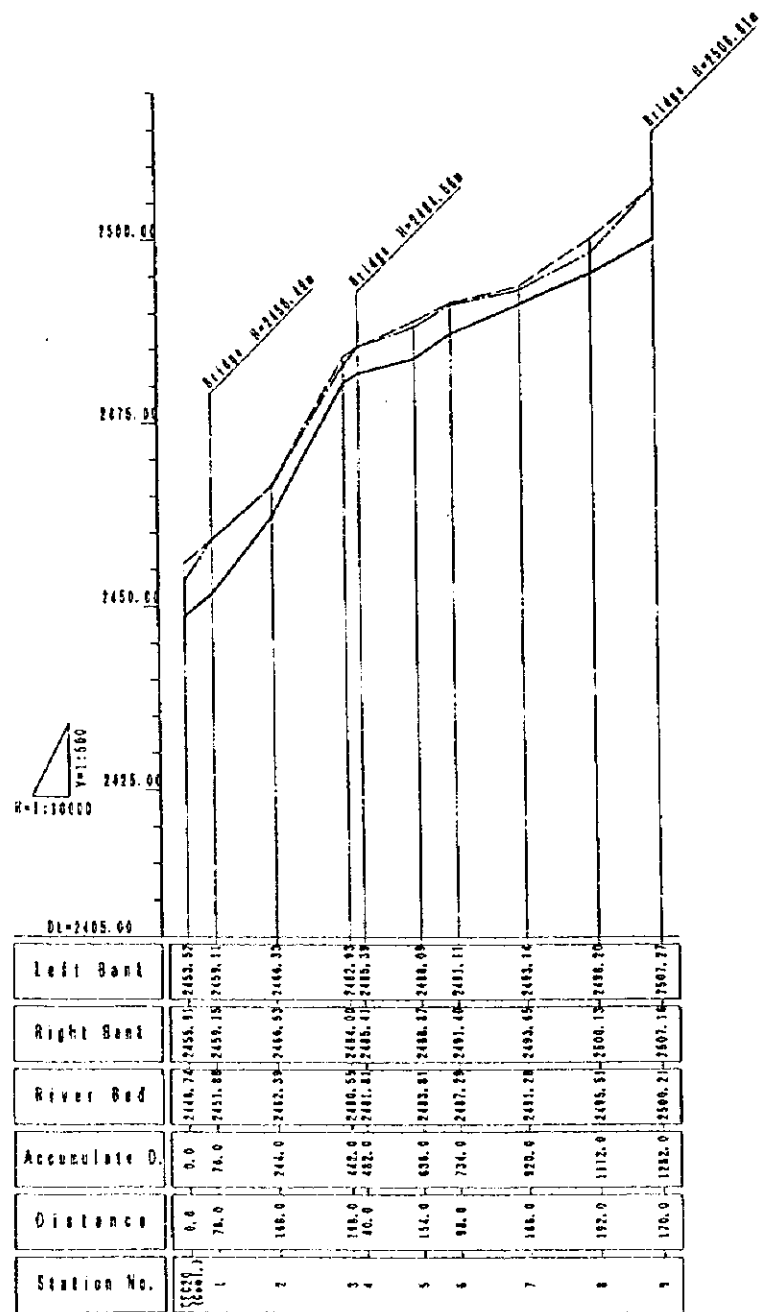

Left Bank	———
Right Bank	-----
River Bed	———

THE STUDY ON ADDIS ABABA FLOOD CONTROL PROJECT  
IN THE FEDERAL DEMOCRATIC REPUBLIC OF ETHIOPIA

JAPAN INTERNATIONAL COOPERATION AGENCY  
REGION 14 ADMINISTRATION

DRAWING NO. LOCATION OF RIVER PROFILE SECTION  
KECR-SECT-03 KECHENE (KECR) RIVER (01/03)

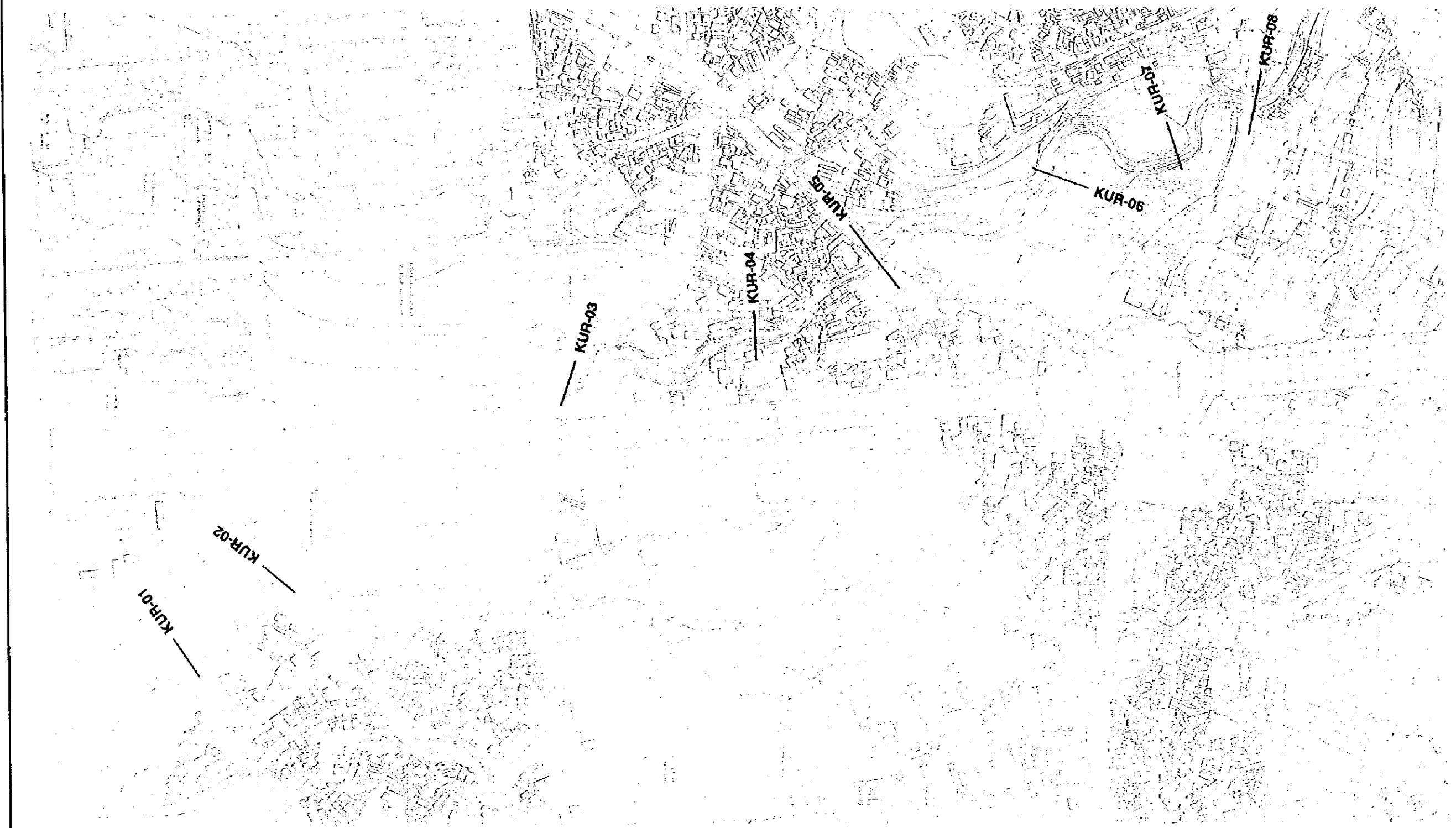

THE STUDY ON ADDIS ABABA FLOOD CONTROL PROJECT  
IN THE FEDERAL DEMOCRATIC REPUBLIC OF ETHIOPIA

JAPAN INTERNATIONAL COOPERATION AGENCY  
REGION 14 ADMINISTRATION

DRAWING NO.  
KUR-PLAN-01

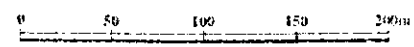
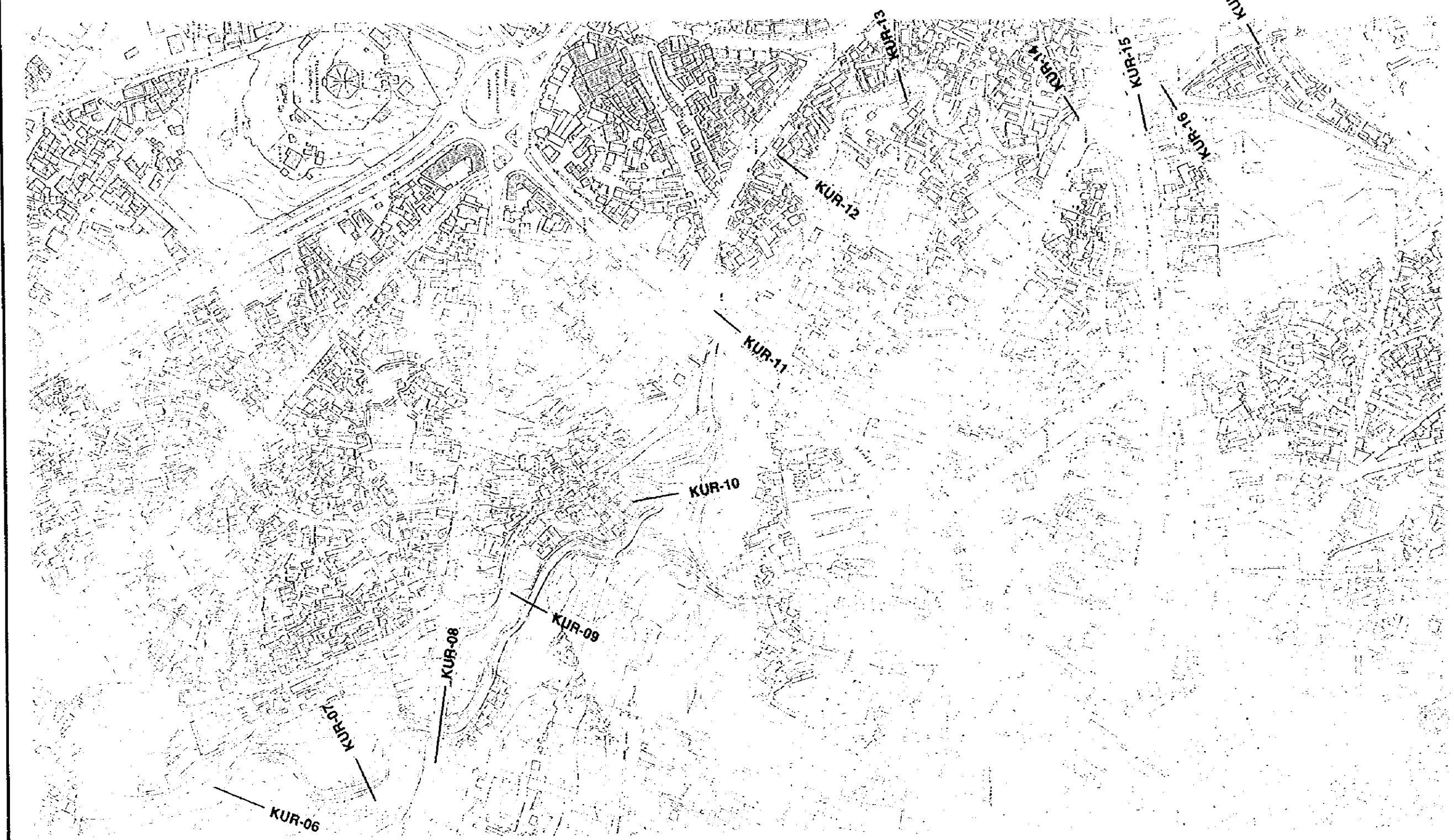

THE STUDY ON ADDIS ABABA FLOOD CONTROL PROJECT IN THE FEDERAL DEMOCRATIC REPUBLIC OF ETHIOPIA	
JAPAN INTERNATIONAL COOPERATION AGENCY REGION 14 ADMINISTRATION	
DRAWING NO.	
KUR-PLAN-02	

No.42,43,54,55

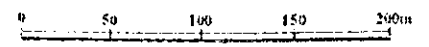
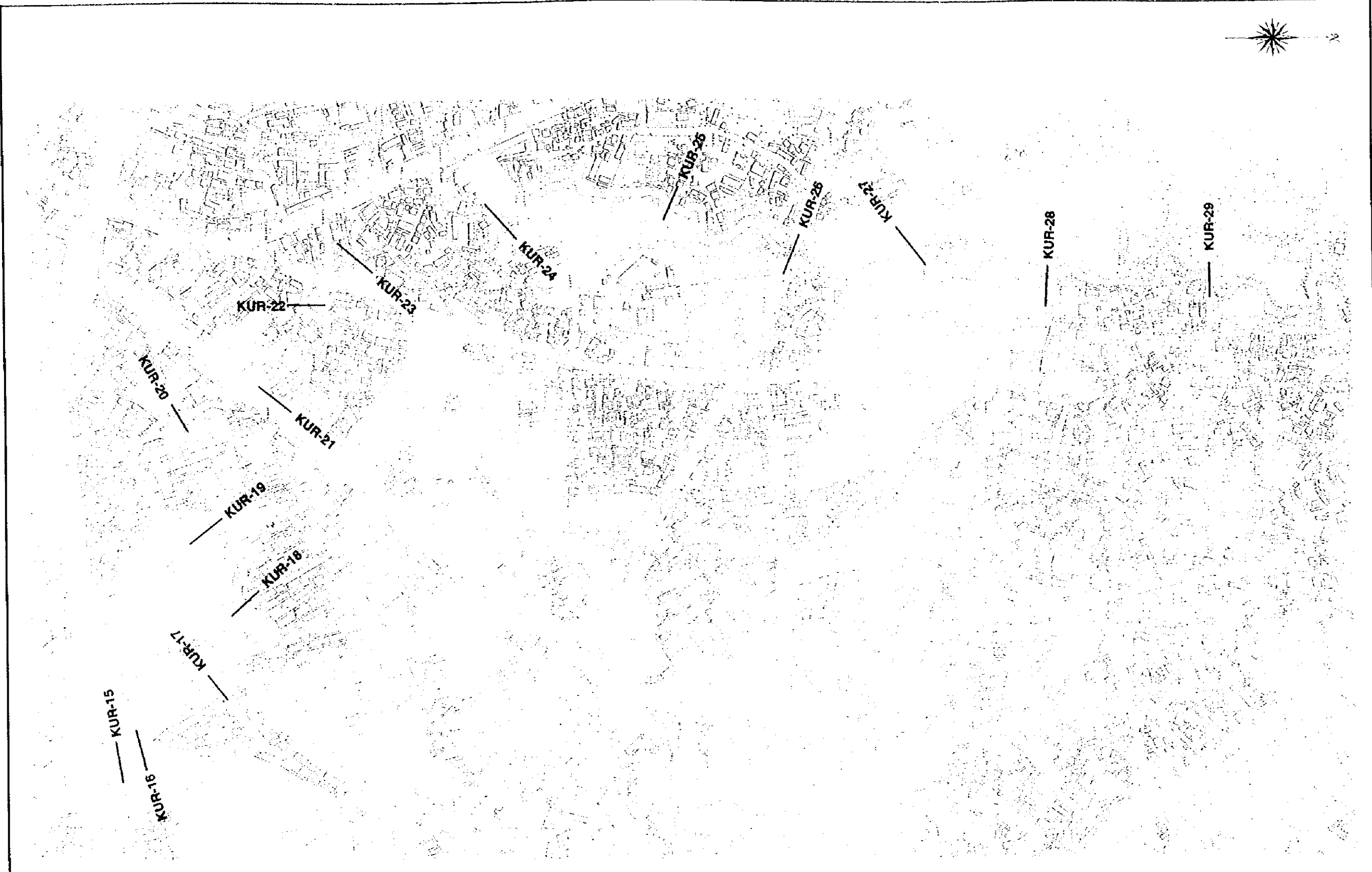

THE STUDY ON ADDIS ABABA FLOOD CONTROL PROJECT IN THE FEDERAL DEMOCRATIC REPUBLIC OF ETHIOPIA	
JAPAN INTERNATIONAL COOPERATION AGENCY REGION 14 ADMINISTRATION	
DRAWING NO.	
KUR-PLAN-03	

No.30,42

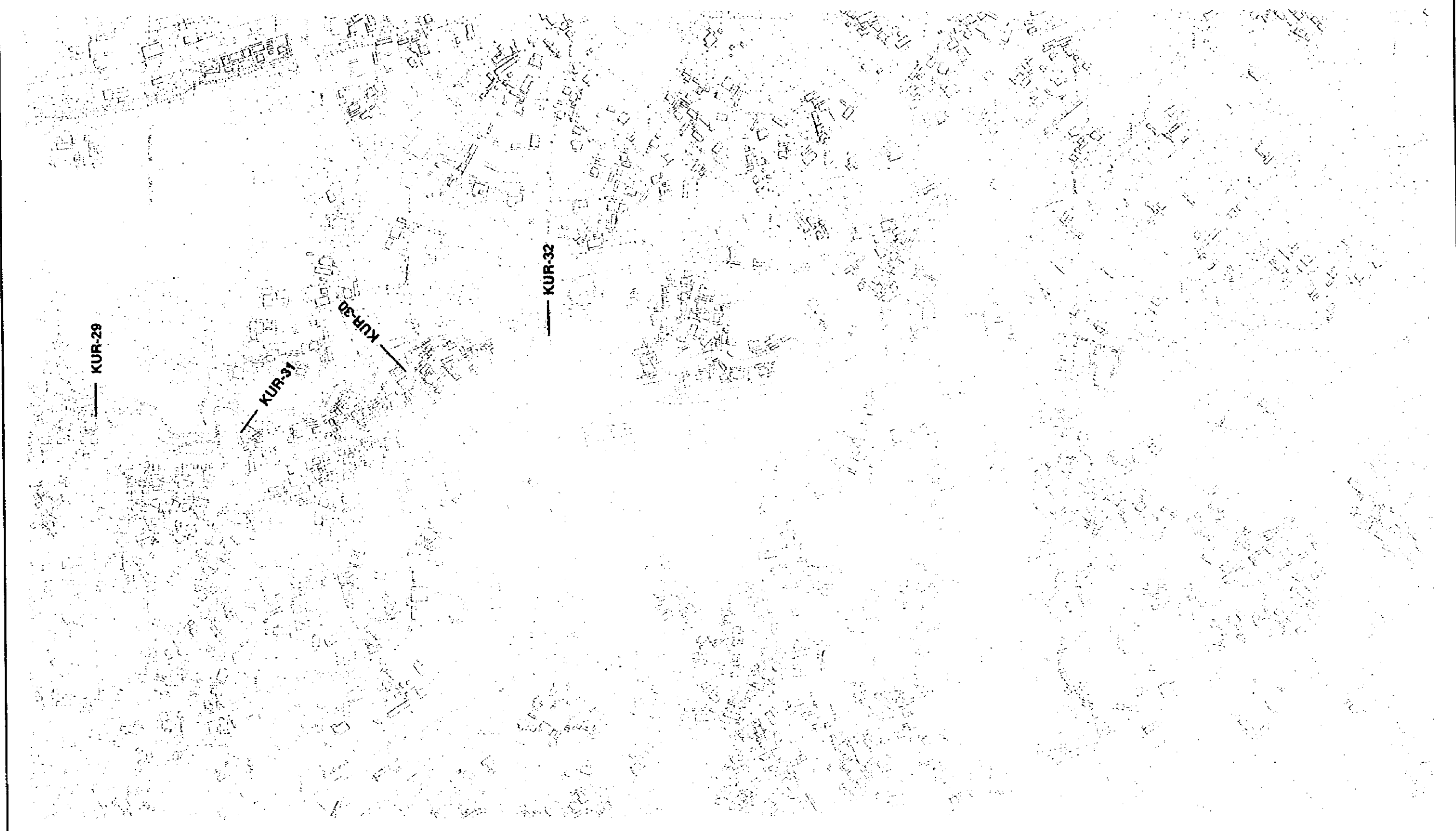

THE STUDY ON ADDIS ABABA FLOOD CONTROL PROJECT IN THE FEDERAL DEMOCRATIC REPUBLIC OF ETHIOPIA	
JAPAN INTERNATIONAL COOPERATION AGENCY REGION 14 ADMINISTRATION	
DRAWING NO. KUR-PLAN-04	

Cross Section S=1:200

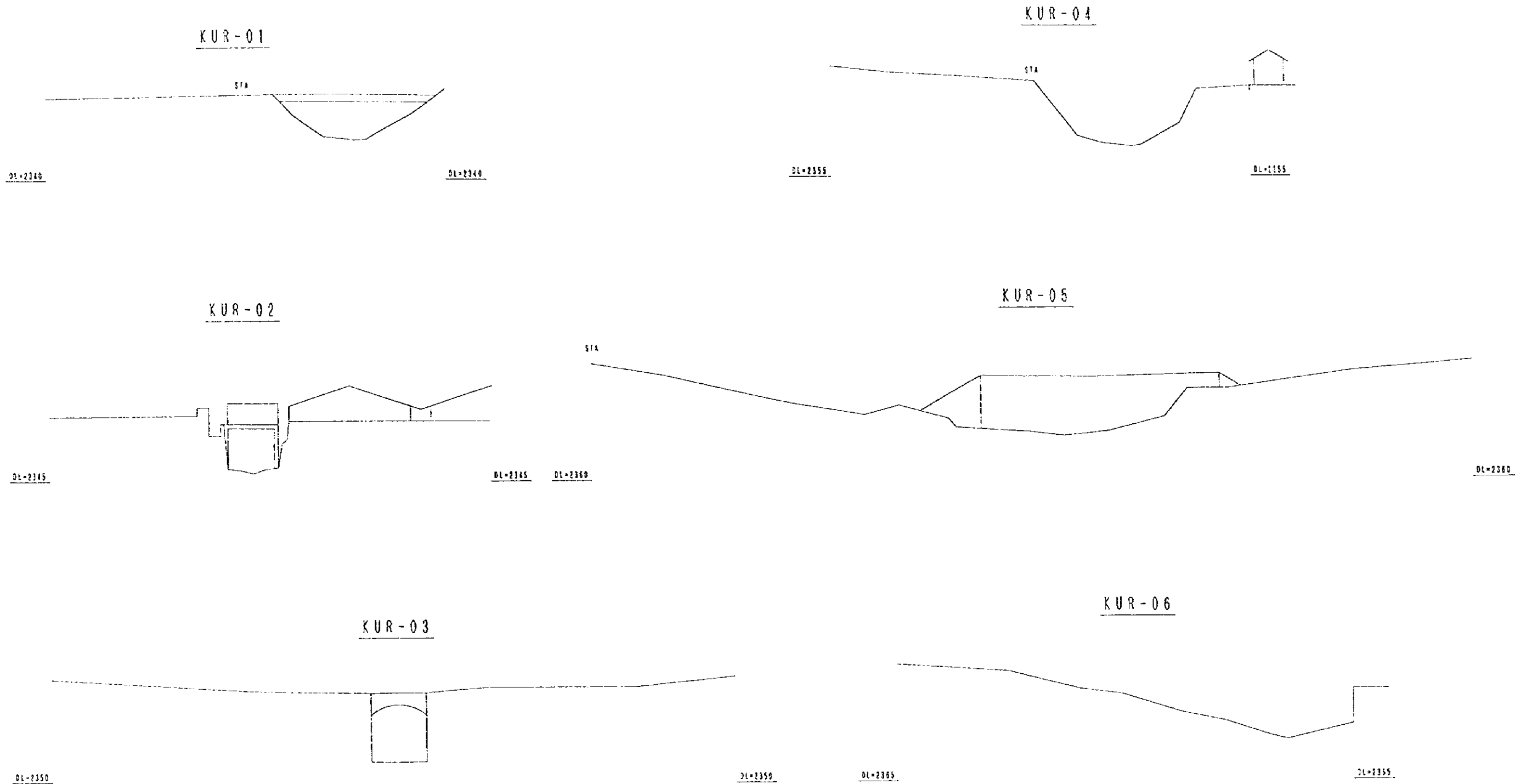

THE STUDY ON ADDIS ABABA FLOOD CONTROL PROJECT IN THE FEDERAL DEMOCRATIC REPUBLIC OF ETHIOPIA	
JAPAN INTERNATIONAL COOPERATION AGENCY REGION 14 ADMINISTRATION	
DRAWING NO. KUR-SECT-01	LOCATION OF RIVER CROSS SECTION KURTUNE (KUR) RIVER (01/06)



Cross Section S=1:200

KUR-07

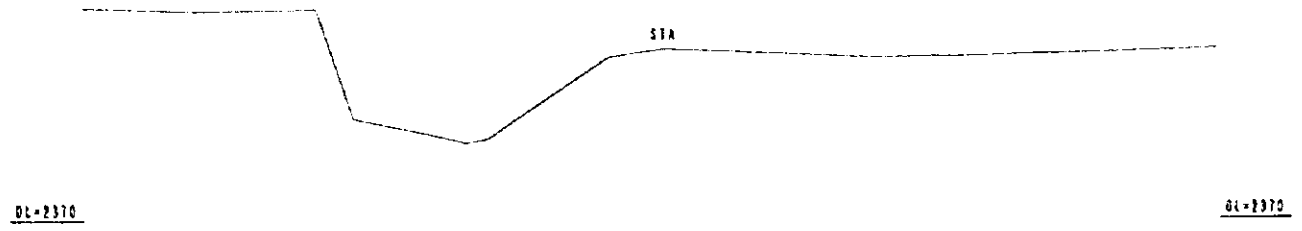

KUR-10

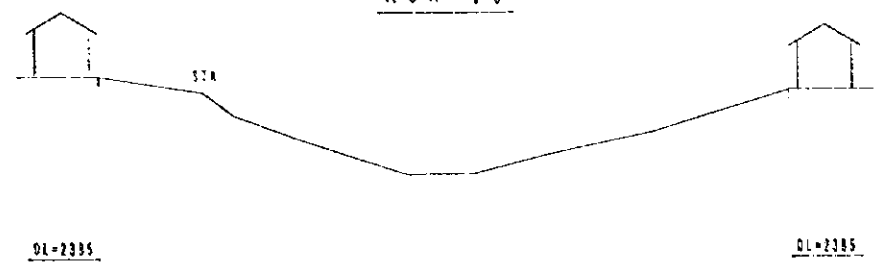

KUR-08

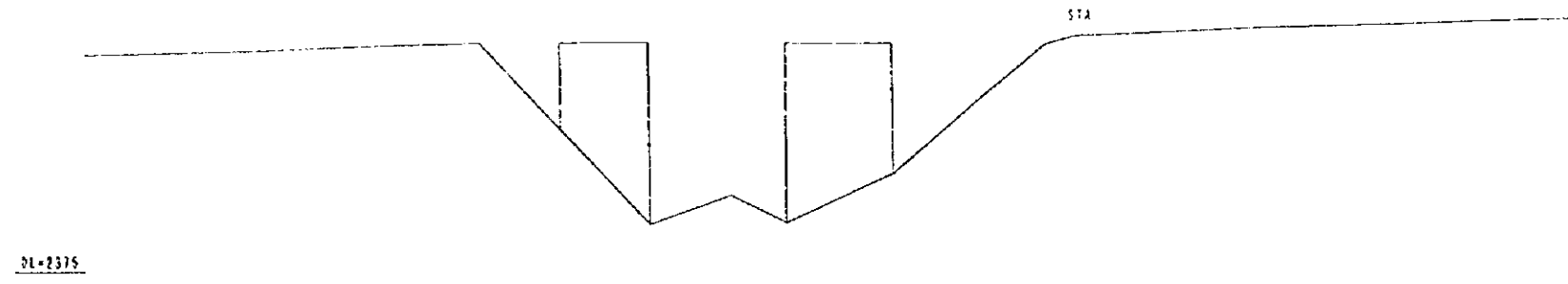

KUR-11

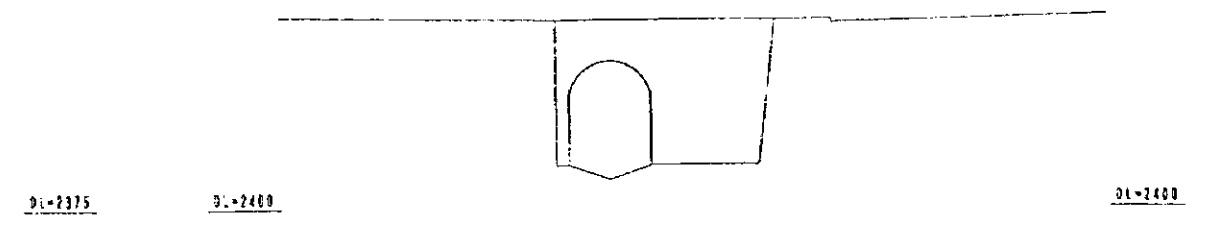

KUR-09

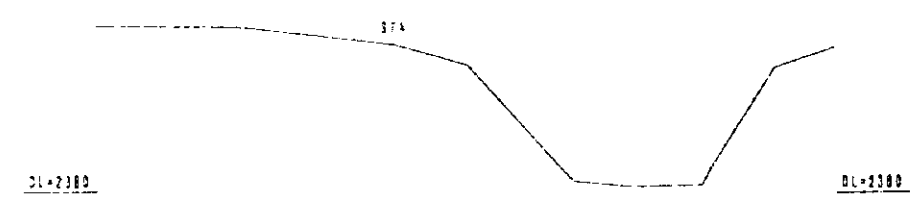

KUR-12

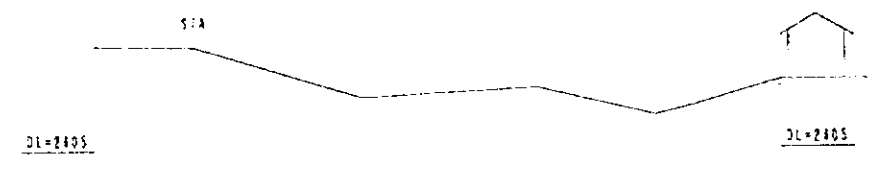

THE STUDY ON ADDIS ABABA FLOOD CONTROL PROJECT IN THE FEDERAL DEMOCRATIC REPUBLIC OF ETHIOPIA	
JAPAN INTERNATIONAL COOPERATION AGENCY REGION 14 ADMINISTRATION	
DRAWING NO. KUR-SECT-02	LOCATION OF RIVER CROSS SECTION KURTUME (KUR) RIVER (02/06)

Cross Section S=1:200

KUR-13



KUR-16



KUR-14

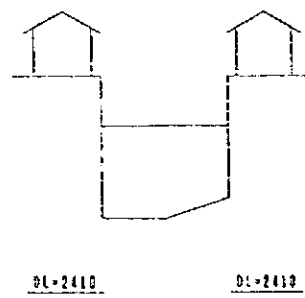

KUR-17



KUR-15

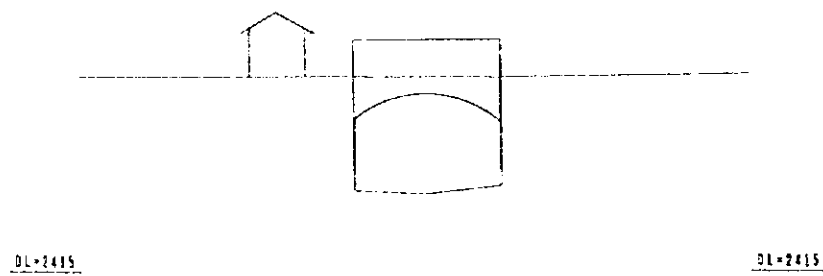

KUR-18

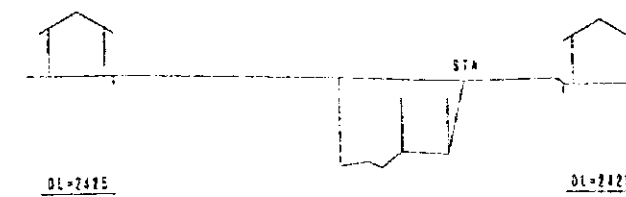

THE STUDY ON ADDIS ABABA FLOOD CONTROL PROJECT  
IN THE FEDERAL DEMOCRATIC REPUBLIC OF ETHIOPIA

JAPAN INTERNATIONAL COOPERATION AGENCY  
REGION 14 ADMINISTRATION

DRAWING NO.  
KUR-SECT-03

LOCATION OF RIVER CROSS SECTION  
KURTUME (KUR) RIVER (03/05)

Cross Section S=1:200

KUR-19

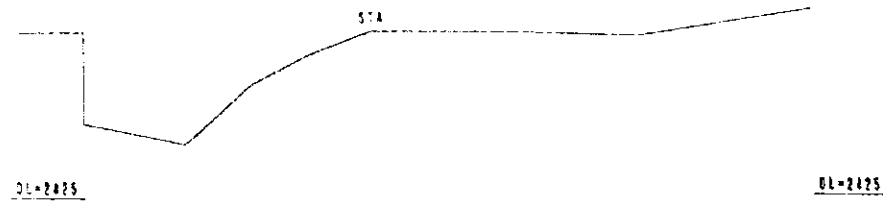

KUR-22

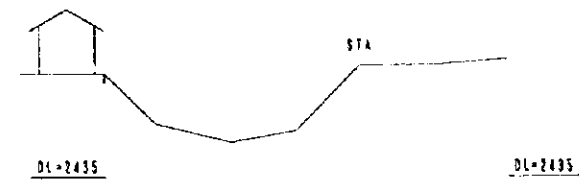

KUR-20

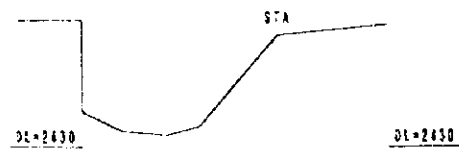

KUR-23

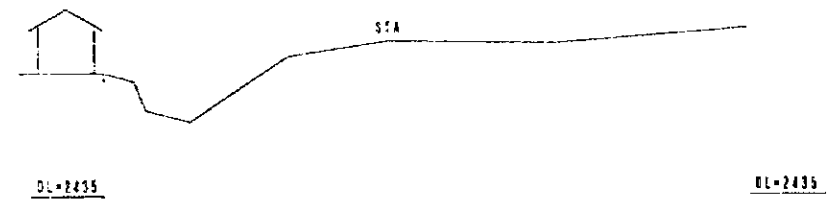

KUR-21

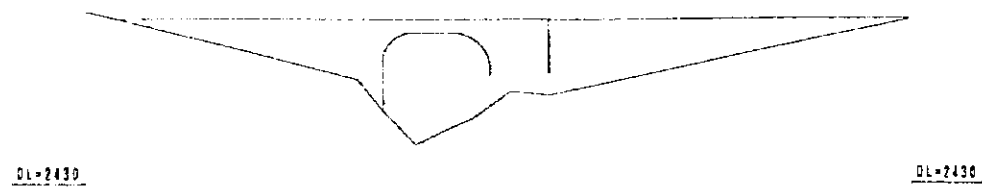

KUR-24

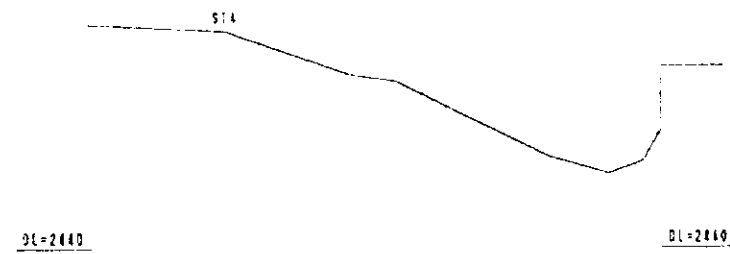

THE STUDY ON ADDIS ABABA FLOOD CONTROL PROJECT IN THE FEDERAL DEMOCRATIC REPUBLIC OF ETHIOPIA	
JAPAN INTERNATIONAL COOPERATION AGENCY REGION IN ADMINISTRATION	
DRAWING NO. KGR-SECT-04	LOCATION OF RIVER CROSS SECTION KURTUME (KUR) RIVER (04/06)

Cross Section S=1:200

KUR-25

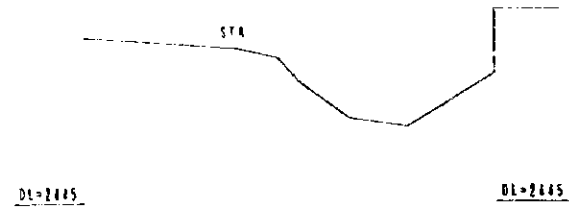

KUR-28

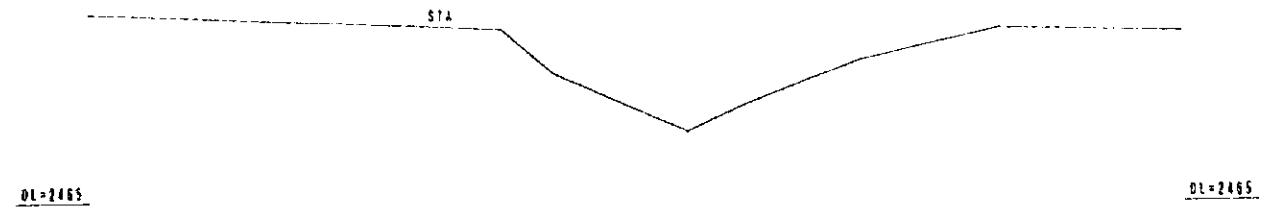

KUR-26

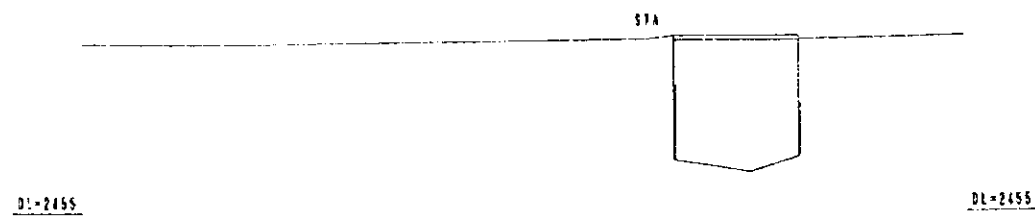

KUR-29

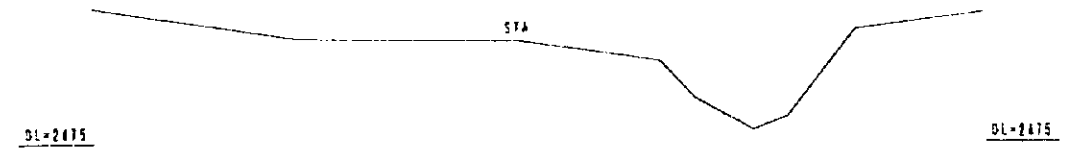

KUR-27

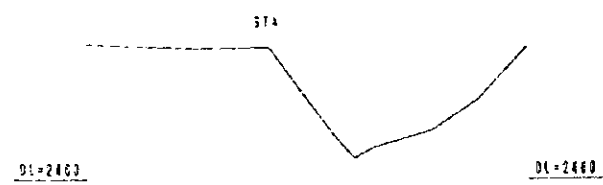

KUR-30



THE STUDY ON ADDIS ABABA FLOOD CONTROL PROJECT IN THE FEDERAL DEMOCRATIC REPUBLIC OF ETHIOPIA	
JAPAN INTERNATIONAL COOPERATION AGENCY REGION 14 ADMINISTRATION	
DRAWING NO. KUR-SECT-05	LOCATION OF RIVER CROSS SECTION KURTOME (KUR) RIVER (05/06)

Cross Section S=1:200

KUR-31

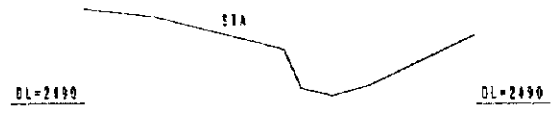

KUR-32

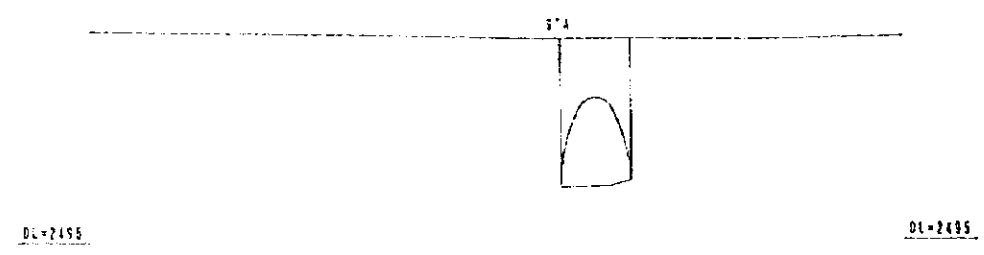

THE STUDY ON ADDIS ABABA FLOOD CONTROL PROJECT IN THE FEDERAL DEMOCRATIC REPUBLIC OF ETHIOPIA	
JAPAN INTERNATIONAL COOPERATION AGENCY REGION 14 ADMINISTRATION	
DRAWING NO. KUR-SECT-08	LOCATION OF RIVER CROSS SECTION KURTUME (KUR) RIVER (06/06)

Profile Section V=1:500  
H=1:10000

DL=2375.00  
V=1:500  
H=1:10000

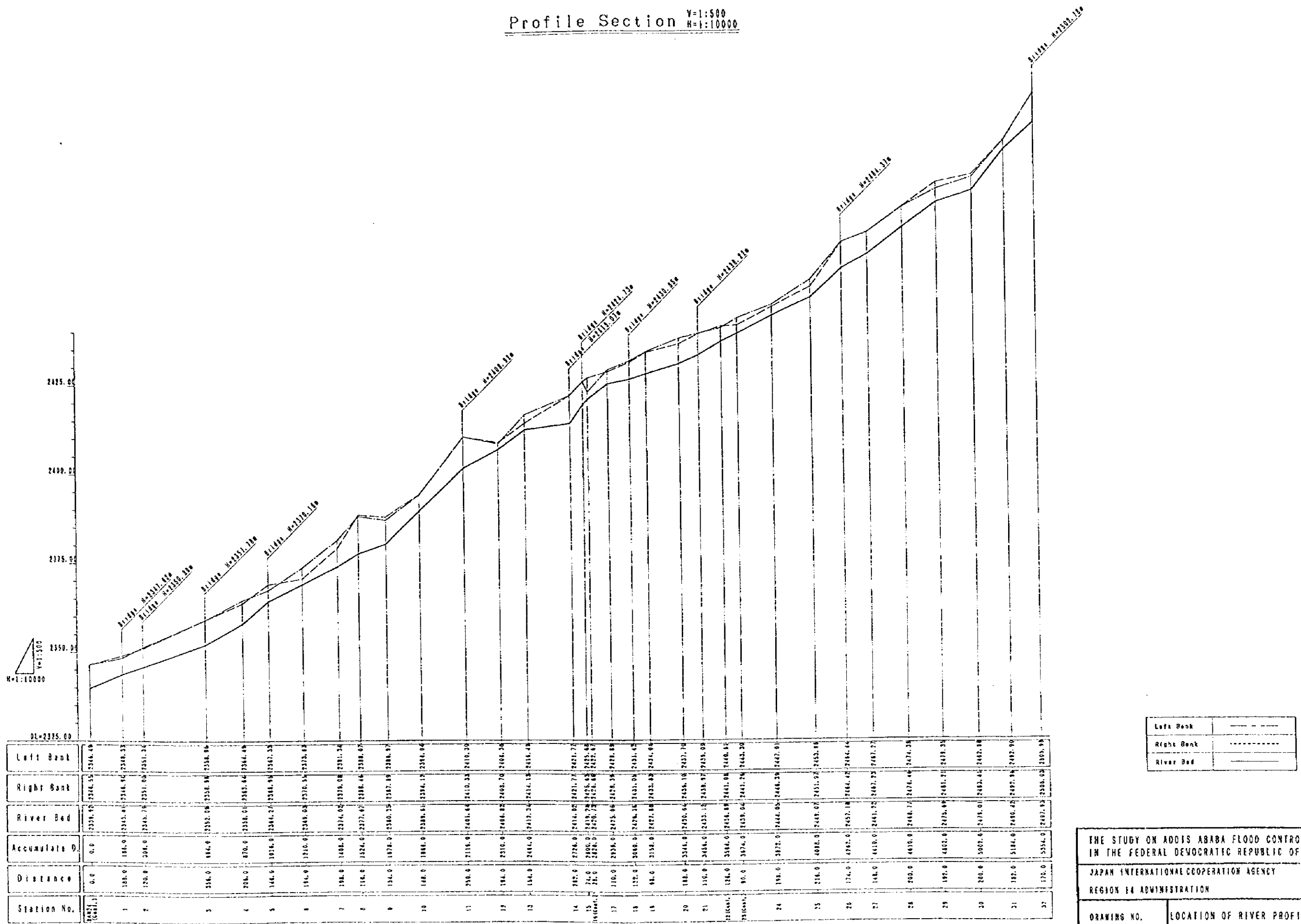

Left Bank	- - - - -
Right Bank	- · - · - ·
River Bed	—————

Left Bank	2376.00	2377.50	2378.50	2380.00	2381.50	2383.00	2384.50	2386.00	2387.50	2389.00	2390.50	2392.00	2393.50	2395.00	2396.50	2398.00	2399.50	2401.00	2402.50	2404.00	2405.50	2407.00	2408.50	2410.00	2411.50	2413.00	2414.50	2416.00	2417.50	2419.00	2420.50	2422.00	2423.50	2425.00	2426.50	2428.00	2429.50	2431.00	2432.50	2434.00	2435.50	2437.00	2438.50	2440.00	2441.50	2443.00	2444.50	2446.00	2447.50	2449.00	2450.50	2452.00	2453.50	2455.00	2456.50	2458.00	2459.50	2461.00	2462.50	2464.00	2465.50	2467.00	2468.50	2470.00	2471.50	2473.00	2474.50	2476.00	2477.50	2479.00	2480.50	2482.00	2483.50	2485.00	2486.50	2488.00	2489.50	2491.00	2492.50	2494.00	2495.50	2497.00	2498.50	2500.00	2501.50	2503.00	2504.50	2506.00	2507.50	2509.00	2510.50	2512.00	2513.50	2515.00	2516.50	2518.00	2519.50	2521.00	2522.50	2524.00	2525.50	2527.00	2528.50	2530.00	2531.50	2533.00	2534.50	2536.00	2537.50	2539.00	2540.50	2542.00	2543.50	2545.00	2546.50	2548.00	2549.50	2551.00	2552.50	2554.00	2555.50	2557.00	2558.50	2560.00	2561.50	2563.00	2564.50	2566.00	2567.50	2569.00	2570.50	2572.00	2573.50	2575.00	2576.50	2578.00	2579.50	2581.00	2582.50	2584.00	2585.50	2587.00	2588.50	2590.00	2591.50	2593.00	2594.50	2596.00	2597.50	2599.00	2600.50	2602.00	2603.50	2605.00	2606.50	2608.00	2609.50	2611.00	2612.50	2614.00	2615.50	2617.00	2618.50	2620.00	2621.50	2623.00	2624.50	2626.00	2627.50	2629.00	2630.50	2632.00	2633.50	2635.00	2636.50	2638.00	2639.50	2641.00	2642.50	2644.00	2645.50	2647.00	2648.50	2650.00	2651.50	2653.00	2654.50	2656.00	2657.50	2659.00	2660.50	2662.00	2663.50	2665.00	2666.50	2668.00	2669.50	2671.00	2672.50	2674.00	2675.50	2677.00	2678.50	2680.00	2681.50	2683.00	2684.50	2686.00	2687.50	2689.00	2690.50	2692.00	2693.50	2695.00	2696.50	2698.00	2699.50	2701.00	2702.50	2704.00	2705.50	2707.00	2708.50	2710.00	2711.50	2713.00	2714.50	2716.00	2717.50	2719.00	2720.50	2722.00	2723.50	2725.00	2726.50	2728.00	2729.50	2731.00	2732.50	2734.00	2735.50	2737.00	2738.50	2740.00	2741.50	2743.00	2744.50	2746.00	2747.50	2749.00	2750.50	2752.00	2753.50	2755.00	2756.50	2758.00	2759.50	2761.00	2762.50	2764.00	2765.50	2767.00	2768.50	2770.00	2771.50	2773.00	2774.50	2776.00	2777.50	2779.00	2780.50	2782.00	2783.50	2785.00	2786.50	2788.00	2789.50	2791.00	2792.50	2794.00	2795.50	2797.00	2798.50	2800.00	2801.50	2803.00	2804.50	2806.00	2807.50	2809.00	2810.50	2812.00	2813.50	2815.00	2816.50	2818.00	2819.50	2821.00	2822.50	2824.00	2825.50	2827.00	2828.50	2830.00	2831.50	2833.00	2834.50	2836.00	2837.50	2839.00	2840.50	2842.00	2843.50	2845.00	2846.50	2848.00	2849.50	2851.00	2852.50	2854.00	2855.50	2857.00	2858.50	2860.00	2861.50	2863.00	2864.50	2866.00	2867.50	2869.00	2870.50	2872.00	2873.50	2875.00	2876.50	2878.00	2879.50	2881.00	2882.50	2884.00	2885.50	2887.00	2888.50	2890.00	2891.50	2893.00	2894.50	2896.00	2897.50	2899.00	2900.50	2902.00	2903.50	2905.00	2906.50	2908.00	2909.50	2911.00	2912.50	2914.00	2915.50	2917.00	2918.50	2920.00	2921.50	2923.00	2924.50	2926.00	2927.50	2929.00	2930.50	2932.00	2933.50	2935.00	2936.50	2938.00	2939.50	2941.00	2942.50	2944.00	2945.50	2947.00	2948.50	2950.00	2951.50	2953.00	2954.50	2956.00	2957.50	2959.00	2960.50	2962.00	2963.50	2965.00	2966.50	2968.00	2969.50	2971.00	2972.50	2974.00	2975.50	2977.00	2978.50	2980.00	2981.50	2983.00	2984.50	2986.00	2987.50	2989.00	2990.50	2992.00	2993.50	2995.00	2996.50	2998.00	2999.50	3001.00	3002.50	3004.00	3005.50	3007.00	3008.50	3010.00	3011.50	3013.00	3014.50	3016.00	3017.50	3019.00	3020.50	3022.00	3023.50	3025.00	3026.50	3028.00	3029.50	3031.00	3032.50	3034.00	3035.50	3037.00	3038.50	3040.00	3041.50	3043.00	3044.50	3046.00	3047.50	3049.00	3050.50	3052.00	3053.50	3055.00	3056.50	3058.00	3059.50	3061.00	3062.50	3064.00	3065.50	3067.00	3068.50	3070.00	3071.50	3073.00	3074.50	3076.00	3077.50	3079.00	3080.50	3082.00	3083.50	3085.00	3086.50	3088.00	3089.50	3091.00	3092.50	3094.00	3095.50	3097.00	3098.50	3000.00	3001.50	3003.00	3004.50	3006.00	3007.50	3009.00	3010.50	3012.00	3013.50	3015.00	3016.50	3018.00	3019.50	3021.00	3022.50	3024.00	3025.50	3027.00	3028.50	3030.00	3031.50	3033.00	3034.50	3036.00	3037.50	3039.00	3040.50	3042.00	3043.50	3045.00	3046.50	3048.00	3049.50	3051.00	3052.50	3054.00	3055.50	3057.00	3058.50	3060.00	3061.50	3063.00	3064.50	3066.00	3067.50	3069.00	3070.50	3072.00	3073.50	3075.00	3076.50	3078.00	3079.50	3081.00	3082.50	3084.00	3085.50	3087.00	3088.50	3090.00	3091.50	3093.00	3094.50	3096.00	3097.50	3099.00	3100.50	3102.00	3103.50	3105.00	3106.50	3108.00	3109.50	3111.00	3112.50	3114.00	3115.50	3117.00	3118.50	3120.00	3121.50	3123.00	3124.50	3126.00	3127.50	3129.00	3130.50	3132.00	3133.50	3135.00	3136.50	3138.00	3139.50	3141.00	3142.50	3144.00	3145.50	3147.00	3148.50	3150.00	3151.50	3153.00	3154.50	3156.00	3157.50	3159.00	3160.50	3162.00	3163.50	3165.00	3166.50	3168.00	3169.50	3171.00	3172.50	3174.00	3175.50	3177.00	3178.50	3180.00	3181.50	3183.00	3184.50	3186.00	3187.50	3189.00	3190.50	3192.00	3193.50	3195.00	3196.50	3198.00	3199.50	3201.00	3202.50	3204.00	3205.50	3207.00	3208.50	3210.00	3211.50	3213.00	3214.50	3216.00	3217.50	3219.00	3220.50	3222.00	3223.50	3225.00	3226.50	3228.00	3229.50	3231.00	3232.50	3234.00	3235.50	3237.00	3238.50	3240.00	3241.50	3243.00	3244.50	3246.00	3247.50	3249.00	3250.50	3252.00	3253.50	3255.00	3256.50	3258.00	3259.50	3261.00	3262.50	3264.00	3265.50	3267.00	3268.50	3270.00	3271.50	3273.00	3274.50	3276.00	3277.50	3279.00	3280.50	3282.00	3283.50	3285.00	3286.50	3288.00	3289.50	3291.00	3292.50	3294.00	3295.50	3297.00	3298.50	3300.00	3301.50	3303.00	3304.50	3306.00	3307.50	3309.00	3310.50	3312.00	3313.50	3315.00	3316.50	3318.00	3319.50	3321.00	3322.50	3324.00	3325.50	3327.00	3328.50	3330.00	3331.50	3333.00	3334.50	3336.00	3337.50	3339.00	3340.50	3342.00	3343.50	3345.00	3346.50	3348.00	3349.50	3351.00	3352.50	3354.00	3355.50	3357.00	3358.50	3360.00	3361.50	3363.00	3364.50	3366.00	3367.50	3369.00	3370.50	3372.00	3373.50	3375.00	3376.50	3378.00	3379.50	3381.00	3382.50	3384.00	3385.50	3387.00	3388.50	3390.00	3391.50	3393.00	3394.50	3396.00	3397.50	3399.00	3400.50	3402.00	3403.50	3405.00	3406.50	3408.00	3409.50	3411.00	3412.50	3414.00	3415.50	3417.00	3418.50	3420.00	3421.50	3423.00	3424.50	3426.00	3427.50	3429.00	3430.50	3432.00	3433.50	3435.00	3436.50	3438.00	3439.50	3441.00	3442.50	3444.00	3445.50	3447.00	3448.50	3450.00	3451.50	3453.00	3454.50	3456.00	3457.50	3459.00	3460.50	3462.00	3463.50	3465.00	3466.50	3468.00	3469.50	3471.00	3472.50	3474.00	3475.50	3477.00	3478.50	3480.00	3481.50	3483.00	3484.50	3486.00	3487.50	3489.00	3490.50	3492.00	3493.50	3495.00	3496.50	3498.00	3499.50	3501.00	3502.50	3504.00	3505.50	3507.00	3508.50	3510.00	3511.50	3513.00	3514.50	3516.00	3517.50	3519.00	3520.50	3522.00	3523.50	3525.00	3526.50	3528.00	3529.50	3531.00	3532.50	3534.00	3535.50	3537.00	3538.50	3540.00	3541.50	3543.00	3544.50	3546.00	3547.50	3549.00	3550.50	3552.00	3553.50	3555.00	3556.50	3558.00	3559.50	3561.00	3562.50	3564.00	3565.50	3567.00	3568.50	3570.00	3571.50	3573.00	3574.50	3576.00	3577.50	3579.00	3580.50	3582.00	3583.50	3585.00	3586.50	3588.00	3589.50	3591.00	3592.50	3594.00	3595.50	3597.00	3598.50	3600.00	3601.50	3603.00	3604.50	3606.00	3607.50	3609.00	3610.50	3612.00	3613.50	3615.00	3616.50	3618.00	3619.50	3621.00	3622.50	3624.00	3625.50	3627.00	3628.50	3630.00	3631.50	3633.00	3634.50	3636.00	3637.50	3639.00	3640.50	3642.00	3643.50	3645.00	3646.50	3648.00	3649.50	3651.00	3652.50	3654.00	3655.5
-----------	---------	---------	---------	---------	---------	---------	---------	---------	---------	---------	---------	---------	---------	---------	---------	---------	---------	---------	---------	---------	---------	---------	---------	---------	---------	---------	---------	---------	---------	---------	---------	---------	---------	---------	---------	---------	---------	---------	---------	---------	---------	---------	---------	---------	---------	---------	---------	---------	---------	---------	---------	---------	---------	---------	---------	---------	---------	---------	---------	---------	---------	---------	---------	---------	---------	---------	---------	---------	---------	---------	---------	---------	---------	---------	---------	---------	---------	---------	---------	---------	---------	---------	---------	---------	---------	---------	---------	---------	---------	---------	---------	---------	---------	---------	---------	---------	---------	---------	---------	---------	---------	---------	---------	---------	---------	---------	---------	---------	---------	---------	---------	---------	---------	---------	---------	---------	---------	---------	---------	---------	---------	---------	---------	---------	---------	---------	---------	---------	---------	---------	---------	---------	---------	---------	---------	---------	---------	---------	---------	---------	---------	---------	---------	---------	---------	---------	---------	---------	---------	---------	---------	---------	---------	---------	---------	---------	---------	---------	---------	---------	---------	---------	---------	---------	---------	---------	---------	---------	---------	---------	---------	---------	---------	---------	---------	---------	---------	---------	---------	---------	---------	---------	---------	---------	---------	---------	---------	---------	---------	---------	---------	---------	---------	---------	---------	---------	---------	---------	---------	---------	---------	---------	---------	---------	---------	---------	---------	---------	---------	---------	---------	---------	---------	---------	---------	---------	---------	---------	---------	---------	---------	---------	---------	---------	---------	---------	---------	---------	---------	---------	---------	---------	---------	---------	---------	---------	---------	---------	---------	---------	---------	---------	---------	---------	---------	---------	---------	---------	---------	---------	---------	---------	---------	---------	---------	---------	---------	---------	---------	---------	---------	---------	---------	---------	---------	---------	---------	---------	---------	---------	---------	---------	---------	---------	---------	---------	---------	---------	---------	---------	---------	---------	---------	---------	---------	---------	---------	---------	---------	---------	---------	---------	---------	---------	---------	---------	---------	---------	---------	---------	---------	---------	---------	---------	---------	---------	---------	---------	---------	---------	---------	---------	---------	---------	---------	---------	---------	---------	---------	---------	---------	---------	---------	---------	---------	---------	---------	---------	---------	---------	---------	---------	---------	---------	---------	---------	---------	---------	---------	---------	---------	---------	---------	---------	---------	---------	---------	---------	---------	---------	---------	---------	---------	---------	---------	---------	---------	---------	---------	---------	---------	---------	---------	---------	---------	---------	---------	---------	---------	---------	---------	---------	---------	---------	---------	---------	---------	---------	---------	---------	---------	---------	---------	---------	---------	---------	---------	---------	---------	---------	---------	---------	---------	---------	---------	---------	---------	---------	---------	---------	---------	---------	---------	---------	---------	---------	---------	---------	---------	---------	---------	---------	---------	---------	---------	---------	---------	---------	---------	---------	---------	---------	---------	---------	---------	---------	---------	---------	---------	---------	---------	---------	---------	---------	---------	---------	---------	---------	---------	---------	---------	---------	---------	---------	---------	---------	---------	---------	---------	---------	---------	---------	---------	---------	---------	---------	---------	---------	---------	---------	---------	---------	---------	---------	---------	---------	---------	---------	---------	---------	---------	---------	---------	---------	---------	---------	---------	---------	---------	---------	---------	---------	---------	---------	---------	---------	---------	---------	---------	---------	---------	---------	---------	---------	---------	---------	---------	---------	---------	---------	---------	---------	---------	---------	---------	---------	---------	---------	---------	---------	---------	---------	---------	---------	---------	---------	---------	---------	---------	---------	---------	---------	---------	---------	---------	---------	---------	---------	---------	---------	---------	---------	---------	---------	---------	---------	---------	---------	---------	---------	---------	---------	---------	---------	---------	---------	---------	---------	---------	---------	---------	---------	---------	---------	---------	---------	---------	---------	---------	---------	---------	---------	---------	---------	---------	---------	---------	---------	---------	---------	---------	---------	---------	---------	---------	---------	---------	---------	---------	---------	---------	---------	---------	---------	---------	---------	---------	---------	---------	---------	---------	---------	---------	---------	---------	---------	---------	---------	---------	---------	---------	---------	---------	---------	---------	---------	---------	---------	---------	---------	---------	---------	---------	---------	---------	---------	---------	---------	---------	---------	---------	---------	---------	---------	---------	---------	---------	---------	---------	---------	---------	---------	---------	---------	---------	---------	---------	---------	---------	---------	---------	---------	---------	---------	---------	---------	---------	---------	---------	---------	---------	---------	---------	---------	---------	---------	---------	---------	---------	---------	---------	---------	---------	---------	---------	---------	---------	---------	---------	---------	---------	---------	---------	---------	---------	---------	---------	---------	---------	---------	---------	---------	---------	---------	---------	---------	---------	---------	---------	---------	---------	---------	---------	---------	---------	---------	---------	---------	---------	---------	---------	---------	---------	---------	---------	---------	---------	---------	---------	---------	---------	---------	---------	---------	---------	---------	---------	---------	---------	---------	---------	---------	---------	---------	---------	---------	---------	---------	---------	---------	---------	---------	---------	---------	---------	---------	---------	---------	---------	---------	---------	---------	---------	---------	---------	---------	---------	---------	---------	---------	---------	---------	---------	---------	---------	---------	---------	---------	---------	---------	---------	---------	---------	---------	---------	---------	---------	---------	---------	---------	---------	---------	---------	---------	---------	---------	---------	---------	---------	---------	---------	---------	---------	---------	---------	---------	---------	---------	---------	---------	---------	---------	---------	---------	---------	---------	---------	---------	---------	---------	---------	---------	---------	---------	---------	---------	---------	---------	---------	---------	---------	---------	---------	---------	---------	---------	---------	---------	---------	---------	---------	---------	---------	---------	---------	---------	---------	---------	---------	---------	---------	---------	---------	---------	---------	---------	---------	---------	---------	---------	---------	---------	---------	---------	---------	---------	---------	---------	---------	---------	---------	---------	---------	---------	---------	---------	---------	---------	---------	---------	---------	---------	---------	---------	---------	---------	---------	---------	---------	---------	---------	---------	---------	---------	---------	---------	---------	---------	---------	---------	---------	---------	---------	---------	---------	---------	---------	---------	---------	---------	---------	---------	---------	---------	---------	---------	---------	---------	---------	---------	---------	---------	---------	---------	---------	---------	---------	---------	---------	---------	---------	---------	---------	---------	---------	---------	---------	---------	---------	---------	--------

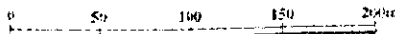

THE STUDY ON ADDIS ABABA FLOOD CONTROL PROJECT IN THE FEDERAL DEMOCRATIC REPUBLIC OF ETHIOPIA	
JAPAN INTERNATIONAL COOPERATION AGENCY REGION 11 ADMINISTRATION	
DRAWING NO.	
KURL-PLAN-01	

Cross Section S=1:200

KURL-01



KURL-04

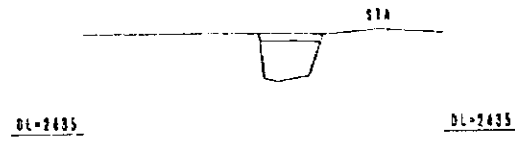

KURL-07

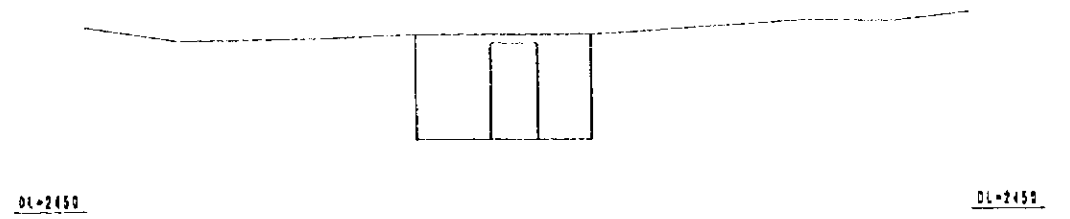

KURL-02

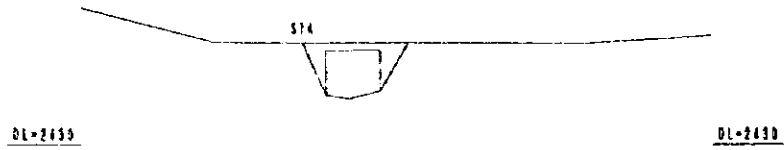

KURL-05

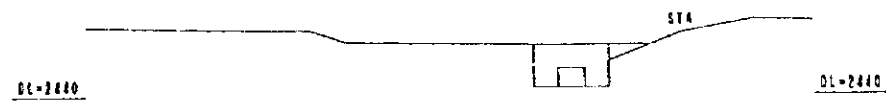

KURL-03

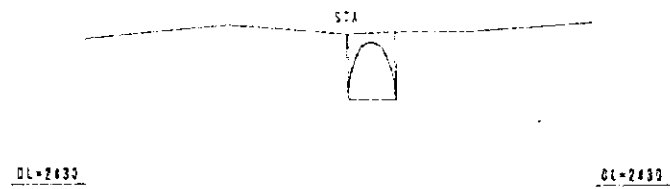

KURL-06

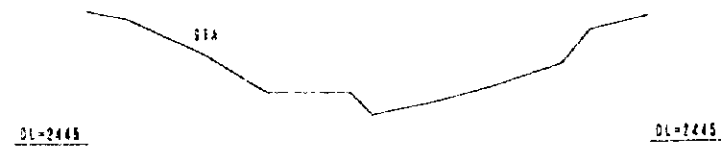

THE STUDY ON ADDIS ABABA FLOOD CONTROL PROJECT IN THE FEDERAL DEMOCRATIC REPUBLIC OF ETHIOPIA	
JAPAN INTERNATIONAL COOPERATION AGENCY REGION 14 ADMINISTRATION	
DRAWING NO. KURL-SECT-01	LOCATION OF RIVER CROSS SECTION KURTUME (KURL) RIVER (01/01)



Profile Section  $V=1:500$   
 $H=1:10000$

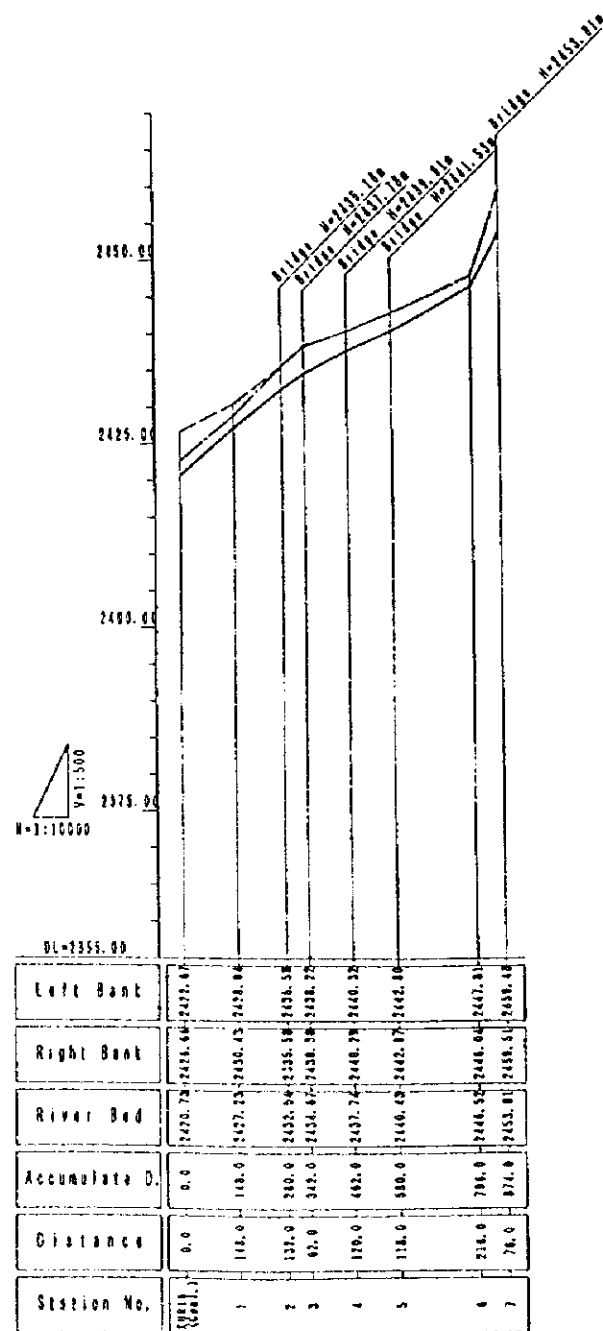

Left Bank	———
Right Bank	-----
River Bed	- . - . -

THE STUDY ON ADDIS ABABA FLOOD CONTROL PROJECT  
IN THE FEDERAL DEMOCRATIC REPUBLIC OF ETHIOPIA

JAPAN INTERNATIONAL COOPERATION AGENCY  
REGION 14 ADMINISTRATION

DRAWING NO. KURL-SECT-01	LOCATION OF RIVER PROFILE SECTION KURTUME (KURL) RIVER (01/01)
-----------------------------	---

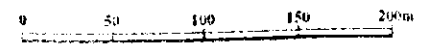

THE STUDY ON ADDIS ABABA FLOOD CONTROL PROJECT  
IN THE FEDERAL DEMOCRATIC REPUBLIC OF ETHIOPIA

JAPAN INTERNATIONAL COOPERATION AGENCY  
REGION 14 ADMINISTRATION

DRAWING NO.	
KURRI-PLAN-01	

No. 30,42

Cross Section S=1:200

KURRI-01

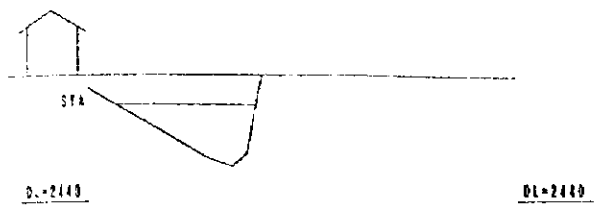

KURRI-04

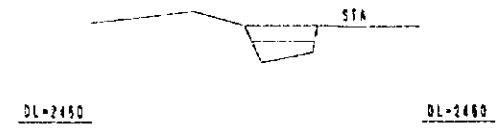

KURRI-02

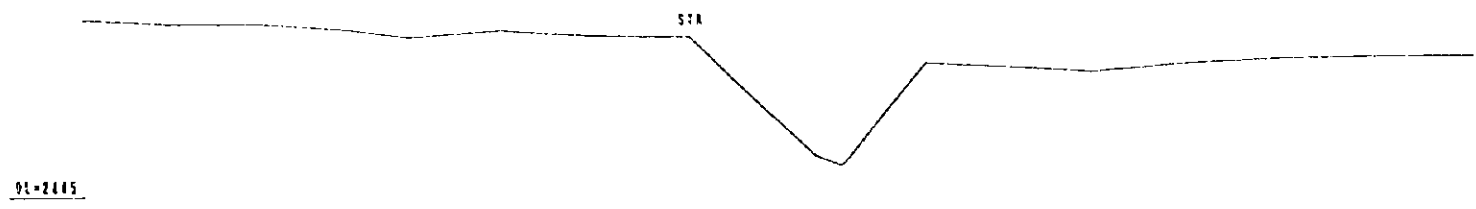

KURRI-05

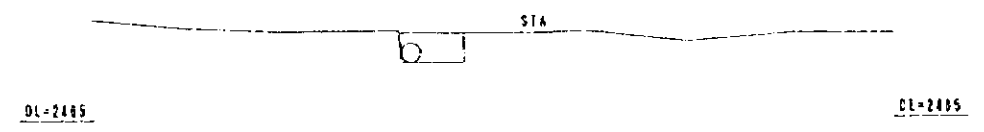

KURRI-03

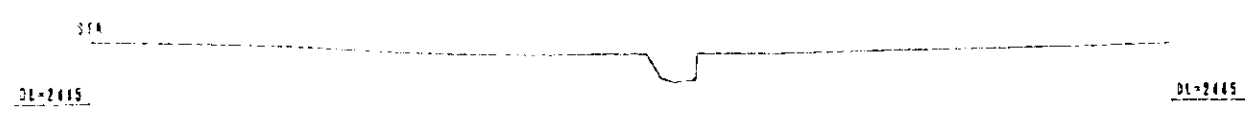

KURRI-06

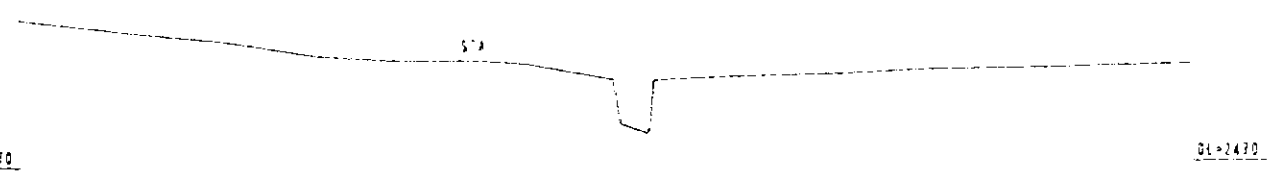

THE STUDY ON ADDIS ABABA FLOOD CONTROL PROJECT IN THE FEDERAL DEMOCRATIC REPUBLIC OF ETHIOPIA	
JAPAN INTERNATIONAL COOPERATION AGENCY REGION 14 ADMINISTRATION	
DRAWING NO. KURRI-SECT-01	LOCATION OF RIVER CROSS SECTION KURTUME (KURRI) RIVER (01/02)

Cross Section S=1:200

KURRI-17

KURRI-10

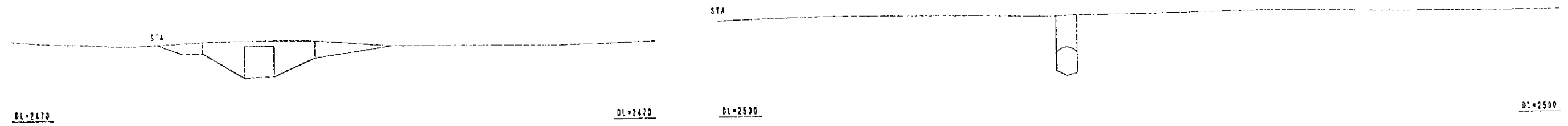

KURRI-08

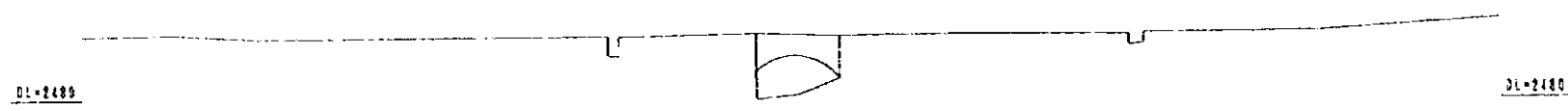

KURRI-09



THE STUDY ON ADDIS ABABA FLOOD CONTROL PROJECT IN THE FEDERAL DEMOCRATIC REPUBLIC OF ETHIOPIA	
JAPAN INTERNATIONAL COOPERATION AGENCY REGION 14 ADMINISTRATION	
DRAWING NO. KURRI-SECT-02	LOCATION OF RIVER CROSS SECTION KURTUME (KURRI) RIVER (02/02)

Profile Section V=1:500  
H=1:10000

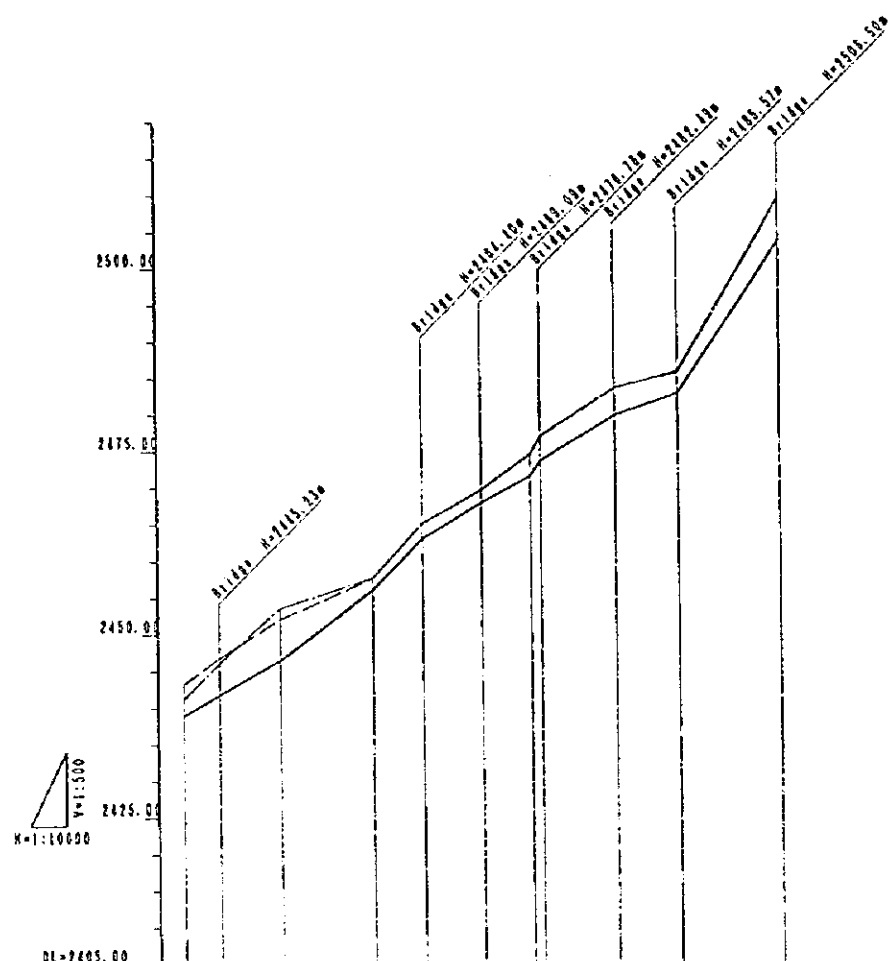

DL=2405.00									
Left Bank	2431.06	2442.30	2458.24	2468.24	2488.88	2497.50	2498.65	2498.88	2491.45
Right Bank	2421.00	2446.85	2452.18	2465.16	2485.75	2491.50	2492.00	2492.00	2491.45
River Bed	2421.00	2421.00	2421.00	2421.00	2421.00	2421.00	2421.00	2421.00	2421.00
Accumulate D.	0.0	100.0	200.0	322.0	480.0	621.0	747.5	858.5	1030.5
Distance	0.0	100.0	200.0	256.0	356.0	456.0	556.0	656.0	772.0
Station No.	1	2	3	4	5	6	7	8	10

Left Bank	———
Right Bank	-----
River Bed	.....

THE STUDY ON ADDIS ABABA FLOOD CONTROL PROJECT  
 IN THE FEDERAL DEMOCRATIC REPUBLIC OF ETHIOPIA  
 JAPAN INTERNATIONAL COOPERATION AGENCY  
 REGION 14 ADMINISTRATION

DRAWING NO. KURRI-SECT-01	LOCATION OF RIVER PROFILE SECTION KURTUME (KURRI) RIVER (01/01)
------------------------------	--

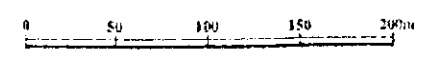

THE STUDY ON ADDIS ABABA FLOOD CONTROL PROJECT  
IN THE FEDERAL DEMOCRATIC REPUBLIC OF ETHIOPIA

JAPAN INTERNATIONAL COOPERATION AGENCY  
REGION 14 ADMINISTRATION

DRAWING NO.	
KURR2-PLAN-01	

1-2-19

No.30,42

Cross Section S=1:200

KURR2-01

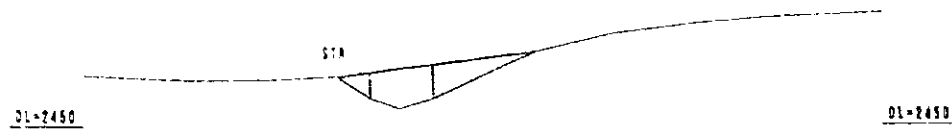

KURR2-04

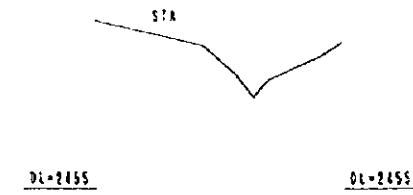

KURR2-02



KURR2-05

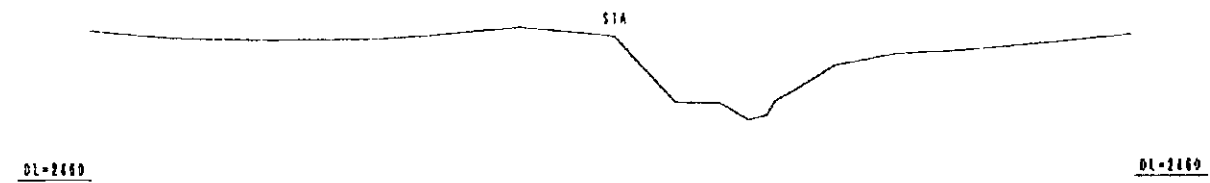

KURR2-03

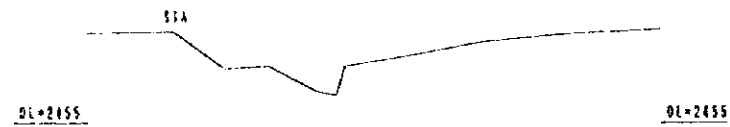

KURR2-06



THE STUDY ON ADDIS ABABA FLOOD CONTROL PROJECT IN THE FEDERAL DEMOCRATIC REPUBLIC OF ETHIOPIA	
JAPAN INTERNATIONAL COOPERATION AGENCY REGION 14 ADMINISTRATION	
DRAWING NO. KURR2-SECT-01	LOCATION OF RIVER CROSS SECTION KURTUME (KURR2) RIVER (01/02)

Cross Section S=1:200

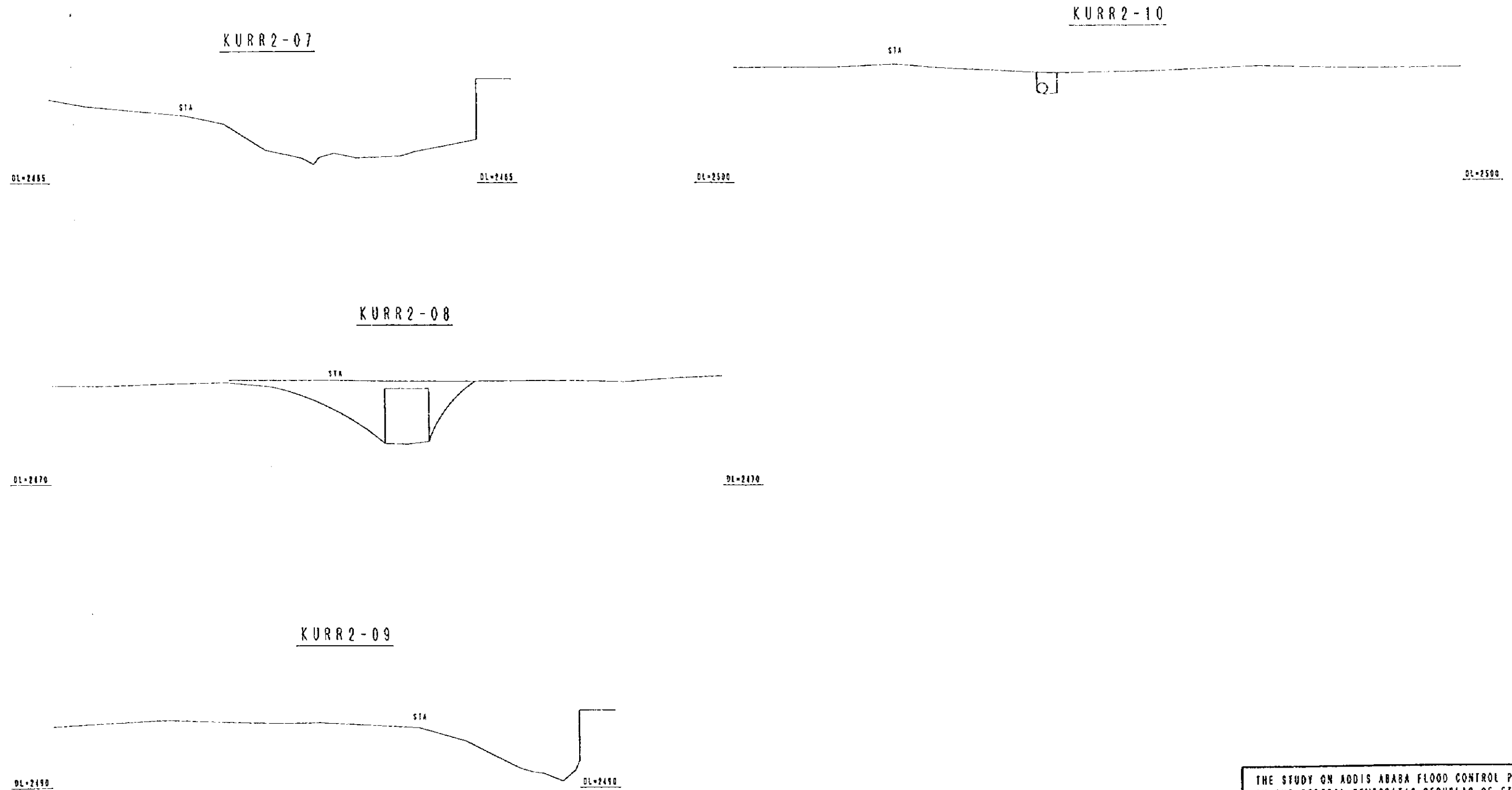

THE STUDY ON ADDIS ABABA FLOOD CONTROL PROJECT IN THE FEDERAL DEMOCRATIC REPUBLIC OF ETHIOPIA	
JAPAN INTERNATIONAL COOPERATION AGENCY REGION 14 ADMINISTRATION	
DRAWING NO. KURR2-SECT-02	LOCATION OF RIVER CROSS SECTION KURTUME (KURR2) RIVER (02/02)



Profile Section V=1:500  
H=1:10000

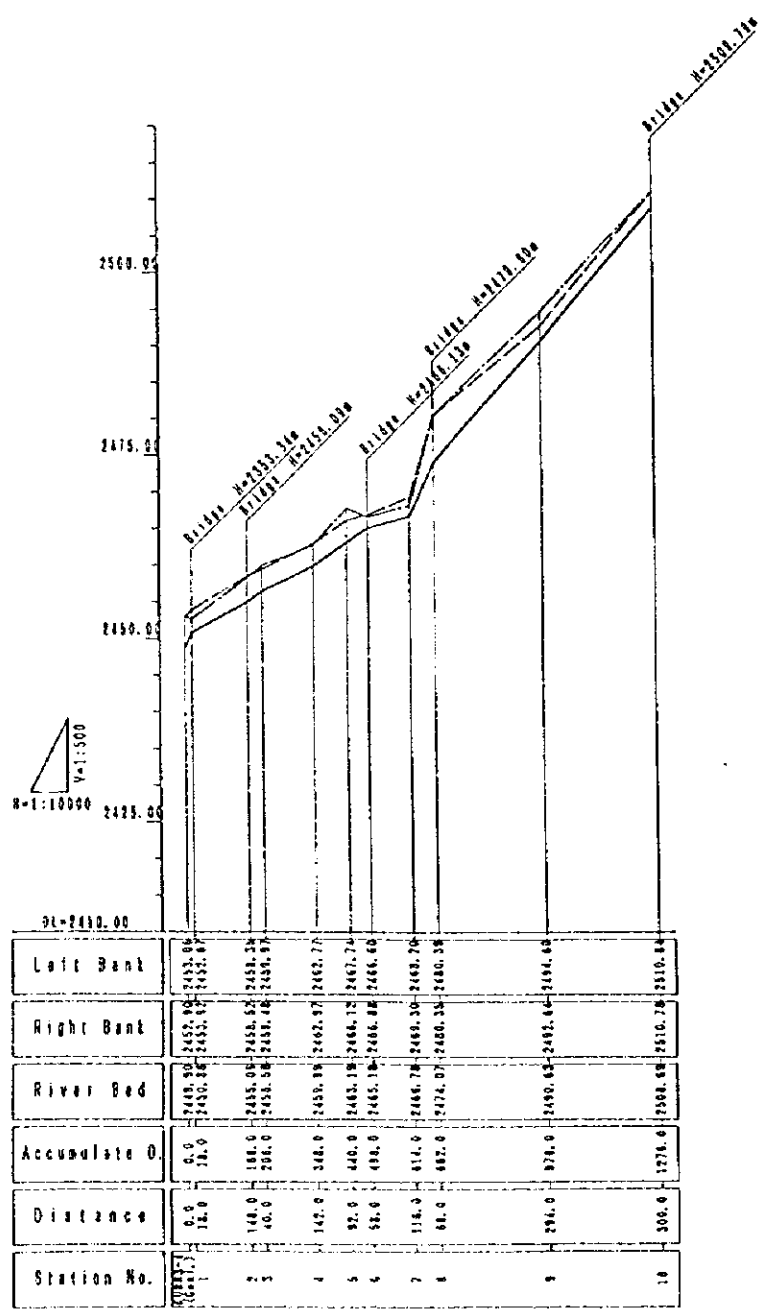

Left Bank	-----
Right Bank	.....
River Bed	—————

THE STUDY ON ADDIS ABABA FLOOD CONTROL PROJECT  
IN THE FEDERAL DEMOCRATIC REPUBLIC OF ETHIOPIA

JAPAN INTERNATIONAL COOPERATION AGENCY  
REGION 14 ADMINISTRATION

DRAWING NO. LOCATION OF RIVER PROFILE SECTION  
KURR2-SECT-01 KURTUME (KURR2) RIVER (01/01)



THE STUDY ON ADDIS ABABA FLOOD CONTROL PROJECT  
 IN THE FEDERAL DEMOCRATIC REPUBLIC OF ETHIOPIA

JAPAN INTERNATIONAL COOPERATION AGENCY  
 REGION 14 ADMINISTRATION

DRAWING NO.  
 KURR3-PLAN-01

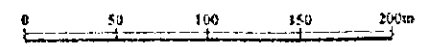

Cross Section S=1:200

KURR3-01

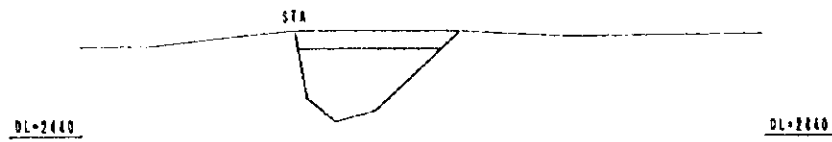

KURR3-04

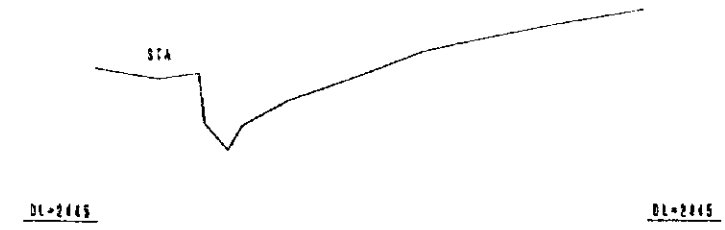

KURR3-02

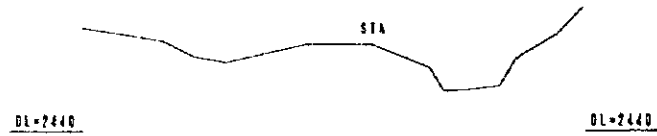

KURR3-05

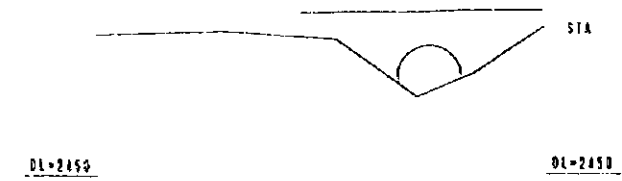

KURR3-03

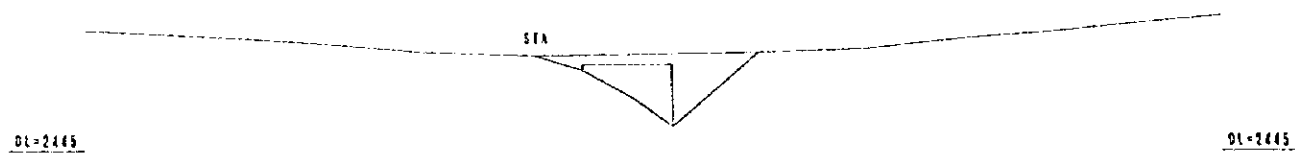

KURR3-06

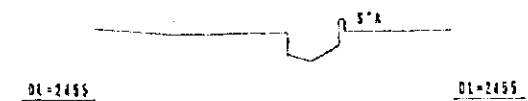

THE STUDY ON ADDIS ABABA FLOOD CONTROL PROJECT  
IN THE FEDERAL DEMOCRATIC REPUBLIC OF ETHIOPIA

JAPAN INTERNATIONAL COOPERATION AGENCY  
REGION 14 ADMINISTRATION

DRAWING NO.  
KURR3-SECT-01

LOCATION OF RIVER CROSS SECTION  
KURTUME (KURR3) RIVER (01/03)

Cross Section S=1:200

KURR3-07

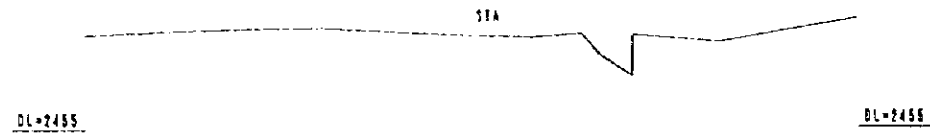

KURR3-10



KURR3-08

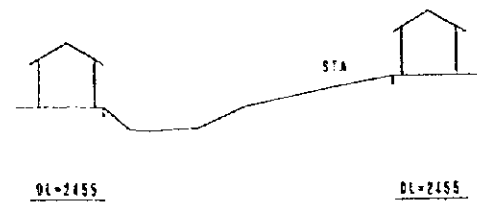

KURR3-11

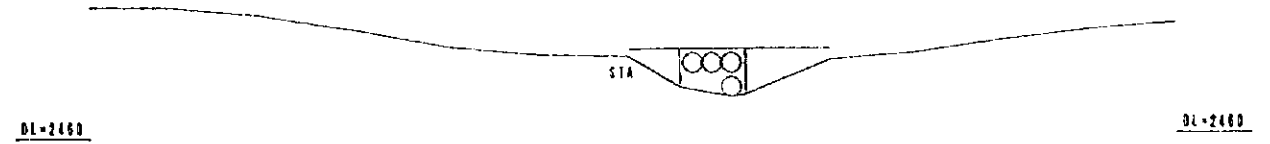

KURR3-09

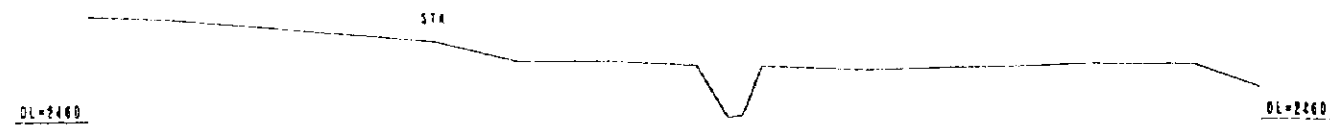

KURR3-12

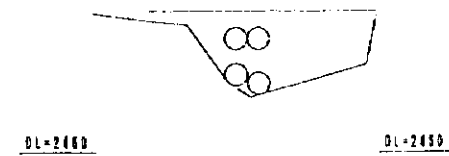

THE STUDY ON ADDIS ABABA FLOOD CONTROL PROJECT IN THE FEDERAL DEMOCRATIC REPUBLIC OF ETHIOPIA	
JAPAN INTERNATIONAL COOPERATION AGENCY REGION 14 ADMINISTRATION	
DRAWING NO. KURR3-SECT-02	LOCATION OF RIVER CROSS SECTION KURTUWE (KURR3) RIVER (02/03)

Cross Section S=1:200

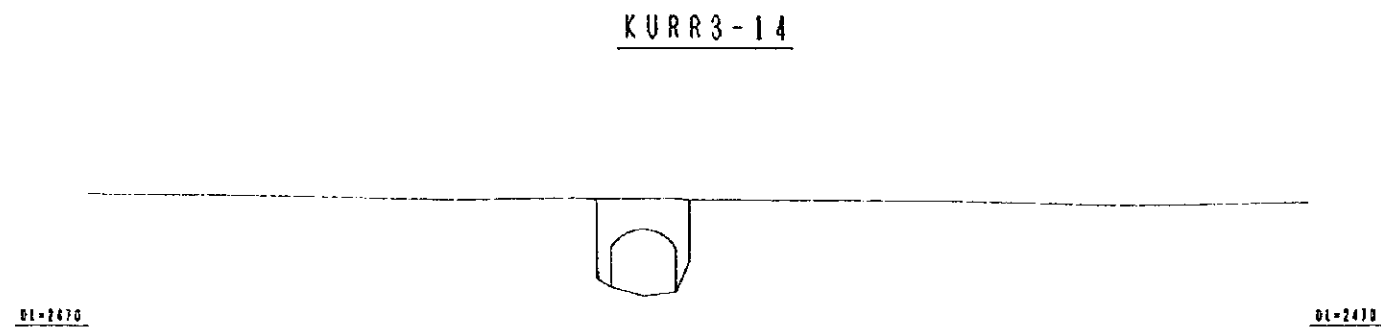
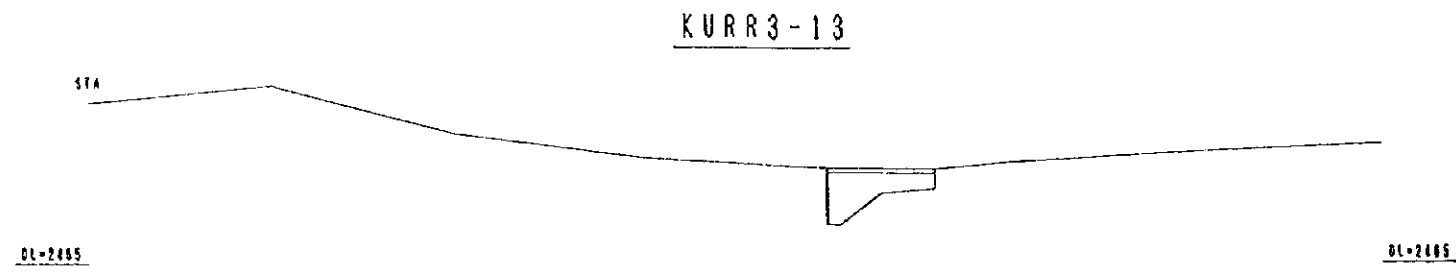

THE STUDY ON ADDIS ABABA FLOOD CONTROL PROJECT IN THE FEDERAL DEMOCRATIC REPUBLIC OF ETHIOPIA	
JAPAN INTERNATIONAL COOPERATION AGENCY REGION 14 ADMINISTRATION	
DRAWING NO. KURR3-SECT-03	LOCATION OF RIVER CROSS SECTION KURTUME (KURR3) RIVER (03/03)

Profile Section V=1:500  
H=1:10000

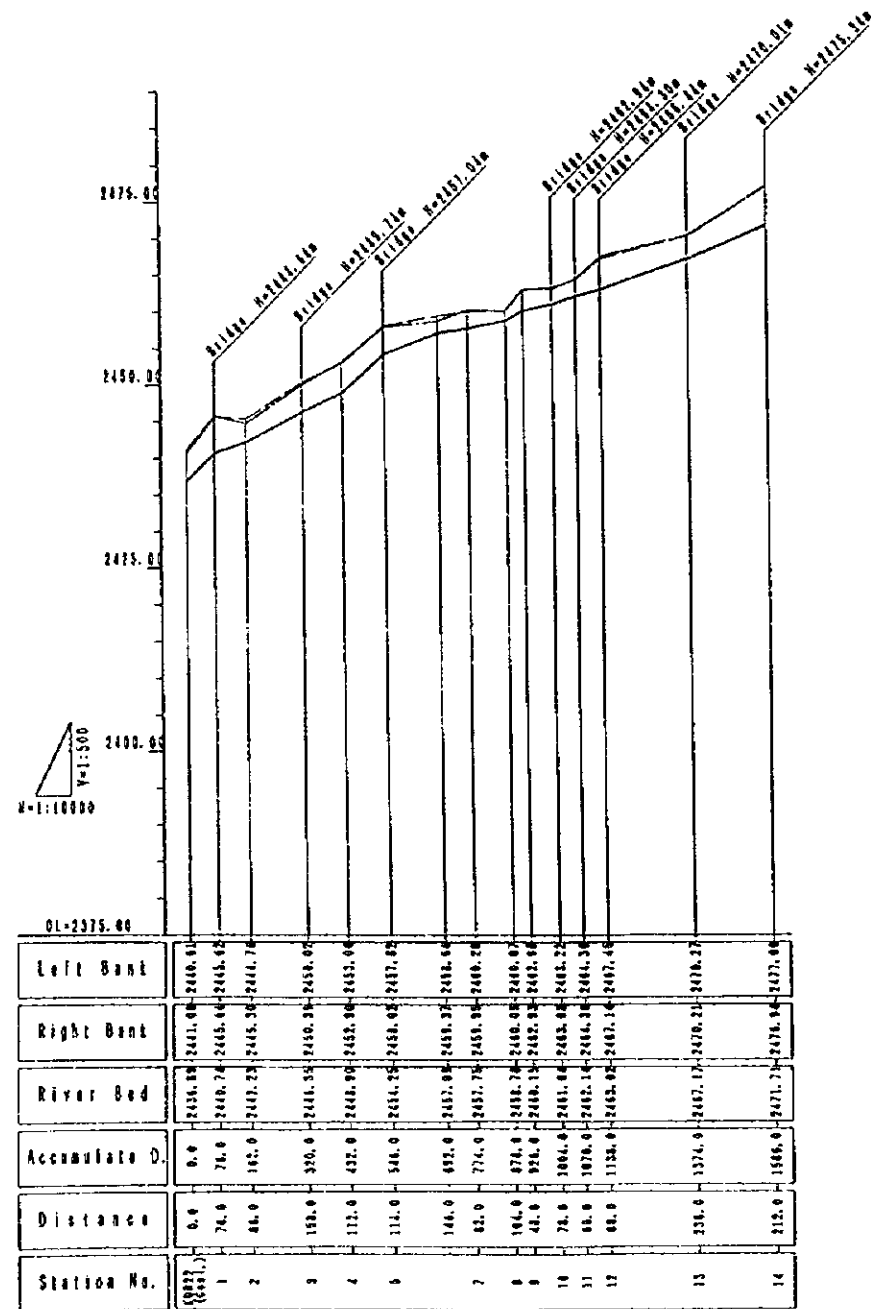

Left Bank	—————
Right Bank	-----
River Bed	.....

THE STUDY ON ADDIS ABABA FLOOD CONTROL PROJECT  
IN THE FEDERAL DEMOCRATIC REPUBLIC OF ETHIOPIA  
JAPAN INTERNATIONAL COOPERATION AGENCY  
REGION 14 ADMINISTRATION

DRAWING NO. LOCATION OF RIVER PROFILE SECTION  
KURRS-SECT-01 KURTUME (KURRS) RIVER (01/01)