

Source : National Water Master Plan 1992, JICA

JAPAN INTERNATIONAL COOPERATION AGENCY  
 REPUBLIC OF KENYA  
 MUTONGA/GRAND FALLS HYDROPOWER PROJECT

Lower Tana River Basin

Fig. No.  
 6.3.11

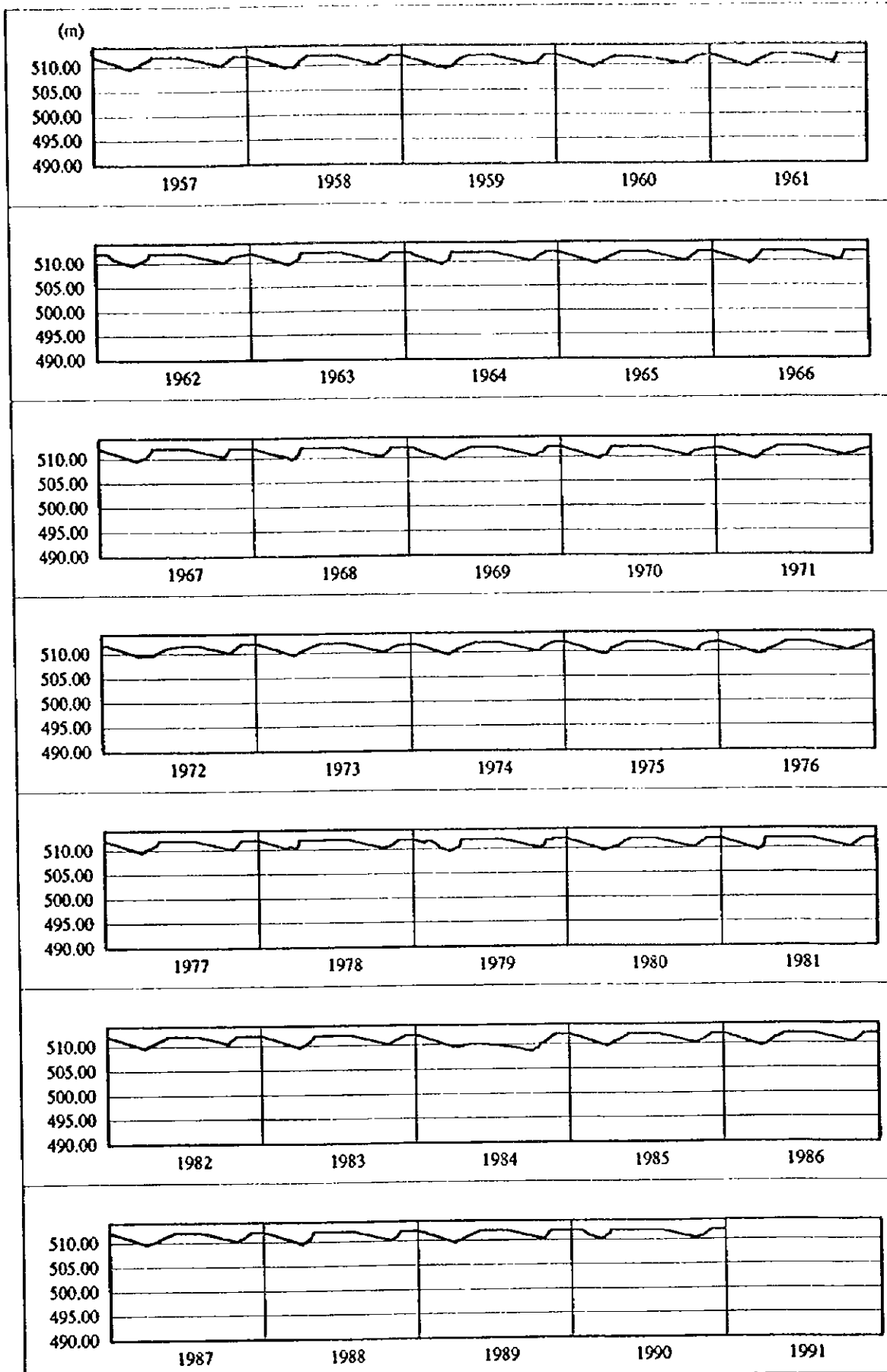

JAPAN INTERNATIONAL COOPERATION AGENCY  
 REPUBLIC OF KENYA  
 GRANDFALLS/MUTONGA HYDROPOWER PROJECT

Low Grand Falls Power Operation  
 Reservoir Water Level Results

Fig. No.  
 6.3.12

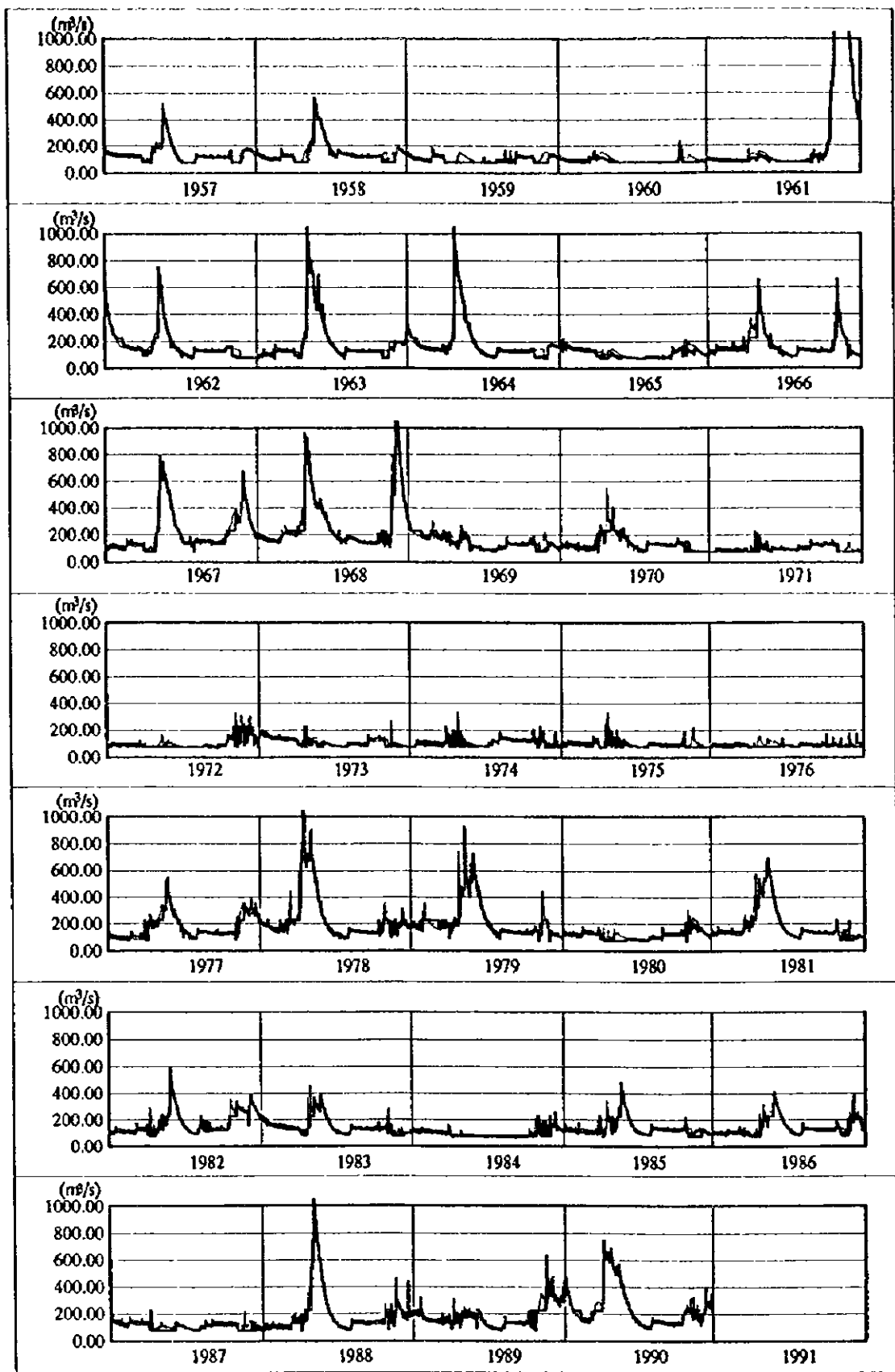

— Inflow  
 — Outflow

JAPAN INTERNATIONAL COOPERATION AGENCY  
 REPUBLIC OF KENYA  
 GRANDFALLS/MUTONGA HYDROPOWER PROJECT

Low Grand Falls Power Operation  
 Outflow Results

Fig. No.  
 6.3.13

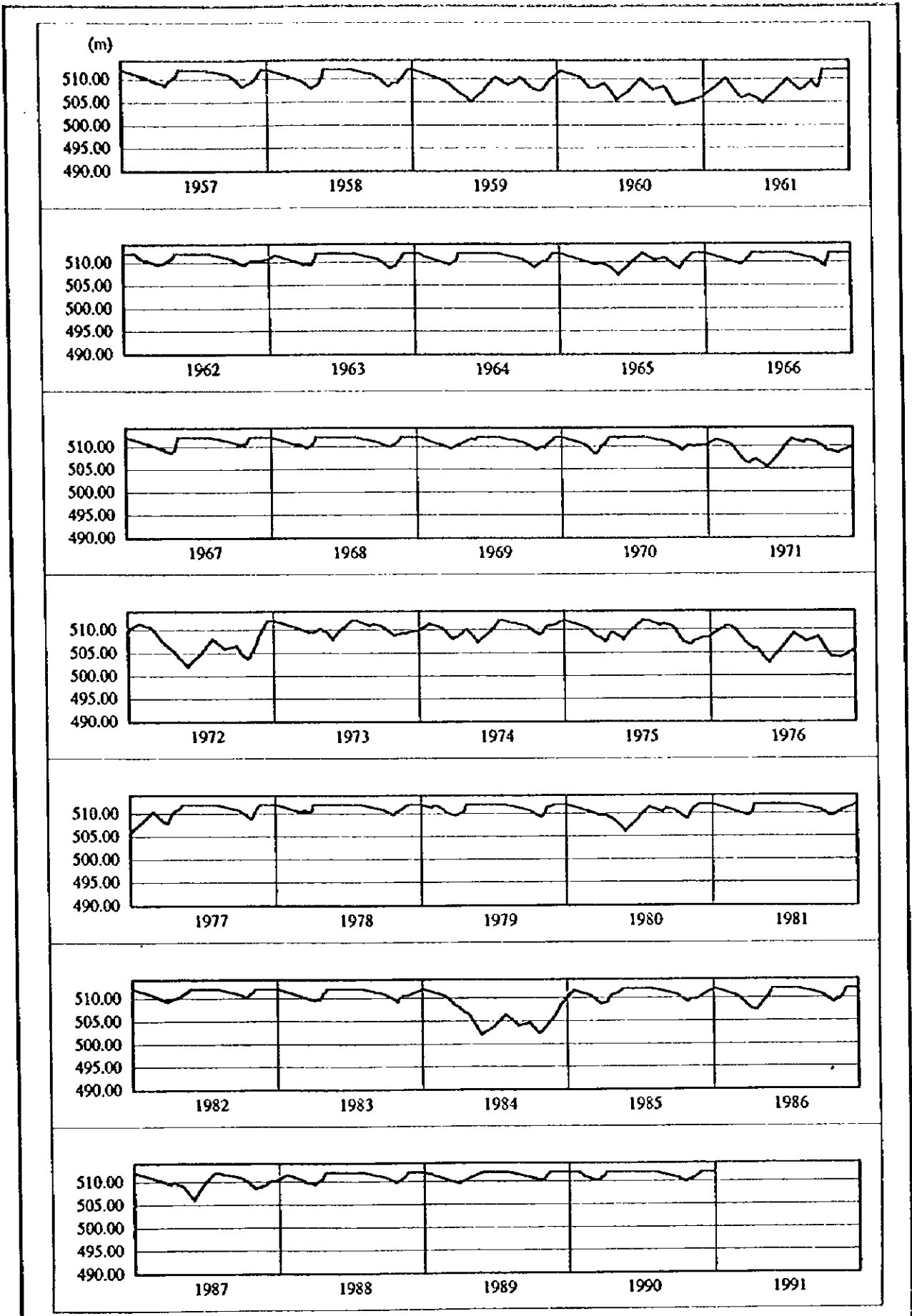

JAPAN INTERNATIONAL COOPERATION AGENCY  
 REPUBLIC OF KENYA  
 GRANDFALLS/MUTONGA HYDROPOWER PROJECT

Low Grand Falls Irrigation Operation  
 Reservoir Water Level Results

Fig. No.  
 6.3.14

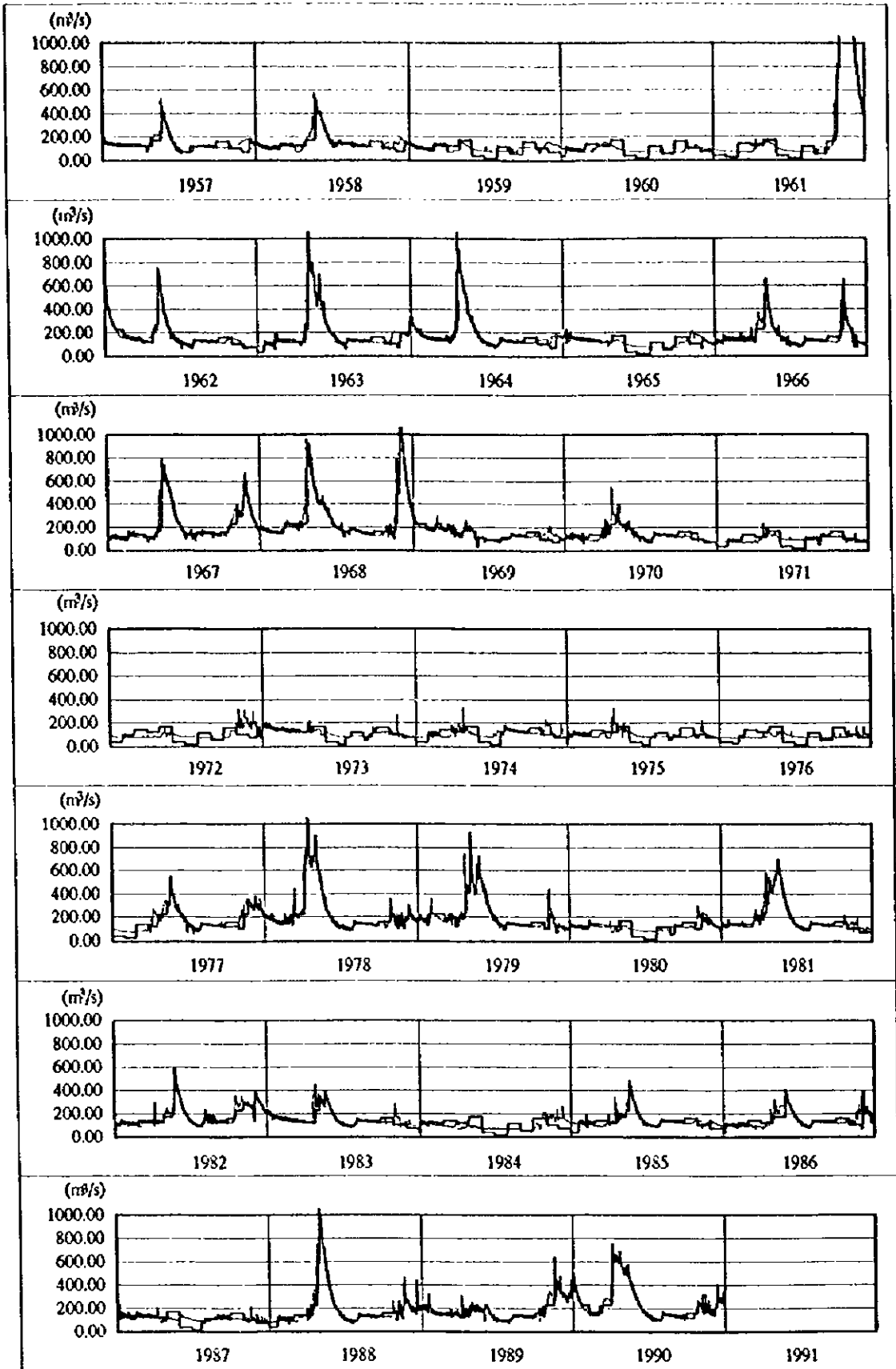

— Inflow  
 - - - Outflow

JAPAN INTERNATIONAL COOPERATION AGENCY  
 REPUBLIC OF KENYA  
 GRANDFALLS/MUTONGA HYDROPOWER PROJECT

Low Grand Falls Irrigation Operation  
 Outflow Results

Fig. No.  
 6.3.15

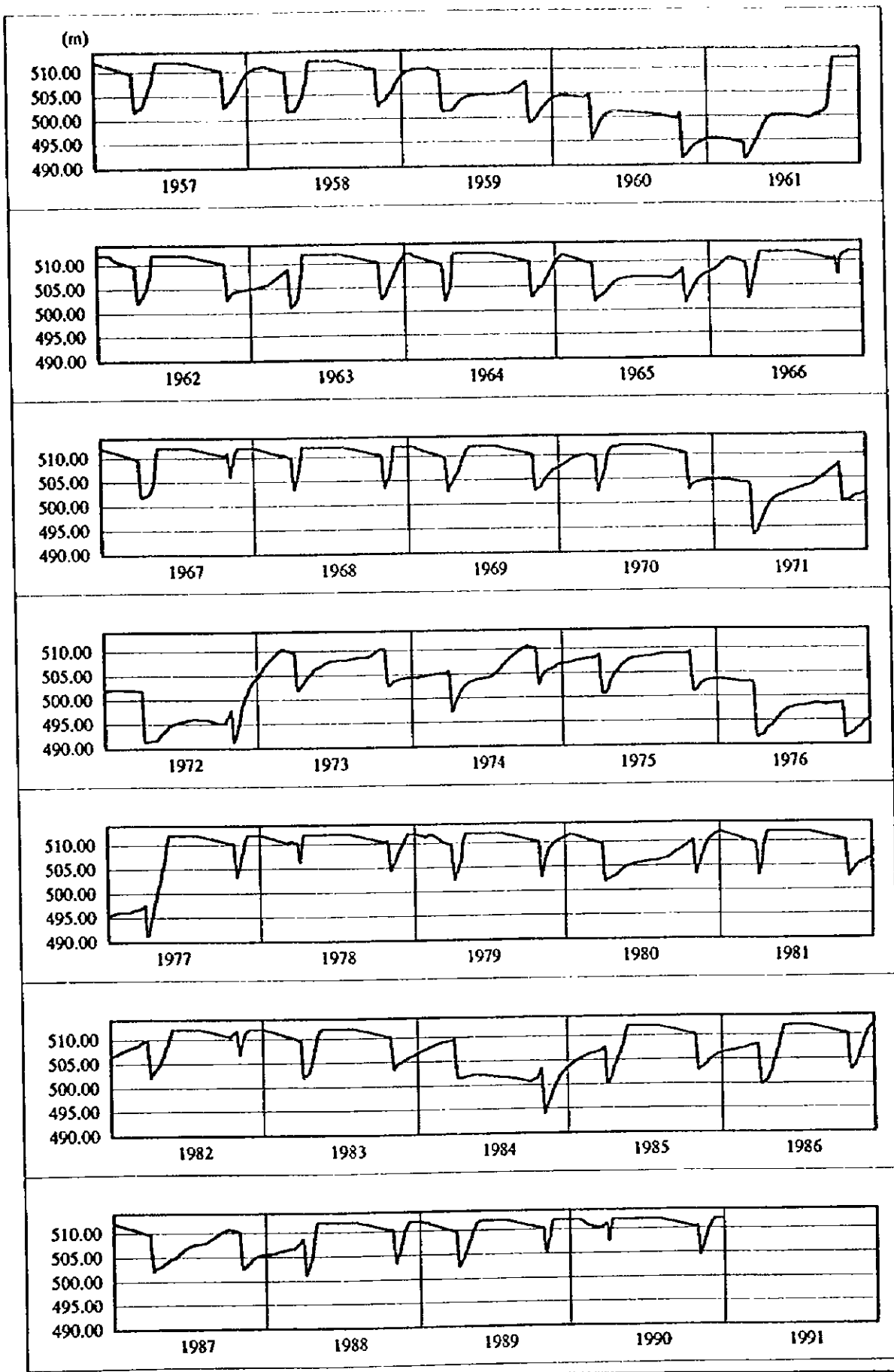

JAPAN INTERNATIONAL COOPERATION AGENCY  
 REPUBLIC OF KENYA  
 GRANDFALLS/MUTONGA HYDROPOWER PROJECT

Low Grand Falls Flood Operation  
 Reservoir Water Level Results

Fig. No.  
 6.3.16

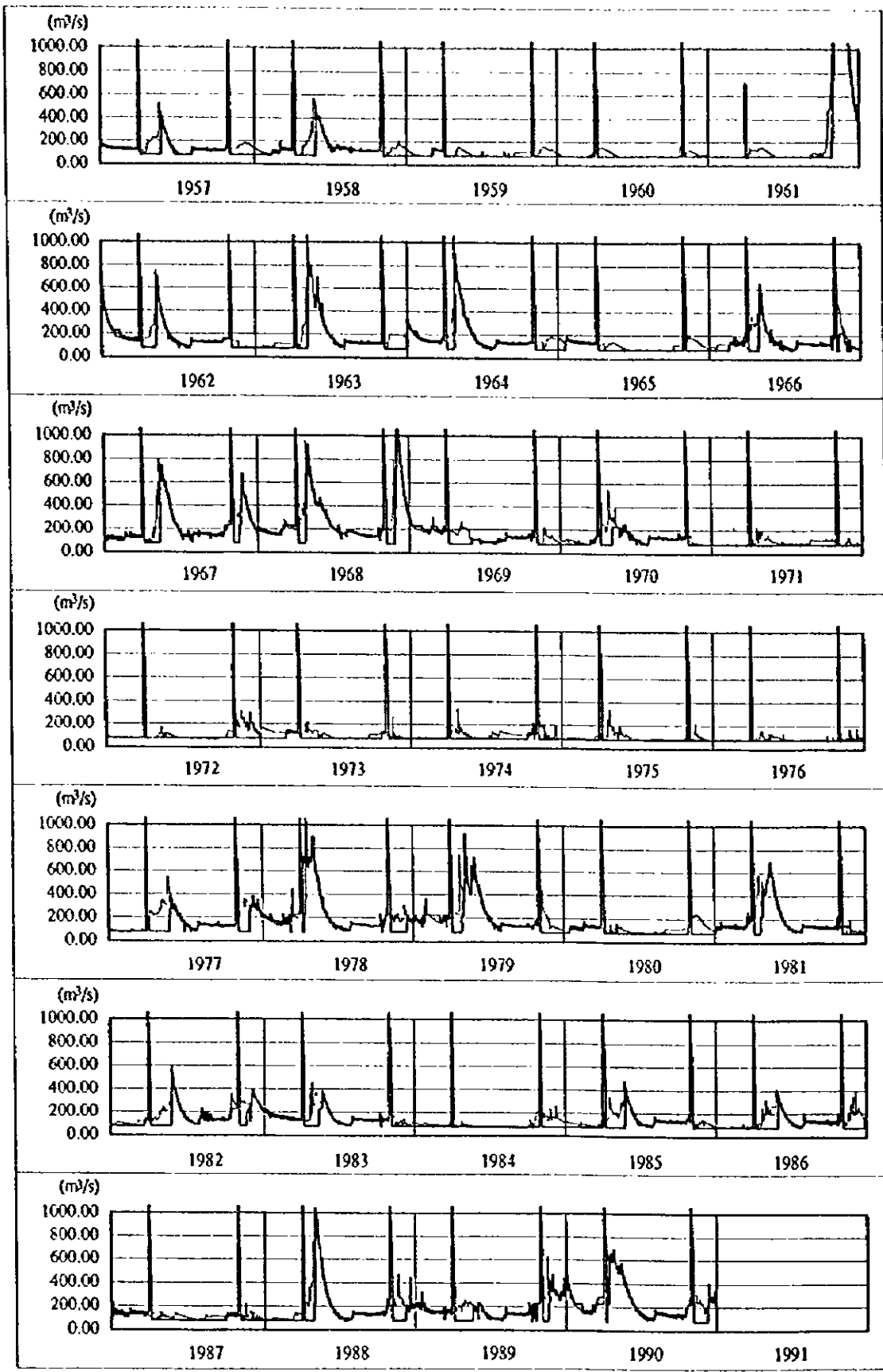

— Inflow  
 — Outflow

JAPAN INTERNATIONAL COOPERATION AGENCY  
 REPUBLIC OF KENYA  
 GRANDFALLS/MUTONGA HYDROPOWER PROJECT

Low Grand Falls Flood Operation  
 Outflow Results

Fig. No.  
 6.3.17



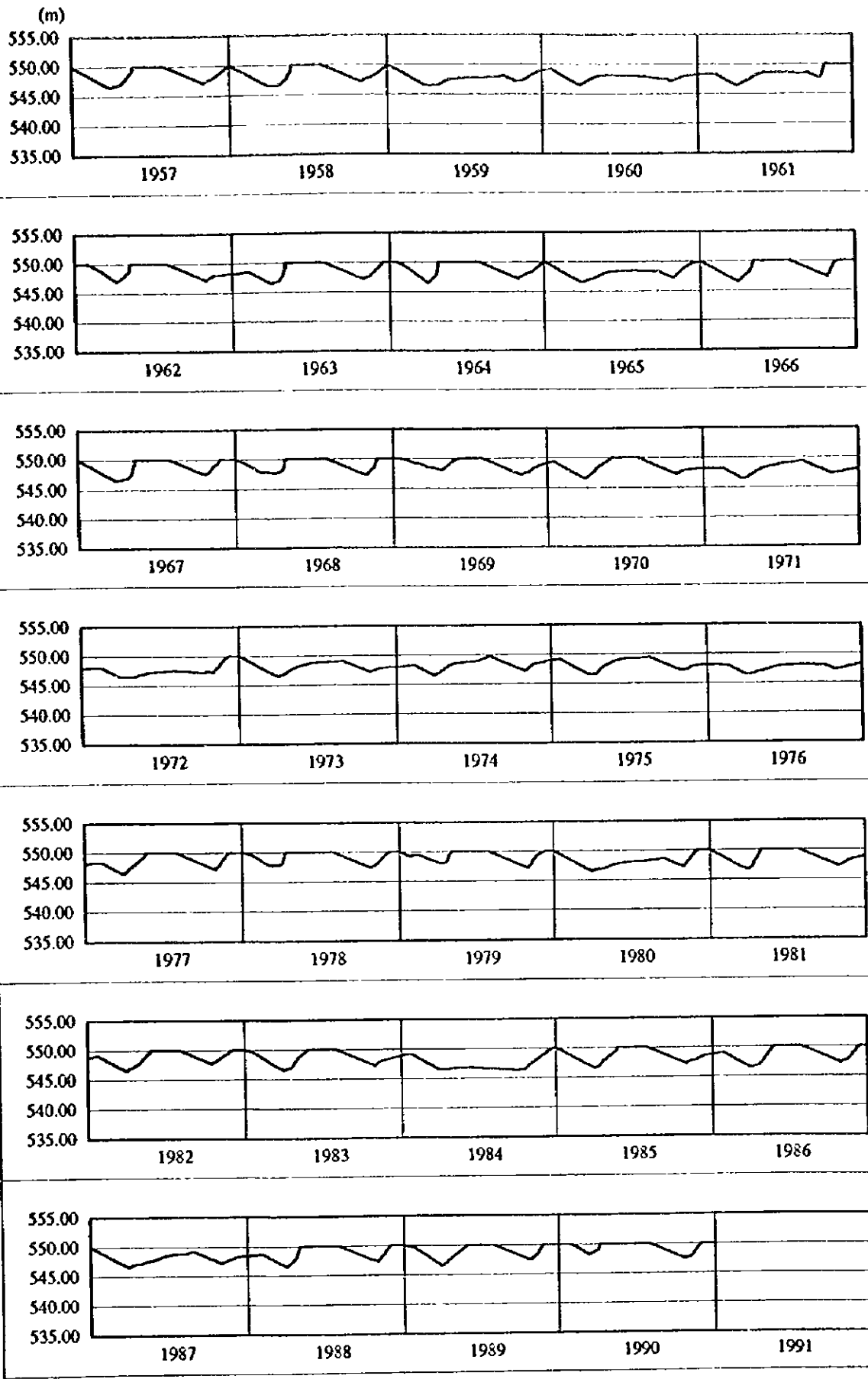

JAPAN INTERNATIONAL COOPERATION AGENCY  
 REPUBLIC OF KENYA  
 GRANDFALLS/MUTONGA HYDROPOWER PROJECT

High Grand Falls Power Operation  
 Reservoir Water Level Results

Fig. No.  
 6.3.18

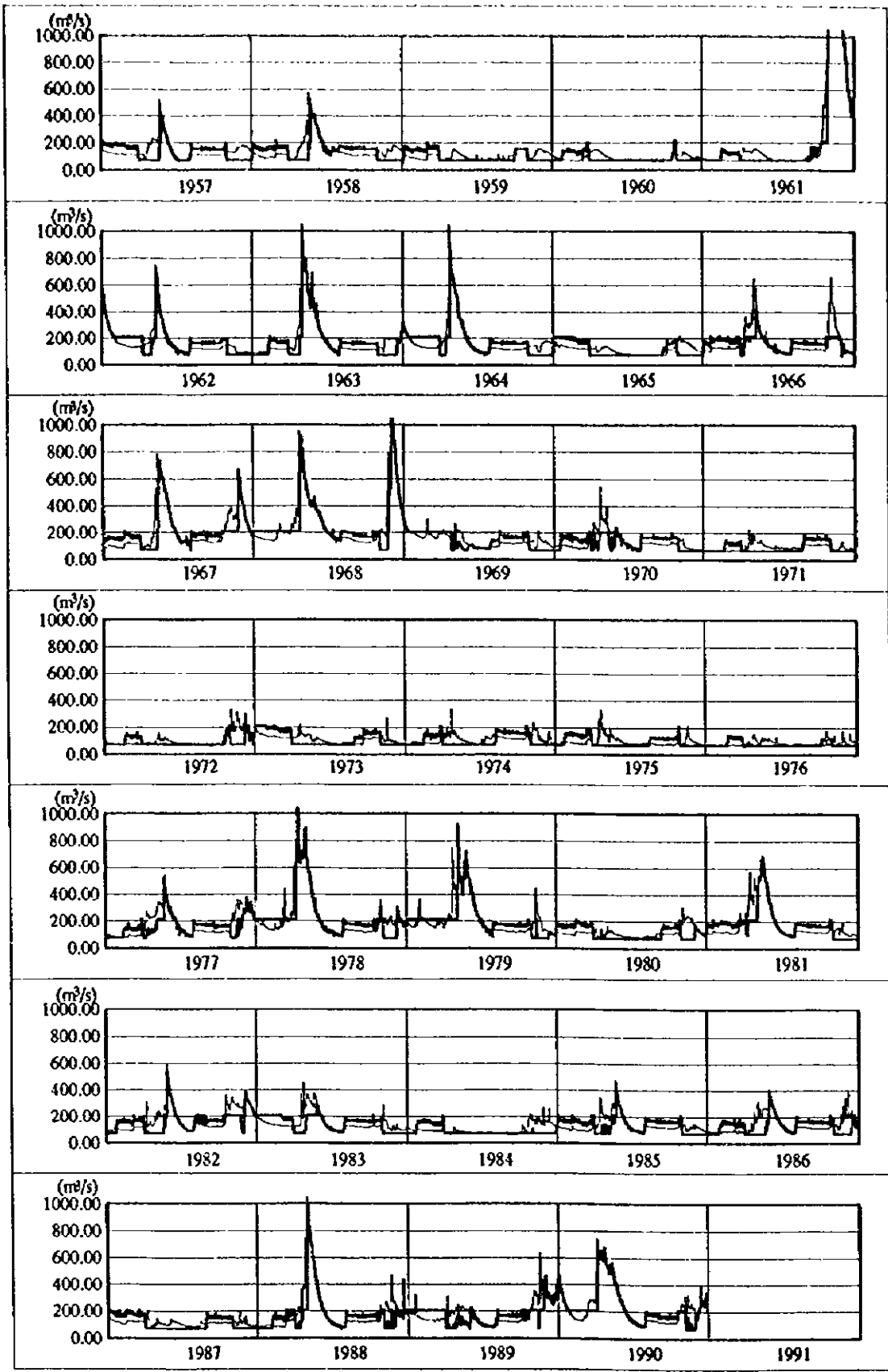

— Inflow  
— Outflow

JAPAN INTERNATIONAL COOPERATION AGENCY REPUBLIC OF KENYA GRANDFALLS/MUTONGA HYDROPOWER PROJECT	High Grand Falls Power Operation Outflow Results	Fig. No. 6.3.19
--	---	--------------------

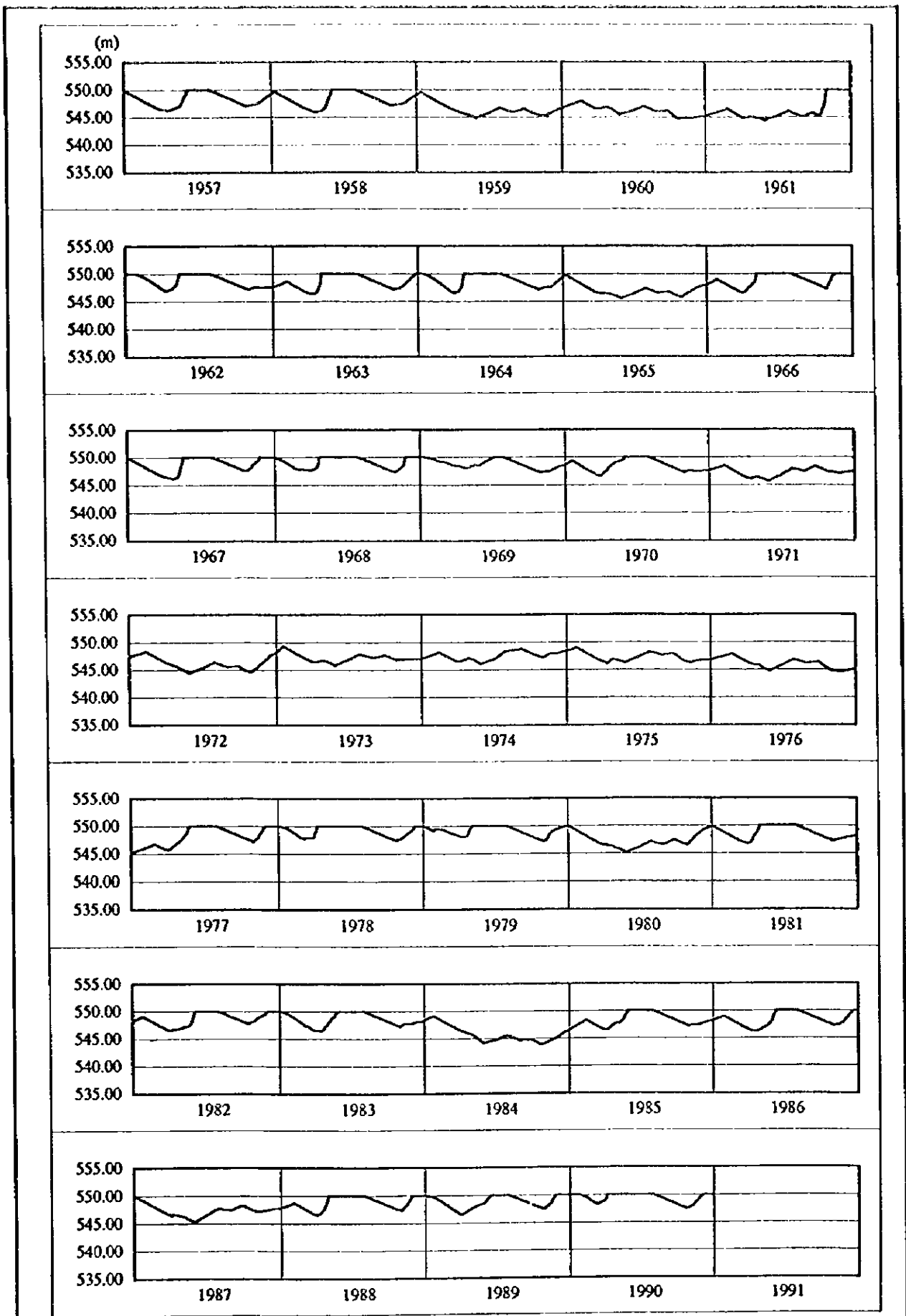

JAPAN INTERNATIONAL COOPERATION AGENCY  
 REPUBLIC OF KENYA  
 GRANDFALLS/MUTONGA HYDROPOWER PROJECT

High Grand Falls Irrigation Operation  
 Reservoir Water Level Results

Fig. No.  
 6.3.20

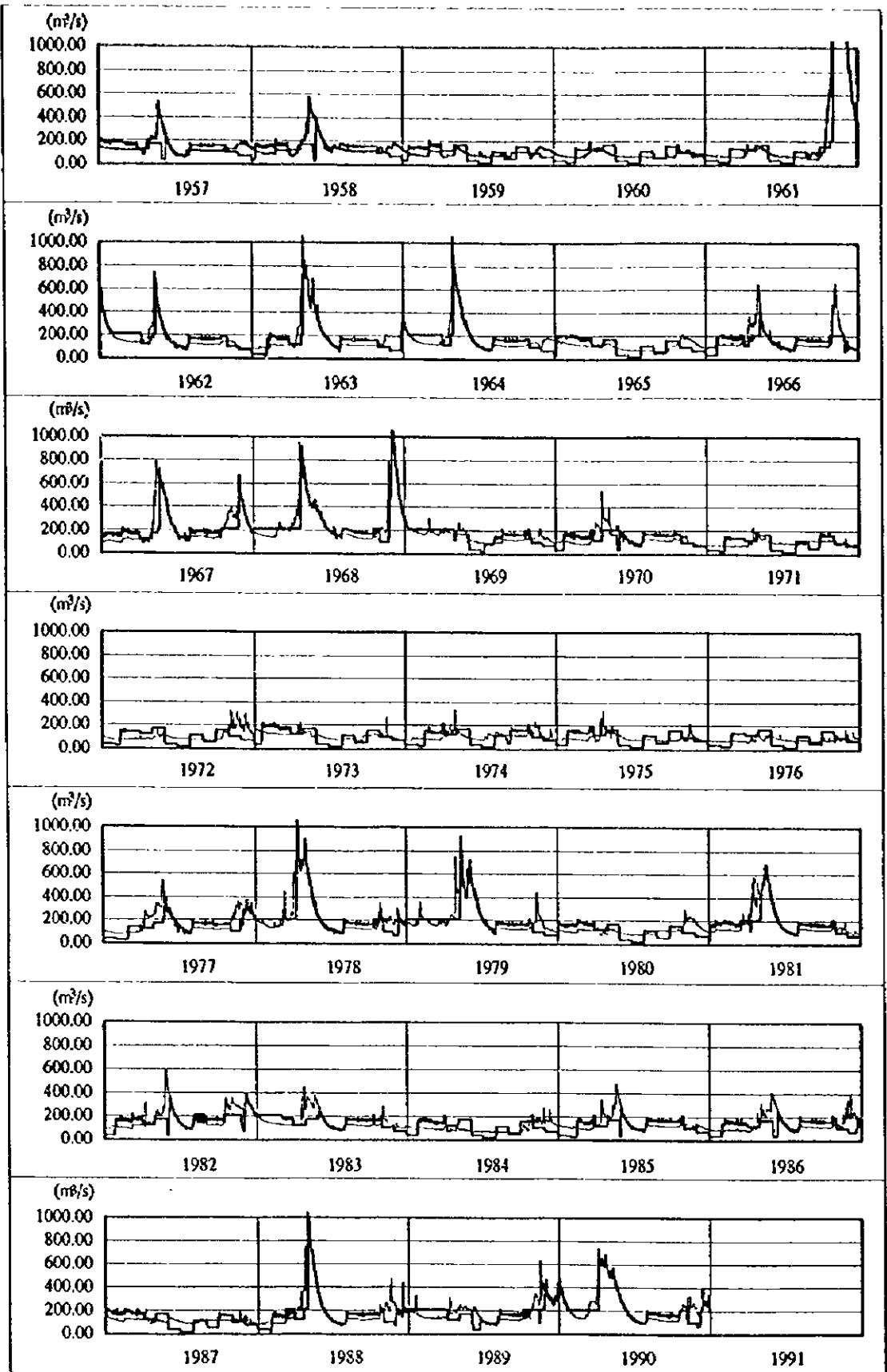

— Inflow  
 — Outflow

JAPAN INTERNATIONAL COOPERATION AGENCY REPUBLIC OF KENYA GRANDFALLS/MUTONGA HYDROPOWER PROJECT	High Grand Falls Irrigation Operation	Fig. No.
	Outflow Results	6.3.21

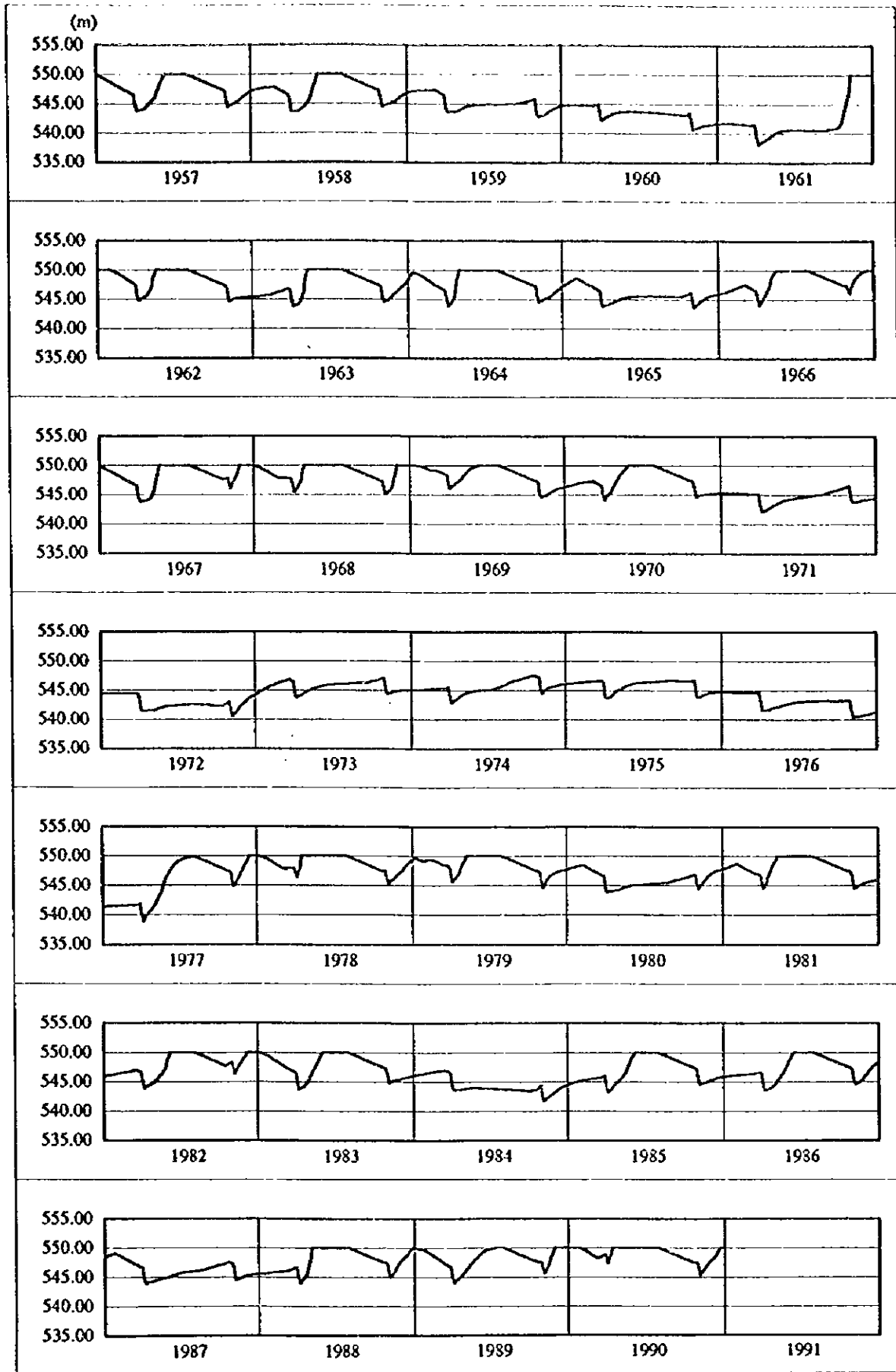

JAPAN INTERNATIONAL COOPERATION AGENCY  
 REPUBLIC OF KENYA  
 GRANDFALLS/MUTONGA HYDROPOWER PROJECT

High Grand Falls Flood Operation  
 Reservoir Water Level Results

Fig. No.  
 6.3.22

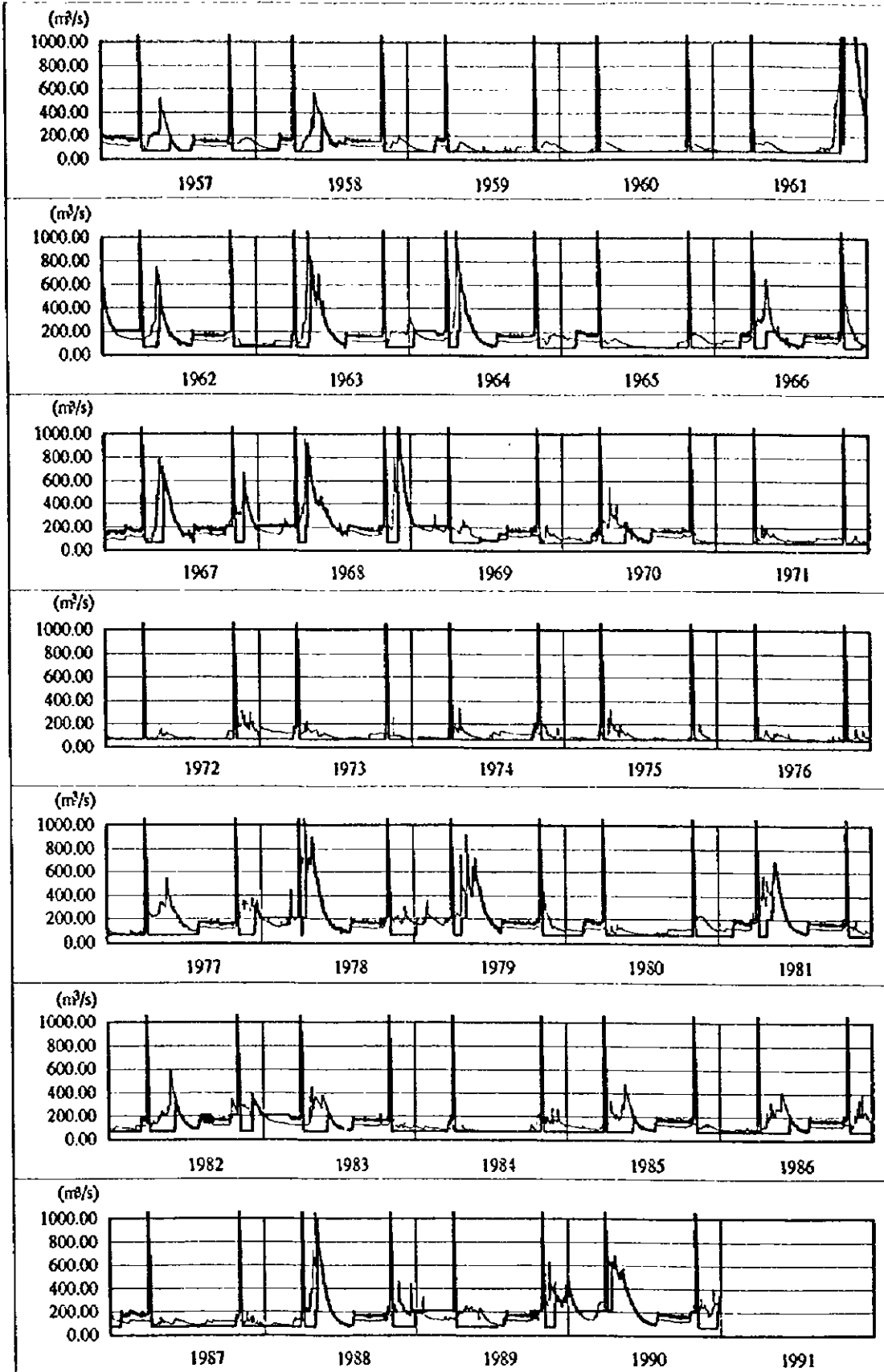

— Inflow  
 - - - Outflow

JAPAN INTERNATIONAL COOPERATION AGENCY  
 REPUBLIC OF KENYA  
 GRANDFALLS/MUTONGA HYDROPOWER PROJECT

High Grand Falls Flood Operation  
 Outflow Results

Fig. No.  
 6.3.23

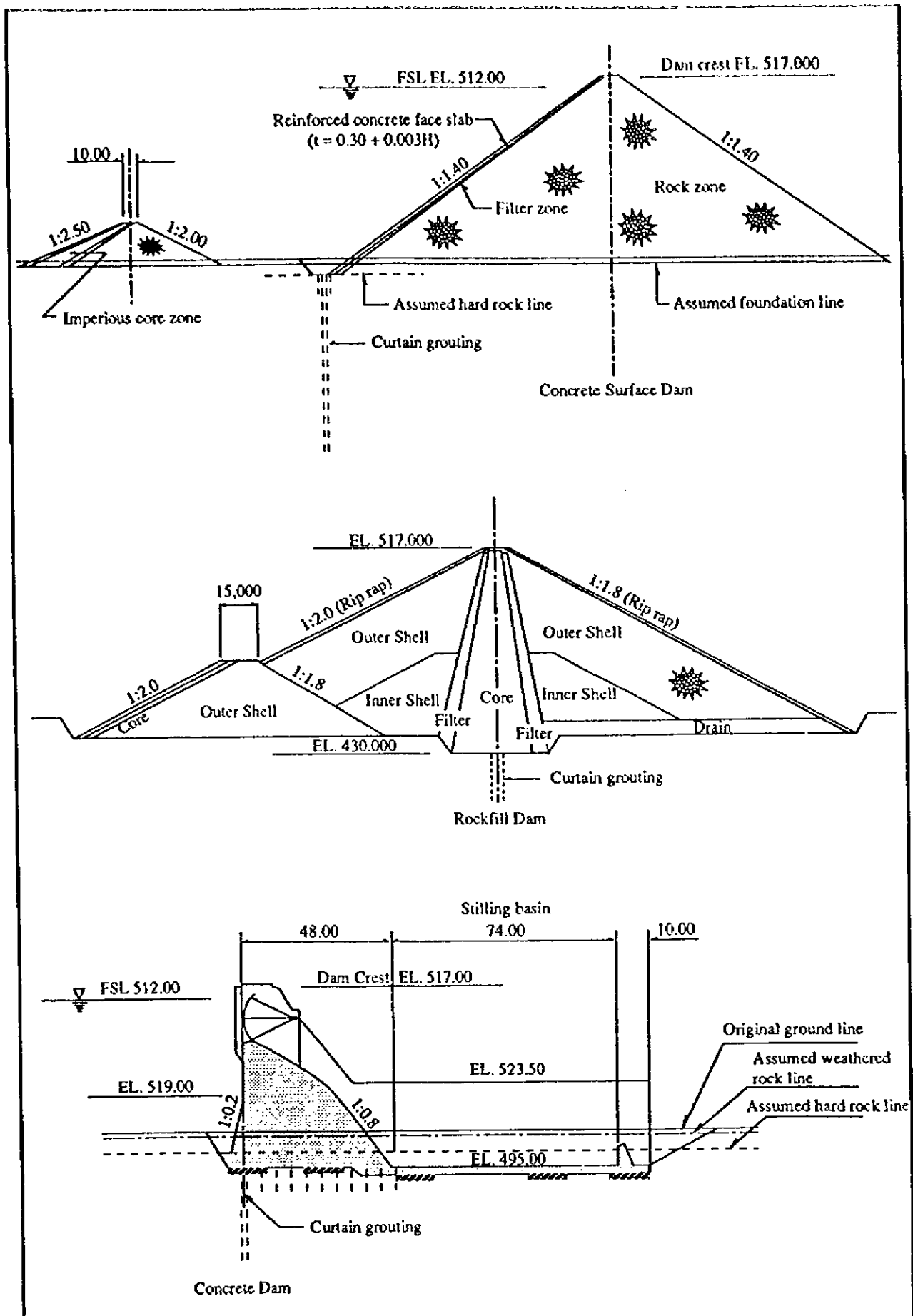

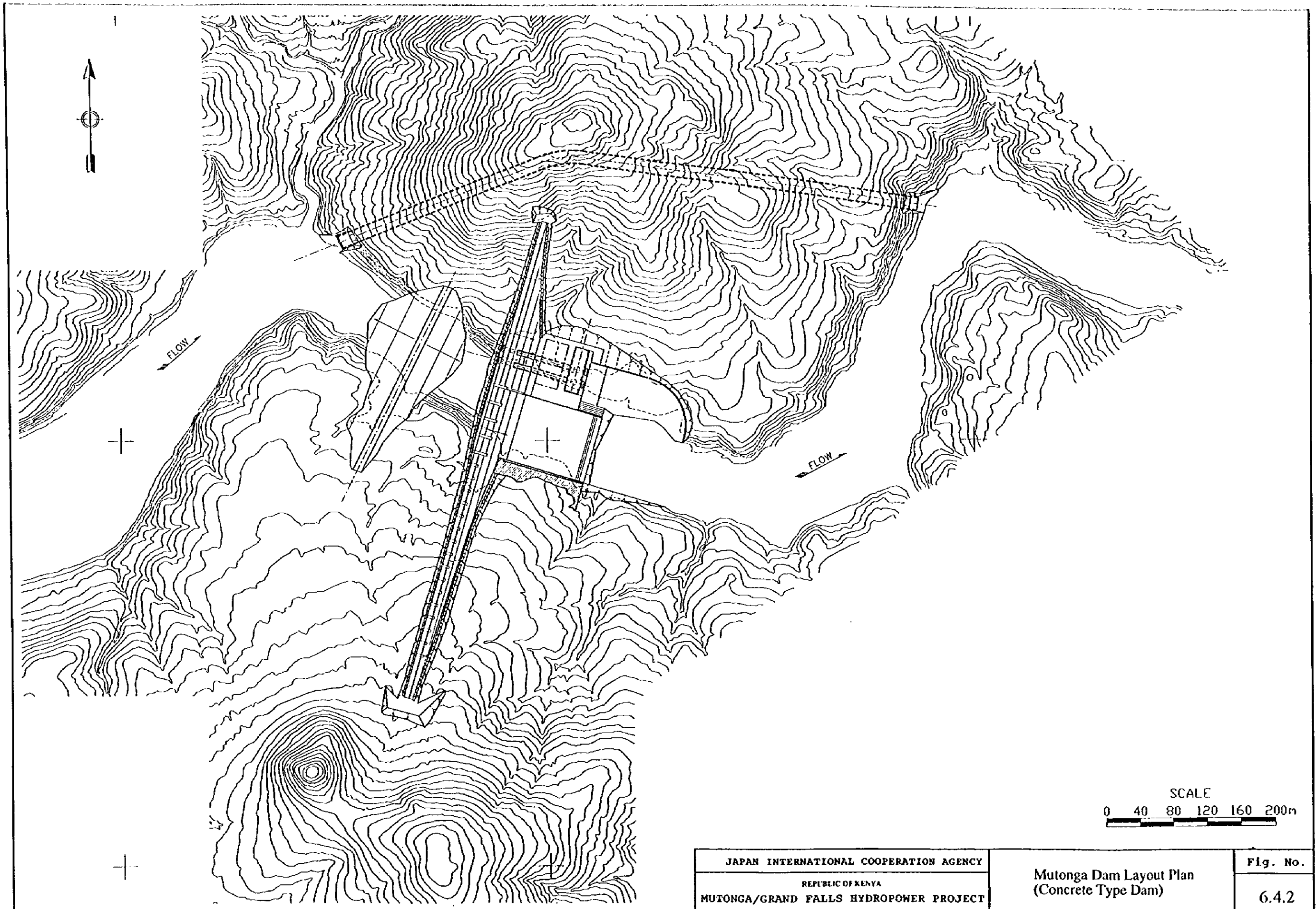

JAPAN INTERNATIONAL COOPERATION AGENCY		Mutonga Dam Layout Plan (Concrete Type Dam)	Fig. No.
REPUBLIC OF KENYA MUTONGA/GRAND FALLS HYDROPOWER PROJECT			6.4.2



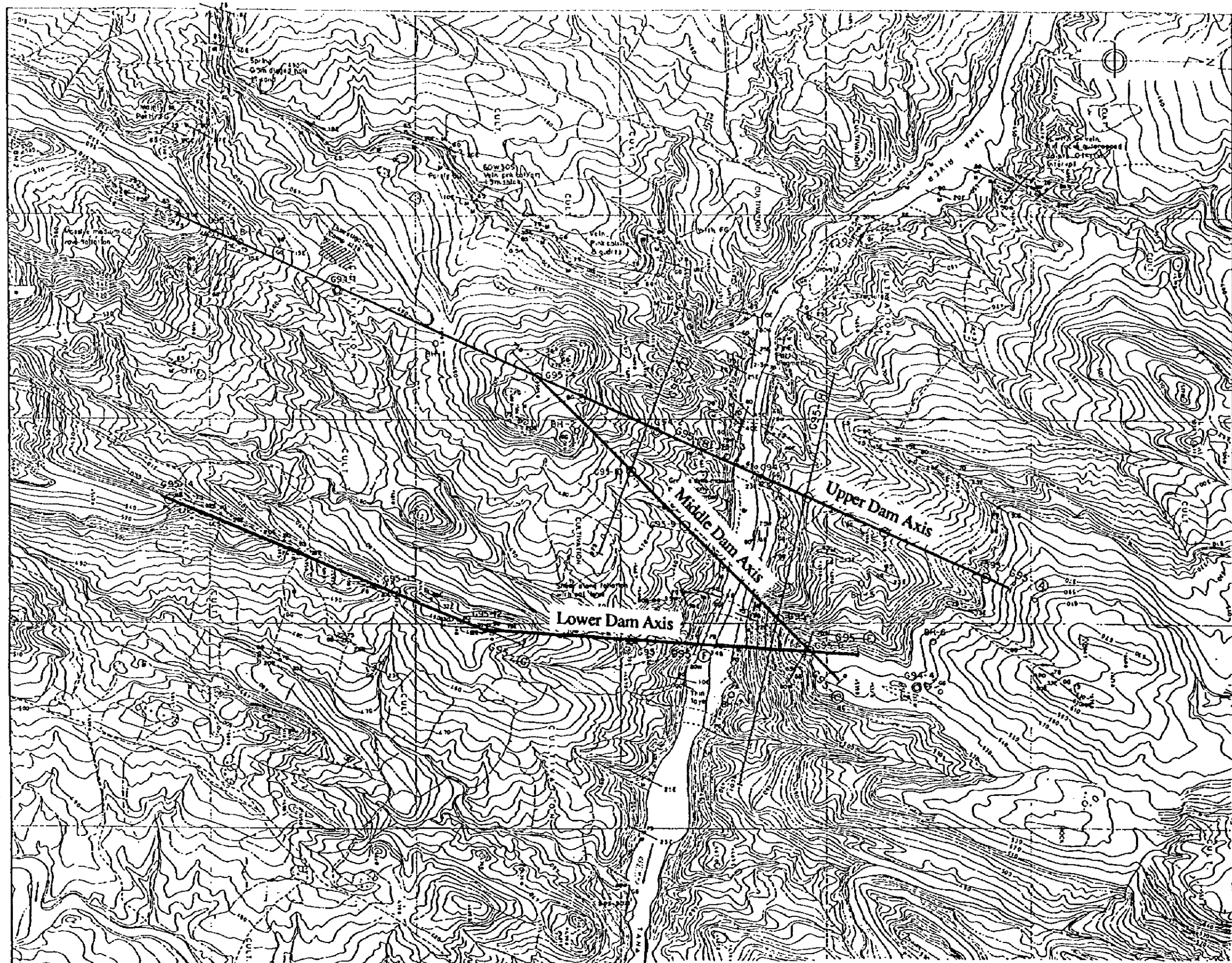

JAPAN INTERNATIONAL COOPERATION AGENCY  
 REPUBLIC OF KENYA  
 MUTONGA/GRAND FALLS HYDROPOWER PROJECT

Dam Axis at Grand Falls Dam Site

Fig. No.  
 6.4.3

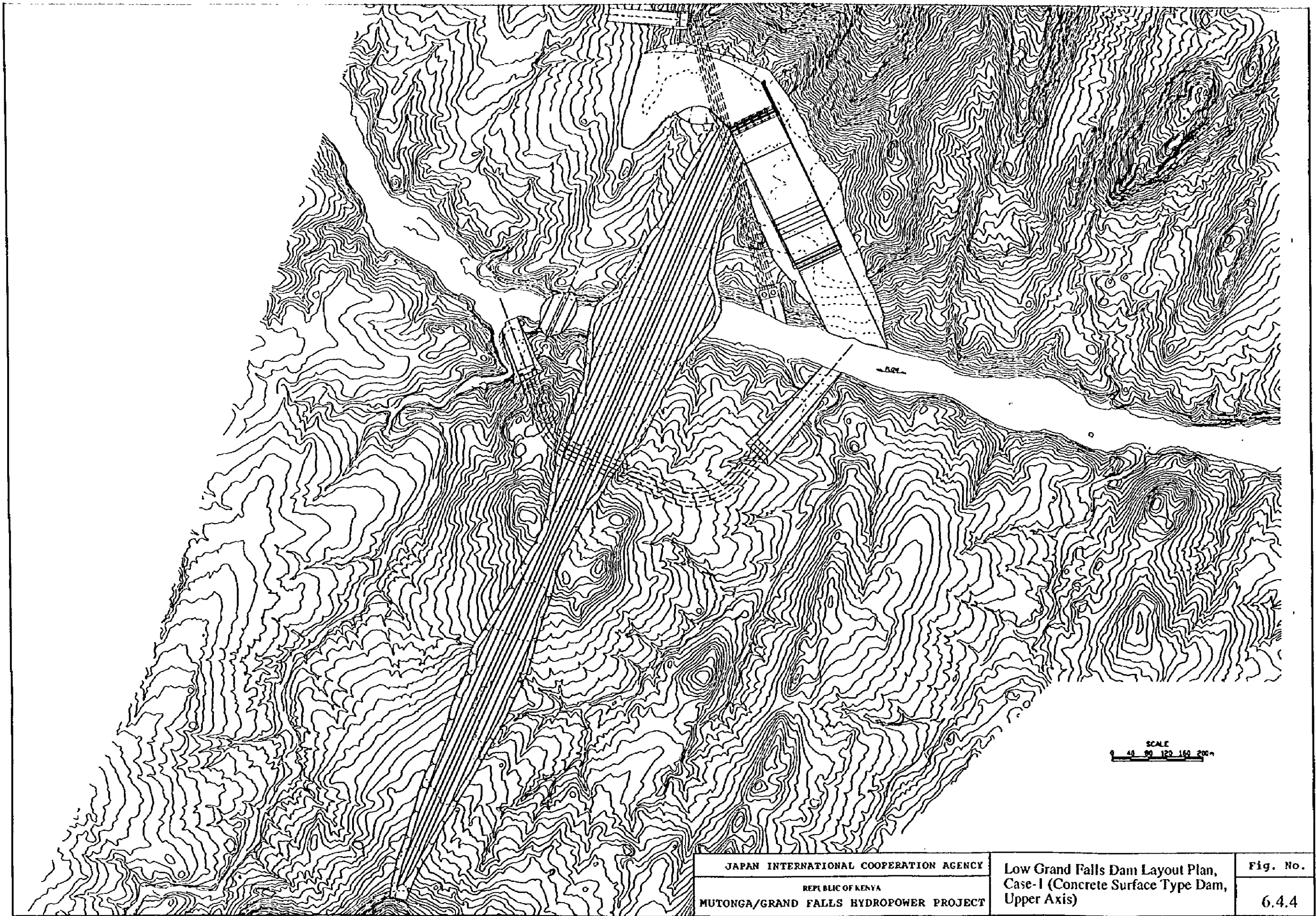

JAPAN INTERNATIONAL COOPERATION AGENCY  
 REPUBLIC OF KENYA  
 MUTONGA/GRAND FALLS HYDROPOWER PROJECT

Low Grand Falls Dam Layout Plan,  
 Case-1 (Concrete Surface Type Dam,  
 Upper Axis)

Fig. No.  
 6.4.4

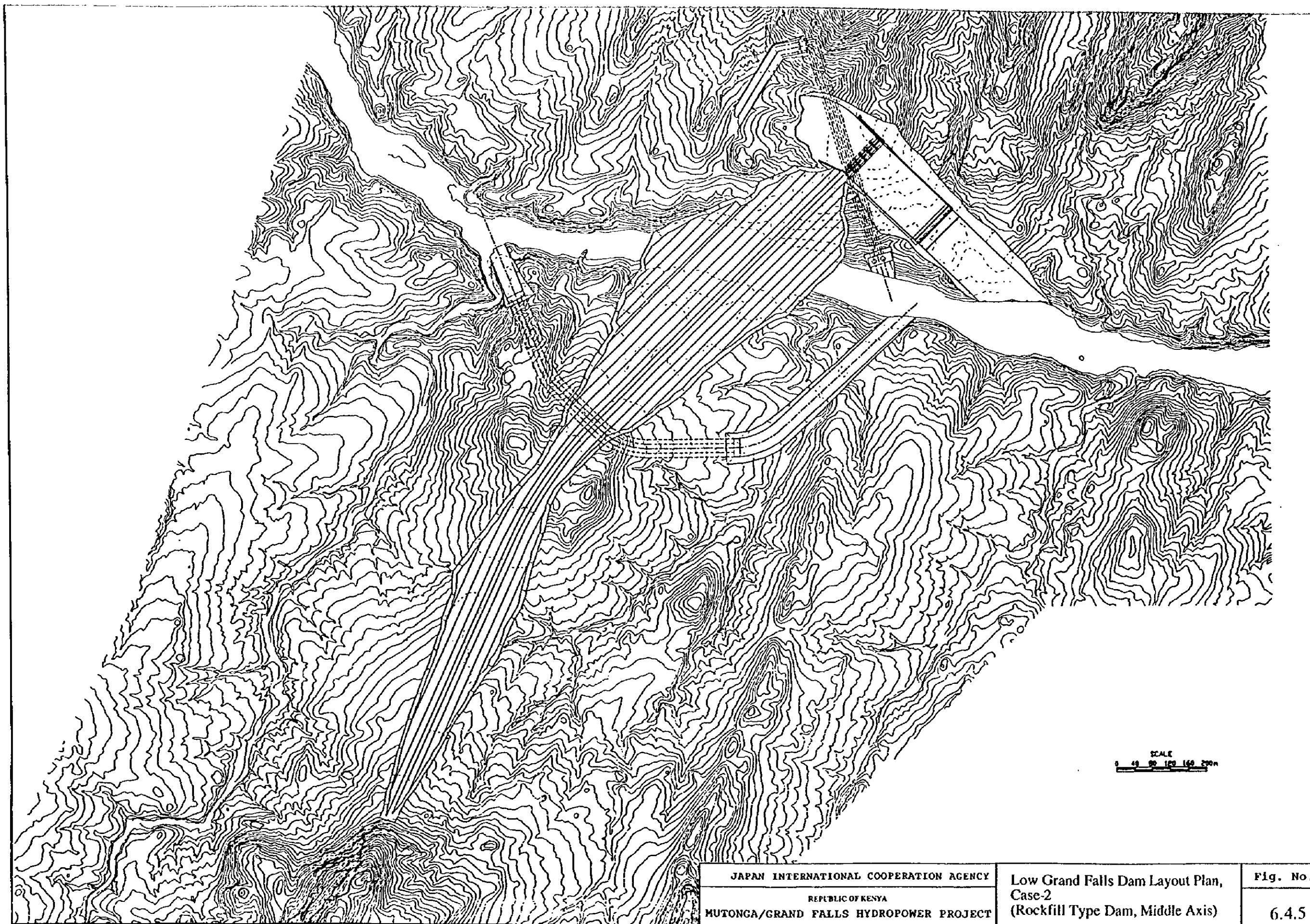

JAPAN INTERNATIONAL COOPERATION AGENCY  
 REPUBLIC OF KENYA  
 MUTONGA/GRAND FALLS HYDROPOWER PROJECT

Low Grand Falls Dam Layout Plan,  
 Case-2  
 (Rockfill Type Dam, Middle Axis)

Fig. No.  
 6.4.5

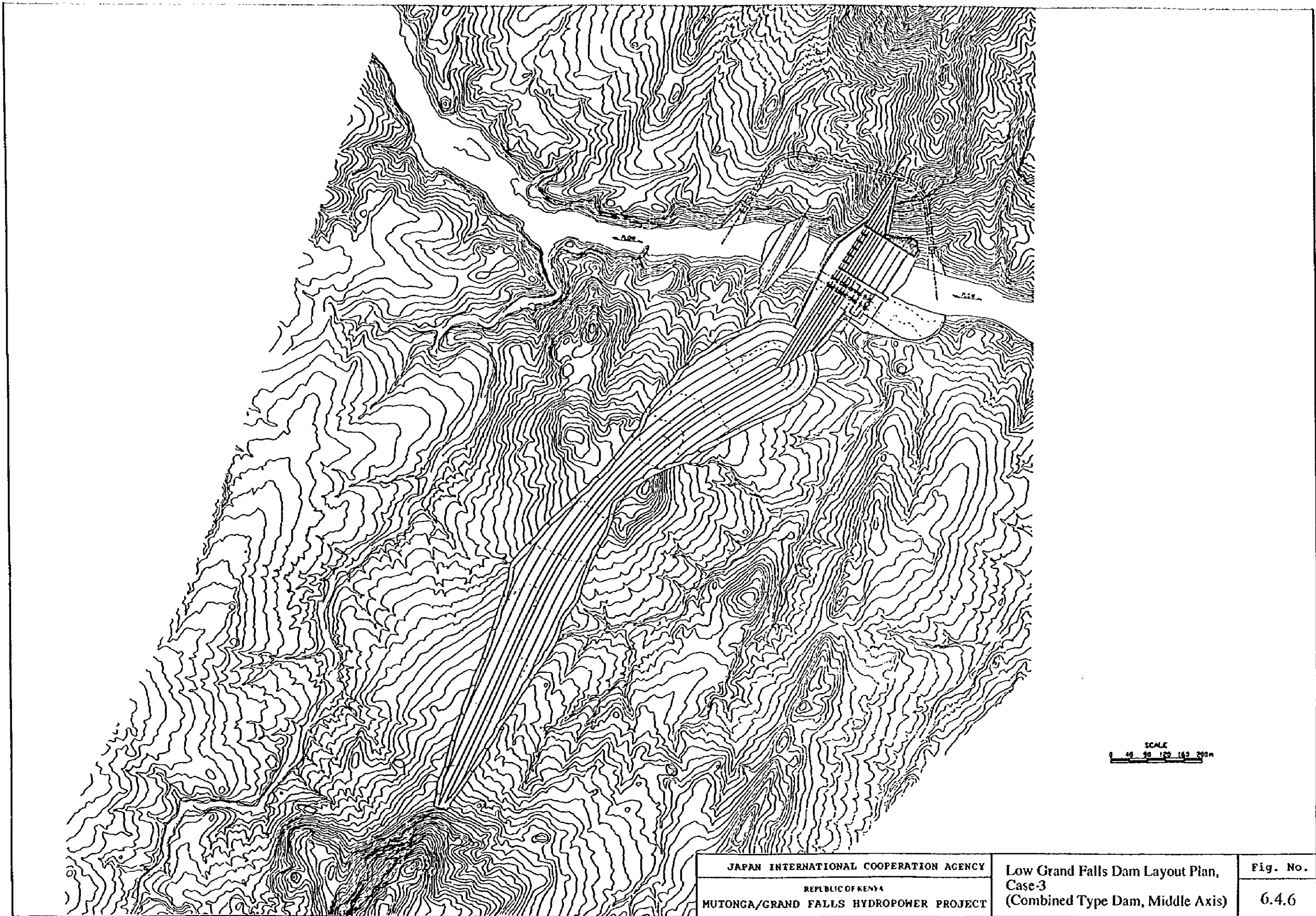

JAPAN INTERNATIONAL COOPERATION AGENCY	Low Grand Falls Dam Layout Plan, Case-3	Fig. No.
REPUBLIC OF KENYA	(Combined Type Dam, Middle Axis)	6.4.6
MUTONGA/GRAND FALLS HYDROPOWER PROJECT		

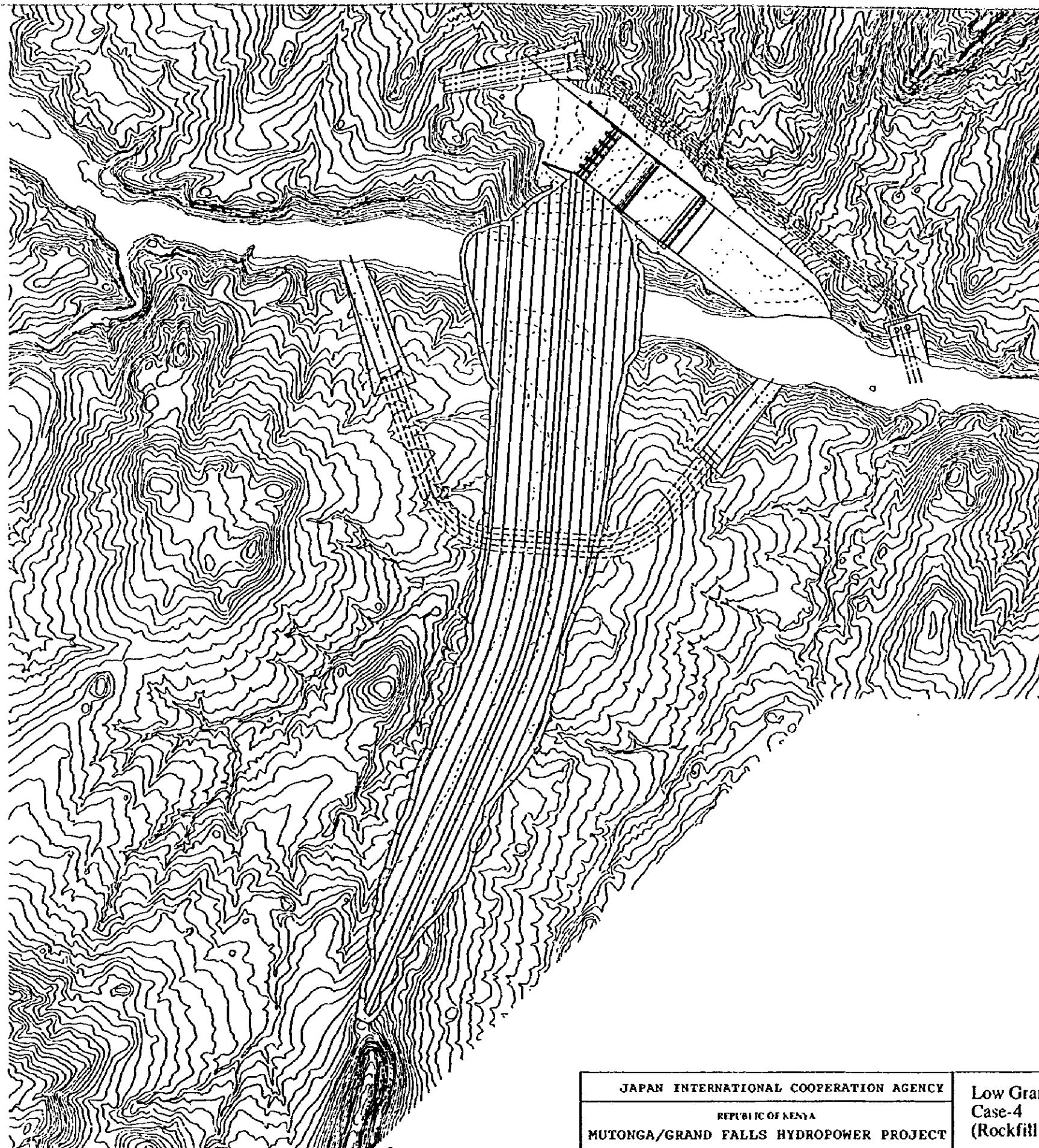

SCALE  
0 40 80 120 160 200m

JAPAN INTERNATIONAL COOPERATION AGENCY	Low Grand Falls Dam Layout Plan,	Fig. No.
REPUBLIC OF KENYA MUTONGA/GRAND FALLS HYDROPOWER PROJECT	Case-4 (Rockfill Type Dam, Lower Axis)	6.4.7

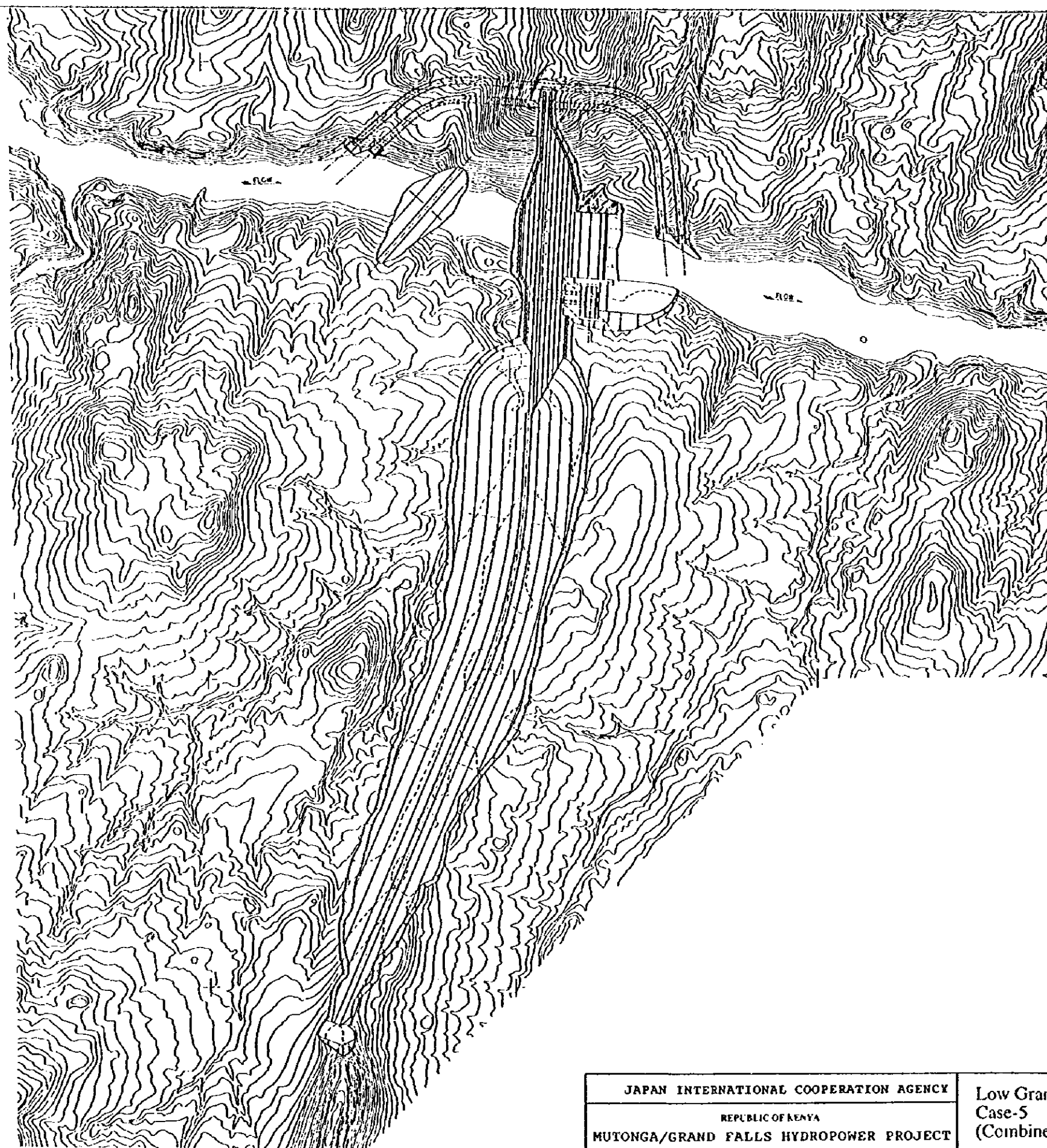

SCALE  
0 40 80 120 160 200m

JAPAN INTERNATIONAL COOPERATION AGENCY	Low Grand Falls Dam Layout Plan, Case-5	Fig. No.
REPUBLIC OF KENYA MUTONGA/GRAND FALLS HYDROPOWER PROJECT	(Combined Type Dam, Lower Axis)	6.4.8



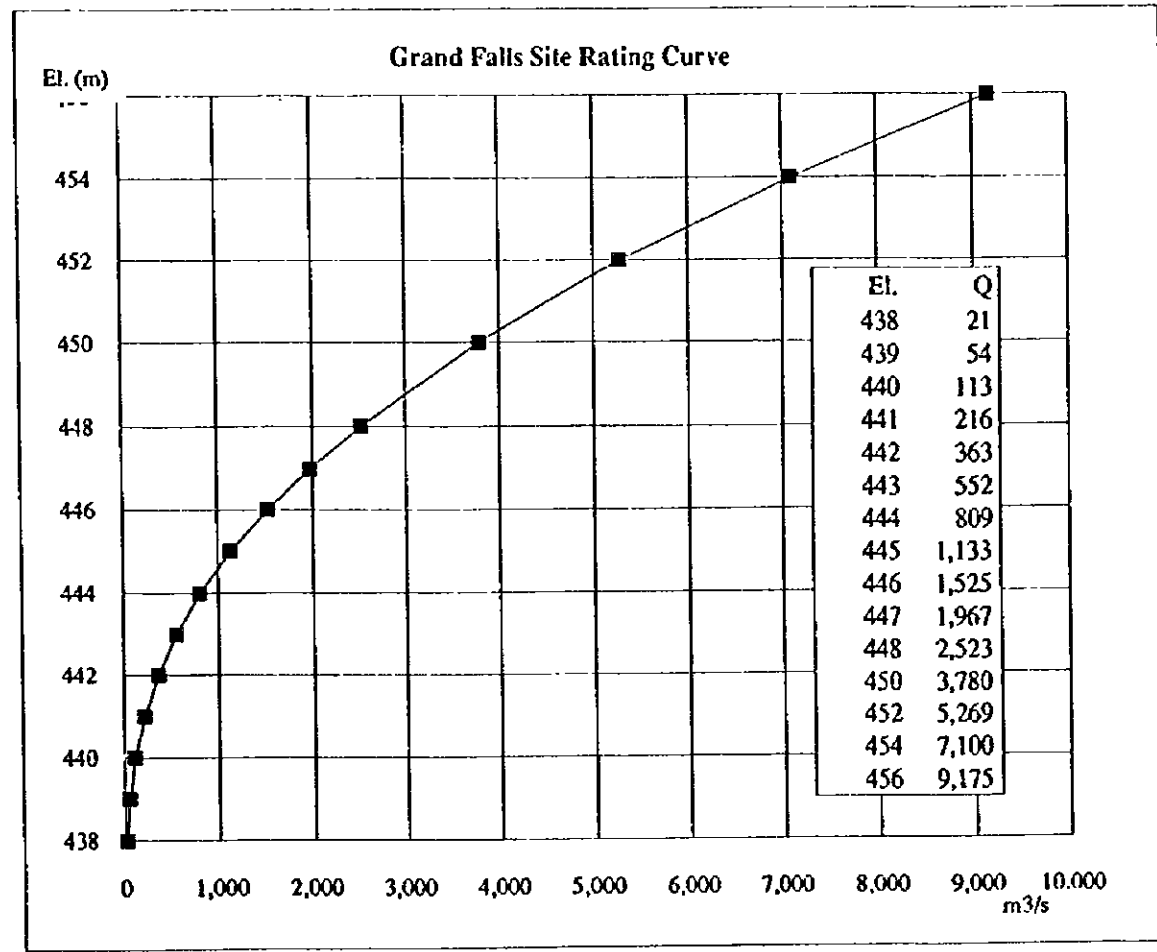
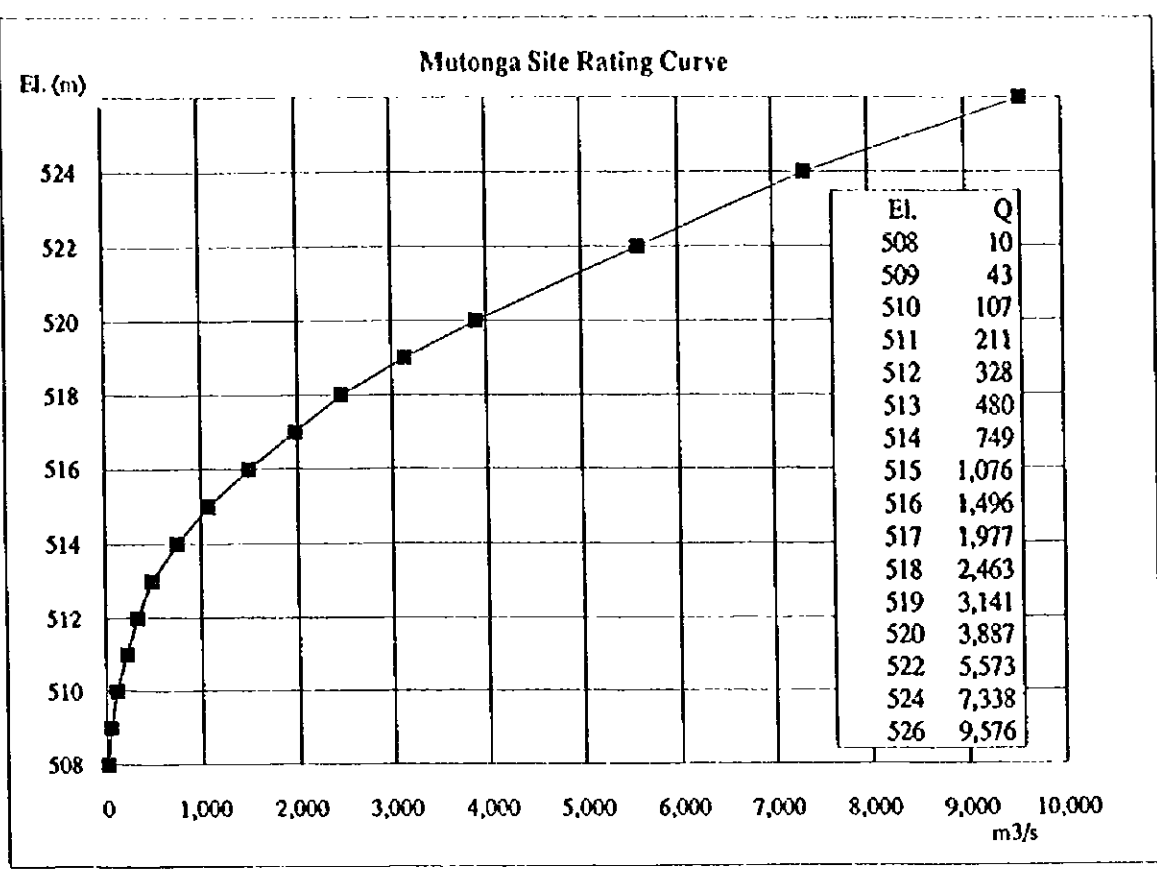



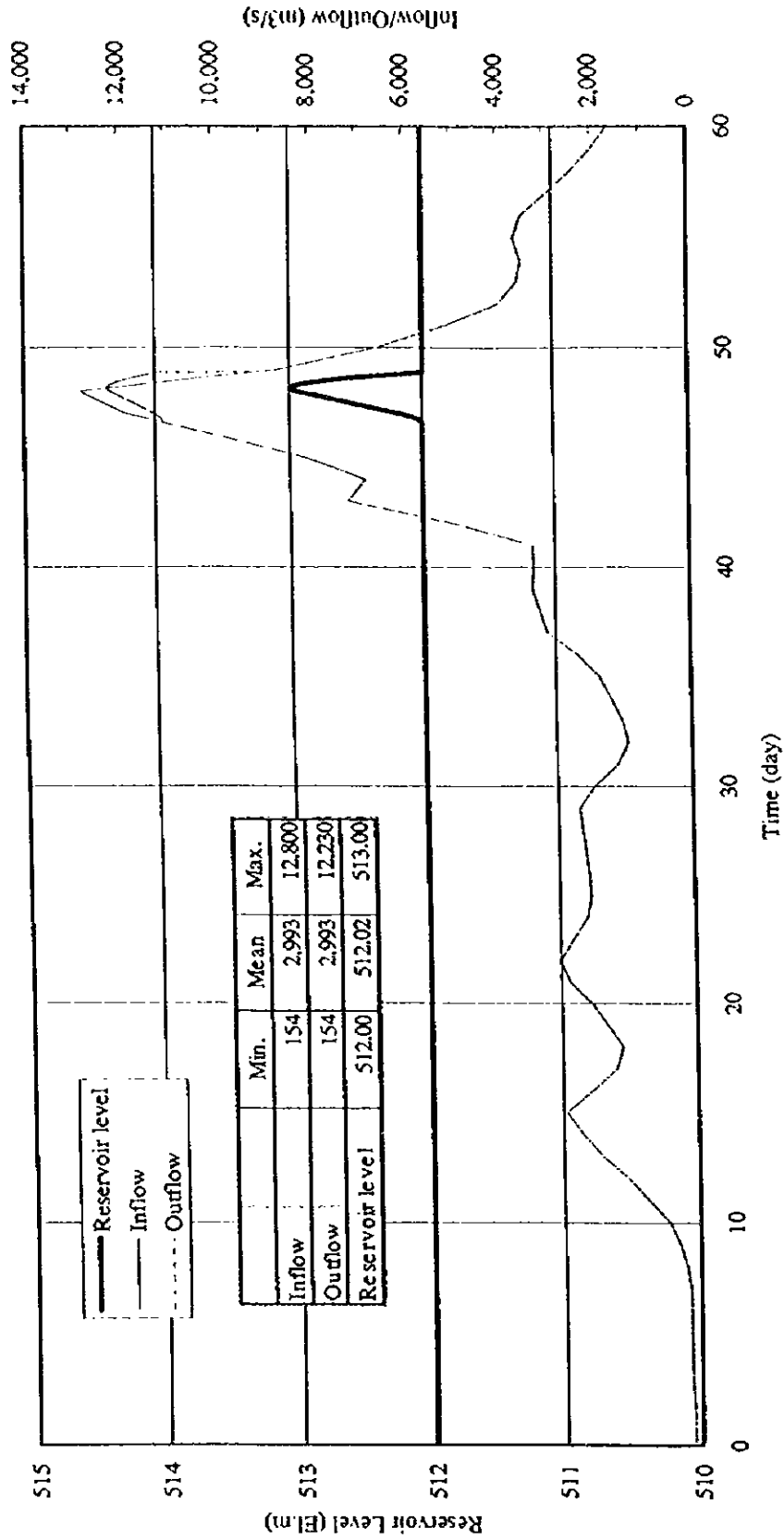

JAPAN INTERNATIONAL COOPERATION AGENCY  
 REPUBLIC OF KENYA  
 MUTONGA/GRAND FALLS HYDROPOWER PROJECT

Reservoir Routing of 10,000-year  
 Flood for the Low Grand Falls Dam

Fig. No.  
 7.1

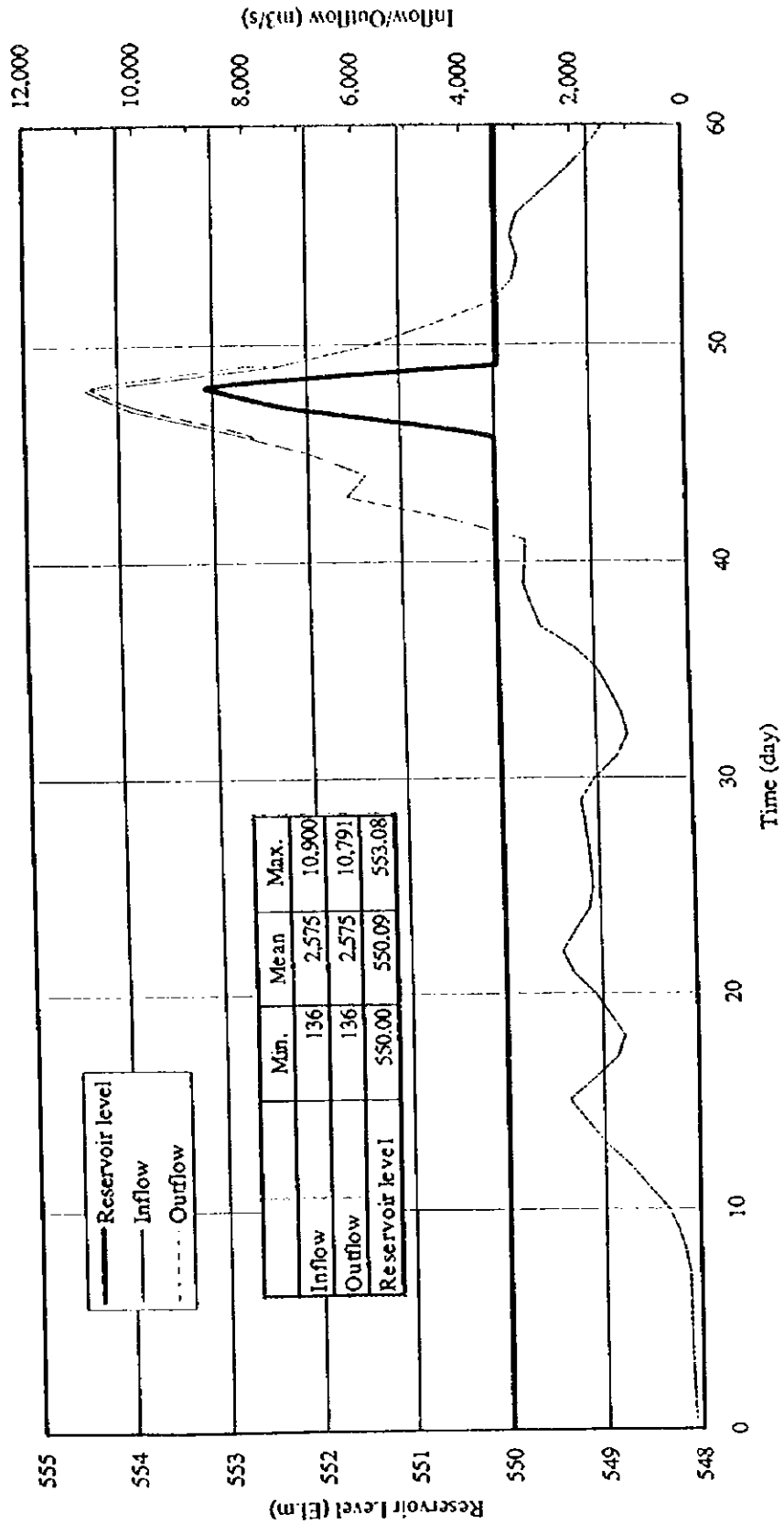

JAPAN INTERNATIONAL COOPERATION AGENCY  
 REPUBLIC OF KENYA  
 MUTONGA/GRAND FALLS HYDROPOWER PROJECT

Reservoir Routing of 10,000-year  
 Flood for the Mutonga Dam

Fig. No.

7.2

Figure 8.1 Construction Schedule

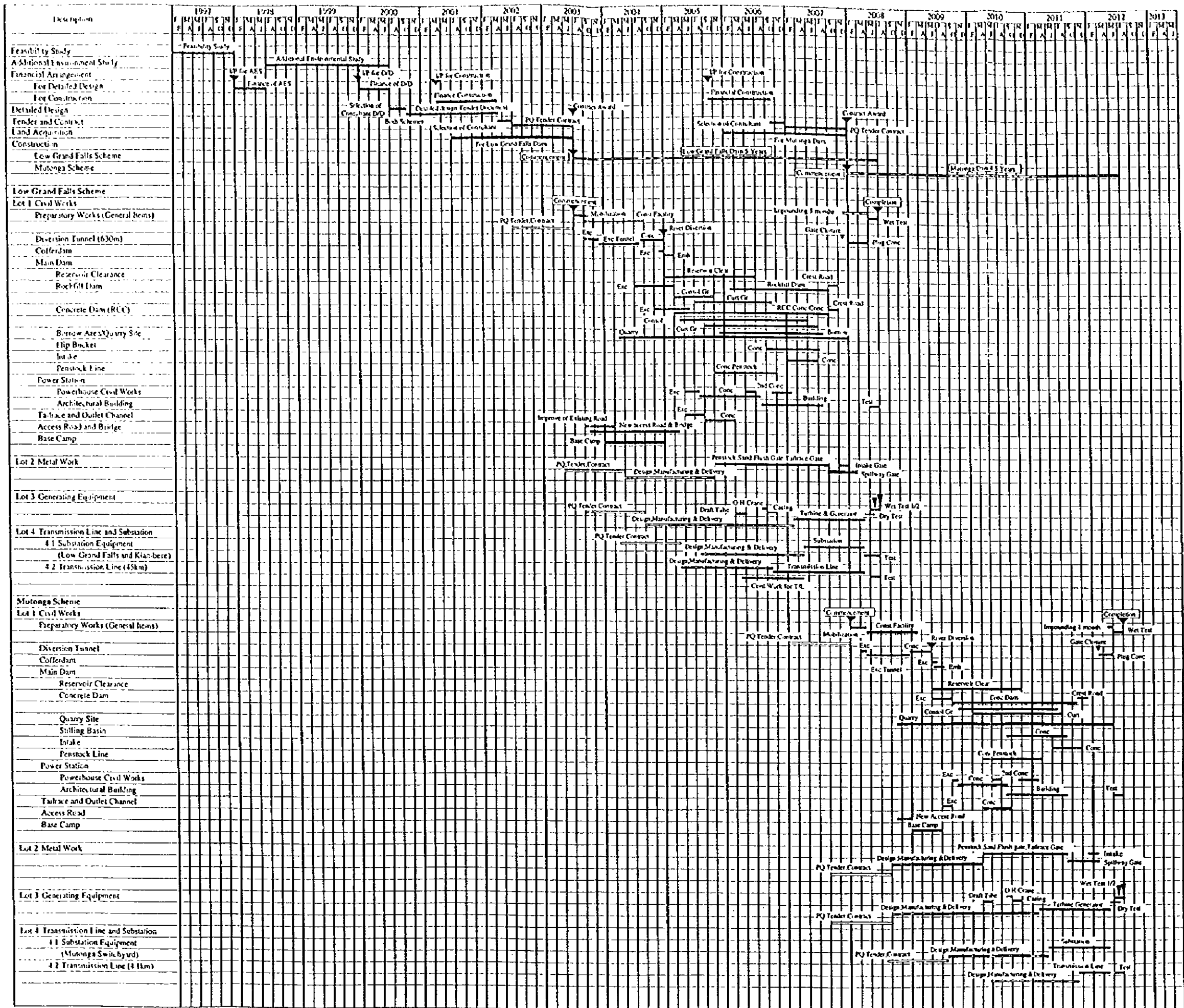



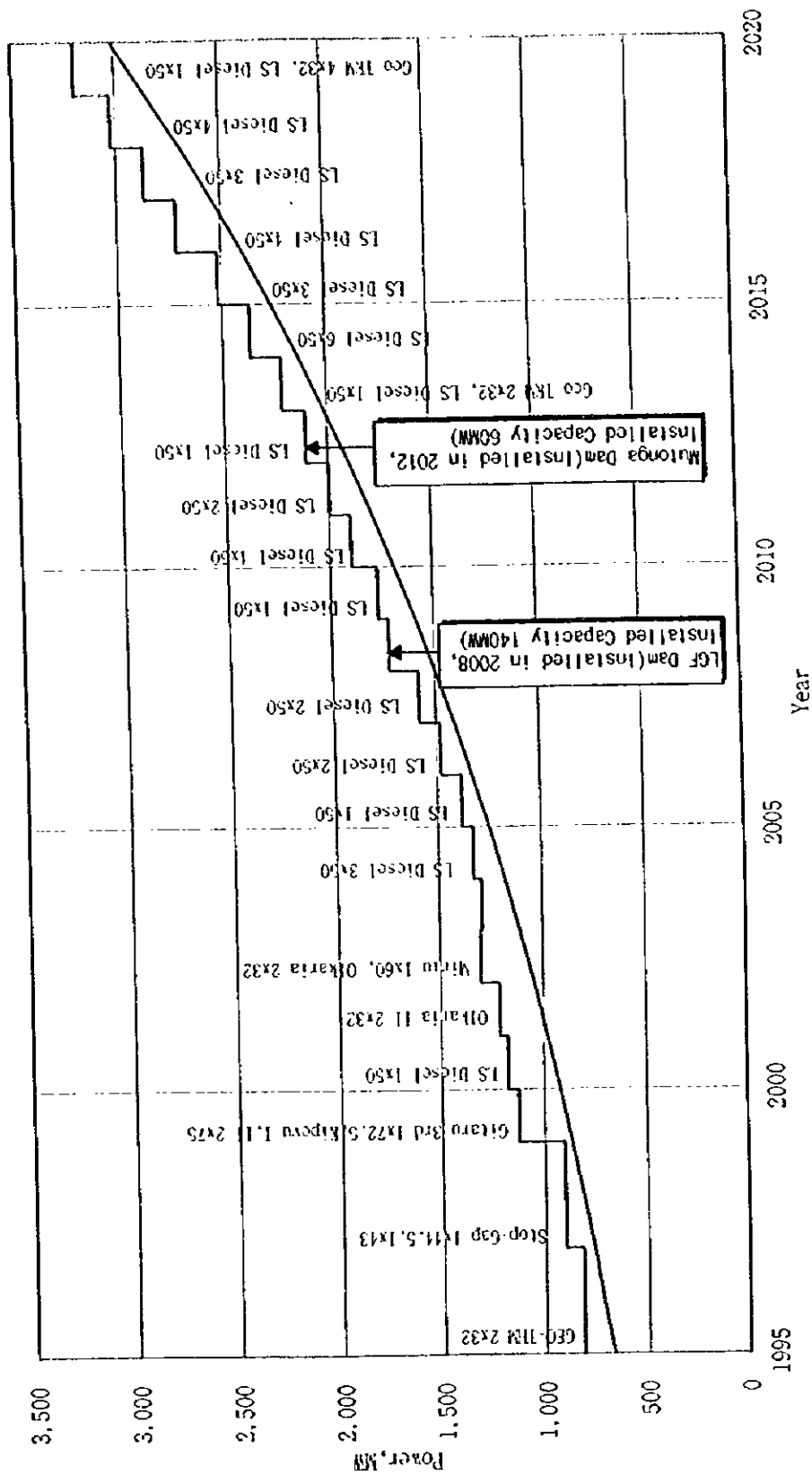

Fig. No. 9.2.1

Power Balance of Planting-up Study

JAPAN INTERNATIONAL COOPERATION AGENCY  
 REPUBLIC OF KENYA  
 MUTONGA/GRAND FALLS HYDROPOWER PROJECT

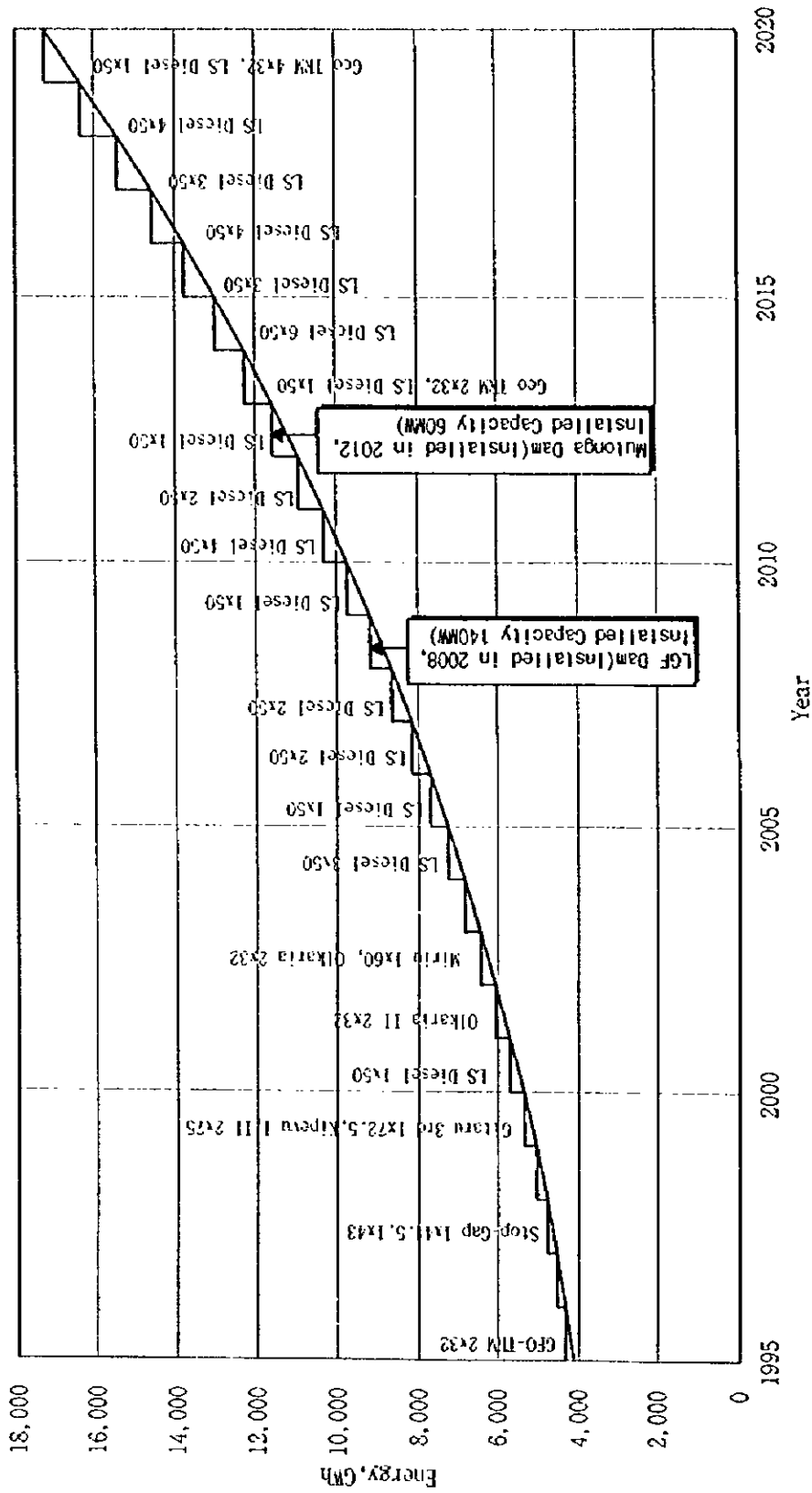

Fig. No. 9.2.2

Energy Balance of Planting-up Study

JAPAN INTERNATIONAL COOPERATION AGENCY  
 REPUBLIC OF KENYA  
 MUTONGA/GRAND FALLS HYDROPOWER PROJECT

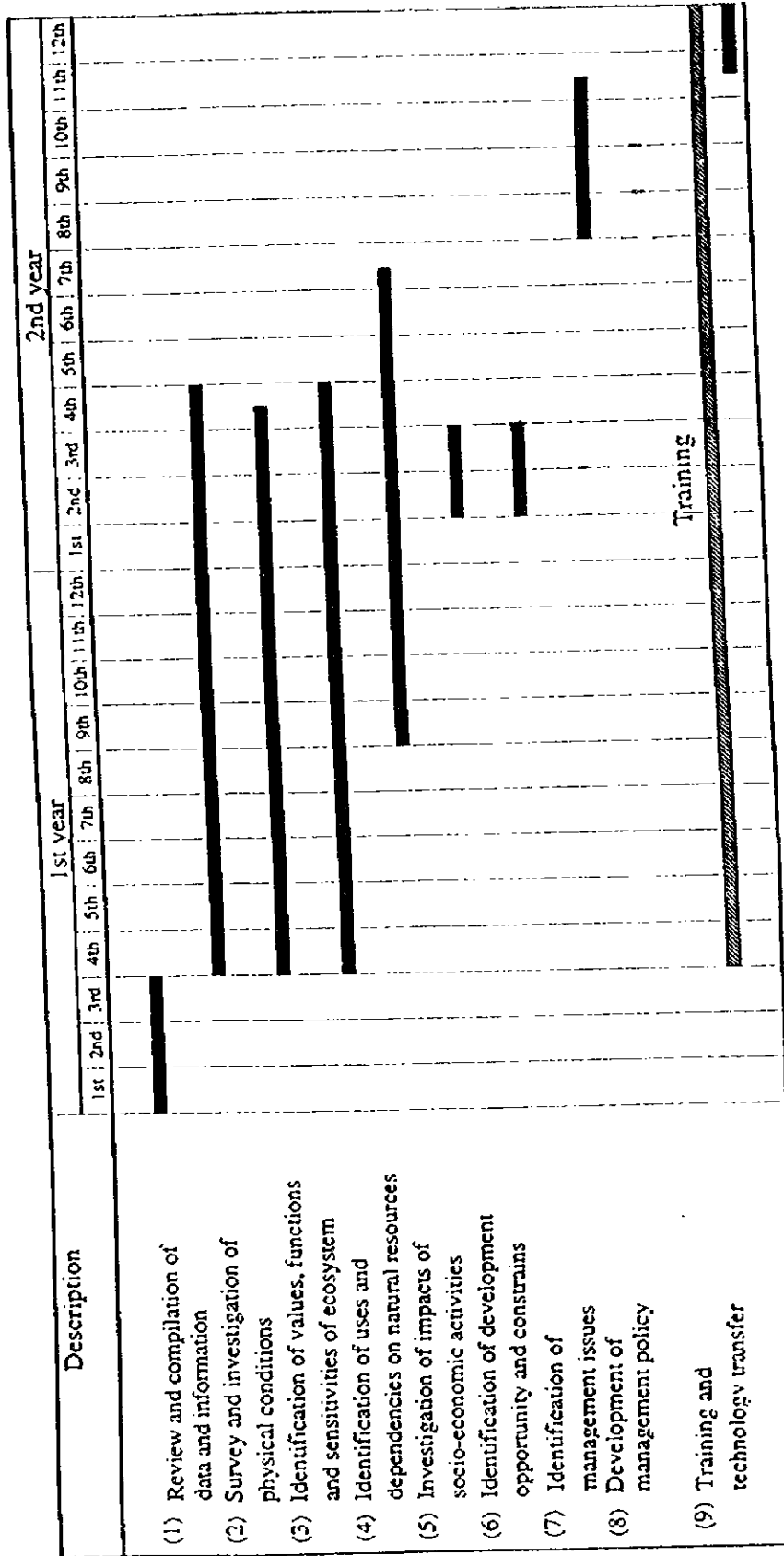

Fig. No.

Schedule of Additional Environmental Assessment Study

10.1

JAPAN INTERNATIONAL COOPERATION AGENCY  
 REPUBLIC OF KENYA  
 MUTONGA/GRAND FALLS HYDROPOWER PROJECT

*Drawings*







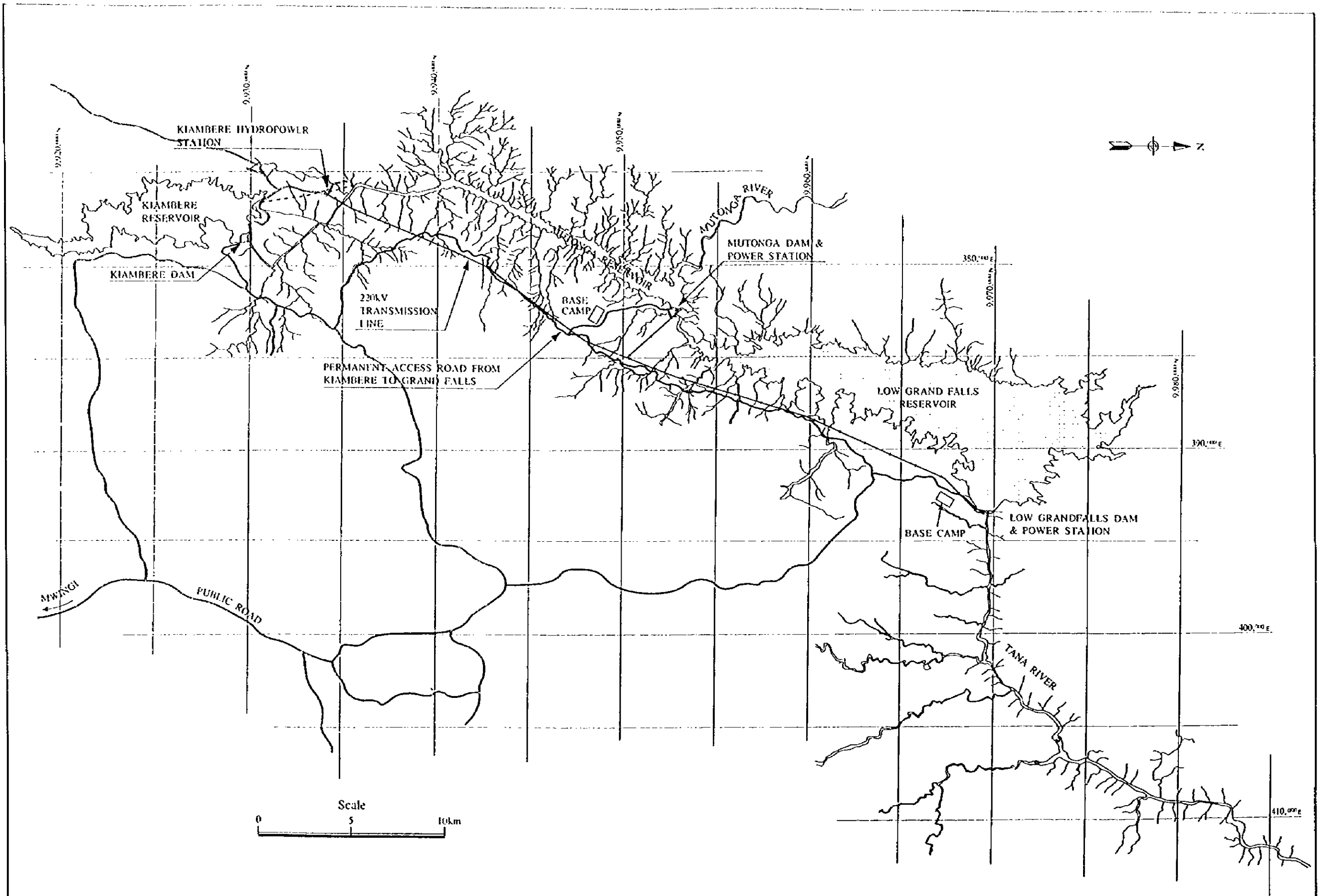

JAPAN INTERNATIONAL COOPERATION AGENCY  
 REPUBLIC OF KENYA  
 MUTONGA/GRAND FALLS HYDROPOWER PROJECT

General Layout of Project

Fig. No.  
 DWG-02

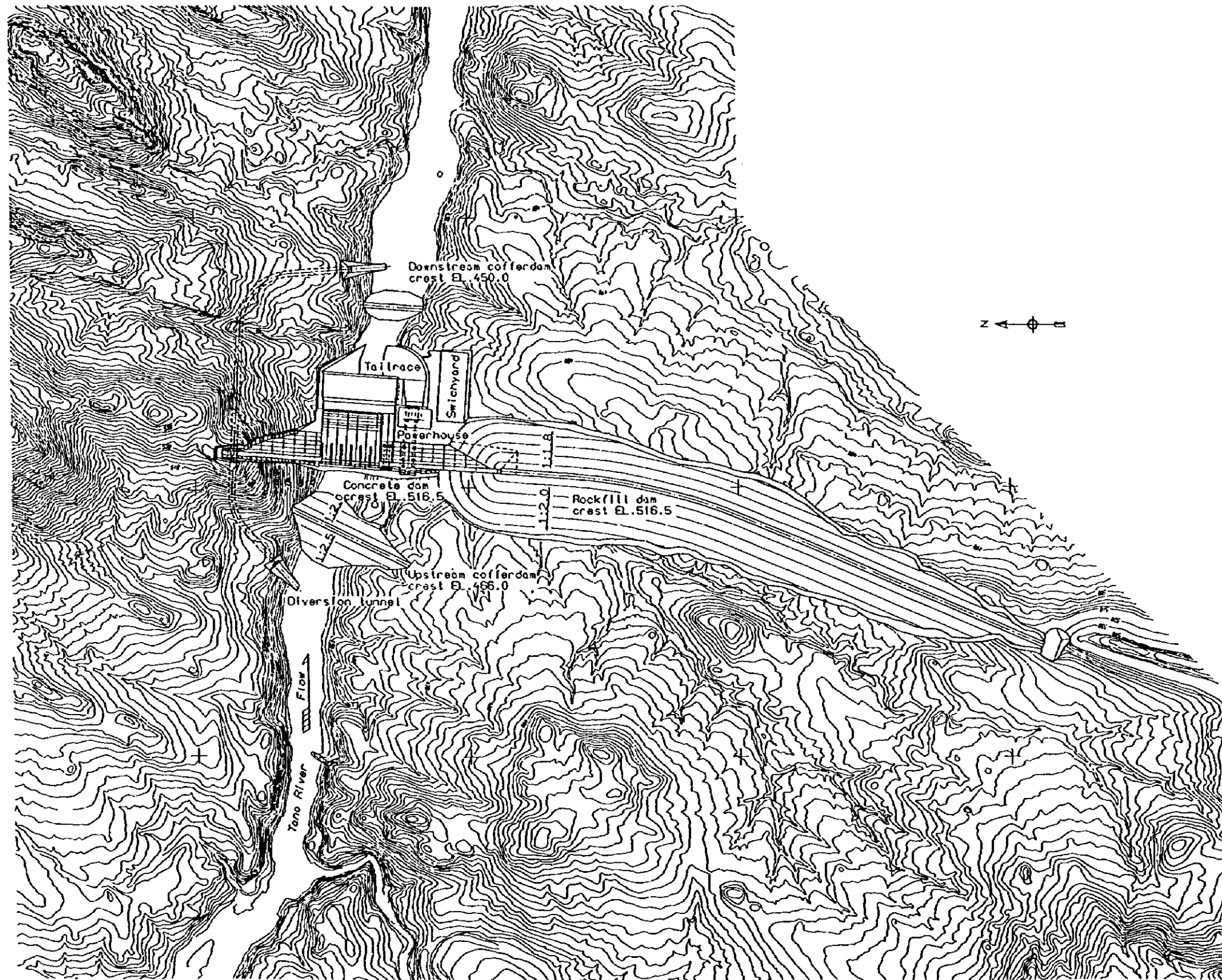

JAPAN INTERNATIONAL COOPERATION AGENCY	LOW GRAND FALLS DAM	Fig. No.
REPUBLIC OF KENYA	GENERAL PLAN	DWG-03
MUTONGA/GRAND FALLS HYDROPOWER PROJECT		

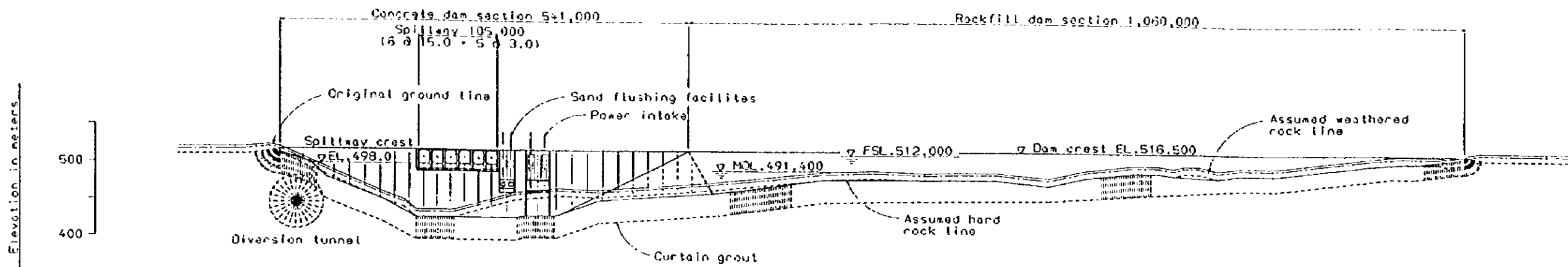

UPSTREAM ELEVATION SCALE A

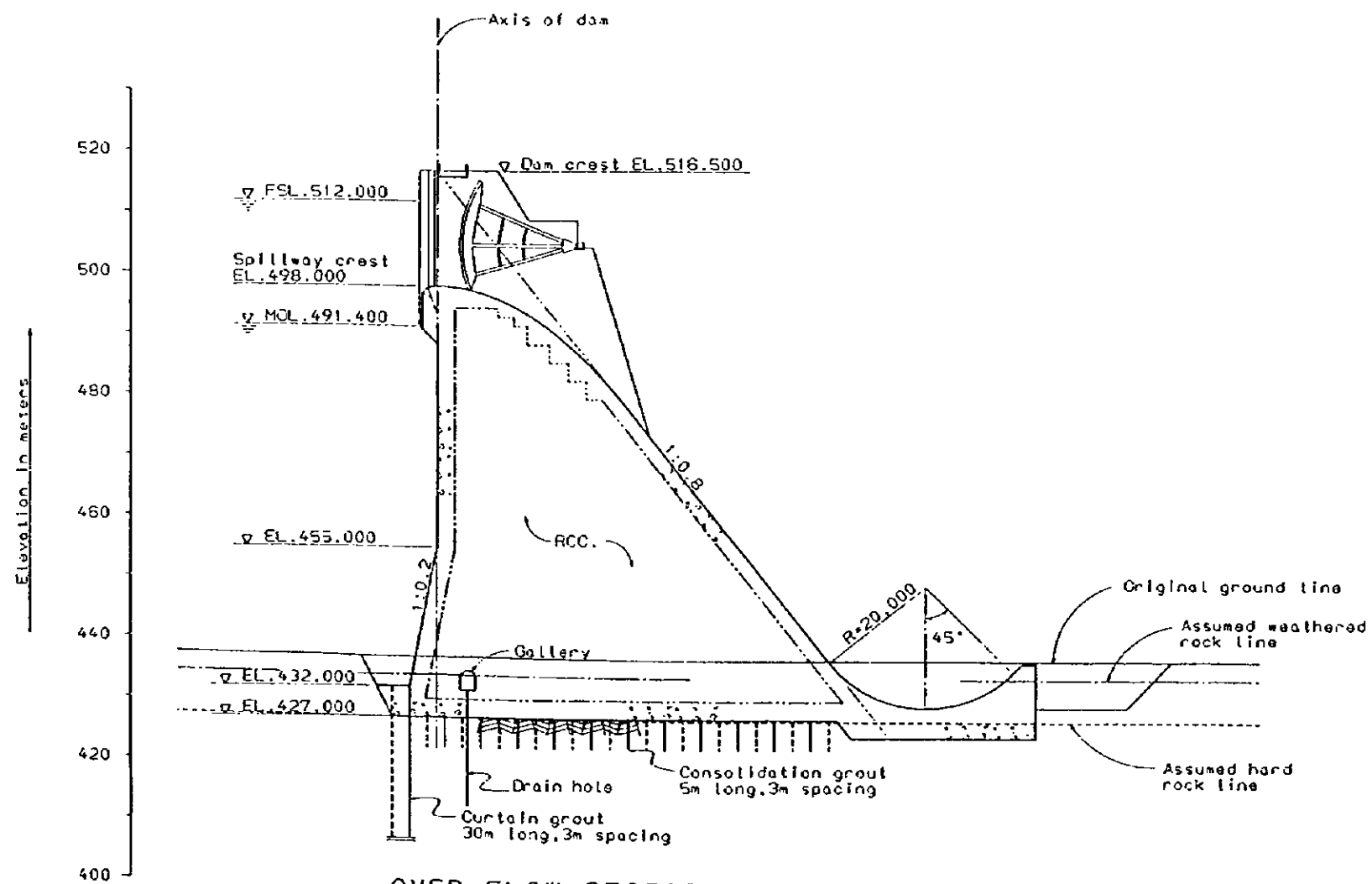

OVER FLOW SECTION SCALE B

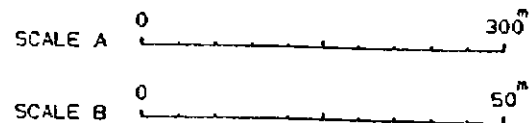

JAPAN INTERNATIONAL COOPERATION AGENCY	LOW GRAND FALLS ELEVATION AND TYPICAL SECTION	Fig. No.
REPUBLIC OF KENYA		
MUTONGA/GRAND FALLS HYDROPOWER PROJECT		D#G-04

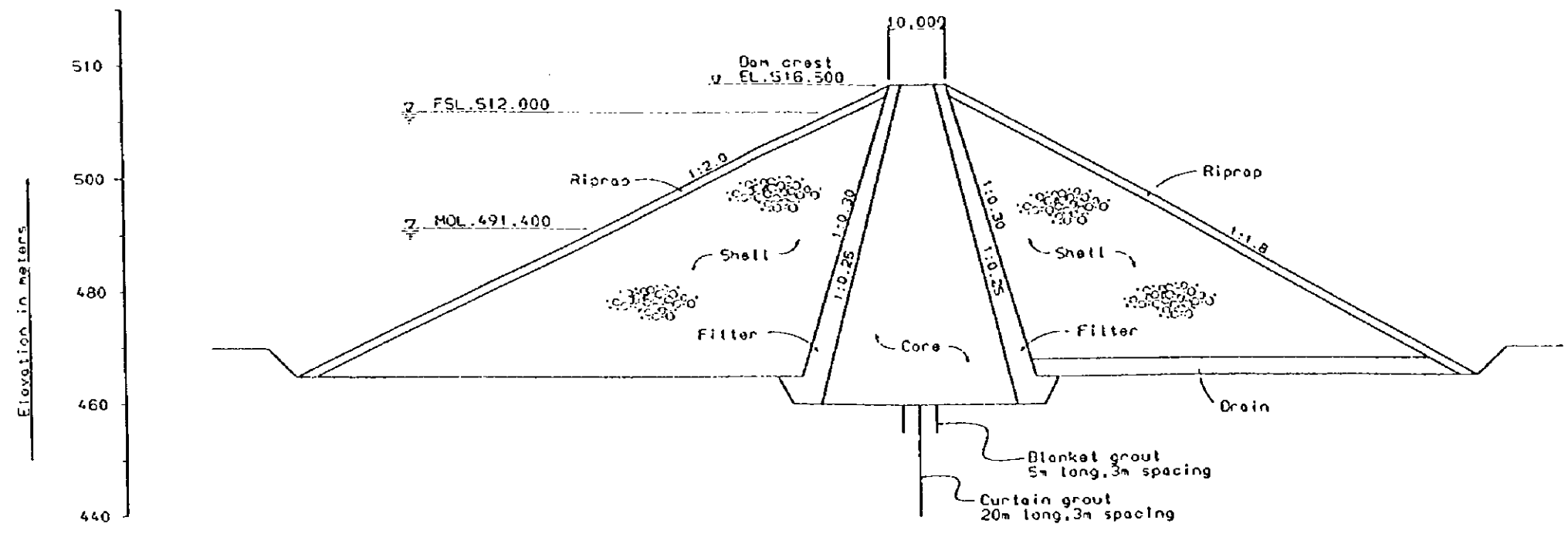

ROCKFILL DAM

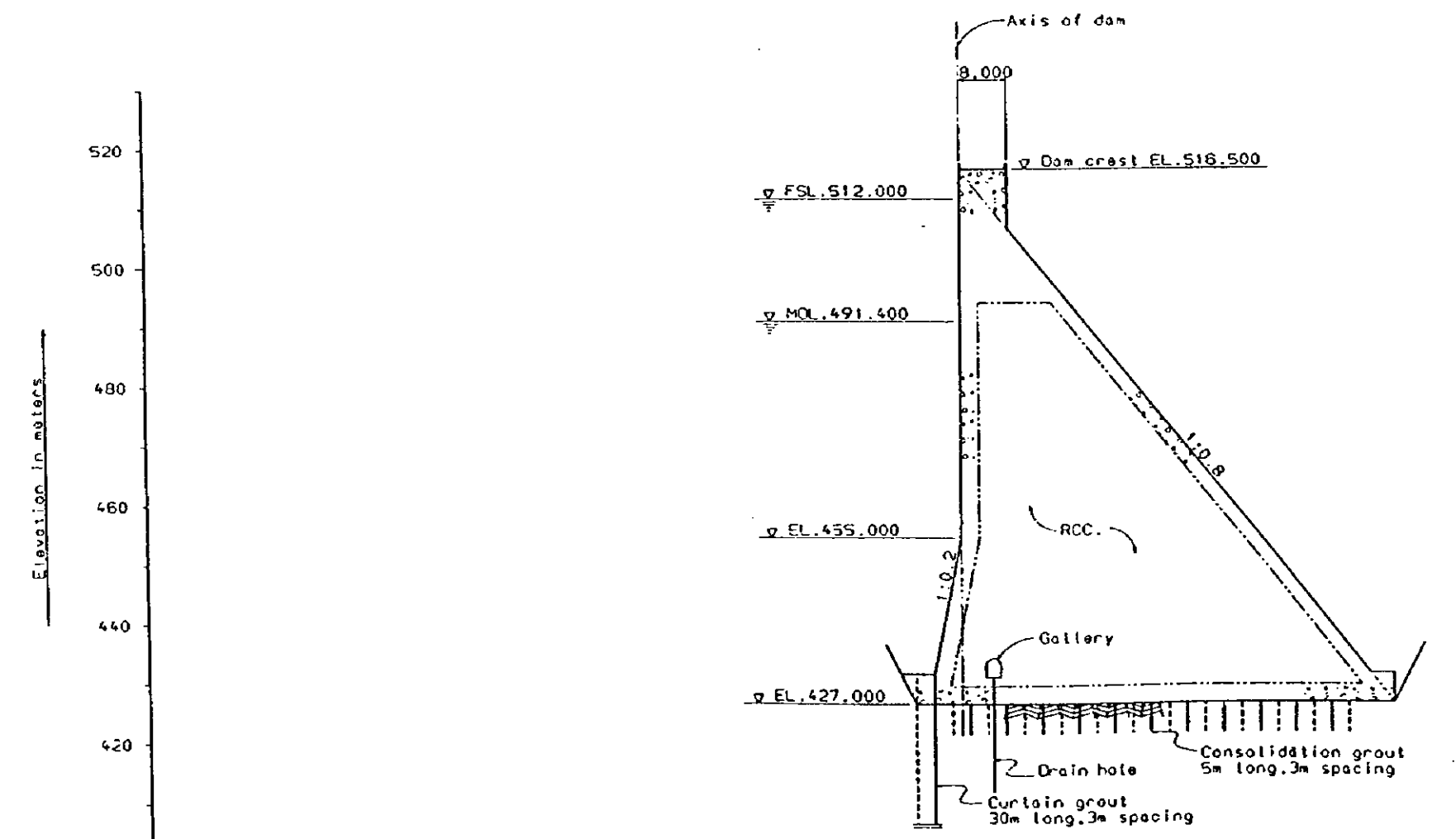

NON-OVER FLOW SECTION

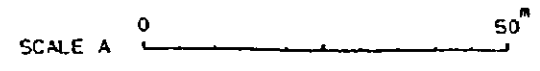

JAPAN INTERNATIONAL COOPERATION AGENCY	LOW GRAND FALLS	Fig. No.
REPUBLIC OF KENYA	CONCRETE DAM AND	
MUTONGA/GRAND FALLS HYDROPOWER PROJECT	ROCKFILL DAM SECTIONS	DWG-05

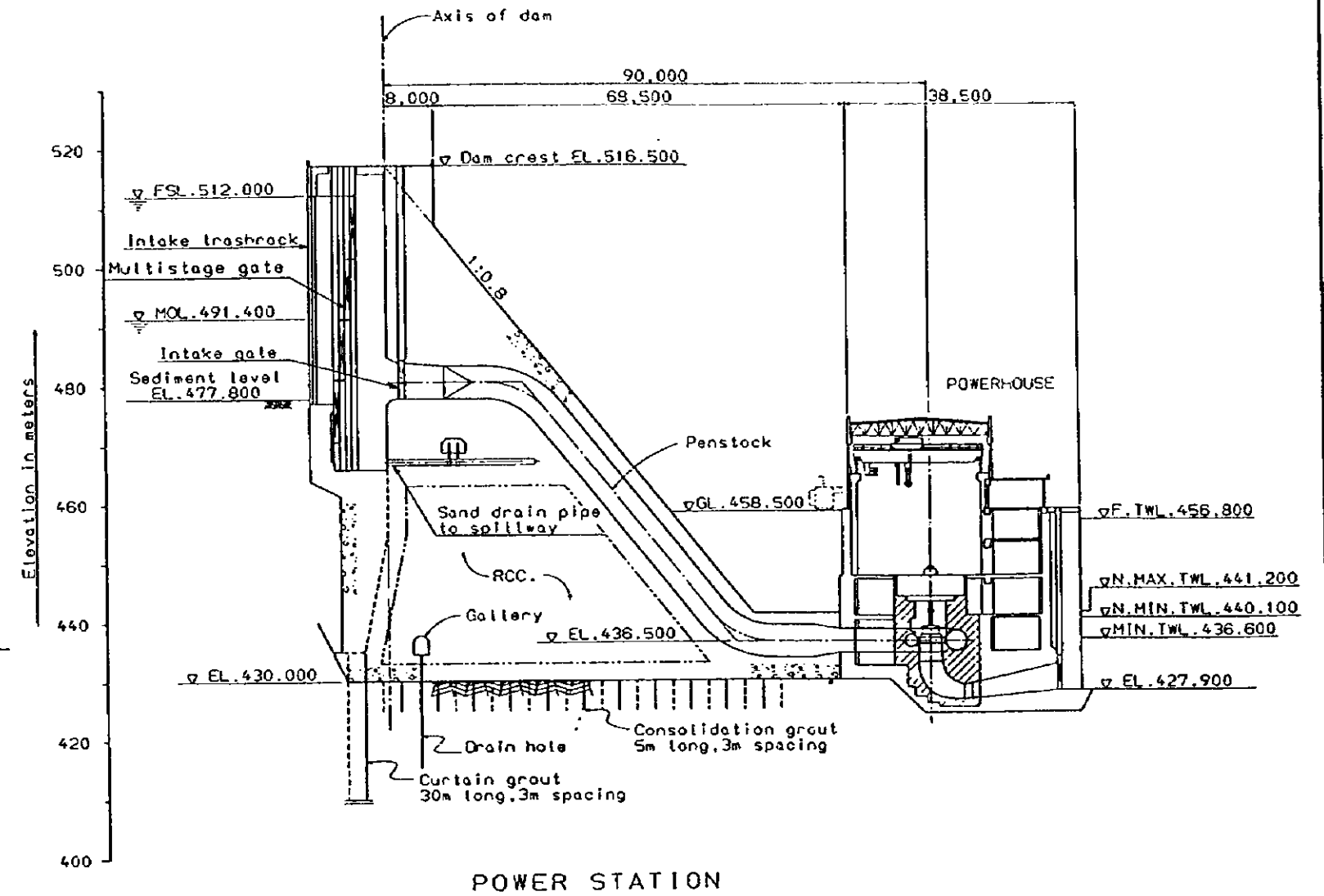
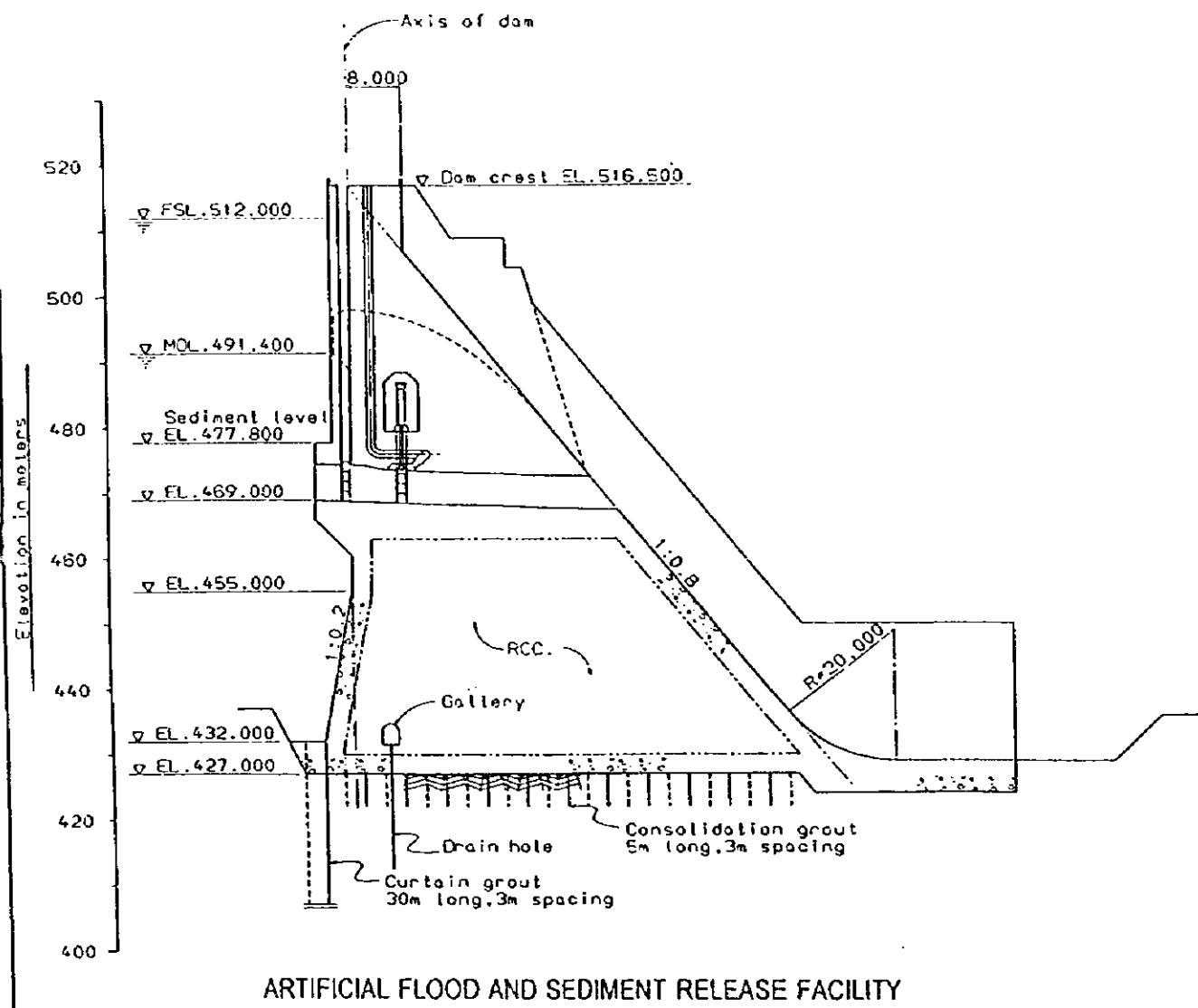

SCALE A 0 50<sup>m</sup>

JAPAN INTERNATIONAL COOPERATION AGENCY	LOW GRAND FALLS	Fig. No.
REPUBLIC OF KENYA	ARTIFICIAL FLOOD AND SEDIMENT	
MUTONGA/GRAND FALLS HYDROPOWER PROJECT	RELEASE FACILITY AND POWER STATION	DWG-06

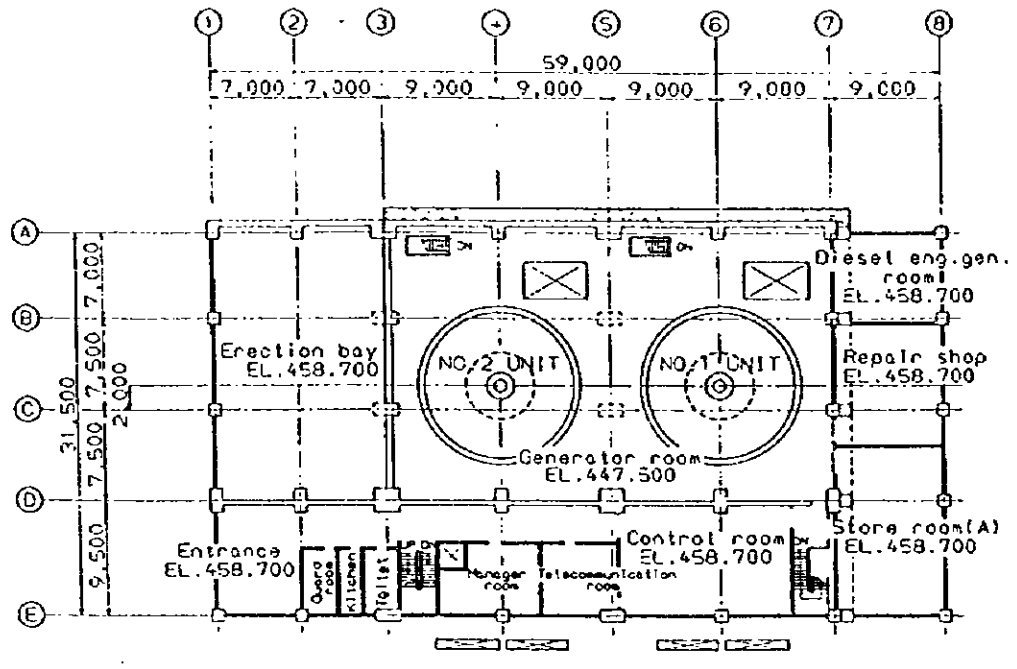

FLOOR PLAN AT EL. 447.500

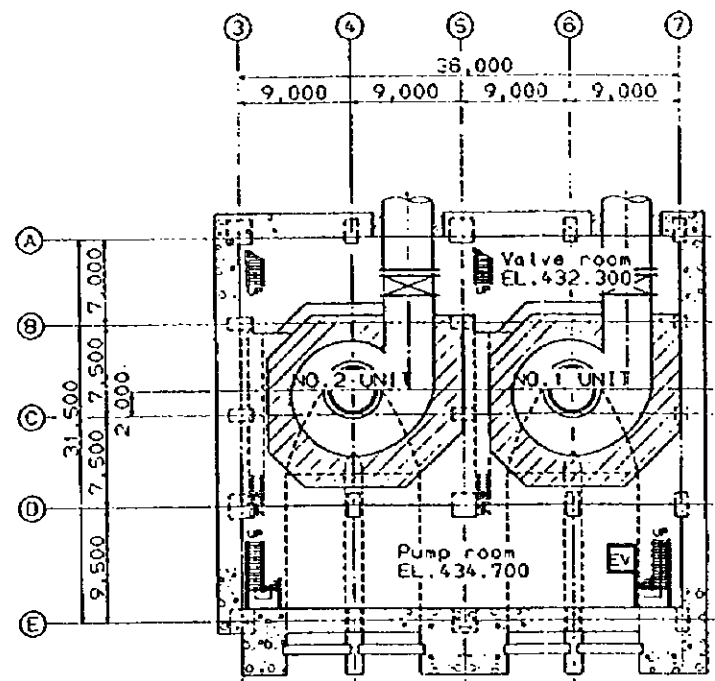

FLOOR PLAN AT EL. 434.700

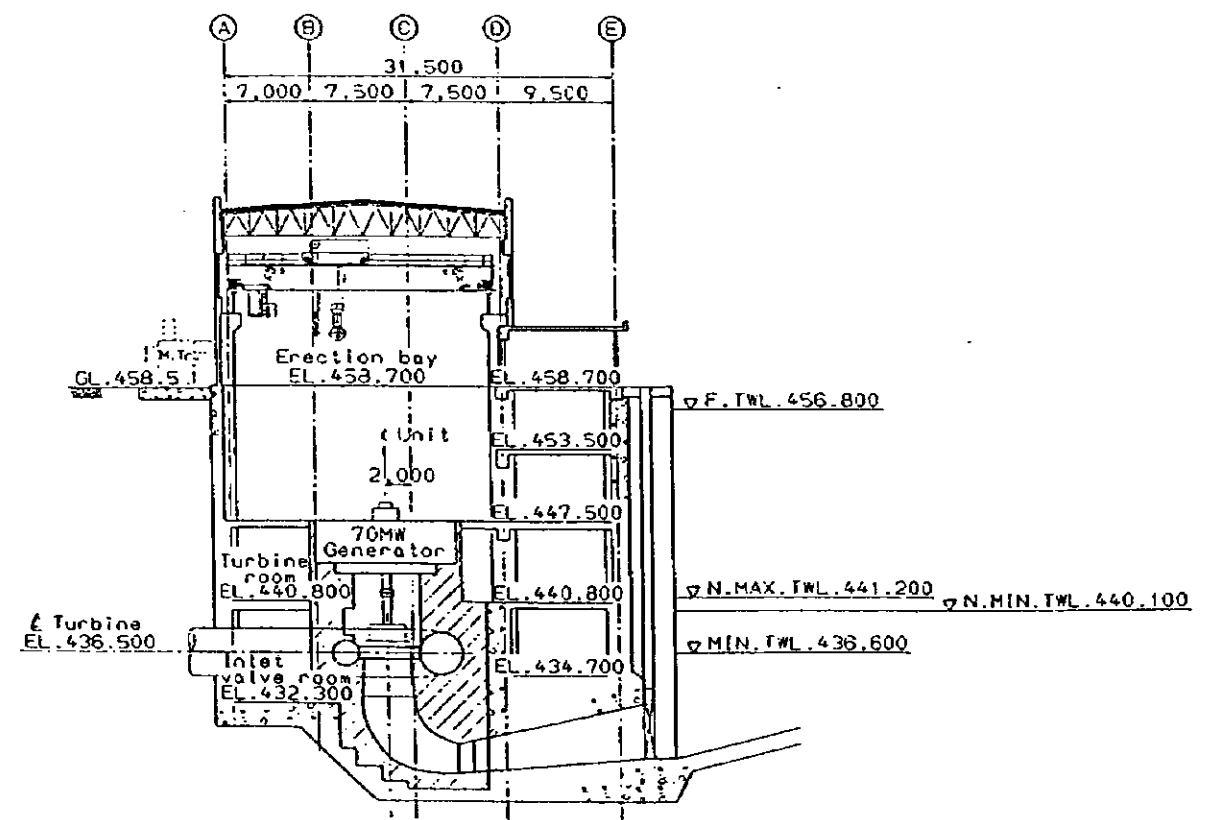

TRANSVERSE SECTION

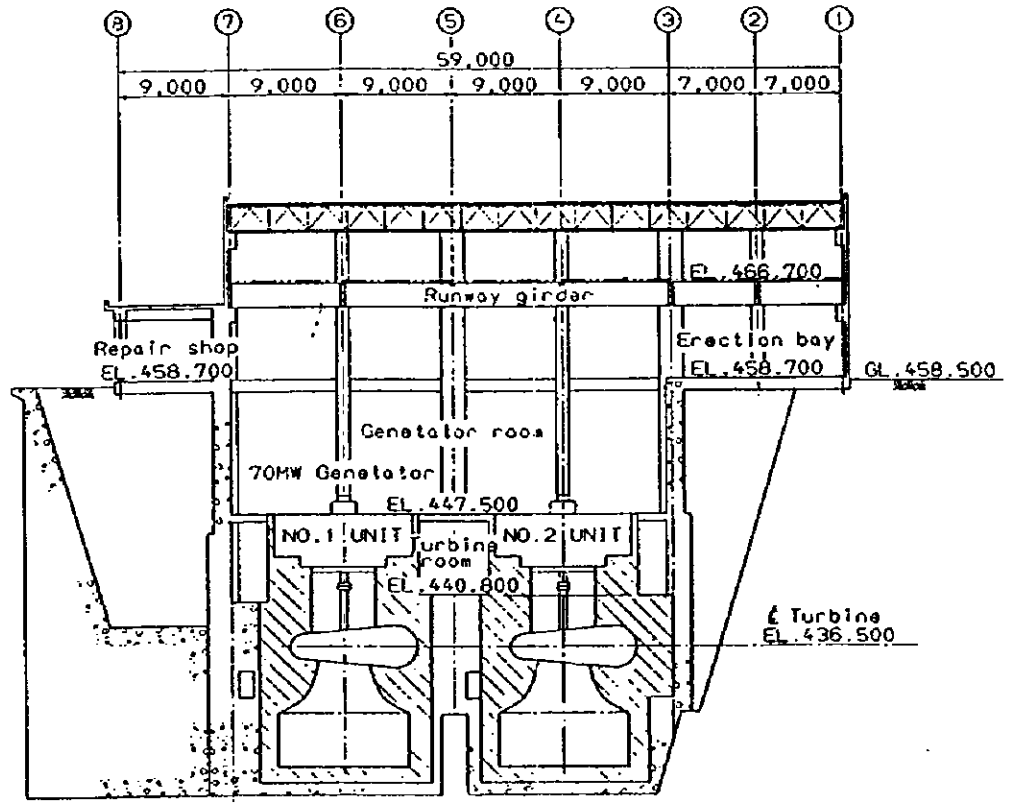

LONGITUDINAL SECTION

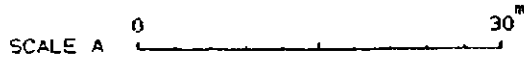

JAPAN INTERNATIONAL COOPERATION AGENCY	LOW GRAND FALLS	Fig. No.
REPUBLIC OF KENYA	POWERHOUSE	DWG-07
MUTONGA/GRAND FALLS HYDROPOWER PROJECT		



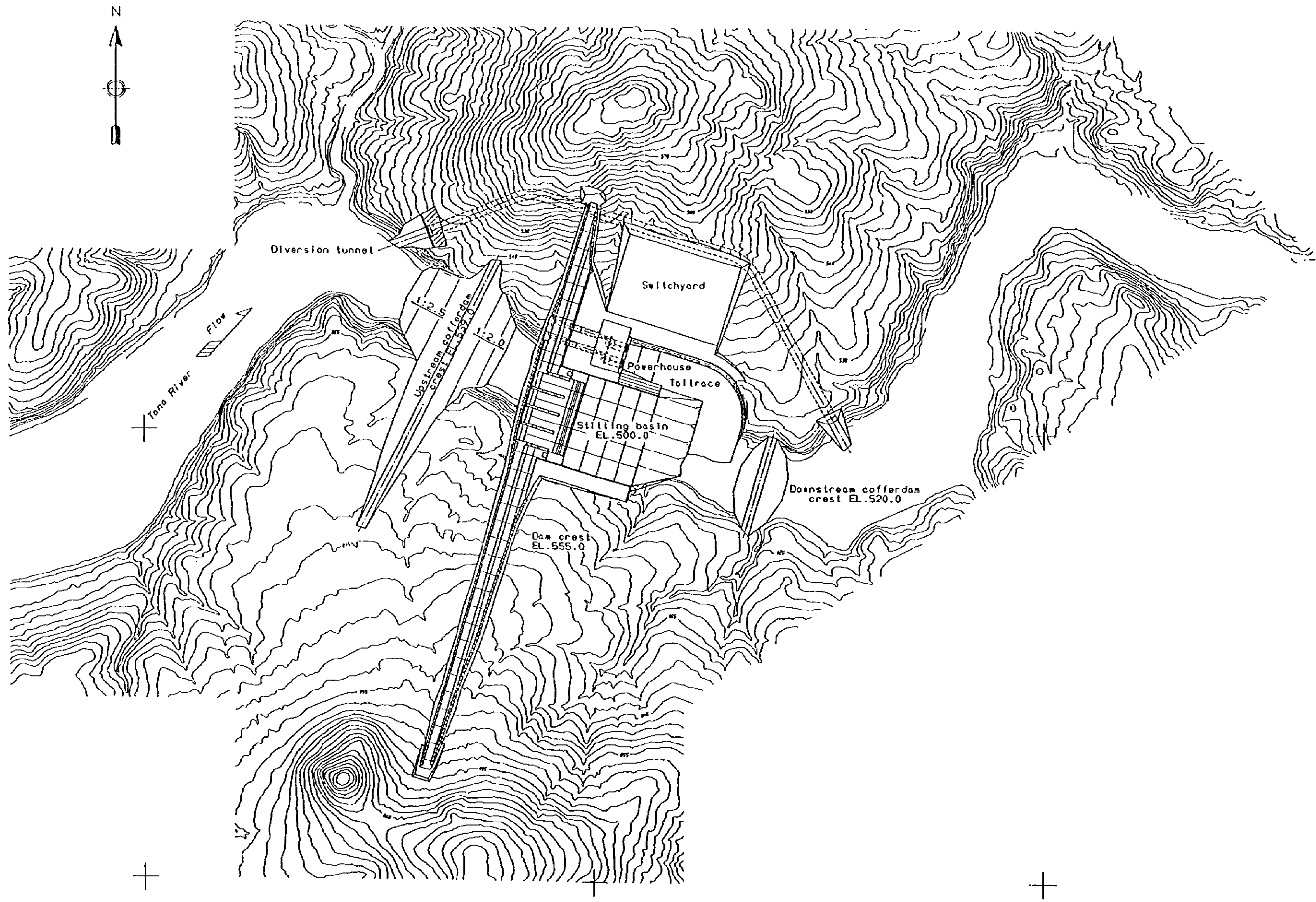

SCALE A 0 200<sup>m</sup>

JAPAN INTERNATIONAL COOPERATION AGENCY	MUTONGA DAM	Fig. No.
REPUBLIC OF KENYA	GENERAL PLAN	DWG-08
MUTONGA/GRAND FALLS HYDROPOWER PROJECT		

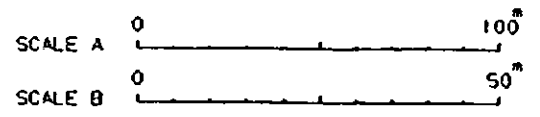
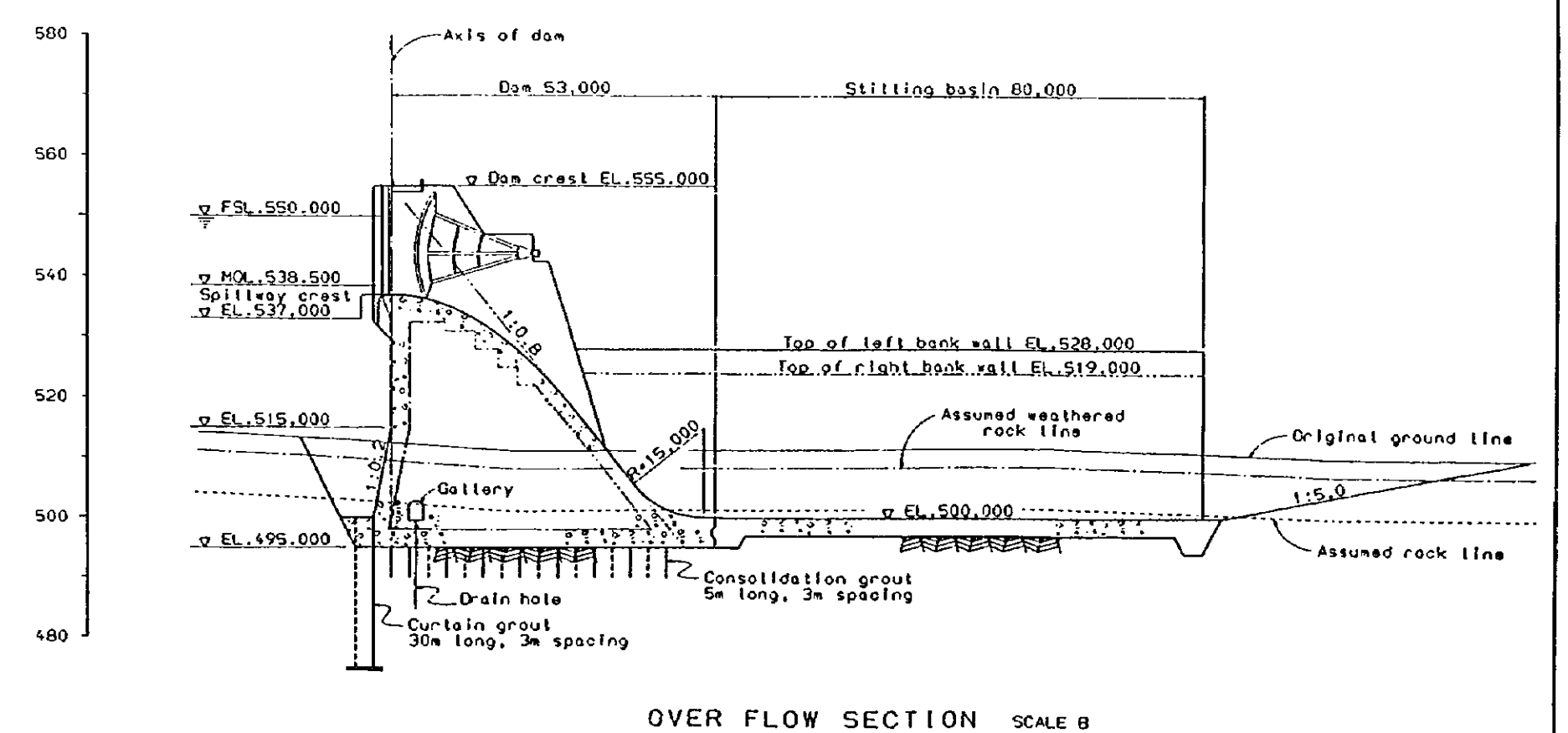
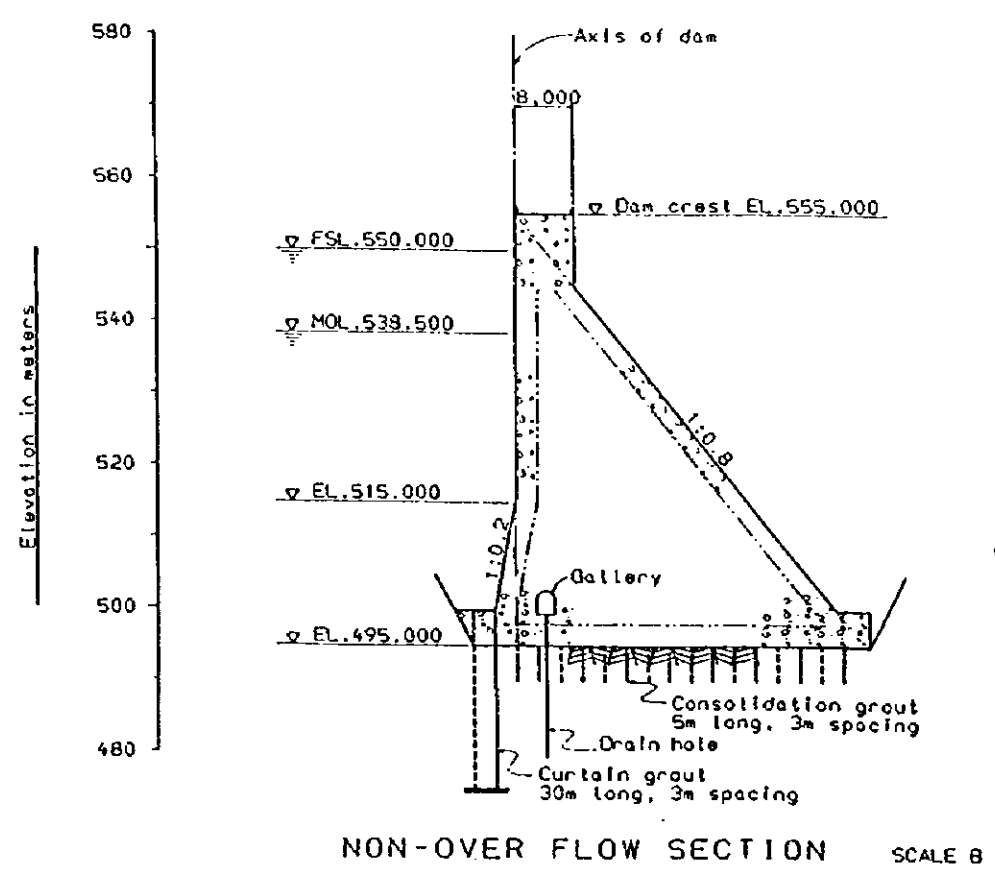
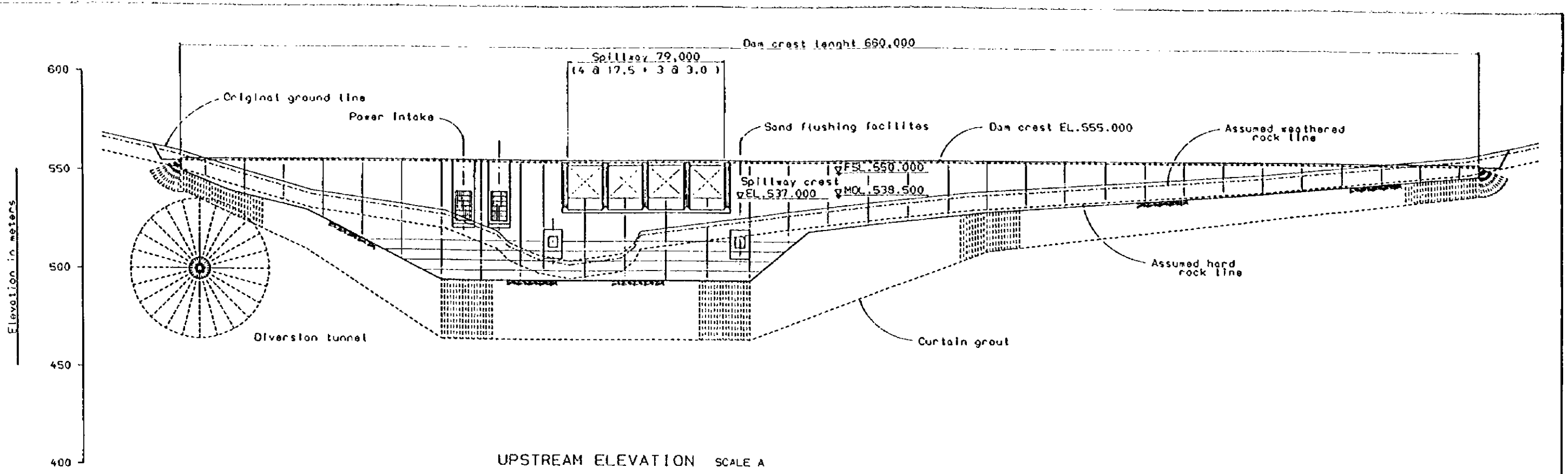

JAPAN INTERNATIONAL COOPERATION AGENCY	MUTONGA DAM ELEVATION AND TYPICAL SECTIONS	Fig. No. DWG-09
REPUBLIC OF KENYA		
MUTONGA/GRAND FALLS HYDROPOWER PROJECT		

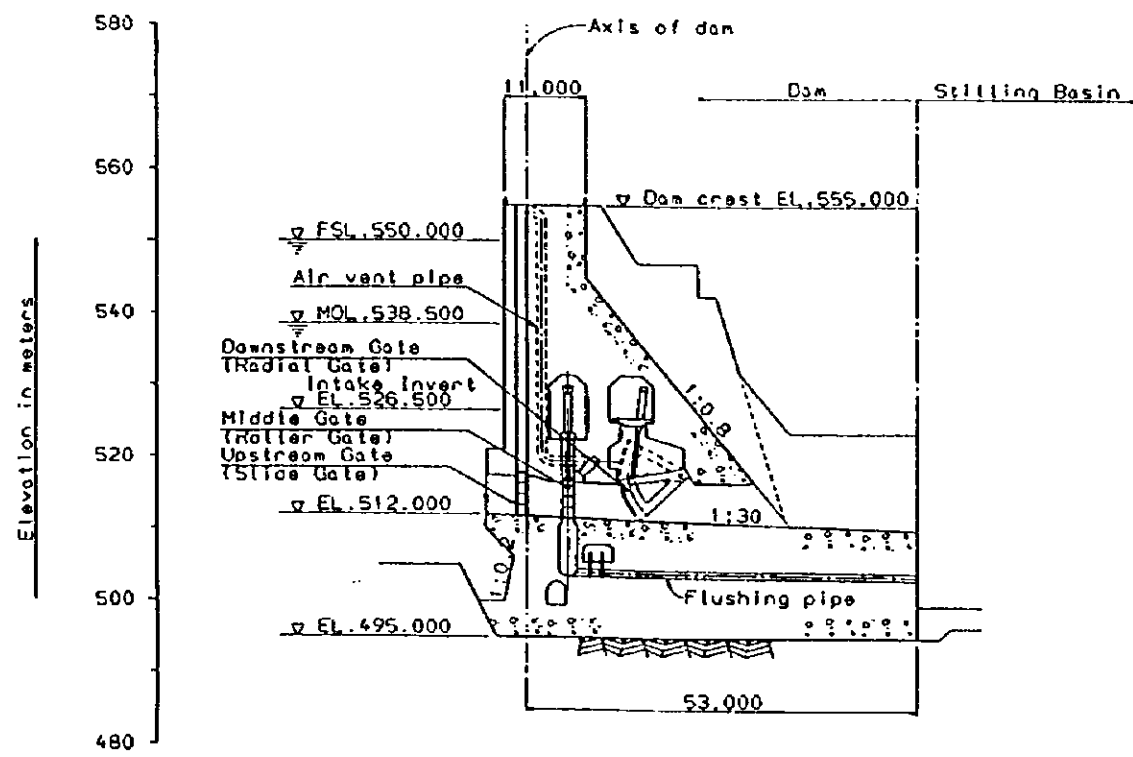

ARTIFICIAL FLOOD AND SEDIMENT RELEASE FACILITY

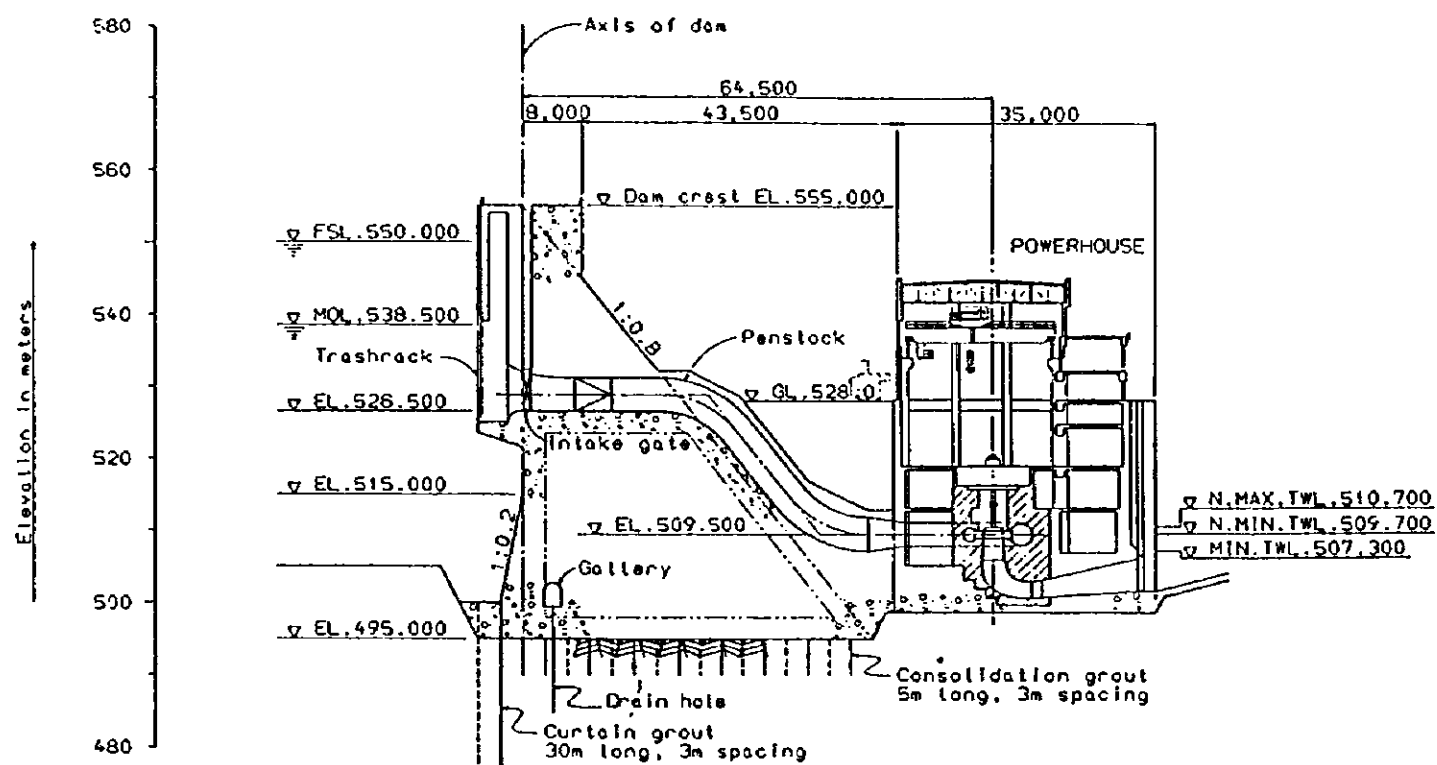

POWER STATION



JAPAN INTERNATIONAL COOPERATION AGENCY	MUTONGA DAM	Fig. No.
REPUBLIC OF KENYA	ARTIFICIAL FLOOD AND SEDIMENT RELEASE FACILITY AND POWER STATION	DWG-10
MUTONGA/GRAND FALLS HYDROPOWER PROJECT		

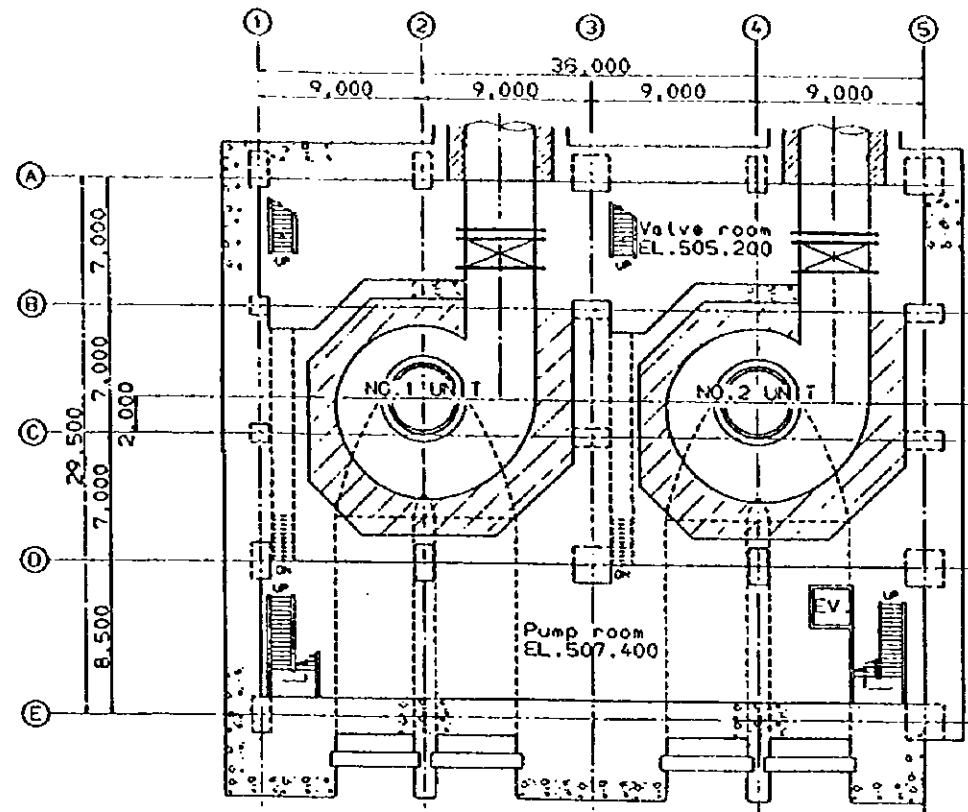

FLOOR PLAN AT EL. 507.400

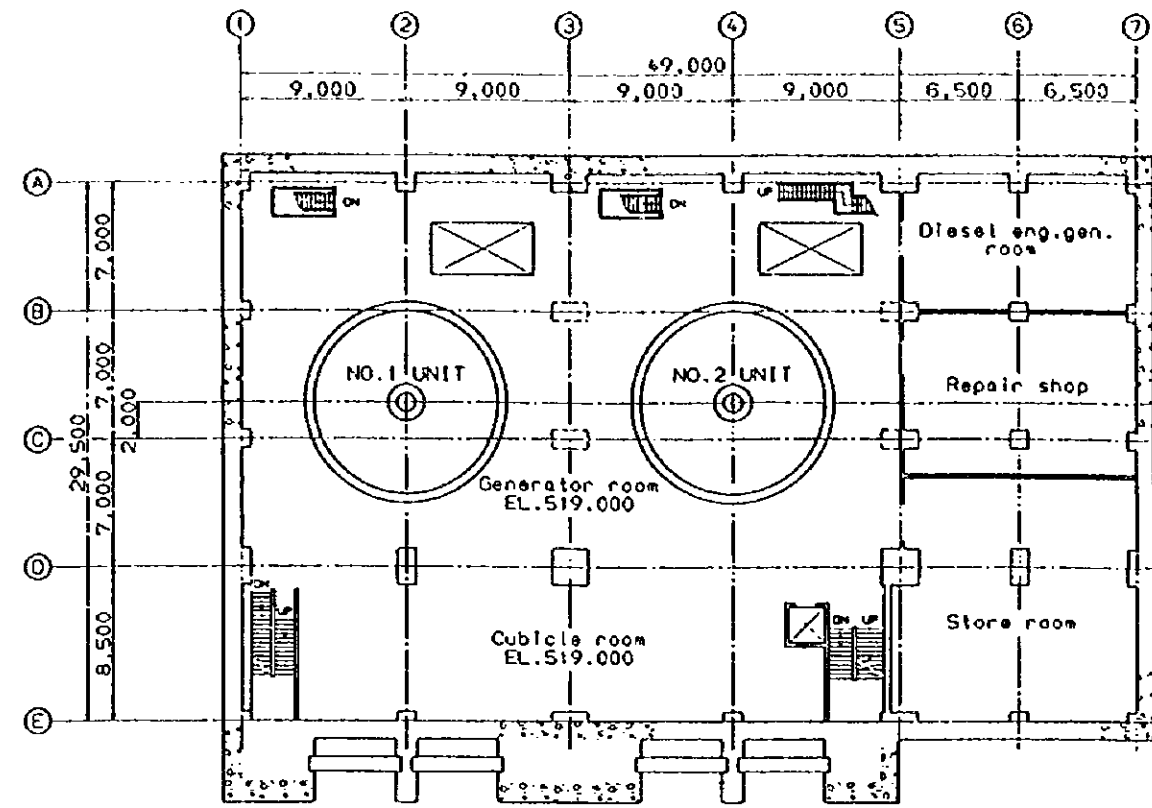

FLOOR PLAN AT EL. 519.000

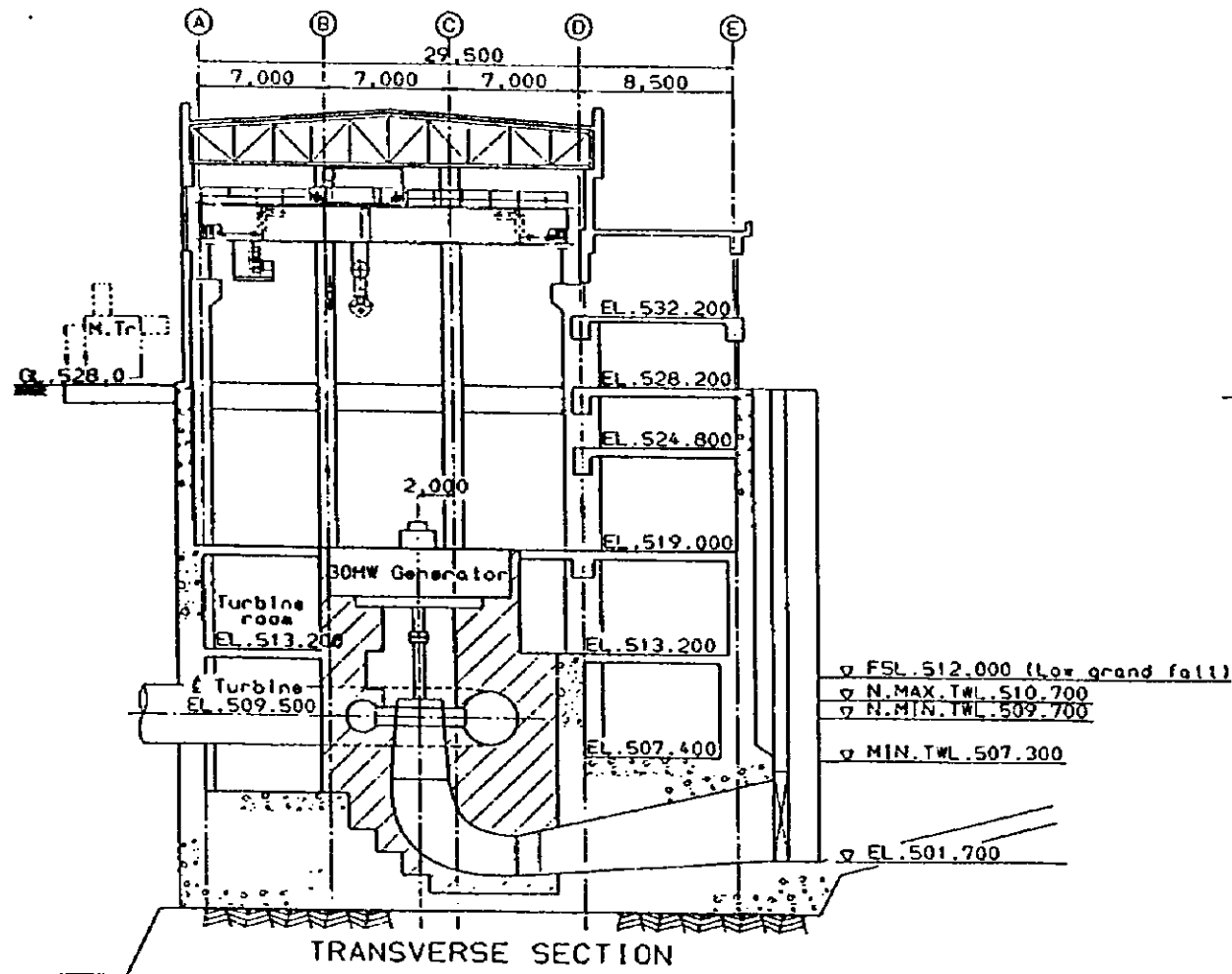

TRANSVERSE SECTION

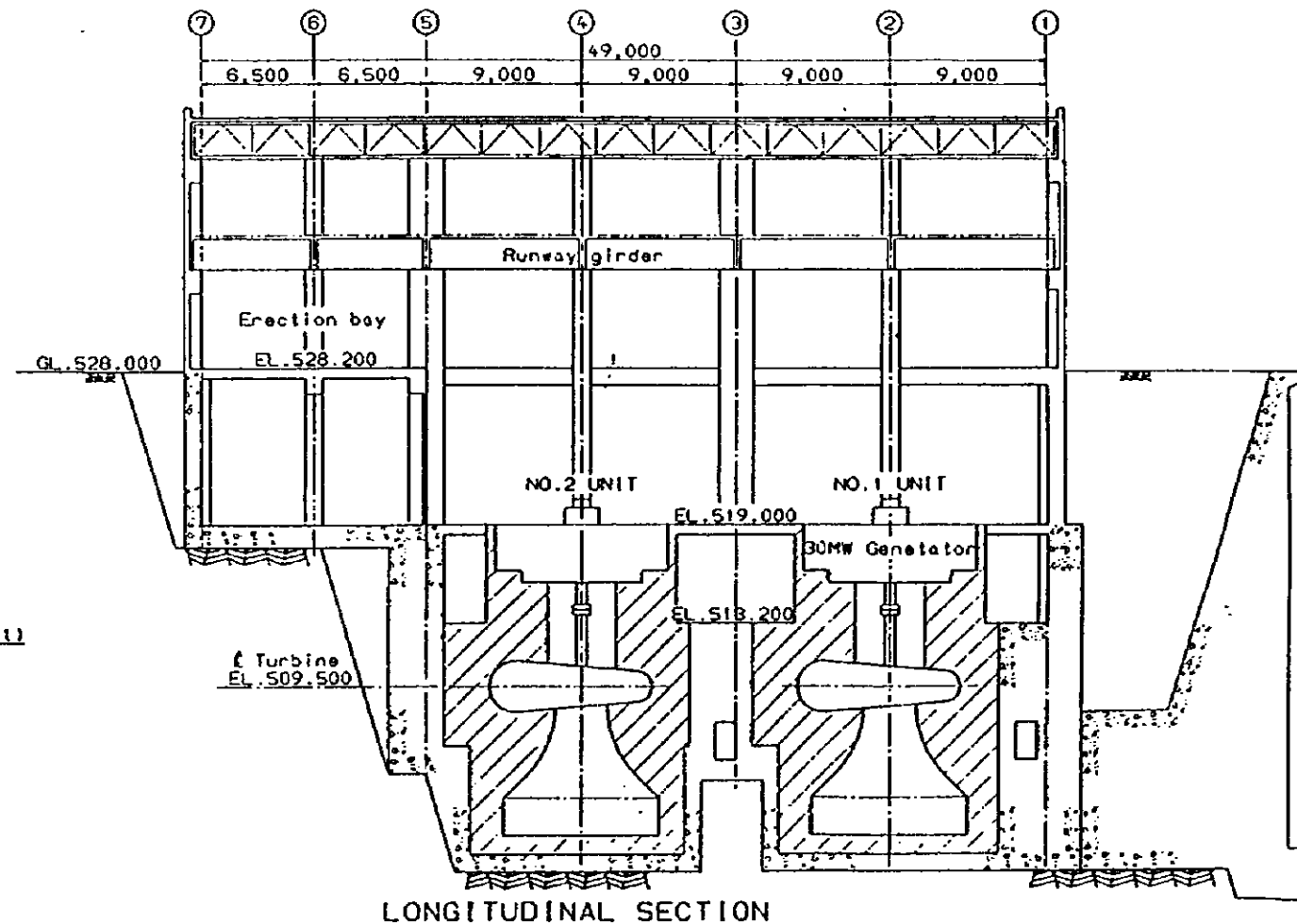

LONGITUDINAL SECTION

SCALE A 0 20m

JAPAN INTERNATIONAL COOPERATION AGENCY	MUTONGA DAM	Fig. No. DWG-11
REPUBLIC OF KENYA	POWERHOUSE	
MUTONGA/GRAND FALLS HYDROPOWER PROJECT		

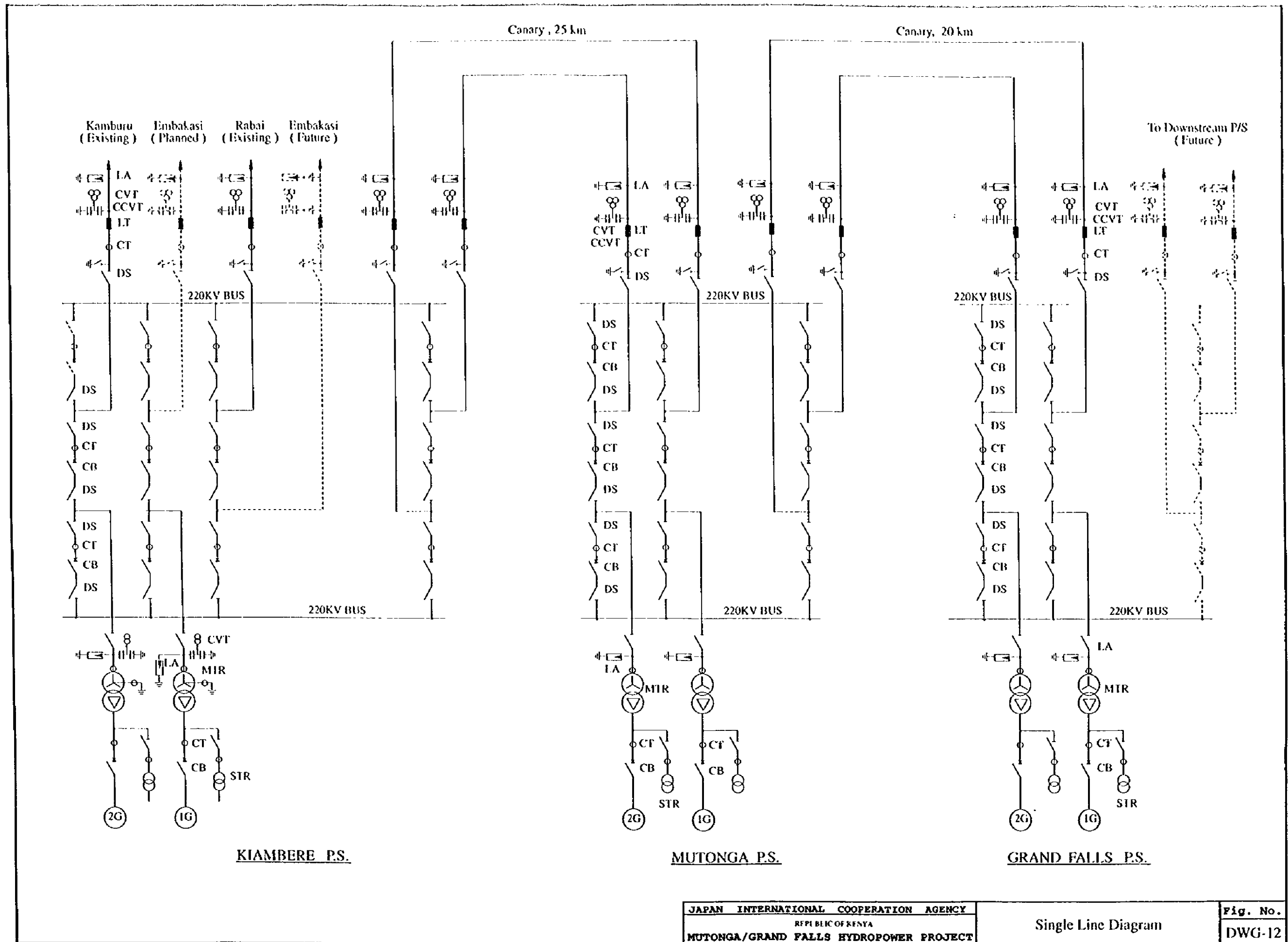

JAPAN INTERNATIONAL COOPERATION AGENCY  
 REPUBLIC OF KENYA  
 MUTONGA/GRAND FALLS HYDROPOWER PROJECT

Single Line Diagram

Fig. No.  
 DWG-12

3

4

5

1

2

3

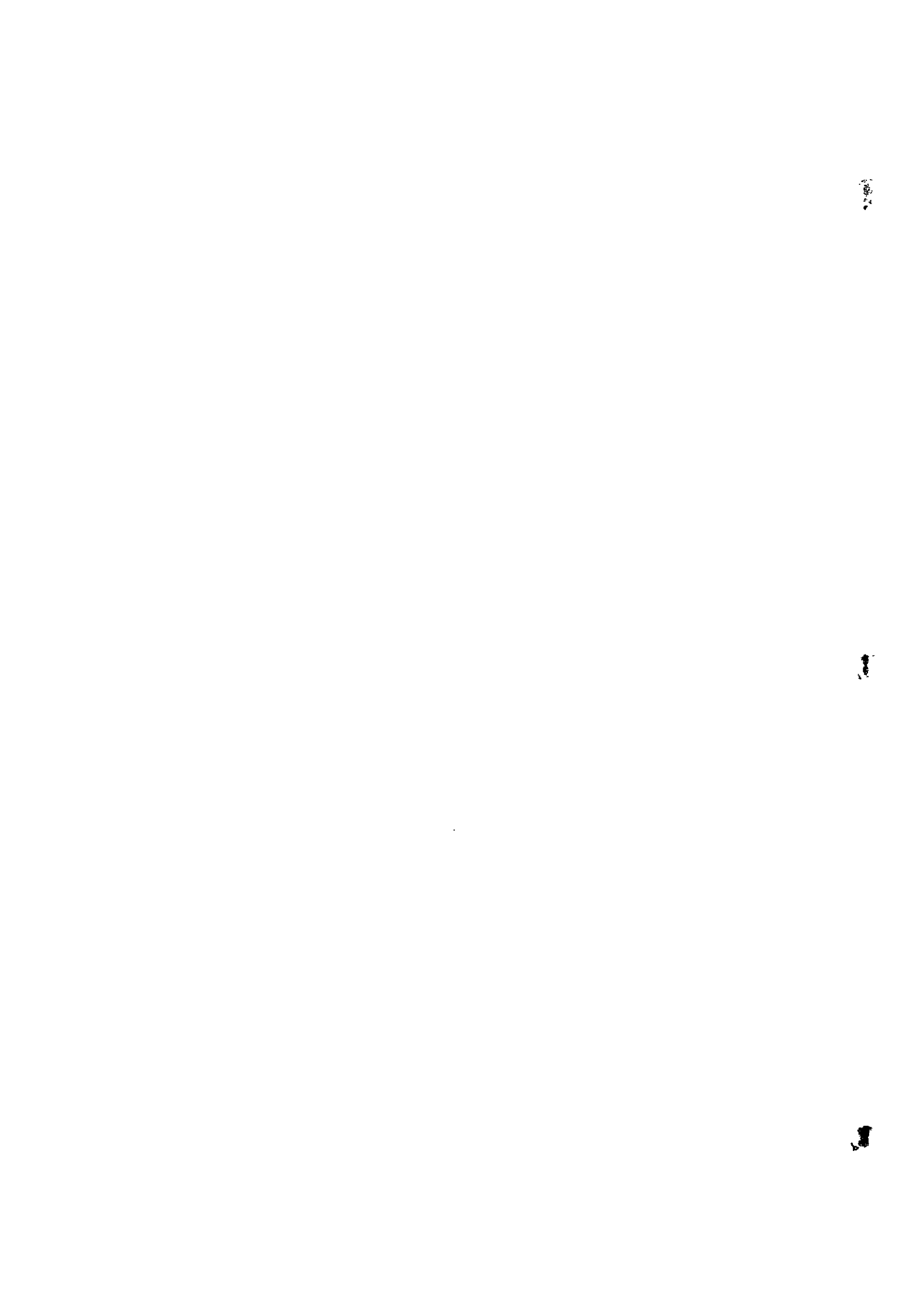





JICA