

JAPAN INTERNATIONAL COOPERATION AGENCY
 REPUBLIC OF YENYA
 MUTONGA/GRAND FALLS HYDROPOWER PROJECT

2008年の潮流解析結果

Fig. No.
 図 5.2.9

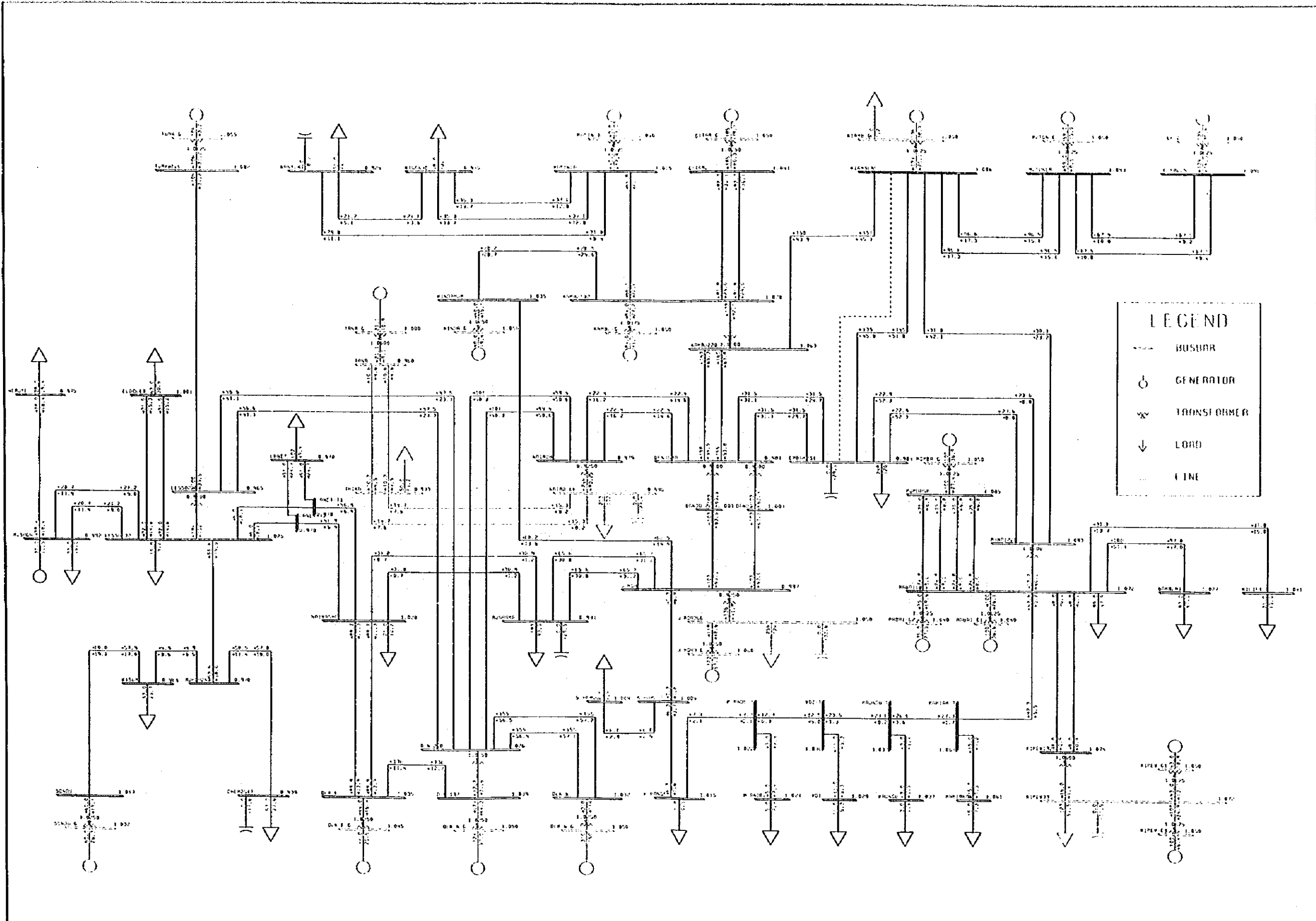

JAPAN INTERNATIONAL COOPERATION AGENCY
 REPUBLIC OF KENYA
 MUTONGA/GRAND FALLS HYDROPOWER PROJECT

2012年の潮流解析結果

Fig. No.
 図 5.2.10

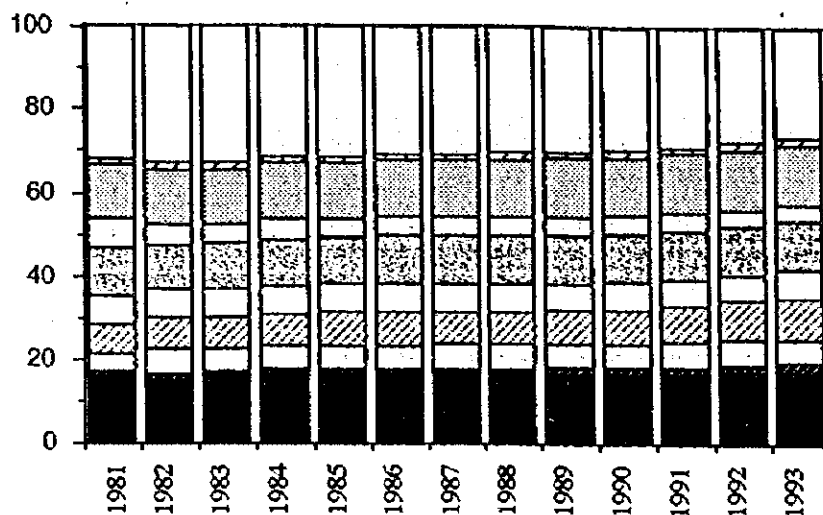

- Agriculture
- ▨ Forestry, Fishery, Mining/quarrying
- ▤ Manufacturing
- ▧ Building/construction, Electricity/water
- ▩ Trade/restaurant/hotel
- Transport/storage/communication
- ▨ Finance/insurance/real estate/business services
- ▧ Other services
- ▩ Domestic Services
- ▤ Procedures of Government Services

Source : Statistical Abstract 1991

JAPAN INTERNATIONAL COOPERATION AGENCY
 REPUBLIC OF KENYA
 MUTONGA/GRAND FALLS HYDROPOWER PROJECT

地域別及び産業別国内総生産

Fig. No.

図 5.3.1

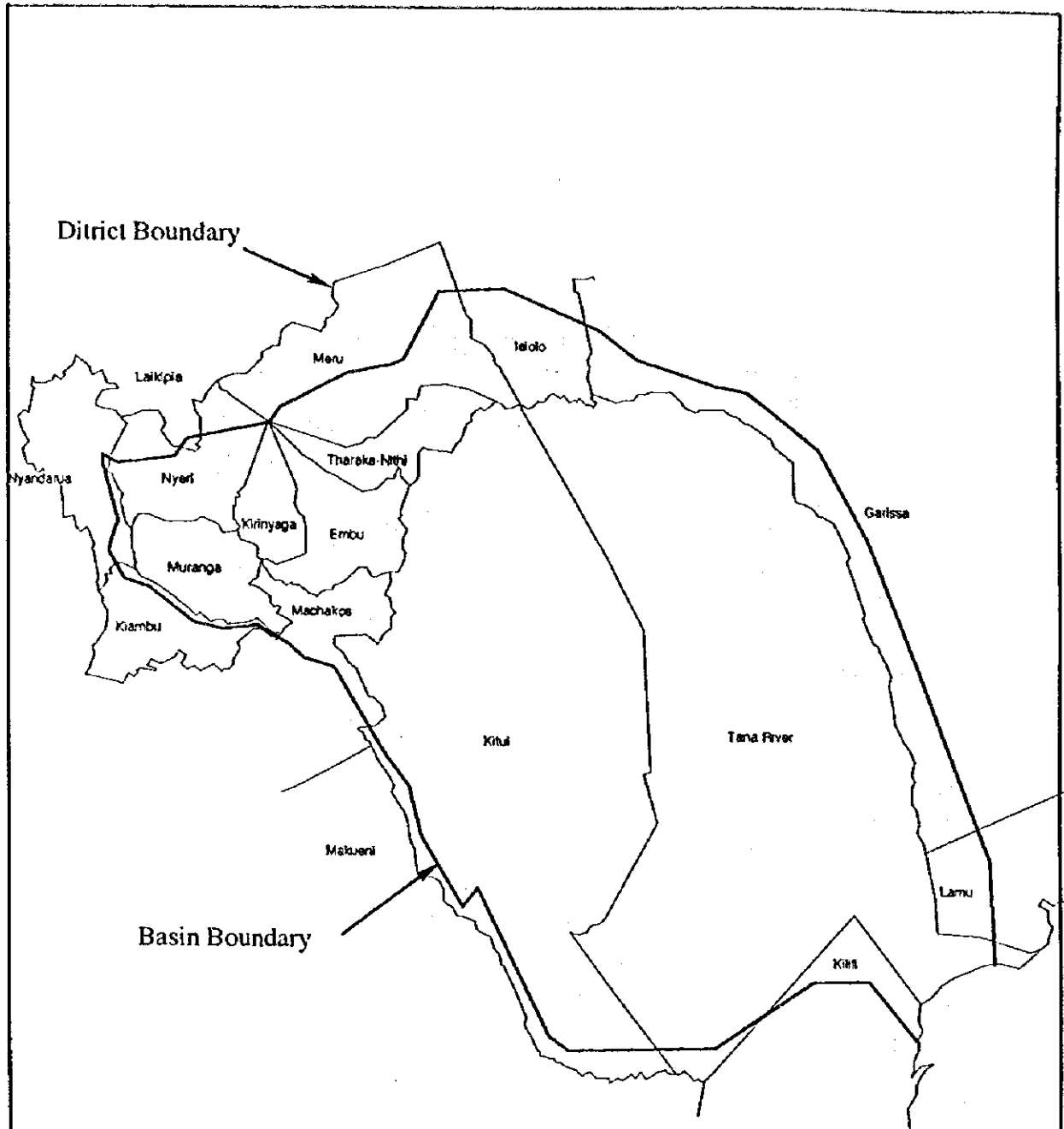

Source : TARDA

JAPAN INTERNATIONAL COOPERATION AGENCY
 REPUBLIC OF KENYA
 MUTONGA/GRAND FALLS HYDROPOWER PROJECT

タナ川流域内の県

Fig. No.
 図 5.3.2

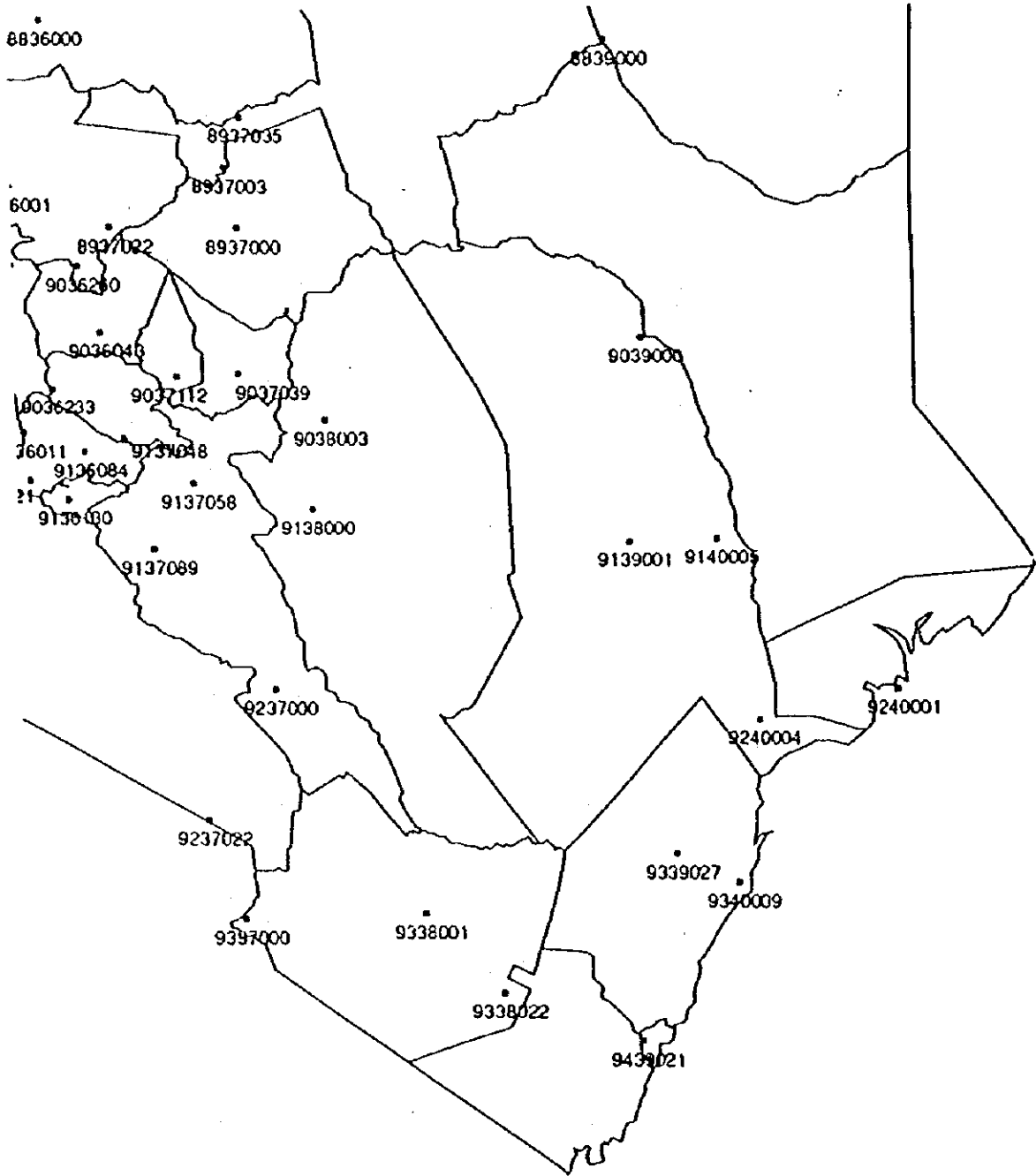

LEGEND

9136167 Station Number

Source : National Water Master Plan 1992, JICA

<p>JAPAN INTERNATIONAL COOPERATION AGENCY REPUBLIC OF KENYA MUTONGA/GRAND FALLS HYDROPOWER PROJECT</p>	<p>水文観測所の位置図</p>	<p>Fig. No. 図 5.3.3</p>
--	------------------	--------------------------------------

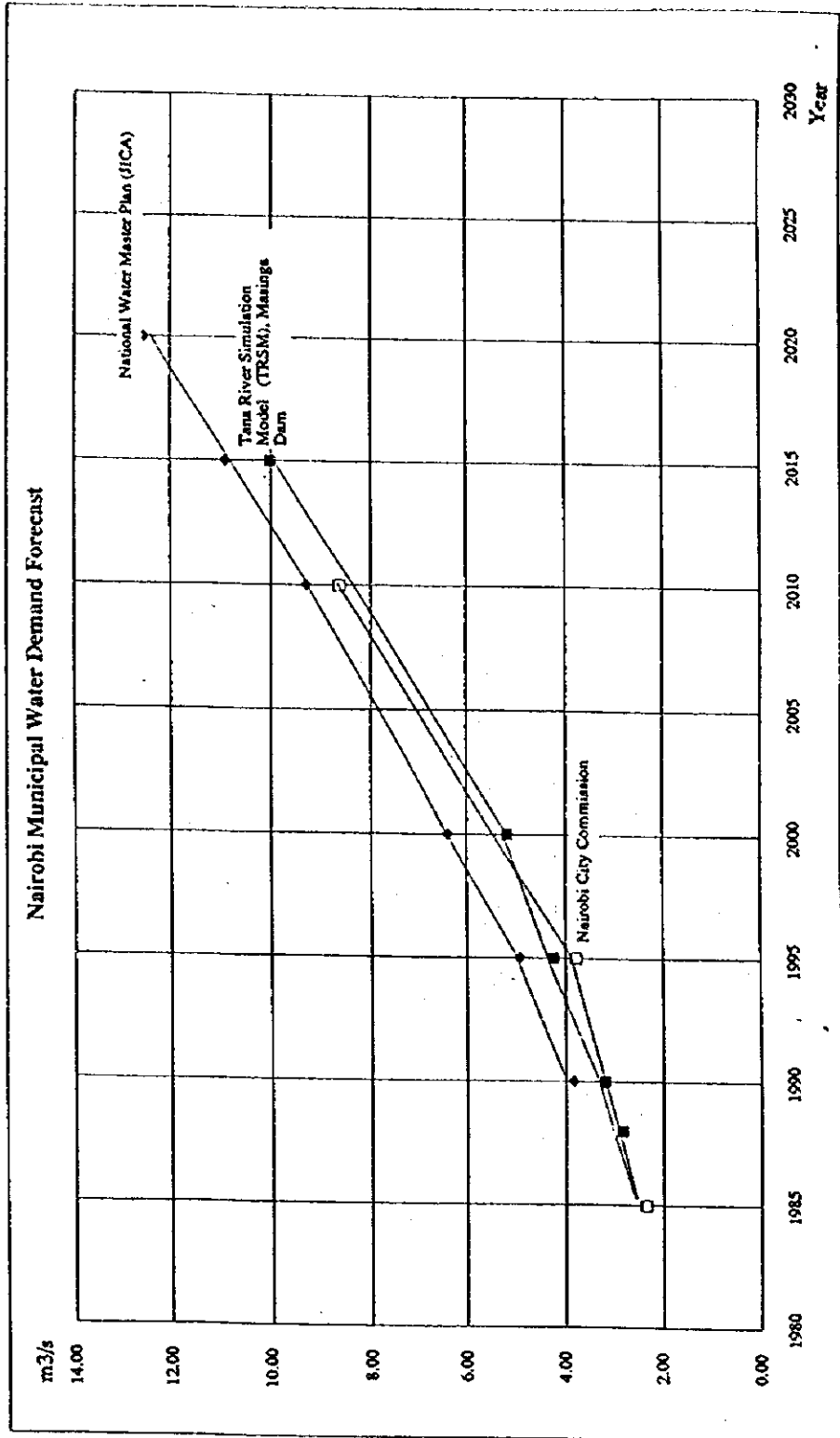

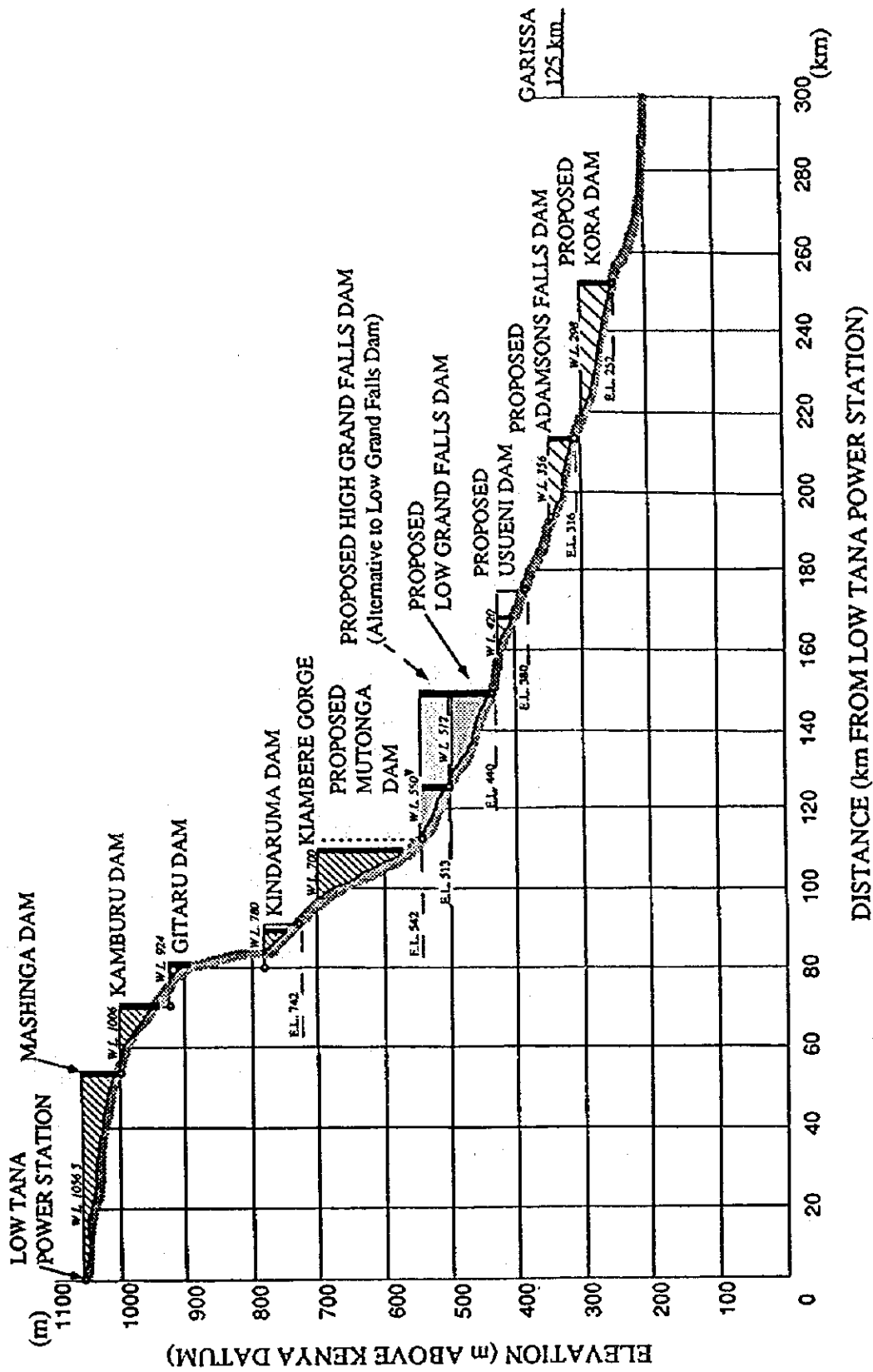

JAPAN INTERNATIONAL COOPERATION AGENCY
 REPUBLIC OF KENYA
 MUTONGA/GRAND FALLS HYDROPOWER PROJECT

タナ川の水力発電所

Fig. No.
 図 6.1.1

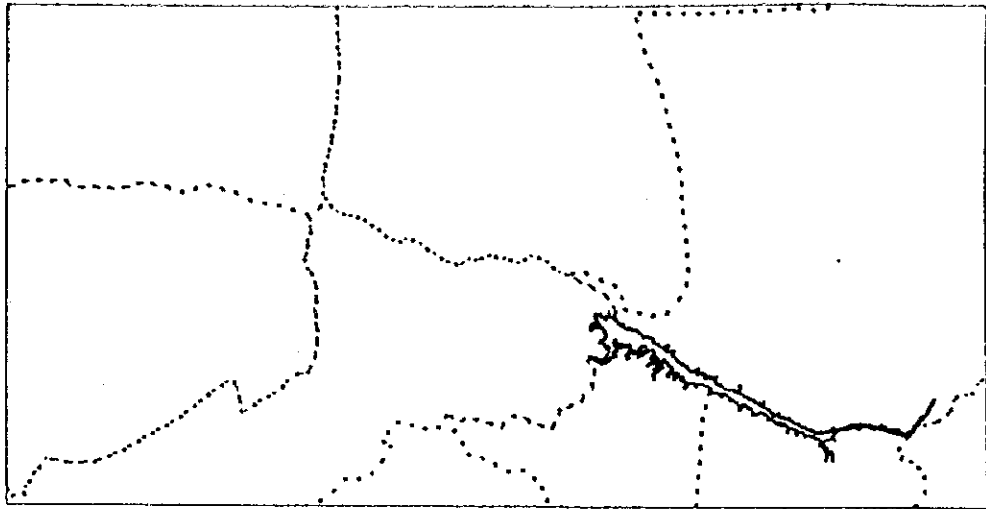

Mutonga

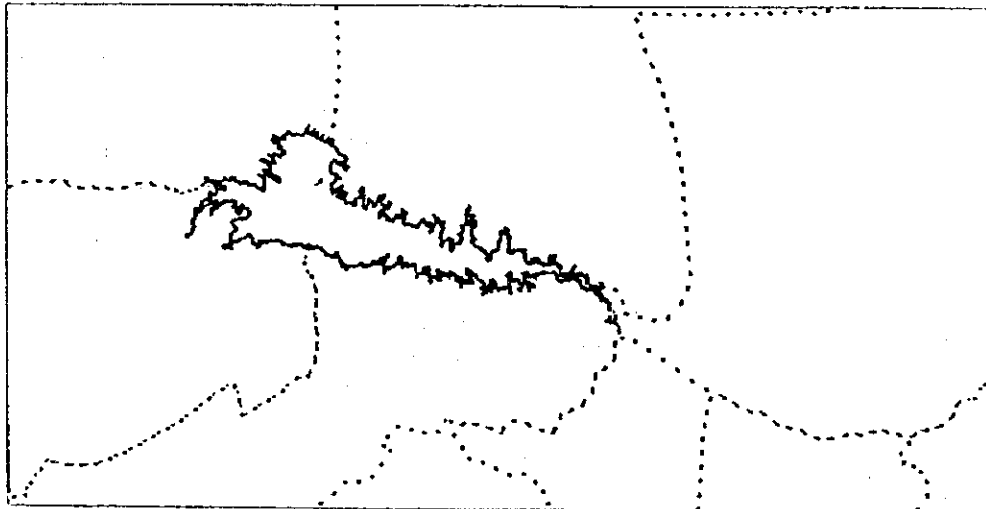

Low Grand Falls

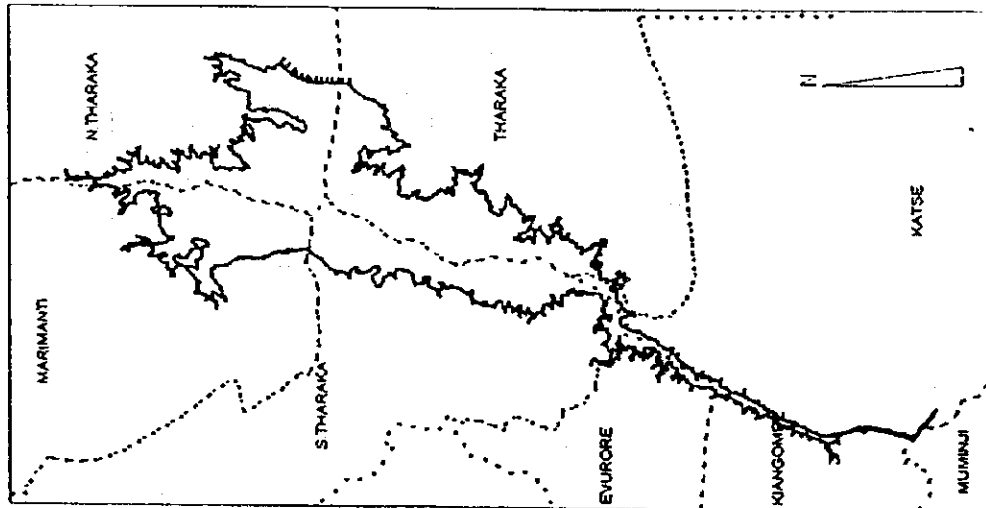

High Grand Falls

JAPAN INTERNATIONAL COOPERATION AGENCY
 REPUBLIC OF KENYA
 MUTONGA/GRAND FALLS HYDROPOWER PROJECT

ムトンガ・低グランドフォールズ
 高グランドフォールズダムの貯水池規模

Fig. No.
 図 6.1.2

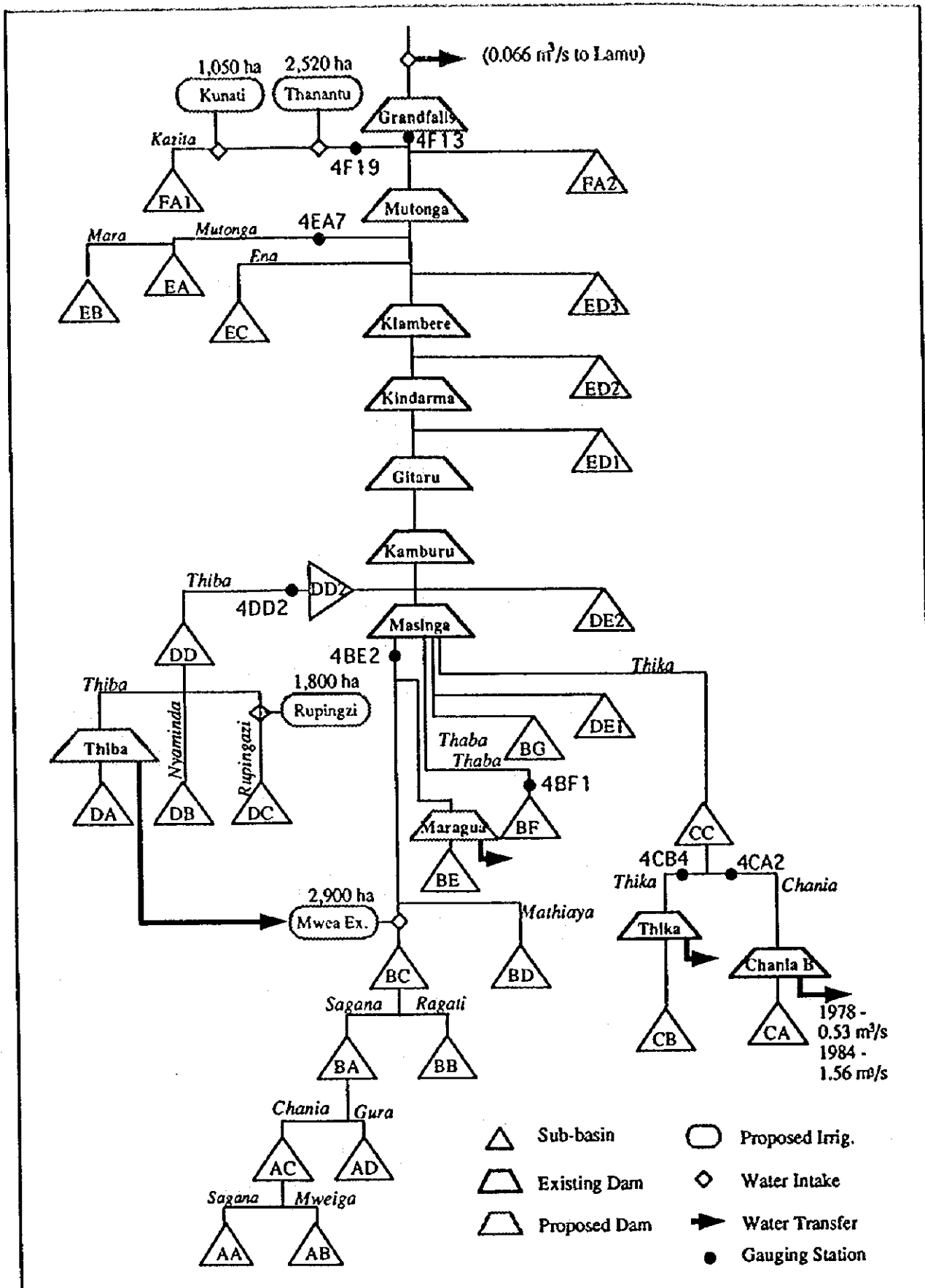

JAPAN INTERNATIONAL COOPERATION AGENCY
 REPUBLIC OF KENYA
 MUTONGA/GRAND FALLS HYDROPOWER PROJECT

タナ上流域の流域モデル

Fig. No.
 図 6.2.1

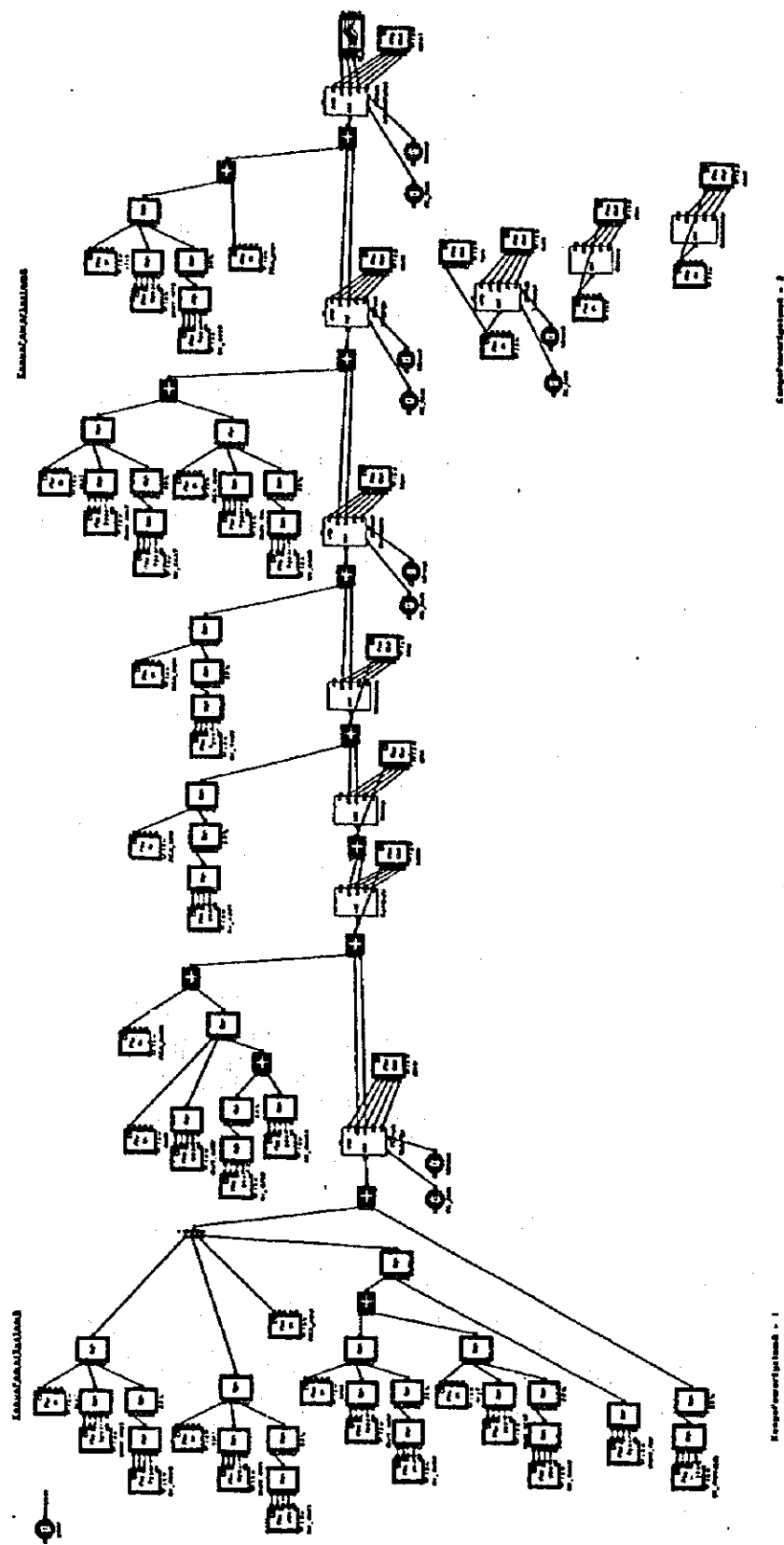

JAPAN INTERNATIONAL COOPERATION AGENCY
 REPUBLIC OF KENYA
 MUTONGA/GRAND FALLS HYDROPOWER PROJECT

貯水池運用操作シミュレーションモデル

Fig. No.
 図 6.2.2

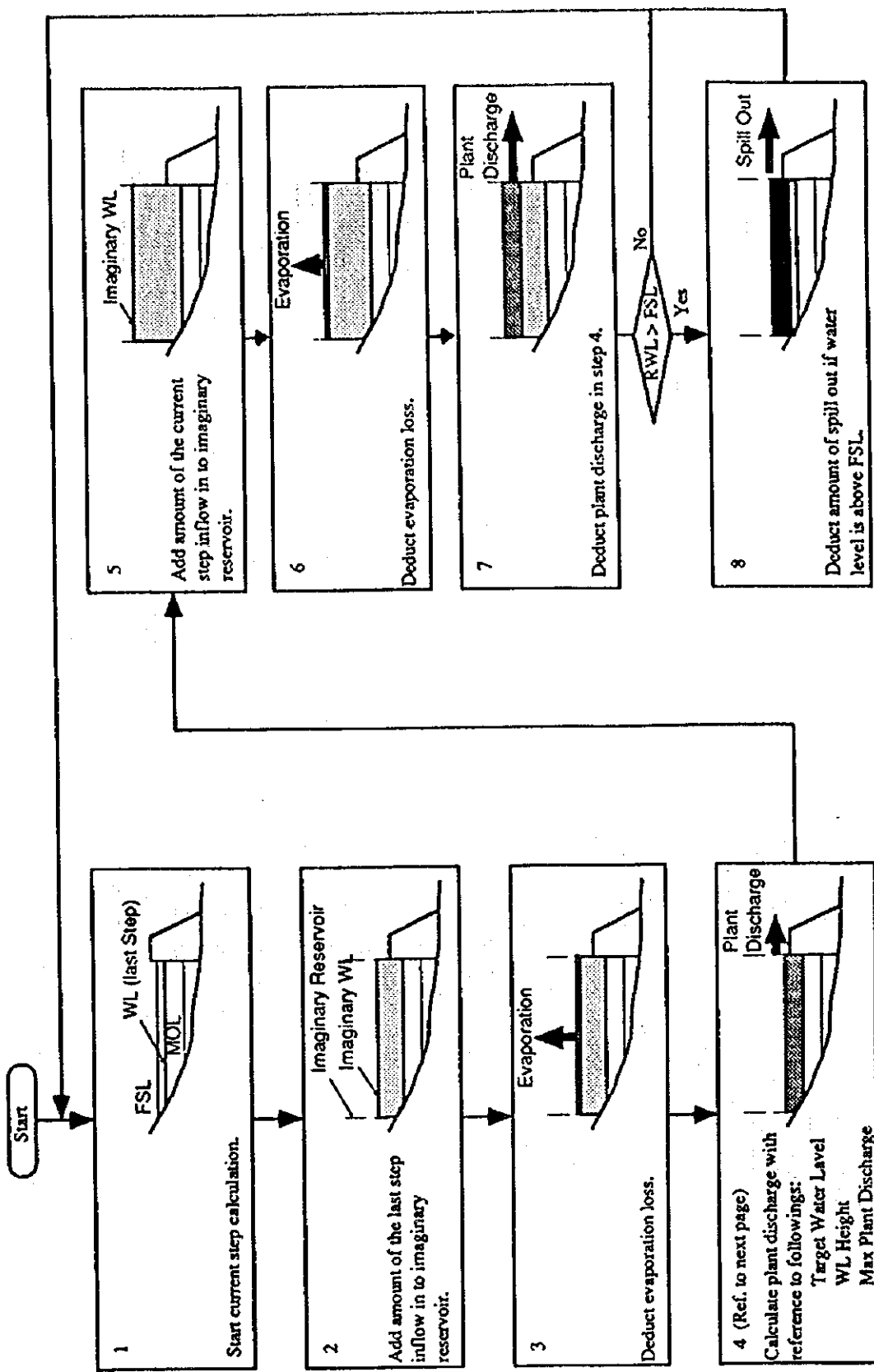

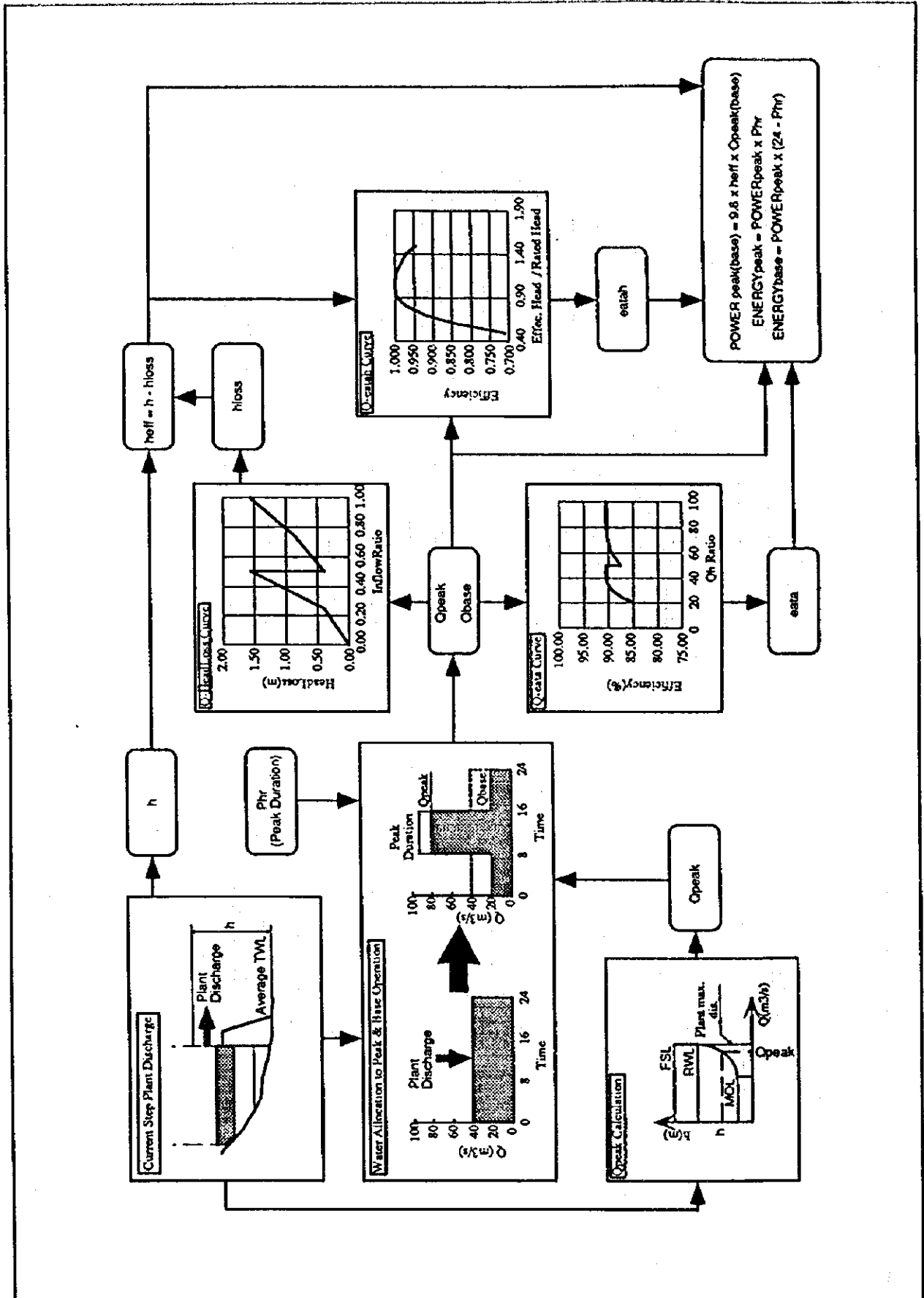

発電流量と電力計算の流れ図

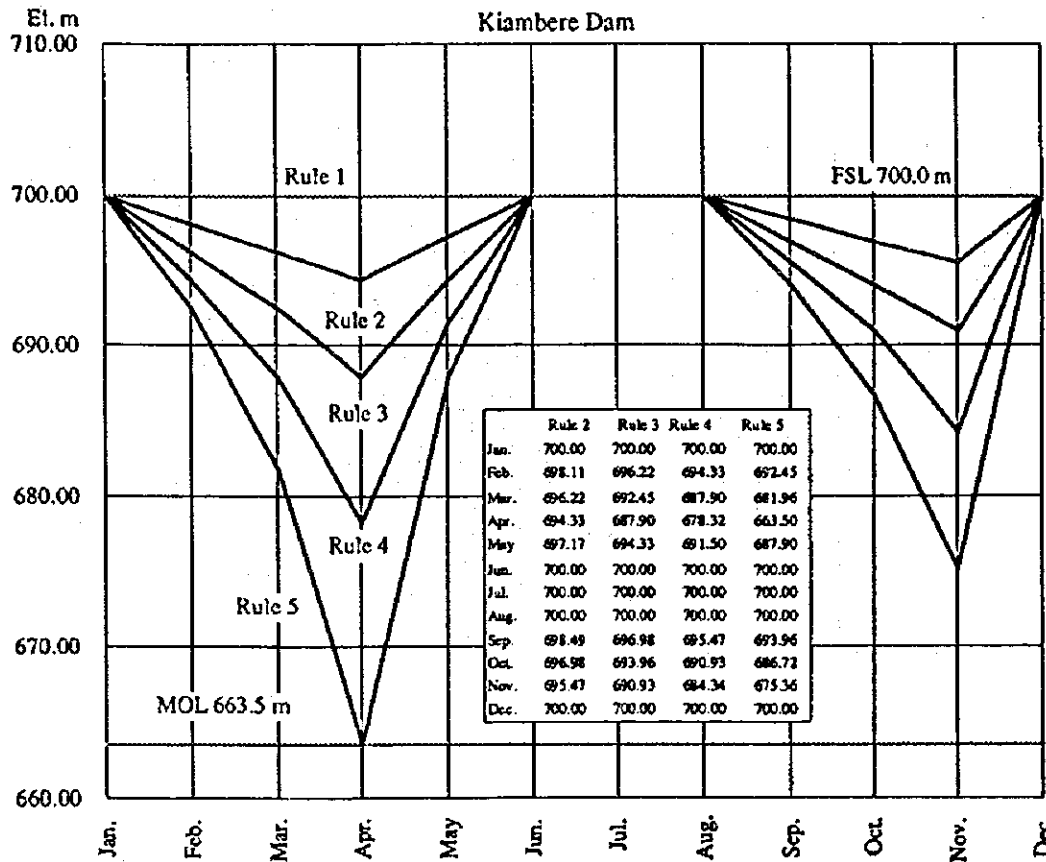
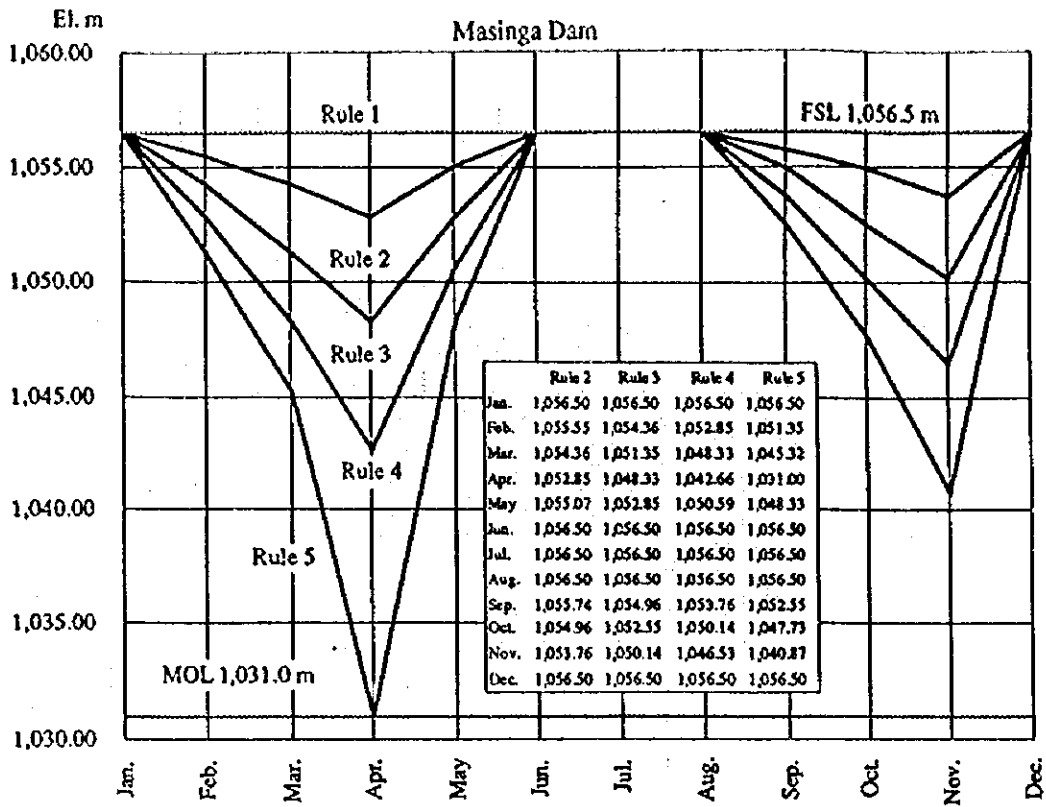

JAPAN INTERNATIONAL COOPERATION AGENCY
 REPUBLIC OF KENYA
 MUTONGA/GRAND FALLS HYDROPOWER PROJECT

貯水池運用操作ルールカーブ (I)

Fig. No.
 図 6.2.5

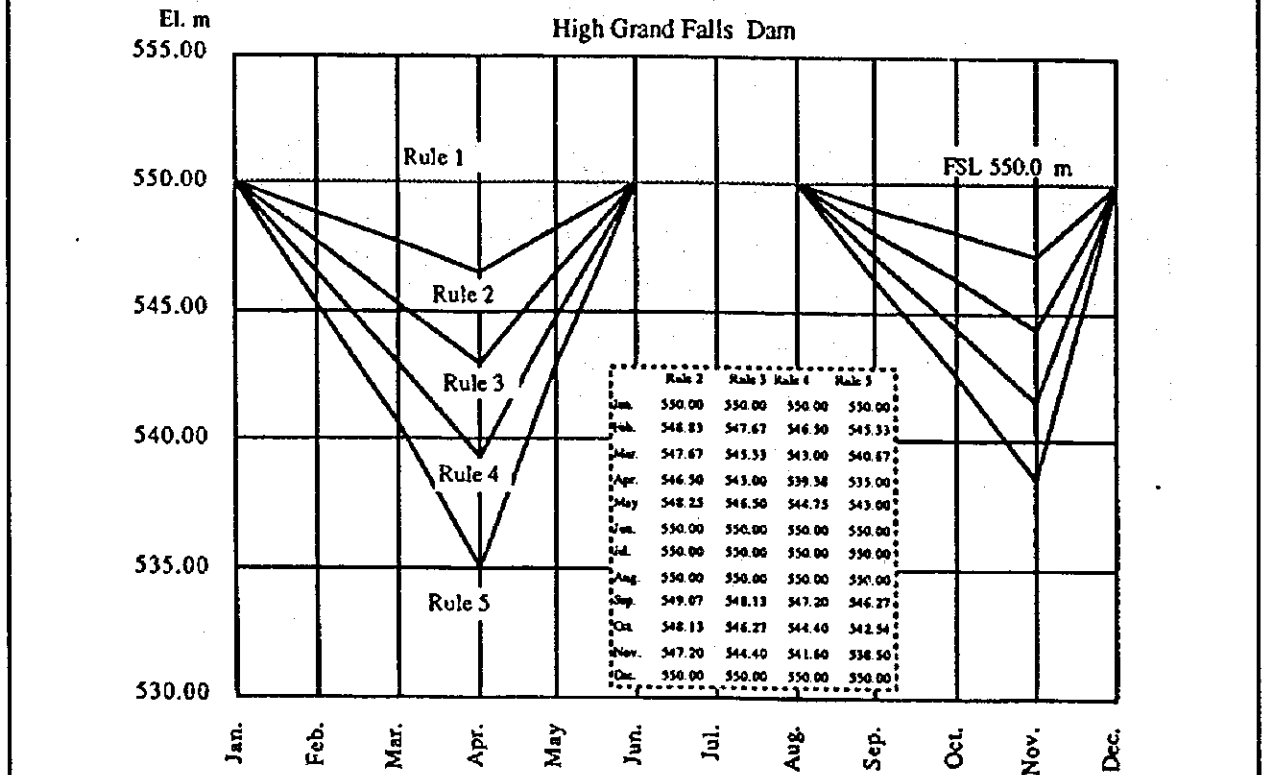
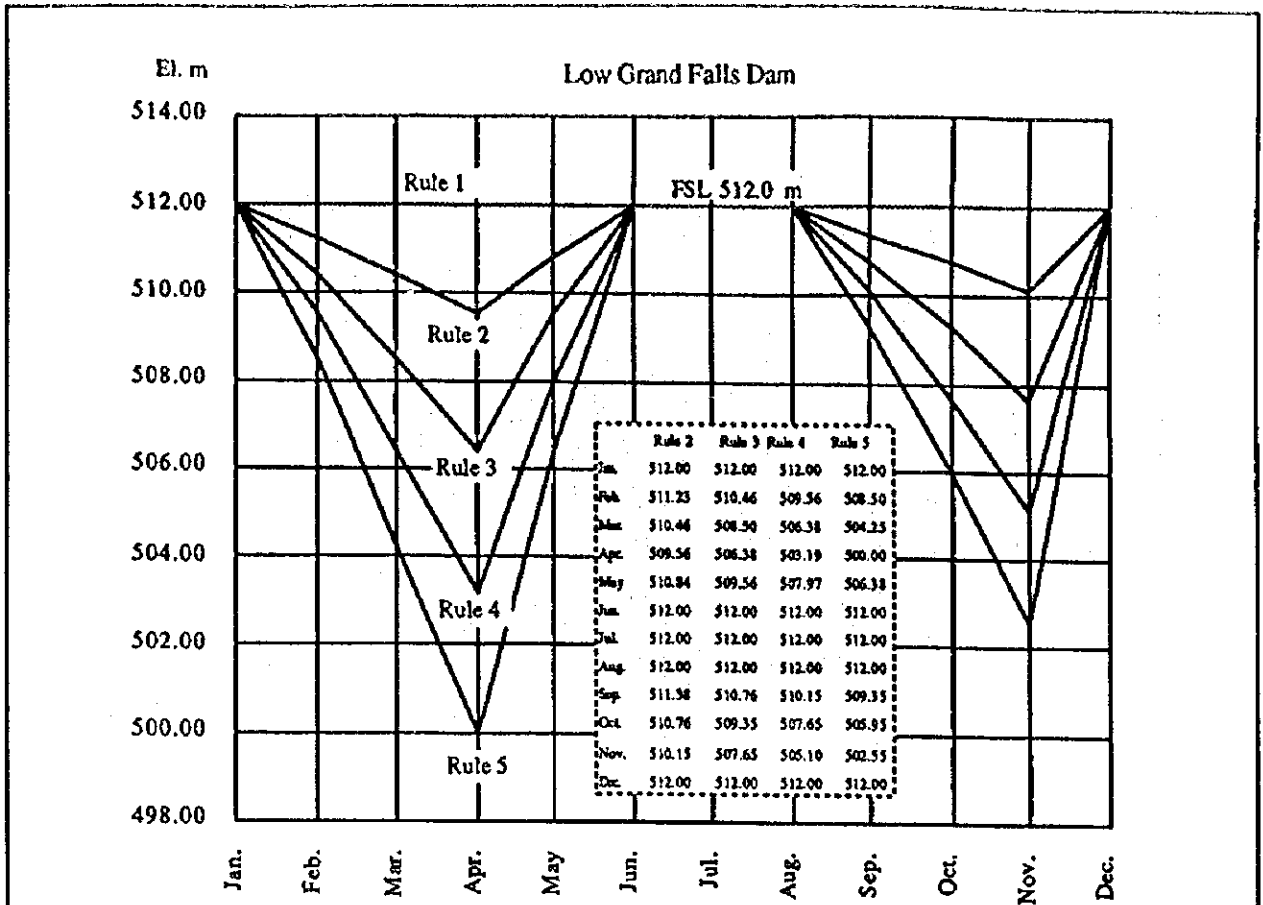

Masinga

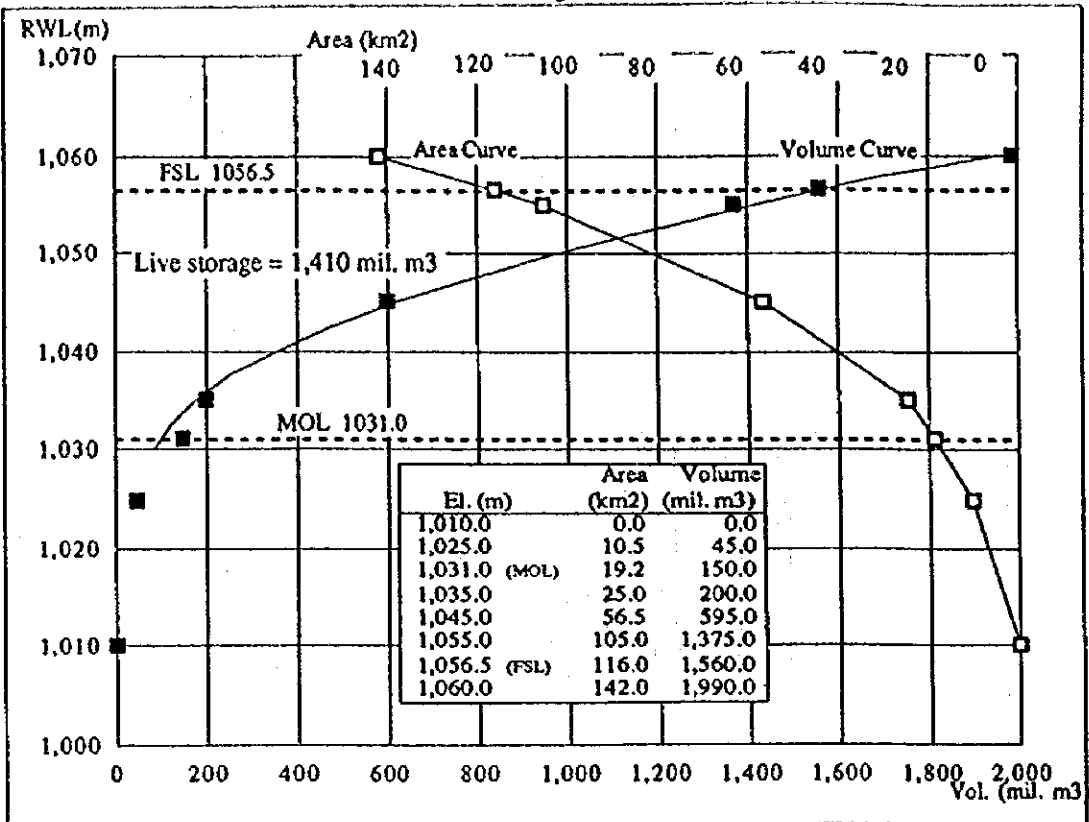

Kamburu

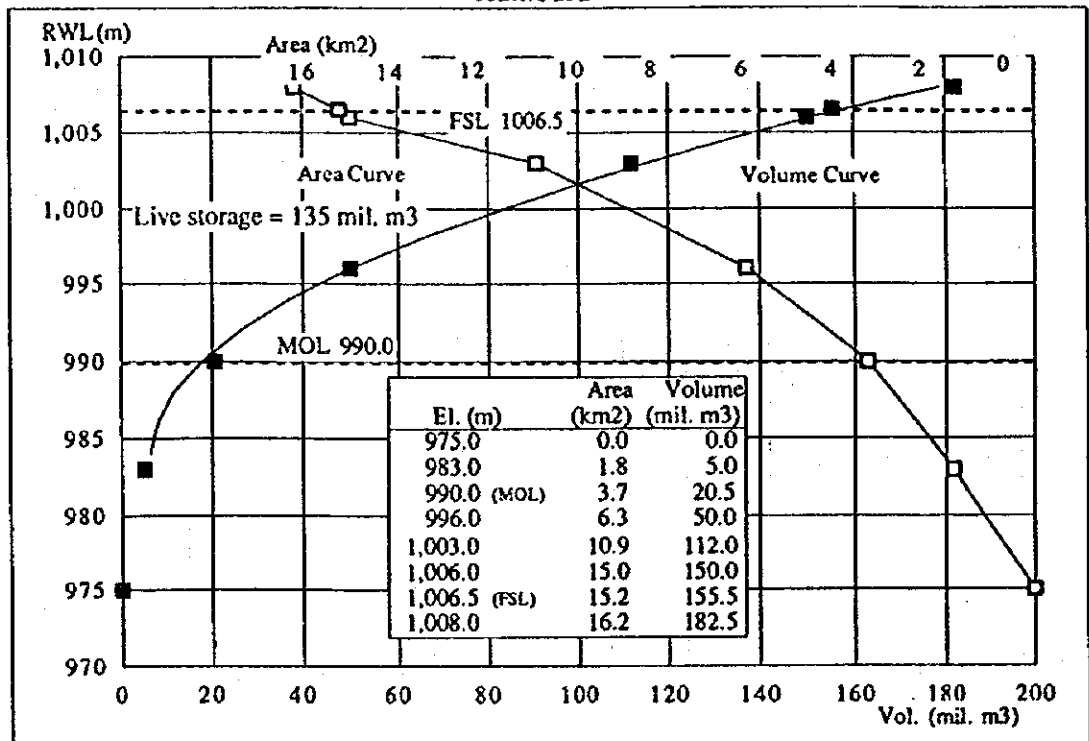

JAPAN INTERNATIONAL COOPERATION AGENCY
 REPUBLIC OF KENYA
 MUTONGA/GRAND FALLS HYDROPOWER PROJECT

貯水容量と面積のカーブ (I)
 (マシンガ及びキャンブル)

Fig. No.
 6.2.7

Kiambere

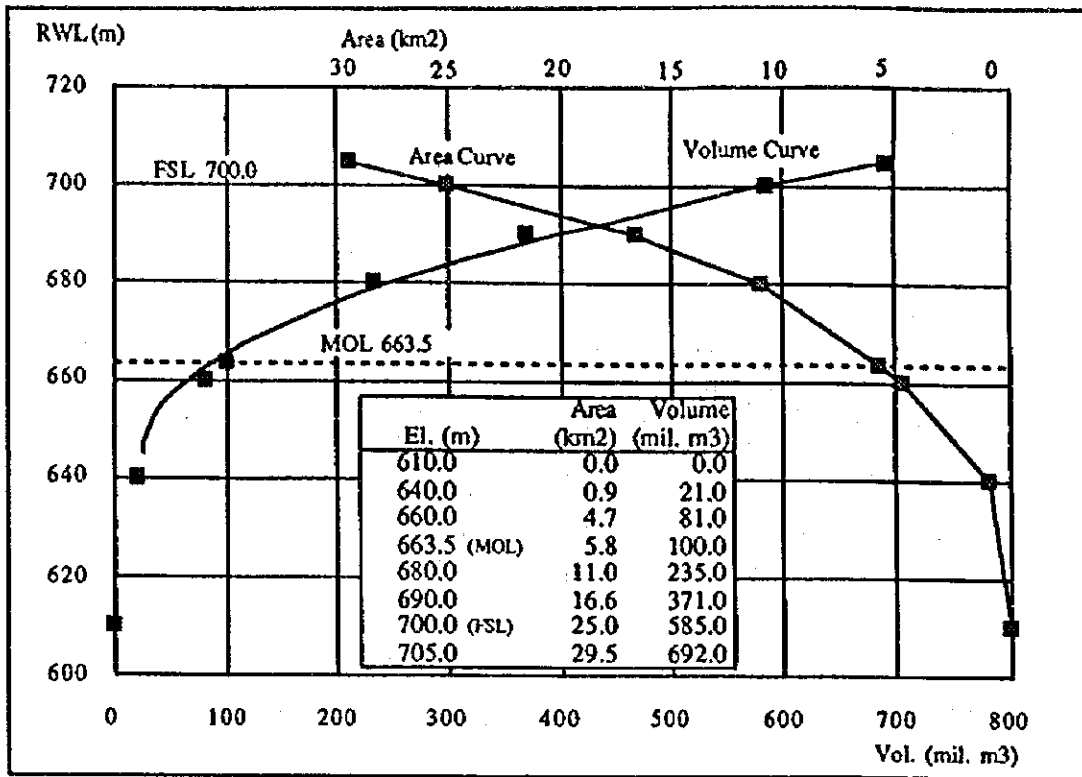

Mutonga

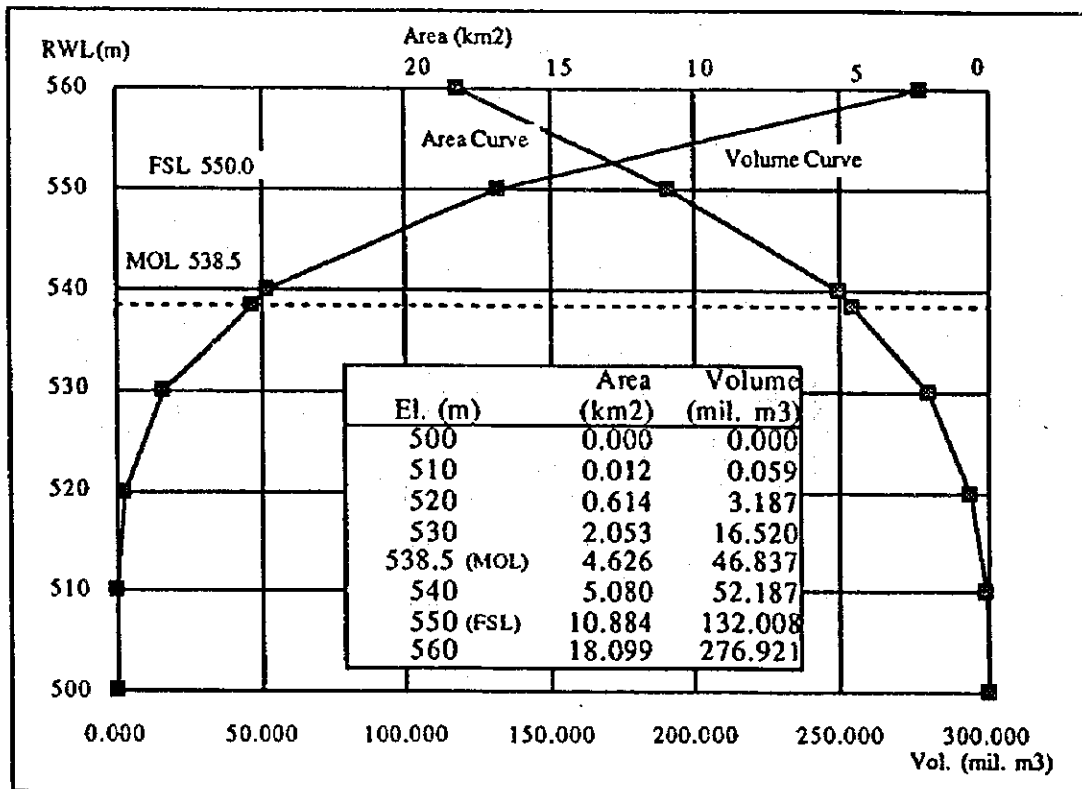

Grand Falls

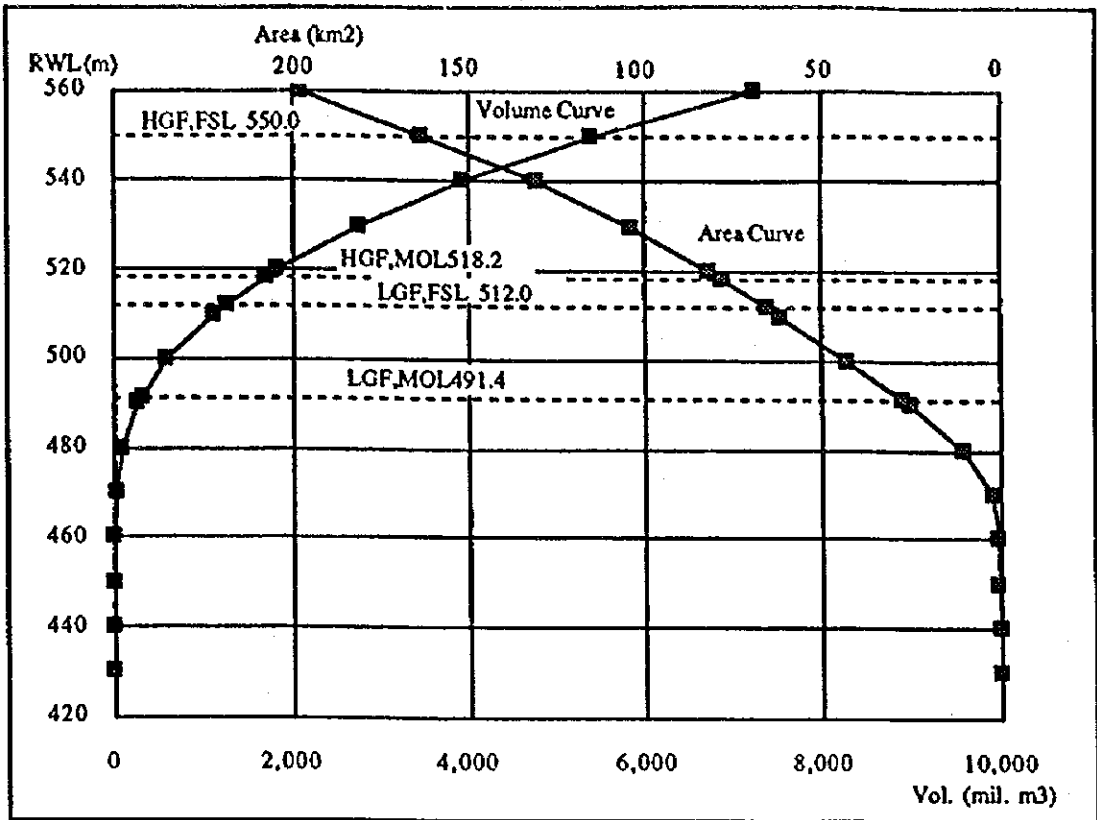

El. (m)	Area (km ²)	Volume (mil. m ³)
430	0.000	0.000
440	0.000	0.000
450	0.298	1.492
460	0.737	6.672
470	2.226	21.491
480	10.222	83.735
490	24.774	258.717
491.4 (MOL)	27.278	305.919
500	42.658	595.877
510	61.677	1,117.551
512 (FSL)	65.720	1,261.119
518.2 (MOL)	78.253	1,706.180
520	81.892	1,835.391
530	104.167	2,765.682
540	130.736	3,940.195
550 (FSL)	163.255	5,410.152
560	198.045	7,216.655

JAPAN INTERNATIONAL COOPERATION AGENCY
 REPUBLIC OF KENYA
 MUTONGA/GRAND FALLS HYDROPOWER PROJECT

貯水容量と面積のカーブ (3)
 (グランドフォールズ)

Fig. No.
 図 6.2.9

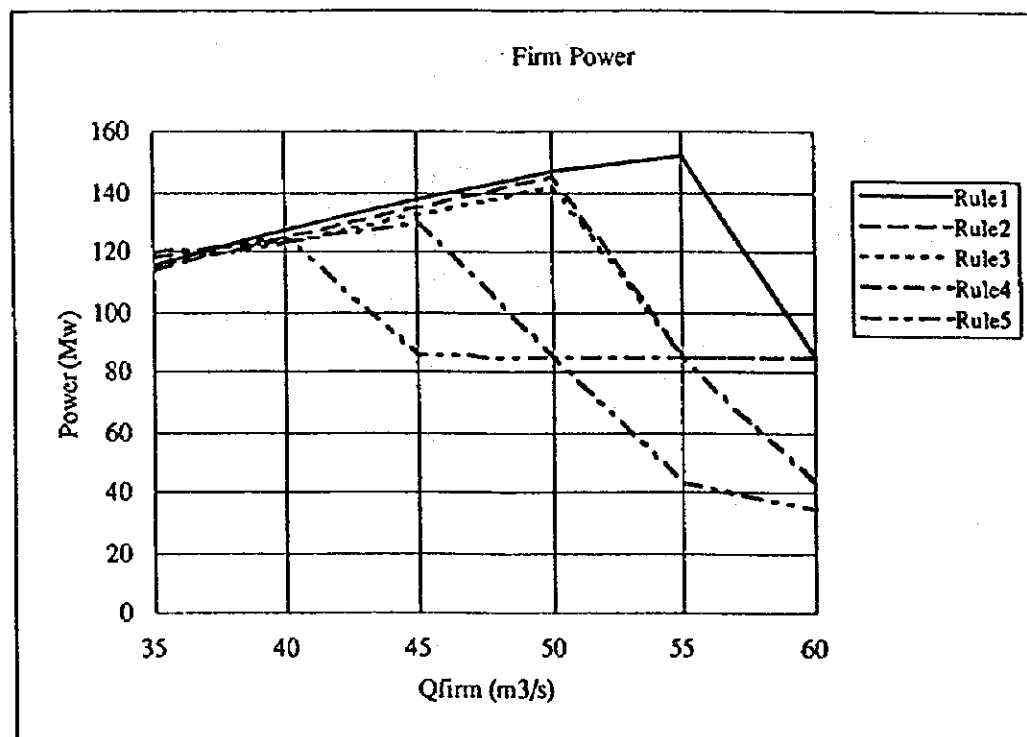
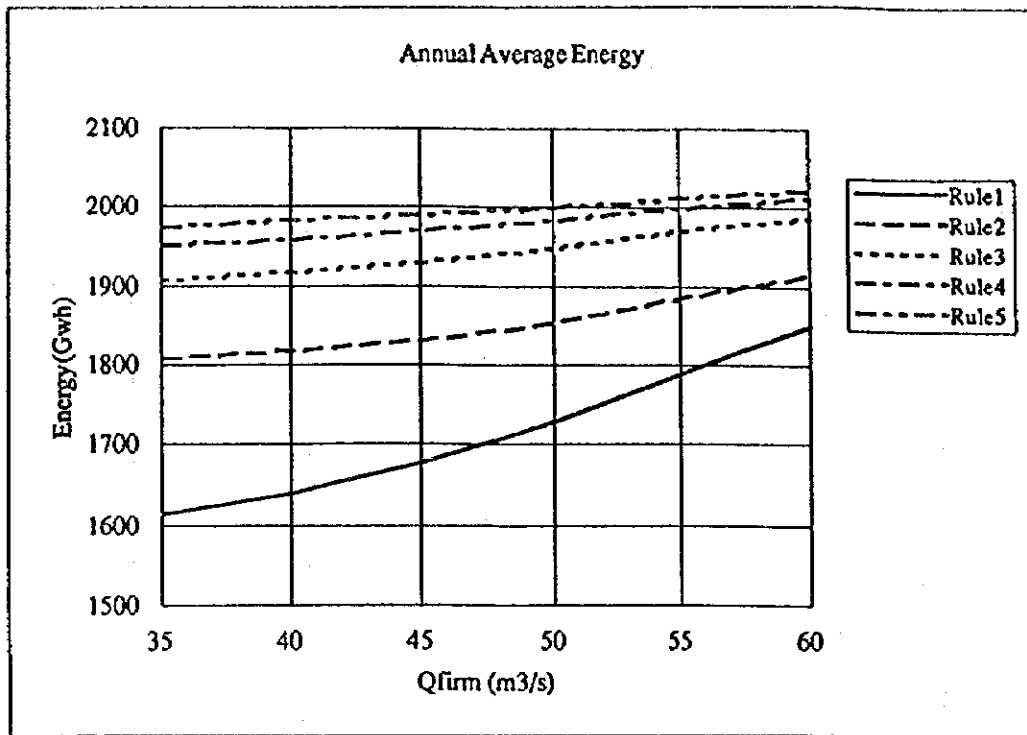

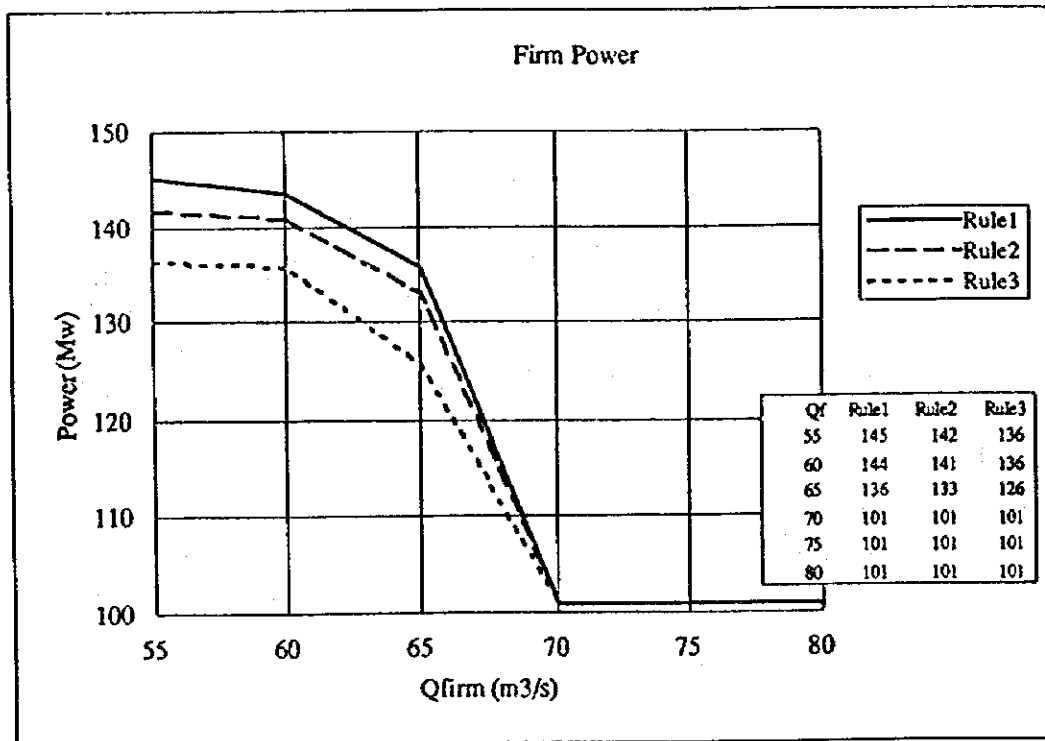
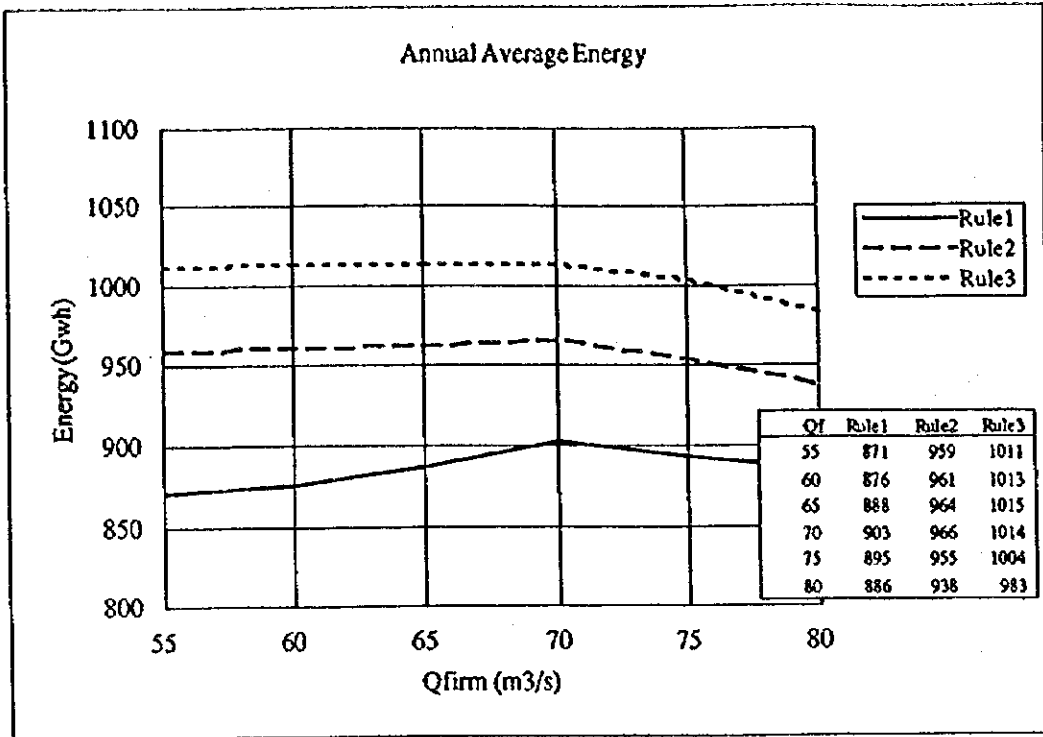

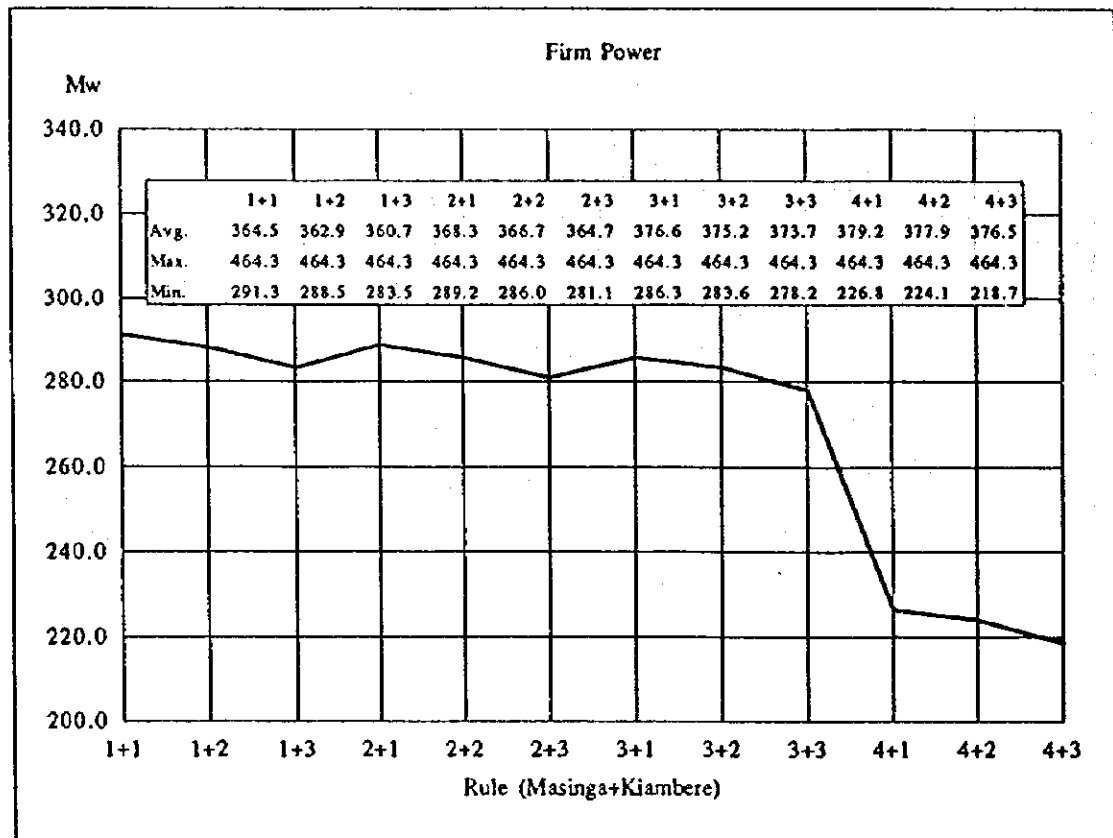
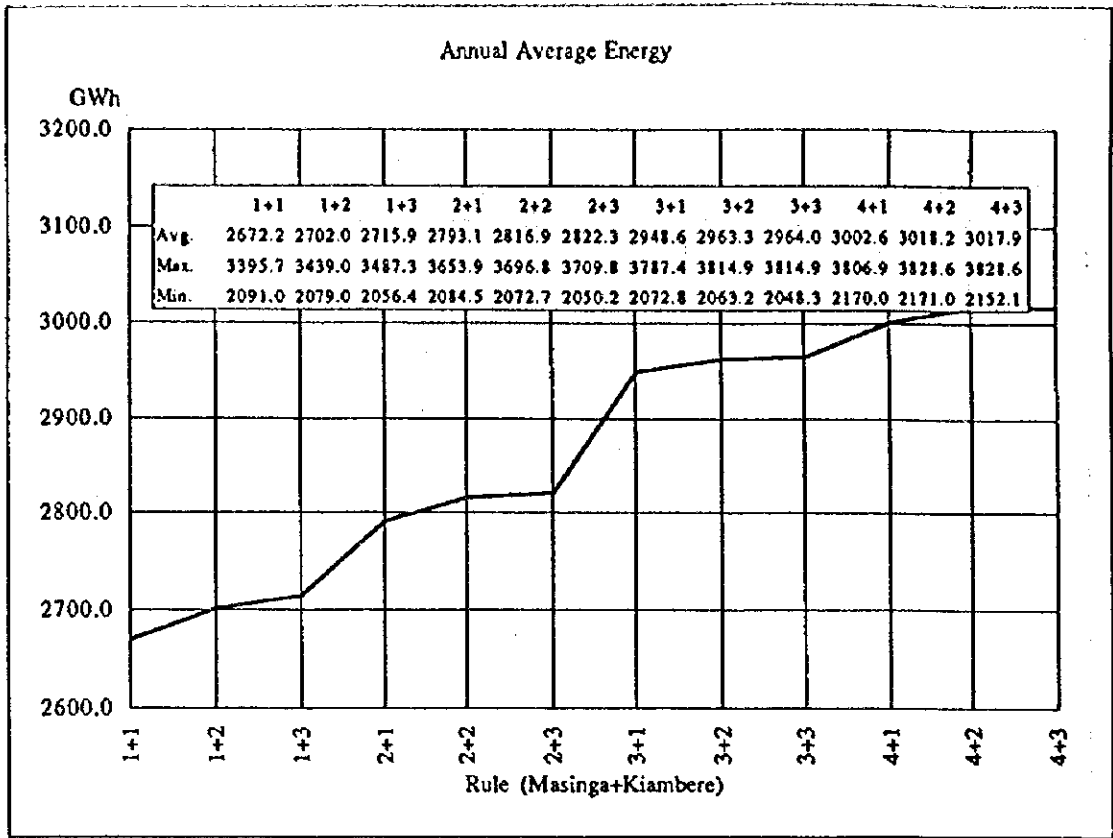

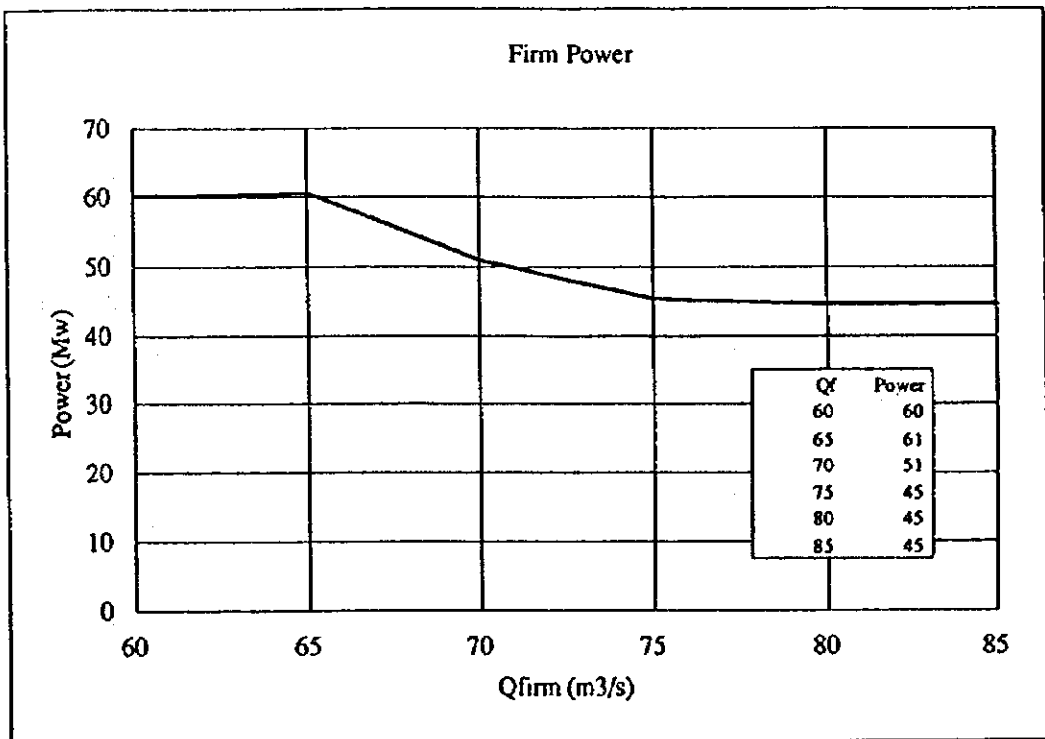
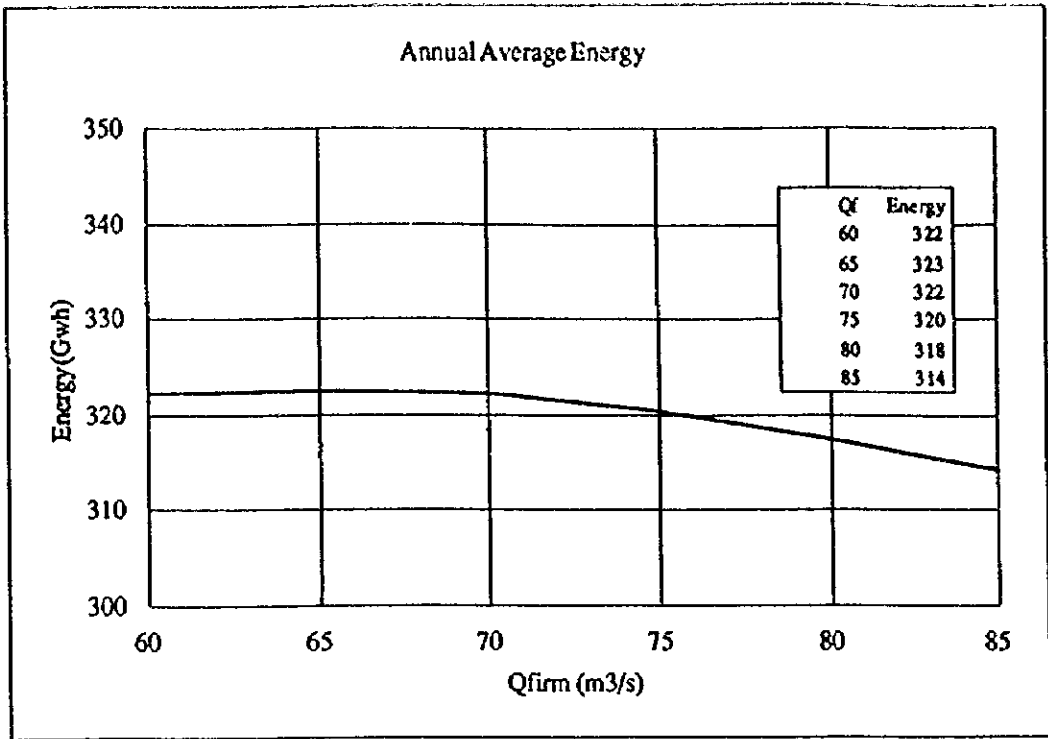

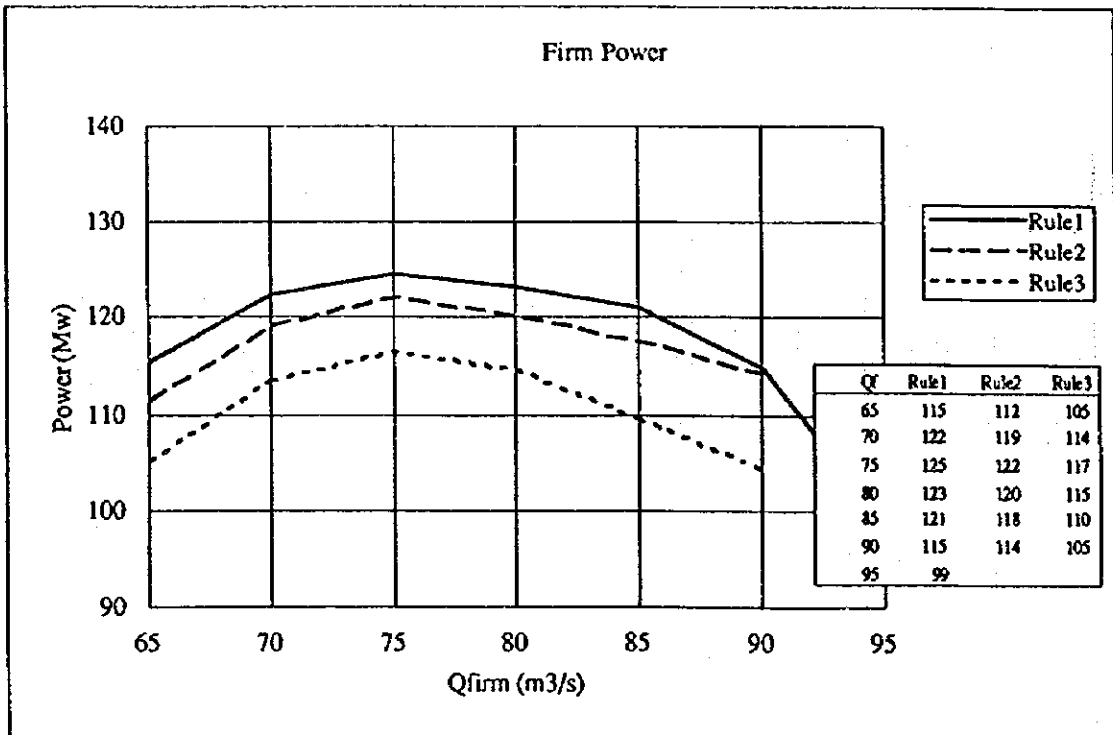
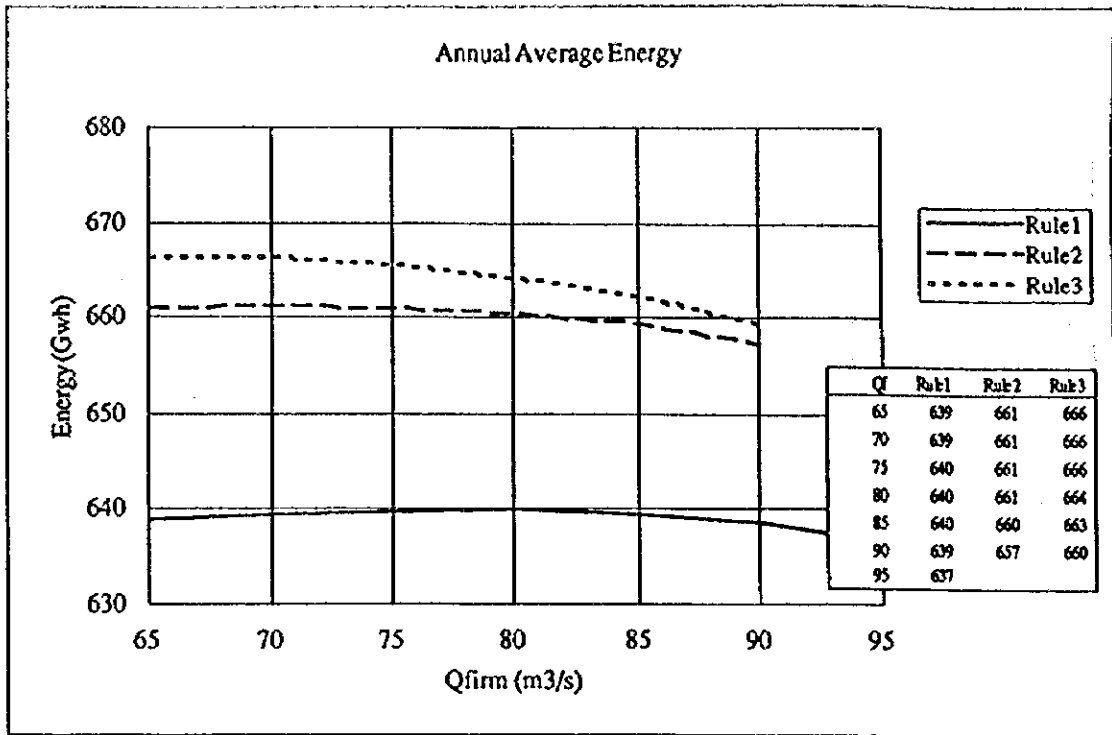

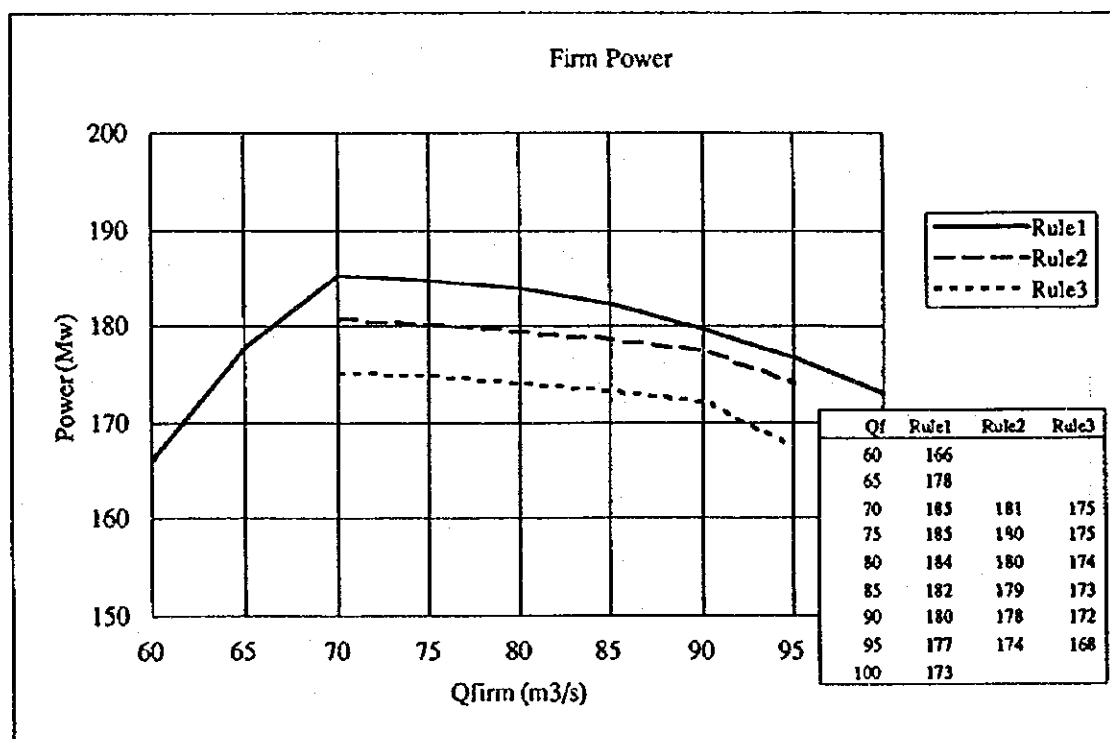
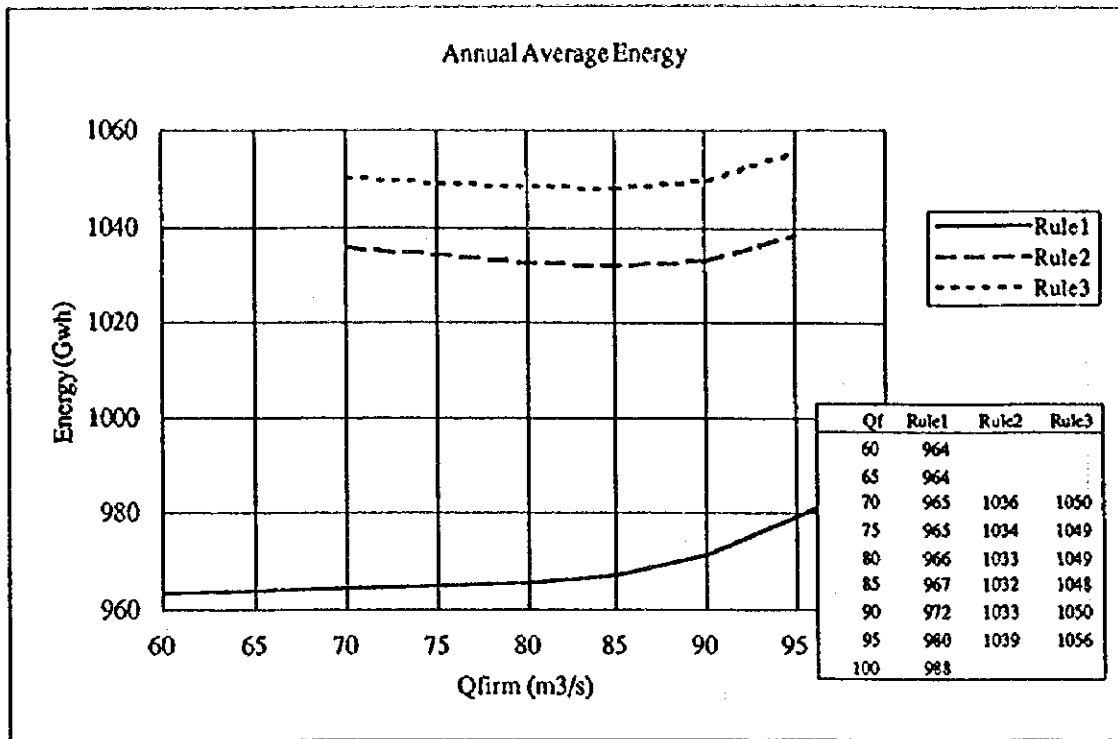

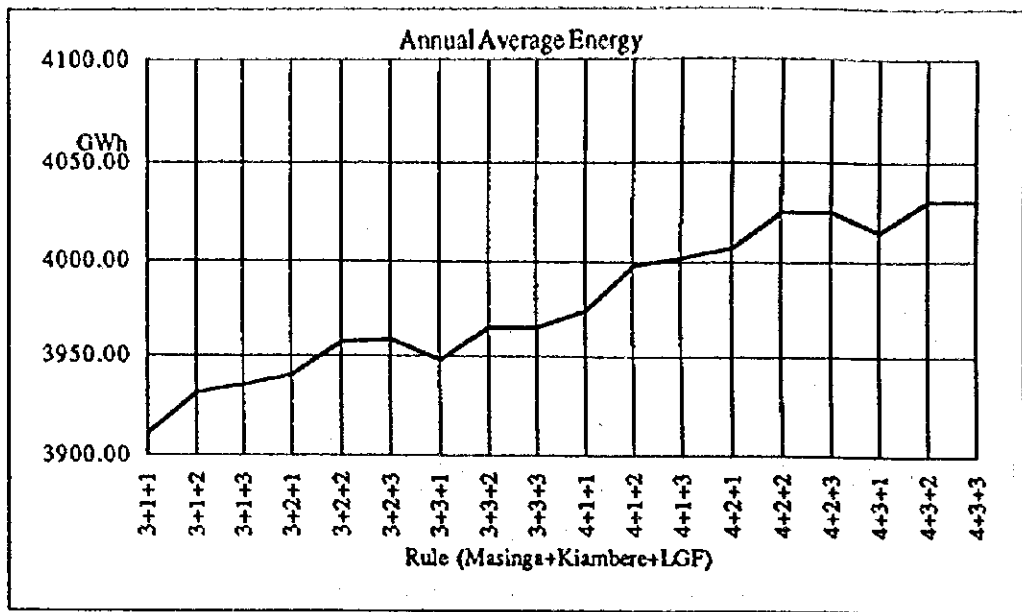

	3+1+1	3+1+2	3+1+3	3+2+1	3+2+2	3+2+3	3+3+1	3+3+2	3+3+3	4+1+1	4+1+2	4+1+3	4+2+1	4+2+2	4+2+3	4+3+1	4+3+2	4+3+3
Avg.	3911	3932	3937	3941	3958	3959	3949	3966	3965	3975	3998	4002	4007	4025	4025	4015	4031	4030
Max.	5159	5191	5214	5195	5227	5250	5195	5227	5250	5181	5213	5237	5209	5241	5264	5209	5241	5264
Min.	2704	2699	2689	2691	2688	2680	2677	2675	2666	2809	2804	2794	2806	2802	2794	2785	2784	2774

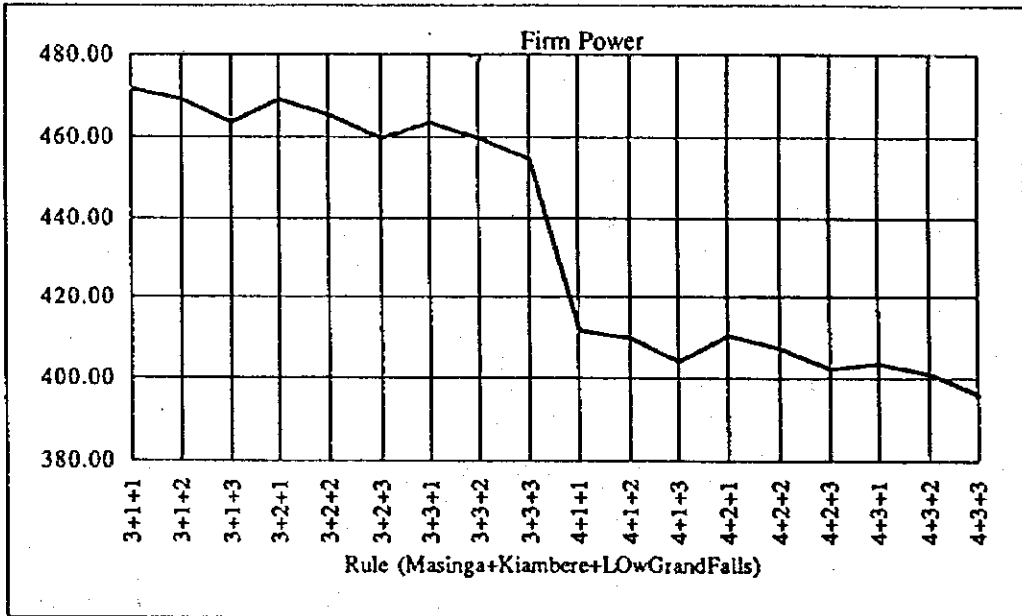

	3+1+1	3+1+2	3+1+3	3+2+1	3+2+2	3+2+3	3+3+1	3+3+2	3+3+3	4+1+1	4+1+2	4+1+3	4+2+1	4+2+2	4+2+3	4+3+1	4+3+2	4+3+3
Avg.	567	565	563	565	564	562	564	562	560	569	568	566	568	567	565	567	565	563
Max.	655	655	655	655	655	655	655	655	655	655	655	655	655	655	655	655	655	655
Min.	472	469	464	469	465	460	463	460	455	412	410	405	411	408	402	404	401	396

JAPAN INTERNATIONAL COOPERATION AGENCY
 REPUBLIC OF KENYA
 MUTONGA/GRAND FALLS HYDROPOWER PROJECT

タナ川全発電所のシミュレーション結果
 (マシングダムから
 低グランドフォールズダム)

Fig. No.
 図 6.2.16

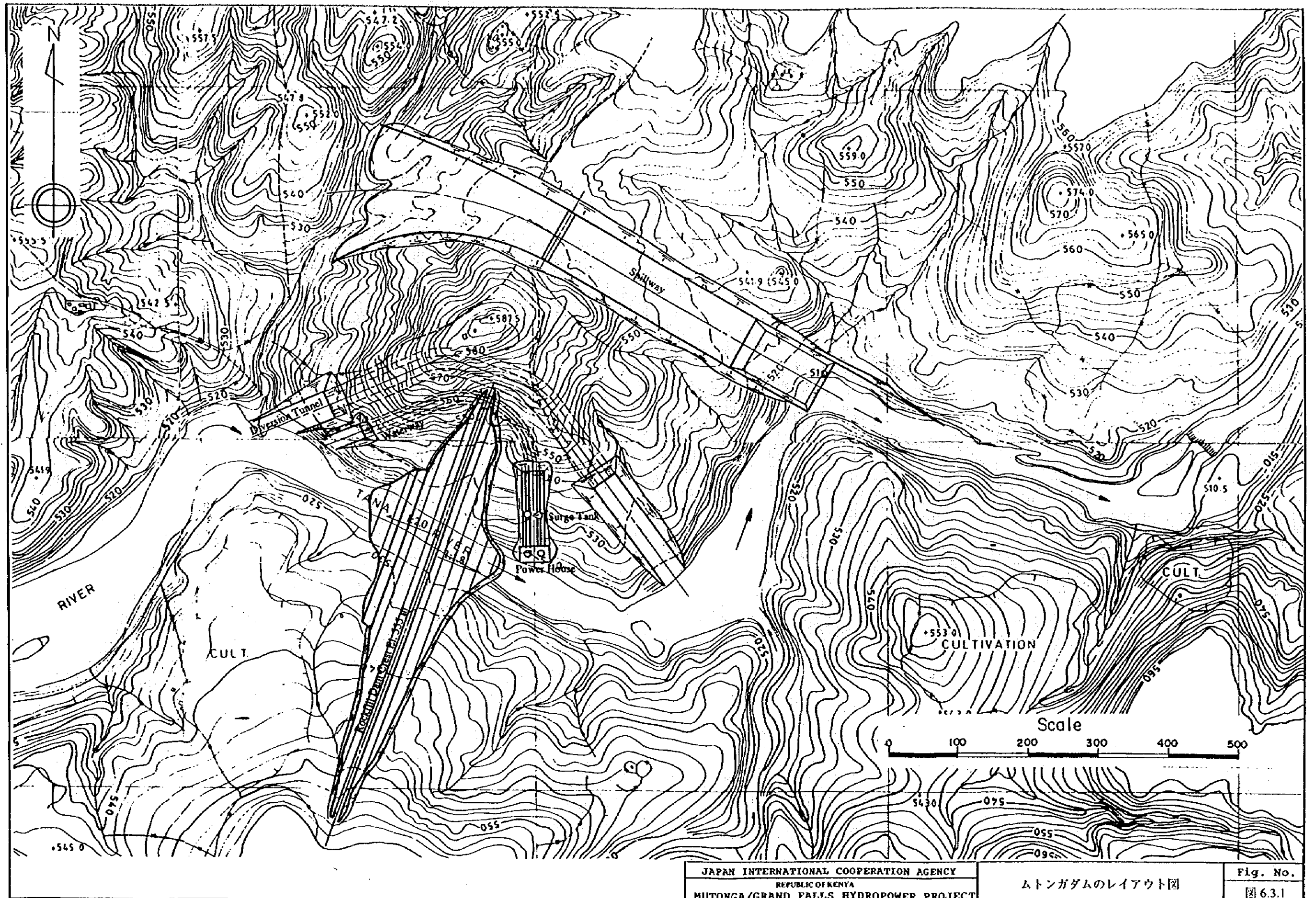

JAPAN INTERNATIONAL COOPERATION AGENCY
 REPUBLIC OF KENYA
 MUTONGA/GRAND FALLS HYDROPOWER PROJECT

ムトンガダムのレイアウト図
 图 6.3.1

Fig. No.
 图 6.3.1

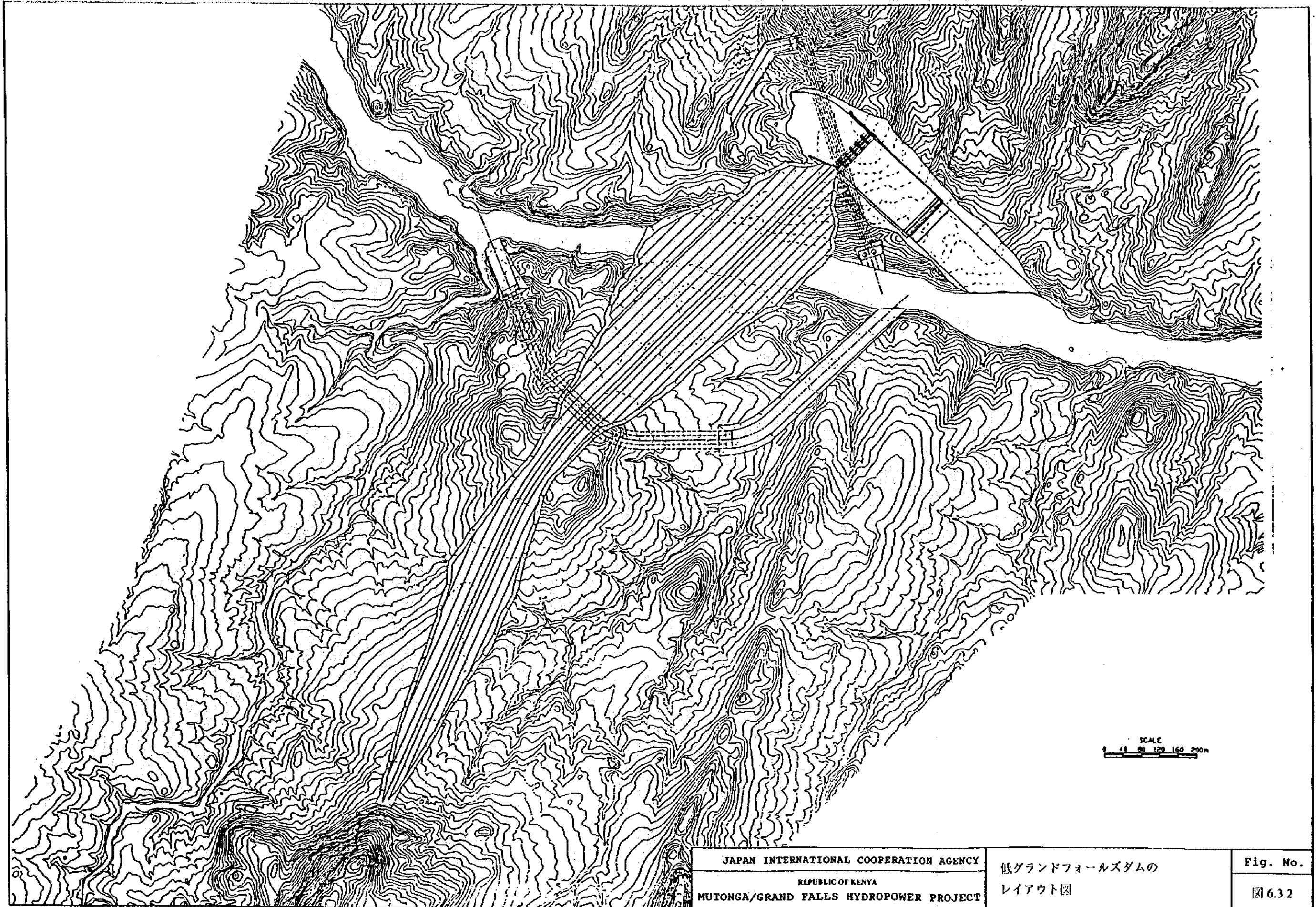

JAPAN INTERNATIONAL COOPERATION AGENCY
 REPUBLIC OF KENYA
 MUTONGA/GRAND FALLS HYDROPOWER PROJECT

低グランドフォールズダムの
 レイアウト図

Fig. No.
 図 6.3.2

SCALE
 0 40 80 120 160 200m

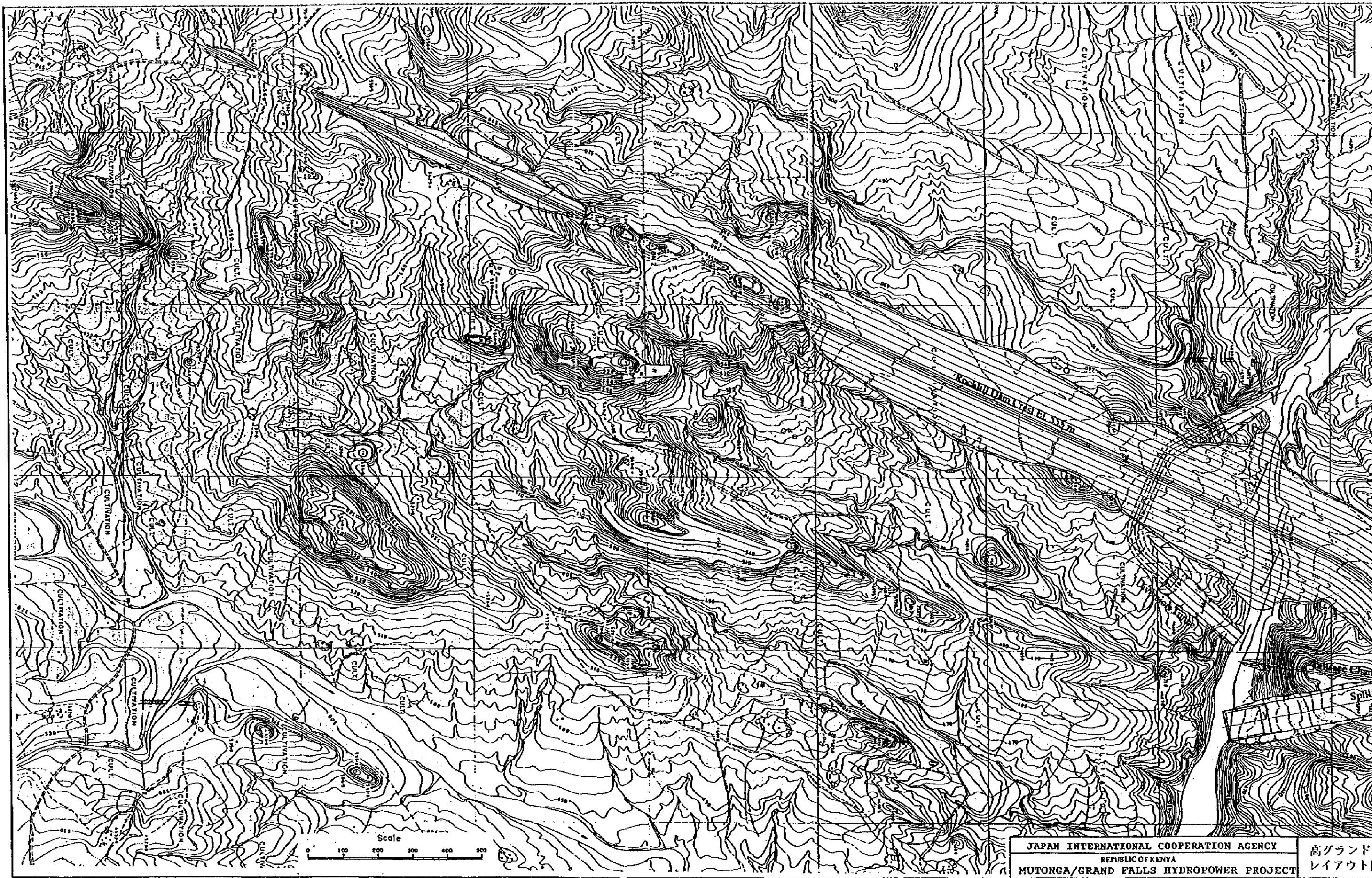

JAPAN INTERNATIONAL COOPERATION AGENCY
REPUBLIC OF KENYA
MUTONGA/GRAND FALLS HYDROPOWER PROJECT

高グランド
レイアウト

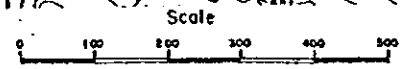
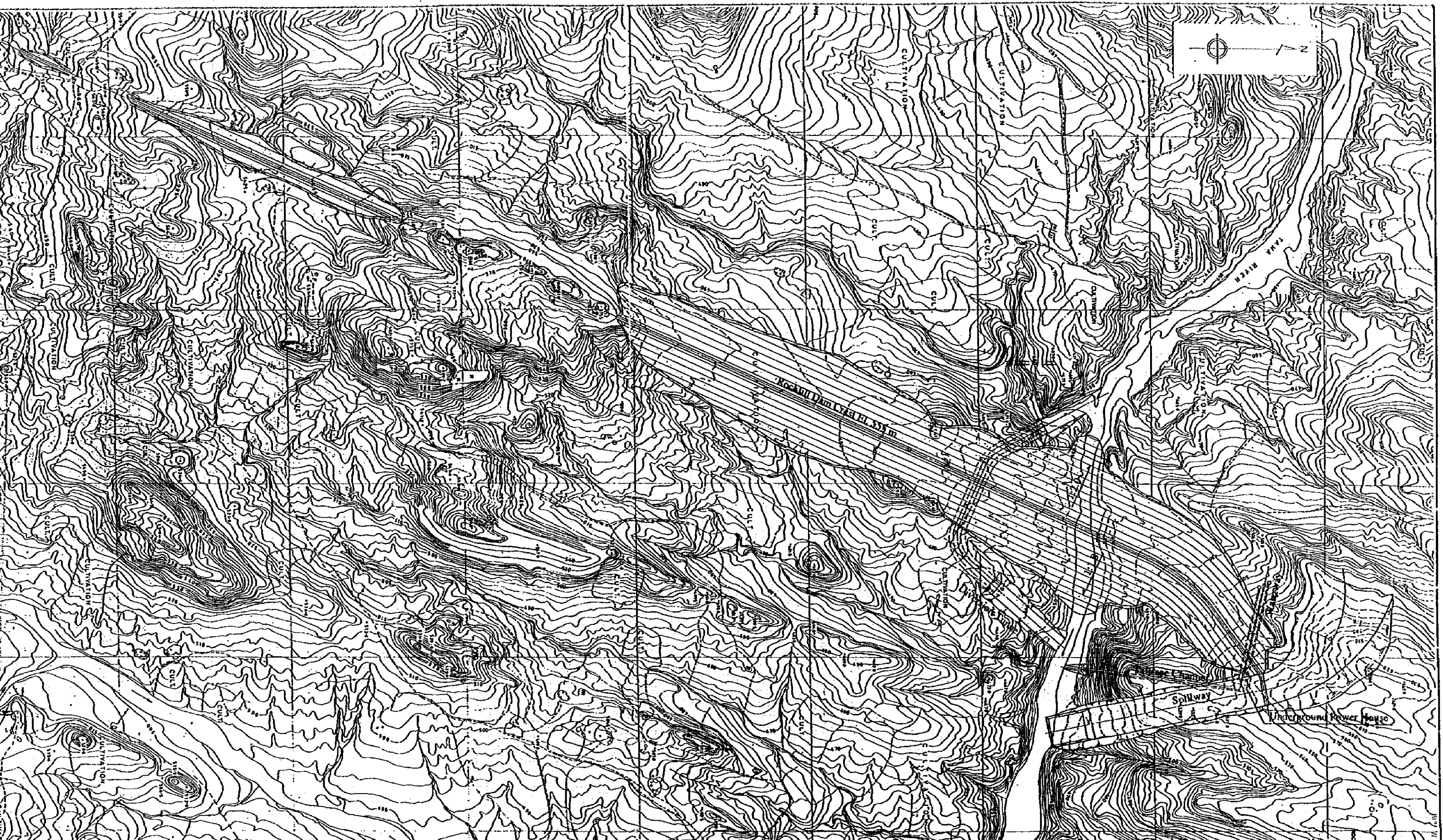

JAPAN INTERNATIONAL COOPERATION AGENCY REPUBLIC OF KENYA MUTONGA/GRAND FALLS HYDROPOWER PROJECT	高グランドフォールズダムの レイアウト図	Fig. No. 図 6.3.3
---	-------------------------	---------------------

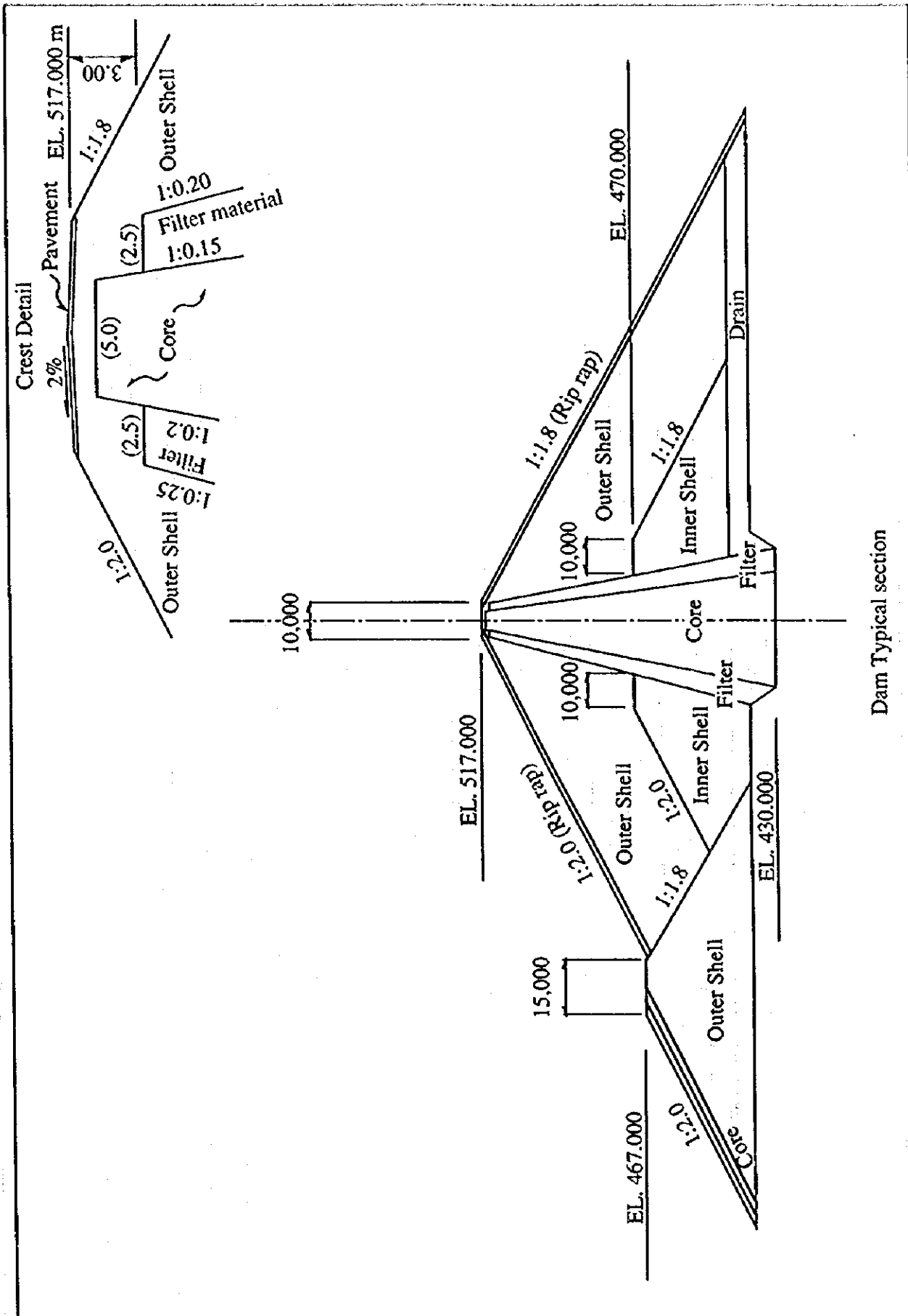

Dam Typical section

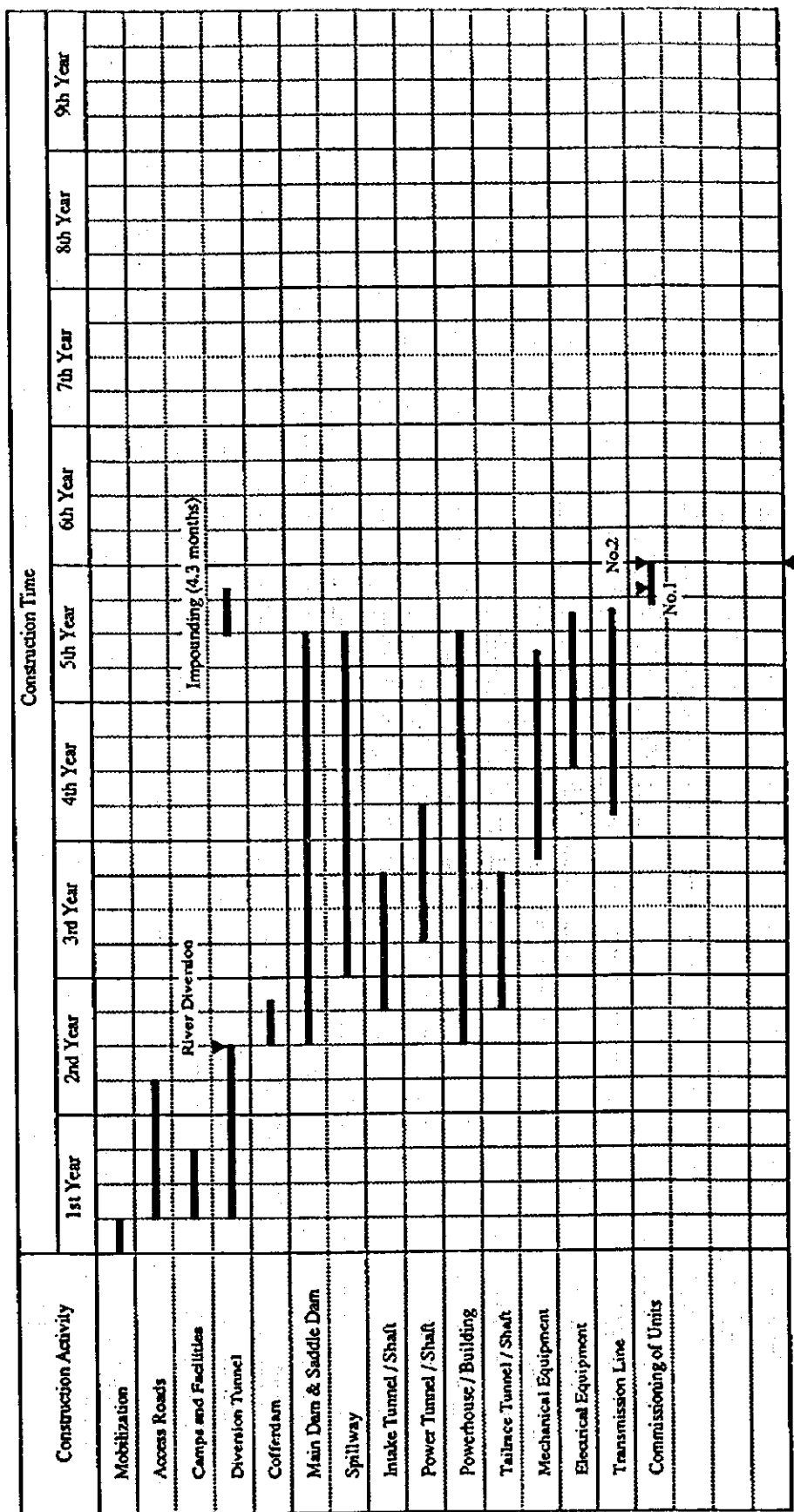

Commissioning

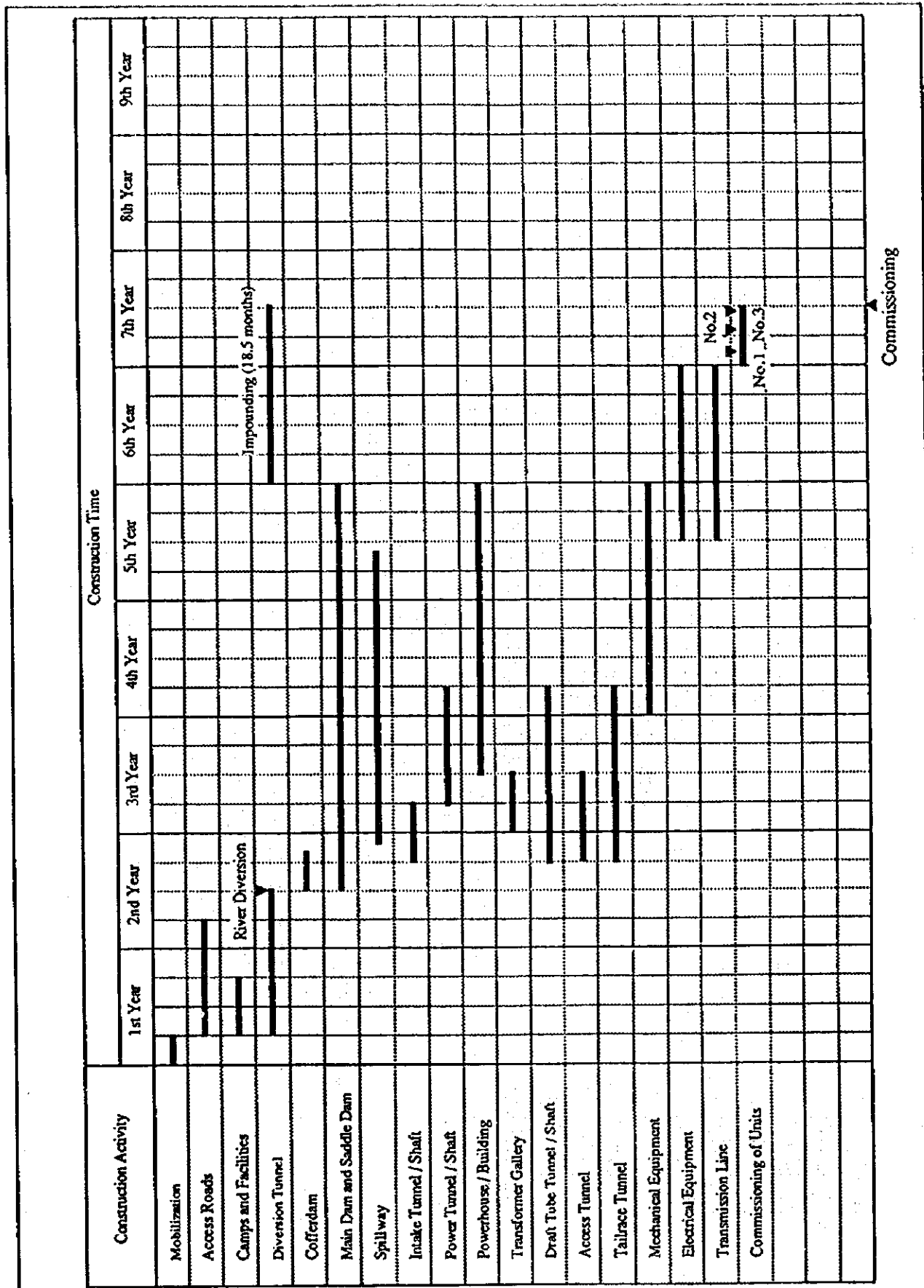

Commissioning

JAPAN INTERNATIONAL COOPERATION AGENCY
 REPUBLIC OF KENYA
 MUTONGA/GRAND FALLS HYDROPOWER PROJECT

高グランドフォールズダムの工程表

Fig. No.
 図 6.3.8



Source : National Water Master Plan 1992, JICA





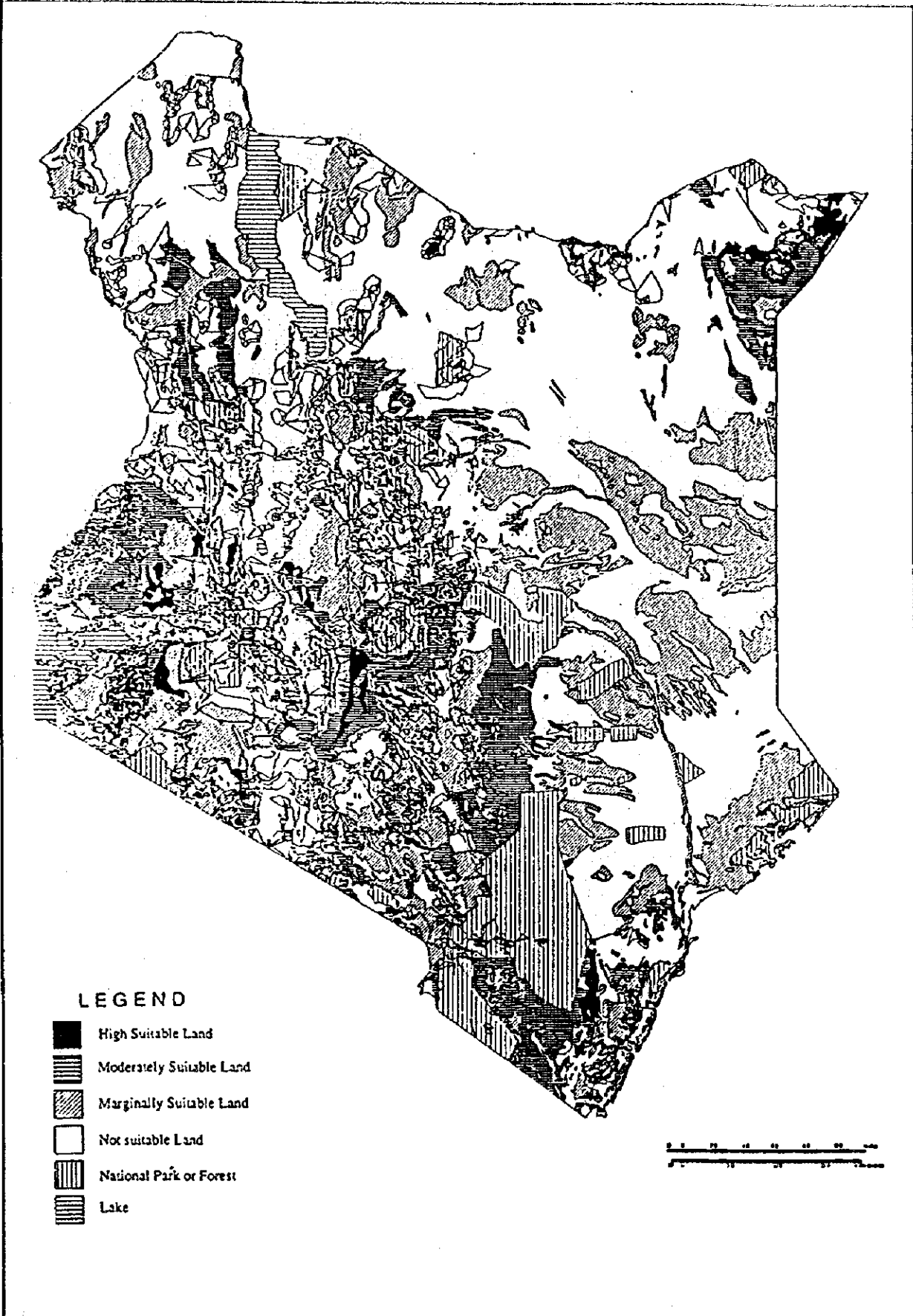

JAPAN INTERNATIONAL COOPERATION AGENCY
 REPUBLIC OF KENYA
 MUTONGA/GRAND FALLS HYDROPOWER PROJECT

低地作物の灌漑ポテンシャル

Fig. No.
 図 6.3.9



LEGEND

-  High Suitable Land
-  Moderately Suitable Land
-  Marginally Suitable Land
-  Not suitable Land
-  National Park or Forest
-  Lake



Source : National Water Master Plan 1992, JICA

JAPAN INTERNATIONAL COOPERATION AGENCY
 REPUBLIC OF KENYA
 MUTONGA/GRAND FALLS HYDROPOWER PROJECT

高地作物の灌漑ポテンシャル

Fig. No.
 図 6.3.10

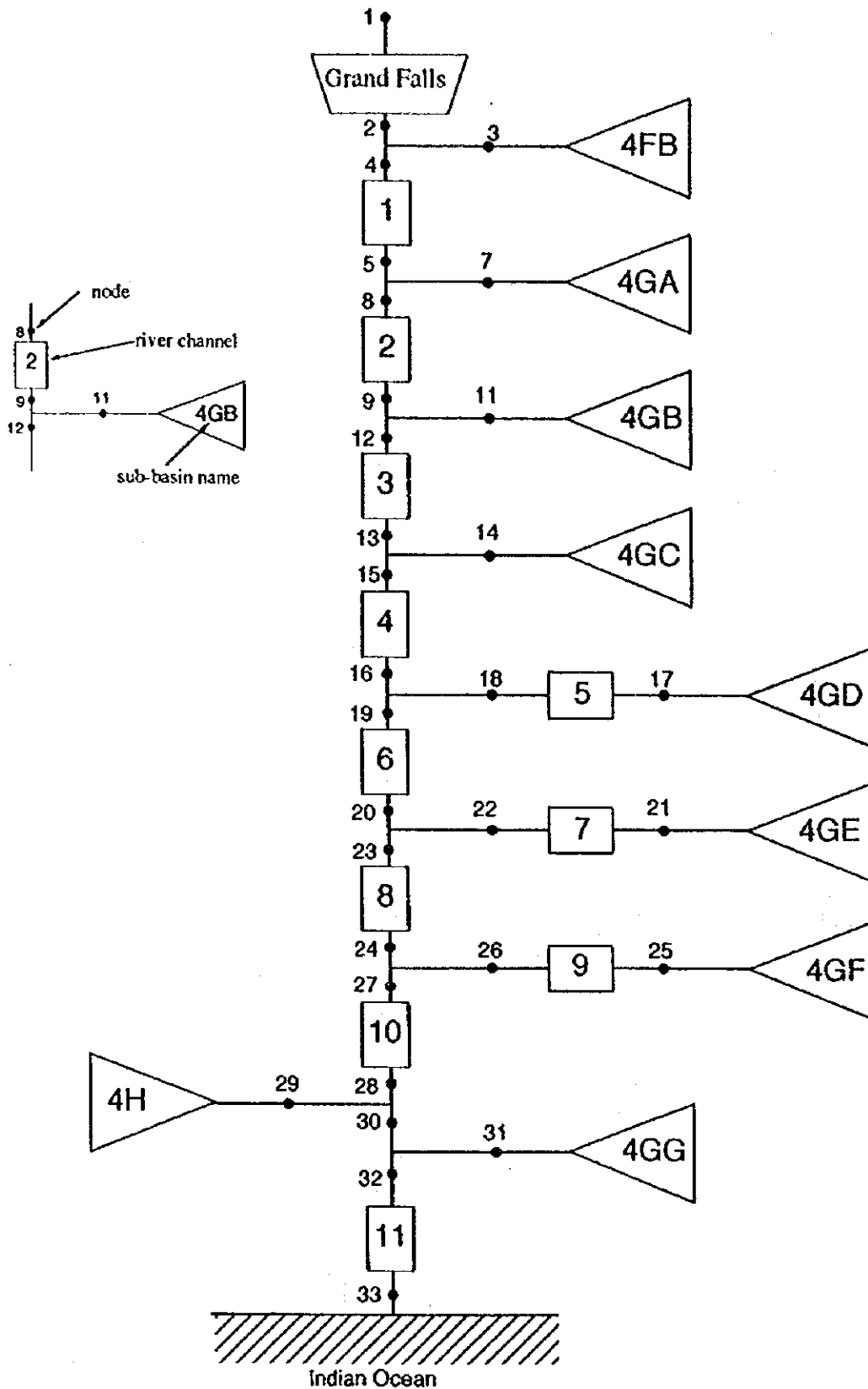

Source : National Water Master Plan 1992, JICA

JAPAN INTERNATIONAL COOPERATION AGENCY
 REPUBLIC OF KENYA
 MUTONGA/GRAND FALLS HYDROPOWER PROJECT

タナ川下流域の流域モデル

Fig. No.
 図 6.3.11

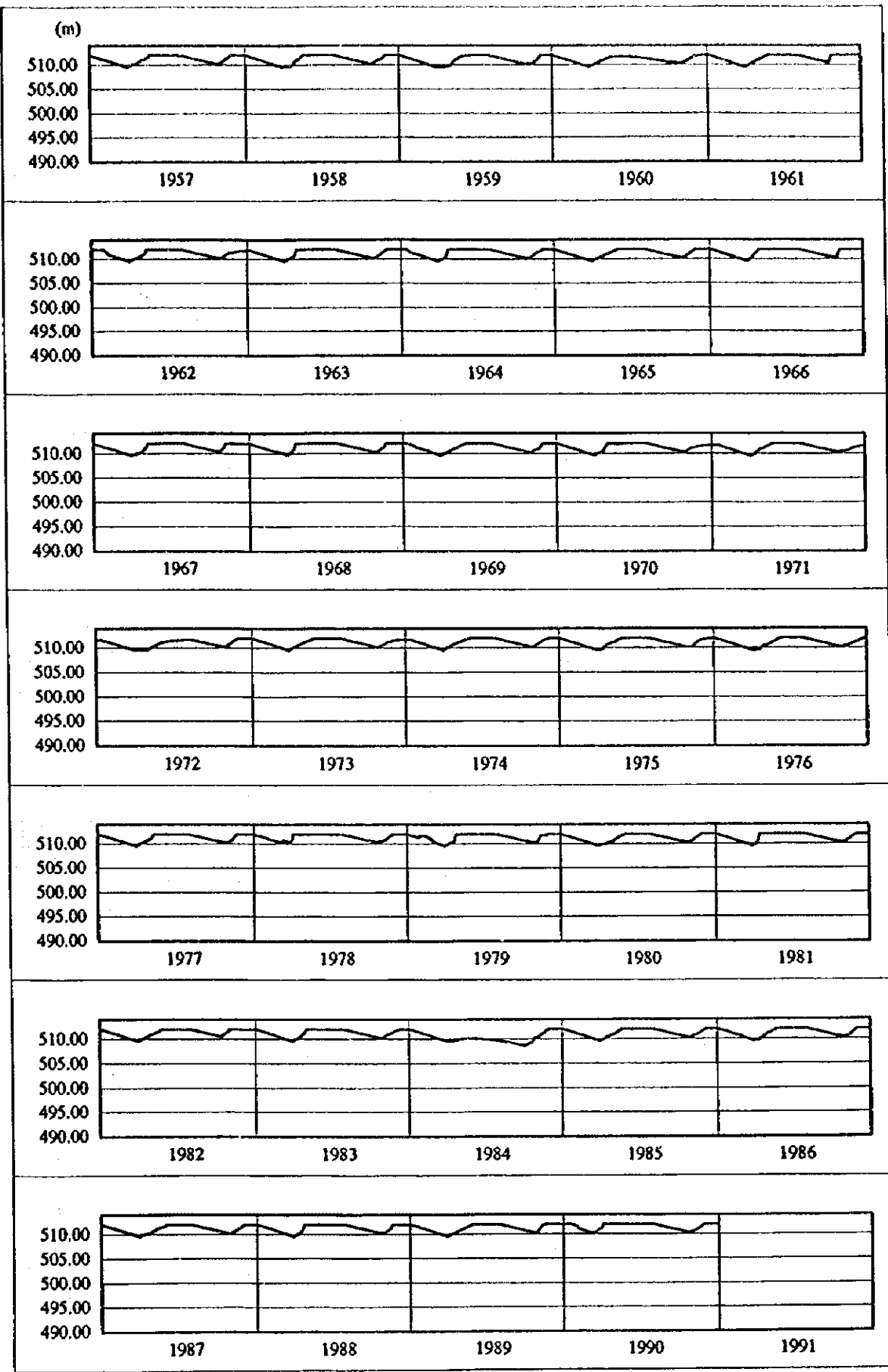

JAPAN INTERNATIONAL COOPERATION AGENCY
 REPUBLIC OF KENYA
 GRANDFALLS/MUTONGA HYDROPOWER PROJECT

低グランドフォールズダム
 発電操作による貯水池水位

Fig. No.
 図 6.3.12

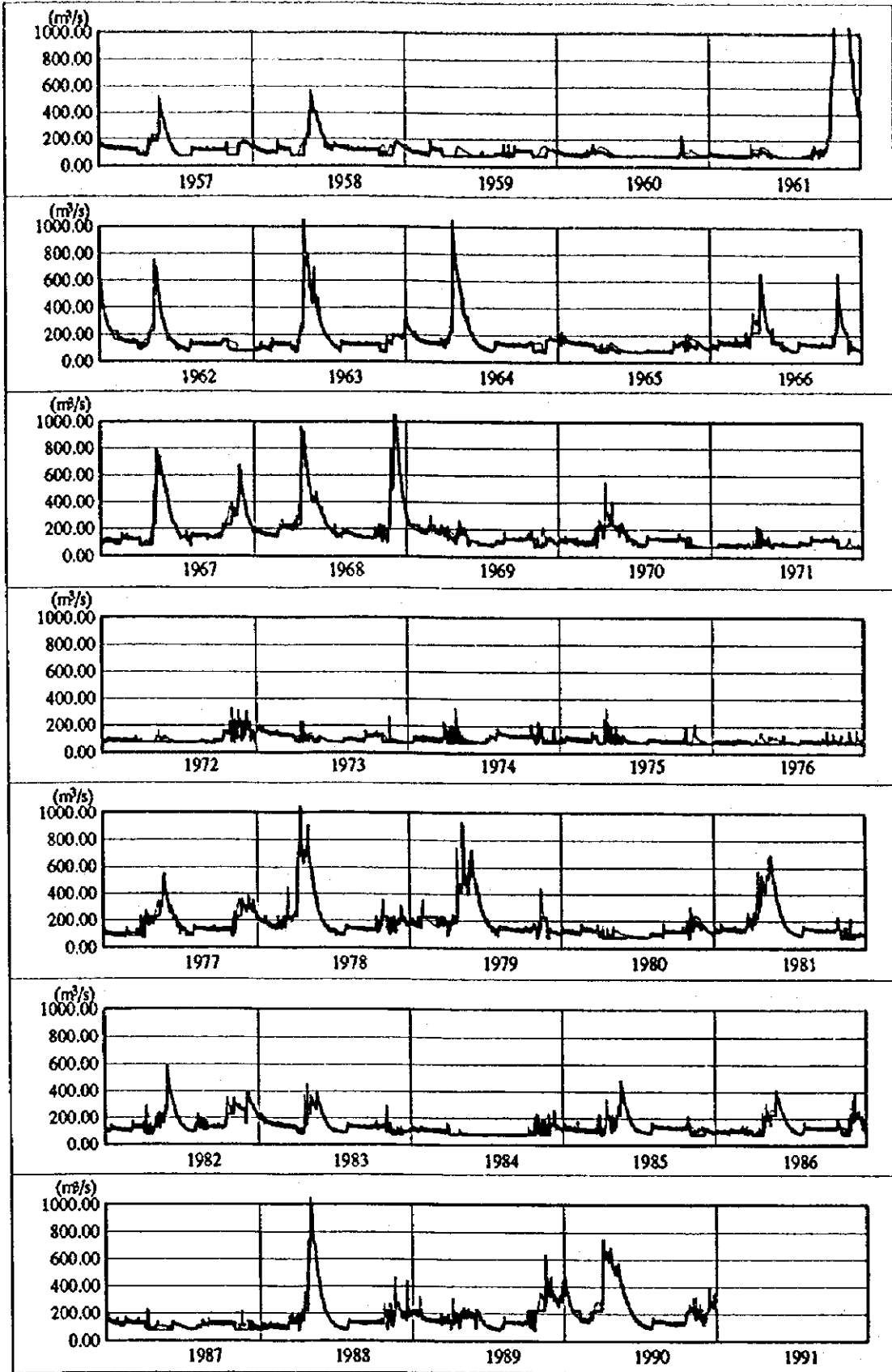

— Inflow
 — Outflow

JAPAN INTERNATIONAL COOPERATION AGENCY
 REPUBLIC OF KENYA
 GRANDFALLS/MUTONGA HYDROPOWER PROJECT

低グランドフォールズダム
 発電操作による流出量

Fig. No.
 図 6.3.13

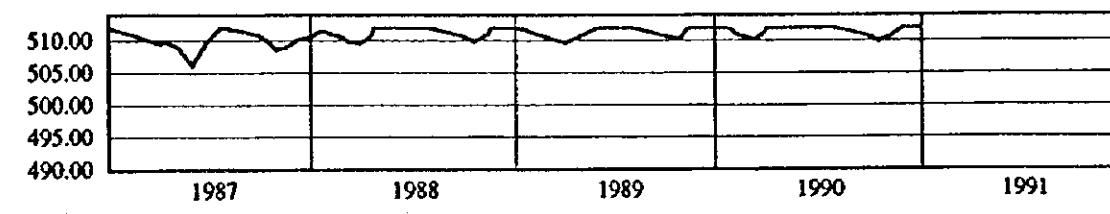
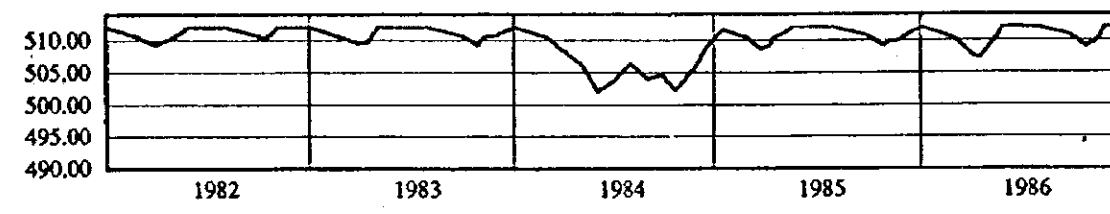
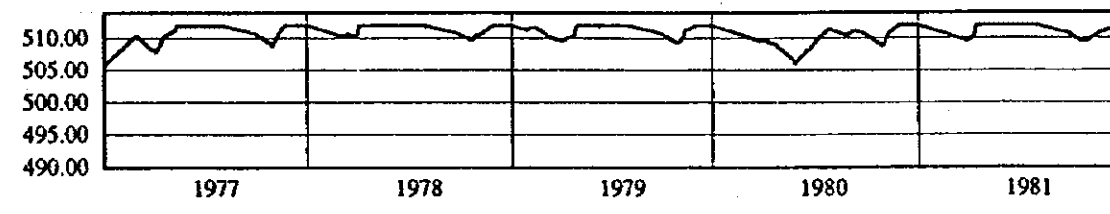
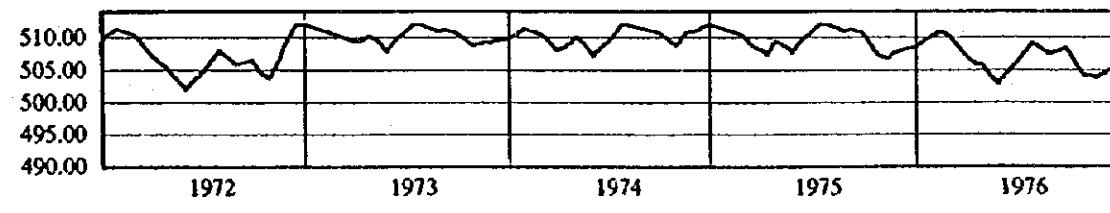
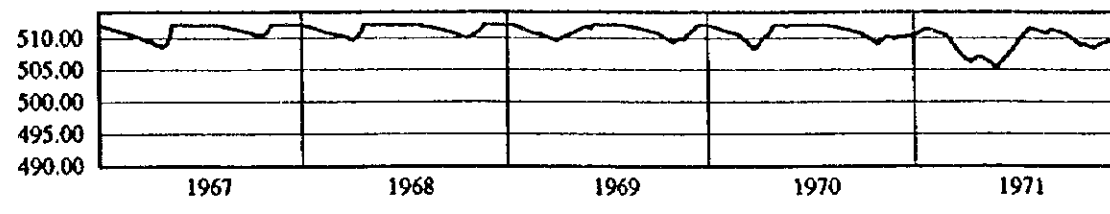
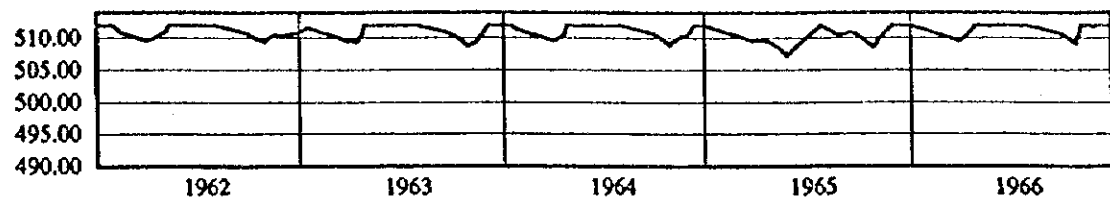
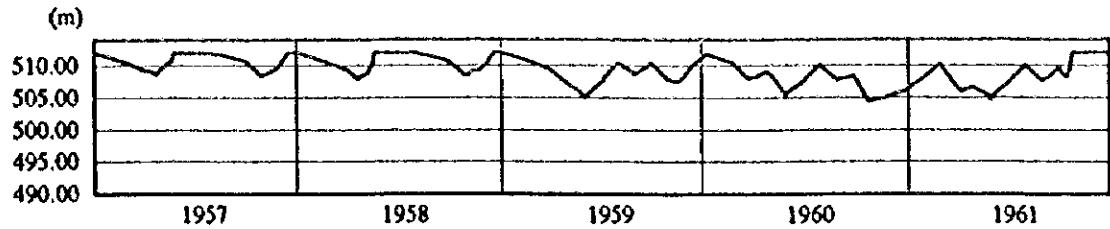

JAPAN INTERNATIONAL COOPERATION AGENCY
 REPUBLIC OF KENYA
 GRANDFALLS/MUTONGA HYDROPOWER PROJECT

低グランドフォールズダム
 灌漑操作による貯水池水位

Fig. No.
 図 6.3.14

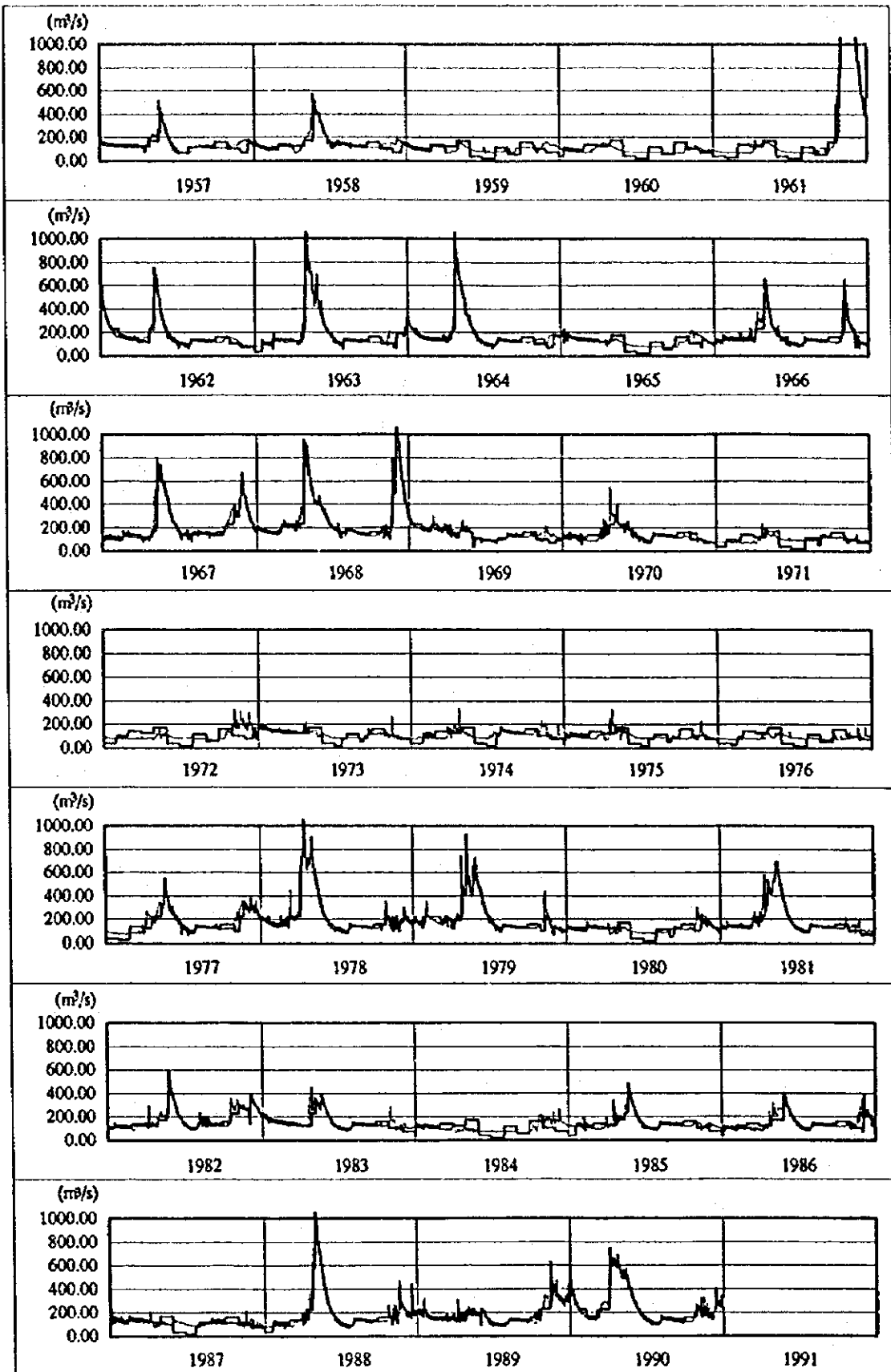

— Inflow
 — Outflow

JAPAN INTERNATIONAL COOPERATION AGENCY
 REPUBLIC OF KENYA
 GRANDFALLS/MUTONGA HYDROPOWER PROJECT

低グランドフォールズダム
 灌漑操作による流出量

Fig. No.
 図 6.3.15

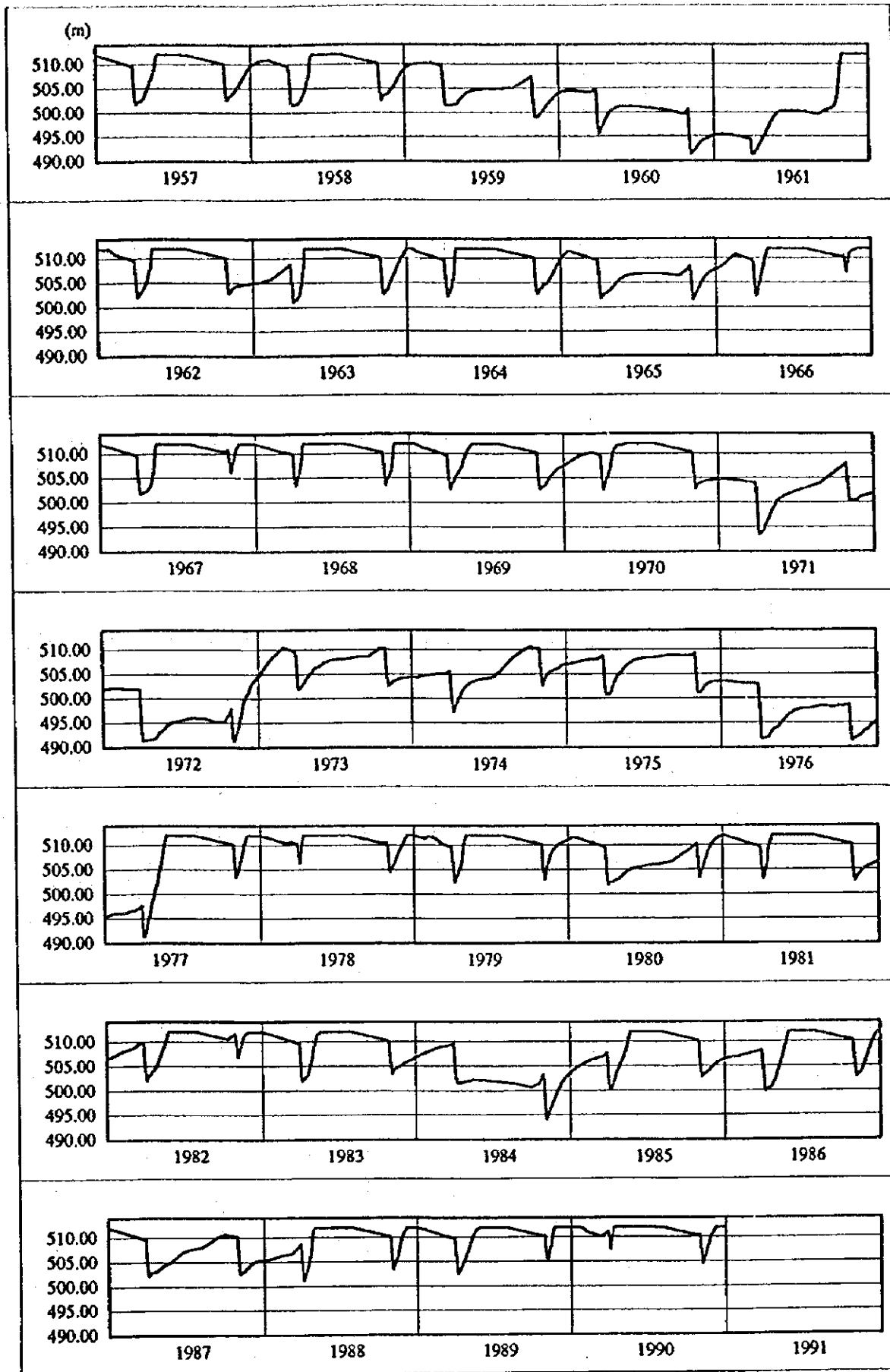

JAPAN INTERNATIONAL COOPERATION AGENCY
 REPUBLIC OF KENYA
 GRANDFALLS/MUTONGA HYDROPOWER PROJECT

低ランドフォールズダム
 洪水操作による貯水池水位

Fig. No.
 図 6.3.16

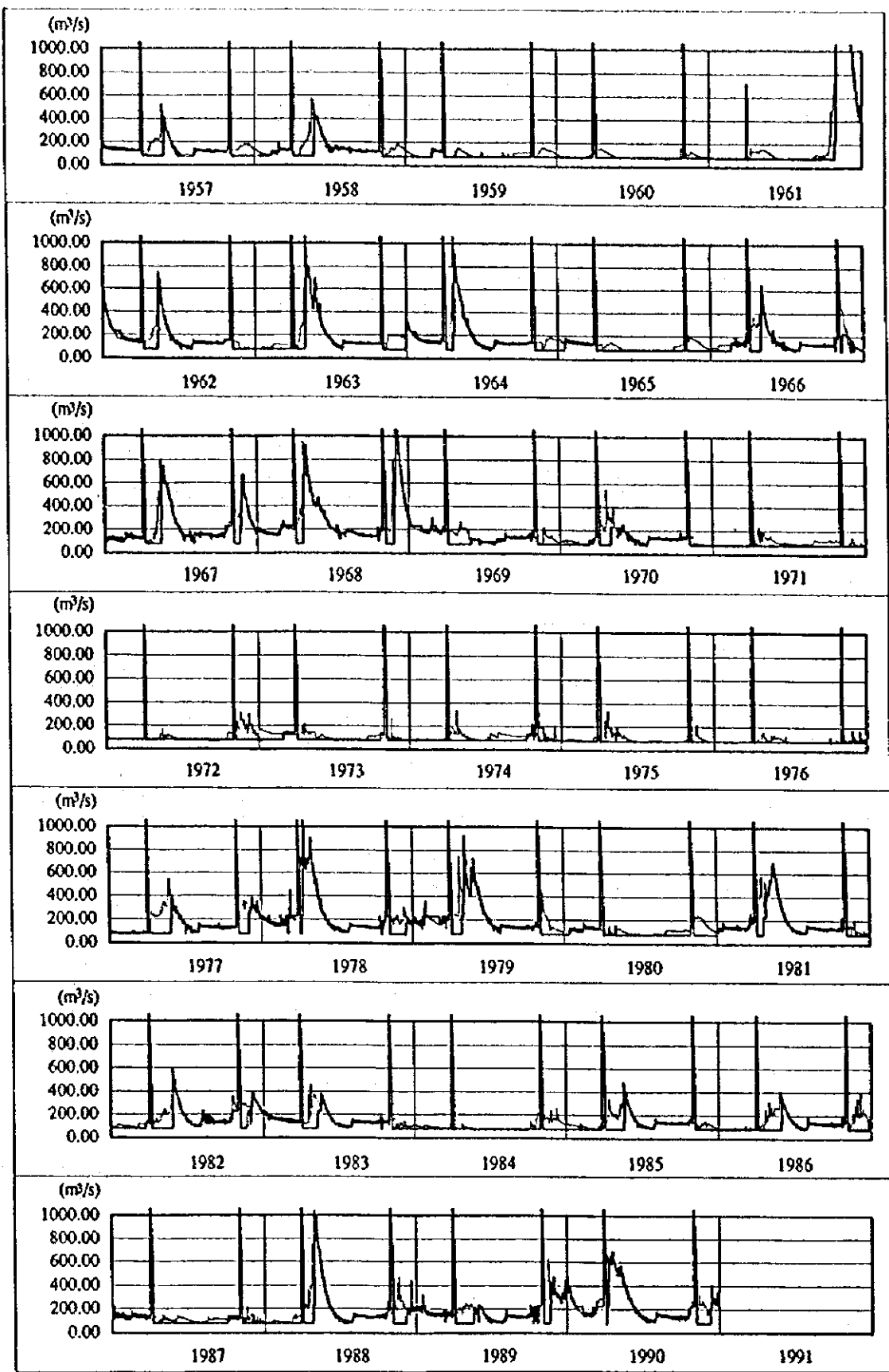

— Inflow
 — Outflow

JAPAN INTERNATIONAL COOPERATION AGENCY
 REPUBLIC OF KENYA
 GRANDFALLS/MUTONGA HYDROPOWER PROJECT

低グランドフォールズダム
 洪水操作による流出量

Fig. No.
 図 6.3.17