

INVENTORY OF PAVEMENT SURFACE CONDITION

Km. 1262 + 000

Date: 10-14-95

Sheet No: 1/2

☒ KP 1262 + 000

										Po											

		De									Po	Po	De	De							

Po	Po										Po	Po	Po	Po							

Po	De	OL	OL		Mambutay Br.		OL	OL	Po			Sc	Sc	Sc						

INVENTORY OF PAVEMENT SURFACE CONDITION

Km. 1262 + 000

Date: 10-14-95

Sheet No: 2/2

Sc											—				

	—		Sc	Sc	Po			Po					}		

							Po								

		Oph								Sc					
											Po				

Crack

									Sc						

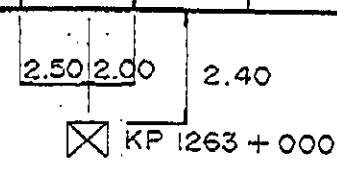

INVENTORY OF PAVEMENT SURFACE CONDITION

Km. 1262 + 000

Date : 10-14-95

Sheet No : 2/2

Sc																				

			Sc	Sc	Po			Po													

							Po														

		Oph									Sc										

Crack

										Sc											

2.50 | 2.00 | 2.40

☒ KP 1263 + 000

INVENTORY OF PAVEMENT SURFACE CONDITION

Km. 1263 + 000

Date: 10-15-95

Sheet No: 2/2

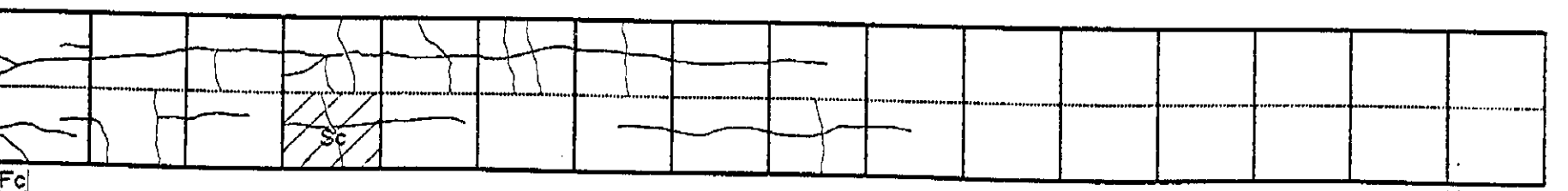
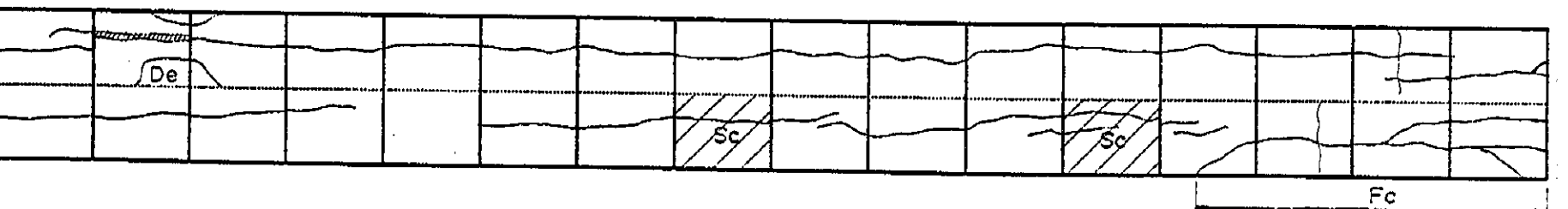
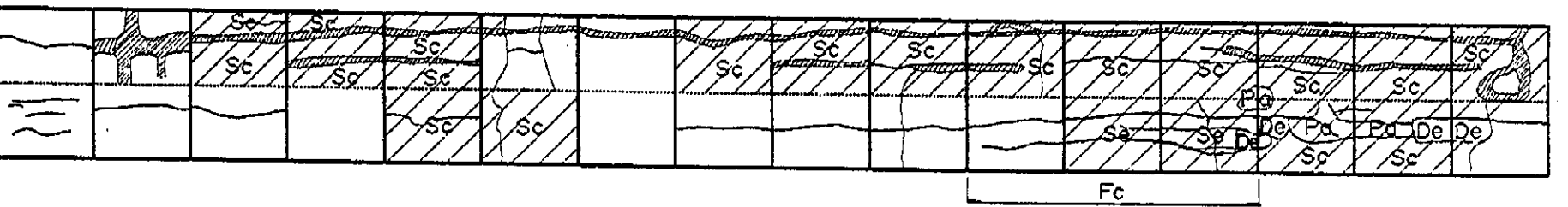
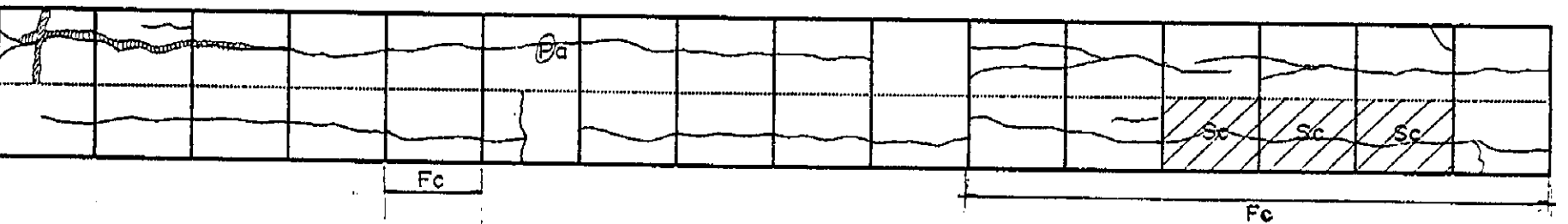
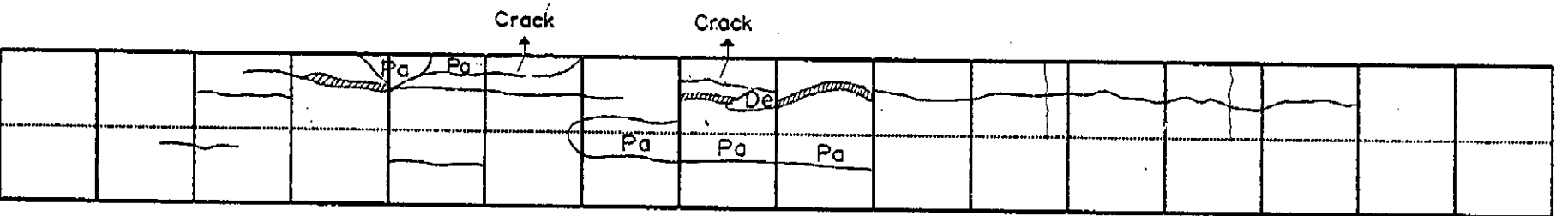
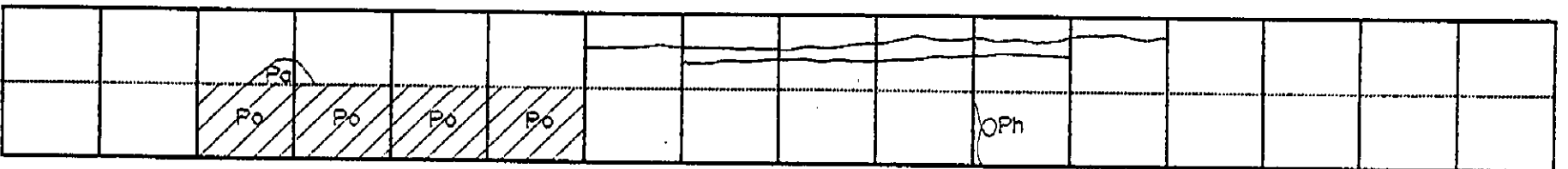
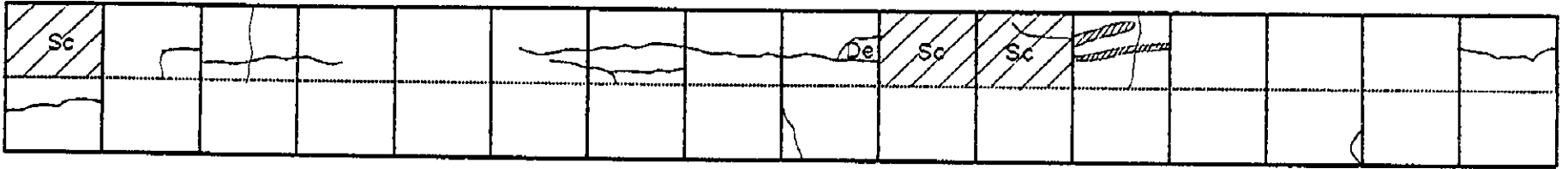

0.60 3.00

INVENTORY OF PAVEMENT SURFACE CONDITION

Km. 1263 +000

Date: 10-15-95

Sheet No: 2/2

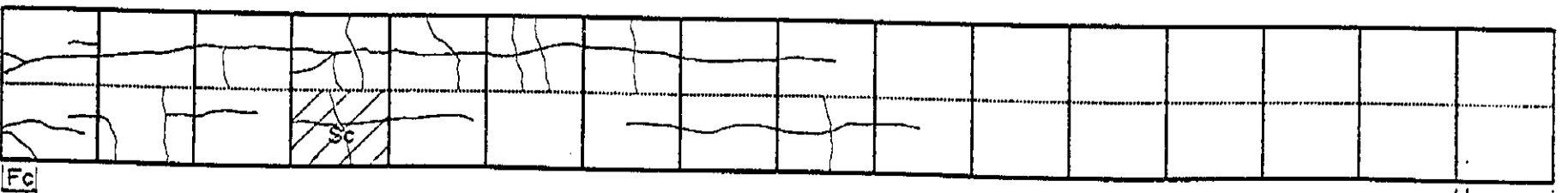
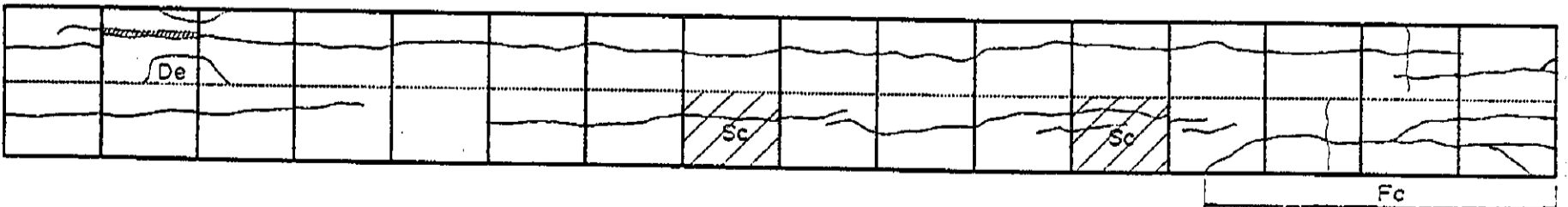
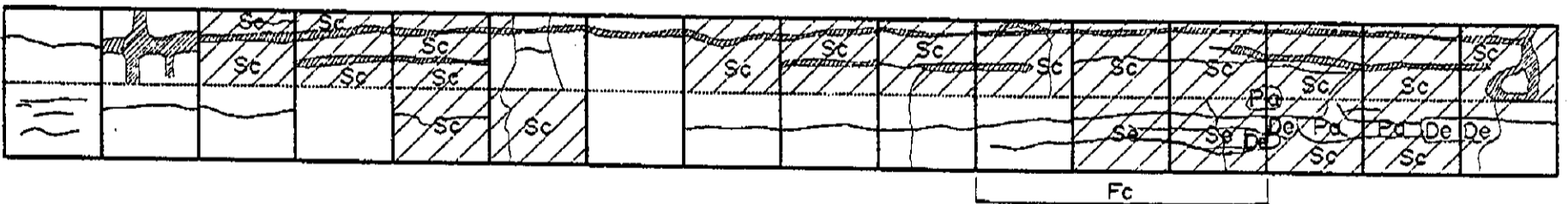
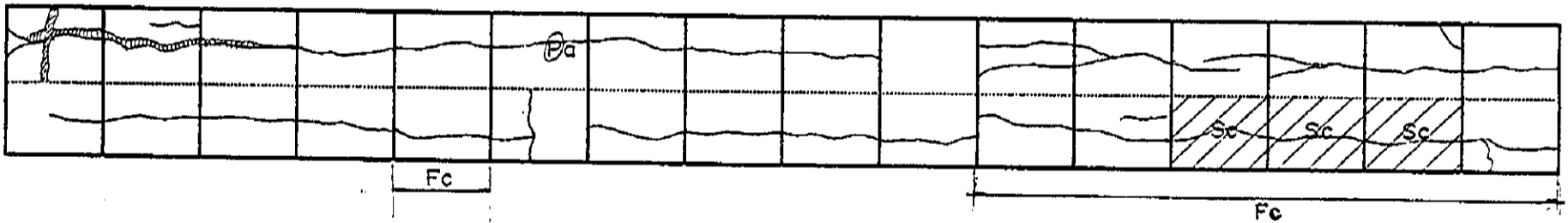
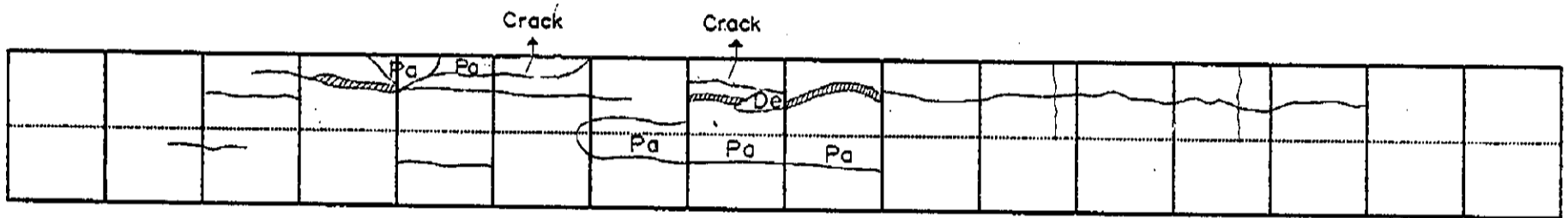
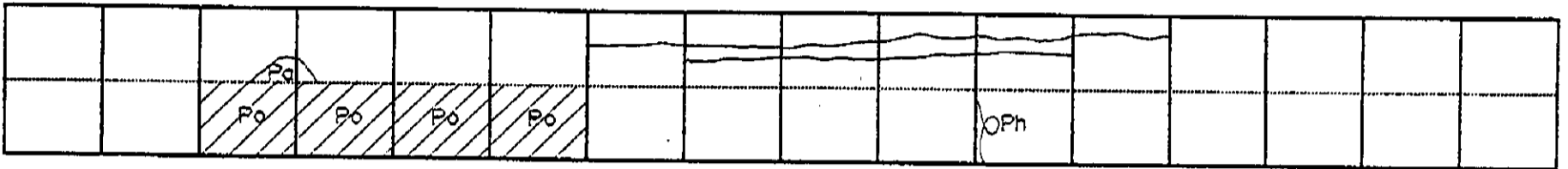
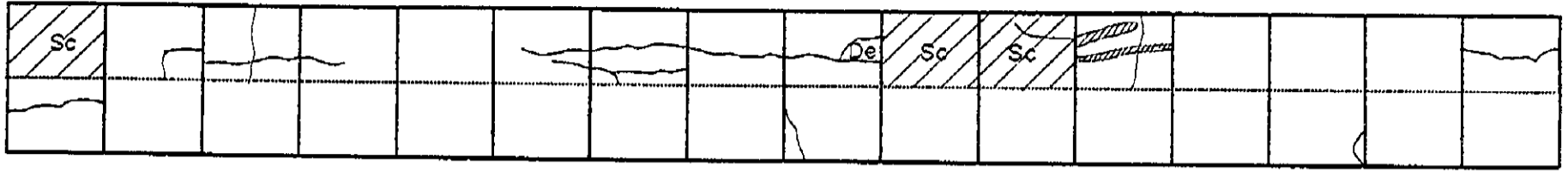

0.60 3.00

INVENTORY OF PAVEMENT SURFACE CONDITION

Km. 1264 + 000

Date: 10-15-95

Sheet No: 2/2

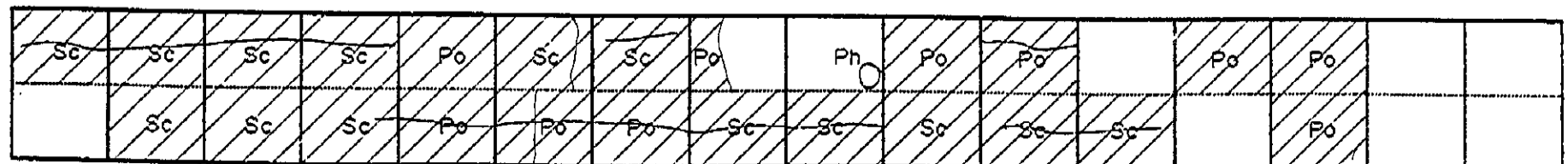
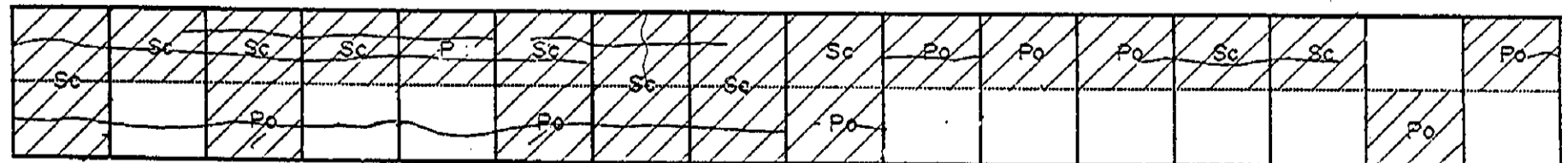
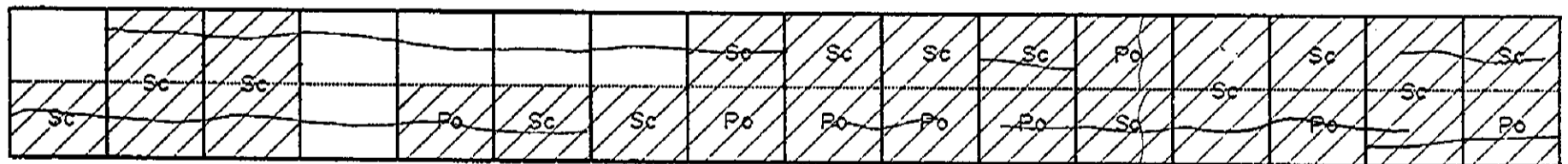
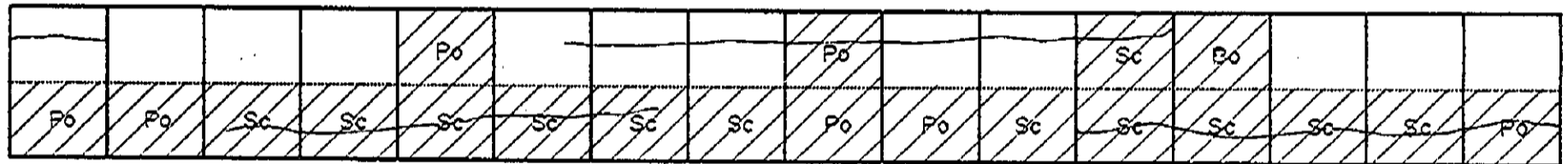
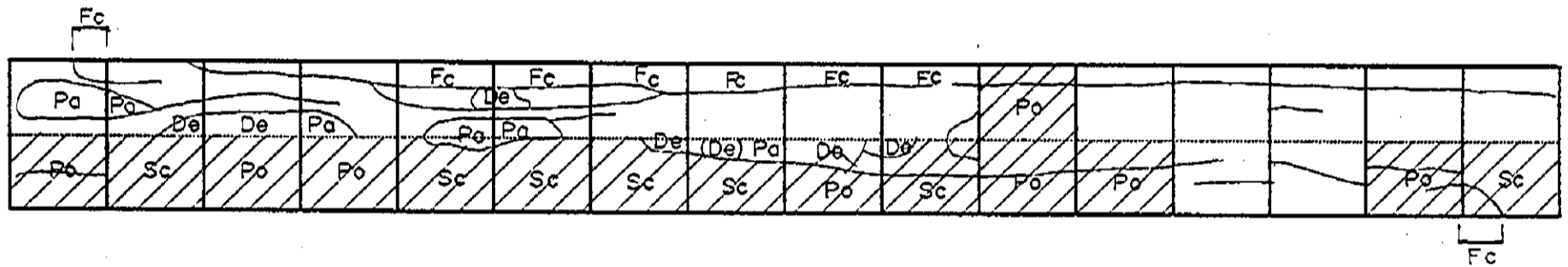
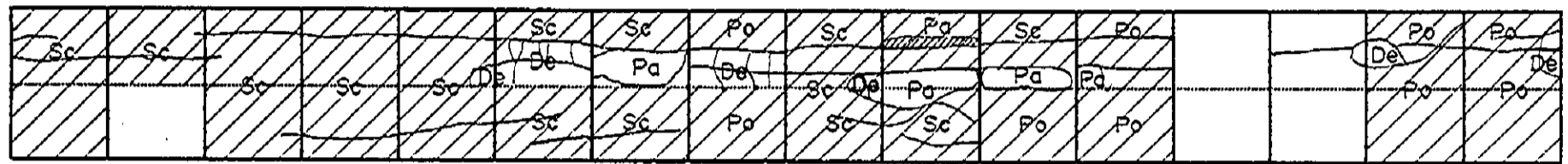
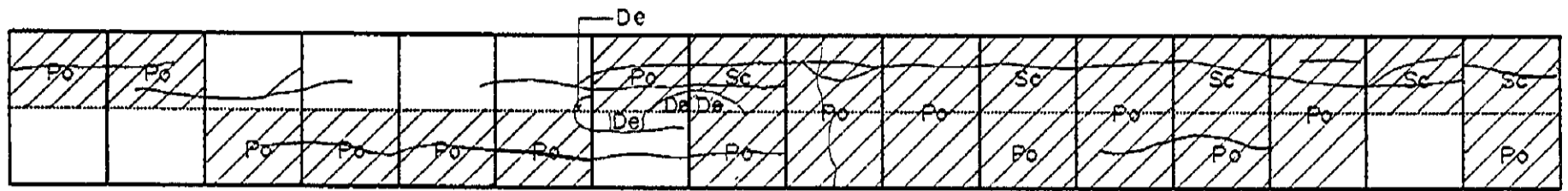

0.60 2.90

⊗ KP 1265 + 000

INVENTORY OF PAVEMENT SURFACE CONDITION

Date: 10-15-95

Km. 1265 + 000

Sheet No: 1/2

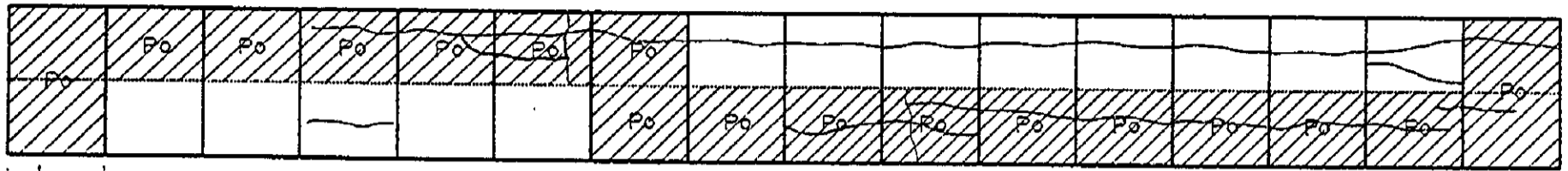

0.60 | 2.90

☒ KP 1265 + 000

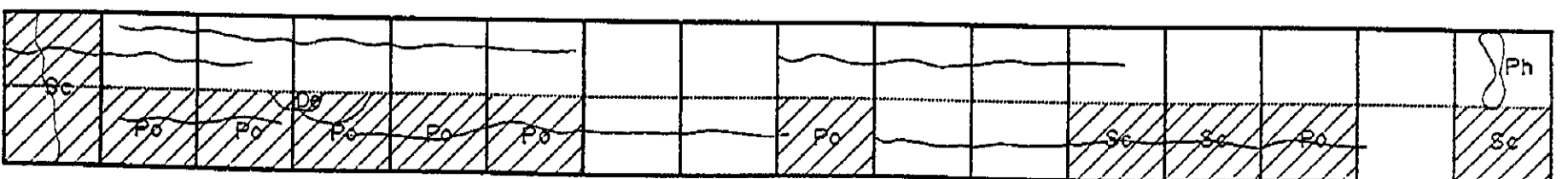
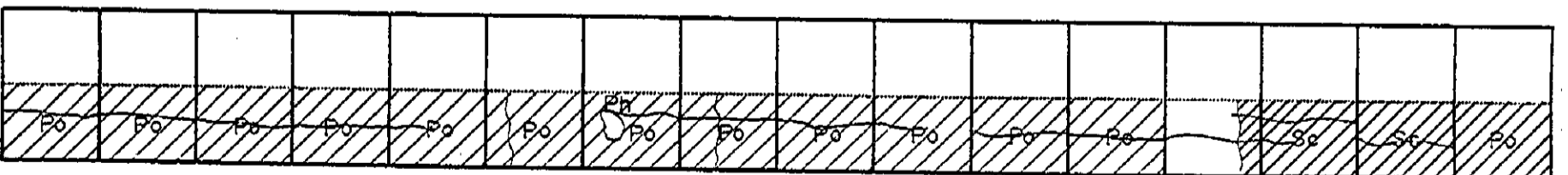
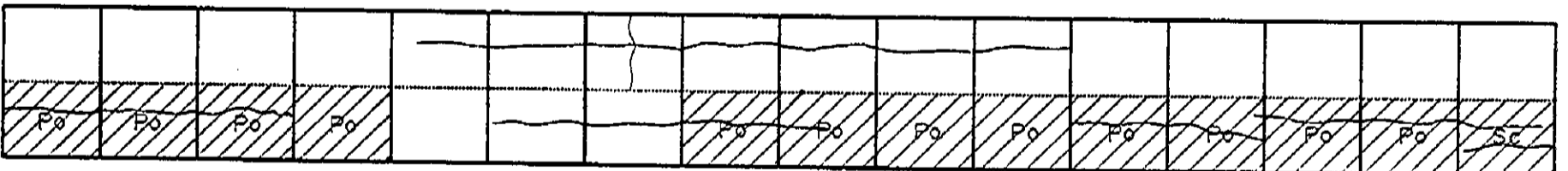
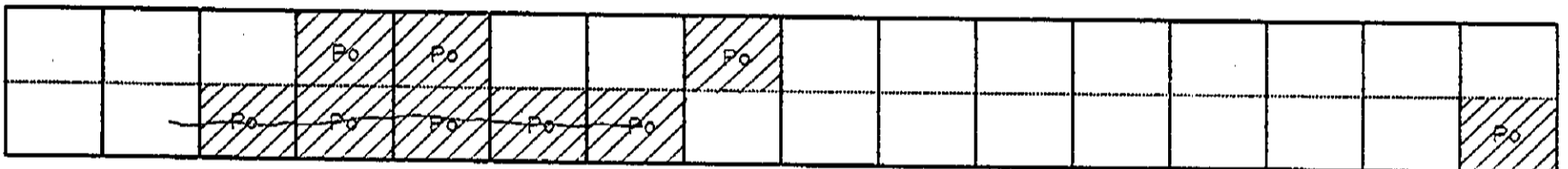
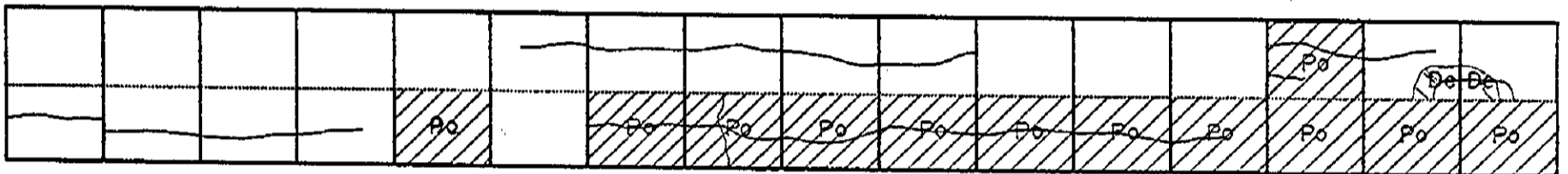
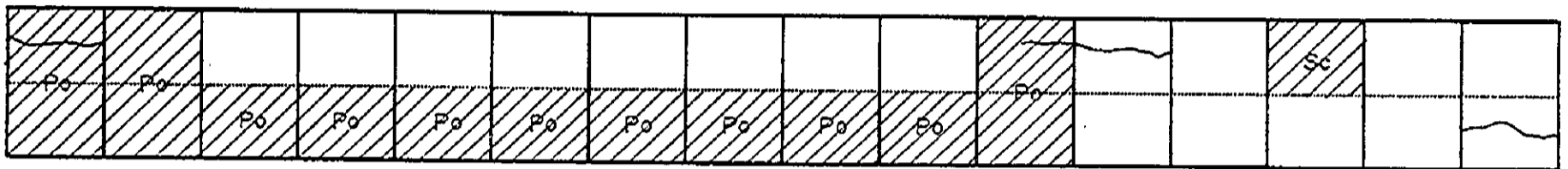

INVENTORY OF PAVEMENT SURFACE CONDITION

Km. 1265 + 000

Date: 10-15-95

Sheet No: 2/2

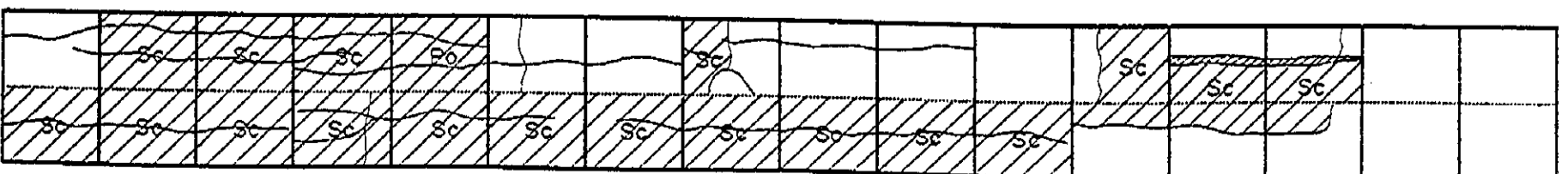
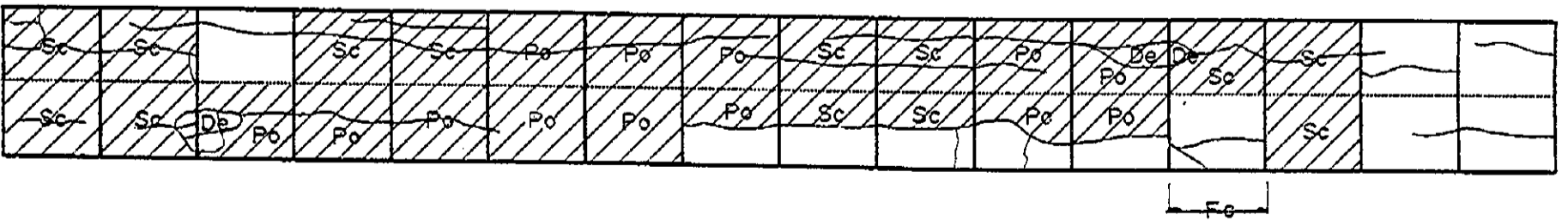
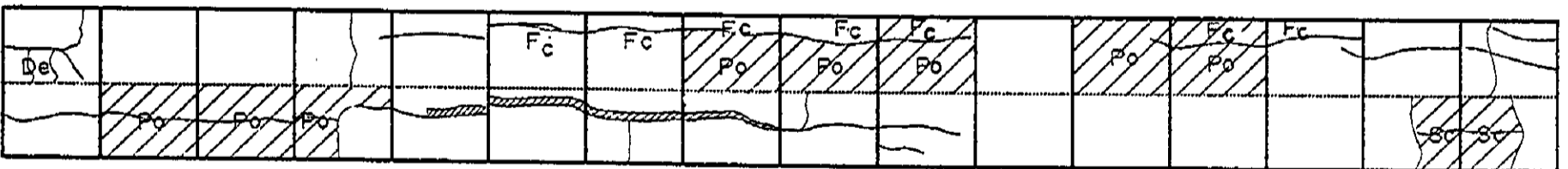
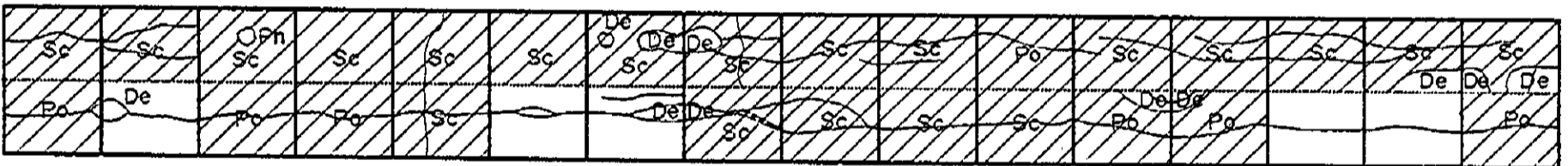
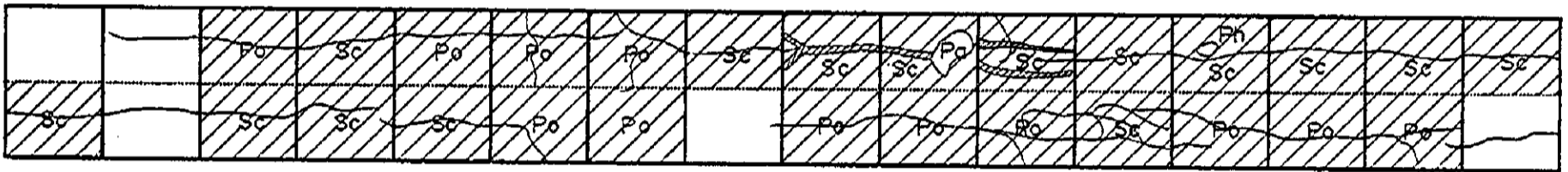
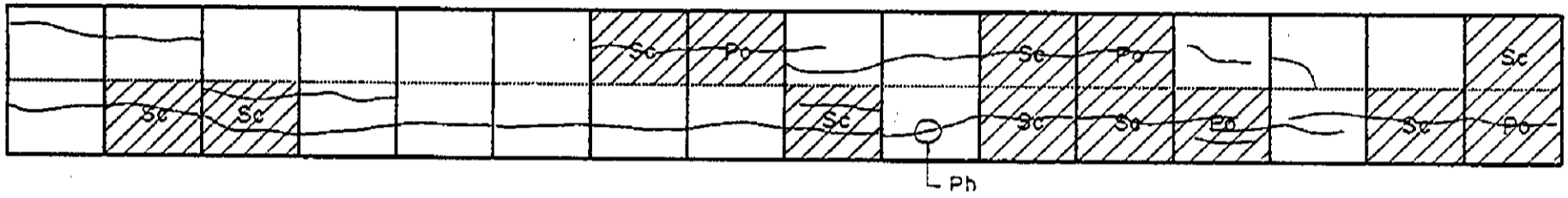
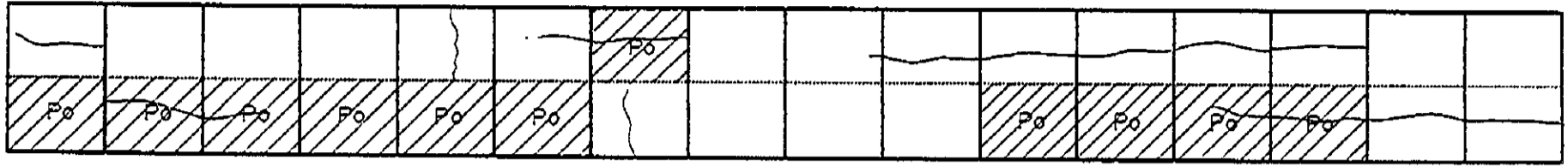

1.20 3.30

⊗ KP 1266 + 000

INVENTORY OF PAVEMENT SURFACE CONDITION

Date: 10-15-95

Km. 1266+000

Sheet No: 1/3

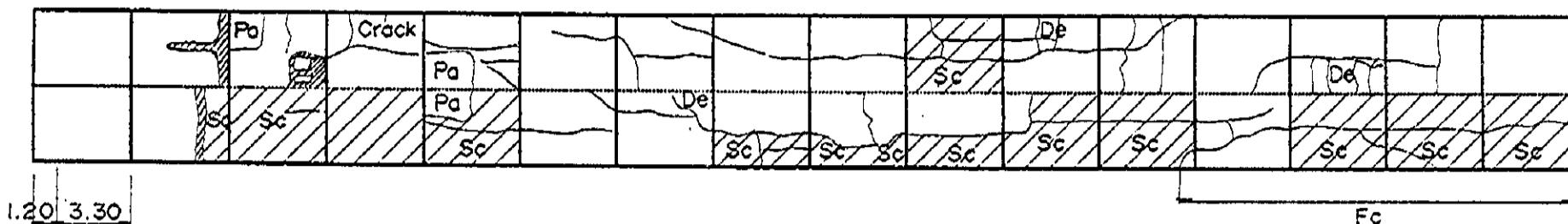

☒ KP 1266 + 000

3.70

Andanan Br.
L = 181.00 Lm.

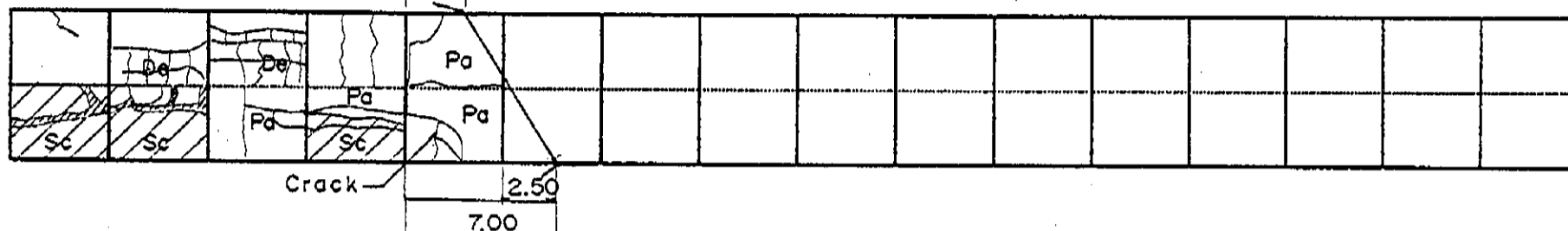

Andanan Br.
L = 181.00 Lm.

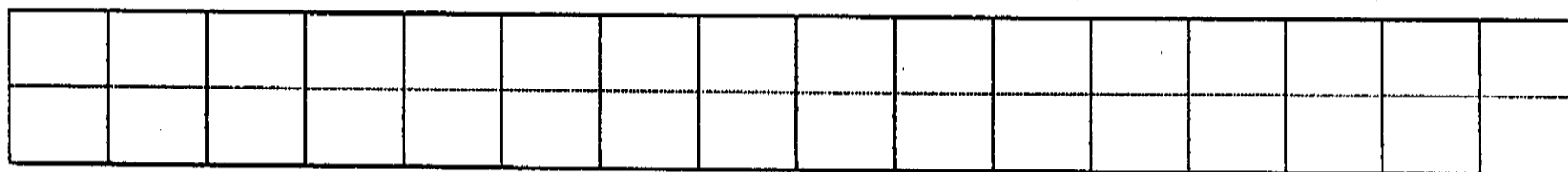

Andanan Br.
L = 181.00 Lm.

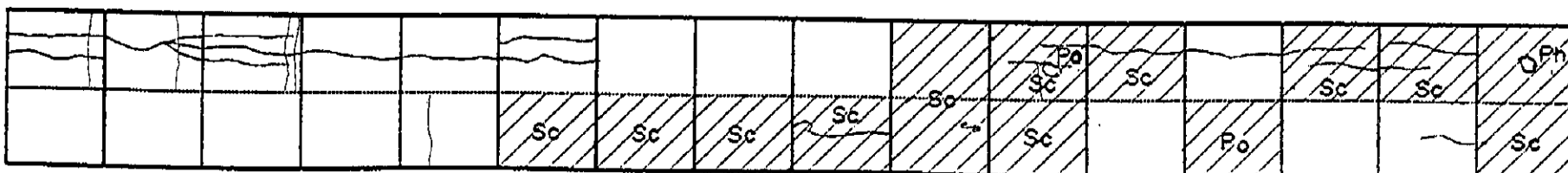
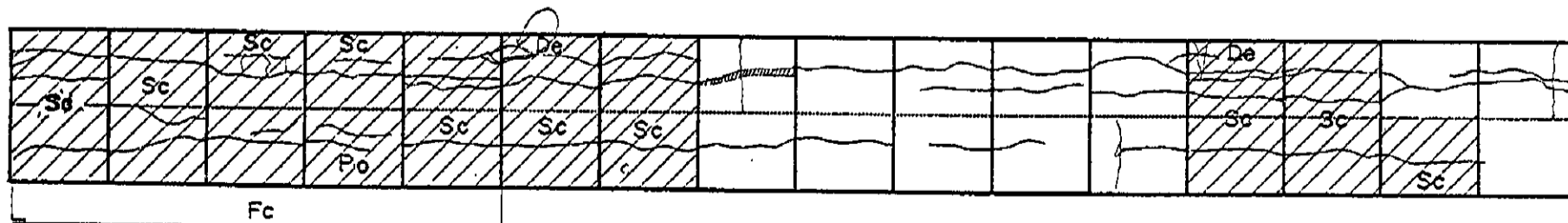
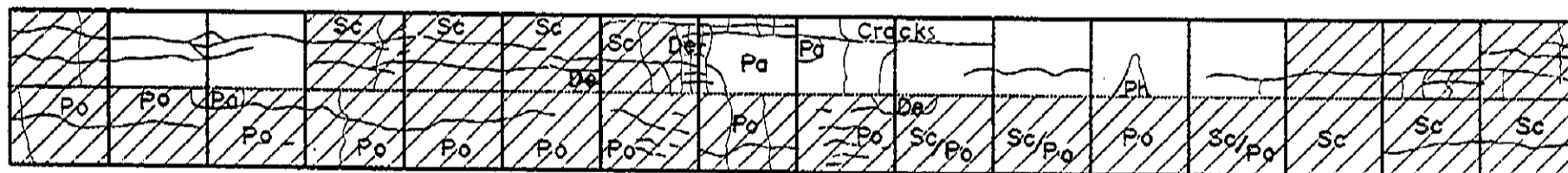
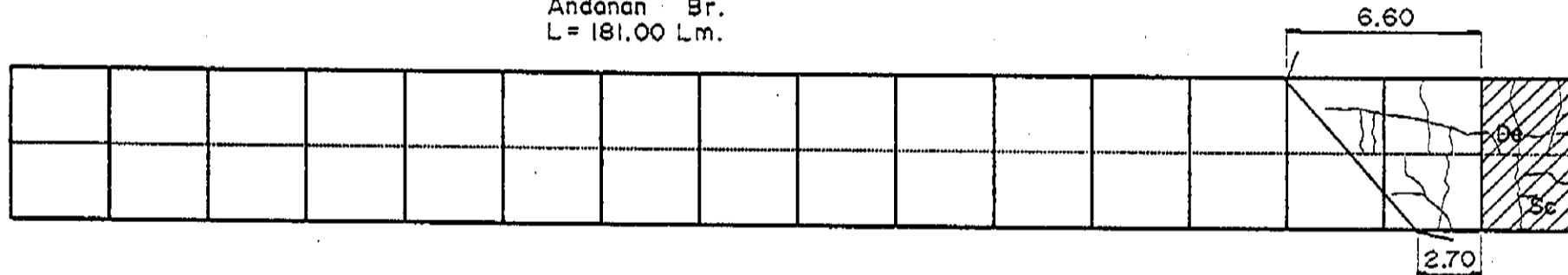

INVENTORY OF PAVEMENT SURFACE CONDITION

Km. 1266+000

Date: 10-18-95

Sheet No: 2/3

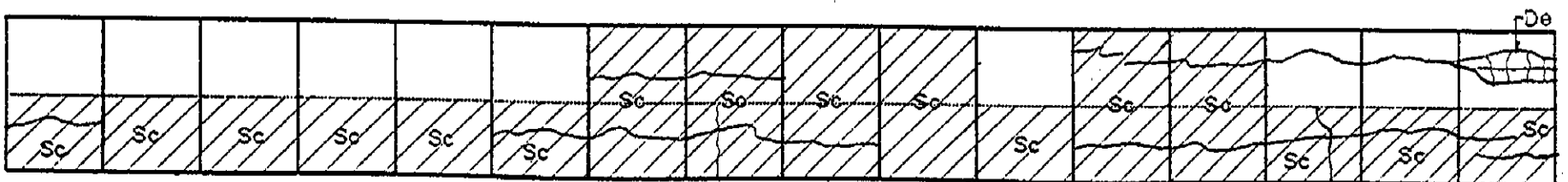
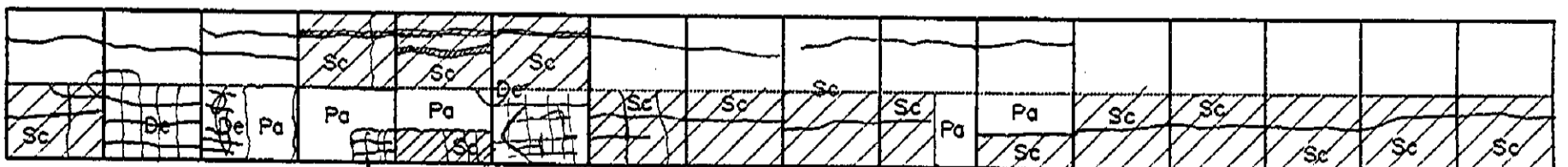
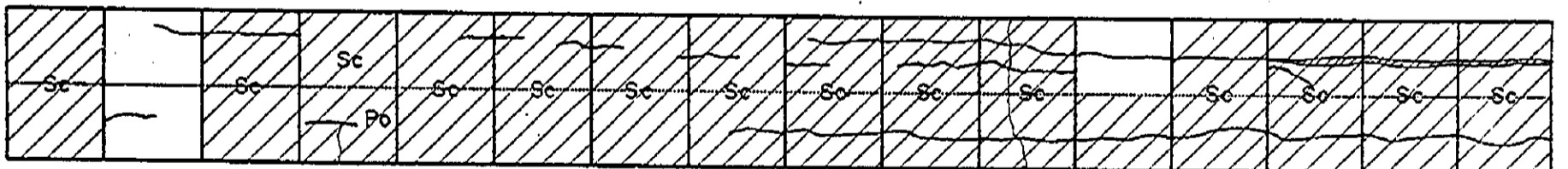
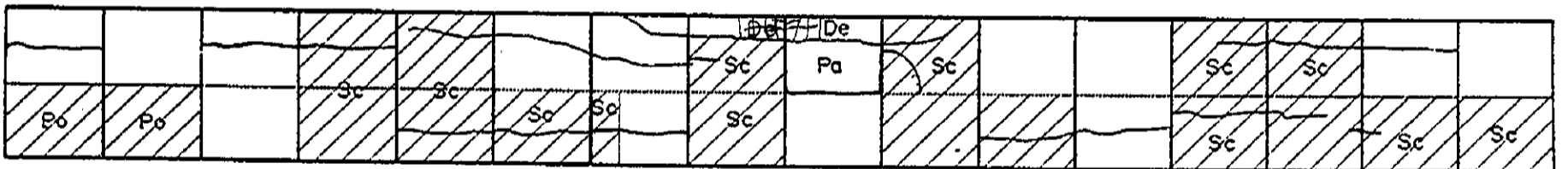
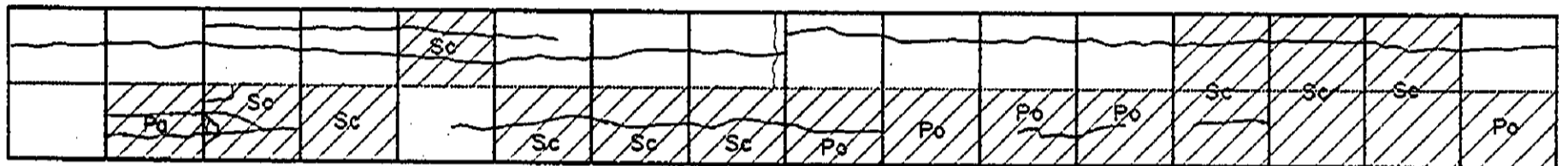
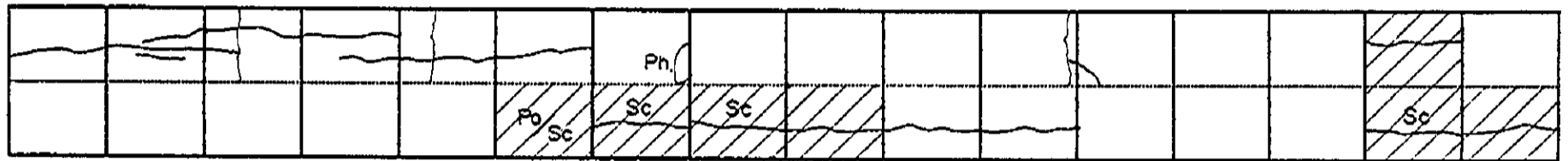
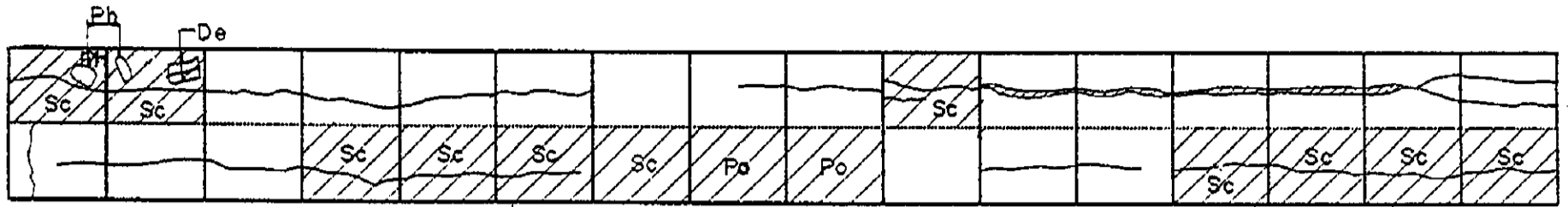

INVENTORY OF PAVEMENT SURFACE CONDITION

Date: 10-15-95

Sheet No: 1/3

Km. 1267 + 000

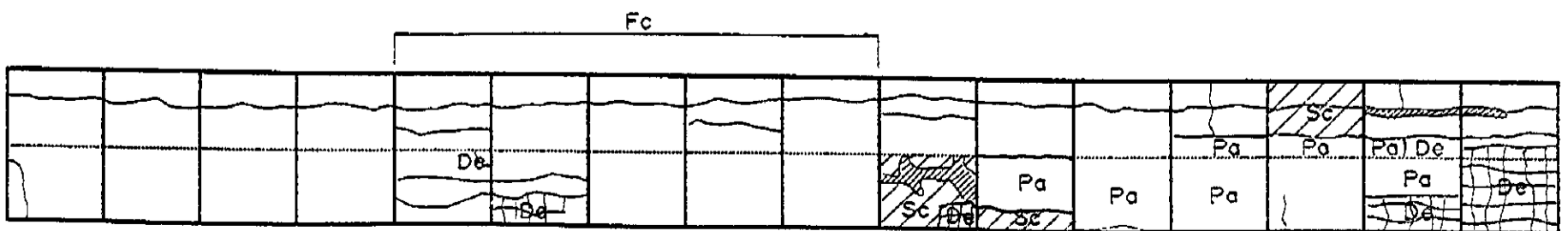
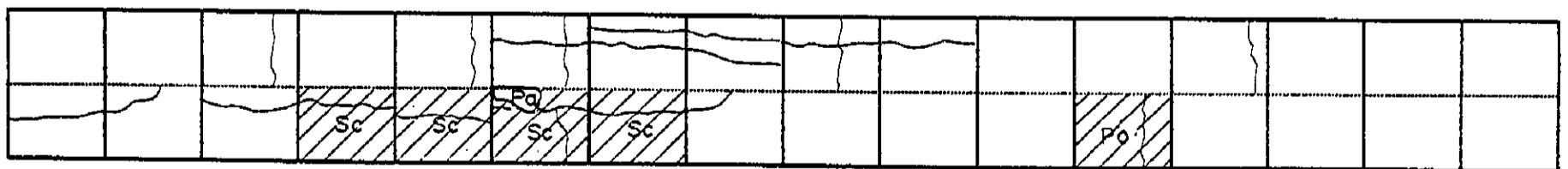
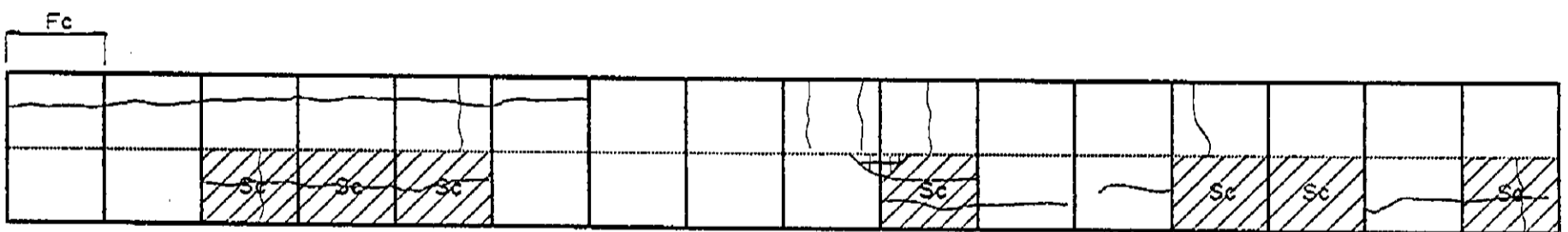
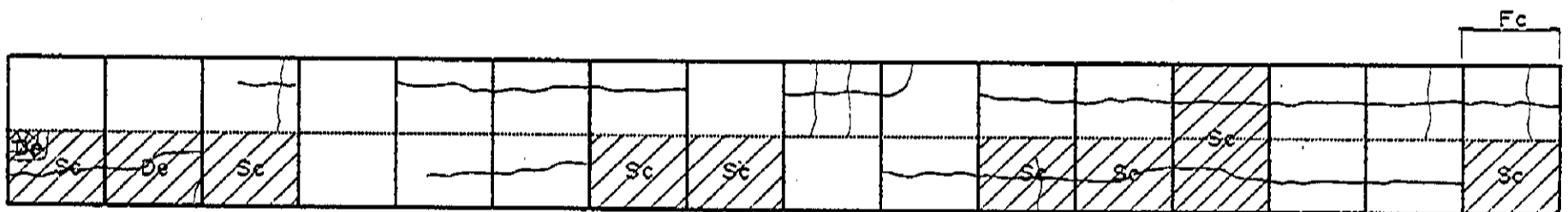
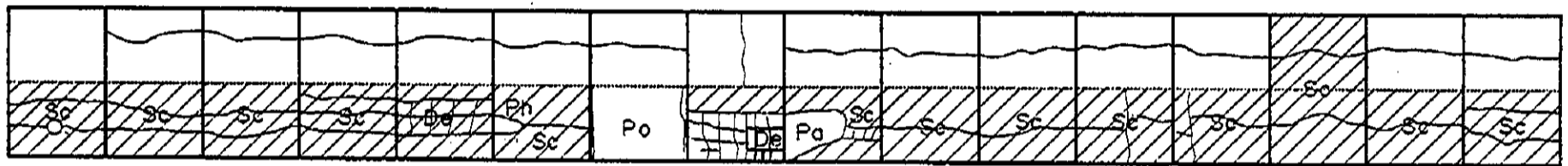
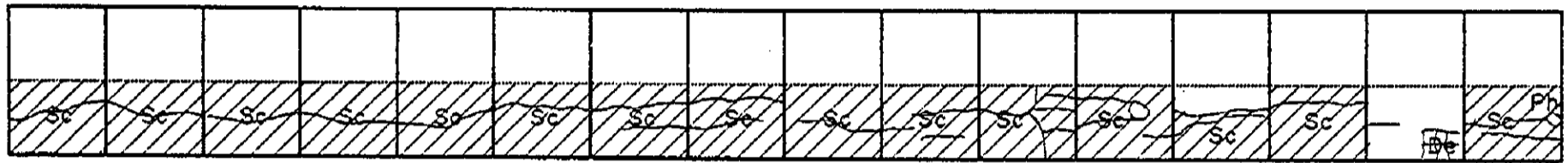
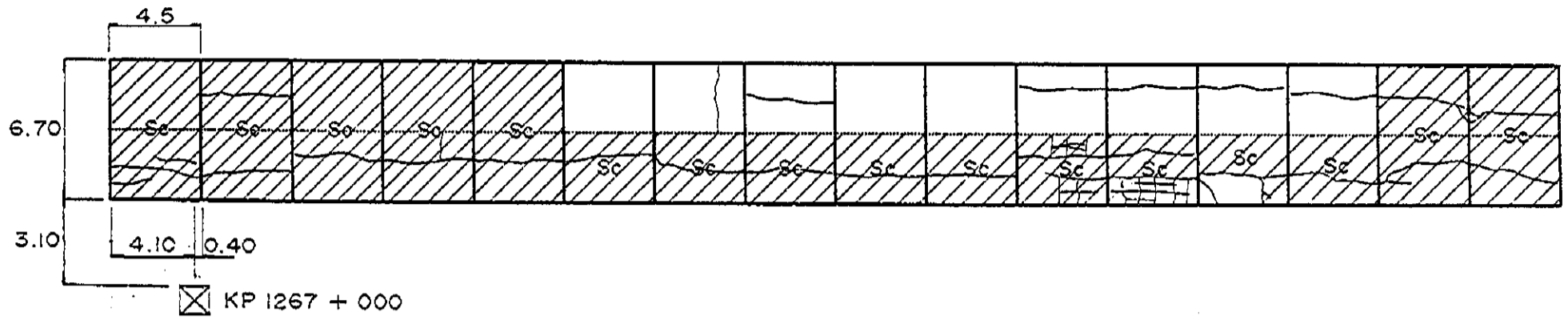

INVENTORY OF PAVEMENT SURFACE CONDITION

Km. 1267 + 000

Date: 10-15-95

Sheet No: 2/3

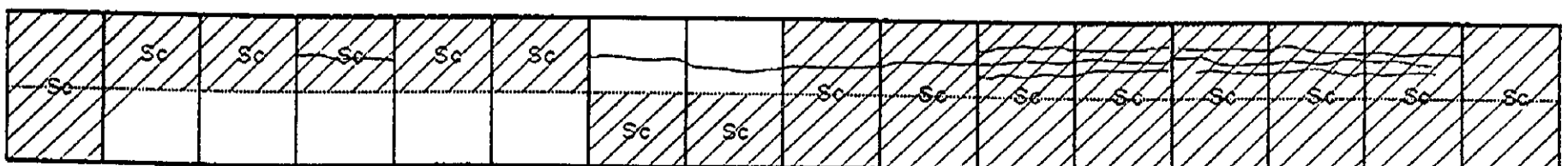
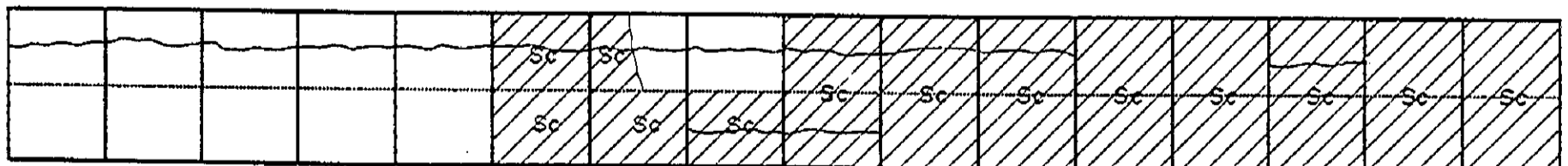
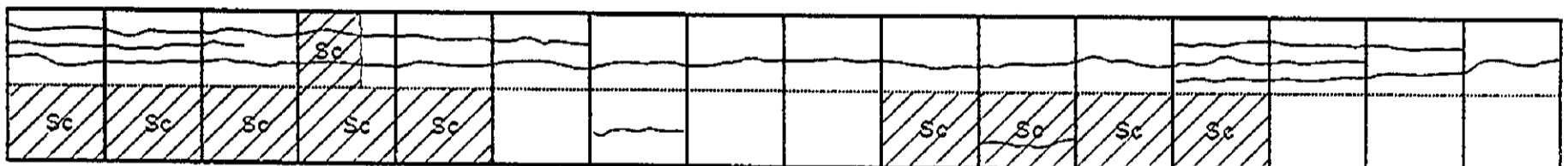
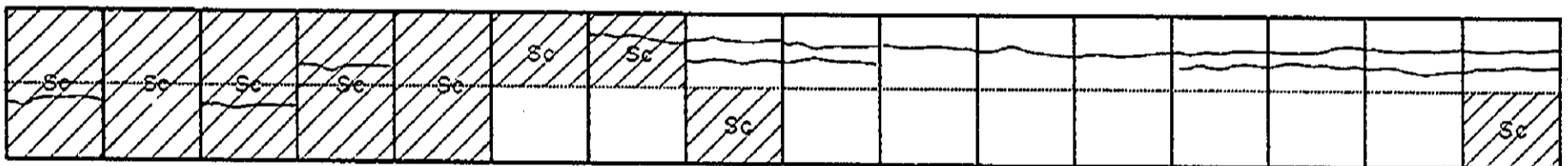
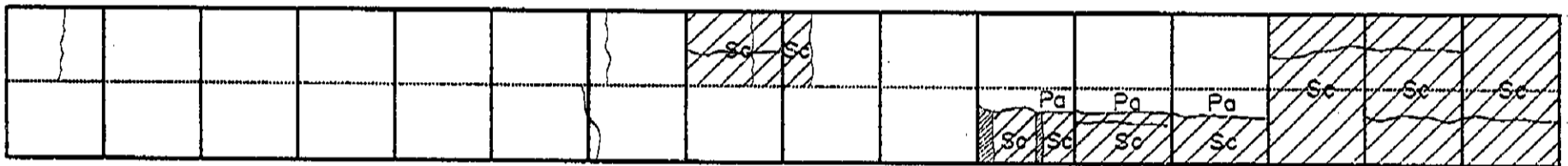
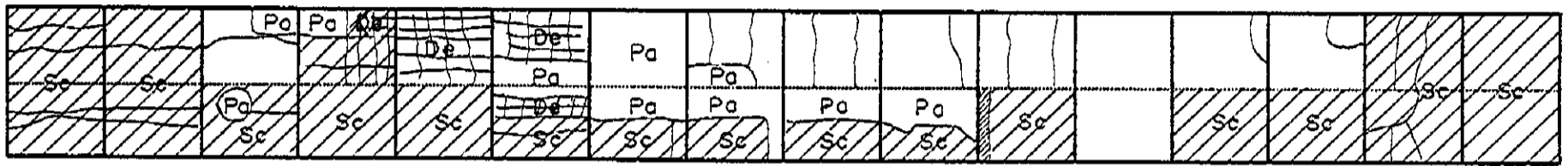
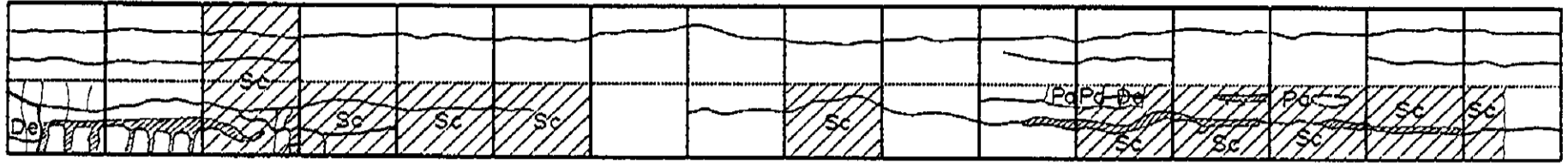

INVENTORY OF PAVEMENT SURFACE CONDITION

Date : 10-15-95

Km. 1268 + 000

Sheet No : 1/2

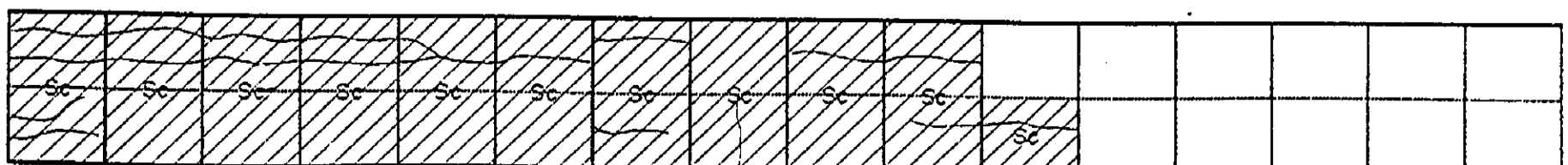
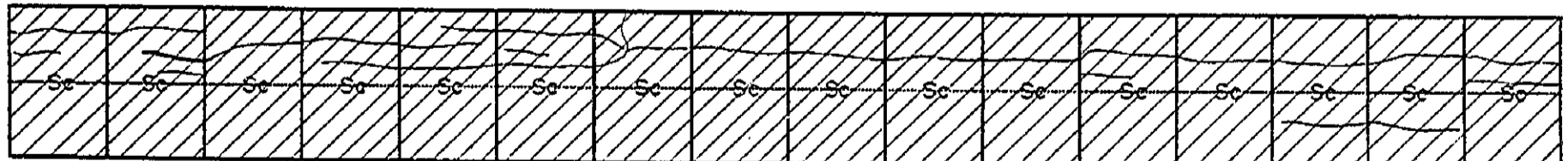
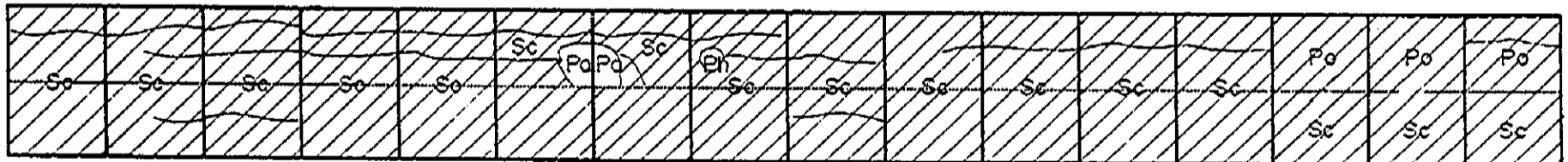
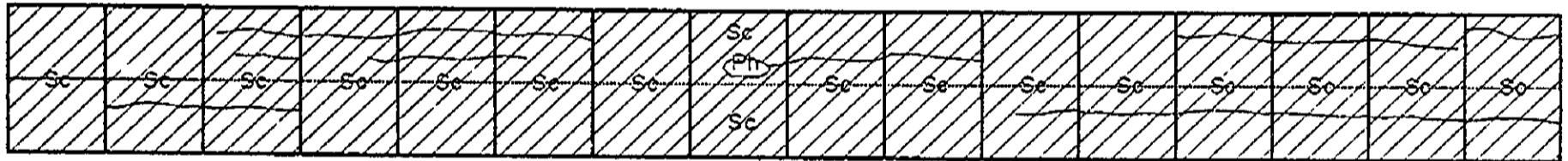
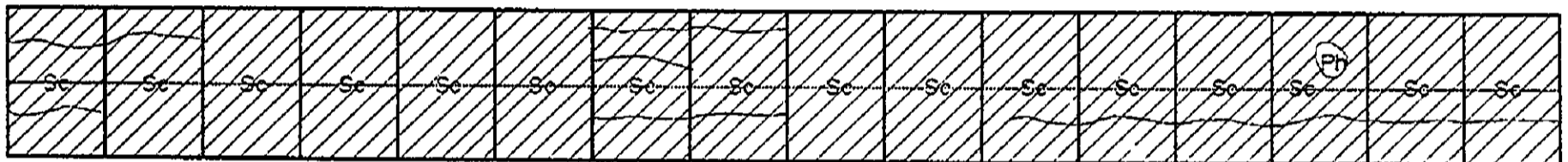
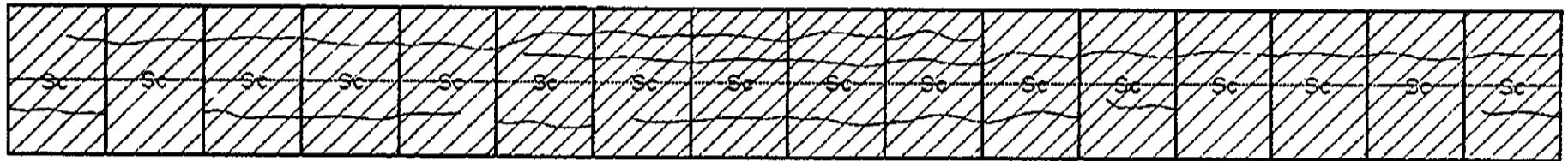
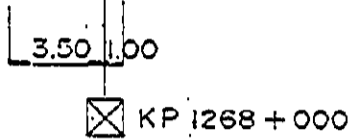
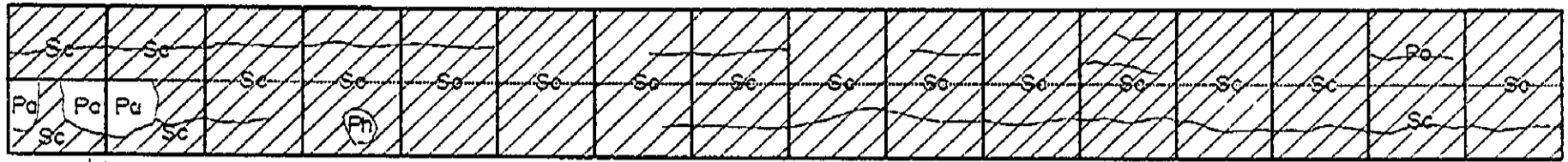

INVENTORY OF PAVEMENT SURFACE CONDITION

Km. 1268+000

Date: 10-15-95

Sheet No: 2/2

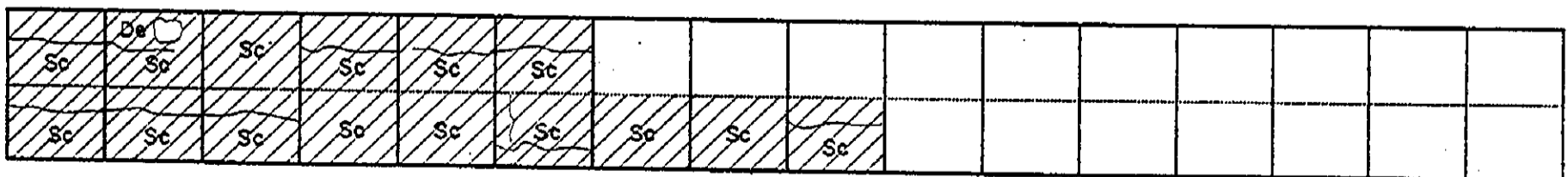
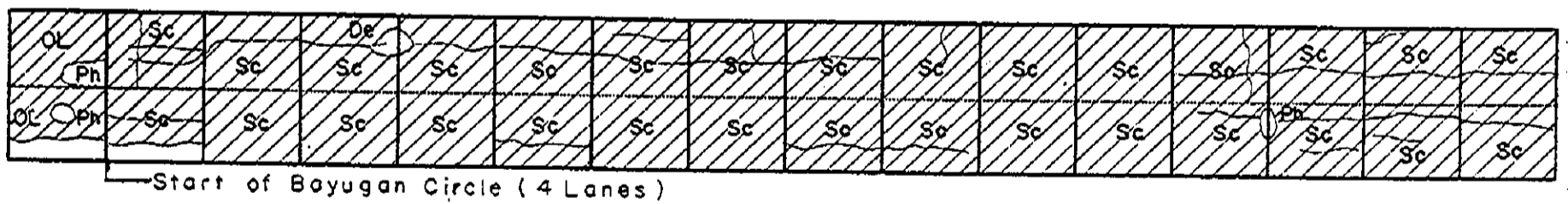
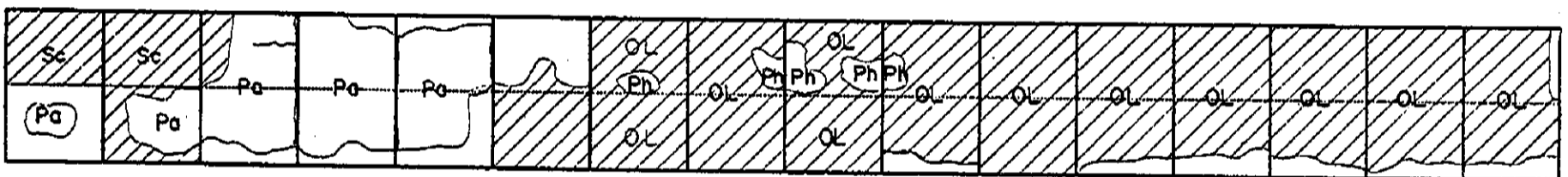
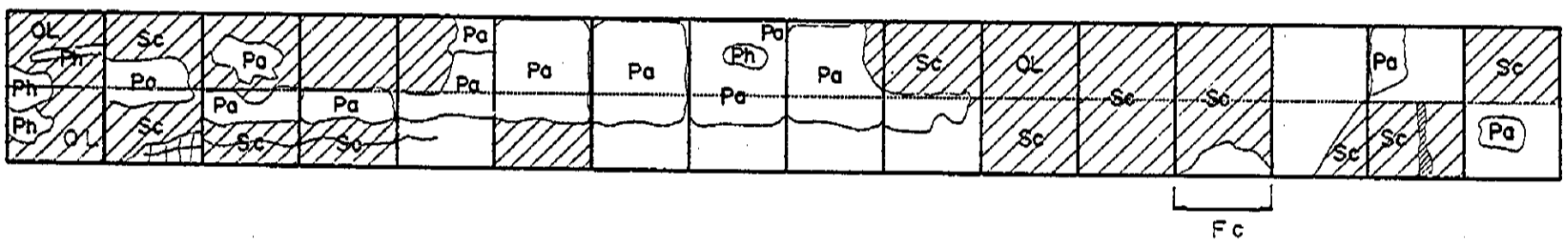
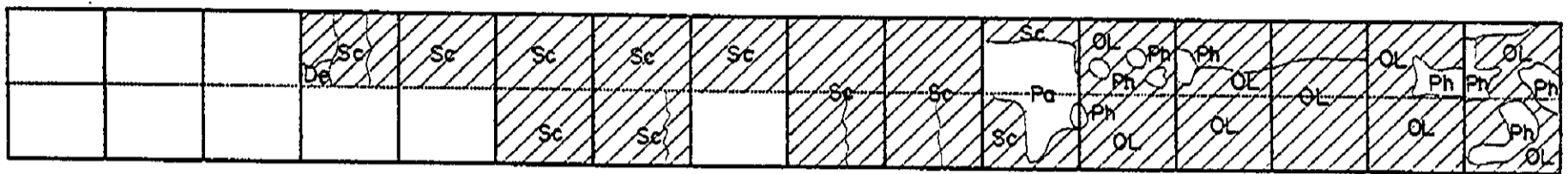
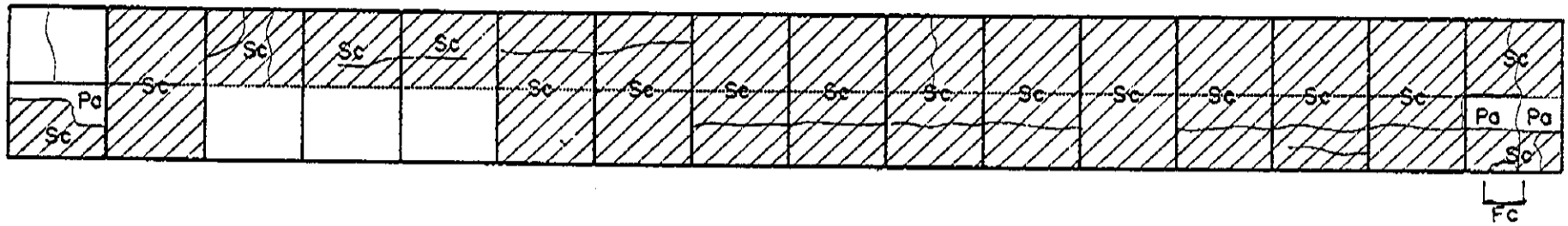

⊠ KP 1269 + 000

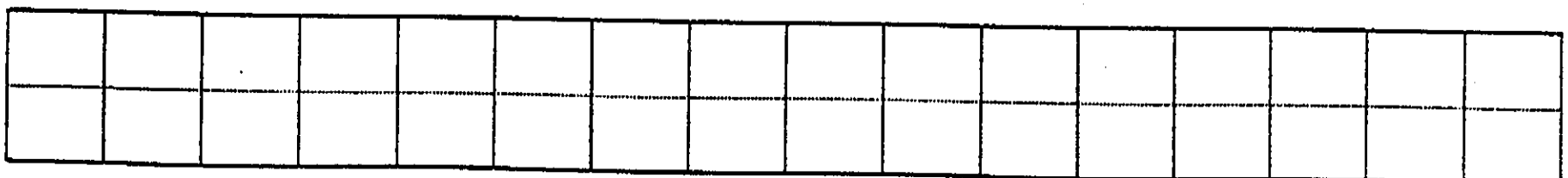

INVENTORY OF PAVEMENT SURFACE CONDITION

Date : 10-15-95

Km. 1269+000

Sheet No : 1/3

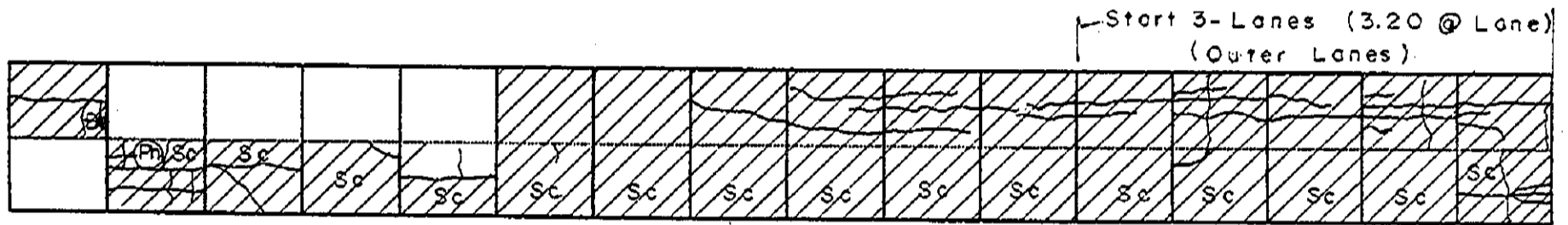
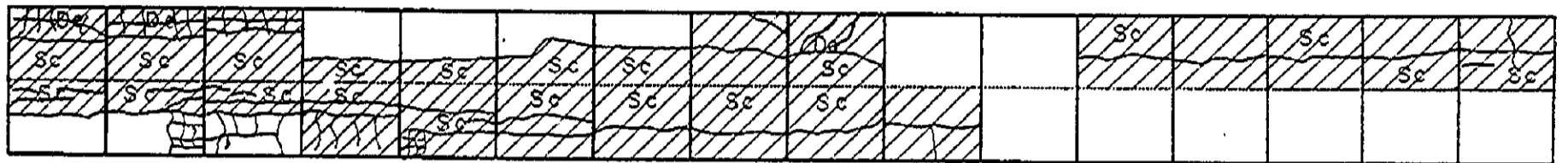
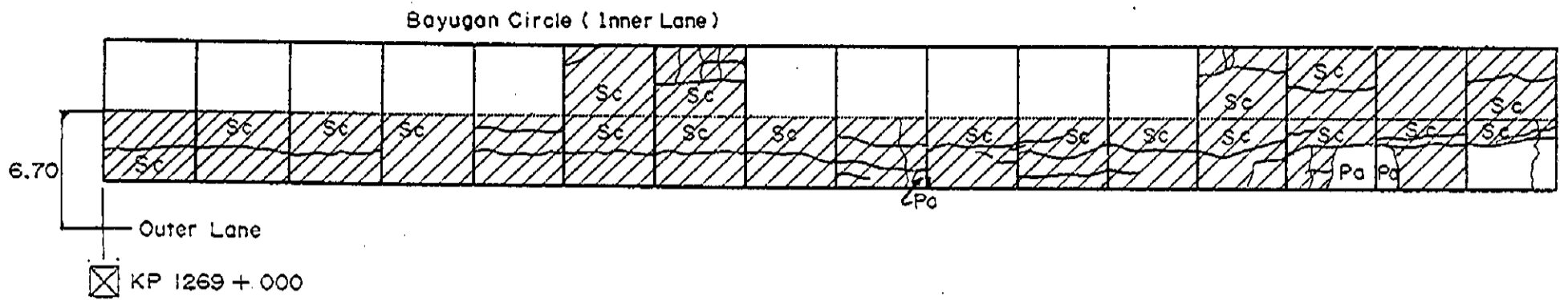

End 3-Lanes

Width (6.0m)

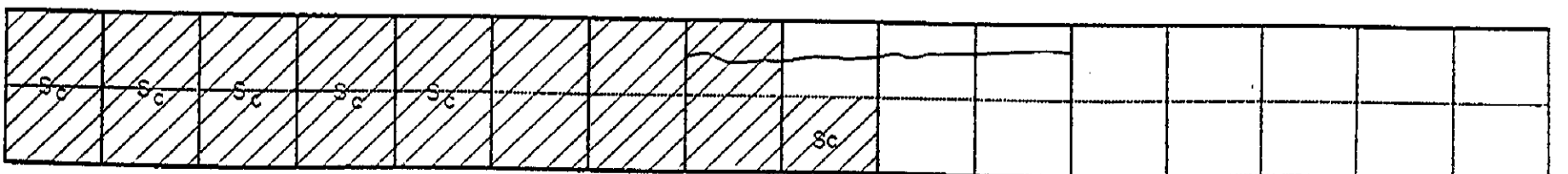
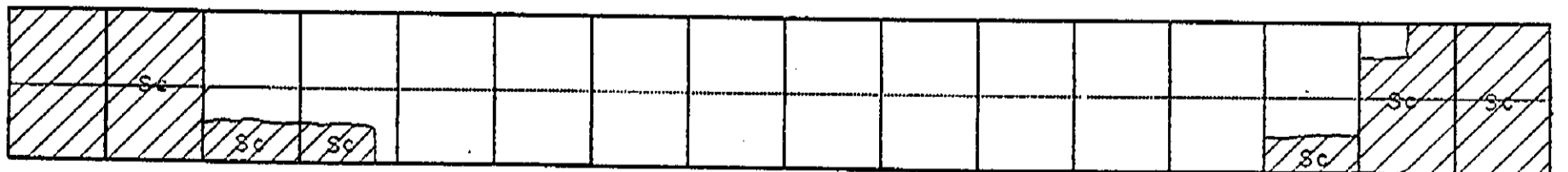
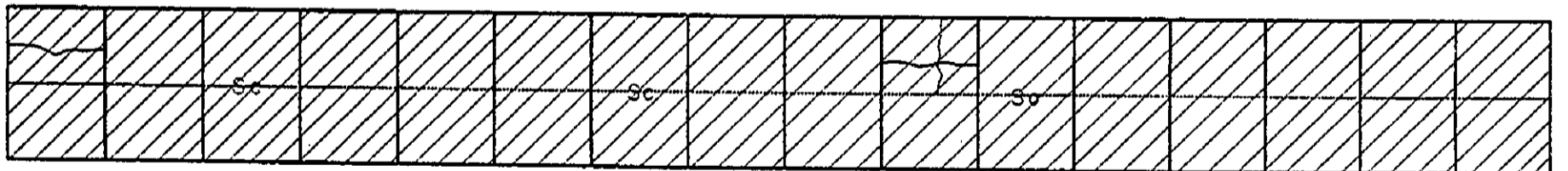
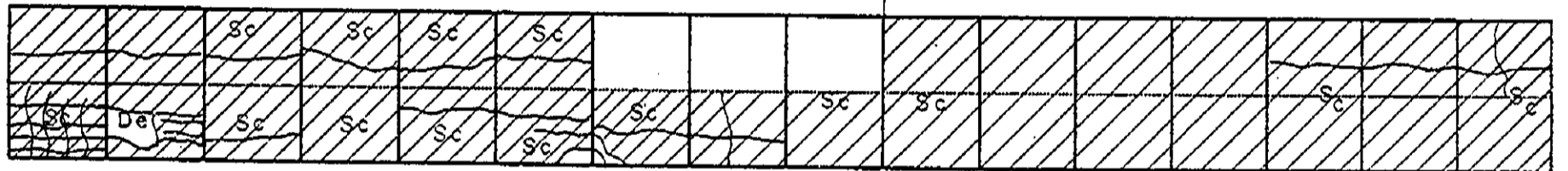

INVENTORY OF PAVEMENT SURFACE CONDITION

Km. 1269 + 000

Date: 10-15-95

Sheet No: 2/3

Width (6.50 m)

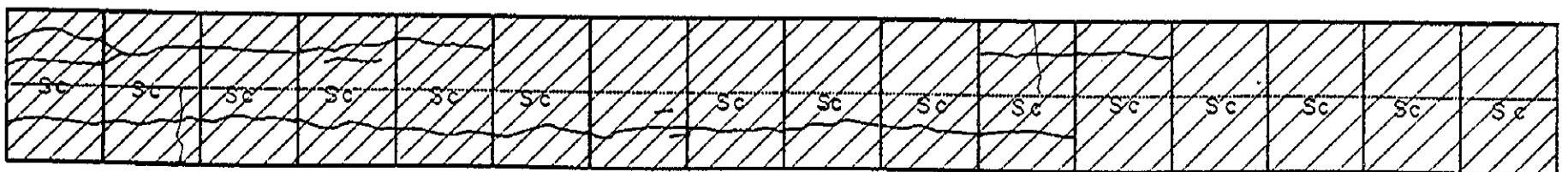
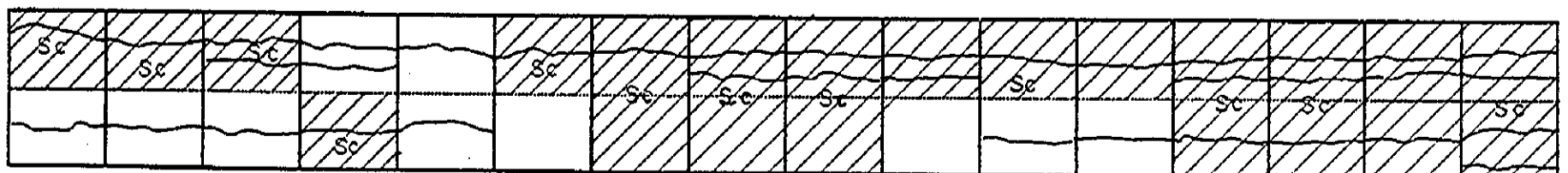
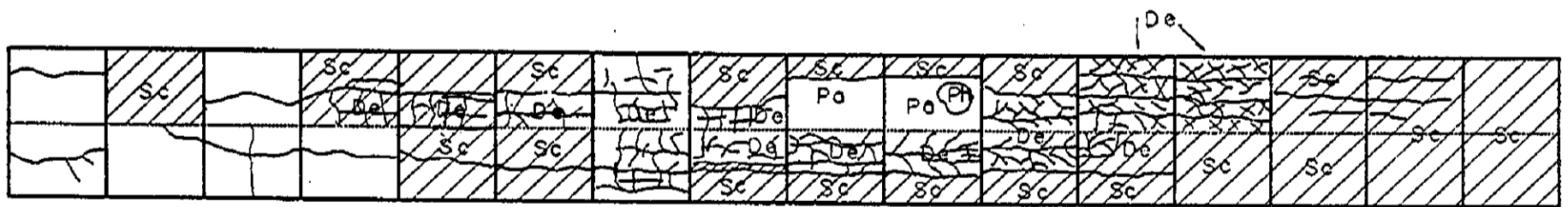
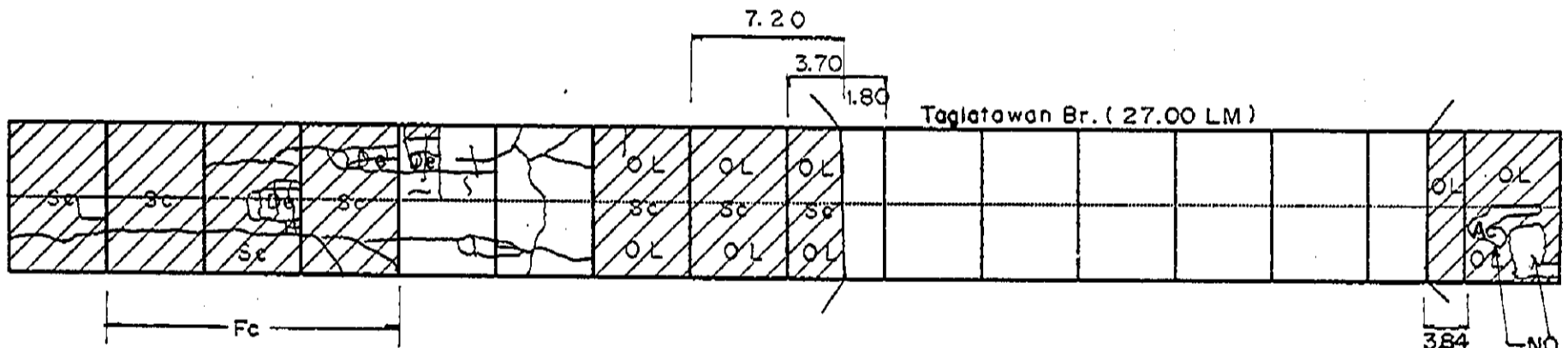
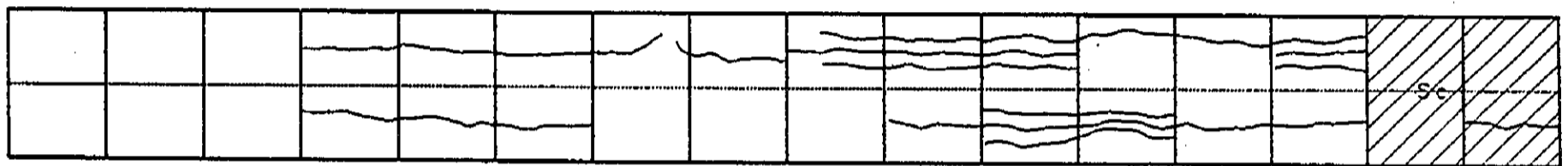
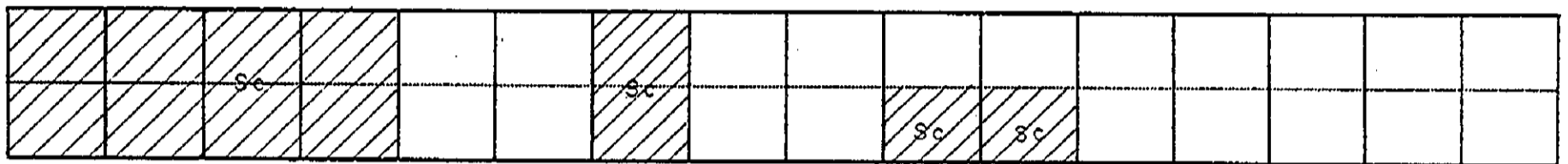
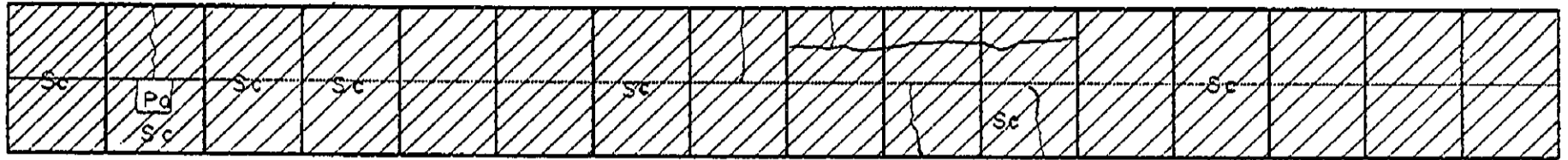

INVENTORY OF PAVEMENT SURFACE CONDITION

Km. 1270 + 000

Date: 10-15-95

Sheet No: 2/2

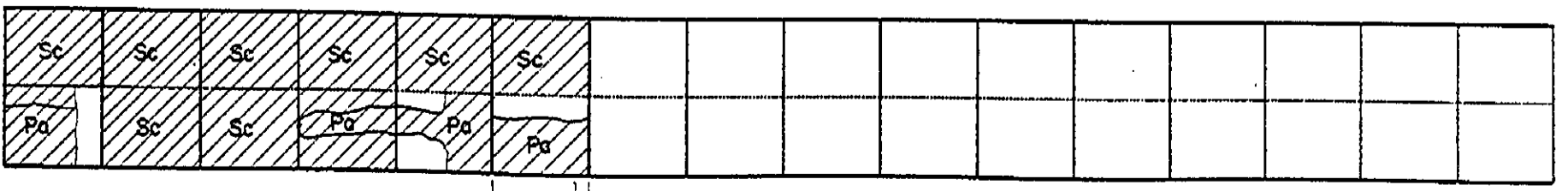
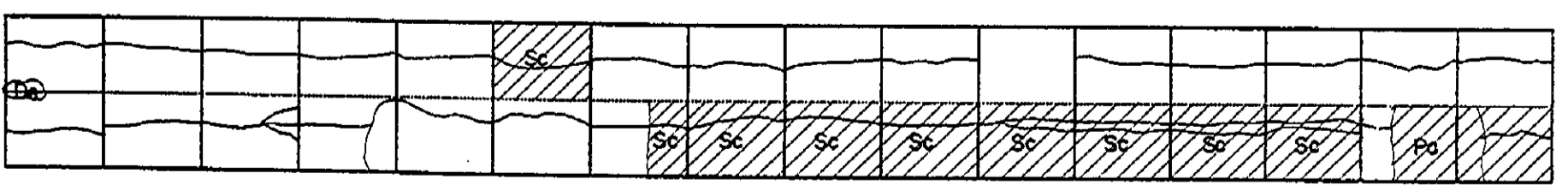
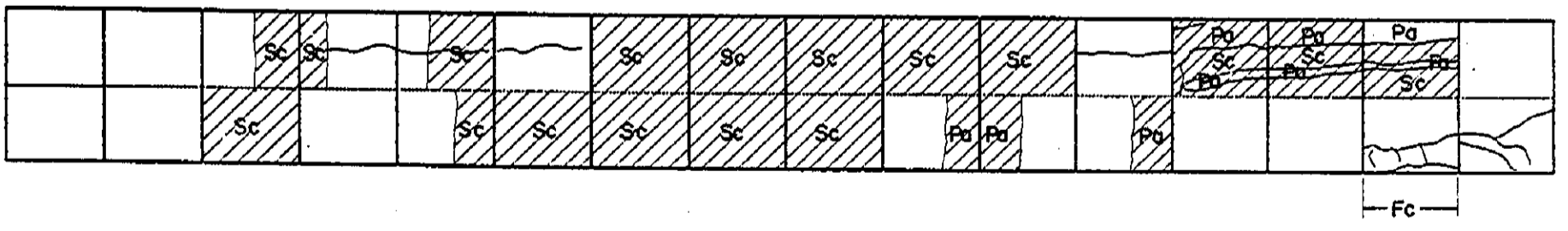
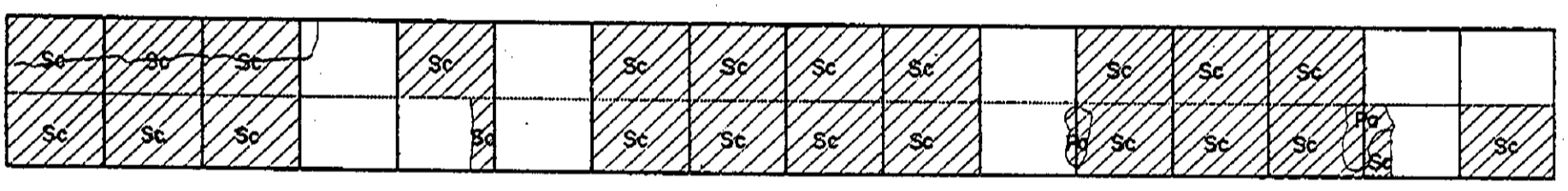
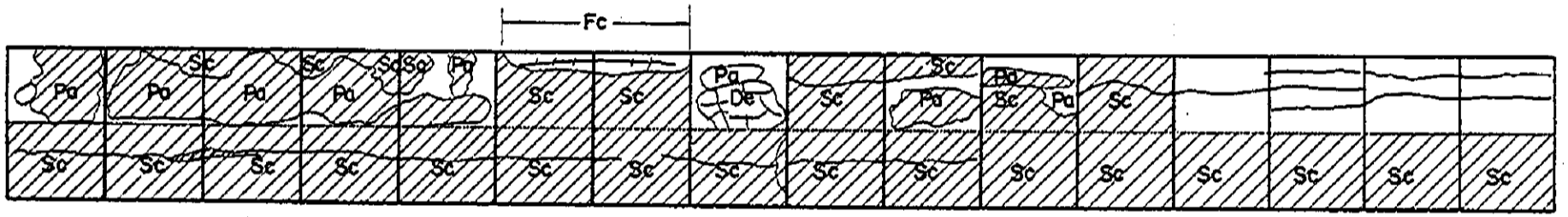
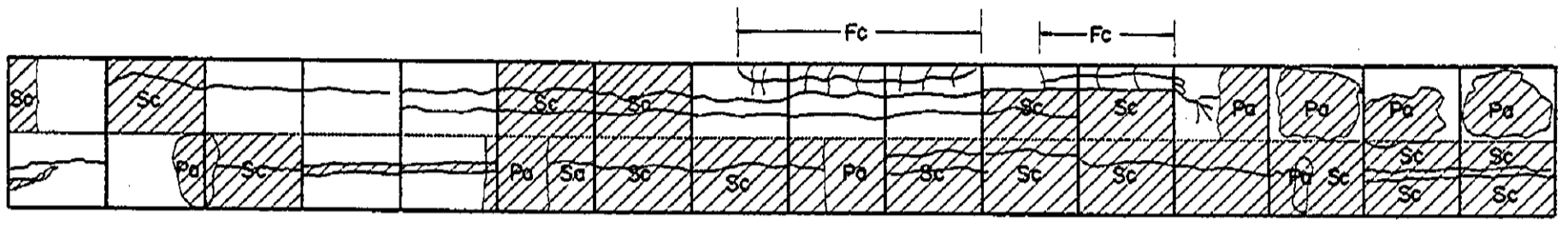
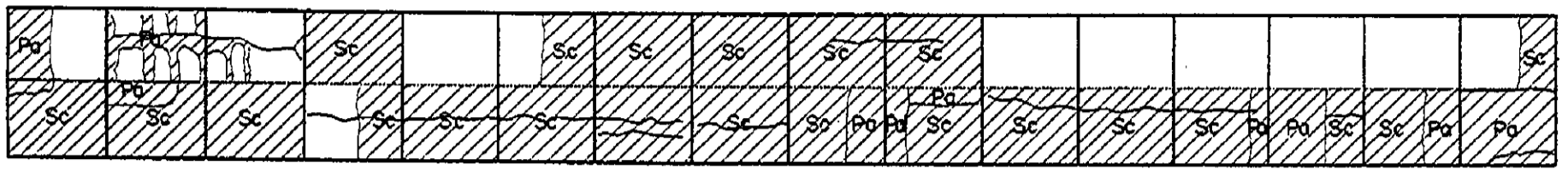

3.70 0.80

☒ KP 1271 + 000

PAN-PHILIPPINE HIGHWAY IMPROVEMENT PROJECT
(MINDANAO SECTION)

PAVEMENT DISTRESS SURVEY
PACKAGE 7

Km.1271+000 - Km.1291+000

DECEMBER , 1996

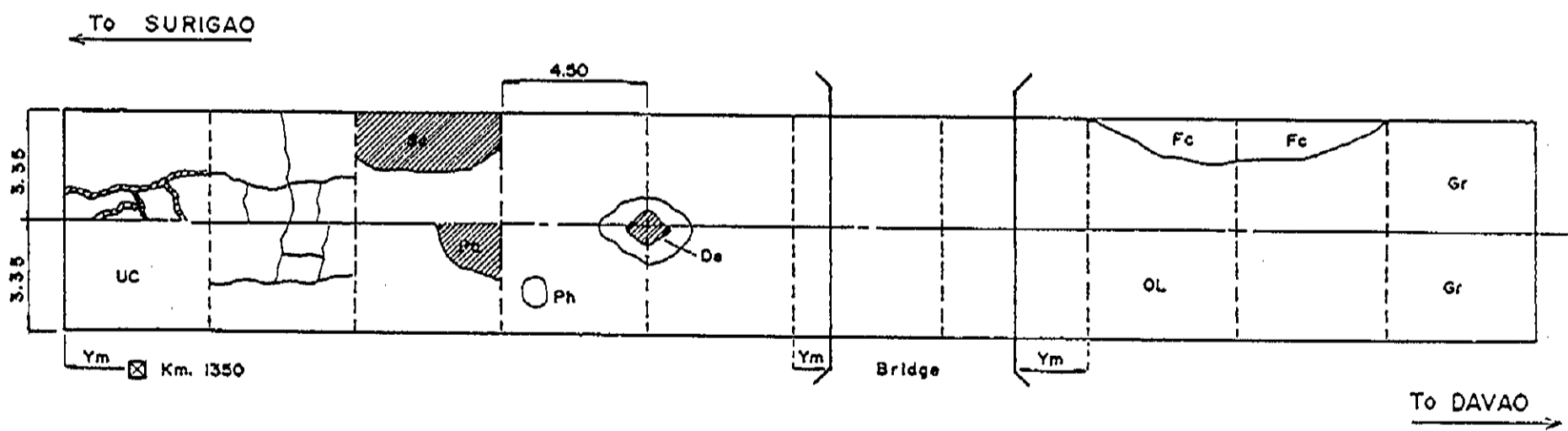

LEGENDS :

- | | | | |
|-------------------------|---------------|---|--|
| 1. Cracks | Open Cracks | — | 8. Overlay - OL |
| | Sealed Cracks | ▨ | (Sketch area of pavement with overlay) |
| 2. Potholes | - Ph | | 9. Under Construction - UC |
| 3. Patching | - Pa | | 10. Gravel - Gr |
| 4. Cracks with Faulting | - Fc | | (Except Under Construction) |
| 5. Sealing | - Sc | | 11. Other Information |
| 6. Depression | - De | | • Kilometer Post |
| 7. Pop out | - Po | | • Bridge |

FIGURE 2.1-1 LEGENDS USED FOR SKETCHING PAVEMENT DISTRESS

INVENTORY OF PAVEMENT SURFACE CONDITION

Km. 1271+000

Date: 10-15-95

Sheet No: 1/2

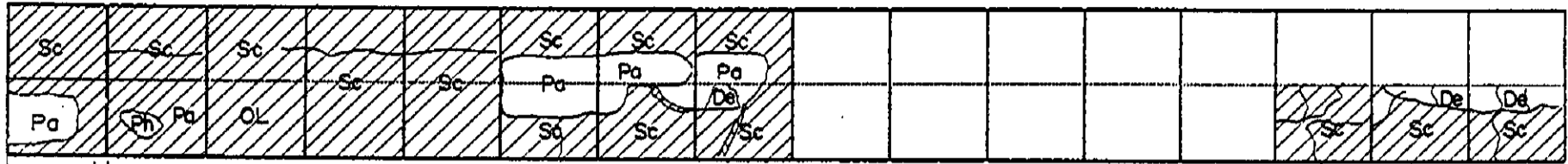

3.70 0.80

☒ KP 1271 + 000

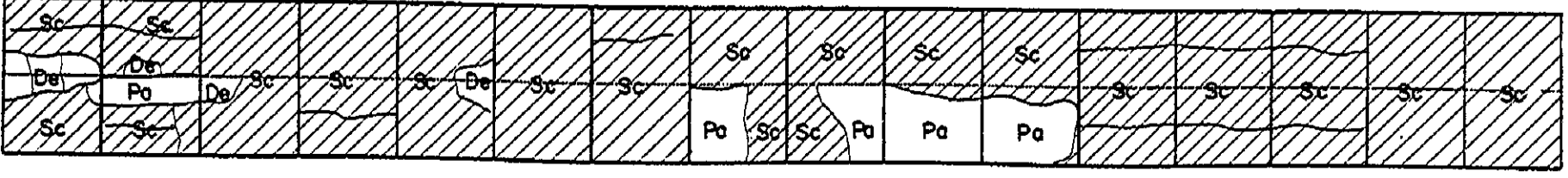
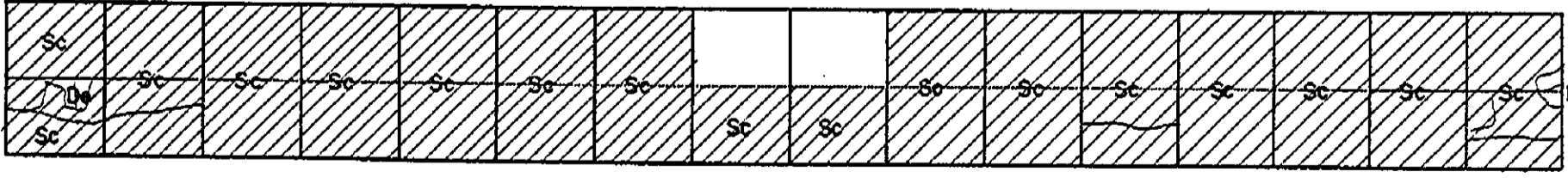
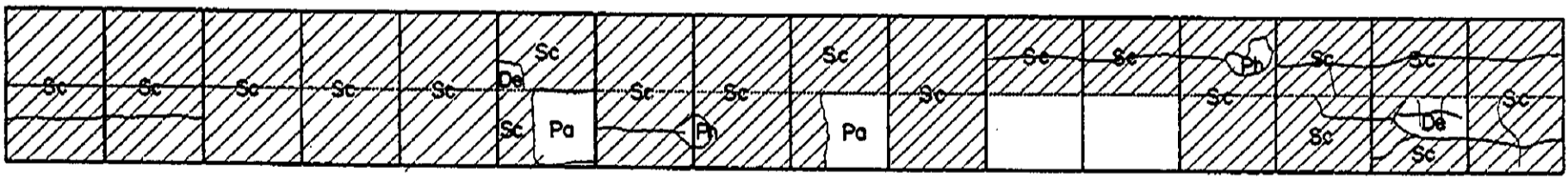
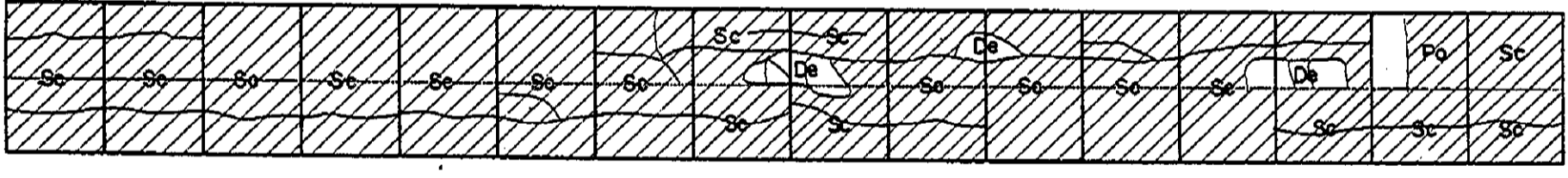
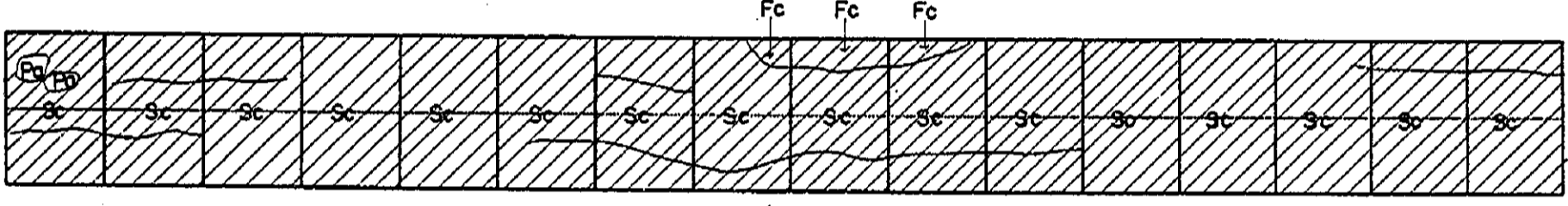
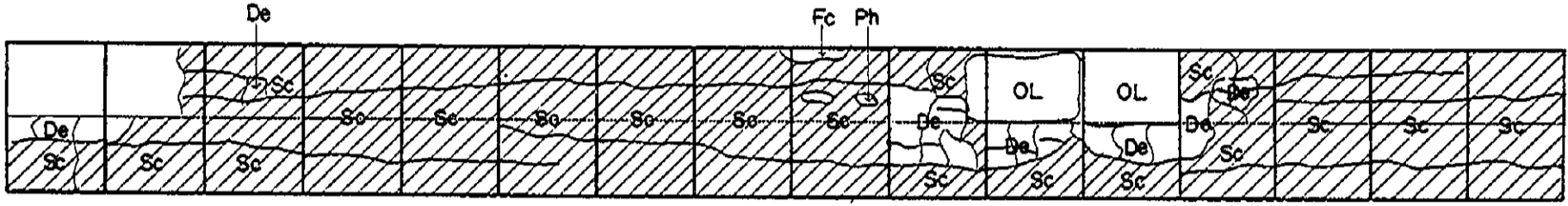

INVENTORY OF PAVEMENT SURFACE CONDITION

Date: 10-15-95

Km. 1271 + 000

Sheet No: 2/2

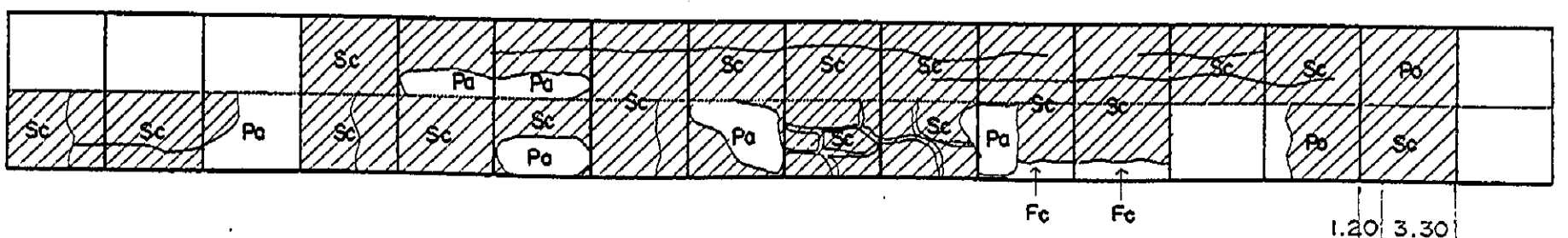
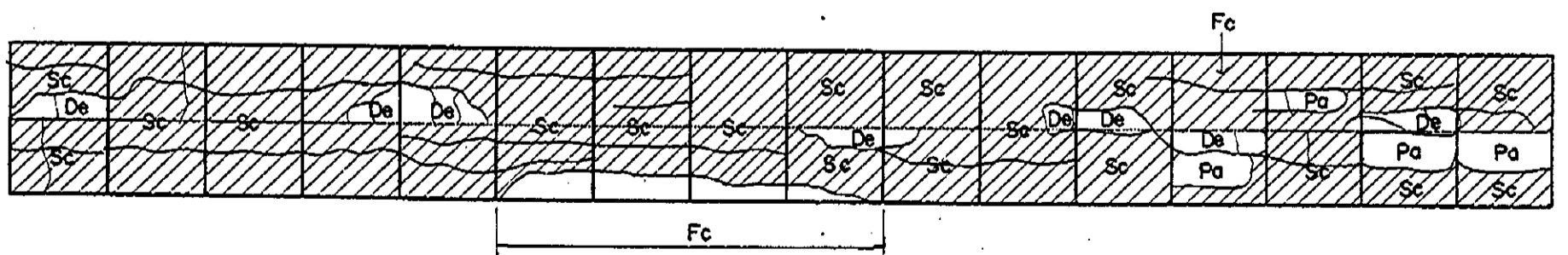
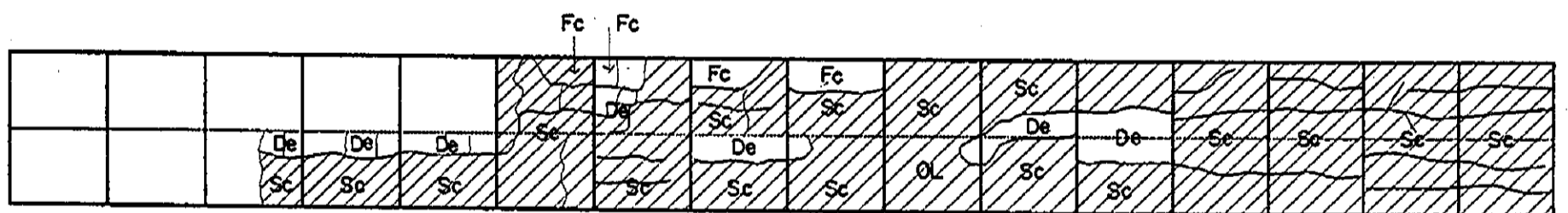
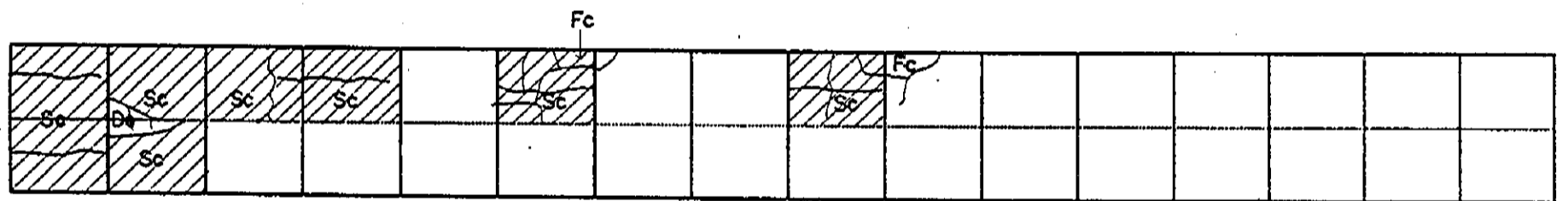
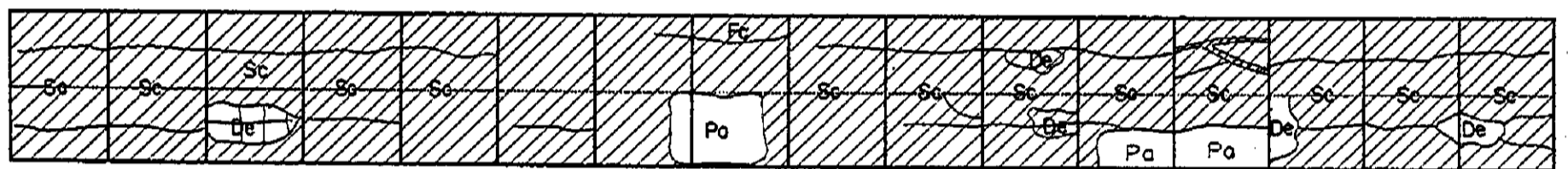
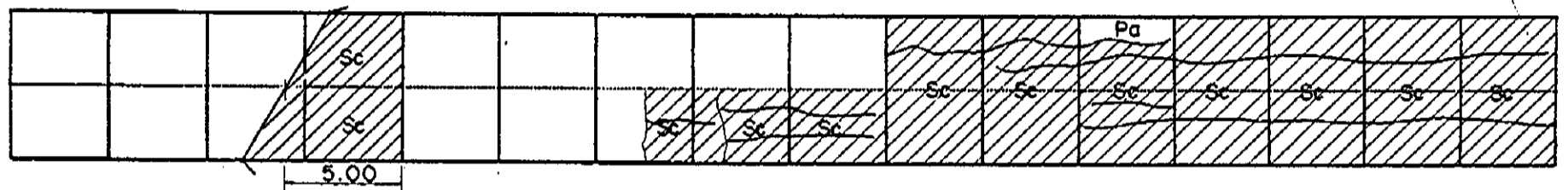
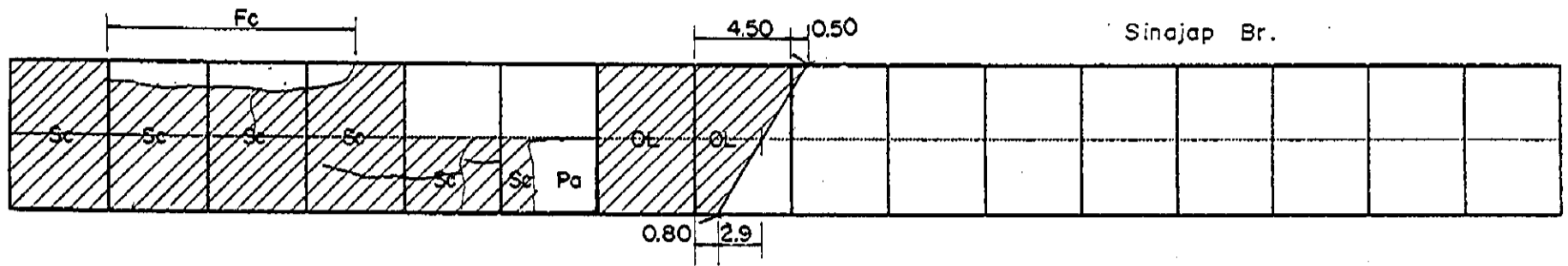

INVENTORY OF PAVEMENT SURFACE CONDITION

Date: 10-16-95

Km. 1272+000

Sheet No: 1/2

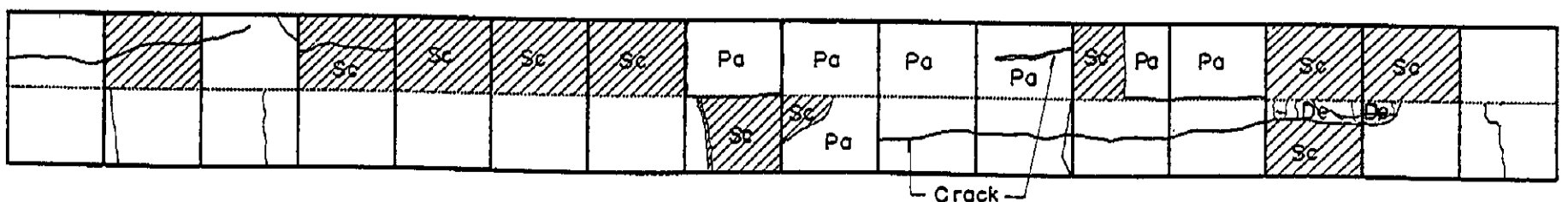
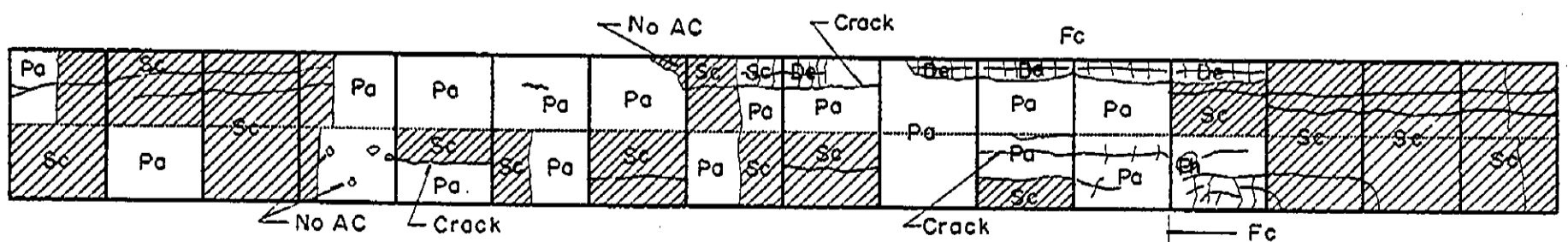
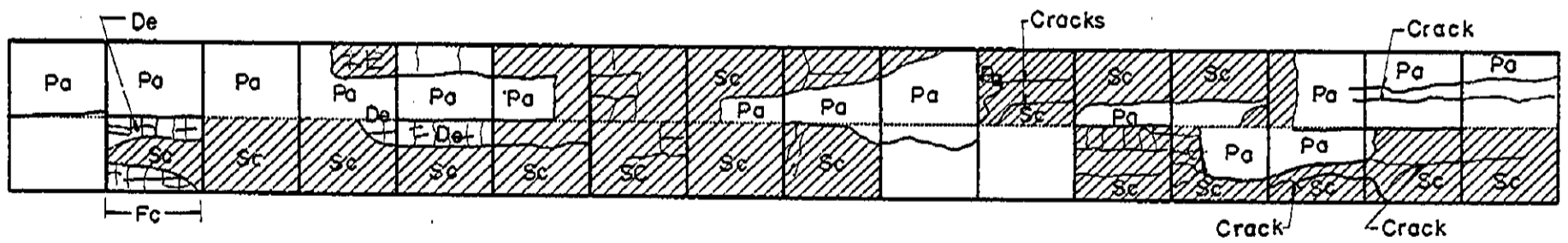
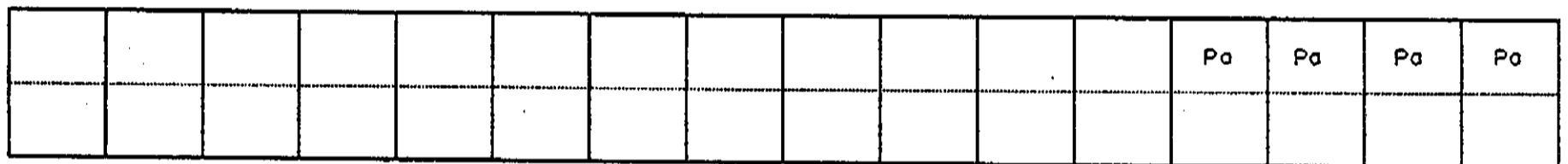
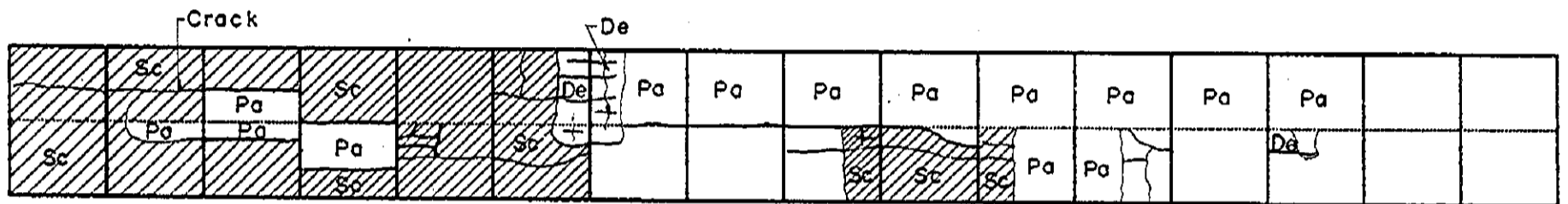
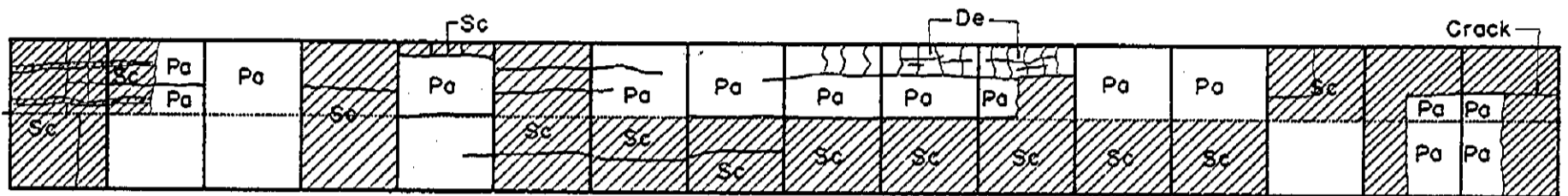
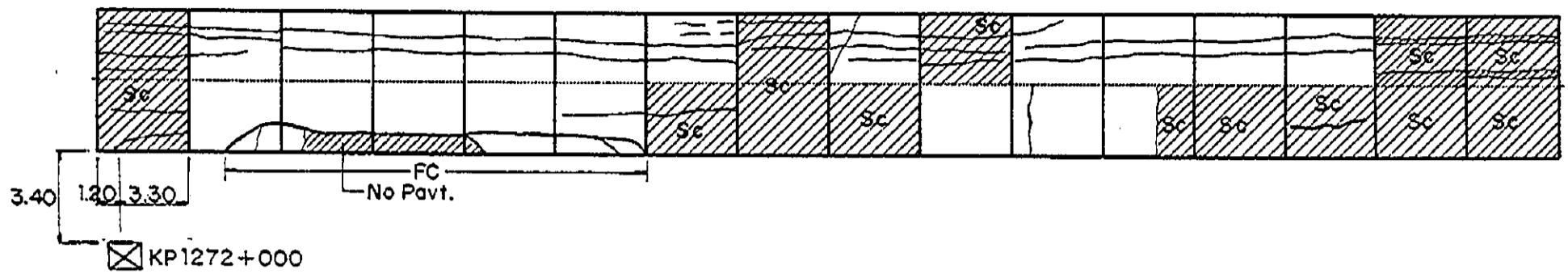

INVENTORY OF PAVEMENT SURFACE CONDITION

Date: 10-16-95

Km. 1272+000

Sheet No: 2/2

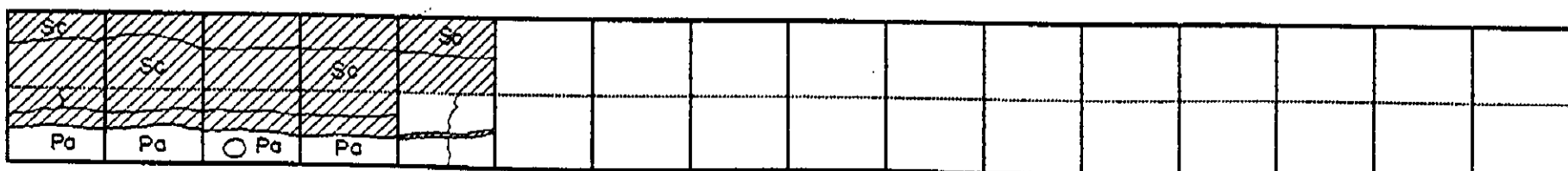
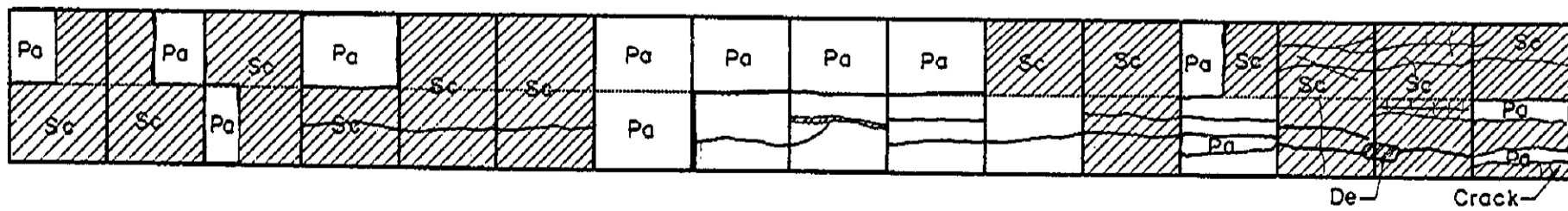
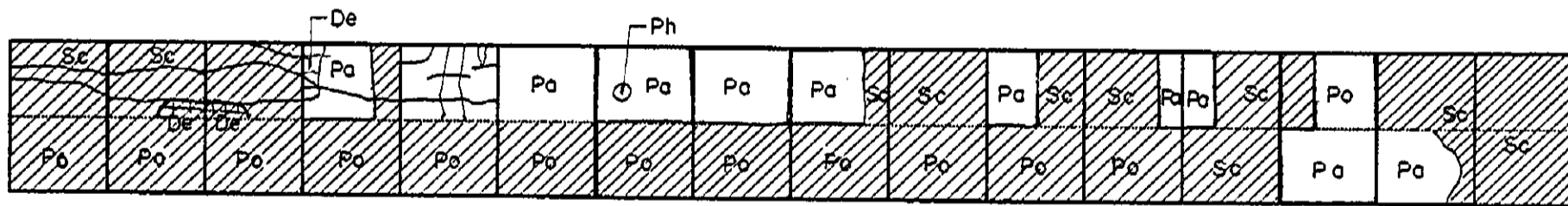
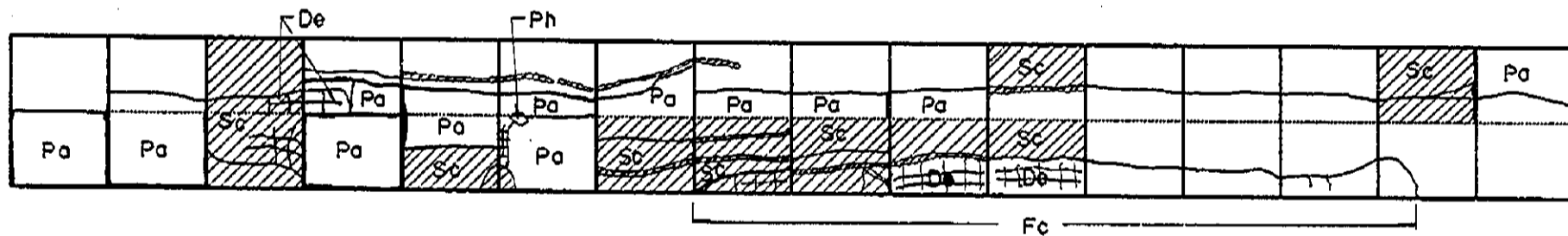
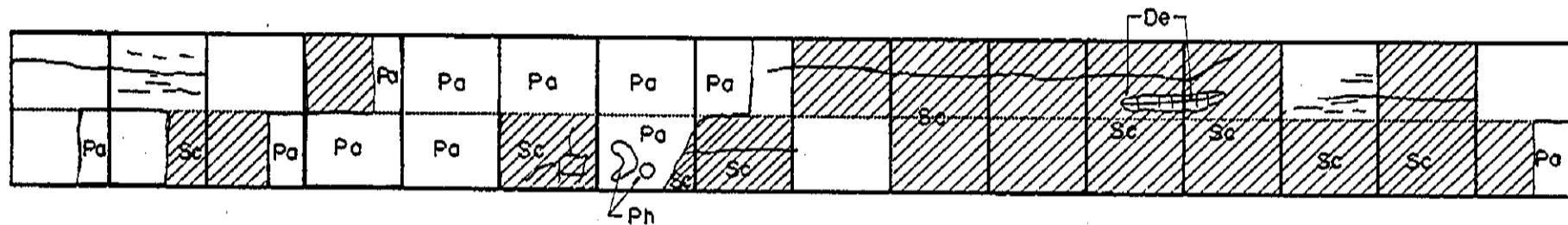
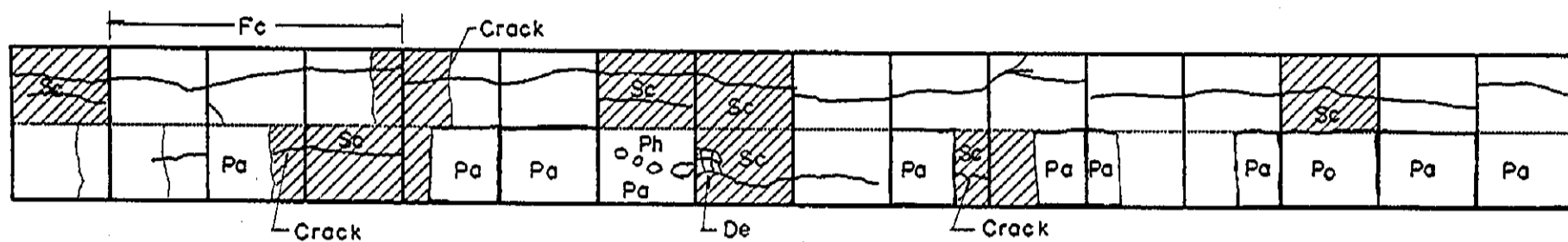
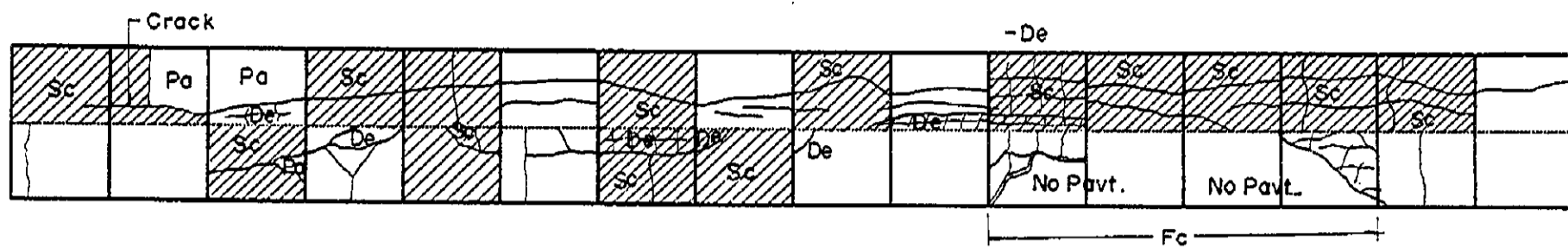

2.20 | 2.30 | 3.00

☒ KP 1273+000

INVENTORY OF PAVEMENT SURFACE CONDITION

Km. 1273+000

Date: 10-16-95

Sheet No: 1/2

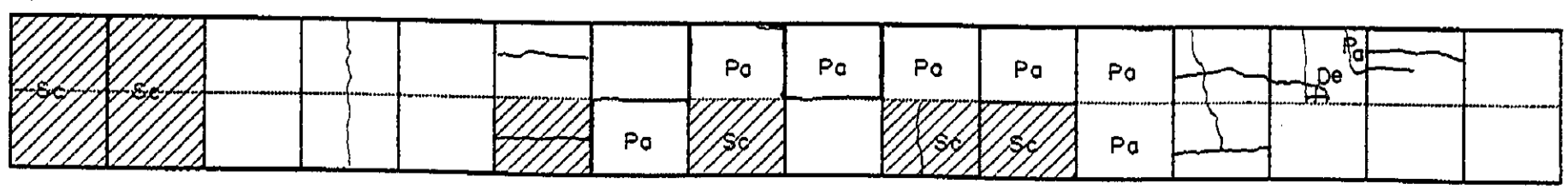
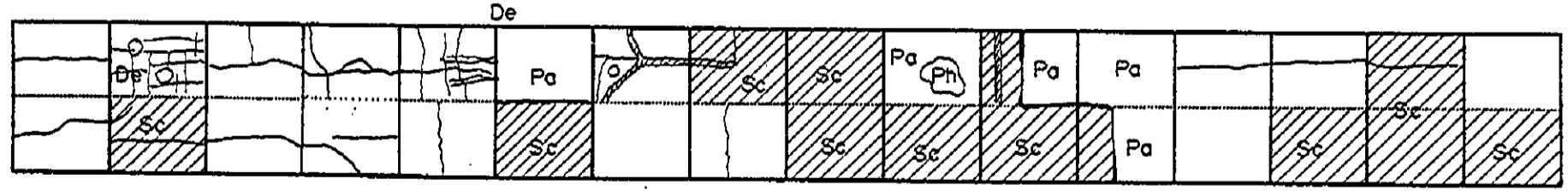
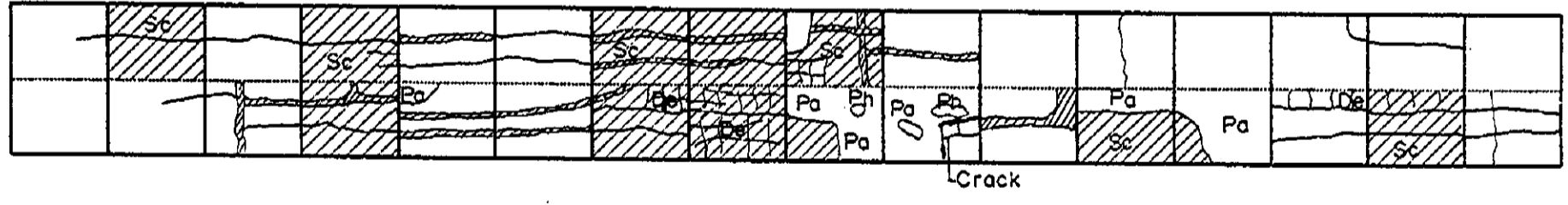
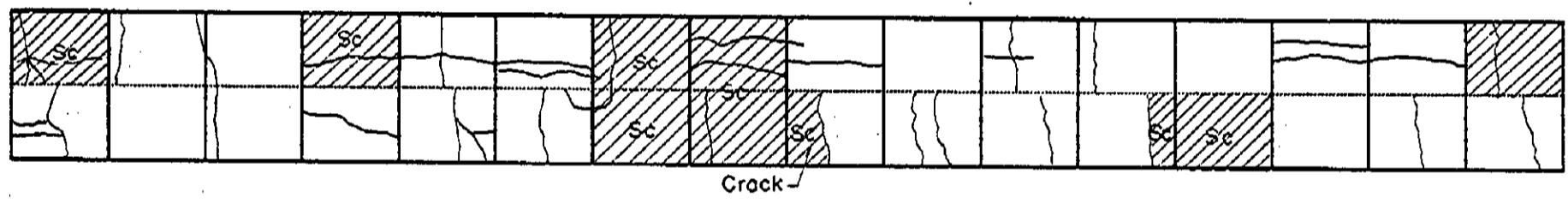
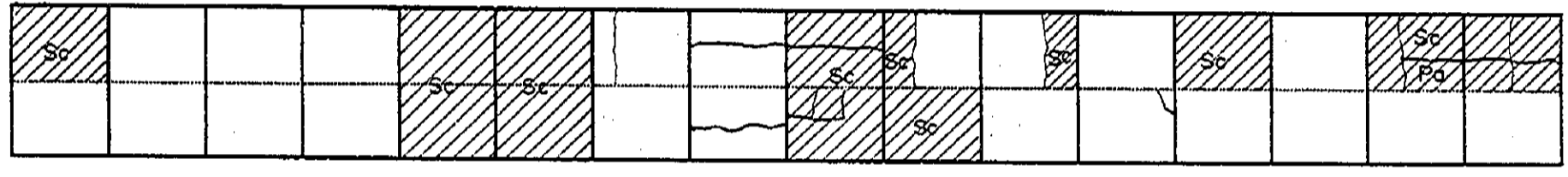
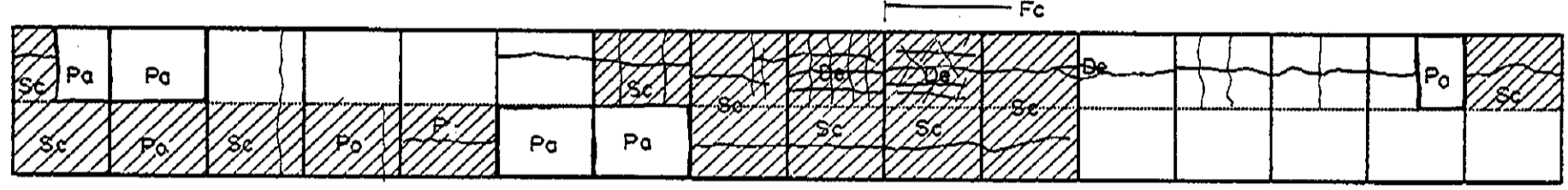
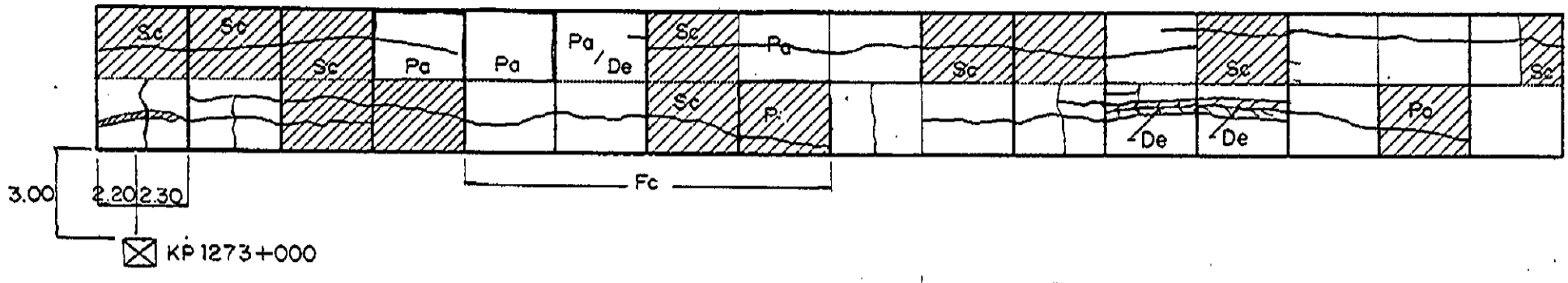

INVENTORY OF PAVEMENT SURFACE CONDITION

Km. 1273+000

Date: 10-16-95

Sheet No: 2 / 2

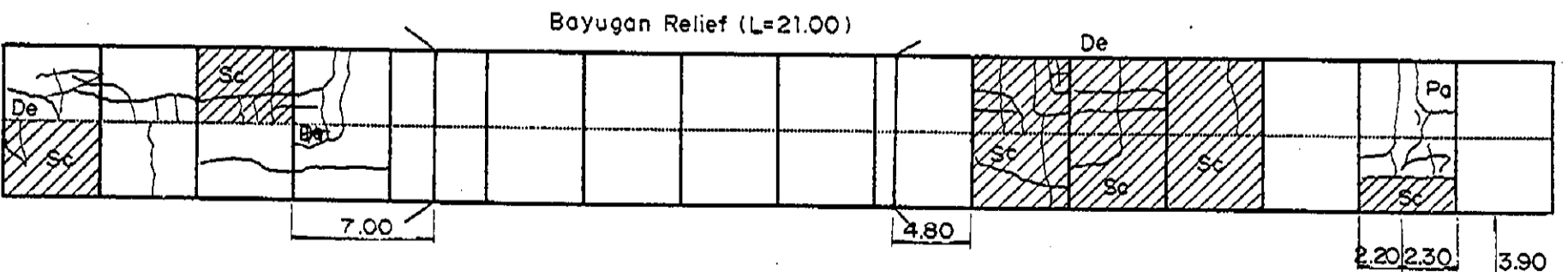
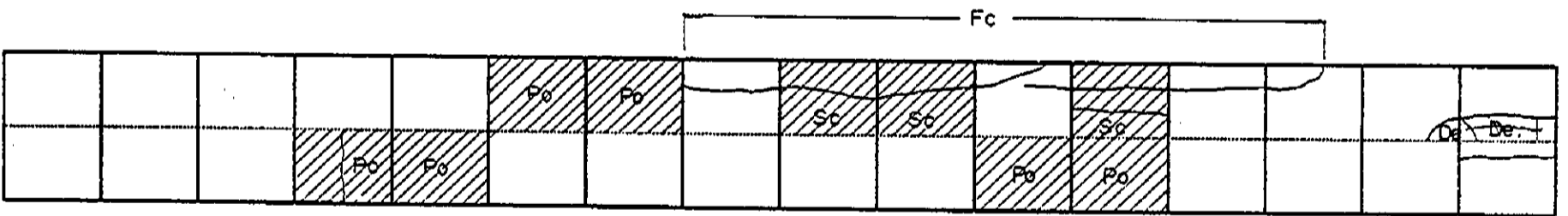
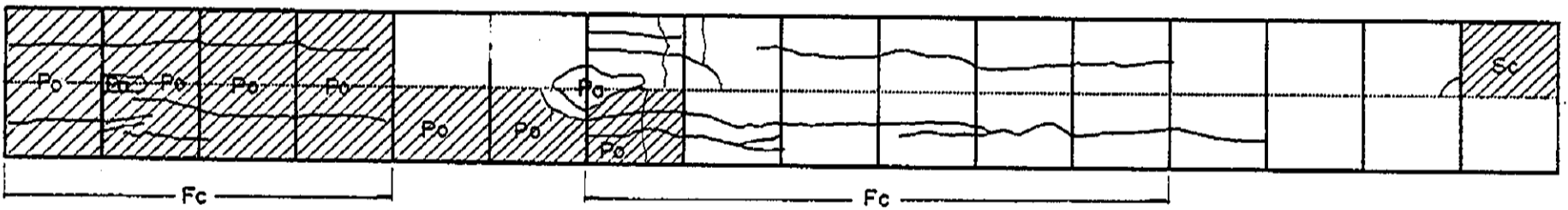
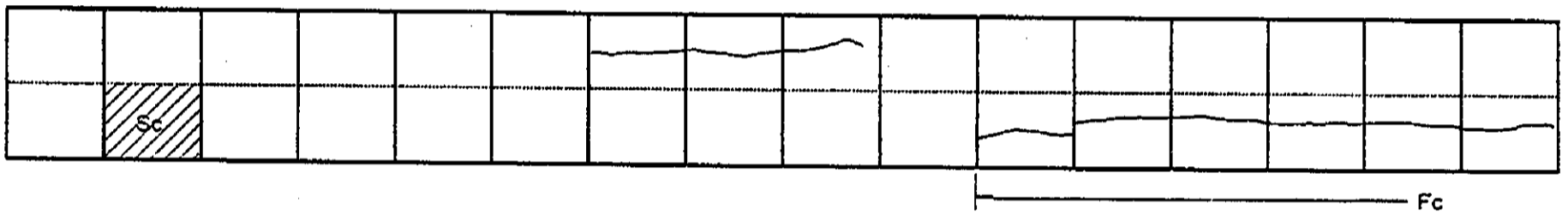
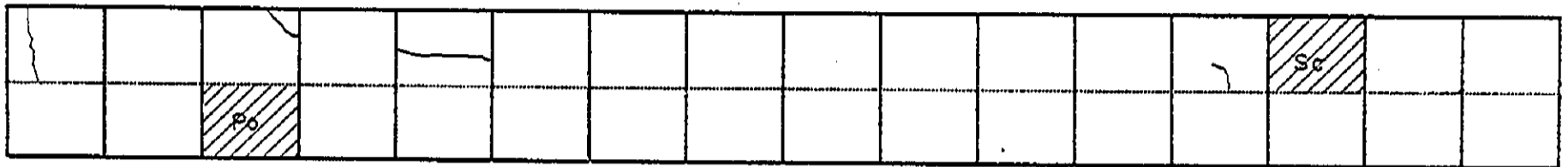
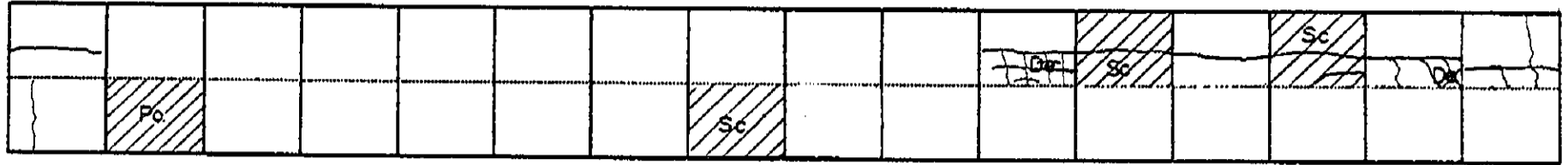

⊗ KP 1274+000

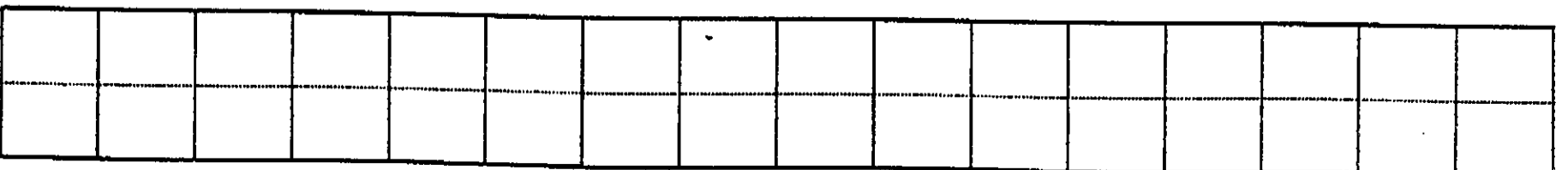

INVENTORY OF PAVEMENT SURFACE CONDITION

Date: 10-16-75

Sheet No: 1/3

Km. 1274 + 000

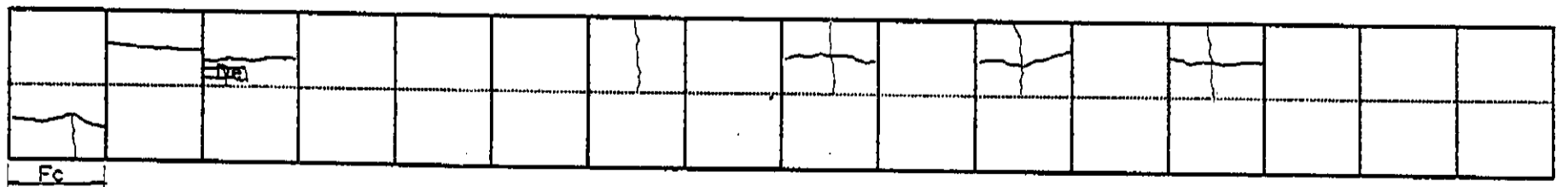
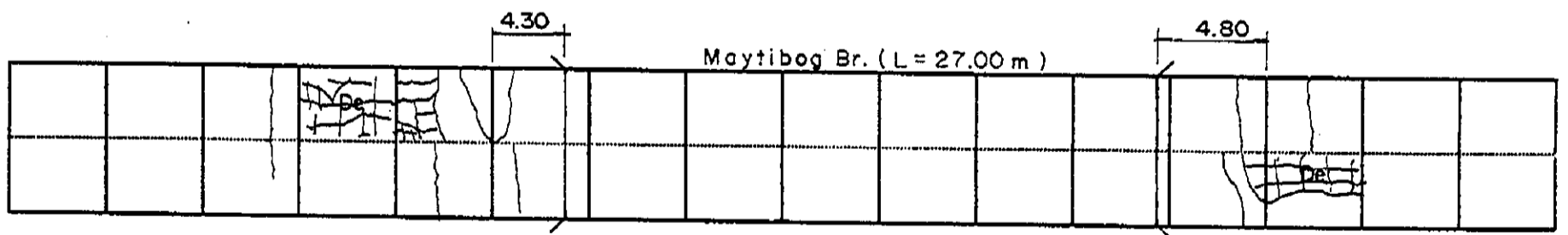
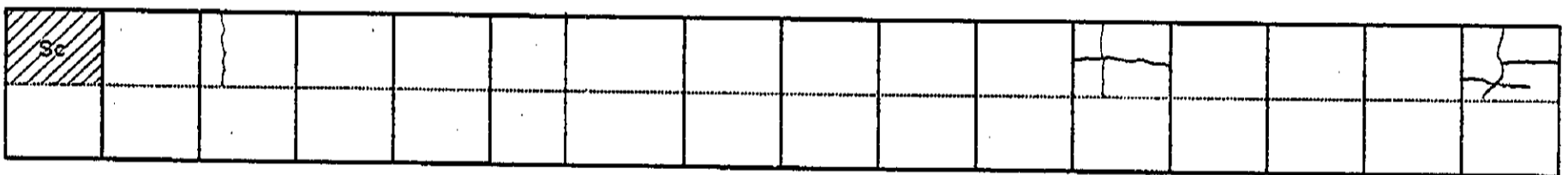
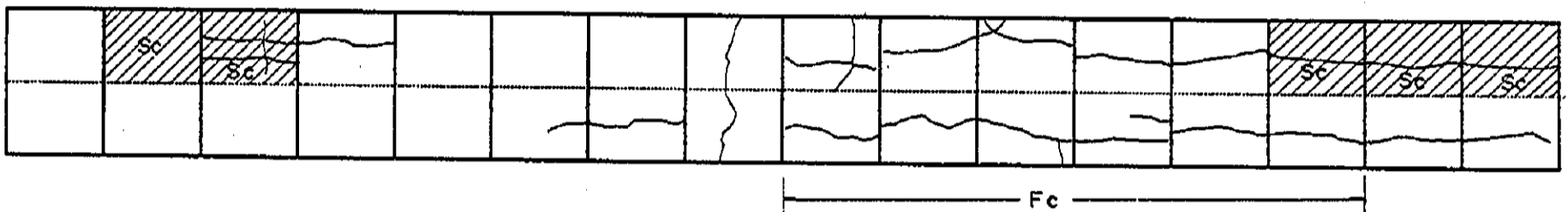
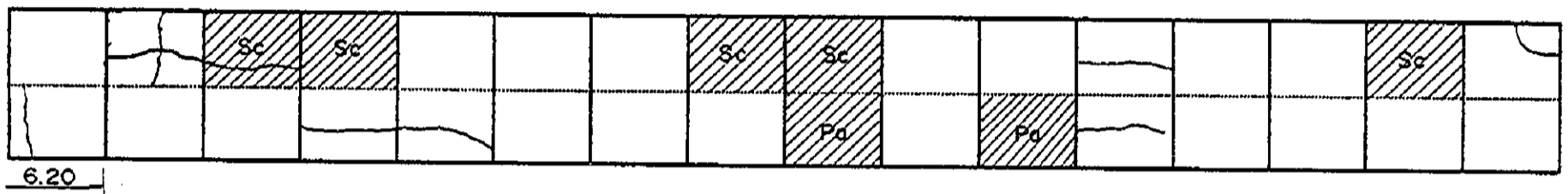
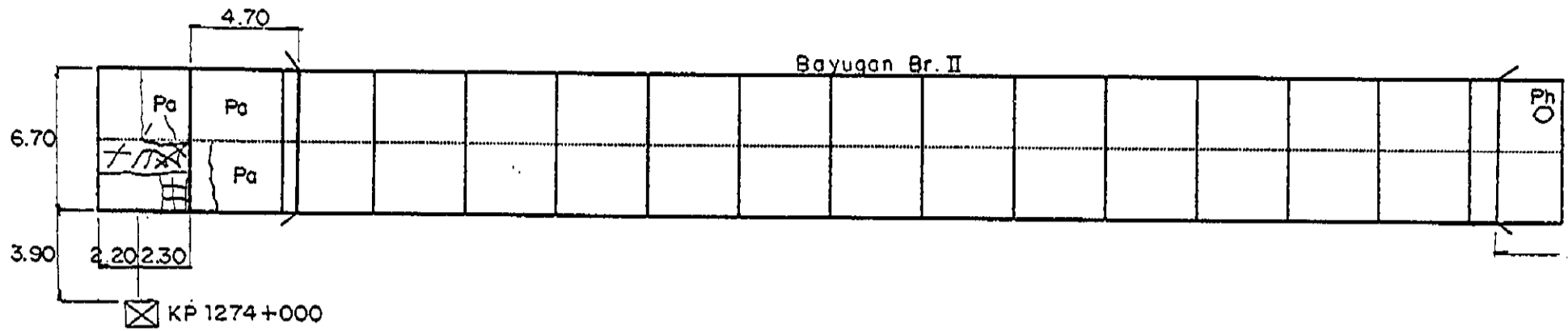

INVENTORY OF PAVEMENT SURFACE CONDITION

Km. 1274+000

Date: 10-16-95

Sheet No: 2/3

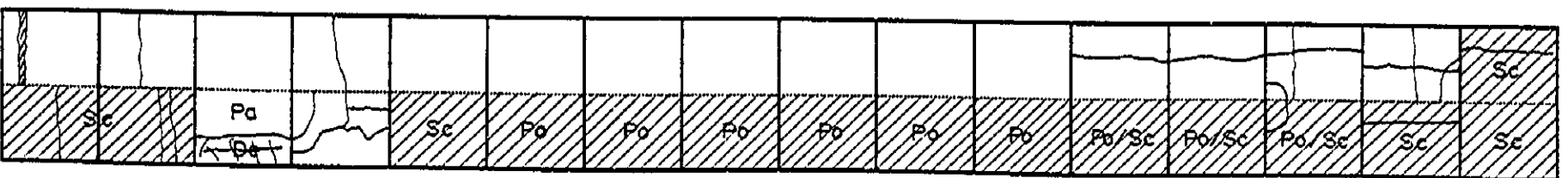
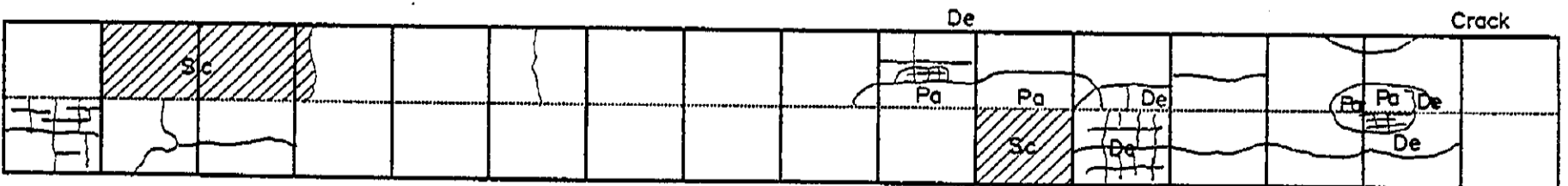
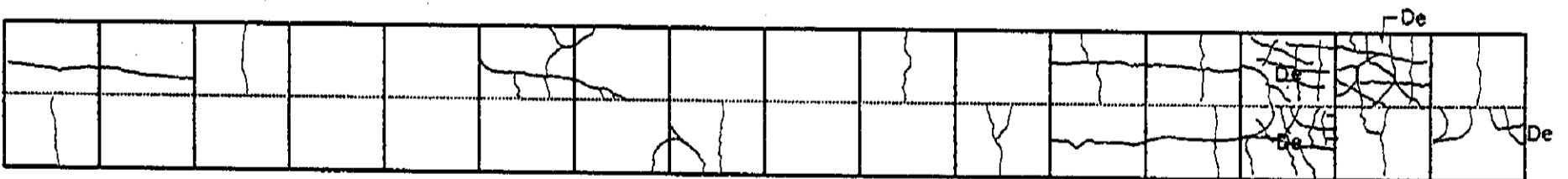
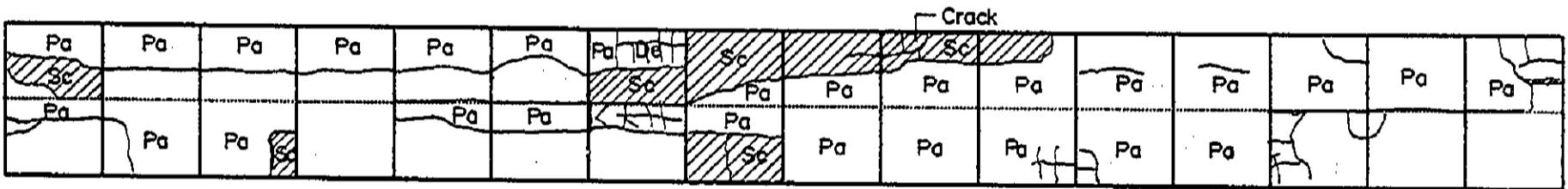
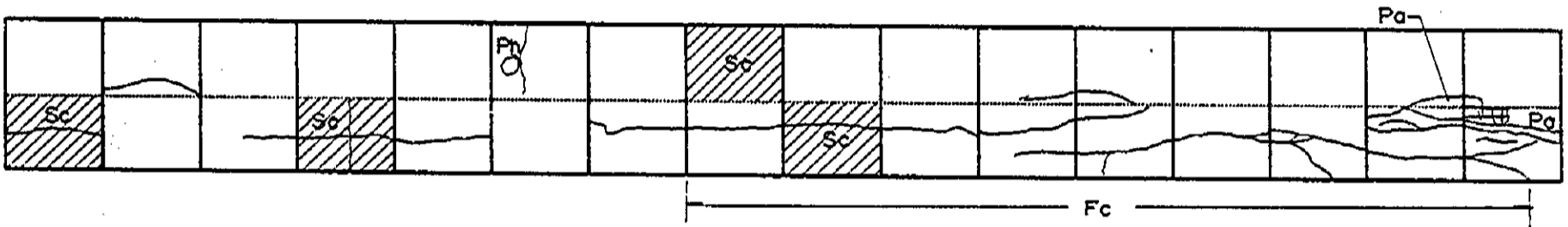
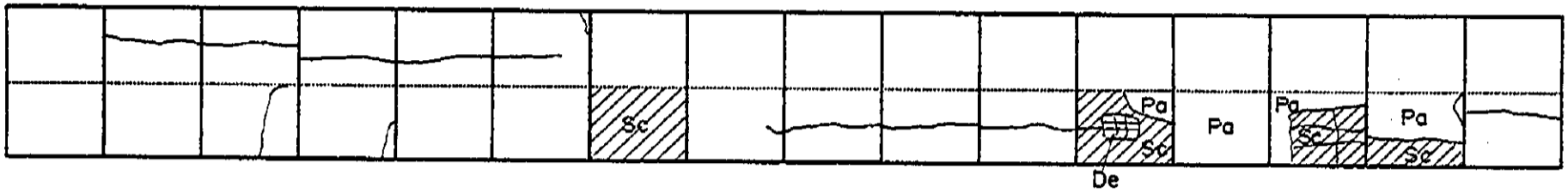
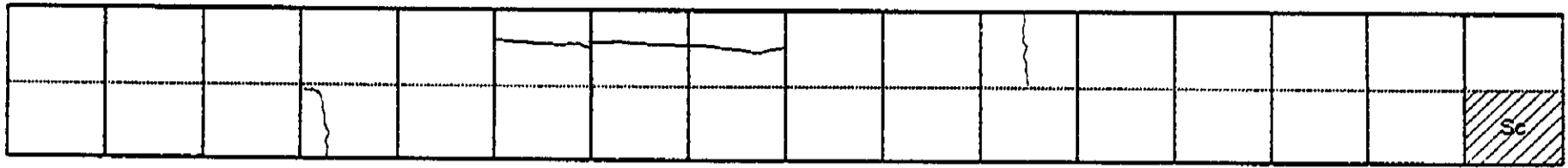

INVENTORY OF PAVEMENT SURFACE CONDITION

Date: 10-16-95

Km. 1275+000

Sheet No: 1/2

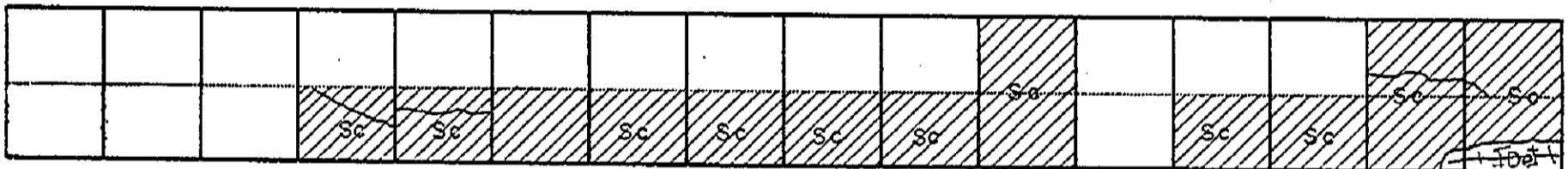
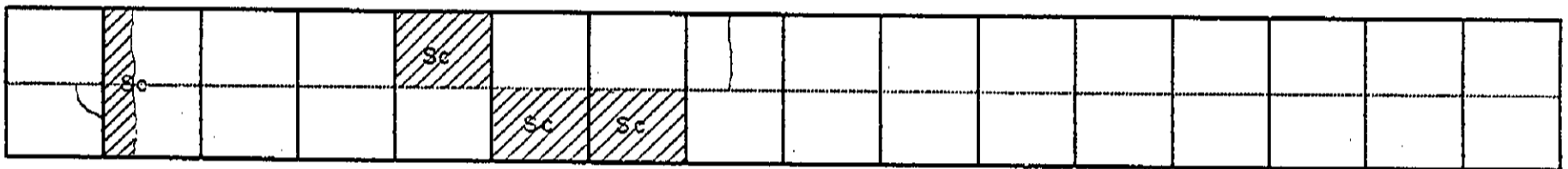
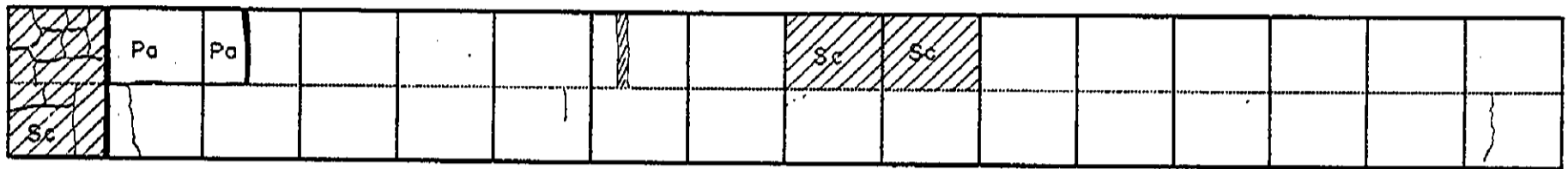
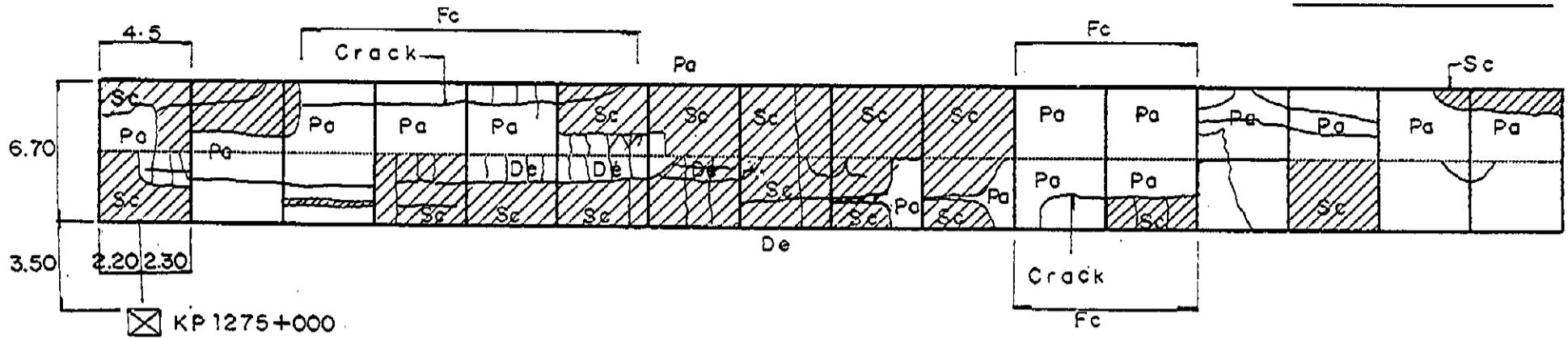

F_c

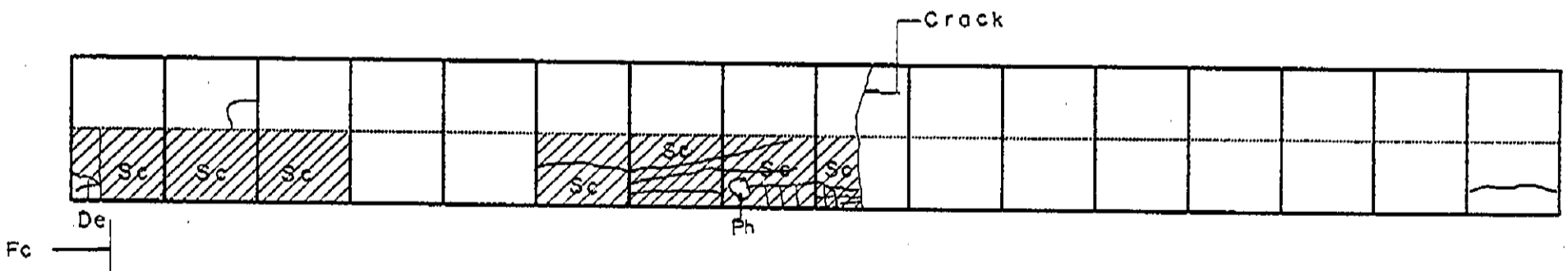

F_c

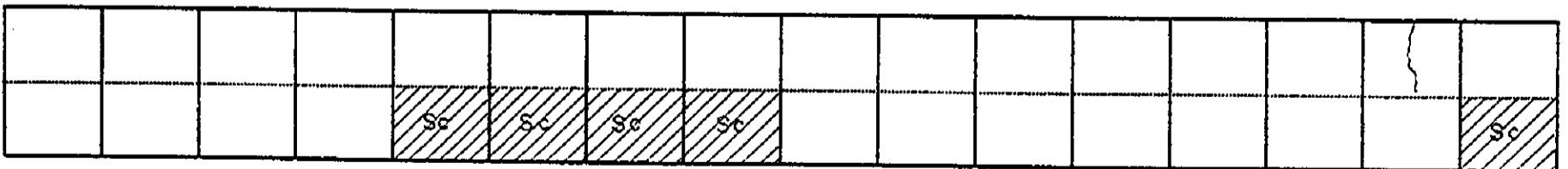

F_c

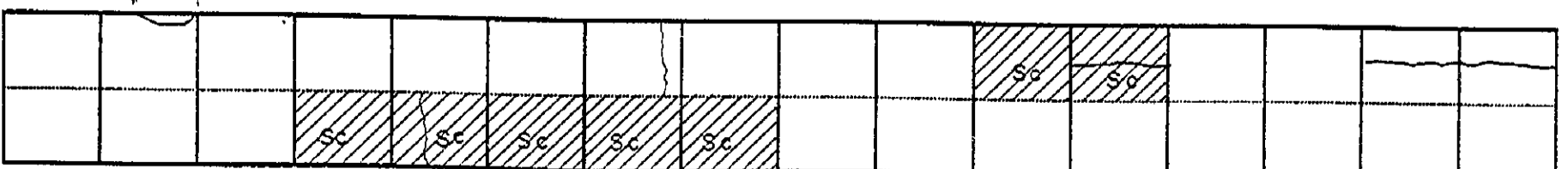

INVENTORY OF PAVEMENT SURFACE CONDITION

Km. 1275+000

Date: 10-16-95

Sheet No: 2/2

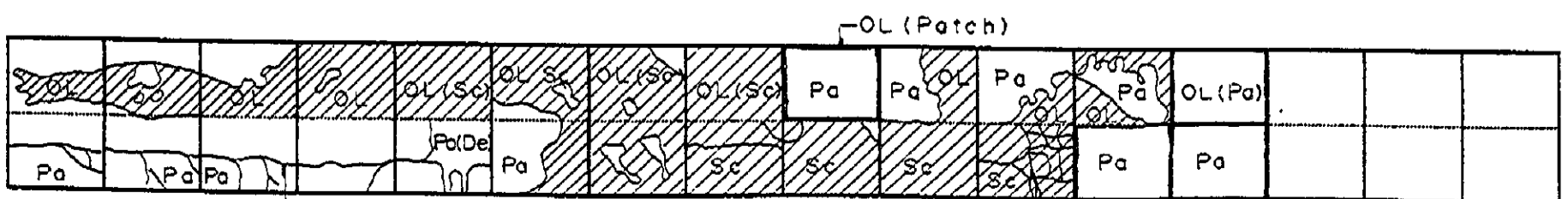
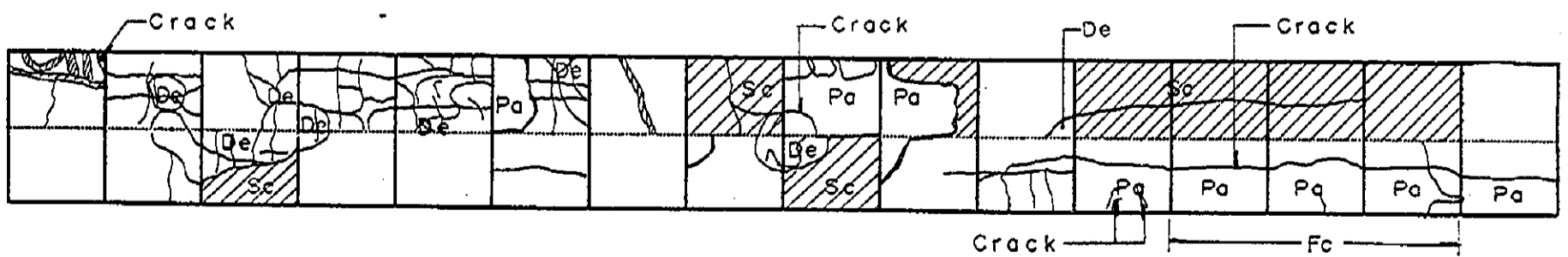
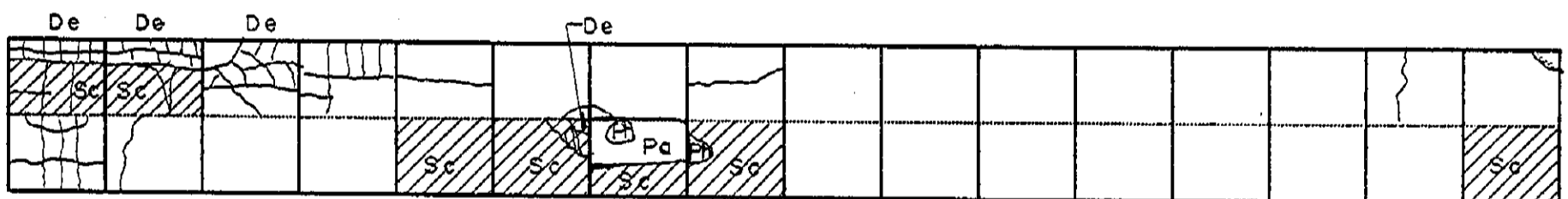
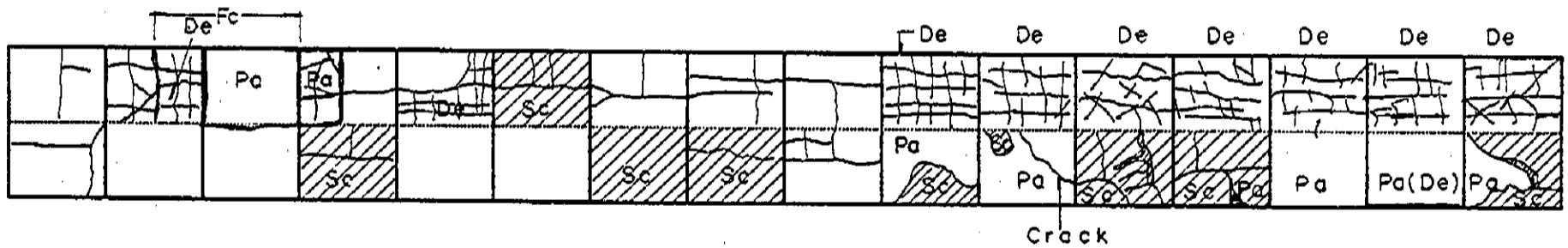
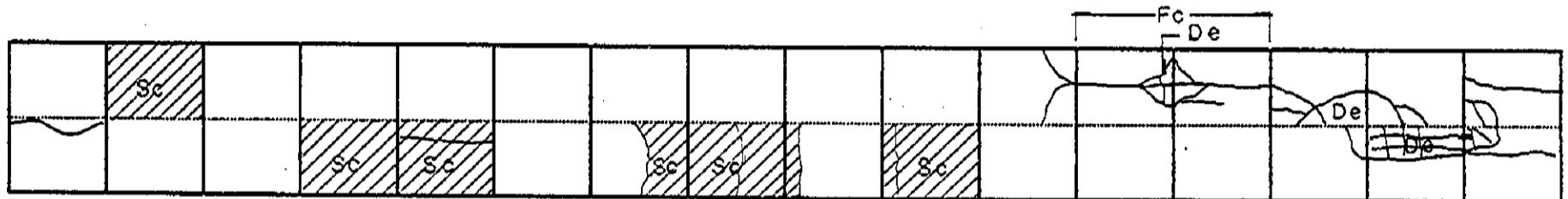
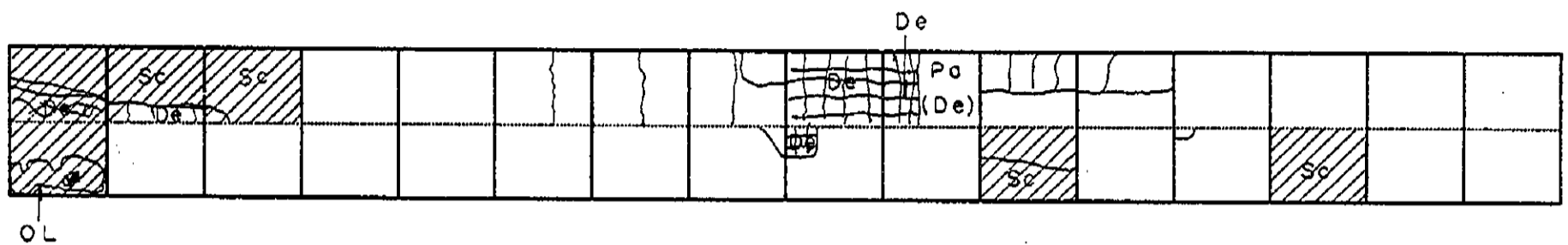
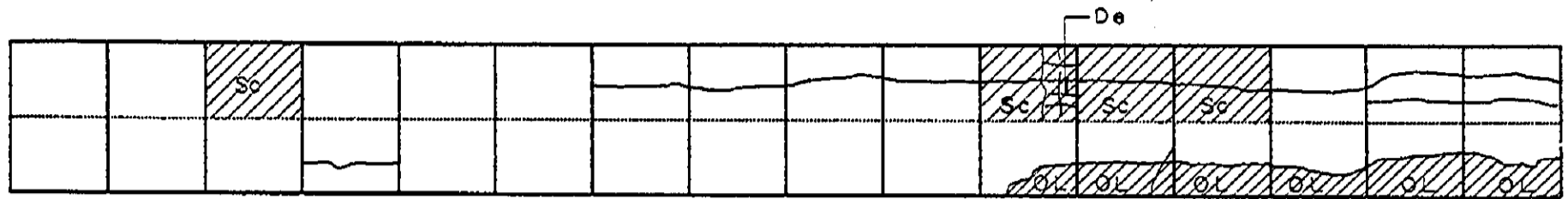

4.15
3.55
☒ KP1276+000