

TABLAS



Tabla 1.1-1 (1/2) Resumen del Plan Maestro

Stage	Category	Objective	Project	Outcome	Procedure	Timing	Responsible agency #1	Effectiveness #2 (US\$1,000)	Economic priority	Financial cost (US\$1,000)	Method of cost recovery	Report reference (Vol. 2)		
Short Term Program	Technical measure	Water quality improvement	Installation of treatment plant to existing factories and piggeries	Reduction of BOD pollution of 0.49 kg/day Reduction of SS pollution	Installation of treatment plant to factories with support of institutional measures	2000-2003	(1) Factory and piggery owners (2) ACRIT	\$3,864 /ton/day	4	\$11,998	Factory and piggery owners pay the cost	6.1.1 (Vol. 2)		
			Installation of treatment plant to factories (heavily congested)	Reduction of BOD pollution of 0.67 ton/day, SS and Toxicant	Installation with support of institutional measures	2000-2003	(1) Factory owners (2) ACRIT	\$2,473/ton/day	3	\$10,791	-do-	6.1.1 (Vol. 2)		
			Installation of sewage treatment plant and its operation	Reduction of BOD pollution of 2.70 ton/day	Installation of sewage treatment plant in the area of Occumate del Tuy	1997-2003	(1) ACRIT (2) State Gov.	\$1,333/ton/day	2	\$28,020	Charge to households and factories	6.1.1 (Vol. 2)		
			Reforestation	Reduction of BOD pollution of 4.07 ton/day*5	Installation in the area of Las Teñeras	2000-2003	(1) ACRIT (2) State Gov.	\$422 /ton/day	1	\$12,700	- do -			
				Reduction of Turbidity of 35 mg/l	Reforestation in Mantana basin	1997-2003	(1) ACRIT (2) State Gov.	\$9.1/mg/l	1	\$2,520	Government pay the cost	6.1.1 (Vol. 2)		
				Securement of water quantity by newly developed water of 2.0 m ³ /s	O-Tuy III pumping and construction of Cuare dam	Construction of pump and dam	1997-2003	(1) Hidrocapital	\$6,290/m ³ /s	1	\$85,980	Charge to households in CMA	6.1.2 (Vol. 2)	
				Securement of water quantity of 0.023 m ³ /s	Installation of sand settling pond at Torre de Agua	Installation of sand settling pond at Torre de Agua	1997-2003	(1) Hidrocapital	\$15,130/m ³ /s	3	\$2,610	-do-	6.1.1 (Vol. 2)	
				Securement of water quantity of 0.024 m ³ /s	Installation of treatment plant to factories	Installation of treatment plant to factories related to odor and color	1997-2003	(1) Factory and piggery owners (2) ACRIT	\$13,167/m ³ /s	2	\$2,057	-do-	6.1.1 (Vol. 2)	
				Assurance of water quantity and water quality improvement	Provision of law and regulation and operation	Strengthening of control of factory effluent	Approval from higher authority	1997-2003	(1) MARNR (2) CORDIPLAN	N.A.	N.A.	N.A.	N.A.	6.1.3 (Vol. 2)
					Strengthening of the function of organization and operation	Strengthening of enforcement for necessary action taken by agency concerned	Approval from higher authority	1997-2003	(1) ACRIT (2) MARNR	N.A.	N.A.	N.A.	N.A.	6.1.3 (Vol. 2)
		Establishment/operation of monitoring system	Collection of basic information	Confirmation of budgetary allocation	1997-2003	(1) ACRIT (2) MARNR	N.A.	N.A.	1,652	Government pay the cost	6.1.3 (Vol. 2)			
		Establishment of environmental fund and operation	Assistance for necessary works for environment improvement	Establishment of new law	1997-2003	(1) ACRIT (2) FONCRESI/CORP. INDUSTRIA	N.A.	N.A.	24,846	Repayment by borrowers	6.1.3 (Vol. 2)			
		Establishment/operation of pollution charge	Promotion of installation of treatment plant for factories/piggeries	Establishment of new law	1997-2003	(1) ACRIT	N.A.	N.A.	N.A.	N.A.	6.1.3 (Vol. 2)			
		Establishment/operation of public education system	Awareness by public on significance of environment problem	Approval from higher authority	1997-2003	(1) ACRIT (2) State Gov., private sector	N.A.	N.A.	50	Government pay the cost	6.1.3 (Vol. 2)			

*1 (1): Implementing Agency/Body (2): Related Agency/Body
 *2 Cost Effectiveness = Annual Cost / Outcome (Annual Cost = Initial Cost x annuity factor (0.11 to 0.13) + O&M Cost)
 *3 Priority is confirmed through the pre-feasibility study
 *4 The cost shows that establish the Environmental Fund including loan amortizations for factories and piggeries
 *5 Outcome at the Doen de Chiquin
 N.A.: not applicable

Tabla 1.1-1 (2/2) Resumen del Plan Maestro

Stage	Category	Objective	Project	Outcome	Procedure	Timing	Related agency *1	Effectiveness *2 (US\$1 000)	Economic priority	Financial cost (US\$1 000)	Method of cost recovery	Report reference
Mid Term Program	Technical measure	Water quality improvement and Securement of water Quantity	Installation of treatment plant to factories (newly constructed)	Reduction of BOD pollution of 1.17 ton/day Reduction of SS pollution Reduction of toxicant measure	Installation of treatment plant to factories with support of institutional measure	2004-2010	(1) Factory (2) ACRT	\$2,441/ton/day	2	\$18,606	Factory owners pay the cost	6.1.1 (Vol.2)
			Installation of sewage treatment plant and its operation	Reduction of BOD pollution of 0.55 ton/day	Installation of sewage system in the area of S.F. de Yare	2004-2010	(1) ACRT (2) State Gov.	\$3,440/ton/day	4	\$14,100	Charge to households and factories	6.1.1 (Vol.2)
			Installation of sewage treatment plant and its operation	Reduction of BOD pollution of 0.27 ton/day	Extension of sewage system in the area of Oxumare del Tuy	2004-2010	(1) ACRT (2) State Gov.	\$2,640/ton/day	3	\$4,914	Charge to households and factories	6.1.1 (Vol.2)
			Installation of sewage treatment plant and its operation	Reduction of BOD pollution of 2.30 ton/day	Installation of sewage system in the area of Oxumare del Tuy EL Consejo	2007-2010	(1) ACRT (2) State Gov.	\$757 /ton/day	1	\$13,100	Charge to households and factories	6.1.1 (Vol.2)
			Reforestation	Reduction of turbidity of 70 mg/l	Reforestation in two tributaries (Odo, Guayes and Cagua)	2004-2010	(1) ACRT (2) State Gov.	\$8.5/mg/l	1	\$5,130	Government pay the cost	6.1.1 (Vol.2)
			Sand settling pond in tributaries	Reduction of turbidity of 225 mg/l	Construction in 4 tributaries	2004-2010	(1) ACRT	\$8.4/mg/l	2	\$11,391	Government pay the cost	6.1.1 (Vol.2)
			Sustainable enforcement of monitoring	Sustainable enforcement of basic information	Continuous operation	2004-2010	(1) ACRT	N.A.	N.A.	Continuation of Short Term	Government pay the cost	6.1.4 (Vol.2)
			Sustainable enforcement of strengthening of control	Strengthening of enforcement for necessity action taken by agency concerned	Continuous operation	2004-2010	(1) ACRT	N.A.	N.A.	Continuation of Short Term	Government pay the cost	6.1.3 (Vol.2)
			Sustainable enforcement of public education	Education for school, manufacturers and inhabitants	Continuous operation	2004-2010	(1) ACRT	N.A.	N.A.	Continuation of Short Term	Government pay the cost	6.1.3 (Vol.2)
			Sustainable enforcement of application of environmental fund	Assistance for necessary works for environment improvement	Continuous operation	2004-2010	(1) ACRT	N.A.	N.A.	US\$18,606	Repayment by borrowers	6.1.3 (Vol.2)
	Institutional measure	Water quality improvement and Securement of water Quantity	Sustainable enforcement of application of pollution charge	Promotion of installation of treatment plant for factories and piggeries	Continuous operation	2004-2010	(1) ACRT	N.A.	N.A.	N.A.	N.A.	6.1.3 (Vol.2)

*1 (1): Responsible Agency/Body (2): Related Agency/Body *2 Cost Effectiveness = Annual Cost / Outcome (Annual Cost = Initial Cost x 0.11 + O&M Cost) N.A.: not applicable

Table 2.1-1 Numero de Fabricas y Empleados en las ciudades

CUV	City	Colonia Tovar	El Consejo	Las Tijeras	Guaya	Car	Panorama	San Diego de los Andes	San José de los Andes	Chimene	Finlaya	Orizaba del Tuy	San Francisco de Yare	Total
		Total	San José de los Andes	Sector Michelena	Sector Michelena	Orizaba	Orizaba	Orizaba	Orizaba	Orizaba	Orizaba	Orizaba	Orizaba	
31100	Food product factory excl. soft drinks						1(203)			1(691)			1(26)	3(920)
31111	Abattoirs for cattle, pigs, sheep, horses and rabbits			1(45)	1(90)					1(33)				3(168)
31112	Farms of chickens and other animals		1(80)		1(328)									3(408)
31113	Preparation and manufacture of food containers	1(34)		2(261)						1(56)				4(311)
31121	Milk pasteurization and bottling					1(14)								1(14)
31123	Biscuits, shortcake and cookies									1(390)			1(286)	2(676)
31221	Production of animal feed			1(59)	1(39)									2(78)
31311	Distillery		1(57)									1(440)		3(1013)
31341	Production of soft drinks												1(18)	1(18)
31342	Bottling and purification of natural mineral waters								1(49)					1(49)
Subtotal of food related factories		1(34)	2(633)	4(345)	3(437)	1(14)	1(203)	0	1(49)	4(1170)	0	1(440)	3(330)	21(3115)
32111	Manufacturer of textile fibers			1(253)		1(23)								2(76)
32112	Spinning, weaving and finishing of wool and mixed fibers					1(11)						1(37)		2(49)
32113	Spinning, weaving and finishing of cotton, artificial, synthetic and mixed fibers			2(159)		2(120)				5(76)	1(150)	1(61)		12(1576)
32211	Tannery, finishing of leather						1(41)							1(41)
32221	Tannery						2(65)							2(65)
35131	Synthetic resin, plastic materials and artificial fibers					1(28)								1(28)
35135	Synthetic resin, plastic materials and artificial fibers			1(117)		1(28)				1(700)		1(37)		4(182)
35211	Manufacturer of paint and varnishes			1(11)		1(55)				3(821)			1(16)	6(914)
35231	Manufacturer of soaps and cleaning products			1(48)	1(256)		1(39)			1(210)			3(748)	3(731)
35234	Manufacturer of perfumes and cosmetics													0
35281	Manufacturer of polishing products, waxes and polishes			2(72)										2(72)
35282	Manufacturer of adhesive, glue and priming for brick factory									1(45)				1(45)
35285	Manufacturer of adhesive materials, glue, putty, and paper									1(18)				1(18)
36200	Pottery and porcelain maker												1(80)	1(80)
36201	Production of fiberglass					1(15)	1(77)							2(77)
36991	Manufacturer of floor tiles					1(300)							1(1039)	2(1339)
3699	Manufacturer of other non-metallic products										1(42)			1(42)
37102	Production of iron and steel and pipes and accessories					1(17)	1(24)			1(56)				3(166)
37201	Production of non-ferrous metals and alloys			1(180)		3(218)					1(41)		1(85)	6(524)
38191	Manufacturer of metallic products, excl. machinery			1(22)			2(130)						1(53)	4(205)
38193	Metal plating		1(25)	2(346)		1(25)	1(53)			2(321)		2(141)		3(911)
38431	Car parts factory			1(296)										1(296)
38433	Automobile spare parts factory					2(410)		1(217)		1(170)		1(26)		5(822)
	Sand mining			1(7)		2(19)	2(15)					2(16)	1(7)	1(68)
Subtotal of non-food related factories		0	1(25)	14(178)	1(236)	10(179)	11(443)	1(212)	0	13(211)	4(945)	3(318)	9(1568)	12(3566)
Total		1(34)	3(678)	18(233)	4(693)	13(193)	11(646)	1(212)	1(49)	17(381)	4(943)	4(758)	12(1898)	33(13020)

Note: Employee numbers in parentheses

Table 2.2-1 Condiciones de Tratamiento de Aguas Residuales en Fabricas y Cochineras

Classification of Factories		Total Factories Number	Factories Number Sampled			
Industry	Scale		Total	Fulfilling Standard	Not-fulfilling Std.	
						T.P. exist
Food Production	large	5	5	3	1	1
	middle	9	9	2	1	6
	small	7	7	5	0	2
Manufacturing of Textile	large	4	2	1	0	1
	middle	5	4	1	1	2
	small	6	3	1	0	2
Chemical & others	large	4	2	1	1	0
	middle	9	3	2	0	1
	small	15	3	2	0	1
Metal Manufacturing	large	5	4	1	1	2
	middle	11	6	5	0	1
	small	12	6	1	0	5
Tannery	large	0				
	middle	0				
	small	3	3	0	0	3
Sand Quarries	large	0				
	middle	0				
	small	8	8	0	0	8
Piggery	large	11	5		4	1
	middle	10	4	2	1	1
	small	12	4		3	1
Sub-Total	large	29	18	6	7	5
	middle	44	26	12	3	11
	small	63	34	9	3	22
Total		136	78	27	13	38

note : T.P. is Wastwater Treatment Plant

Unit cost

Table 2.2-2 Costo de Instalacion de Planta de Tratamiento Existente

Food Product Industry

Reference Number	Discharge (m3/day)	Employee	Surveyed Cost (\$)
F2	25	119	104,000
F3	1,008	328	1,001,168
F4	200	390	344,800
F8	32	14	63,850
F9	320	440	510,800
F66	43	90	117,100
other area	500		276,000

Metal Manufacturing

Reference Number	Discharge (m3/day)	Employee	Surveyed Cost (\$)
N16	42	211	175,042
N18	15	296	40,634
N21	29	41	30,946
N26	100	350	156,000
N31	11	63	50,000
N40	40	160	74,136
N77	7	25	122,200

Manufacturing of Textile

Reference Number	Discharge (m3/day)	Employee	Surveyed Cost (\$)
N13	552	227	420,100
N15	749	379	389,800
N28	30	37	132,000
N41	80	45	160,000

Sand Quarries

Reference Number	Discharge (m3/day)	Employee	Surveyed Cost (\$)
S1	2,000	11	14,924
S2	1,000	8	
S3	1,200	7	

Chemical Industry

Reference Number	Discharge (m3/day)	Employee	Surveyed Cost (\$)
N14	1	11	30,000
N17	9	236	200,000
N25	50	700	465,000
N32	300	1,039	267,492
N33	20	50	76,000
N38	90	300	81,600

Piggery

Reference Number	Discharge (m3/day)	Piggs	Surveyed Cost (\$)
No.13	10	1,500	12,000
N0.25	13	1,800	28,000

Tannery

Reference Number	Discharge (m3/day)	Employee	Surveyed Cost (\$)
N10	11	6	
N11	60	59	46,780
N93	59	41	

Table 2.3-1 Perfil de especificacion y Composicion de la Planta de-
(1/7) Tratamiento Estandar
(Biological Treatment Process)

1. Condition of Wastewater

Industry	Quality of raw water	Quality of treated water	Scale of Quantity	Quantity to be treated
Food Production	BOD: 2000mg/l SS: 500mg/l	BOD: 60mg/l SS: 80mg/l	middle	200 m ³ /day
			large	500 m ³ /day
			small	40 m ³ /day

2. Flowchart of treatment (standard case)

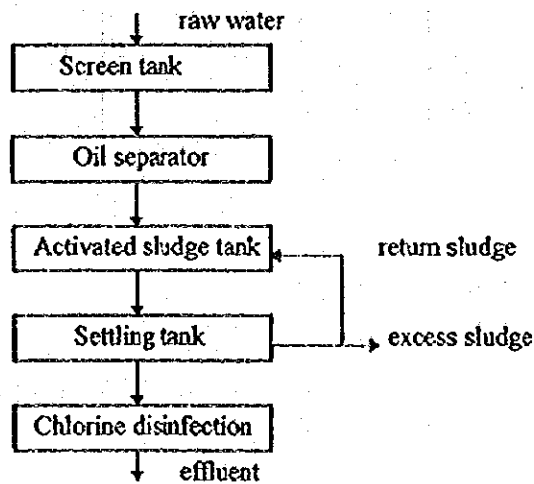

3. Composition of treatment system

Category	Item	Residence time	Abstract	Tank capacity (m ³)			Cost ratio*	
				middle	large	small	large	small
Treatment tank	Screen tank	10 min.	extended aeration & oil separation	1.4	3.5	no	1.6	0
	Oil separator	6 hours		50	125	10	1.6	0.3
	Activated sludge tank	24 hours		200	500	40	1.6	0.3
	Settling tank	2 hours		18	40	3	1.6	0.3
	Chlorination unit	-		-	-	-	-	-
Incidental facilities	Pump & Aerator etc.						2.0	0.3
Instrumentation & Control	Measuring device						1.2	0.7
	Control system							

Table 2.3-1 Perfil de especificacion y Composicion de la Planta de Tratamiento Estandar
(2/7) Tratamiento Estandar
(Combination of Biological and Physio-Chemical Treatment Process)

1. Condition of Wastewater

Industry	Quality of raw water	Quality of treated water	Scale of Quantity	Quantity to be treated
Manufacturing of textile	BOD: 400mg/l SS: 200mg/l	BOD: 60mg/l SS: 80mg/l	middle	100 m ³ /day
			large	300 m ³ /day
			small	30 m ³ /day

2. Flowchart of treatment (standard case)

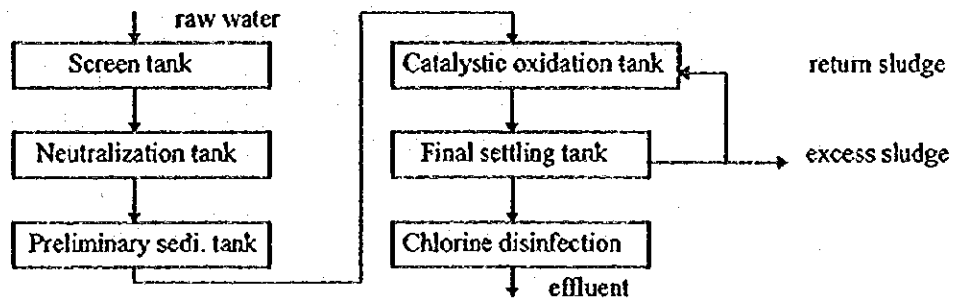

3. Composition of treatment system

Category	Item	Residence time	Abstract	Tank capacity (m ³)			Cost ratio*	
				middle	large	small	large	small
Treatment tank	Screen tank	10 min.	catalytic oxidation & solid-liquid separation	1	2	no	1.6	0
	Neutralization	30 min.		2	5	0.5	1.6	0.4
	Pre. settling tank	30 min.		2	5	0.5	1.6	0.4
	Catalytic oxidation tank	4 hours		17	50	5	1.6	0.4
	Settling tank	60 min.		5	13	1.5	1.6	0.4
	Chlorination unit	-		-	-	-	-	-
Incidental facilities	Pump Aerator Mixing unit etc.						1.5	0.5
Instrumentation & Control	Measuring device Control system						1.3	0.7

Table 2.3-1 Perfil de especificacion y Composicion de la Planta de
(3/7) Tratamiento Estandar.
(Physio-Chemical Treatment Process)

1. Condition of Wastewater

Industry	Quality of raw water	Quality of treated water	Scale of Quantity	Quantity to be treated
Chemical and others	BOD: 250mg/l SS: 100mg/l COD: 1000mg/l	BOD: 60mg/l SS: 80mg/l	middle	40 m ³ /day
			large	100 m ³ /day
			small	20 m ³ /day

2. Flowchart of treatment (standard case)

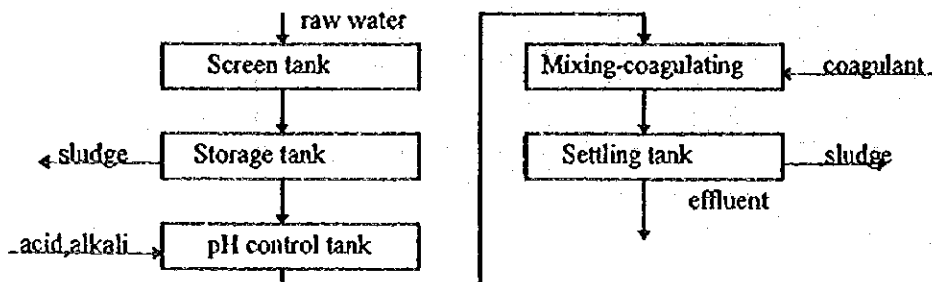

3. Composition of treatment system

Category	Item	Residence time	Abstract	Tank capacity (m ³)			Cost ratio*	
				middle	large	small	large	small
Treatment tank	Screen tank	10 min.	Coagulation & solid-liquid separation	0.3	0.7	0.1	1.6	0.6
	Storage tank	6 hours		10	25	5	1.6	0.6
	pH control tank	30 min.		0.8	2.0	0.4	1.6	0.6
	Mixing-coagulating tank	30 min.		0.8	2.0	0.4	1.6	0.6
	Settling tank	6 hours		10	25	5	1.6	0.6
Incidental facilities	Pump Aerator Mixing unit etc.						1.5	0.5
Instrumentation & Control	Measuring device Control system						1.2	0.8

Table 2.3-1 Perfil de especificacion y Composicion de la Planta de
(4/7) Tratamiento Estandar

(Combination of Biological and Physio-Chemical Treatment Process)

1. Condition of Wastewater

Industry	Quality of raw water	Quality of treated water	Scale of Quantity	Quantity to be treated
Tannery	BOD: 700mg/l	BOD: 60mg/l	middle	-
	SS: 500mg/l	SS: 80mg/l	large	-
	Cr: 100mg/l	Cr: 2mg/l	small	50 m ³ /day

2. Flowchart of treatment (standard case)

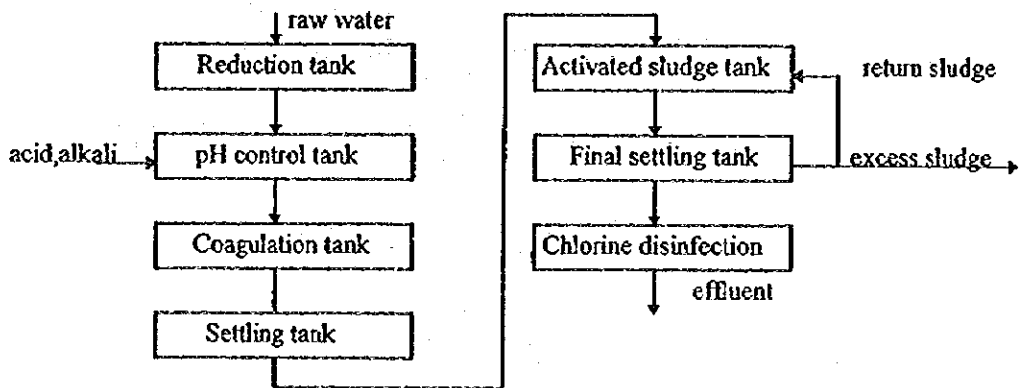

3. Composition of treatment system

Category	Item	Residence time	Abstract	Tank capacity (m ³)			Cost ratio*	
				middle	large	small	large	
Treatment tank	Reduction tank	1 hour	Reduction, Coagulation & solid-liquid separation	-	-	2.0	-	-
	pH control tank	30 min.		-	-	1.0	-	-
	Coagulation tank	30 min.		-	-	1.0	-	-
	Settling tank	2 hours		-	-	4.0	-	-
	Aeration tank	4 hours		-	-	8.0	-	-
	Final settling tank	1 hour		-	-	2.0	-	-
	Chlorination unit	-		-	-	-	-	-
Incidental facilities	Pump Aerator Mixing unit etc.						-	-
Instrumentation & Control	Measuring device Control system						-	-

Table 2.3-1 Perfil de especificacion y Composicion de la Planta de
(5/7) Tratamiento Estandar
(Physio-Chemical Treatment Process)

1. Condition of Wastewater

Industry	Quality of raw water	Quality of treated water	Scale of Quantity	Quantity to be treated
Metal manufacturing	Cr: 100mg/l Cu: 30mg/l	Cr: 2mg/l Cu: 1mg/l	middle	30 m ³ /day
			large	100 m ³ /day
			small	10 m ³ /day

2. Flowchart of treatment (standard case)

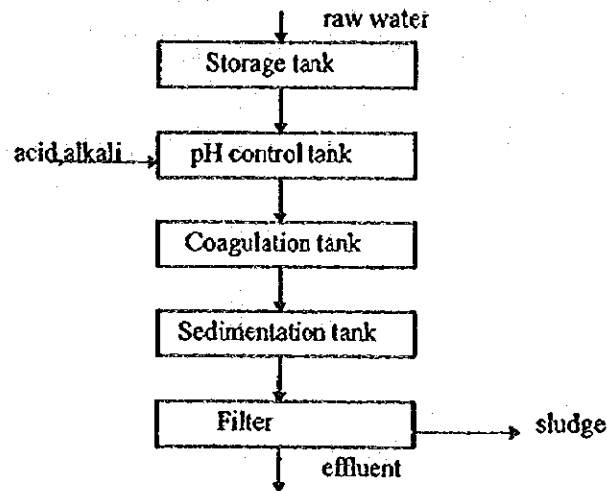

3. Composition of treatment system

Category	Item	Residence time	Abstract	Tank capacity (m ³)			Cost ratio*	
				middle	large	small	large	small
Treatment tank	Storage tank	12 hours	Coagulation solid-liquid separation	15	50	5	1.5	0.6
	pH control tank	30 min.		0.6	2	0.2	1.5	0.6
	Coagulation tank	30 min.		0.6	2	0.2	1.5	0.6
	Sedim. tank	6 hours		7.5	25	2.5	1.5	0.6
Incidental facilities	Pump						1.3	0.8
	Mixing unit							
	Filter etc.							
Instrumentation & Control	Measuring device						1.2	0.8
	Filling system							

Table 2.3-1 Perfil de especificacion y Composicion de la Planta de
(6/7) Tratamiento Estandar
(Physio-Chemical Treatment Process)

1. Condition of Wastewater

Industry	Quality of raw water	Quality of treated water	Scale of Quantity	Quantity to be treated
Sand quarries	SS: 2000 mg/l	SS: 80mg/l	middle	-
			large	-
			small	2000 m3/day

2. Flowchart of treatment (standard case)

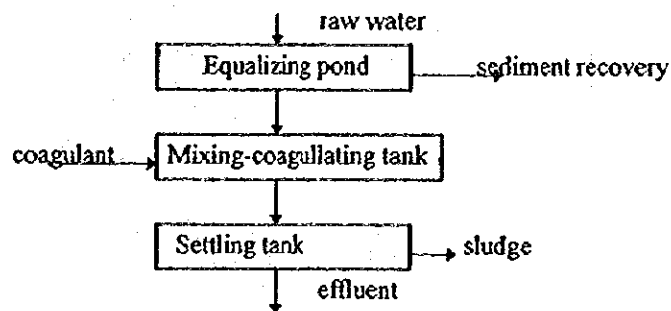

3. Composition of treatment system

Category	Item	Residence time	Abstract	Tank capacity (m3)			Cost ratio*	
				middle	large	small	large	small
Treatment tank	Equalizing pond	24 hours	Coagulation and solid-liquid separation	-	-	2000		
	Mixing-coagulating tank	10 min.		-	-	15		
	Settling pond	120 min.		-	-	180		
Incidental facilities	Pump Mixing unit							
Instrumentation & Control	Filling system							

Table 2.3-1 Perfil de especificacion y Composicion de la Planta de
(7/7) Tratamiento Estandar
(Biological Treatment Process)

1. Condition of Wastewater

Industry	Quality of raw water	Quality of treated water	Scale of Quantity	Quantity to be treated
Piggery	BOD: 7000mg/l SS: 10000mg/l	BOD: 60mg/l SS: 80mg/l	middle	15 m ³ /day
			large	5 m ³ /day
			small	40 m ³ /day

2. Flowchart of treatment (standard case)

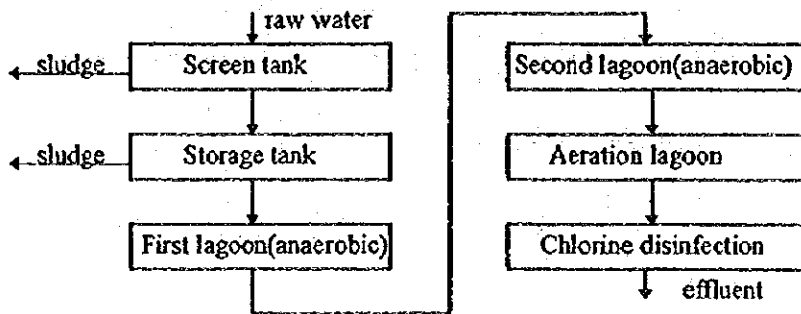

3. Composition of treatment system

Category	Item	Residence time	Abstract	Tank capacity (m ³)			Cost ratio*	
				middle	large	small	large	
Treatment tank	Screen tank	1 hour	solid-liquid separation & aeration lagoon	1	2	1	1.8	0.6
	Storage tank	24 hour		15	40	5	1.8	0.6
	First lagoon	10 days		150	400	50	1.8	0.6
	Second lagoon	10 days		150	400	50	1.8	0.6
	Aeration lagoon	30 days		450	1200	150	1.8	0.6
	Chlorination unit	-		-	-	-	-	1.8
Incidental facilities	Floating aerator Pump etc.						1.8	0.4
Instrumentation & Control	Measuring device Control system						1.3	0.6

Table 2.3-2 Costo de Instalacion de la Planta de Tratamiento Estandar

Treatment Plant Process	Industry	Scale	Quantity (m3/day)	Installation Cost (Thousand US\$)			
				Treatment Tank	Incidental Facilities	Instrument	Total
Biological	Food	Small	60	125	75	50	250
		Middle	200	290	130	80	500
		Large	500	355	200	96	651
Biological plus Physio-chemical	Textile	Small	30	40	40	70	150
		Middle	100	100	80	100	280
		Large	300	170	122	130	422
Physio-chemical	Chemical	Small	20	20	30	40	90
		Middle	40	30	50	90	170
		Large	100	50	70	105	225
Physio-chemical	Metal	Small	20	15	25	35	75
		Middle	50	40	50	98	188
		Large	100	100	110	129	339
Physio-chemical	Tannery	Small	20	70	75	85	230
		Middle					
		Large					
Sedimentation	Sand Quarrie	Small	2,000	15	25	28	68
		Middle	-	-	-	-	-
		Large	-	-	-	-	-
Biological	Piggery	Small	5	10	10	10	30
		Middle	15	15	13	20	48
		Large	40	30	26	34	90

Table 2.4-1 Costo de Instalacion de Planta de Tratamiento en Fabricas Existentes y Cochineras

Classification of Factories		(1)Unit Cost of Treatment Plant (US\$)	Factory Number			Cost* (US\$)
			GACETA Not-satisfaction		Total	
Industry	Scale		(2)No Treatment Plant	(3)Partly Equipped		
Food Production	large	651,000	1	1	2	976,500
	middle	500,000	6	1	7	3,250,000
	small	250,000	2	0	2	500,000
Manufacturing of Textile	large	422,600	2	0	2	845,200
	middle	280,000	2	1	3	700,000
	small	149,700	4	0	4	598,800
Chemical & others	large	225,400	1	1	2	338,100
	middle	170,000	3	0	3	510,000
	small	90,000	11	0	11	990,000
Metal Manufacturing	large	339,000	3	1	4	1,186,500
	middle	188,000	3	0	3	564,000
	small	75,500	10	0	10	755,000
Tannery	large					0
	middle					0
	small	230,000	3	0	3	690,000
Sand Quarries	large					0
	middle					0
	small	68,000	8	0	8	544,000
Piggery	large	90,000	9	2	11	900,000
	middle	48,000	3	2	5	192,000
	small	29,800	9	3	12	312,900
Sub-Total	large	-	16	5	21	4,246,300
	middle	-	17	4	21	5,216,000
	small	-	47	3	50	4,390,700
Total	-	-	80	12	92	13,853,000

Note: *Cost = (1)x(2)+(1)x(3)x0.5

Table 2.4-2 Costo de Operacion y Mantenimiento de Fabricas Existentes y Cochineras

Industry	Construction Cost(US\$)	Rate of O/M Cost in Construction Cost(%)	Annual O/M Cost (\$/year)
Food Production	4,726,500	8.00	378,120
Manufacturing of Textile	2,144,000	7.50	160,800
Chemical & others	1,838,100	8.60	158,077
Metal Manufacturing	2,505,500	8.50	212,968
Tannery	690,000	7.40	51,060
Sand Quarries	544,000	7.50	40,800
Piggery	1,404,900	7.50	105,368
Total	-	-	1,107,192

Table 2.5-1 Costo de Instalacion de Planta de Tratamiento para Fabricas recientemente construidas hasta 2003

Classification of Factories		Unit Cost of Treatment Plant (US\$)	Factory Number Constructed until 2003	Cost (US\$)
Industry	Scale			
Food Production	large	651,000	2	1,302,000
	middle	500,000	4	2,000,000
	small	250,000	3	750,000
Manufacturing of Textile	large	422,600	1	422,600
	middle	280,000	2	560,000
	small	149,700	2	299,400
Chemical & others	large	225,400	2	450,800
	middle	170,000	5	850,000
	small	90,000	9	810,000
Metal Manufacturing	large	339,000	2	678,000
	middle	188,000	5	940,000
	small	75,500	5	377,500
Tannery	large			
	middle			
	small	230,000	2	460,000
Sand Quarries	large			
	middle			
	small	68,000	1	68,000
Piggery	large	-	-	-
	middle	-	-	-
	small	-	-	-
Sub-Total	large	-	7	2,853,400
	middle	-	16	4,350,000
	small	-	22	2,764,900
Total	-	-	45	9,965,300

Table 2.5-2 Costo de Operacion y Mantenimiento de las Fabricas #03 recientemente construidas hasta 2003

Industry	Construction Cos(US\$)	Rate of O/M Cost in Construction Cost(%)	Annual O/M Cost (\$/year)
Food Production	4,052,000	8.00	324,160
Manufacturing of Textile	1,282,000	7.50	96,150
Chemical & others	2,110,800	8.60	181,529
Metal Manufacturing	1,995,500	8.50	169,618
Tannery	460,000	7.40	34,040
Sand Quarries	68,000	7.50	5,100
Piggery	-	-	-
Total	-	-	796,228

Table 3.2-1 Volumen de Sedimento en el Tanque de Pre-tratamiento por un año

Pond No.	Date of Cleaning Pond		Sediment		Total V (m³)
	Start	End	Depth (m)	Volum (m³)	
1	1995/11/20	1995/11/23	1.15	2263	22730
1	1995/12/28	1995/12/29	1.00	1968	
1	1996/6/17	1996/6/19	1.00	1968	
1	1996/7/15	1996/7/16	1.80	3542	
1	1996/8/8	1996/8/12	1.50	2952	
1	1996/9/18	1996/9/19	1.50	2952	
1	1996/10/7	1996/10/10	1.30	2558	
1	1996/10/28	1995/10/29	1.10	2165	
1	1996/11/18	1996/11/21	1.20	2362	
2	1995/11/22	1995/11/22	1.00	1968	
2	1996/1/2	1996/1/3	1.10	2165	
2	1996/6/20	1996/6/21	1.00	1968	
2	1996/7/17	1996/7/18	2.00	3936	
2	1996/8/23	1996/8/28	2.50	4920	
2	1996/9/20	1996/9/23	1.00	1968	
2	1996/10/9	1996/10/11	1.20	2362	
2	1996/10/30	1996/10/31	1.20	2362	
2	1996/11/22	1996/11/23	1.20	2362	
3	1995/11/24	1995/11/27	1.10	2165	17318.4
3	1996/7/8	1996/7/11	1.50	2952	
3	1996/7/19	1996/7/23	1.60	3149	
3	1996/8/29	1996/9/4	2.50	4920	
3	1996/9/25	1996/9/27	1.00	1968	
3	1996/11/1	1996/11/1	1.10	2165	
4	1995/11/10	1995/11/125	1.00	1968	
4	1996/1/4	1996/1/5	1.00	1968	
4	1996/7/1	1996/7/3	1.20	2362	
4	1996/7/30	1996/7/31	2.00	3936	
4	1996/9/5	1996/9/11	2.00	3936	
4	1996/9/24	1996/9/25	1.00	1968	
4	1996/11/5	1996/11/7	1.30	2558	
5	1995/11/16	1995/11/17	1.50	2952	14760
5	1996/6/27	1996/6/28	1.00	1968	
5	1996/8/6	1996/8/7	1.80	3542	
5	1996/9/30	1996/10/1	1.00	1968	
5	1996/10/22	1996/10/24	1.20	2362	
5	1996/11/8	1996/11/8	1.00	1968	
6	1995/11/20	1995/11/20	1.20	2362	19483
6	1996/6/11	1996/6/13	1.00	1968	
6	1996/8/1	1996/8/6	2.40	4723	
6	1996/9/12	1996/9/18	2.00	3936	
6	1996/10/2	1996/10/4	1.10	2165	
6	1996/10/24	1996/10/25	1.10	2165	
6	1996/11/11	1996/11/11	1.10	2165	
Total (Average intake volume = 3.27m³/s)					

Table 4.2-1 Area de tierra utilizado en Ocumare del Tuy

		Commercial District	Residential District	New Residential District	Industrial District	Forest, Aguri culture...	Others	Total
Present	Area(ha)	51	696	-	191	2,638	60	3,636
	Ratio(%)	1.4	19.2	-	5.2	72.5	1.7	100.0
Future	Area(ha)	63	696	1,650	576	516	134	3,636
	Ratio(%)	1.7	19.2	45.4	15.8	14.2	3.7	100.0

*Commercial district : including high-densly populated residential district

*Forest,Aguriculture... :including protection area

Table 4.2-2 Poblacion de cada Localidad del Area Urbana de Ocumare

	1990	2003	2010
Ocumare del Tuy	61,043	111,715	151,985
Piloncito	4,075	7,458	10,146
Santa Barbara	1,691	3,095	4,210
Total	66,809	122,268	166,341
Remark	OCEI	JICA(M/P)	JICA(M/P)

Table 4.2-3 Distancia de Cañerías Existentes

Diameter(mm)	Distance(m)	Remarks
457	2,000	fÓ18 inch
508	43,900	fÓ20 inch
635	6,750	fÓ25 inch
762	2,525	fÓ30 inch
965	4,275	fÓ38 inch
1168	750	fÓ46 inch
1346	1,950	fÓ53 inch
1753	600	fÓ69 inch

Table 4.3-1 Densidad Poblacional de acuerdo al Uso de Tierra en el area de Tratamiento de Ocumare I

	Area (ha)	1990		2003		2010	
		Population	density	Population	density	Population	density
Commercial District	63	17,997	284	19,020	300	22,190	350
Residential District	696	44,368	64	54,189	78	70,794	102
New Residential District	1,650			40,927	25	62,293	38
Industrial District	576						
Forest, Agriculture...	516						
Etc.	134						
Total	3,636	62,365	17	114,135	31	155,277	43

Table 4.3-2 Numero de Empleo y Descarga Industrial Proyectada en el Futuro (Ocumare del Tuy)

CIU	Category	Discharge flowrate	Employee Numbers					Discharge(m ³ /day)						
			1995	2000	2003	2005	2010	1995	2000	2003	2005	2010		
31100	Nourishing product factory expect soft drinks	2.01	0	0	0	0	0	0	0	0	0	0	0	0
31111	Slaughtering cattle, pigs, sheep, horses and rabbits	2.01	0	0	0	0	0	0	0	0	0	0	0	0
31112	Farms of chicken and other animals expect domestic animals	2.01	0	0	0	0	0	0	0	0	0	0	0	0
31113	Preparation and manufacture of meat	2.01	0	0	0	0	0	0	0	0	0	0	0	0
31121	Milk pasteurization and bottling	2.01	0	0	0	0	0	0	0	0	0	0	0	0
31173	Biscuits, shortcake and noodles	2.01	0	0	0	0	0	0	0	0	0	0	0	0
31221	Production of animal food	2.01	0	0	0	0	0	0	0	0	0	0	0	0
31311	Distillation, rectify and blend of alcohol	0.97	440	590	724	814	1,153	427	572	702	789	1,119		
31341	Production of soft drinks	0.97	0	0	0	0	0	0	0	0	0	0	0	0
31342	Bottling and gasification of natural mineral water	0.97	0	0	0	0	0	0	0	0	0	0	0	0
32111	Preparation of textile	2.43	0	0	0	0	0	0	0	0	0	0	0	0
32112	Spinning, weaving and finishing of wool and mixed fibers	2.43	0	0	0	0	0	0	0	0	0	0	0	0
32113	Spinning, weaving and finishing of cotton, artificial and mixed fibers	2.43	54	64	73	78	101	131	155	176	191	244		
32311	Tannery and repair of leather	1.43	0	0	0	0	0	0	0	0	0	0	0	0
32321	Industry to prepare tanning leather	1.43	0	0	0	0	0	0	0	0	0	0	0	0
35131	Synthetic resins, plastic materials and artificial fibers	2.50	0	0	0	0	0	0	0	0	0	0	0	0
35135	Synthetic resins, plastic materials and artificial fibers, expect glass	2.50	103	124	144	156	205	257	311	359	391	512		
35211	Manufacturing of paint, varnishes and shellac	0.09	0	0	0	0	0	0	0	0	0	0	0	0
35231	Manufacture of soaps and cleaning products	0.09	0	0	0	0	0	0	0	0	0	0	0	0
35234	Manufacture of perfumes and cosmetics	0.09	0	0	0	0	0	0	0	0	0	0	0	0
35291	Manufacture of several chemical products	0.92	67	85	101	111	152	62	78	93	102	140		
35292	Adhesives, alus, priming for clothes	0.92	0	0	0	0	0	0	0	0	0	0	0	0
35295	Manufacture of adhesive materials, glues gelatin and gumes	0.92	0	0	0	0	0	0	0	0	0	0	0	0
36200	Mud, porcelain stuff factory	0.45	0	0	0	0	0	0	0	0	0	0	0	0
36201	Production of glass and glass fiber	0.67	0	0	0	0	0	0	0	0	0	0	0	0
3699	Manufacture of other non-metallic products	0.99	178	204	228	244	304	176	202	225	241	300		
37102	Manufacture of iron and steel without pig metal and without rolling	0.26	0	0	0	0	0	0	0	0	0	0	0	0
37201	Basic industry of aluminium	1.44	0	0	0	0	0	0	0	0	0	0	0	0
38191	Manufacture of metallic products, not expect, expect machinery a	0.26	0	0	0	0	0	0	0	0	0	0	0	0
38193	Factory of nickel plate	0.26	78	93	106	114	147	20	24	27	30	38		
38431	Car(automobiles) factory	0.24	0	0	0	0	0	0	0	0	0	0	0	0
38433	Automobile spare parts factory	0.24	0	0	0	0	0	0	0	0	0	0	0	0
0	TOTAL	-	920	1,160	1,375	1,518	2,061	1,073	1,342	1,583	1,743	2,352		

Tabla 4.3-3 Tasa de Flujo por Residente en Previos Estudios y Planes

No.	Objective Year	Reference	Average Flow per Resident
A	2010	<i>Plan Rector para la Cuenca Alta y Media del Rio Tuy (1995, Michael Schlegel)</i>	250 (l/per/day)
B	2010	<i>Analisis de Sensibilidad para el Modelaje de Calidad de Agua(RIOS) del Rio Tuy</i>	272 (l/per/day)
C	1995	<i>Actualizacion de Proyectos de Inversion Ambiental en la Cuenca del Rio Tuy y su Area de Influencia(1994, Efren Guedez)</i>	By a coefficient of return of 0.8 <ul style="list-style-type: none"> • Ocumare del Tuy $298 \times 0.8 = 238.4$ (l/per/day) • Las Tejerias $258 \times 0.8 = 206.4$ (l/per/day)
D	2010	<i>Actualizacion de Proyectos de Inversion Ambiental en la Cuenca del Rio Tuy y su Area de Influencia(1994, Efren Guedez)</i>	By a coefficient of return of 0.8 <ul style="list-style-type: none"> • Ocumare del Tuy $528.9 \times 0.8 = 476.0$ (l/per/day) • Las Tejerias $461.6 \times 0.8 = 369.3$ (l/per/day)

Daily mean : Daily maximum : Hourly maximum = 0.7 : 1.0 : 1.5

Table 4.3-4 Tasa de Flujo de Diseño de agua residual domestico (Ocumare del Tuy)

	Population (person)	Daily Mean		Daily Maximum		Hourly Maximum	
		Flowrate (m ³ /person/day)	Discharge (m ³ /day)	Flowrate (m ³ /person/day)	Discharge (m ³ /day)	Flowrate (m ³ /person/day)	Discharge (m ³ /day)
1990	62,365	0.207	12,930	0.296	18,472	0.444	27,708
2000	99,186	0.269	26,648	0.384	38,068	0.576	57,103
2003	114,134	0.287	32,764	0.410	46,806	0.615	70,209
2005	124,100	0.299	37,147	0.428	53,068	0.641	79,602
2010	155,277	0.330	51,241	0.471	73,202	0.707	109,803

Table 4.3-5 Tasa de Flujo de Diseño de agua residual Industrial (Ocumare del Tuy)

Year	Daily Mean (m ³ /day)	Daily Maximum (m ³ /day)	Hourly Maximum (m ³ /day)
1995	1,073	1,073	2,146
2000	1,342	1,342	2,684
2003	1,583	1,583	3,165
2005	1,743	1,743	3,487
2010	2,352	2,352	4,705

Remark ; DailyMean : Daily Maximum : Hourly Maximum = 1 : 1 : 2

Table 4.3-6 Tasa de Flujo de Diseño en el Alcantarillado de Ocumare

Target year	2010 (m ³ /day)			2003 (m ³ /day)		
	Daily Mean	Daily Max	Hourly Max	Daily Mean	Daily Max	Hourly Max
Domestic Wastewater	51,241	73,202	109,803	32,764	46,806	70,209
Industrial Wastewater	2,352	2,352	4,705	1,583	1,583	3,165
Infiltration	10,980	10,980	10,980	7,021	7,021	7,021
Total	64,574	86,535	125,488	41,368	55,410	80,395

Note: Infiltration=15% of Daily Maximum of Domestic Wastewater

Table 4.3-7 Calidad de Agua Influyente de la Planta de Tratamiento (Ocumare del Tuy)

Target year	2010					2003				
	Daily Mean (m ³ /day)	LOAD(kg/day)		CONC(mg/l)		Daily Mean (m ³ /day)	LOAD(kg/day)		CONC(mg/l)	
		BOD	SS	BOD	SS		BOD	SS	BOD	SS
Domestic Wastewater	51,241	8,385	8,540	164	167	32,764	6,163	6,277	188	192
Industrial Wastewater	2,352	823	941	350	400	1,583	554	633	350	400
Infiltration	10,980	-	-	-	-	7,021	-	-	-	-
Total	64,574	9,208	9,481	143	147	41,368	6,717	6,910	162	167

*Concentration of industrial wastewater; Standard value of discharging to sewer

**Standard : BOD□...350(mg/l), SS□...400(mg/l)

Table 5.2-1 Area de tierra utilizado en Las Tejerías

		Commercial District	Residential District	New Residential District	Industrial District	Forest, Aguri culture...	Others	Total
Present	Area(ha)	35	189	-	103	129	40	495
	Ratio(%)	7.1	38.1	-	20.7	26.0	8.1	100.0
Future	Area(ha)	35	189	89	103	40	40	495
	Ratio(%)	7.1	38.1	17.9	20.7	8.1	8.1	100.0

*Commercial district : including high-densly populated residential district

*Forest,Aguriculture : including protection area

Table 5.2-2 Poblacion del Area Urbana de Las Tejerías

	1990	2003	2010
Las Tejerías	20,246	26,898	30,825
Remark	OCEI	JICA(M/P)	JICA(M/P)

Table 5.2-3 Distancia de Cañerías Existentes

Diameter(mm)	Distance(m)	Remarks
200	10,980	
300	1700	

Table 5.3-1 Densidad Poblacional de acuerdo al Uso de Tierra

	Area (ha)	1990		2003		2010	
		Population	density*	Population	density*	Population	density*
Commercial District	35	5,232	148	5,745	163	6,278	178
Residential District	189	14,002	74	15,377	81	16,802	89
New Residential District	89	-	-	4,431	50	6,203	70
Industrial District	103	-	-	-	-	-	-
Forest, Agriculture...	40	-	-	-	-	-	-
Etc.	40	-	-	-	-	-	-
Total	495	19,234	39	25,553	52	29,284	59

* Unit : Persons/ha

Table S.3-2 Numero de Empleo y Descarga Industrial Proyectada en el Futuro (Las Tejerías)

CIU	Category	Discharge flowrate	Employee Numbers							Discharge(m ³ /day)							
			1995	2000	2003	2005	2010	2015	2020	2003	2005	2010	2015	2020			
31100	Nourishing product factory except soft drinks	2.01	0	0	0	0	0	0	0	0	0	0	0	0	0	0	0
31111	Slaughtering cattle, pigs, sheep, horses and rabbits	2.01	45	56	66	73	99	90	113	133	147	198					
31112	Farms of chicken and other animals except domestic animals	2.01	0	0	0	0	0	0	0	0	0	0	0	0	0	0	0
31113	Preparation and manufacture of meat	2.01	259	324	382	420	567	521	651	767	845	1,140					
31121	Milk pasteurization and bottling	2.01	0	0	0	0	0	0	0	0	0	0	0	0	0	0	0
31173	Biscuits, shortcake and noodles	2.01	0	0	0	0	0	0	0	0	0	0	0	0	0	0	0
31221	Production of animal food	2.01	39	49	57	63	85	78	98	116	127	172					
31311	Distillation, rectify and blend of alcohol	0.97	0	0	0	0	0	0	0	0	0	0	0	0	0	0	0
31341	Production of soft drinks	0.97	0	0	0	0	0	0	0	0	0	0	0	0	0	0	0
31342	Bottling and gasification of natural mineral water	0.97	0	0	0	0	0	0	0	0	0	0	0	0	0	0	0
32111	Preparation of textile	2.43	253	299	340	367	471	615	726	826	893	1,145					
32112	Spinning, weaving and finishing of wool and mixed fibers	2.43	0	0	0	0	0	0	0	0	0	0	0	0	0	0	0
32113	Spinning, weaving and finishing of cotton, artificial and mixed fibers	2.43	606	716	814	880	1,129	1,473	1,740	1,979	2,138	2,744					
32311	Tannery and repair of leather	1.43	0	0	0	0	0	0	0	0	0	0	0	0	0	0	0
32321	Industry to prepare tanning leather	1.43	0	0	0	0	0	0	0	0	0	0	0	0	0	0	0
35131	Synthetic resins, plastic materials and artificial fibers	2.50	0	0	0	0	0	0	0	0	0	0	0	0	0	0	0
35135	Synthetic resins, plastic materials and artificial fibers, except glass	2.50	146	176	204	222	291	364	440	508	554	726					
35211	Manufacturing of paint, varnishes and shellac	0.09	11	15	19	22	32	1	1	2	2	3					
35231	Manufacture of soaps and cleaning products	0.09	0	0	0	0	0	0	0	0	0	0	0	0	0	0	0
35234	Manufacture of perfumes and cosmetics	0.09	9	13	16	18	26	1	1	1	2	2					
35291	Manufacture of several chemical products	0.92	100	127	150	166	226	92	117	138	153	208					
35292	Adhesives, alus, priming for clothes	0.92	0	0	0	0	0	0	0	0	0	0	0	0	0	0	0
35295	Manufacture of adhesive materials, glues gelatin and gumes	0.92	0	0	0	0	0	0	0	0	0	0	0	0	0	0	0
36200	Mud, porcelain stuff factory	0.45	0	0	0	0	0	0	0	0	0	0	0	0	0	0	0
36201	Production of glass and glass fiber	0.67	0	0	0	0	0	0	0	0	0	0	0	0	0	0	0
3699	Manufacture of other non-metallic products	0.99	0	0	0	0	0	0	0	0	0	0	0	0	0	0	0
37102	Manufacture of iron and steel without pig metal and without rolling	0.26	0	0	0	0	0	0	0	0	0	0	0	0	0	0	0
37201	Basic industry of aluminium	1.44	0	0	0	0	0	0	0	0	0	0	0	0	0	0	0
38191	Manufacture of metallic products, not specified, except machinery and equipment	0.26	205	243	277	300	387	53	63	72	78	101					
38193	Factory of nickel plate	0.26	356	422	482	521	671	93	110	125	136	175					
38431	Car(automobiles) factory	0.24	412	541	656	733	1,025	99	130	158	176	246					
38433	Automobile spare parts factory	0.24	0	0	0	0	0	0	0	0	0	0	0	0	0	0	0
TOTAL			2,441	2,981	3,465	3,787	5,011	3,480	4,191	4,826	5,250	6,860					

Tabla 5.3-3 Tasa de Flujo por Residente en Previos Estudios y Planes

No.	Objective Year	Reference	Average Flow per Resident
A	2010	<i>Plan Rector para la Cuenca Alta y Media del Rio Tuy (1995, Michael Schlegel)</i>	250 (l/per/day)
B	2010	<i>Analisis de Sensibilidad para el Modelaje de Calidad de Agua(RIOS) del Rio Tuy</i>	272 (l/per/day)
C	1995	<i>Actualizacion de Proyectos de Inversion Ambiental en la Cuenca del Rio Tuy y su Area de Influencia(1994, Efren Guedez)</i>	By a coefficient of return of 0.8 <ul style="list-style-type: none"> • Ocumare del Tuy $298 \times 0.8 = 238.4$ (l/per/day) • Las Tejerias $258 \times 0.8 = 206.4$ (l/per/day)
D	2010	<i>Actualizacion de Proyectos de Inversion Ambiental en la Cuenca del Rio Tuy y su Area de Influencia(1994, Efren Guedez)</i>	By a coefficient of return of 0.8 <ul style="list-style-type: none"> • Ocumare del Tuy $528.9 \times 0.8 = 476.0$ (l/per/day) • Las Tejerias $461.6 \times 0.8 = 369.3$ (l/per/day)

Daily mean : Daily maximum : Hourly maximum = 0.7 : 1.0 : 1.5

Tabla 5.3-4 Tasa de Flujo de Diseño de agua residual Domestico (Las Tejerias)

	Population (person)	Daily Mean		Daily Maximum		Hourly Maximum	
		Flowrate (m ³ /person/day)	Discharge (m ³ /day)	Flowrate (m ³ /person/day)	Discharge (m ³ /day)	Flowrate (m ³ /person/day)	Discharge (m ³ /day)
1990	19,234	0.175	3,370	0.250	4,814	0.375	7,221
2000	23,977	0.238	5,697	0.339	8,138	0.509	12,208
2003	25,553	0.256	6,550	0.366	9,357	0.549	14,035
2005	26,604	0.269	7,151	0.384	10,216	0.576	15,324
2010	29,284	0.300	8,785	0.429	12,550	0.643	18,825

Note : Daily Average : Daily Maximum : Hour Maximum = 0.7 : 1.0 : 1.5

Tabla 5.3-5 Tasa de Flujo de Diseño de agua residual Industrial (Las Tejerias)

Year	Daily Mean (m ³ /day)	Daily Maximum (m ³ /day)	Hourly Maximum (m ³ /day)
1995	3,480	3,480	6,960
2000	4,191	4,191	8,381
2003	4,826	4,826	9,653
2005	5,250	5,250	10,501
2010	6,860	6,860	13,719

Remark ; DailyMean : Daily Maximum : Hourly Maximum = 1 : 1 : 2

Tabla 5.3-6 Tasa de Flujo de Diseño en el Alcantarillado de Las Tejerias

Target year	2010 (m ³ /day)			2003 (m ³ /day)		
	Daily Mean	Daily Max	Hourly Max	Daily Mean	Daily Max	Hourly Max
Domestic Wastewater	8,785	12,550	18,825	6,550	9,357	14,035
Industrial Wastewater	6,860	6,860	13,719	4,826	4,826	9,653
Infiltration	1,883	1,883	1,883	1,404	1,404	1,404
Total	17,527	21,292	34,427	12,780	15,587	25,092

Note: Infiltration=15% of Daily Maximum of Domestic WasteWater

Table 5.3-7 Calidad de Agua Influyente de la Planta de Tratamiento (Las Tejerías)

Target year	2010					2003				
	Daily Mean (m ³ /day)	LOAD(kg/day)		CONC(mg/l)		Daily Mean (m ³ /day)	LOAD(kg/day)		CONC(mg/l)	
		BOD	SS	BOD	SS		BOD	SS	BOD	SS
Domestic Wastewater	8,785	1,581	1,611	180	183	6,550	1,380	1,405	211	215
Industrial Wastewater	6,860	2,401	2,744	350	400	4,826	1,689	1,931	350	400
Infiltration	1,883	-	-	-	-	1,404	-	-	-	-
Total	17,527	3,982	4,354	227	248	12,780	3,069	3,336	240	261

*Concentration of industrial wastewater; Standard value of discharging to sewer

*Standard ; BOD□...350(mg/l), SS□...400(mg/l)

Table 6.2-1 Compartibilizacion del Area de Reforestacion

	Block Name	Co. No.	Area (ha)	Reforestation Area (ha)	Belts of Fire Resistant Trees (ha)	Distance of New Forest road (km)	Total of Existing Road (km)	Mixed Planting	Fire Resistant Trees	Cutting	Seedling
6	Qda. Santa Maria	1	59.1	57.9	1.2		0.3	77218	1333	38609	39942
7		2	1129.2	1077.2	52.0		13.0	1436318	57778	718159	775937
8		3	361.0	355.0	6.0	0.8	0.7	473394	6667	236697	243364
9		4	182.9	156.9	26.0		6.5	209141	28889	104571	133460
10		5	189.5	175.1	14.4		3.6	233470	16000	116735	132735
11		6	362.6	349.4	13.2		3.3	465868	14667	232934	247601
12		7	244.7	224.7	20.0		5.0	299542	22222	149771	171993
13		8	146.2	139.0	7.2		1.8	185371	8000	92686	100686
	Sub-total		2675.2	2535.2	140.0	0.8	34.2	3380323	155556	1690161	1845717
14	Palo Negro	1	177.9	173.9	4.0	0.4	0.6	231875	4444	115938	120382
15		2	349.9	333.5	16.4	1.4	2.7	444631	18222	222315	240538
16		3	139.2	130.0	9.2	1.2	1.1	173276	10222	86638	96860
	Sub-total		666.9	637.3	29.6	3	4.4	849782	32889	424891	457780
	total		3342.2	3172.6	169.6	3.8	38.6	4230105	188444	2115053	2303497
	Quantity for 1 year		668.4					846021	37689	423011	460699

Table 6.2-2 Proprietarios en el Area de Reforestacion

No.	Area Name	No.	Owner	Observation	ha (aprox.)	Address
1	Qda. Santa Maria	1	No data available	No data available		Unknown
2		2	Succion Hermanos Bravos		920	Moscatel Piso 4, Apto. 4 - 2, Los Teques
3		3	No data available	No data available		Unknown
4		4	Succion Hermanos Bravos		920	Moscatel Piso 4, Apto. 4 - 2, Los Teques
5		5	Ditto		920	Ditto
6		6	Ditto		920	Ditto
7		7	Ditto		920	Ditto
8		8	No data available	No data available		
9	Palo Negro	1	Instituto Agrario Nacional	Estates belong to Agriculture National	450	Unknown
10		2	Instituto Agrario Nacional & Abraham Malave	Ditto	450	Ditto
				Ocampo Farm (Finca Ocampo)	290	Ditto
11		3	Abraham Malave	Ditto	290	Ditto

Table 6.3-3 Tres Especies Elegidas para la Reforestacion

Types (Local Name)	Sowing & Distance (m x m)	Resistance to Fire	Maintenance Required	Annual Growth, Diameter & Height	Cost (Bs)	Selection
Fire Resistant Tree Belt	Alnus Jorulensis (Ajiso) Seed 4x4~4x5	Weak Evergreen.	Laborious	0.5 m/year $\phi = 20$ cm. Height = 15-20 m	86.14	
	Cuji (Prosopis Julifora) Seed 3x3 ~ 3x4	Medium Evergreen	Only a little	1 m/year $\phi = 8 \sim 15$ cm Height = $\pm 3 \sim 5$ m	86.14	•
Mixed Planting Area	Bauhinia (Pata c'Vaca) Seed 3x3 ~ 3x4	Weak Deciduous tree in dry season	Only a little Resist to dry season.	0.5 - 1 m/year. $\phi = 8 \sim 15$ cm. Height = 4 ~ 7 m	86.14	•
	Cassia Moschata (Caña Fistolo) Seed 2x2	Weak Deciduous tree in dry season	Only a little.	0.5 mt/year $\phi = 30$ cm Height = ± 4 m	86.14	
	Gliriscidia sp (Mataraton) Cutting or Seed 2x2	Weak Deciduous tree in dry season	Only a little	1 m/year or more. $\phi = 8 \sim 15$ cm Height = $\pm 3 \sim 4$ m	20.54	•

Table 6.5-1 Vivero & Programa de Plantacion para la Reforestacion

No.	Activity	Month												
		11	12	1	2	3	4	5	6	7	8	9	10	11
1	Preparation of Nursery - Land cleaning - Building of facilities - Preparation of soil for pots - Procurement of seed	—	—	—	—	—	—	—	—	—	—	—	—	—
2	Procurement of cutting						—							
3	Seeding			—	—	—	—							
4	Planting						—	—	—	—	—	—	—	
5	Weeding									—	—	—	—	—
6	Replanting										—	—	—	—

Planting Activity Schedule of Blocks

	Block Name	Year				
		1999	2000	'01	'02	'03
1	Qda. Santa Maria No.1,2-4,4,5 (620ha)	—				
2	Qda. Santa Maria No.2-1,2-2 (658ha)		—			
2	Qda. Santa Maria No.2-3,6,8 (733ha)			—		
4	Qda. Santa Maria No.3,7 (605ha)				—	
5	Palo Negro (667ha)					—

Tabla 7.1-1 Revisión Historica en Relación a Incentivos Fiscales

Law or Regulation	Date Published	Objective	Standing
Decree No. 1.846	26/10/1976	Exoneration of income tax in a period of 3 years of up to 10% to those investments assigned to avoid environment pollution	No (Derogated by Dec. 2.001)
Decree No. 2.995	12/12/1978	Regarding Valencia Lake Basin: - Exoneration of importation tax for equipment, materials and raw material for installation/operation of water treatment systems. - Exoneration of income tax in a period of 5 years for the equivalent amount of the operation costs. - Soft conditions of credit by the government financing institutions for acquisition and installation of equipment for water treatment. To be regulated by the Ministry of Development and the MARNR.	No (Derogated by Dec. 2.001)
Decree No. 2.001	13/5/1983	- Exoneration of importation tax for equipment, materials and raw material for installation/operation of water treatment systems. - Exoneration of income tax in the first year of operation of the decontaminating equipment. - Soft conditions of credit by the government financing institutions for acquisition and installation of equipment for environmental decontamination.	No (Derogated by Dec. 1.302)
Income Tax Law Art. 14, item 3	3/10/1986	Exoneration of tax to those industries which apply methods to avoid the pollution of environment	No
Decree No. 1,302 Art. 3	10/10/1986	Reduction of 10% income tax for investments in equipment, civil works or facilities for the conservation, safeguard and improvement of environment. For local equipment 15%.	No
Income Tax Law Art.62, 63	13/8/1991	Deduction of 10% tax to those industries which make investments to eliminate or avoid the pollution of environment.	No
Decree No. 1,793	7/10/1991	States the applicability of incentives of Decree 1,302.	No
Income Tax Law - Art. 27:	25/5/1994	- Tax deduction for the constructions to comply with sanitary regulations.	Yes
- Art. 118:		- Applicability of tax deductions stated in Income Tax Law of 1991.	No

Sources: a) Collection of laws, b) Consultation to Legal Bureau of Tvy Agency and c) Consultation to Legal Bureau of Finance Ministry (SENIAT)

Table 9.5-1 Impactos Adversos Predecibles y Medidas de Mitigacion.

Predictable Impact	Impact Stage	Assessment of Impact Significance	Mitigation Measure
Illegal land use	Pre-construction Post-construction	High	Proposed land should be under strict surveillance of Tuy Agency or local Government to protect against illegal land use or invasion of third persons. Fencing and employment of security guard are advisable in this regard.
Noise	Construction	Low	Work schedule should be informed in public through local Government, and care needs to be taken to the heavy equipment, of which operation should be limited to only daytime.
Dust	Construction	Low	Watering is desirable for earth moving work or access road. Soil materials should be covered with sheet.
Traffic congestion	Construction	Moderate	Number of mobilized equipment and vehicles should be controlled taking account of present traffic conditions and proposed work schedule.
Water quality of the river	Construction	Moderate	Protective net or fence should be placed on the river edge to keep the stream from entering spilt soil and construction of scrap or waste.
Sediment	Construction	Moderate	Sediment accumulated in the Tuy River channel should not be used for construction materials. It is required to be disposed at designated site.
Aquatic biology	Construction	Low	Same measure as mentioned in the item "water quality" is required not to worsen present stream-ecosystem in the course of construction.
Generation of stench and insects	Post-construction	High	Competent personel should be placed to deal with proper operation and maintenance of sewerage treatment plant
Sludge	Post-construction	High	Sludge produced in treatment plant should be disposed in landfill site at Bonanza on condition that its composition is not detrimental to the environment.

Table 9.6-1 Plan de Gerenciamiento Ambiental para la Instalacion de la
Planta de Tratamiento Cloacal en Ocumare del Tuy y Las Tejerias

Managing Item	Source of Impact	Measuring Standard of Impact	Managing Approach	Management Location	Managing Agency Concerned
(Pre-Construction Stage)					
-Social unrest	-Project location -Land acquisition	-Compensation -Public protest/ demonstration & project disturb	-Negotiation -Public hearing -Presidential decree No.184 (Expropriation Law)	-Project site -All project-affected communities	-MARNR -Tuy Agency -Local Government -Regional Government
(Construction Stage)					
-Noise	Operation of heavy equipment	Noise level : 65 dB (Leq) (Decree No.2217)	-Control of number or speed of vehicles/ equipment -Working hour -Equipment operators	-Residential area -School, clinic	-Tuy Agency -Local Government
-Air pollution and traffic congestion	-Mobilization of equipment -Civil works	-Quality standard (Decree No.618) -Traffic congestion frequency/duration	-Covering materials with sheet -Watering road -Selection of spoil site	-Construction site -Public road & access road	-Tuy Agency -Local Government
-Water quality of the river	All civil works relating to the project	Water quality standard according to Decree No.883	-Effort to minimize spilt soil into the river -Protective net at downstream direction	-Construction site -Sewage pipe setting location	-Tuy Agency
-Sediment	Earth works (embankment / filling)	Contents of Cr, Ni, Pb Cu and Zn in sediment	-No use of such materials for embankment -Proper method of disposal in dumping site	Construction site	-Tuy Agency
-Aquatic biology	Embankment / filling for flood protection	Presence and density of benthos, plankton and netoon	-Effort to minimize degradation of water quality -Preservation of natural ecology	Tuy river at Project site (sampling point as determined in EIA)	-Tuy Agency
-Employment and economic growth	Project implementation	-Willingness to participate in project -Increase in family income	Recruitment of local manpower	Municipalities of Santos Michelena and Tomas Lander	-Tuy Agency -Local Government
(Post-Construction Stage)					
-Illegal land use of project site	-Project location -Land acquisition	-No. of squatters -Illegal land use	-Effort to gain public comprehension -Control of illegal land use	Proposed site for sewage treatment plant	-MARNR -Tuy Agency -Local Government -Regional Government
-Generation of stench and insects	Sewerage treatment plant	Public complaint, protest and reaction	-Treatment method and system -Proper operation and maintenance	Sewerage treatment plant	-Tuy Agency
-Disposal of sludge	Sewerage treatment plant	Sludge composition (contents of toxic substances)	-Sludge disposal system -Proper operation and maintenance	-Final disposal site -Sewerage treatment system	-Tuy Agency -Mancoset -Local Government
-Sewage canals/pipes	Domestic/industrial wastewater	Function of sewerage system	-Proper maintenance of sewerage network -Educating people	Each community concerned	-Tuy Agency -Local Government

Table 9.6-2 Plan de Gerenciamiento Ambiental para la Construcción del Tanque de sedimentación de arena en la Captación del Agua .

Managing Item	Source of Impact	Measuring Standard of Impact	Managing Approach	Management Location	Managing Agency Concerned
(Pre-Construction Stage)					
-Social unrest	-Project location	-Compensation -Public protest/ -demonstration & -project disturb	-Negotiation -Public hearing	-Construction site -All project-affected -land	-Hidrocapital -MARNR -Tuy Agency -Local Government
(Construction Stage)					
-Noise	Operation of heavy equipment	Noise level : 65 dB (Leq) (Decree No 2217)	-Control of number or -speed of vehicles/ -equipment -Working hour -Equipment operators	Village(s) close to project site	-Hidrocapital -Tuy Agency -Local Government
-Air pollution and traffic congestion	-Mobilization of equipment -Civil works	-Quality standard (Decree No 638) -Traffic congestion -frequency/duration	-Covering materials with sheet -Watering road -Selection of spoil site	-Construction site -Public road & access road	-Hidrocapital -Tuy Agency -Local Government
-Water quality of the river	All civil works relating to the project	Water quality standard according to Decree No. 883	-Effort to minimize -spilt soil into the river -Protective net at -downstream direction	-Construction site -Water intake -facility	-Hidrocapital -Tuy Agency
-Sediment	Earth works (embankment / filling)	Contents of Cr, Ni, Pb Cu and Zn in sediment	-No use of such materials for embankment -Proper method of disposal in dumping site	Construction site	-Hidrocapital -Tuy Agency
-Aquatic biology	All civil works relating to the project	Presence and density of benthos, plankton and necton	-Effort to minimize -degradation of water -quality -Preservation of natural ecology	Tuy river at Project site (sampling point as determined in EIA)	-Tuy Agency
-Employment and economic growth	Project implementation	-Willingness to participate in project -Increase in family income	Employment of local manpower	San Francisco de Yare and other nearby villages	-Hidrocapital -Local Government
(Post-Construction Stage)					
-Illegal land use of project site	-Project location	-No. of squatters -Illegal land use	-Effort to gain -public comprehension -Control of illegal land use	Proposed site for sand settling pond and its surrounding area	-Hidrocapital -MARNR -Tuy Agency -Local Government
-Water intake and pre-treatment facility	Sand settling pond	-Turbidity -Pumping operation	-Introduction of mechanical sand settling system -Proper operation and maintenance	-Sand settling pond -Intake facility	-Hidrocapital -Tuy Agency
-Flushed sediment	Sand settling pond	Volume of flushed sediment	-Flushing operation -Proper maintenance of facility	-Flushing gate -Downstream of intake weir	-Hidrocapital -Tuy Agency
-Sewage canals/pipes	Domestic/industrial wastewater	Function of sewerage system	-Proper maintenance of sewerage network -Educating people	Each community concerned	-Tuy Agency -Local Government

Table 9.7-1 Plan de Monitoreo Ambiental para la Instalacion de planta de Tratamiento Cloacal en Ocumare del Tuy y Las Tejerias

Monitoring Item	Monitoring Method	Location	Monitoring Frequency	Duration	Monitoring Agency
Illegal land use of project site	Field visit and confirmation	Proposed site for sewerage treatment plant	Every 6 months	No limit defined	-MARNR -Tuy Agency -Local Government
Noise	Measured by noise level meter	Residential area close to project site	Once a month	Construction period	Tuy Agency
Dust and traffic congestion	Field inspection and measurement	-Construction site -Urban area	Once a month	Construction period	Tuy Agency
Sediment	Field inspection and measurement	Sampling points as selected in EIA	Every 6 months	Till year 2010	Tuy Agency
Aquatic biology	-Field inspection -Sample analysis	Sampling points as selected in EIA	Every 6 months	Till year 2010	Tuy Agency
Water quality of the Tuy River	Test and analysis of sample waters in laboratory	Sampling points as selected in EIA	Every 6 months	Till year 2010	Tuy Agency
Groundwater quality	Test and analysis of sample waters in laboratory	Sampling points (deep well) as selected in EIA	Every 6 months	Till year 2010	Tuy Agency
Inflow of wastewater	Sample analysis in laboratory	Inlet of sewerage treatment plant	Once a week	No limit defined	Tuy Agency
Outflow of wastewater	Sample analysis in laboratory	Outlet of sewerage treatment plant	Once a week	No limit defined	Tuy Agency
Disposal of sludge	-Field inspection -Sample analysis	-Sewerage treatment plant -Disposal site	Once a month	No limit defined	-Tuy Agency -MARNR
Water supply operation	-Pump operation hours -Volume of pre-treated water	Pre-treatment plant	Every 3 months	Till year 2010	Hidrocapital
Public health	Collection of inform on waterborn diseases	Distrito Sanitario No 2	Every 3 months	Till year 2010	Tuy Agency
Generation of stench and insects	Public opinion and field inspection	-Sewerage treatment plant -Residential area	Every 3 months	Till year 2010	Tuy Agency
Operation and maintenance of facility	Field inspection	-Sewerage treatment plant -Project-related communities	Every 6 months	No limit defined	Tuy Agency

**Table 9.7-2 Plan de Monitoreo Ambiental para la Construcción del
Tanque de Sedimentación de Arena en la Captación del Agua**

Monitoring Item	Monitoring Method	Location	Monitoring Frequency	Duration	Monitoring Agency
Illegal land use of project site	Field visit and inspection	Construction site and its surrounding areas	Every 6 months	No limit defined	-MARNR -Hidrocapital -Local Government
Noise	Measured by noise level meter	Communities close to project site	Once a month	Construction period	Tuy Agency
Dust and traffic congestion	Field inspection and measurement	-Construction site -Artery road to urban center	Once a month	Construction period	Tuy Agency
Sediment	Field inspection and measurement	Sampling points as selected in EIA	Every 6 months	Till year 2010	Tuy Agency
Aquatic biology	-Field inspection -Sample analysis	Sampling points as selected in EIA	Every 6 months	Till year 2010	Tuy Agency
Water quality of the Tuy River	Test and analysis of sample waters in laboratory	Sampling points as selected in EIA	Every 6 months	Till year 2010	Tuy Agency
Flushed sediment	-Field inspection -Volume of flushed sediment	-Sand settling pond -Downstream of intake weir	Once a month	Till year 2010	-Hidrocapital -Tuy Agency
Turbidity	Sample analysis in laboratory	Pre-treatment plant	Once a week	No limit defined	Hidrocapital
Water supply operation	-Pump operation hours -Volume of flushed sediment	Pre-treatment plant	Every 3 months	Till year 2010	Hidrocapital
Operation and maintenance of facility	Field inspection	Sand settling pond	Every 3 months	No limit defined	Hidrocapital
	-Volume of pre-treated water				
Public health	Collection of inform. on waterborne diseases	Districto Sanitario No.2	Every 3 months	Till year 2010	Tuy Agency
Generation of stench and insects	Public opinion and field inspection	-Sewerage treatment plant -Residential area	Every 3 months	Till year 2010	Tuy Agency
Operation and maintenance of facility	Field inspection	-Sewerage treatment plant -Project-related communities	Every 6 months	No limit defined	Tuy Agency

FIGURAS

2
E. K.
/r



Item	Year												
	1998	1999	2000	2001	2002	2003	2004	2005	2006	2007	2008	2009	2010
Short Term Program													
<i>Structure Measure</i>													
Water quality													
Factory (Food/non-food)													
Existing													
Newly developed													
Domestic wastewater													
Ocumare del Tuy													
Las Tejerias													
Turbidity													
Reforestation													
Water quantity													
Securement of water													
Ocumarito-Tuy III Pumping													
Guare Dam													
Factory													
For color/odor													
Turbidity													
Sand settling pond for intake													
<i>Institutional Measure</i>													
Laws and Regulations		Improvement											
Organization		Strengthening											
Monitoring		Establishment of system					Application						
Public education		Establishment of program					Application						
Environmental Fund		Establishment of system					Application						
Pollution Charge		Establishment of system					Application						
Mid Term Program													
<i>Structure Measure</i>													
Water quality													
Factory (Food/non-food)													
Newly developed													
Domestic wastewater													
Ocumare del Tuy													
San Francisco de Yare													
El Consejo													
Turbidity													
Reforestation													
Sand settling pond for tributary													
<i>Institutional Measure</i>													
Sustainable enforcement													
Monitoring													
Strengthening of Control													
Public education													
Environmental Fund													
Pollution Charge													

THE STUDY ON
THE ENVIRONMENTAL IMPROVEMENT PROGRAM OF THE UPPER AND MIDDLE
STREAM OF THE TUY RIVER BASIN
IN THE REPUBLIC OF VENEZUELA

JAPAN INTERNATIONAL COOPERATION AGENCY

Fig. 1.1-1 Programa de Implementacion

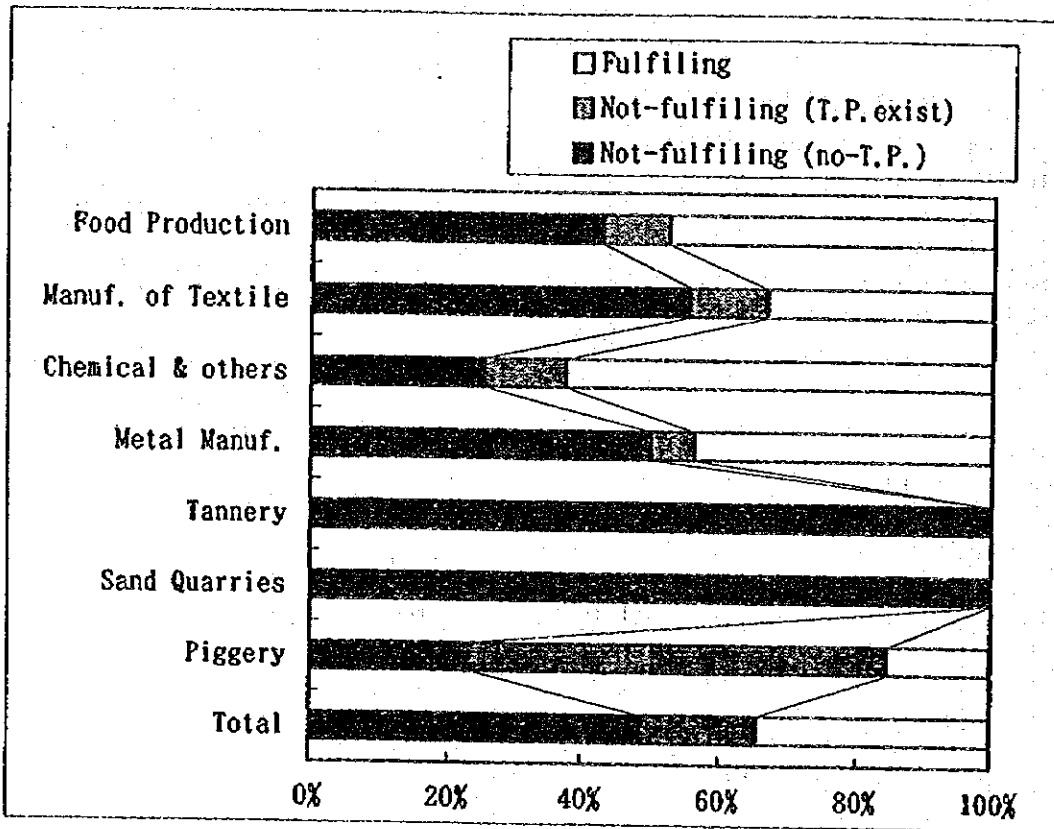

THE STUDY ON
 THE ENVIRONMENTAL IMPROVEMENT PROGRAM OF THE UPPER AND MIDDLE
 STREAM OF THE TUY RIVER BASIN
 IN THE REPUBLIC OF VENEZUELA

JAPAN INTERNATIONAL COOPERATION AGENCY

Fig. 2.2-1 Condicion de Tratamiento en:
 Fabricas y Cochineras Existentes

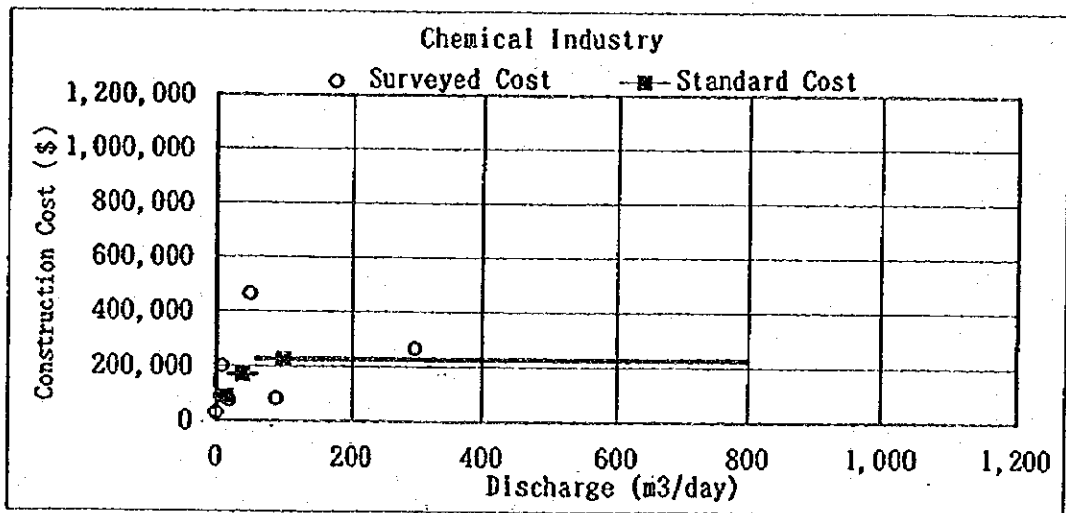
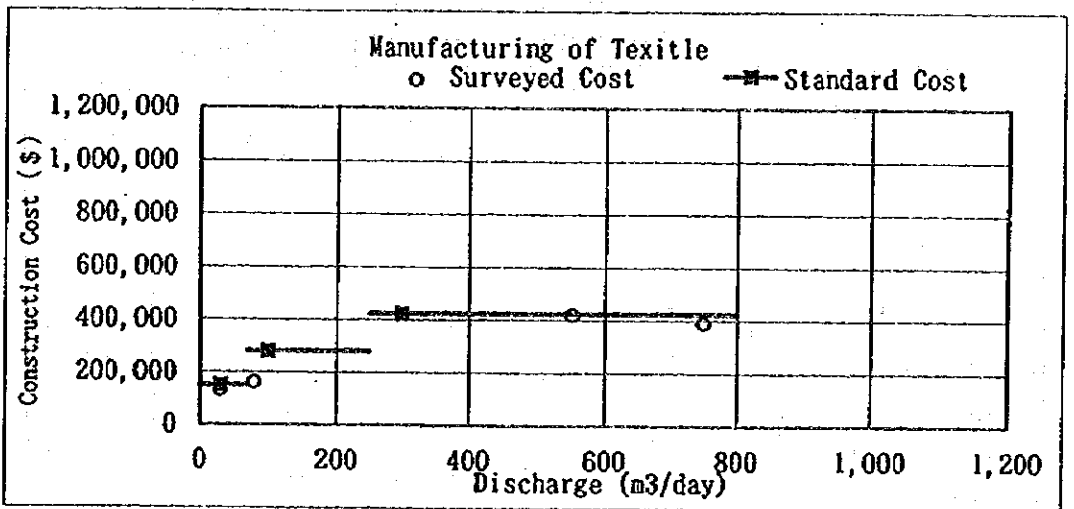
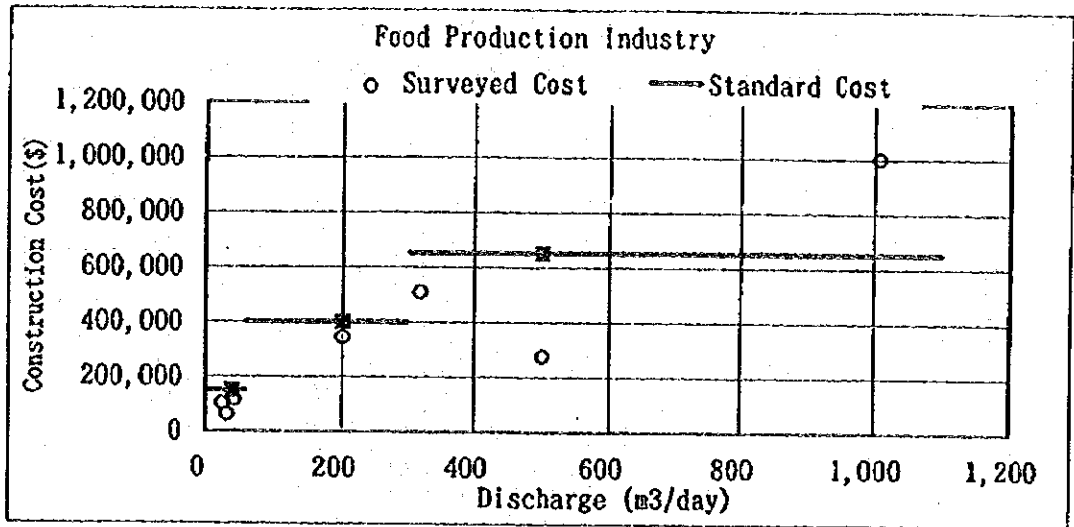

THE STUDY ON
THE ENVIRONMENTAL IMPROVEMENT PROGRAM OF THE UPPER AND MIDDLE
STREAM OF THE TUY RIVER BASIN
IN THE REPUBLIC OF VENEZUELA

JAPAN INTERNATIONAL COOPERATION AGENCY

Fig. 2.3-1 Relacion entre la Descarga de Agua Residual y el Costo de Instalacion de la Planta de Tratamiento (1/3)

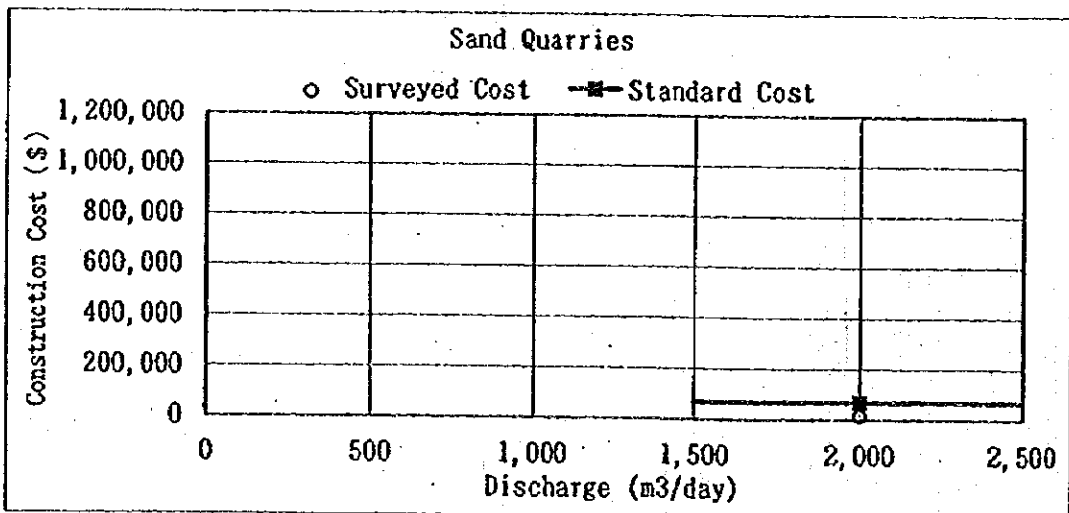
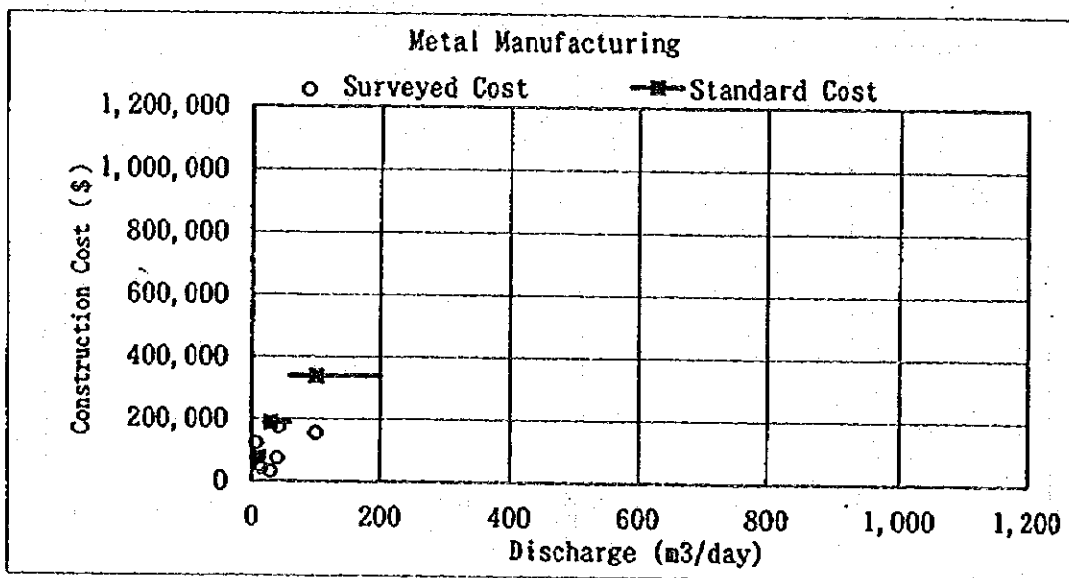
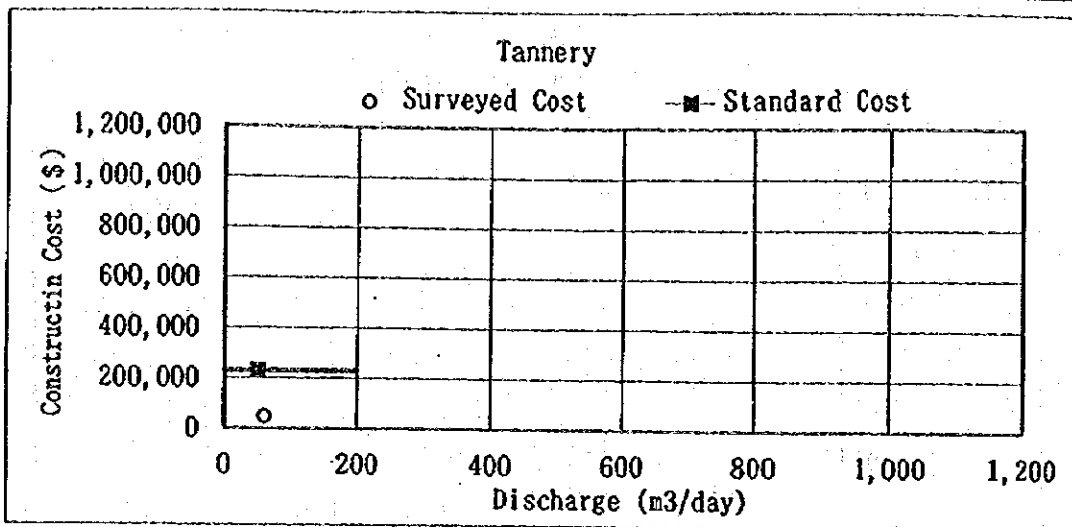

THE STUDY ON
THE ENVIRONMENTAL IMPROVEMENT PROGRAM OF THE UPPER AND MIDDLE
STREAM OF THE TUY RIVER BASIN
IN THE REPUBLIC OF VENEZUELA

JAPAN INTERNATIONAL COOPERATION AGENCY

Fig. 2.3-1 Relacion entre la Descarga de Agua Residual y el Costo de Instalacion de la Planta de Tratamiento (2/3)

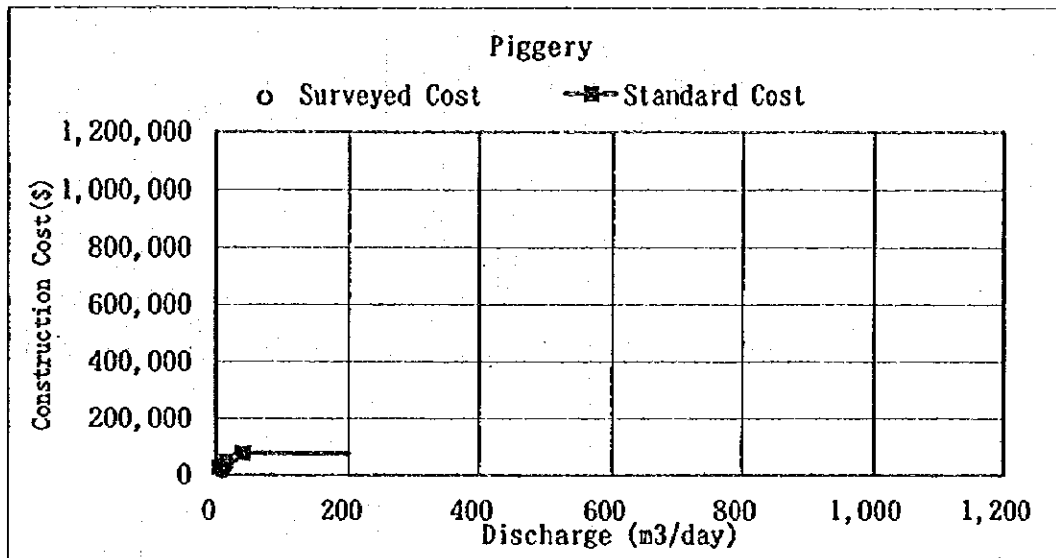

THE STUDY ON
THE ENVIRONMENTAL IMPROVEMENT PROGRAM OF THE UPPER AND MIDDLE
STREAM OF THE TUY RIVER BASIN
IN THE REPUBLIC OF VENEZUELA

JAPAN INTERNATIONAL COOPERATION AGENCY

Fig. 2.3-1 Relacion entre la Descarga de Agua Residual y el Costo de Instalacion de la Planta de Tratamiento (3/3)

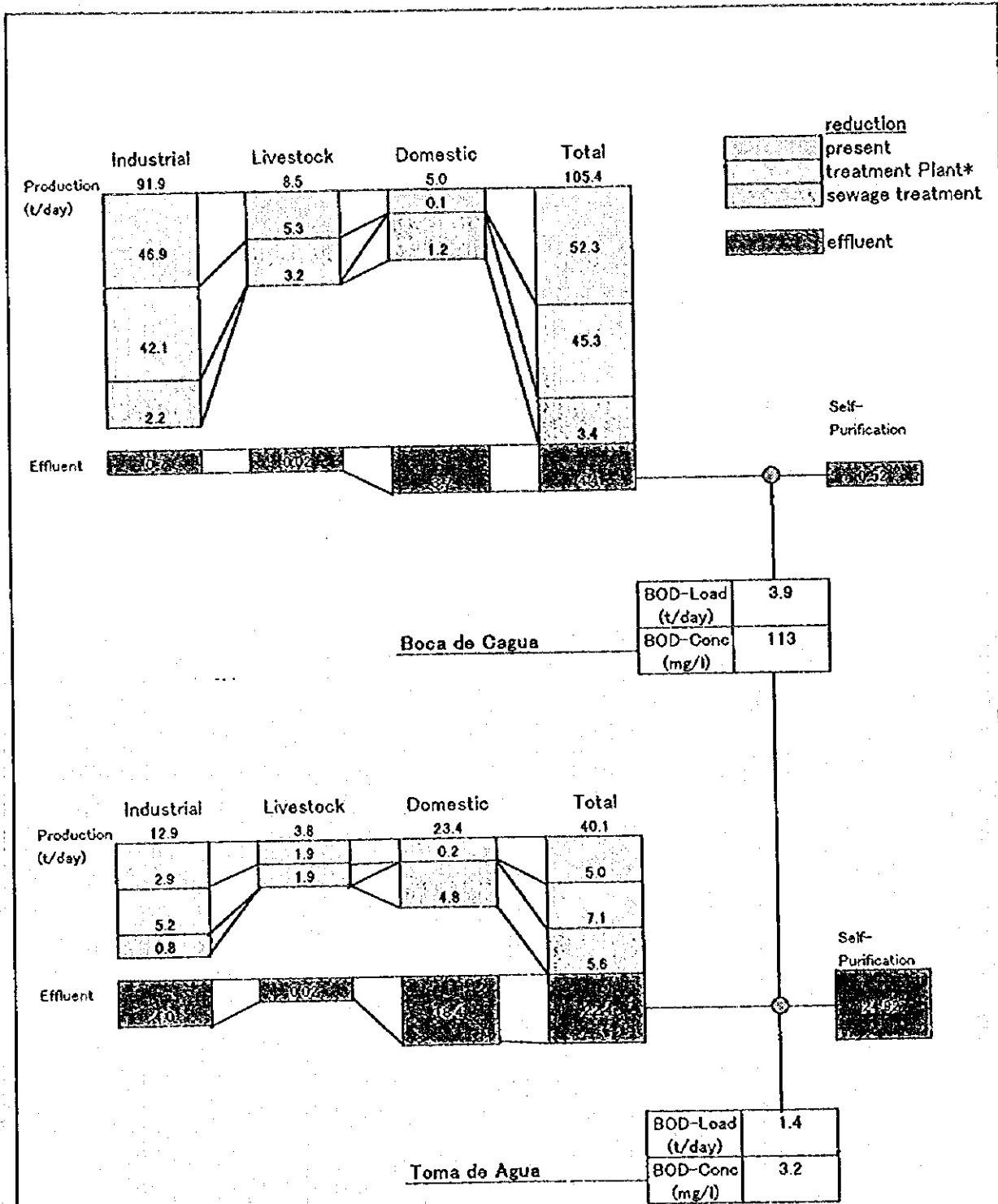

* Note : Treatment Plant by Factories and Piggeries

Fig.2.6-1 Balance de la Carga de Polución (2010)

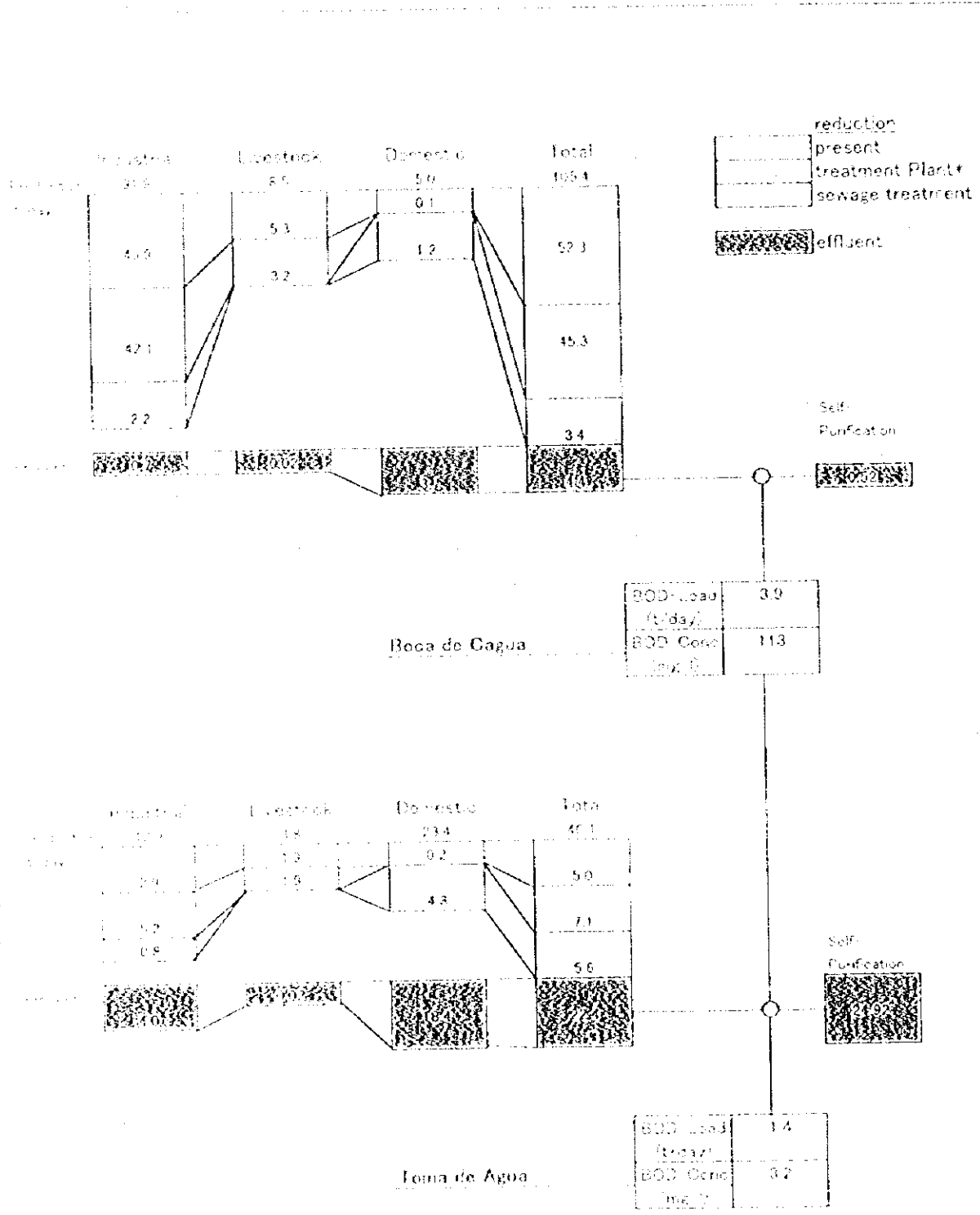

• Note: Treatment Plant by Factories and Piggeries

Fig.2.6-1 Balance de la Carga de Polución (2010)

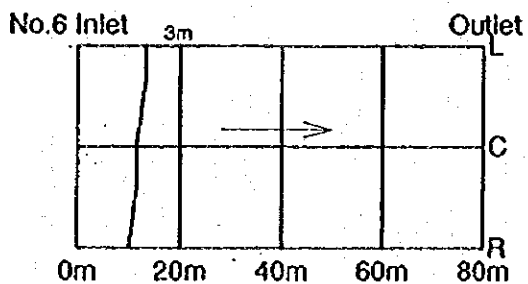
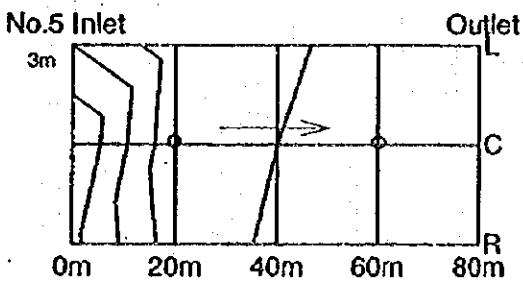
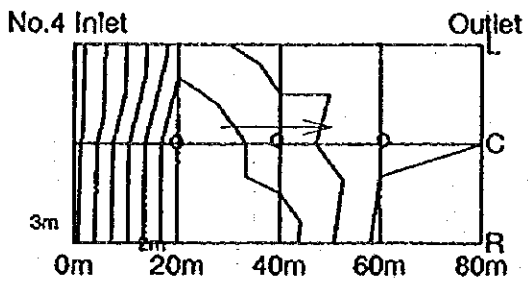
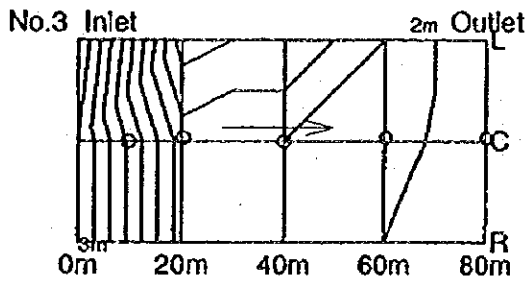
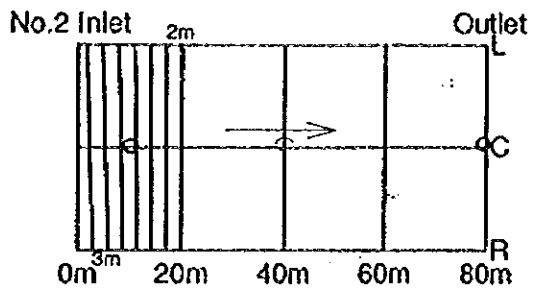

Notes : Pond No.1 was being cleaning.
:o is Sampling Point.

THE STUDY ON
THE ENVIRONMENTAL IMPROVEMENT PROGRAM OF THE UPPER AND MIDDLE
STREAM OF THE TUY RIVER BASIN
IN THE REPUBLIC OF VENEZUELA

JAPAN INTERNATIONAL COOPERATION AGENCY

Fig. 3.2-1 Profundidad el Sedimento en la Planta de Pre-Tratamiento

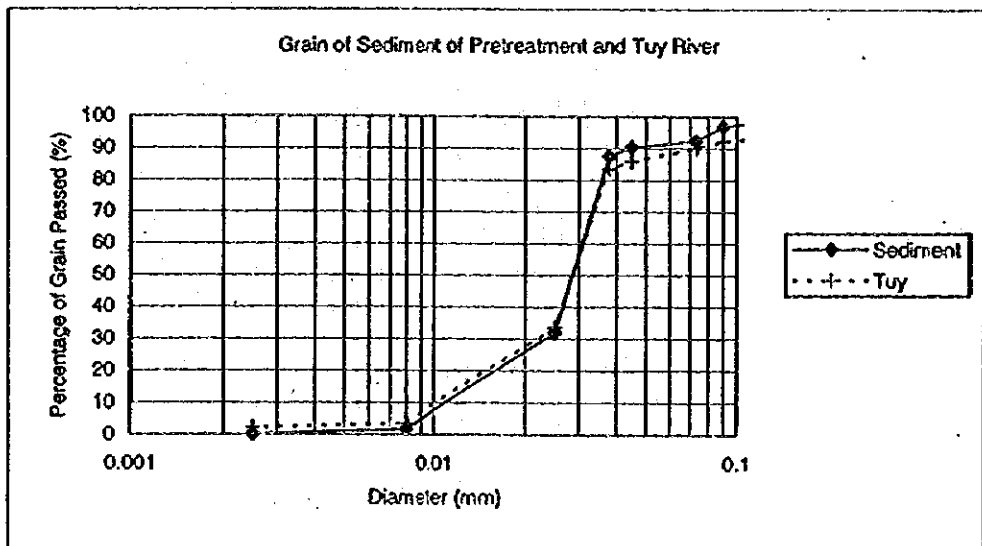
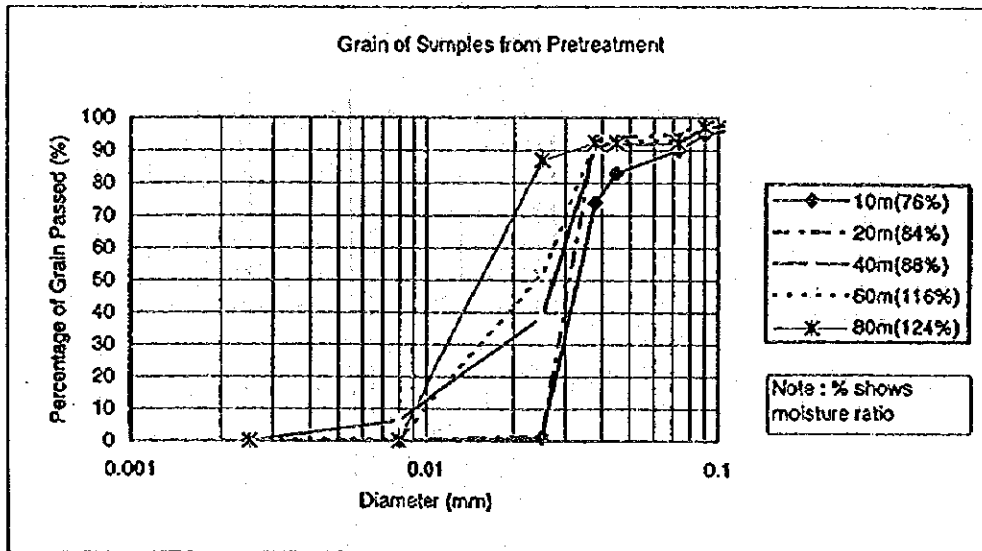

THE STUDY ON
THE ENVIRONMENTAL IMPROVEMENT PROGRAM OF THE UPPER AND MIDDLE
STREAM OF THE TUY RIVER BASIN
IN THE REPUBLIC OF VENEZUELA

JAPAN INTERNATIONAL COOPERATION AGENCY

Fig. 3.2-2 Distribucion del Tamano de Grano del Sedimento

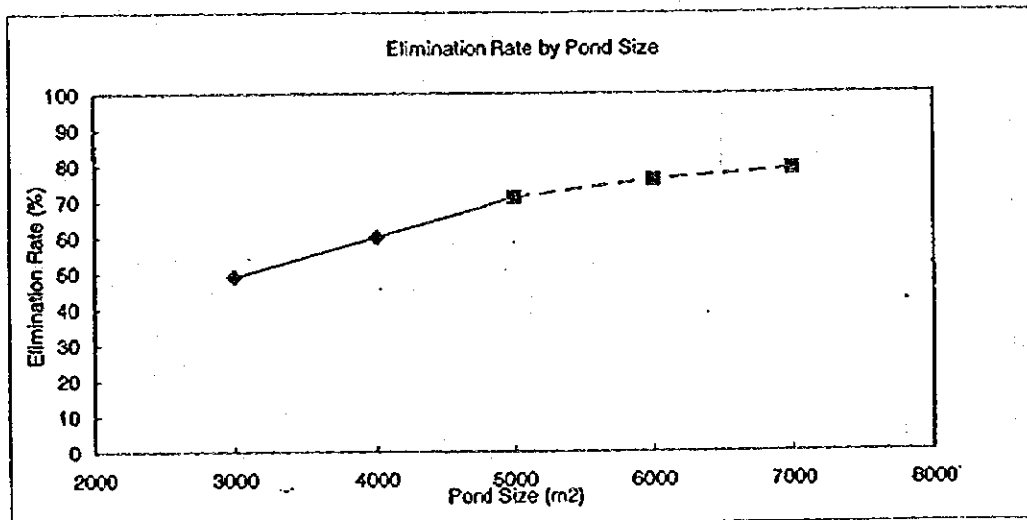
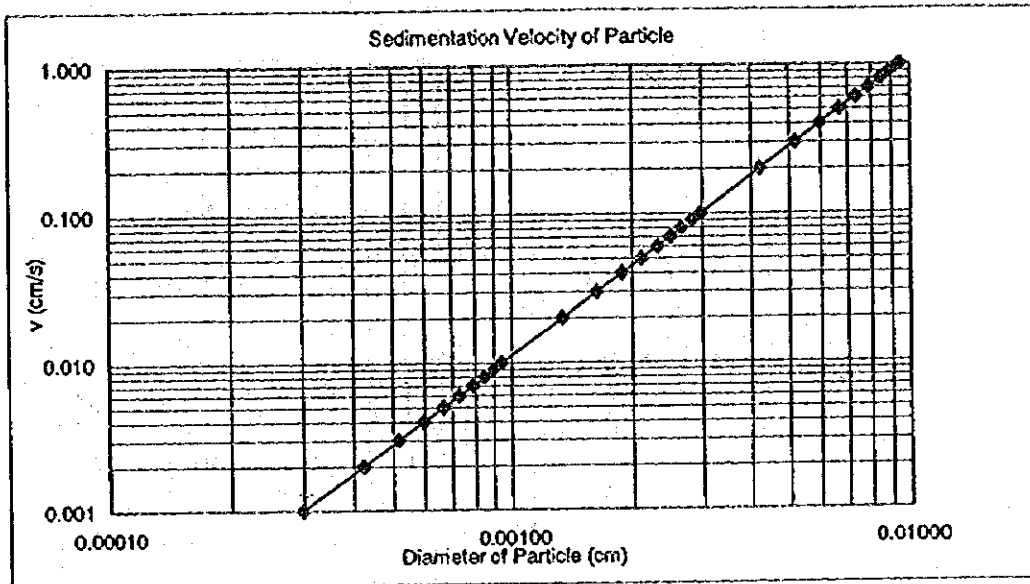

THE STUDY ON
 THE ENVIRONMENTAL IMPROVEMENT PROGRAM OF THE UPPER AND MIDDLE
 STREAM OF THE TUY RIVER BASIN
 IN THE REPUBLIC OF VENEZUELA

JAPAN INTERNATIONAL COOPERATION AGENCY

Fig. 3.3-1 Curva de Eliminacion del Tanque sedimentador de arena

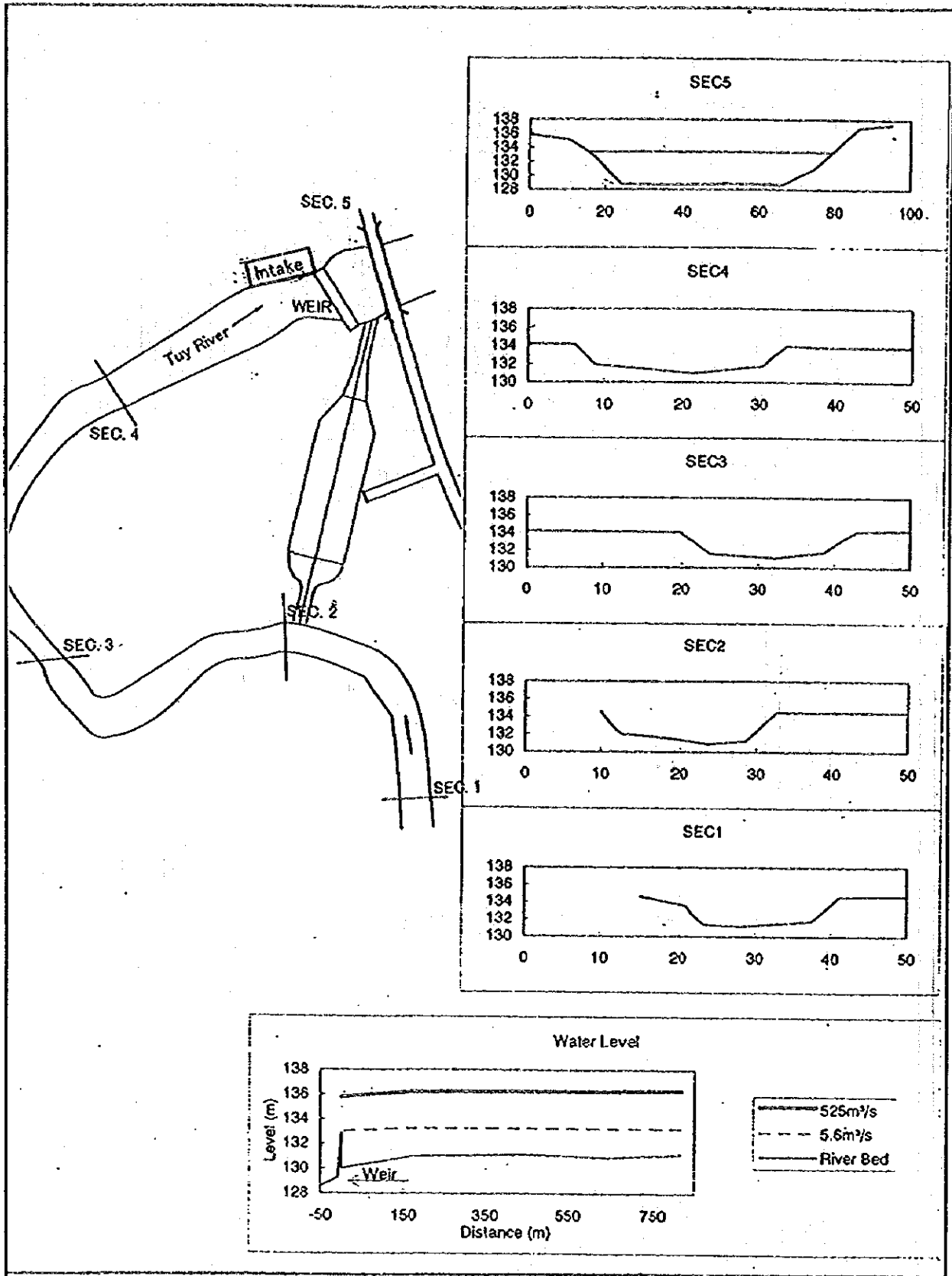

THE STUDY ON
 THE ENVIRONMENTAL IMPROVEMENT PROGRAM OF THE UPPER AND MIDDLE
 STREAM OF THE TUY RIVER BASIN
 IN THE REPUBLIC OF VENEZUELA

JAPAN INTERNATIONAL COOPERATION AGENCY

Fig. 3.5-1 Nivel de agua del Rio Tuy

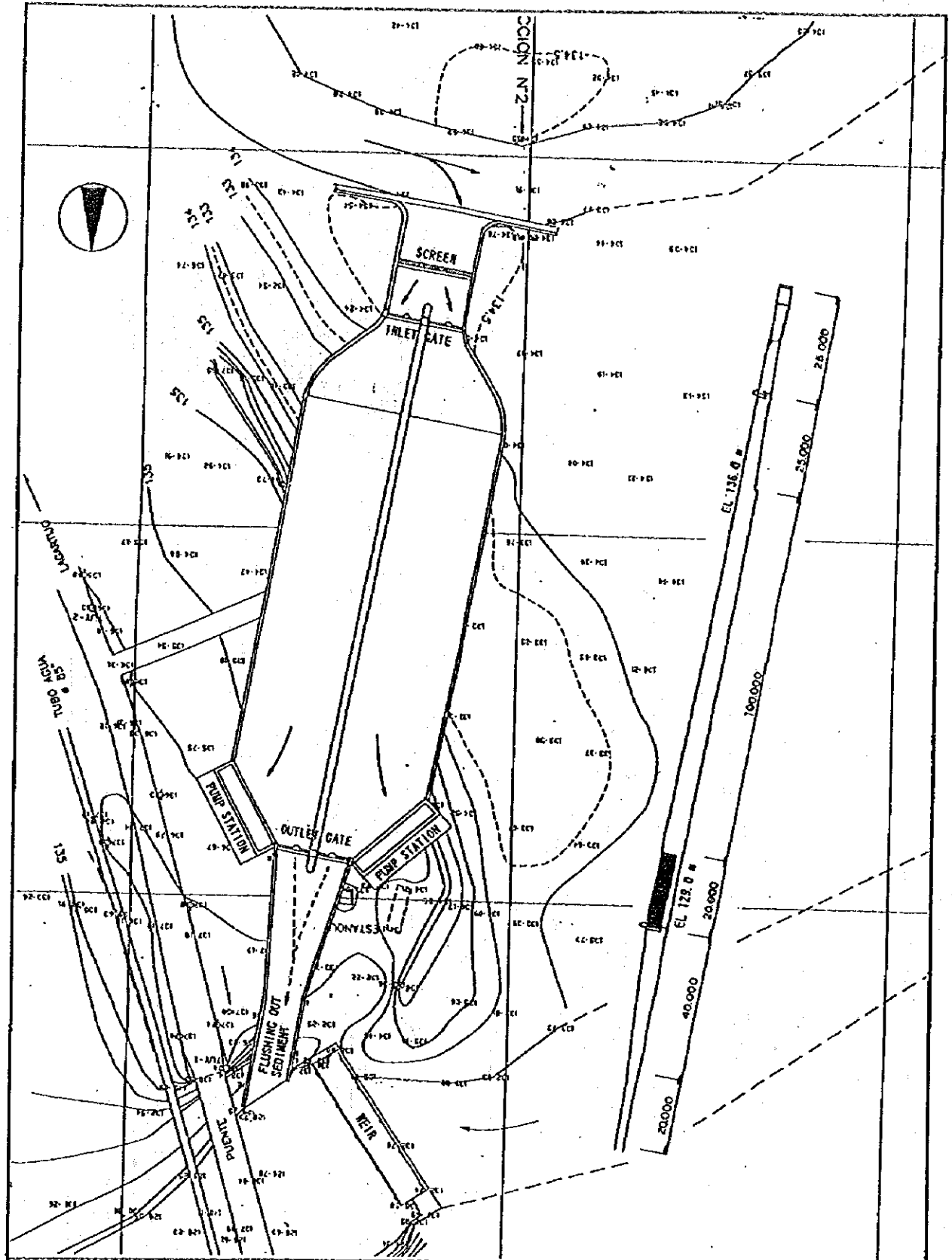

THE STUDY ON
 THE ENVIRONMENTAL IMPROVEMENT PROGRAM OF THE UPPER AND MIDDLE
 STREAM OF THE TUY RIVER BASIN
 IN THE REPUBLIC OF VENEZUELA
 JAPAN INTERNATIONAL COOPERATION AGENCY

Fig. 3.6-1 Diseño Preliminar del Tanque Sedimentador de Arena

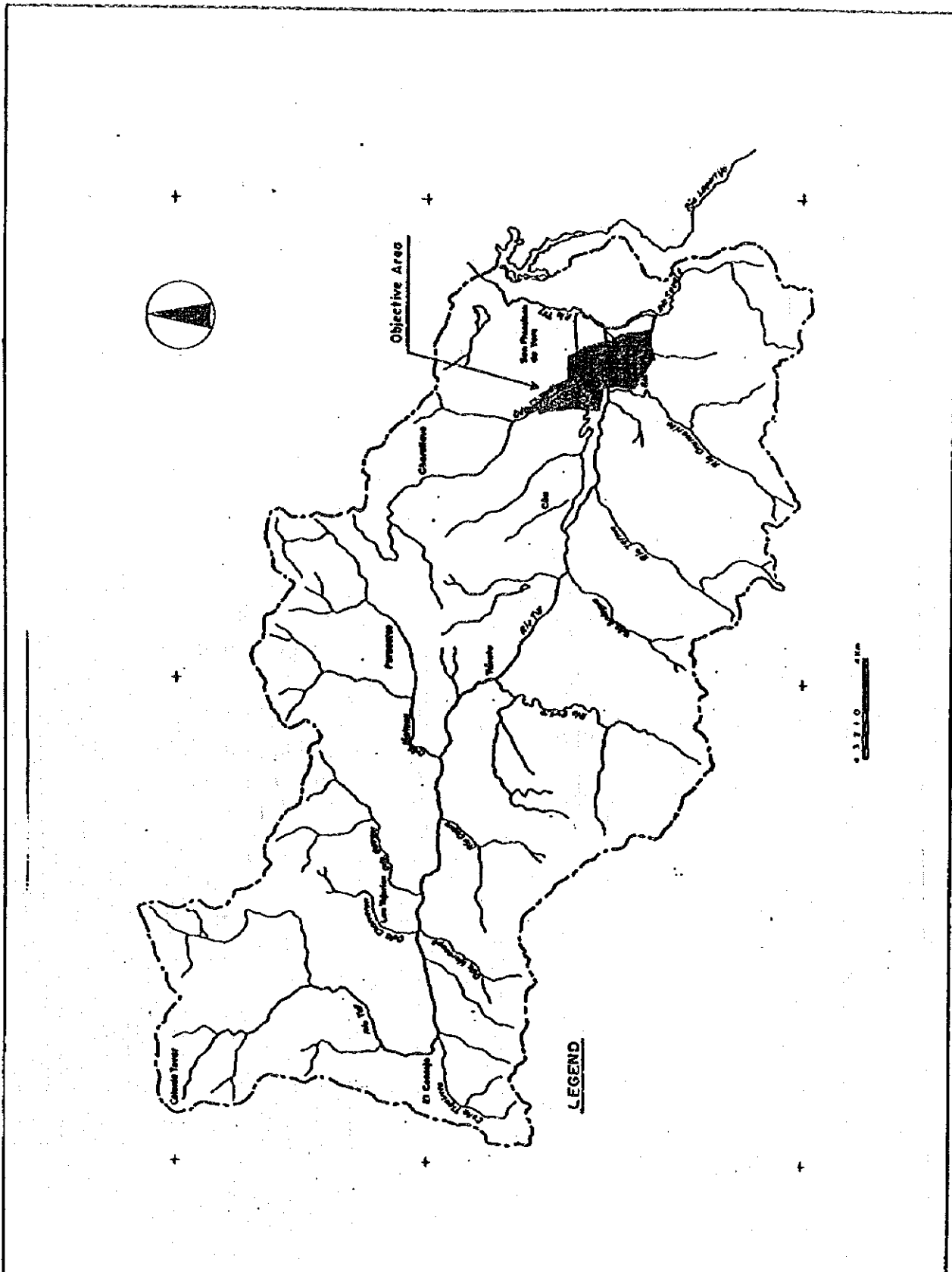

THE STUDY ON
 THE ENVIRONMENTAL IMPROVEMENT PROGRAM OF THE UPPER AND MIDDLE
 STREAM OF THE TUY RIVER BASIN
 IN THE REPUBLIC OF VENEZUELA

JAPAN INTERNATIONAL COOPERATION AGENCY

Fig. 4.2-1 Ubicacion del Area Objetivo

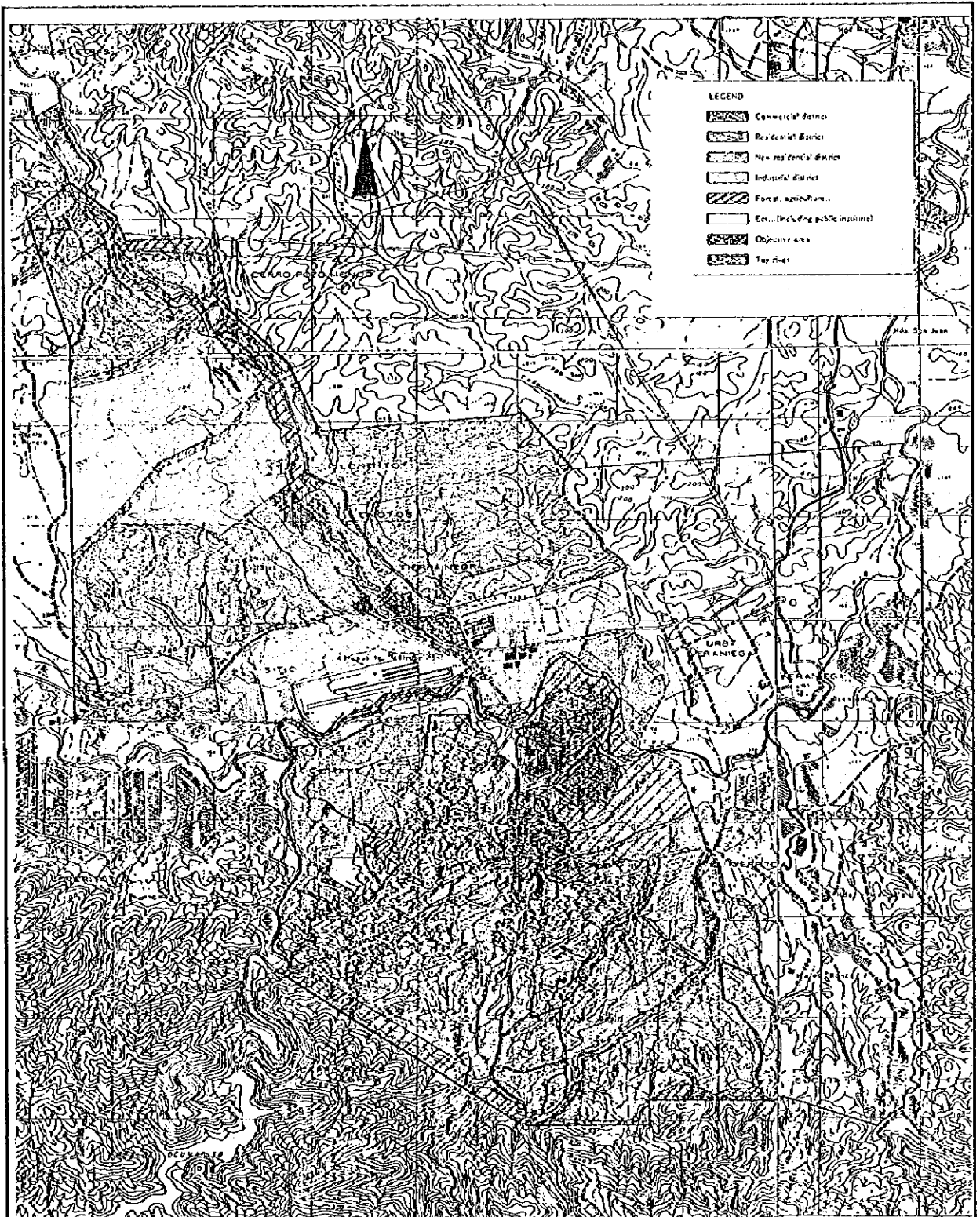

SCALE

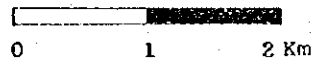

THE STUDY ON
 THE ENVIRONMENTAL IMPROVEMENT PROGRAM OF THE UPPER AND MIDDLE
 STREAM OF THE TUY RIVER BASIN
 IN THE REPUBLIC OF VENEZUELA

JAPAN INTERNATIONAL COOPERATION AGENCY

Fig. 4.2-2 Plan de Desarrollo Urbano
 del MINDUR

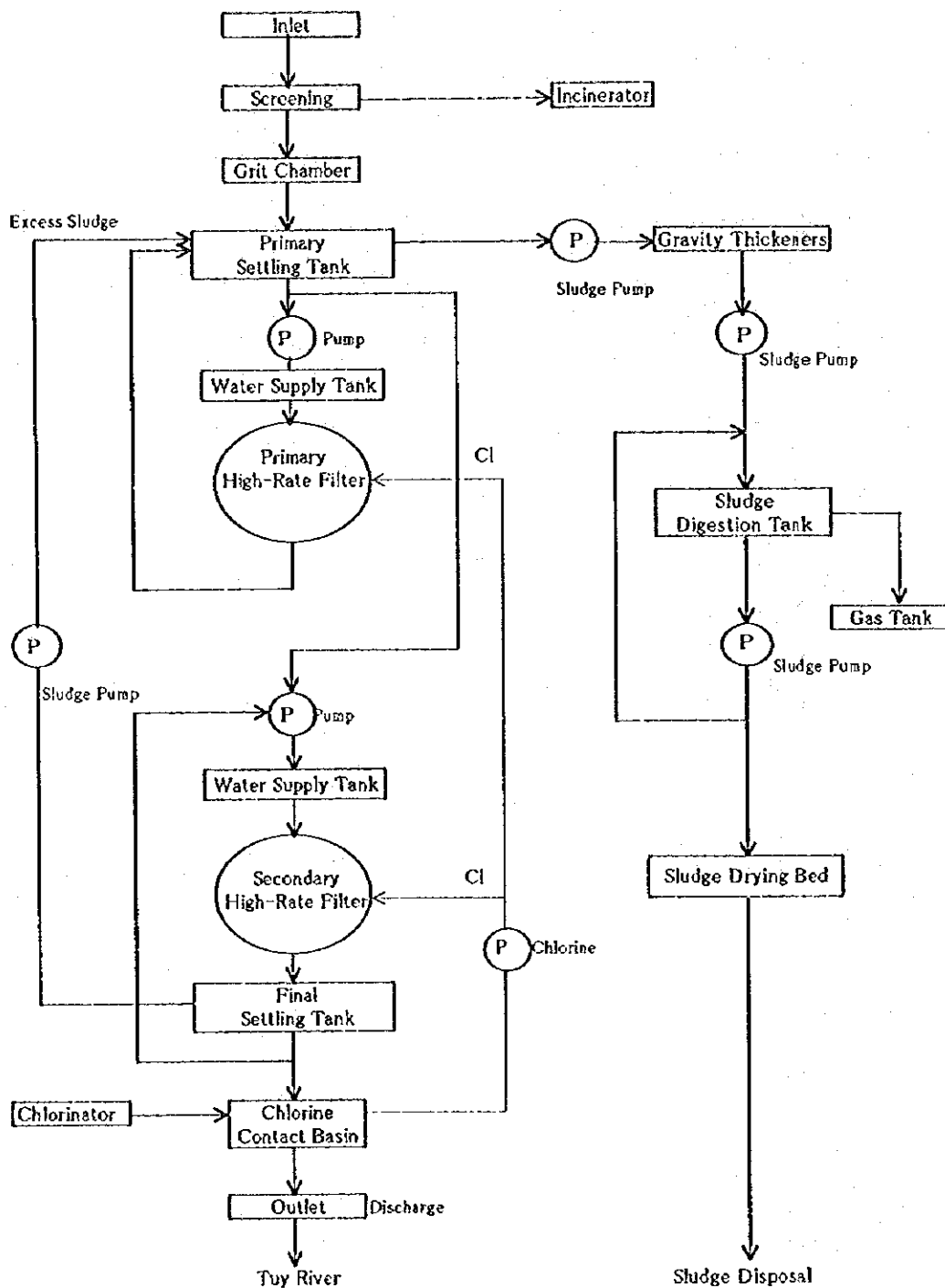

THE STUDY ON
 THE ENVIRONMENTAL IMPROVEMENT PROGRAM OF THE UPPER AND MIDDLE
 STREAM OF THE TUY RIVER BASIN
 IN THE REPUBLIC OF VENEZUELA

JAPAN INTERNATIONAL COOPERATION AGENCY

Fig. 4.4-1 Flujo del Proceso de Tratamiento cloacal propuesto

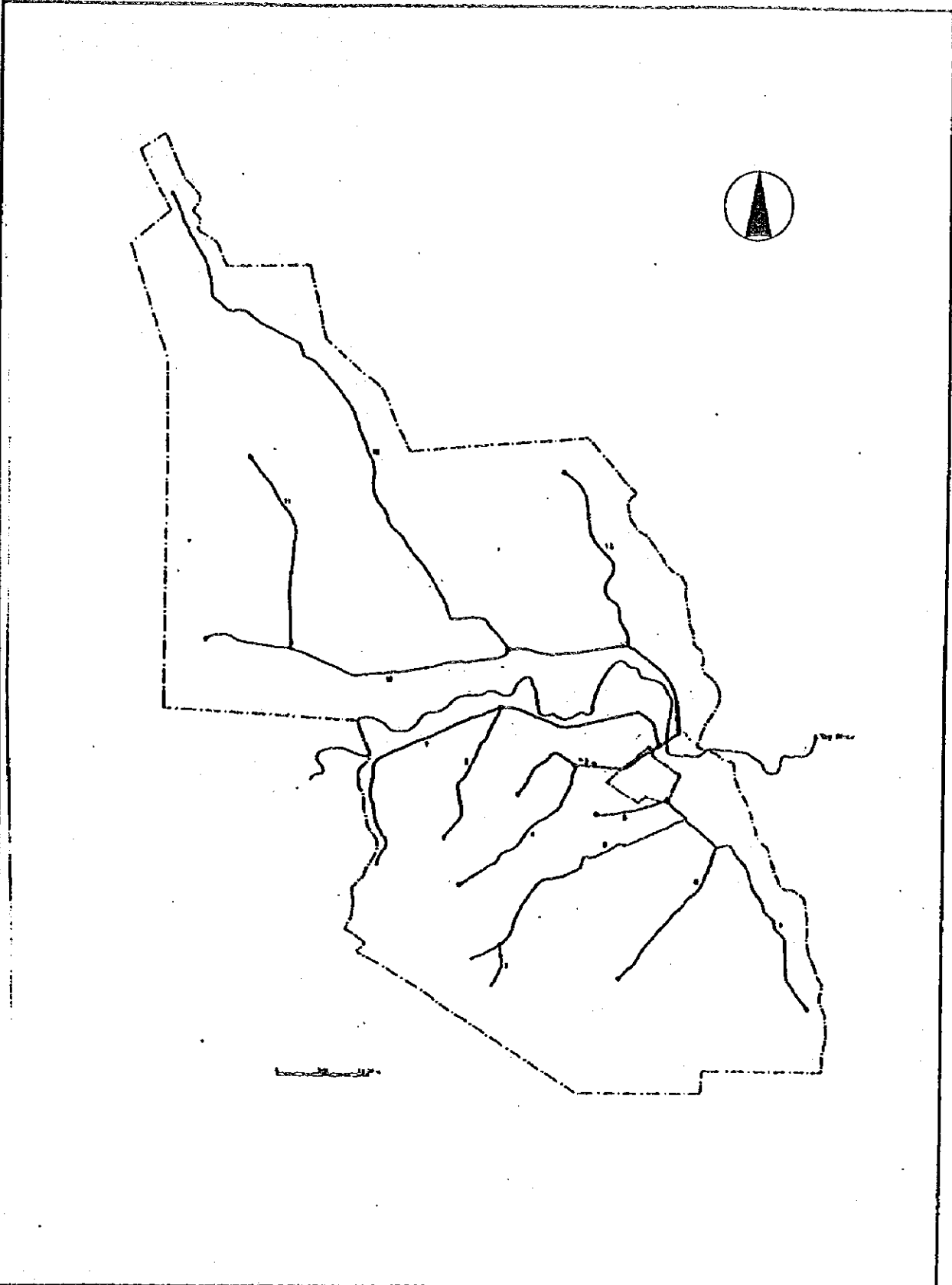

THE STUDY ON
THE ENVIRONMENTAL IMPROVEMENT PROGRAM OF THE UPPER AND MIDDLE
STREAM OF THE TUY RIVER BASIN
IN THE REPUBLIC OF VENEZUELA

JAPAN INTERNATIONAL COOPERATION AGENCY

Fig. 4.4-2 Red de Alcantarillado.
(Principal Drenaje)

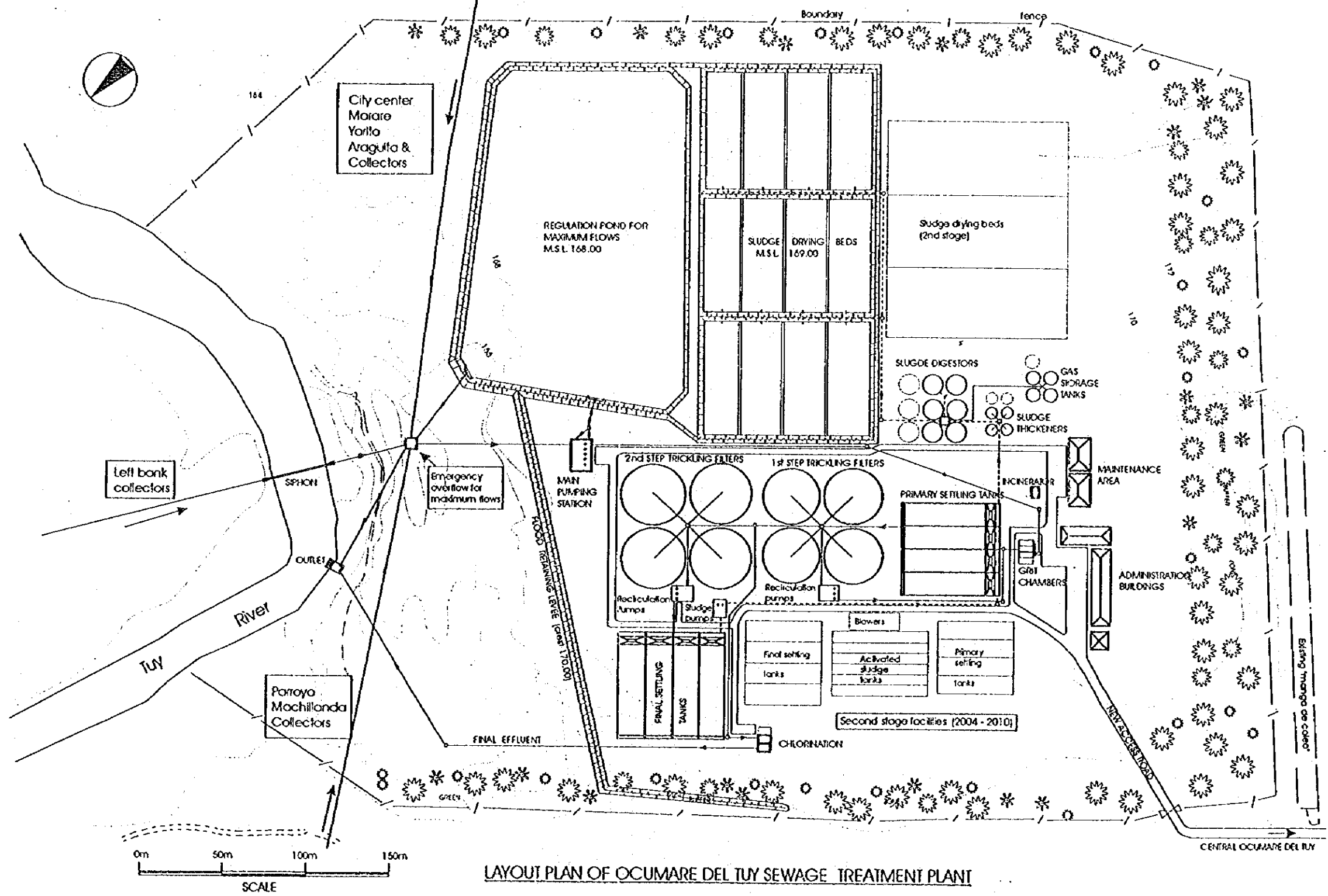

LAYOUT PLAN OF OCUMARE DEL TUY SEWAGE TREATMENT PLANT

THE STUDY ON
 THE ENVIRONMENTAL IMPROVEMENT PROGRAM OF THE UPPER AND MIDDLE
 STREAM OF THE TUY RIVER BASIN
 IN THE REPUBLIC OF VENEZUELA
 JAPAN INTERNATIONAL COOPERATION AGENCY

Fig. 4.4-3 Perfil de la Planta de
 Tratamiento Cloacal

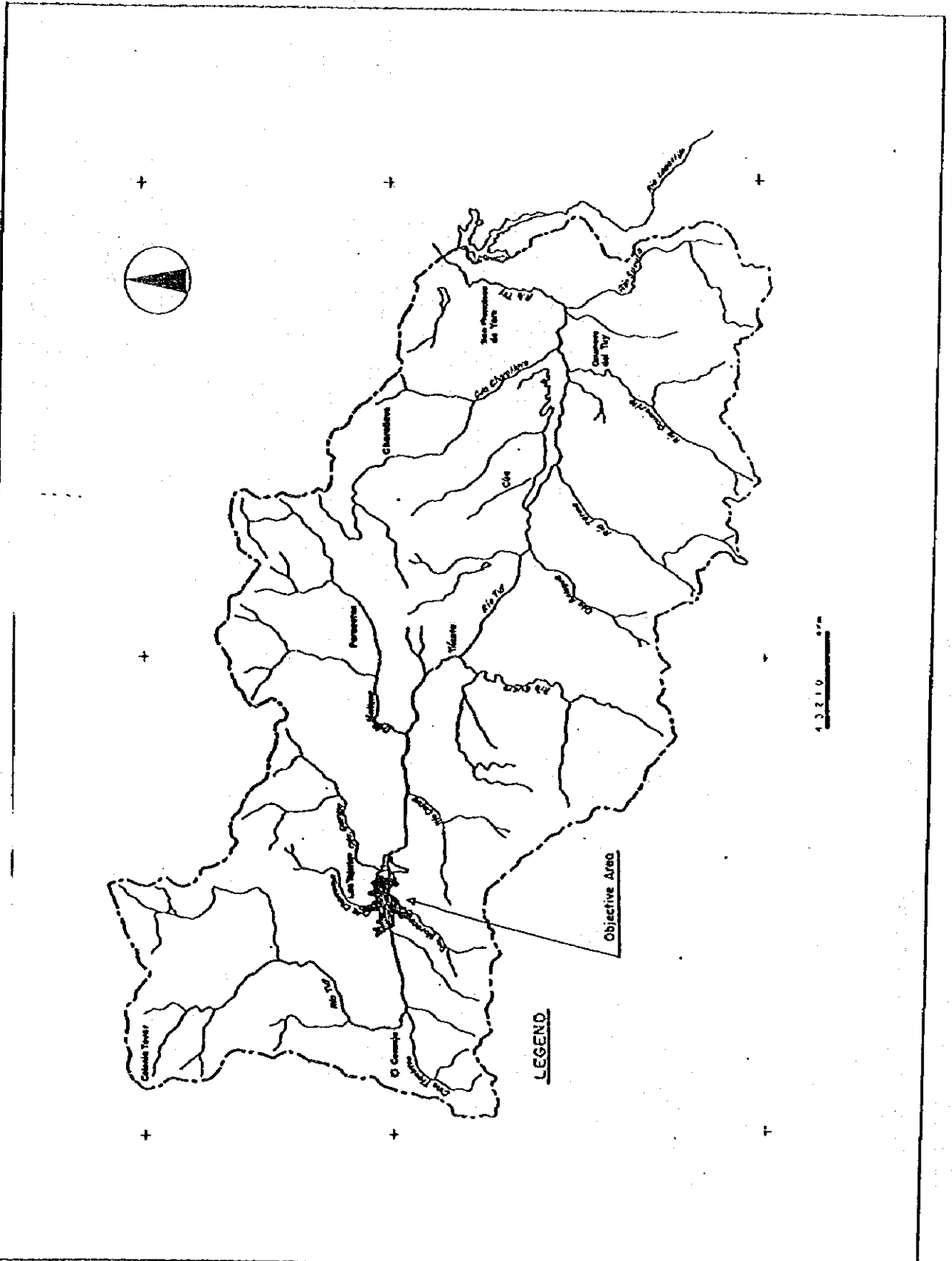









THE STUDY ON
 THE ENVIRONMENTAL IMPROVEMENT PROGRAM OF THE UPPER AND MIDDLE
 STREAM OF THE TUY RIVER BASIN
 IN THE REPUBLIC OF VENEZUELA

JAPAN INTERNATIONAL COOPERATION AGENCY

Fig. 5.2-1 Ubicacion del Area Objetivo



LEGEND

-  Commercial district
-  Residential district
-  New residential district
-  Industrial district
-  Forest, agriculture
-  Etc. (including public institution)
-  Objective area
-  Express way

SCALE

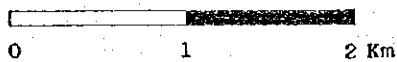

THE STUDY ON
 THE ENVIRONMENTAL IMPROVEMENT PROGRAM OF THE UPPER AND MIDDLE
 STREAM OF THE TUY RIVER BASIN
 IN THE REPUBLIC OF VENEZUELA

Fig. 5.2-2 Plan de Desarrollo Urbano
 del MINDUR

JAPAN INTERNATIONAL COOPERATION AGENCY

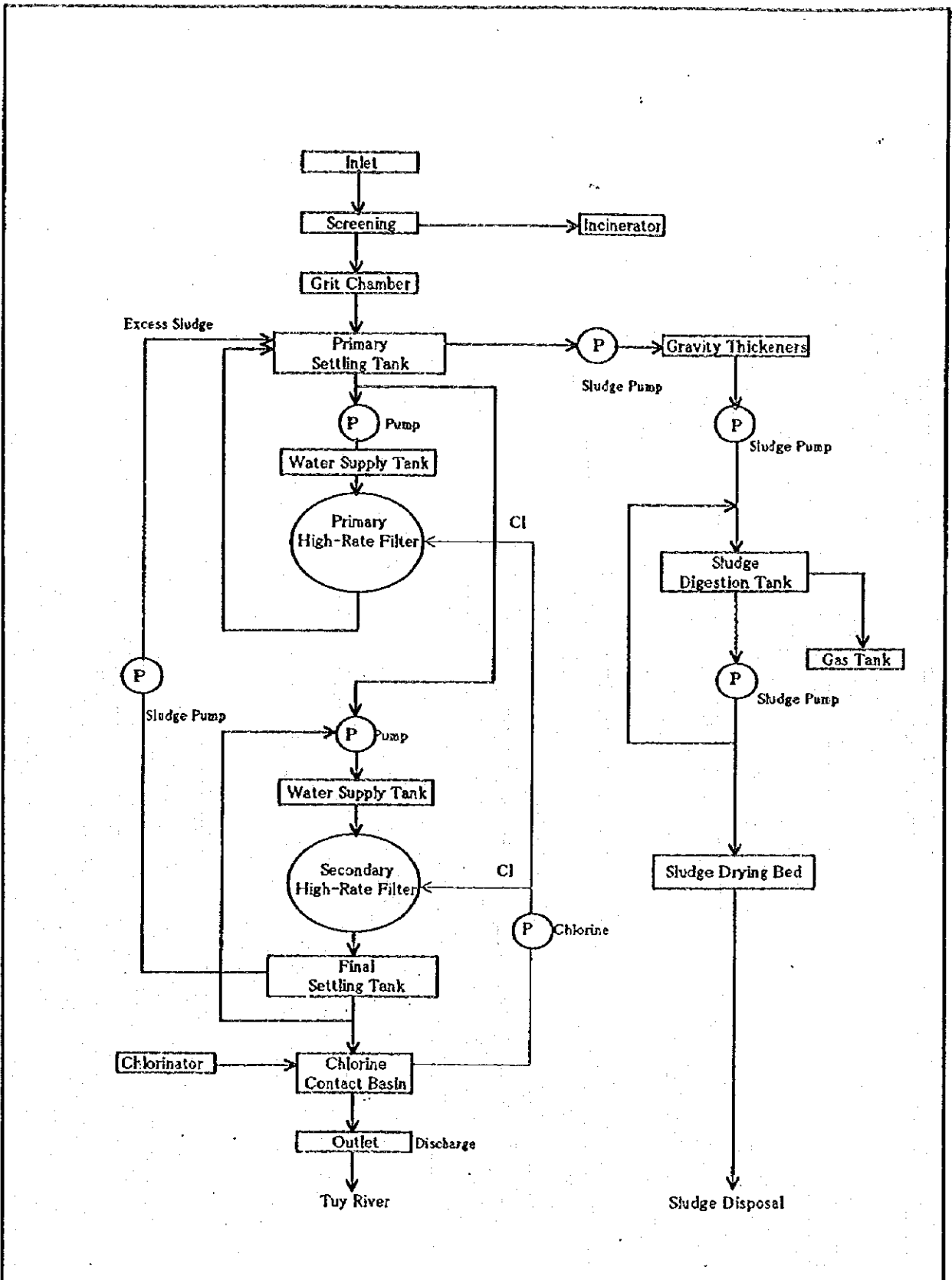

THE STUDY ON
 THE ENVIRONMENTAL IMPROVEMENT PROGRAM OF THE UPPER AND MIDDLE
 STREAM OF THE TUY RIVER BASIN
 IN THE REPUBLIC OF VENEZUELA
 JAPAN INTERNATIONAL COOPERATION AGENCY

Fig. 5.4-1 Flujo del Proceso de Tratamiento cloacal propuesto:

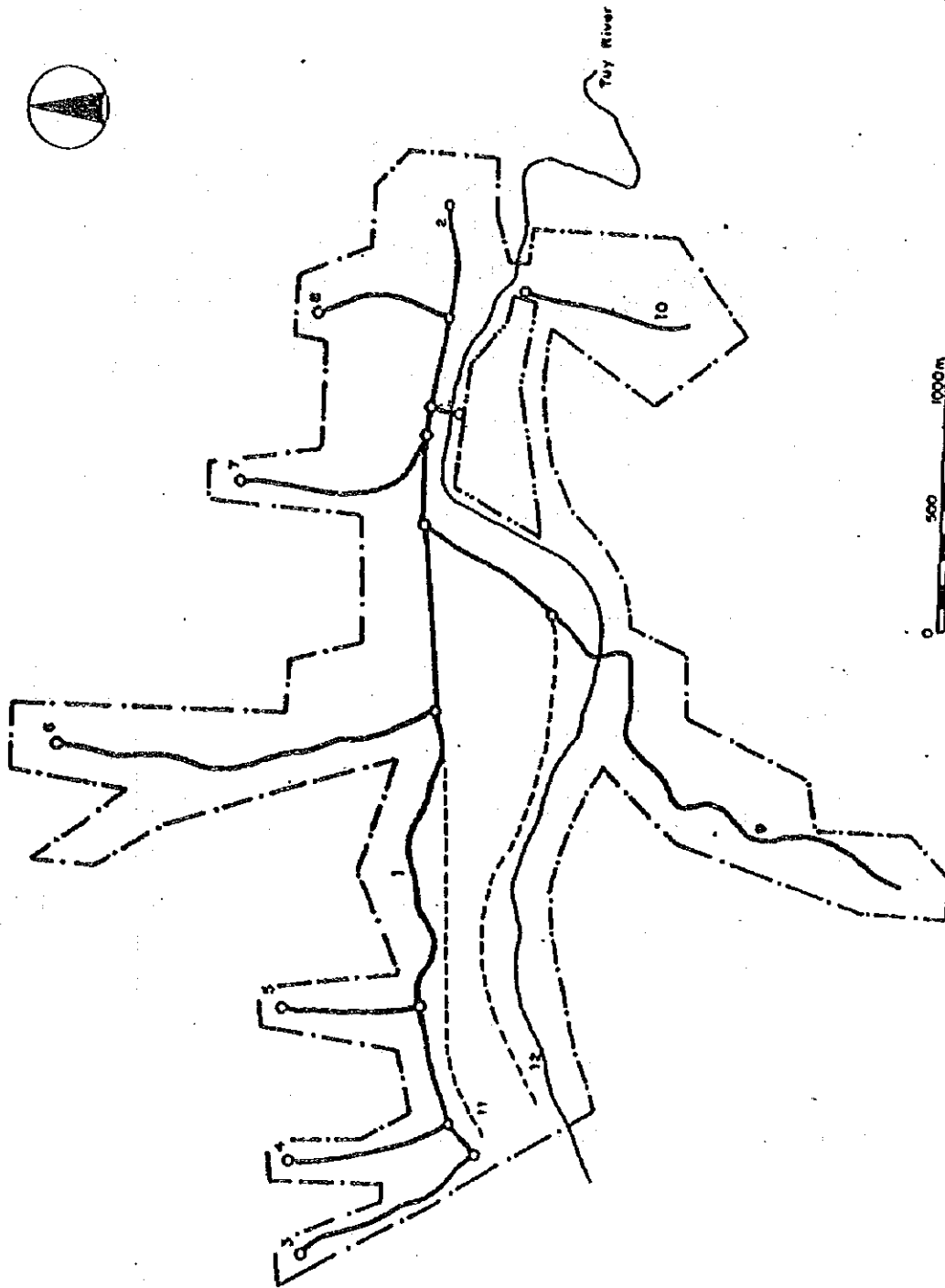

THE STUDY ON
 THE ENVIRONMENTAL IMPROVEMENT PROGRAM OF THE UPPER AND MIDDLE
 STREAM OF THE TUY RIVER BASIN
 IN THE REPUBLIC OF VENEZUELA

JAPAN INTERNATIONAL COOPERATION AGENCY

Fig. 5.4-2 Red de Alcantarillado
 (Principal Drenaje)

Layout Plan of Las Tejerias Sewage Treatment Plant

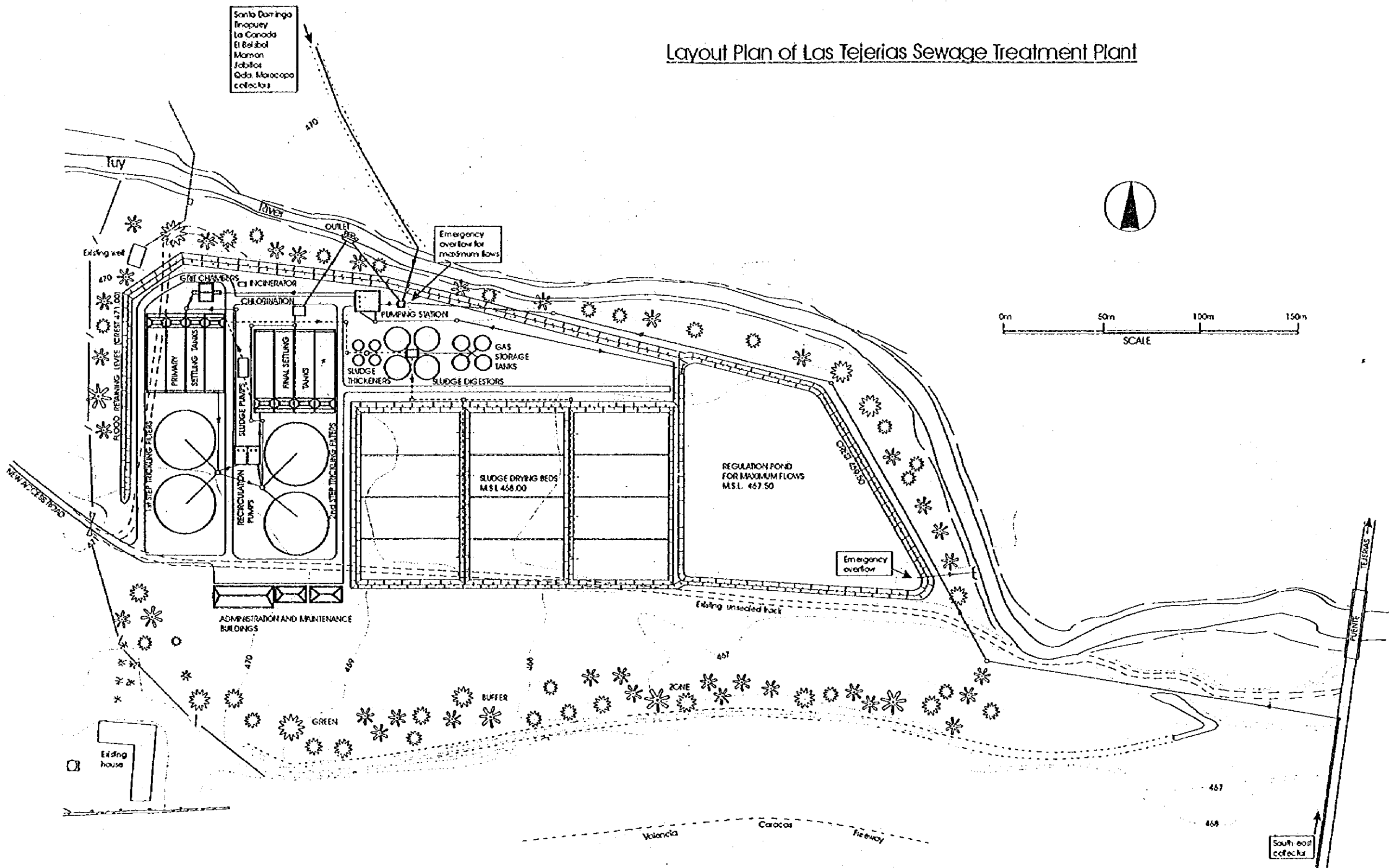

THE STUDY ON
 THE ENVIRONMENTAL IMPROVEMENT PROGRAM OF THE UPPER AND MIDDLE
 STREAM OF THE TUY RIVER BASIN
 IN THE REPUBLIC OF VENEZUELA
 JAPAN INTERNATIONAL COOPERATION AGENCY

Fig. 5.4-3 Perfil de la Planta de Tratamiento Cloacal

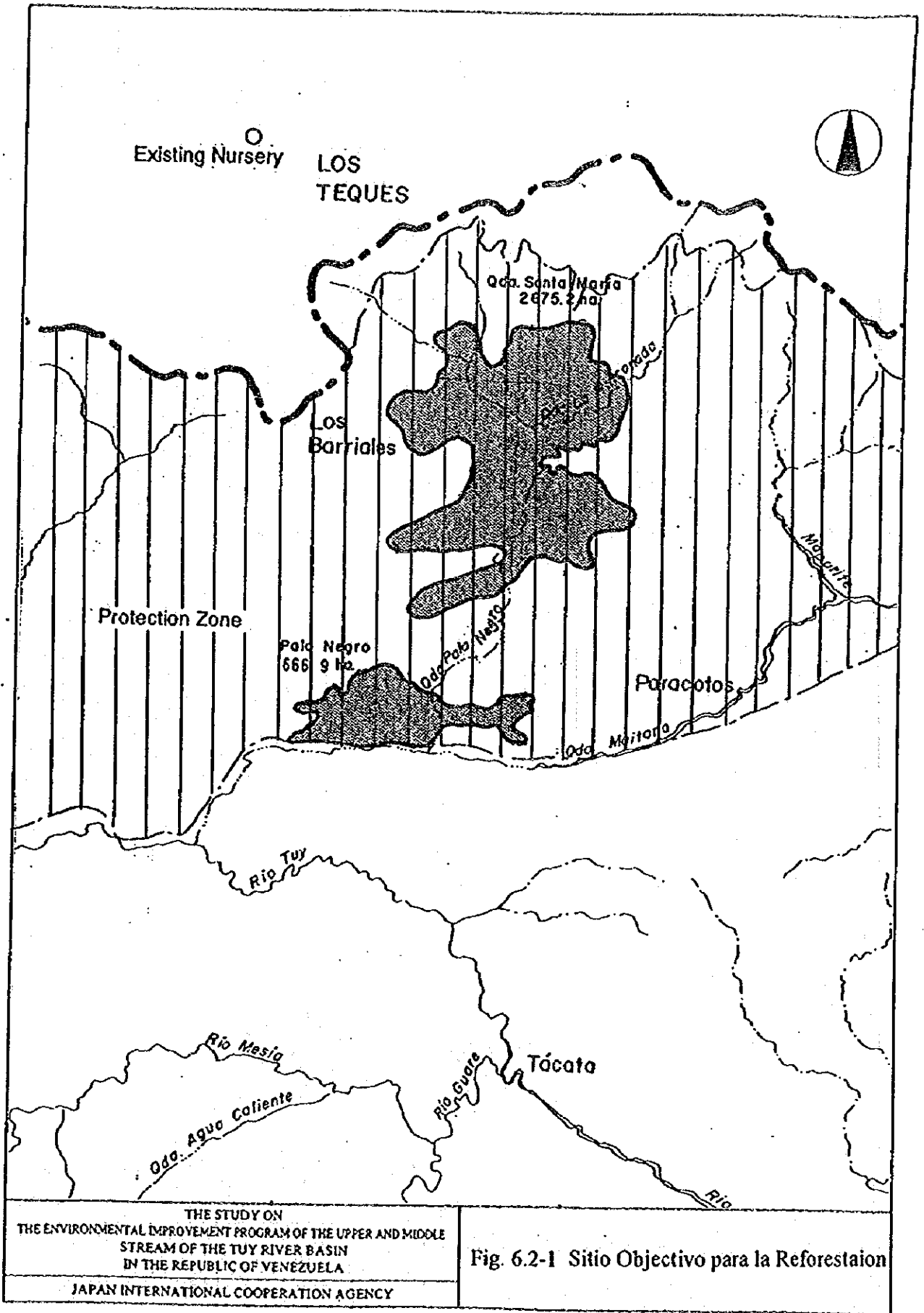

THE STUDY ON
 THE ENVIRONMENTAL IMPROVEMENT PROGRAM OF THE UPPER AND MIDDLE
 STREAM OF THE TUY RIVER BASIN
 IN THE REPUBLIC OF VENEZUELA

JAPAN INTERNATIONAL COOPERATION AGENCY

Fig. 6.2-1 Sitio Objetivo para la Reforestacion

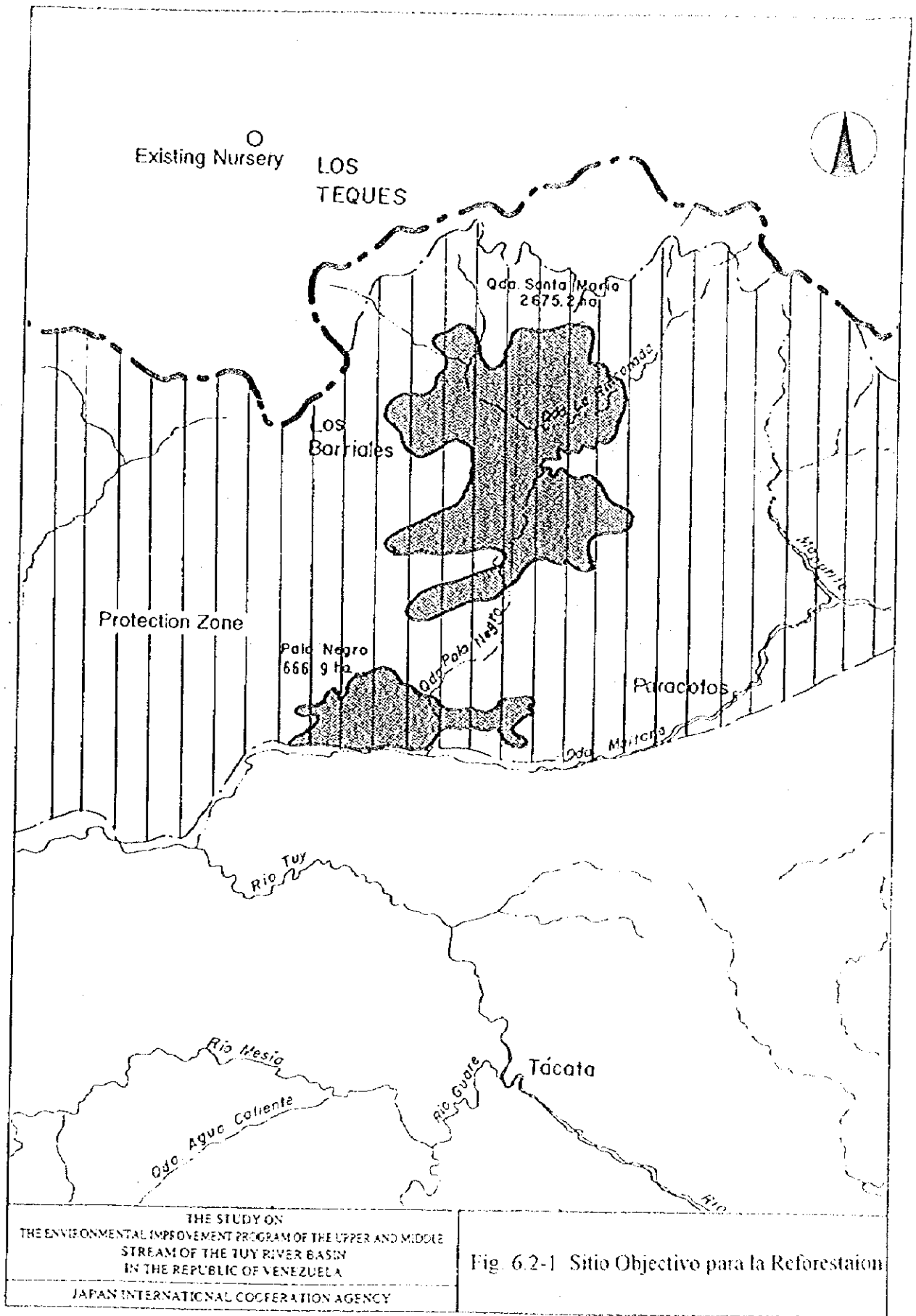

A - A SECTION

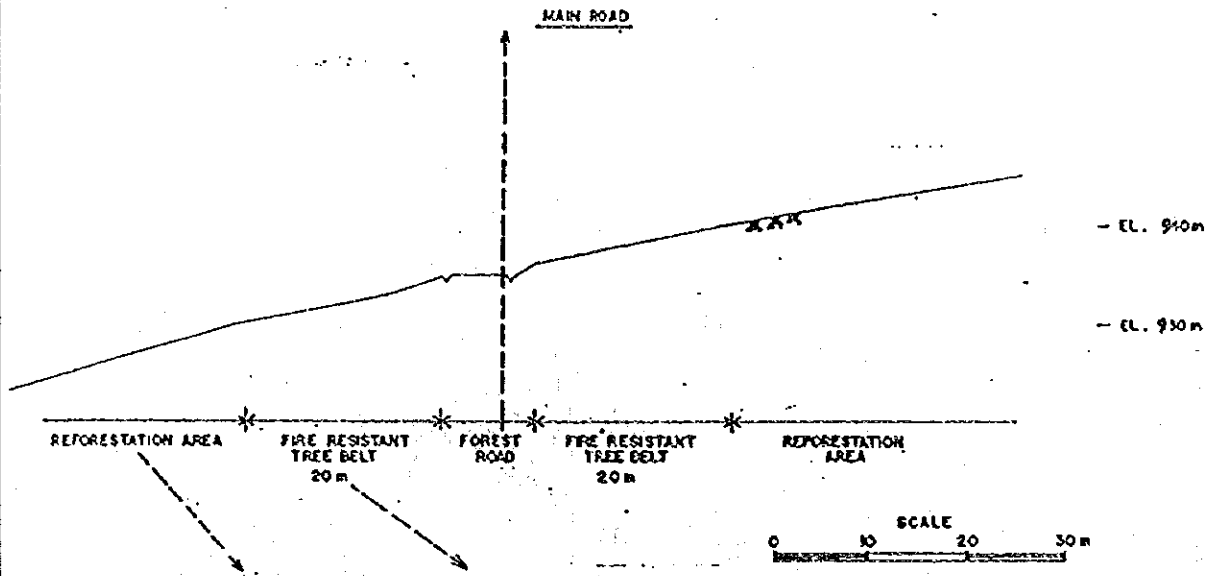
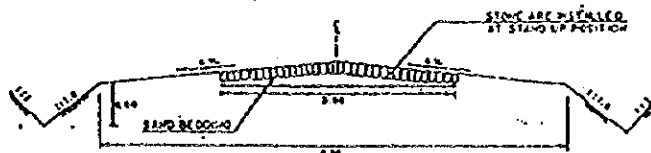

REFORESTATION AREA * FIRE RESISTANT TREE BELT 20m * FOREST ROAD * FIRE RESISTANT TREE BELT 20m * REFORESTATION AREA

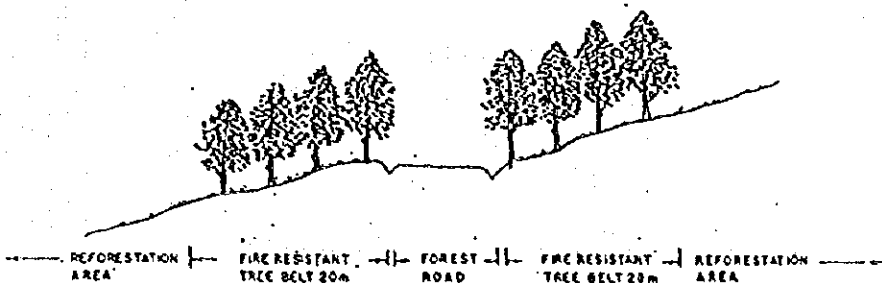
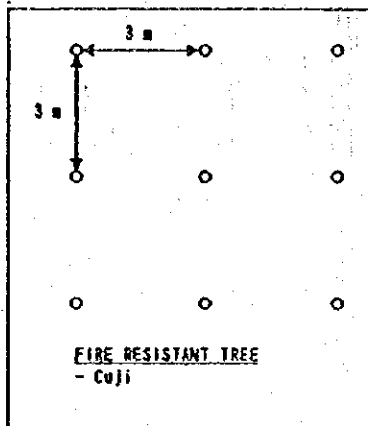
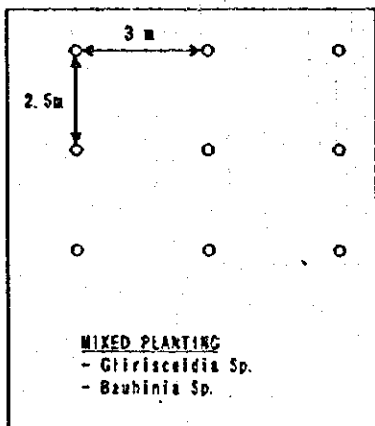
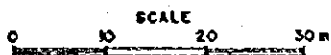

THE STUDY ON
THE ENVIRONMENTAL IMPROVEMENT PROGRAM OF THE UPPER AND MIDDLE
STREAM OF THE TUY RIVER BASIN
IN THE REPUBLIC OF VENEZUELA

JAPAN INTERNATIONAL COOPERATION AGENCY

Fig. 6.3-1 Plan de Plantacion

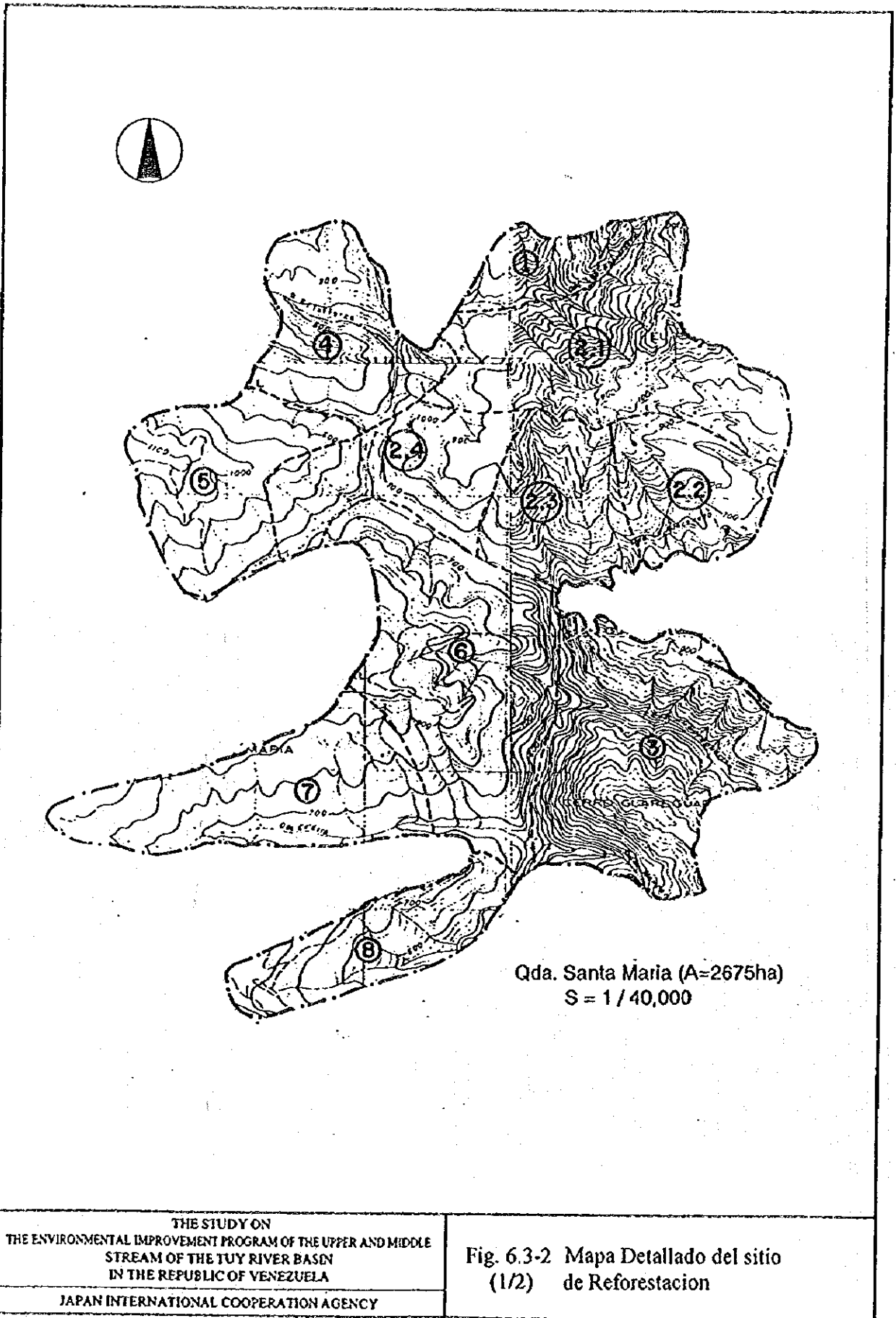

THE STUDY ON
THE ENVIRONMENTAL IMPROVEMENT PROGRAM OF THE UPPER AND MIDDLE
STREAM OF THE TUY RIVER BASIN
IN THE REPUBLIC OF VENEZUELA

JAPAN INTERNATIONAL COOPERATION AGENCY

Fig. 6.3-2 Mapa Detallado del sitio
(1/2) de Reforestacion

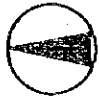

Palo Negro (A-667ha)
S = 1 / 30,000

THE STUDY ON
THE ENVIRONMENTAL IMPROVEMENT PROGRAM OF THE UPPER AND MIDDLE
STREAM OF THE TUY RIVER BASIN
IN THE REPUBLIC OF VENEZUELA

JAPAN INTERNATIONAL COOPERATION AGENCY

Fig. 6.3-2 Mapa Detallado del sitio
(2/2) de Reforestacion

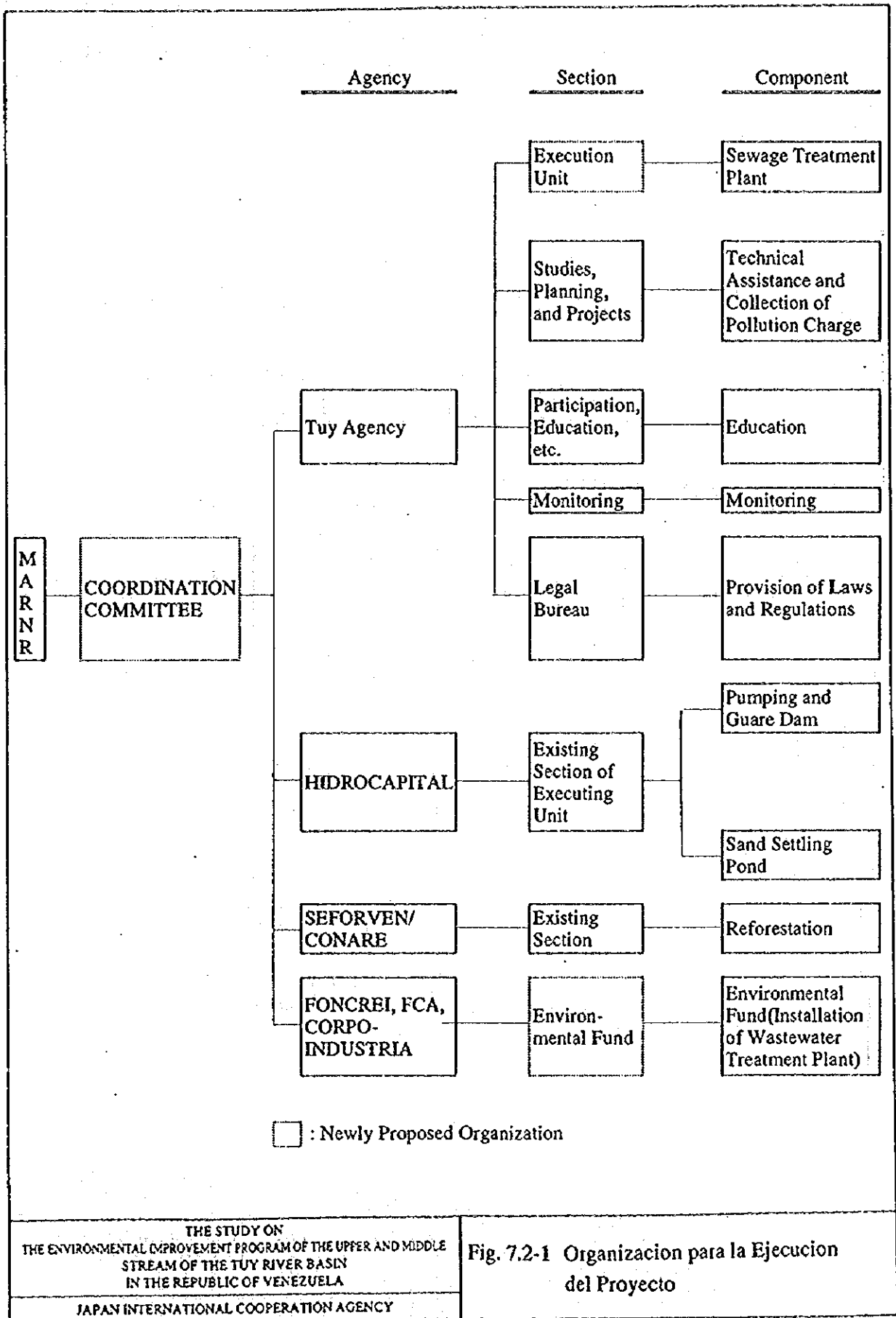

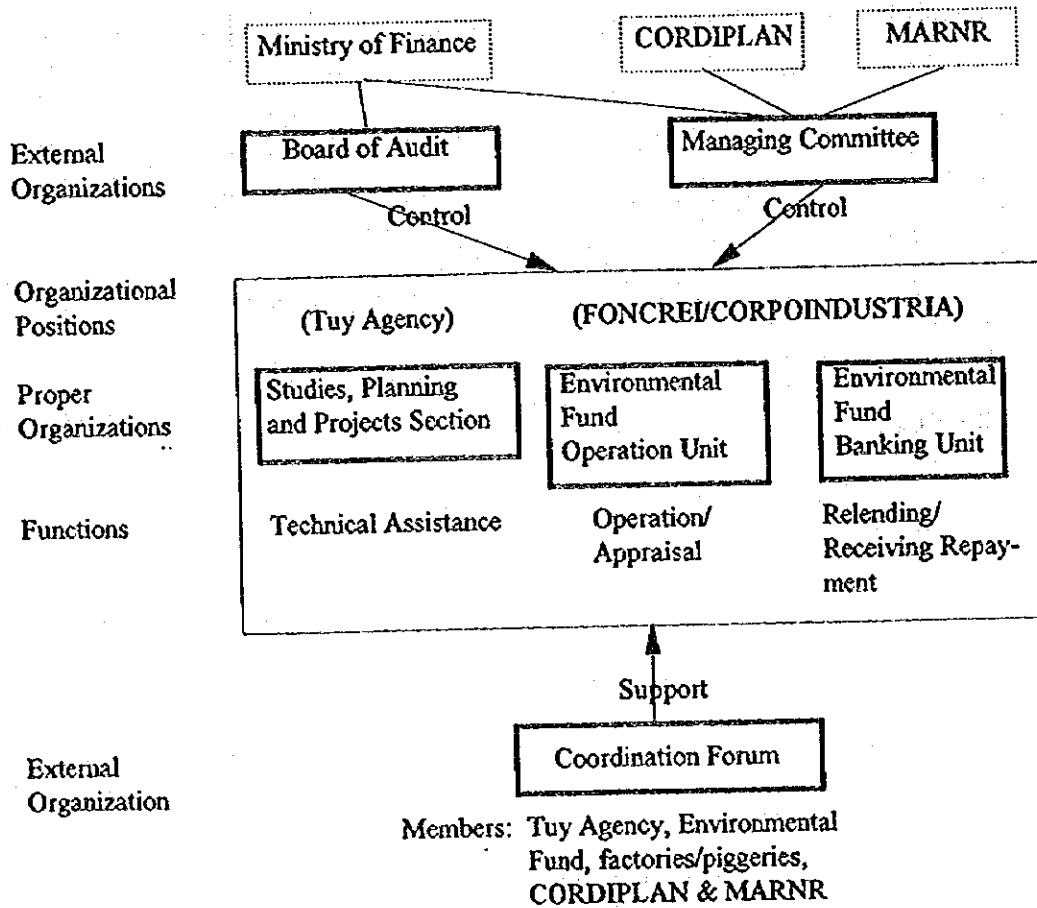

Note: FCA (Fondo de Credito Agropecuario) will perform banking functions for piggeries. However, it will not undergo any organizational change upon the introduction of the Environmental Fund.

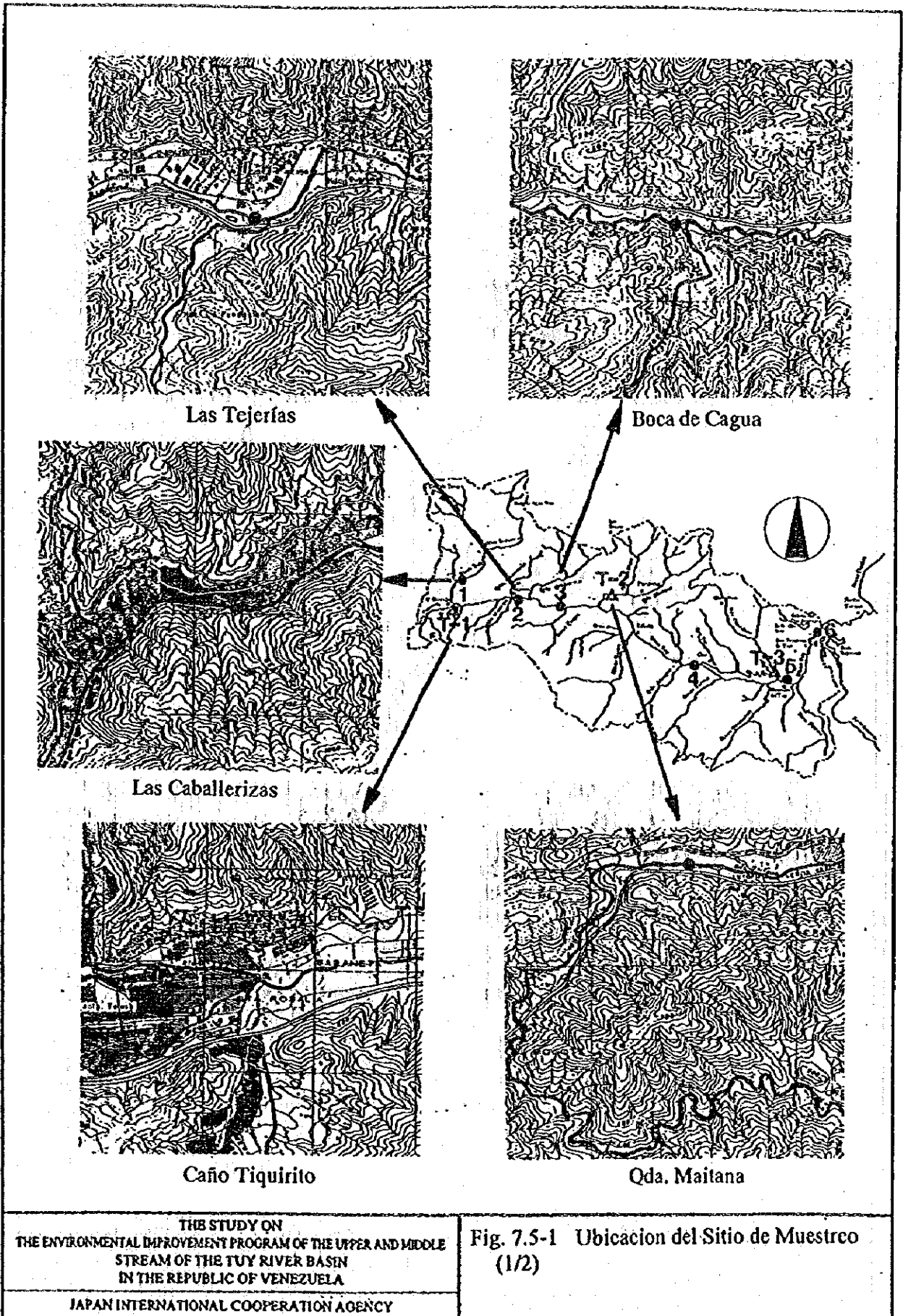

THE STUDY ON
 THE ENVIRONMENTAL IMPROVEMENT PROGRAM OF THE UPPER AND MIDDLE
 STREAM OF THE TUY RIVER BASIN
 IN THE REPUBLIC OF VENEZUELA

JAPAN INTERNATIONAL COOPERATION AGENCY

Fig. 7.5-1 Ubicacion del Sitio de Muestreo (1/2)



Qda. Charallave



S.A. de Yare

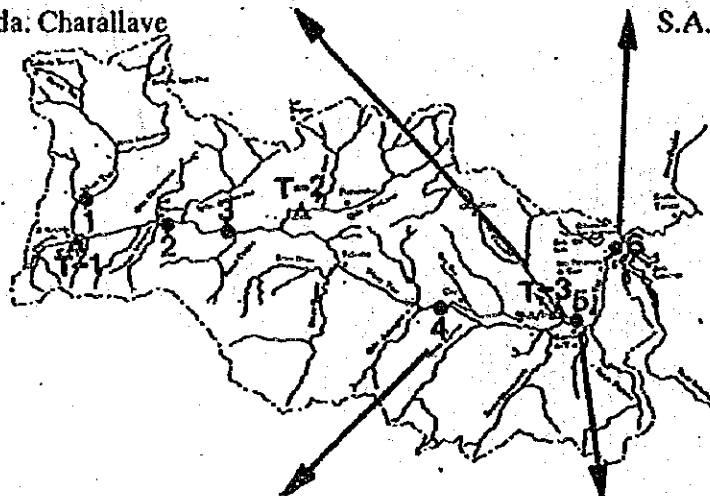

Cua Bridge



Ocumare Bridge

THE STUDY ON
THE ENVIRONMENTAL IMPROVEMENT PROGRAM OF THE UPPER AND MIDDLE
STREAM OF THE TUY RIVER BASIN
IN THE REPUBLIC OF VENEZUELA

JAPAN INTERNATIONAL COOPERATION AGENCY

Fig. 7.5-1 Ubicacion del Sitio de Muestreo:
(2/2)

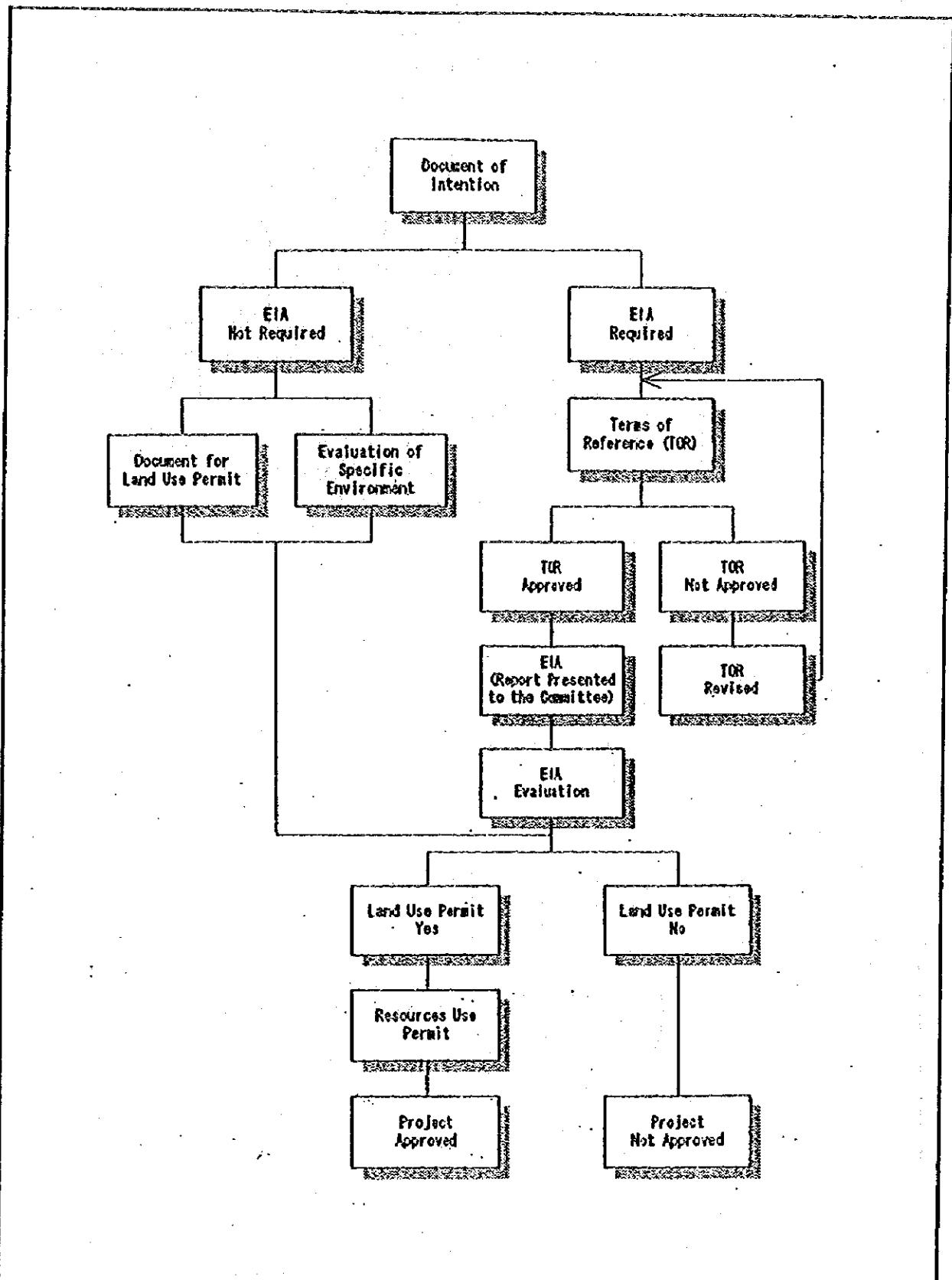

THE STUDY ON
 THE ENVIRONMENTAL IMPROVEMENT PROGRAM OF THE UPPER AND MIDDLE
 STREAM OF THE TUY RIVER BASIN
 IN THE REPUBLIC OF VENEZUELA

JAPAN INTERNATIONAL COOPERATION AGENCY

Fig. 9.1-1 Procedimiento para EIA

Ocumarito - Lagartijo Diversion Plan

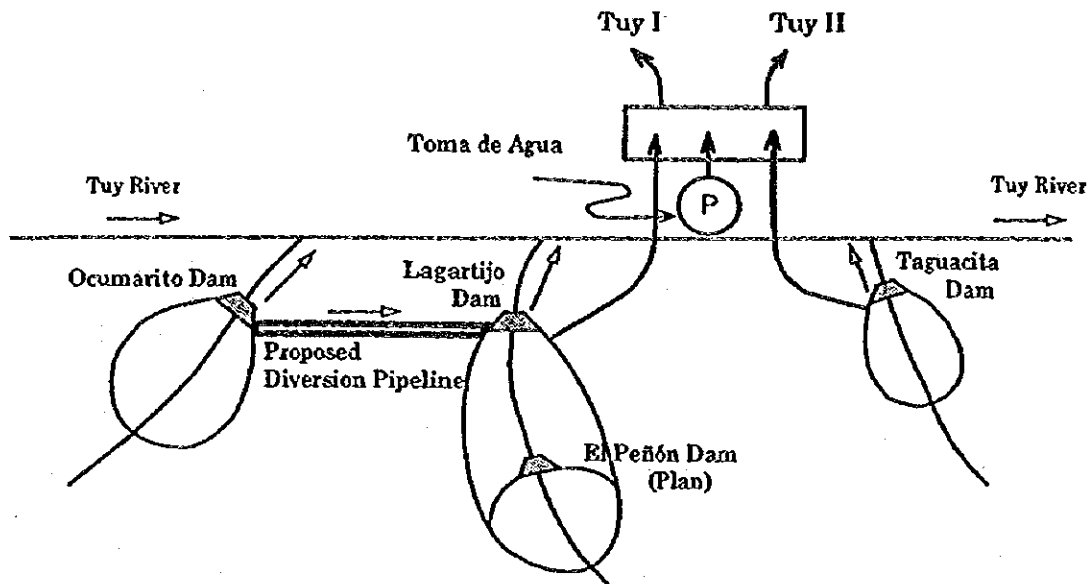

Pumping Plan to Tuy III Pipeline

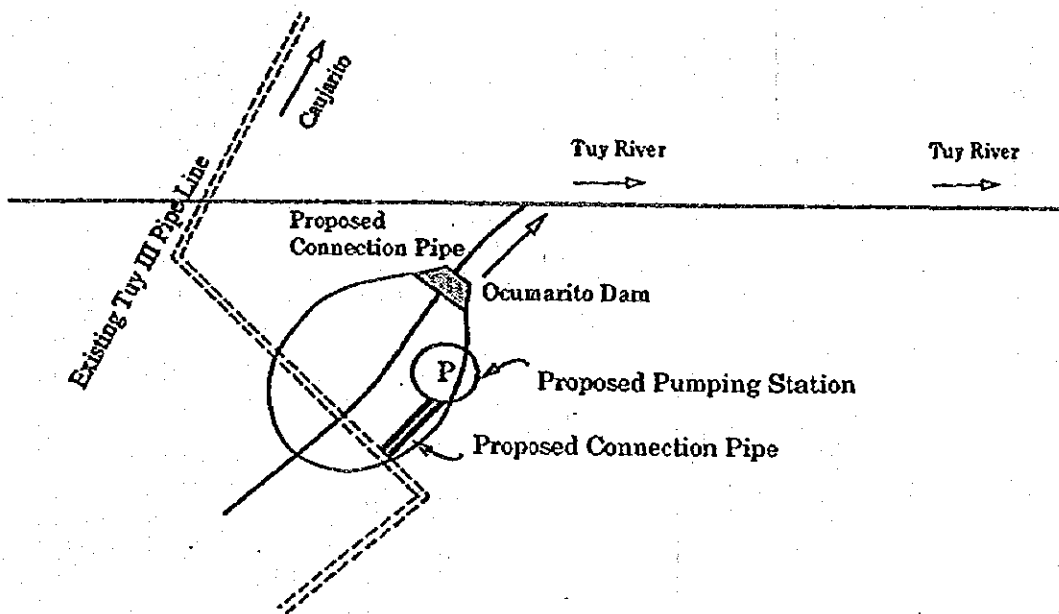

THE STUDY ON
THE ENVIRONMENTAL IMPROVEMENT PROGRAM OF THE UPPER AND MIDDLE
STREAM OF THE TUY RIVER BASIN
IN THE REPUBLIC OF VENEZUELA

JAPAN INTERNATIONAL COOPERATION AGENCY

Fig. 10.3-1 Concepto General del Plan de Utilization del Rio Ocumarito

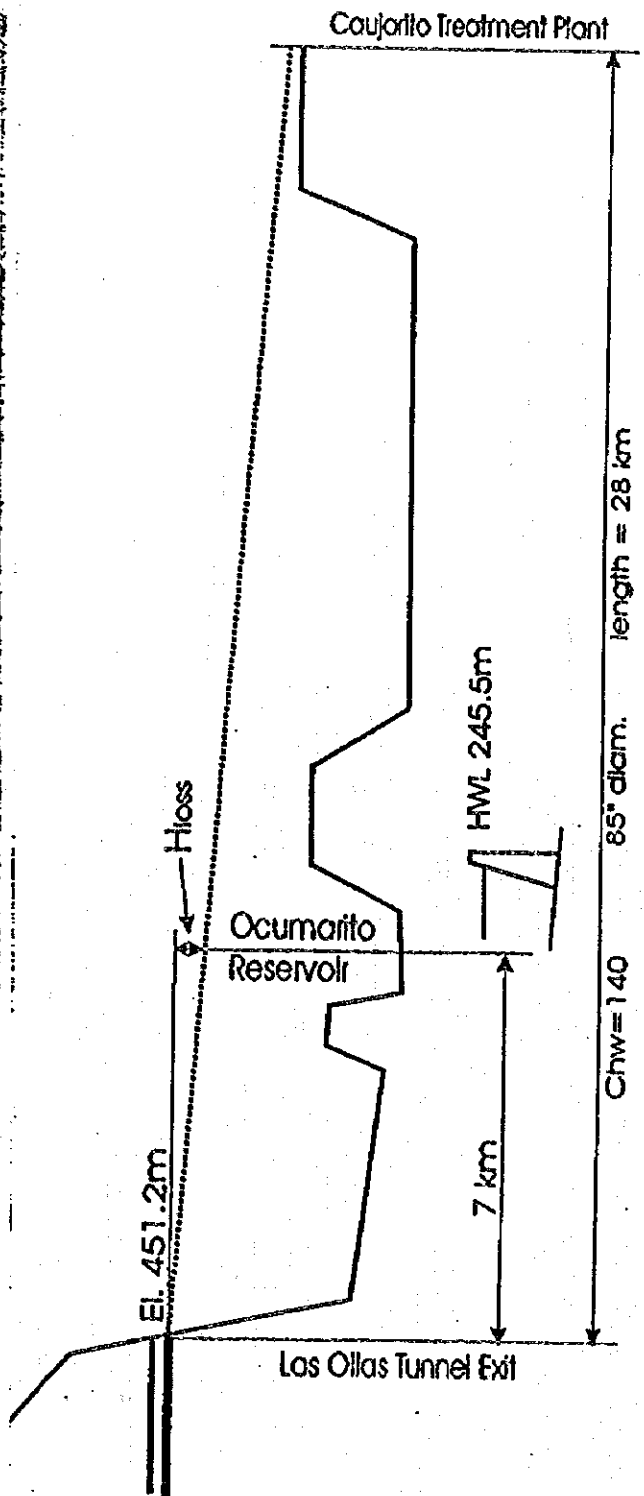
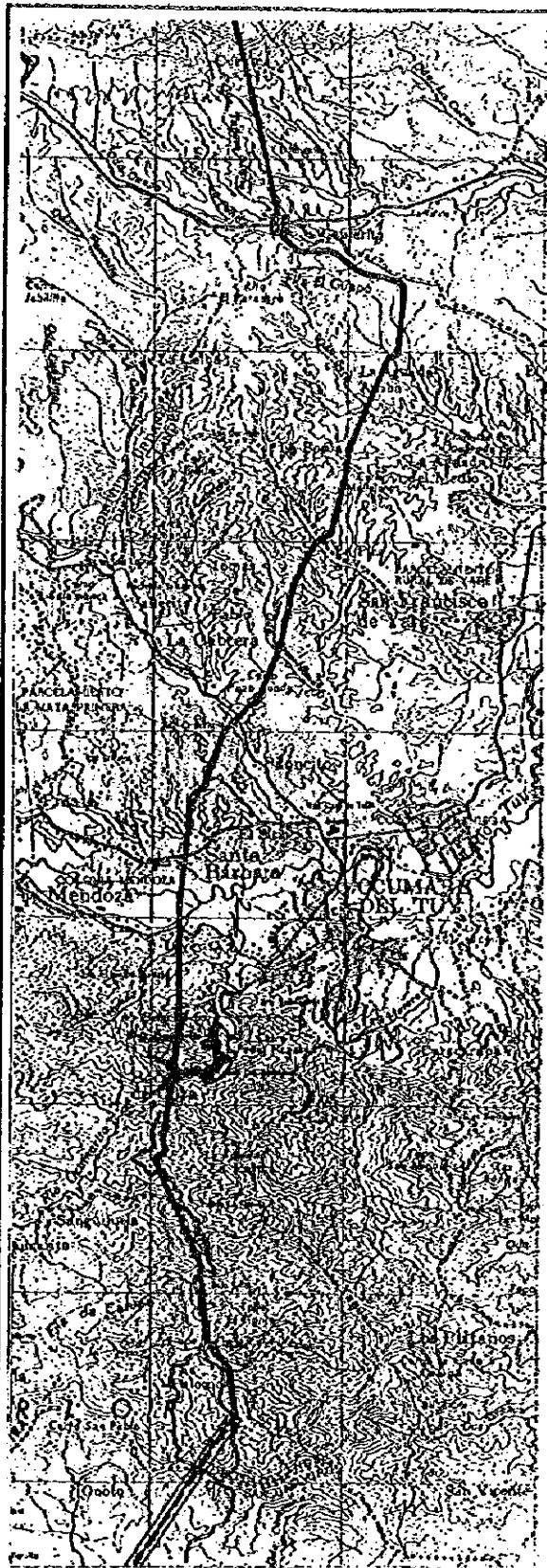

THE STUDY ON
 THE ENVIRONMENTAL IMPROVEMENT PROGRAM OF THE UPPER AND MIDDLE
 STREAM OF THE TUY RIVER BASIN
 IN THE REPUBLIC OF VENEZUELA
 JAPAN INTERNATIONAL COOPERATION AGENCY

Fig. 10.3-2 Plan y Perfil Piezometrico de la Cañeria de Tuy III

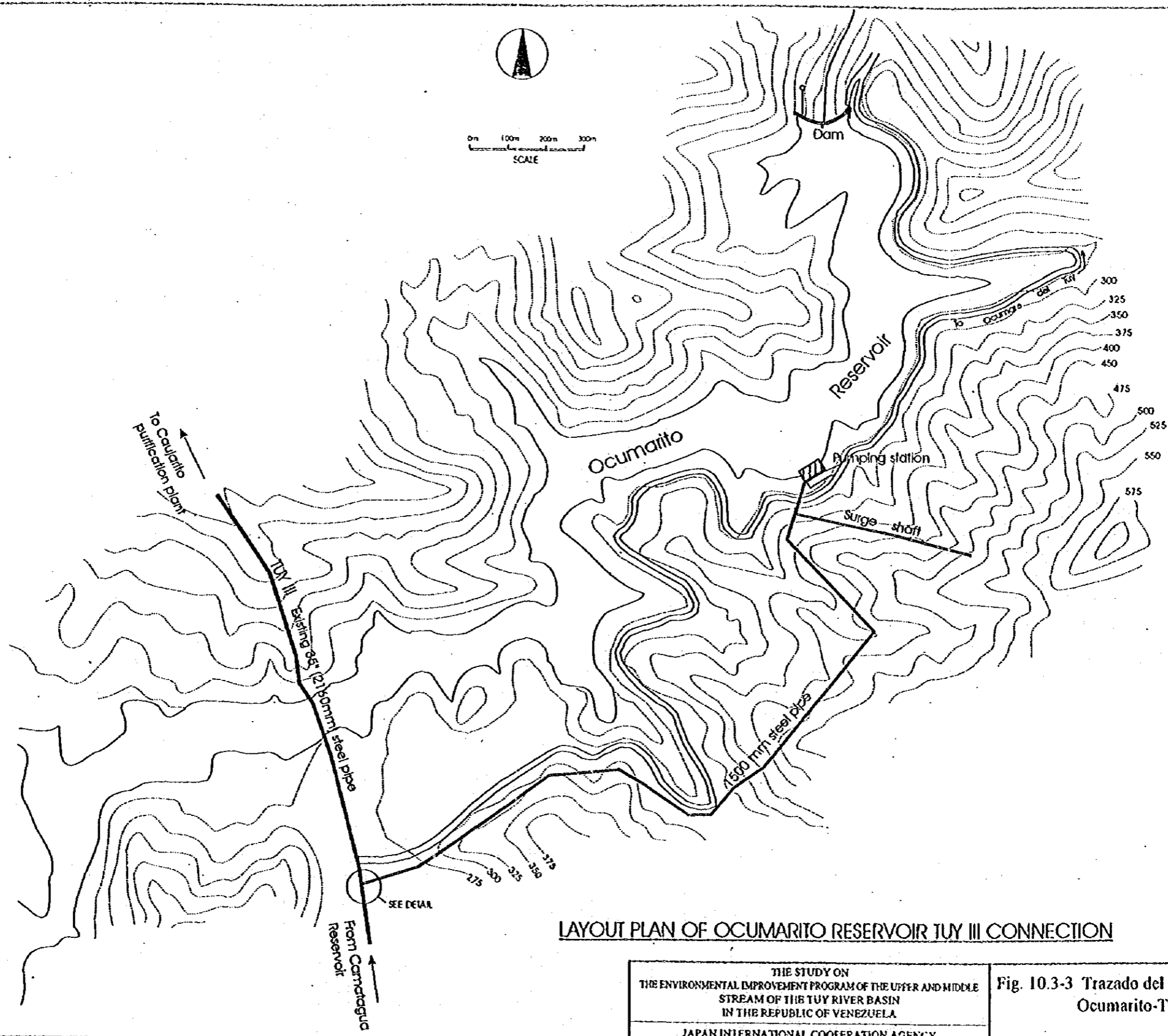

LAYOUT PLAN OF OCUMARITO RESERVOIR TUY III CONNECTION

THE STUDY ON
 THE ENVIRONMENTAL IMPROVEMENT PROGRAM OF THE UPPER AND MIDDLE
 STREAM OF THE TUY RIVER BASIN
 IN THE REPUBLIC OF VENEZUELA
 JAPAN INTERNATIONAL COOPERATION AGENCY

Fig. 10.3-3 Trazado del Plan de Bombeo
 Ocumarito-Tuy III

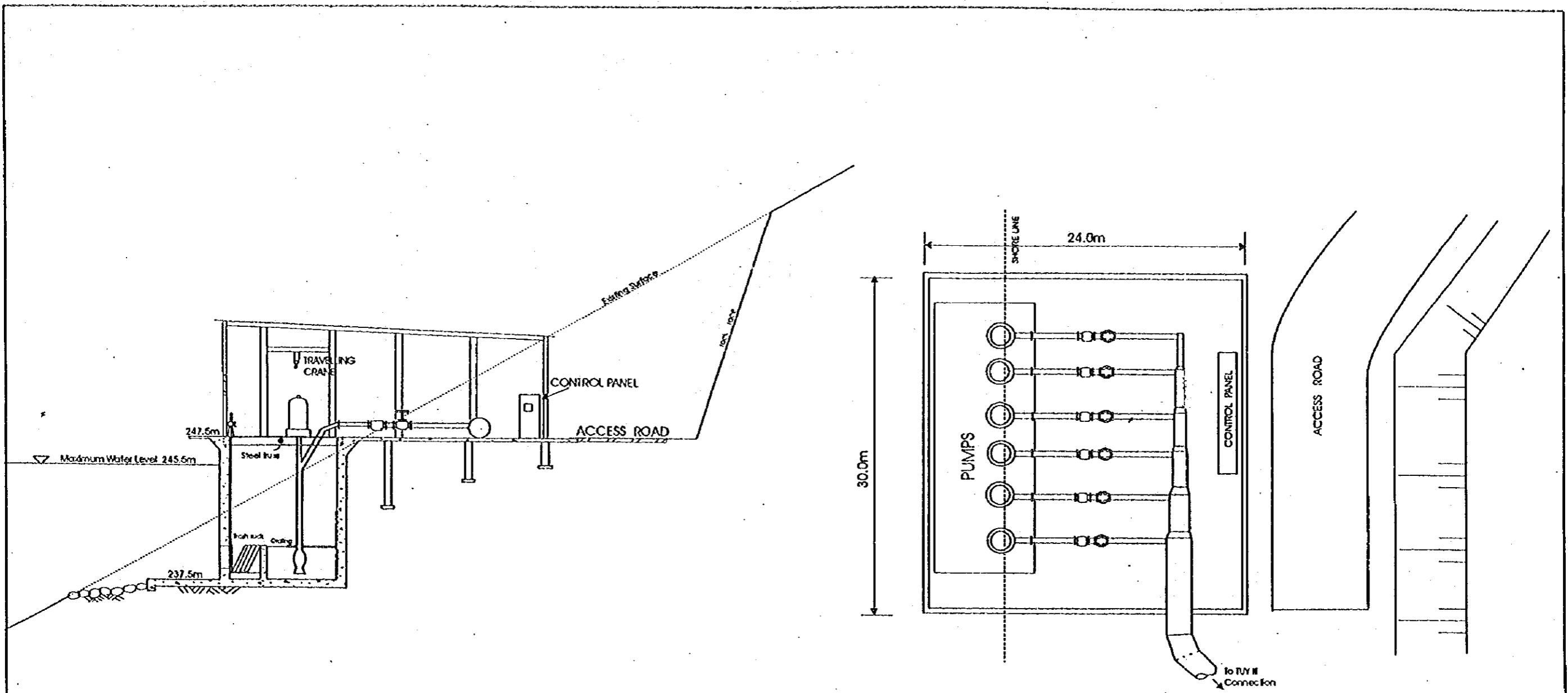

OCUMARITO RESERVOIR TUY III CONNECTION PUMPING STATION

THE STUDY ON
 THE ENVIRONMENTAL IMPROVEMENT PROGRAM OF THE UPPER AND MIDDLE
 STREAM OF THE TUY RIVER BASIN
 IN THE REPUBLIC OF VENEZUELA
 JAPAN INTERNATIONAL COOPERATION AGENCY

Fig. 10.3-4 Plano Estructural de la Estacion de Bombeo Ocumarito-Tuy III

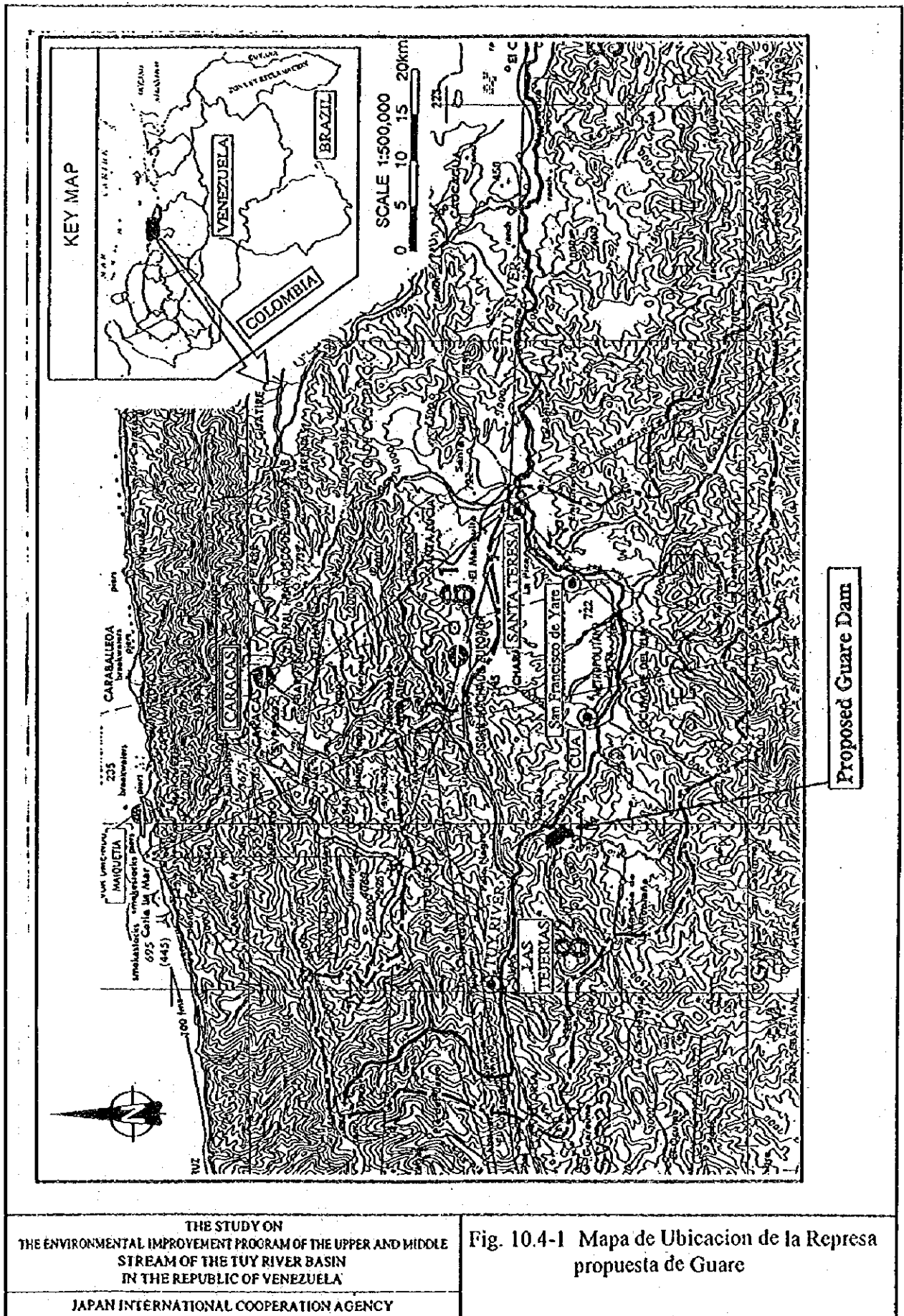

THE STUDY ON
 THE ENVIRONMENTAL IMPROVEMENT PROGRAM OF THE UPPER AND MIDDLE
 STREAM OF THE TUY RIVER BASIN
 IN THE REPUBLIC OF VENEZUELA

Fig. 10.4-1 Mapa de Ubicacion de la Represa
 propuesta de Guare

JAPAN INTERNATIONAL COOPERATION AGENCY

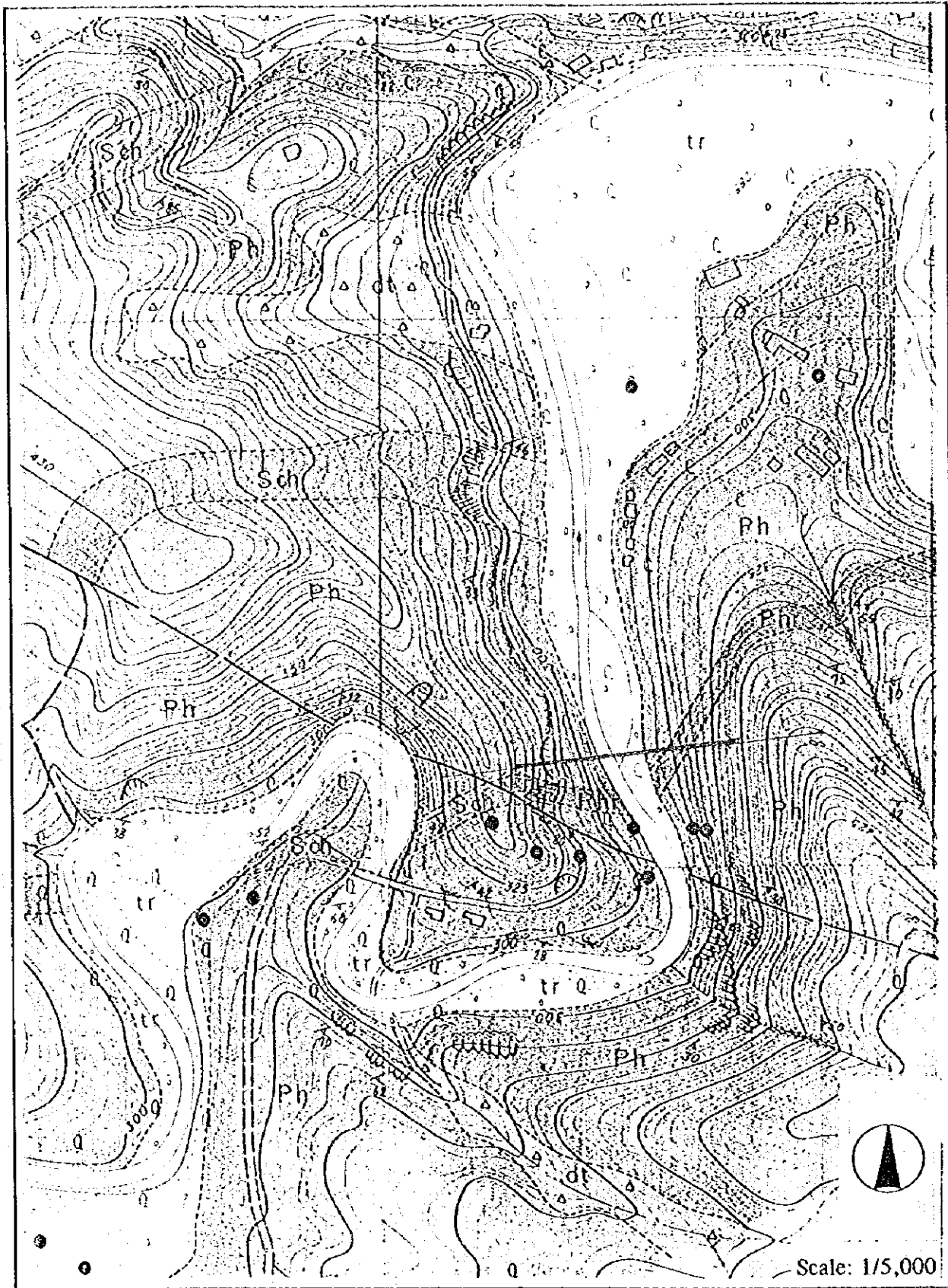

Scale: 1/5,000

THE STUDY ON
 THE ENVIRONMENTAL IMPROVEMENT PROGRAM OF THE UPPER AND MIDDLE
 STREAM OF THE TUY RIVER BASIN
 IN THE REPUBLIC OF VENEZUELA
 JAPAN INTERNATIONAL COOPERATION AGENCY

Fig. 10.4-2 Mapa Geologico del Sitio para la
 (1/2) Represa propuesta de Guare

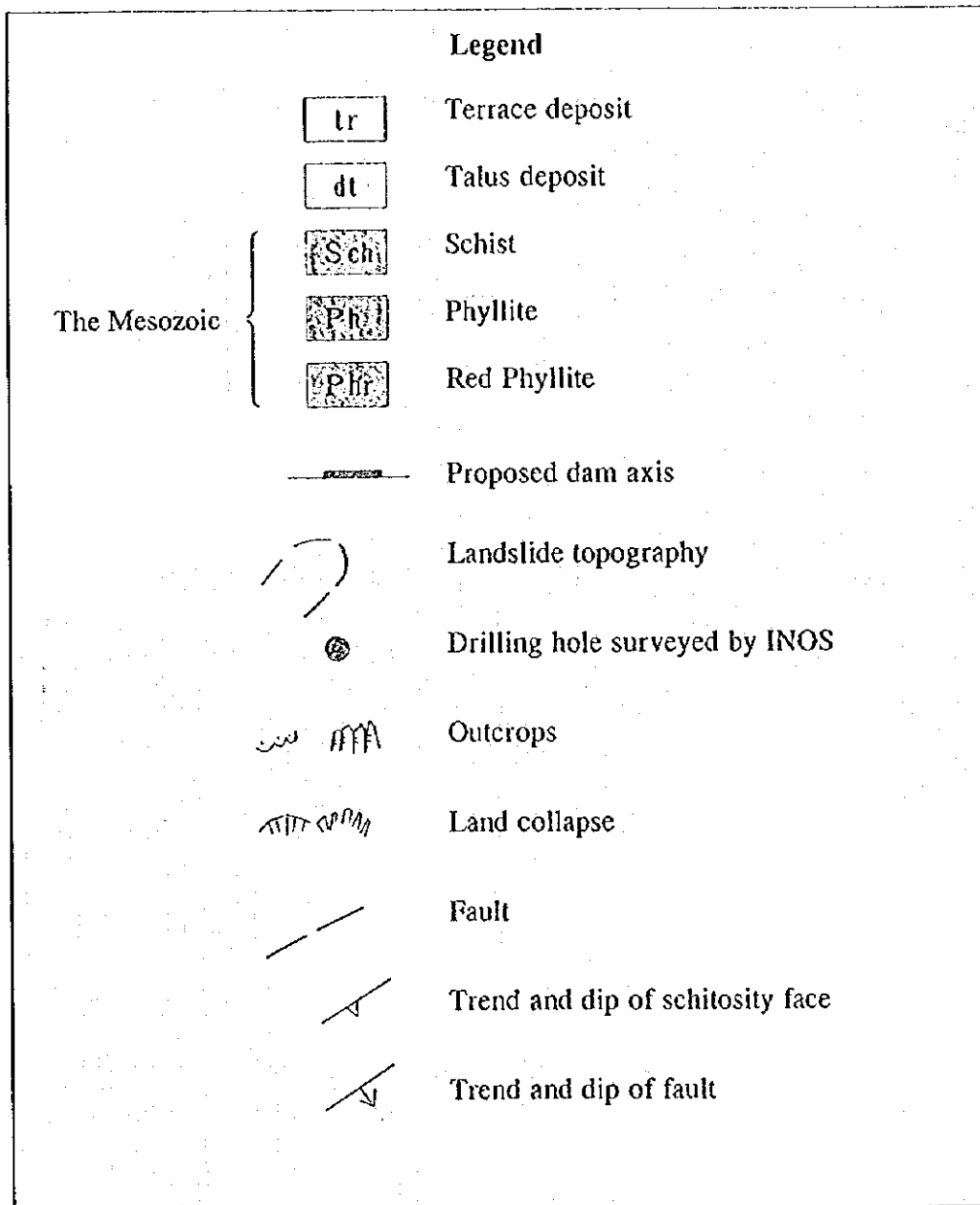

THE STUDY ON
 THE ENVIRONMENTAL IMPROVEMENT PROGRAM OF THE UPPER AND MIDDLE
 STREAM OF THE TUY RIVER BASIN
 IN THE REPUBLIC OF VENEZUELA

JAPAN INTERNATIONAL COOPERATION AGENCY

Fig. 10.4-2 Mapa Geologico del Sitio para la
 (2/2) Represa propuesta de Guare

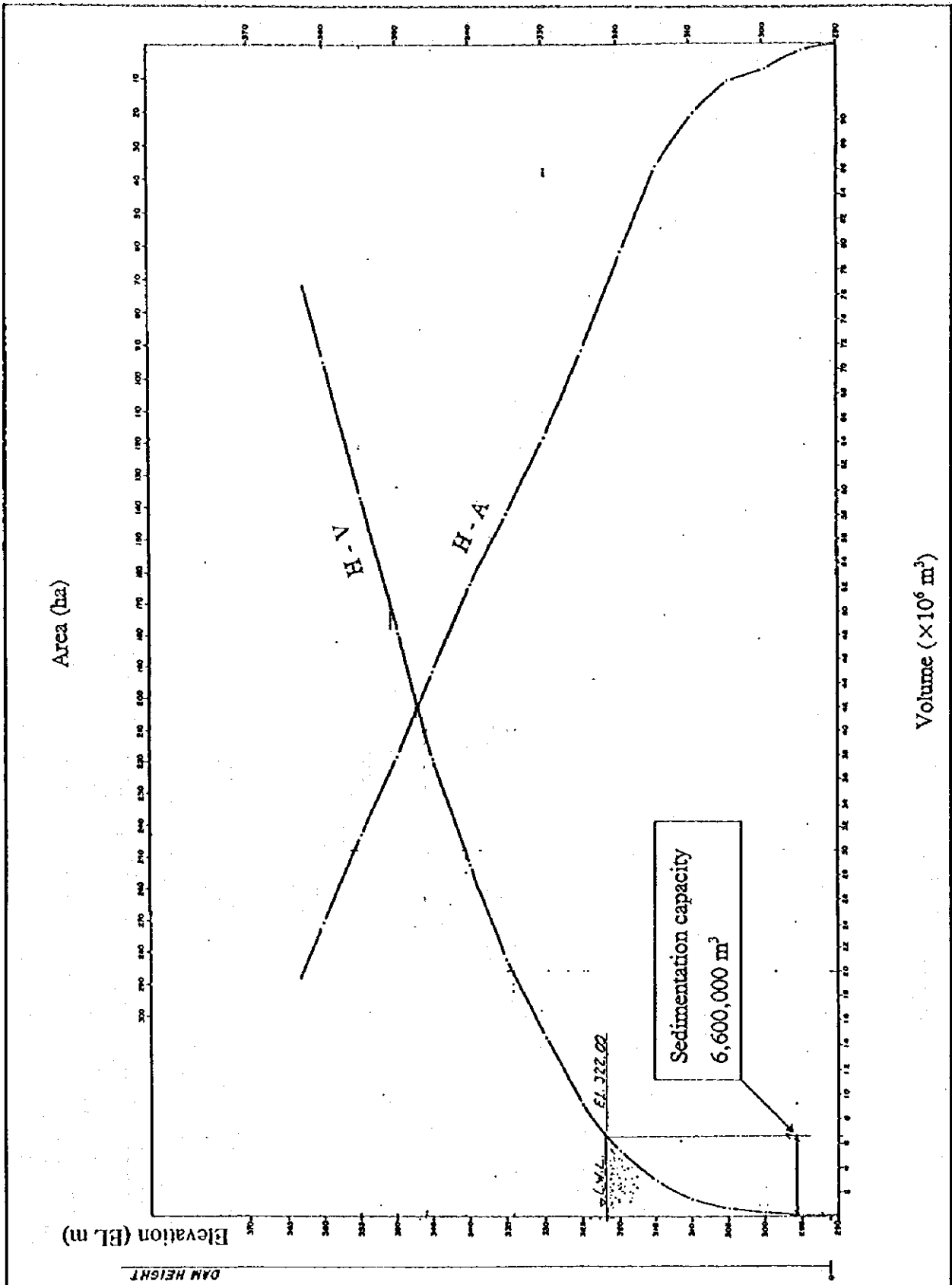

Sedimentation capacity
6,600,000 m³

THE STUDY ON
THE ENVIRONMENTAL IMPROVEMENT PROGRAM OF THE UPPER AND MIDDLE
STREAM OF THE TUY RIVER BASIN
IN THE REPUBLIC OF VENEZUELA
JAPAN INTERNATIONAL COOPERATION AGENCY

Fig. 10.4-3 Curva H-A-V de la Represa' propuesta de Guare

