

SINRUJALA RIVER
NO 00-01

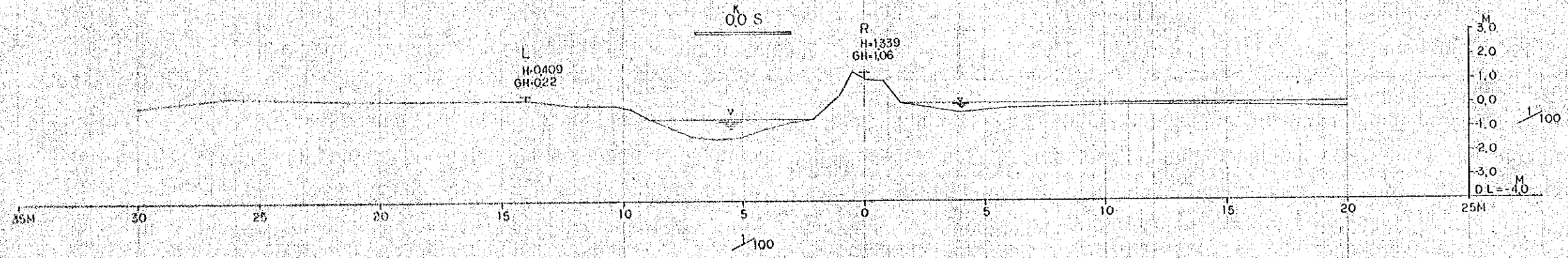

SINRIJALA RIVER

NO 02-06

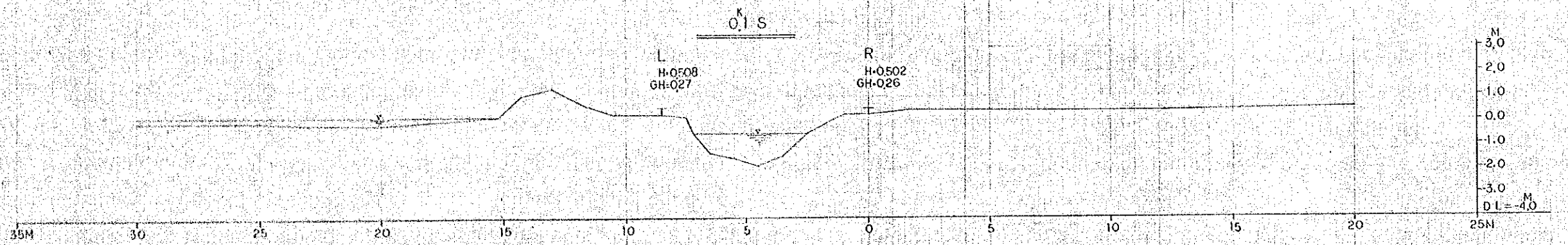
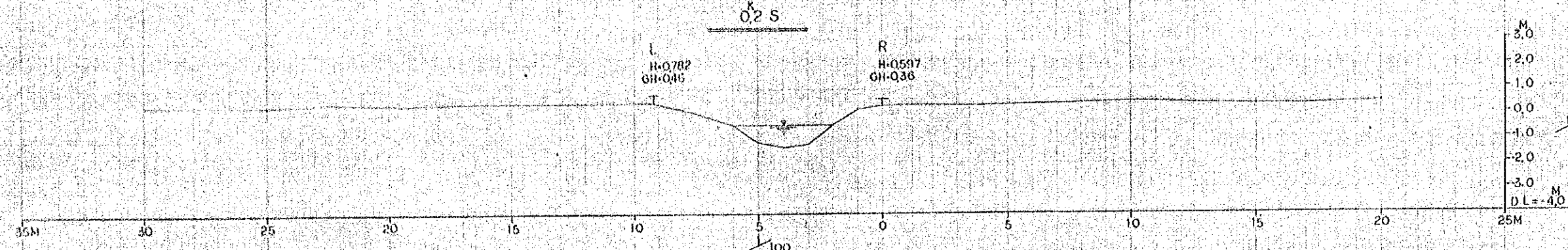
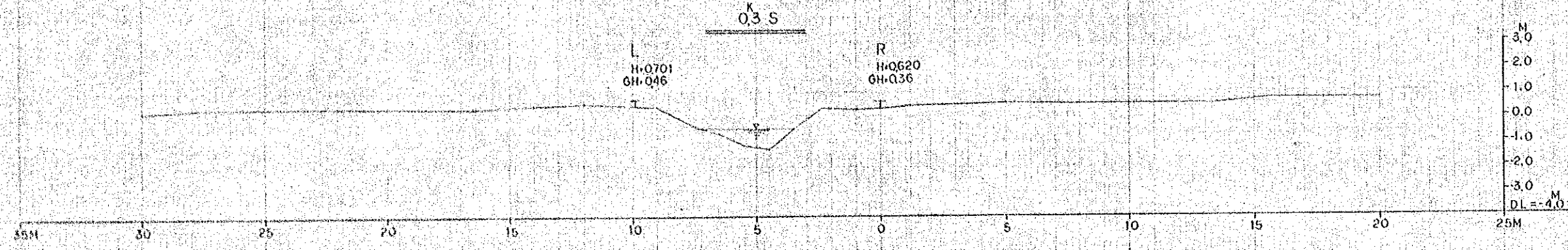
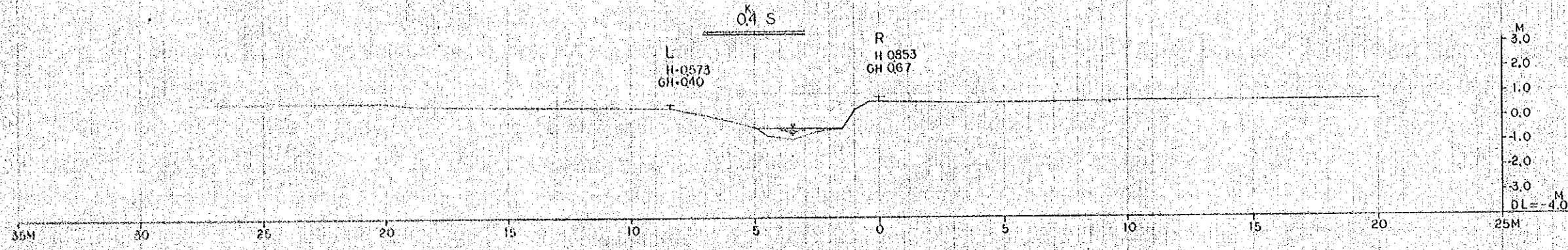
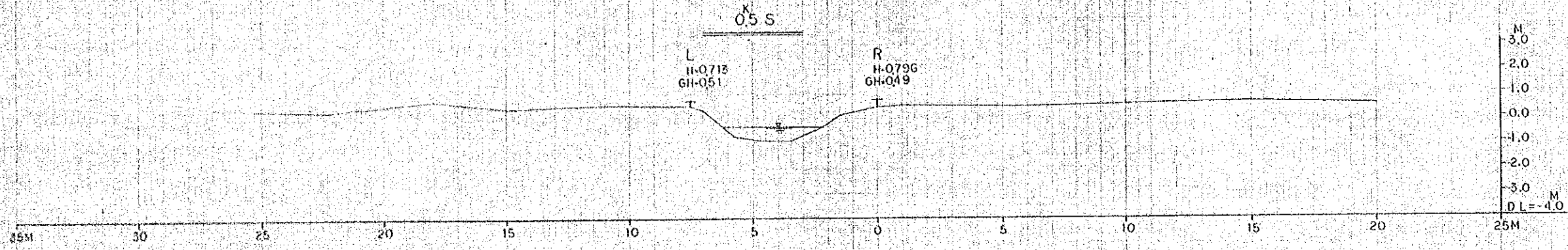
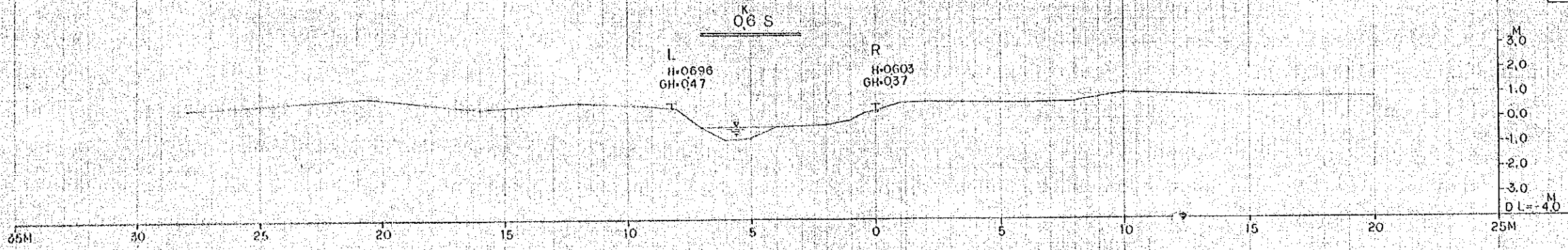

SINRIJALA RIVER

NO 07-1.1

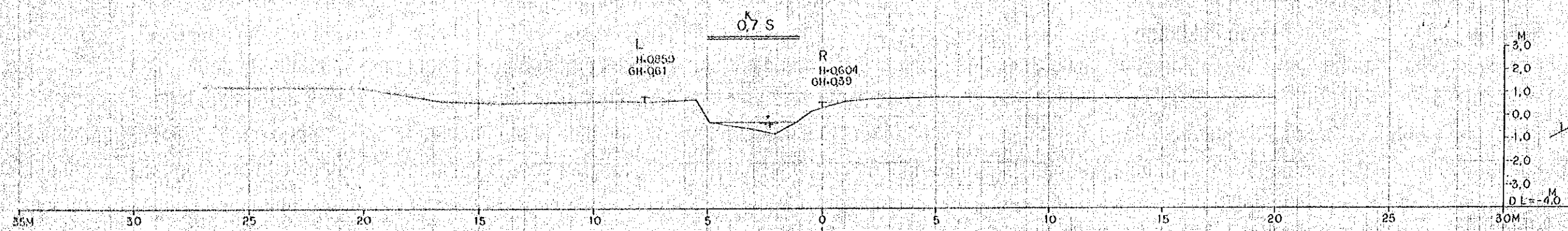
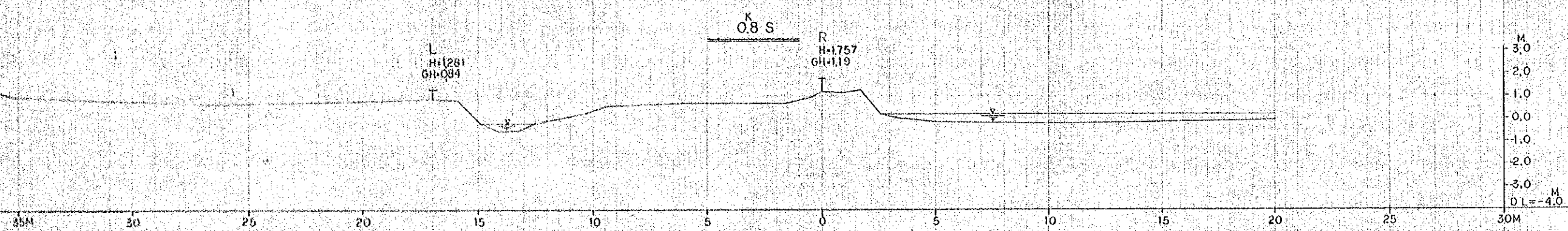
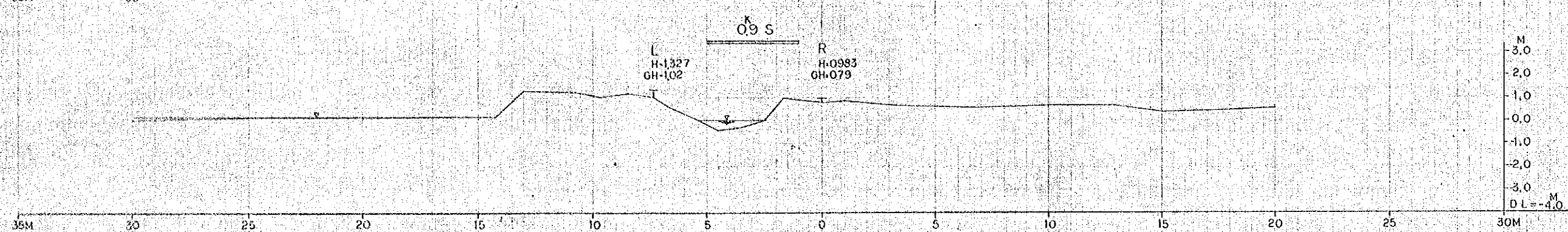
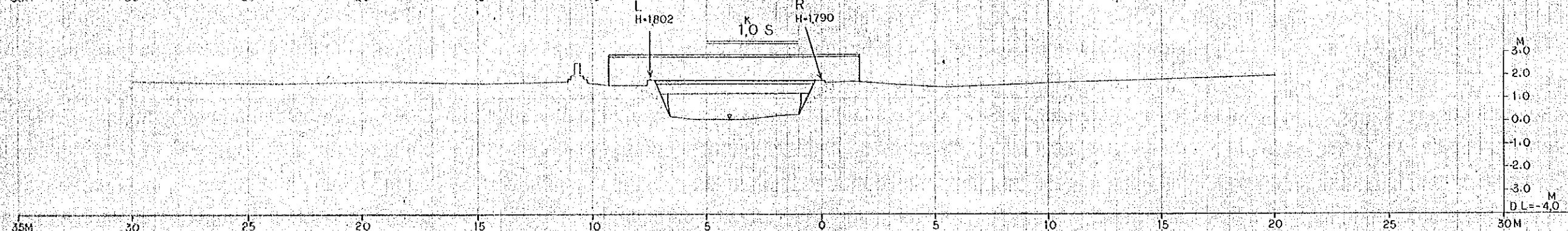
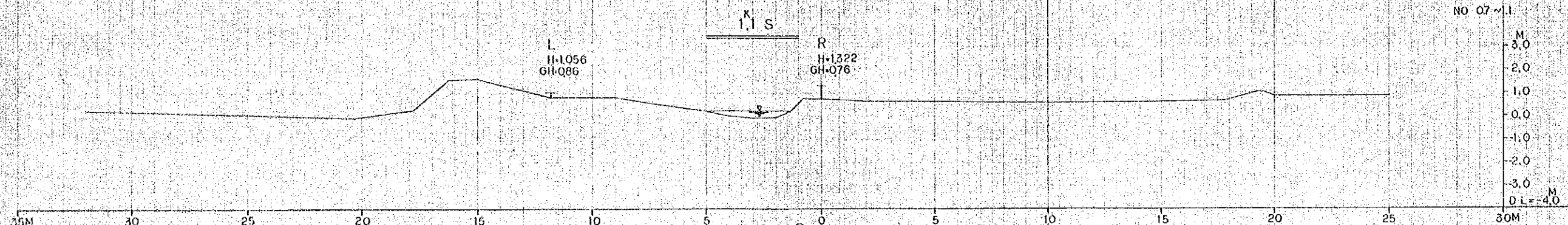

SINRUJALA RIVER

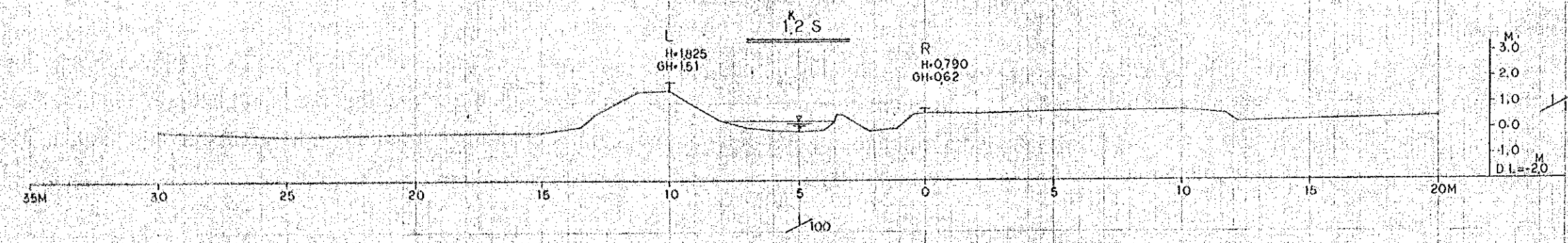
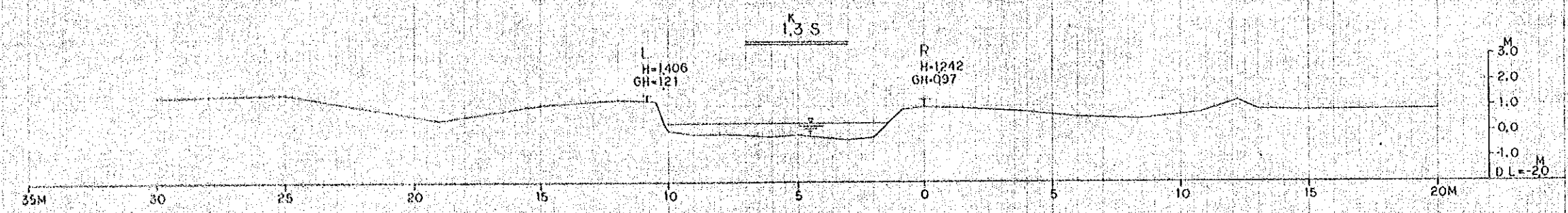
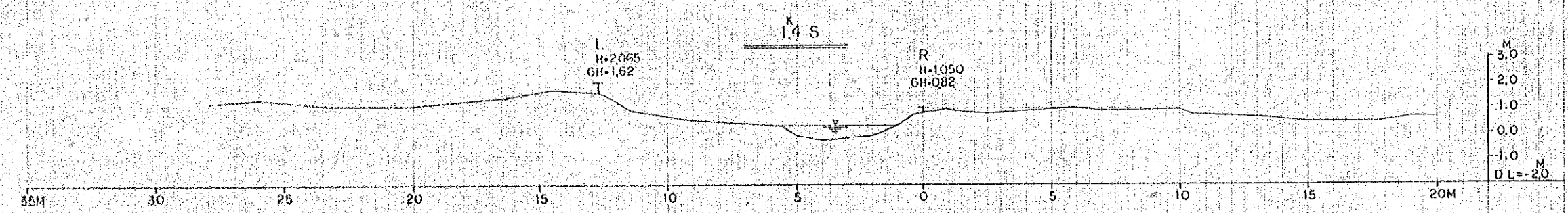
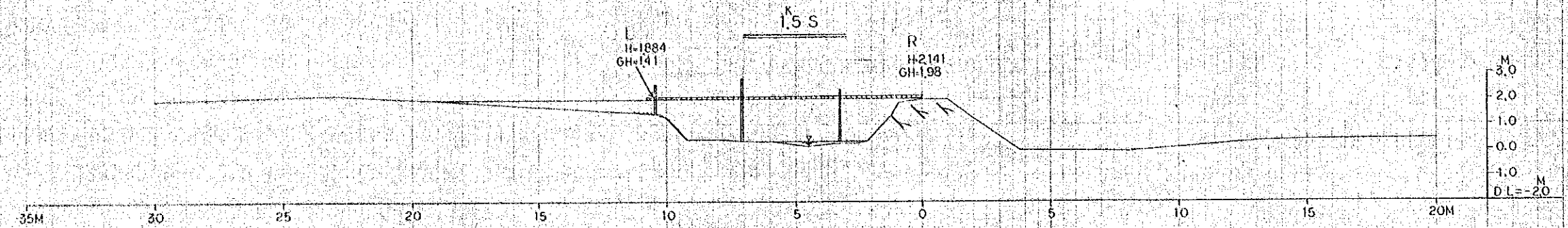
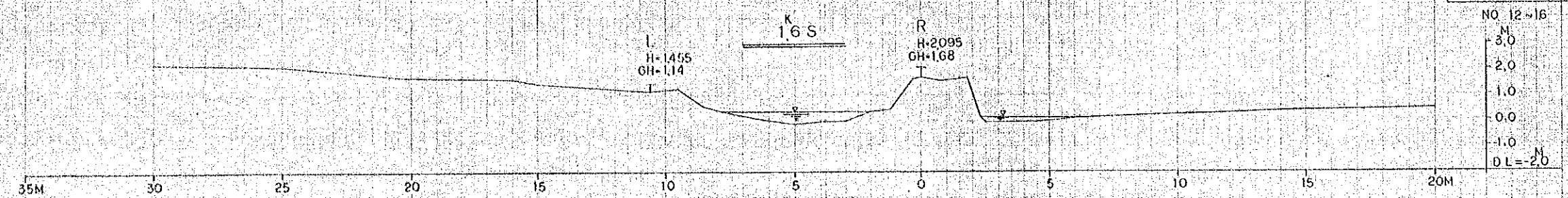

SINRIJALA RIVER

NO 17-21

M
3.0
2.0
1.0
0.0
-1.0
-2.0
DL = -2.0

M
3.0
2.0
1.0
0.0
-1.0
-2.0
DL = -2.0

M
3.0
2.0
1.0
0.0
-1.0
-2.0
DL = -2.0

M
3.0
2.0
1.0
0.0
-1.0
-2.0
DL = -2.0

M
3.0
2.0
1.0
0.0
-1.0
-2.0
DL = -2.0

K
2.1 S

L
H=1.029
GH=086

R
H=1.311
GH=109

K
2.0 S

L
H=1.288
GH=106

R
H=1.093
GH=082

K
1.9 S

L
H=1.812
GH=140

R
H=0.943
GH=076

K
1.8 S

L
H=1.151
GH=182

R
H=0.981
GH=077

K
1.7 S

L
H=2.550
GH=222

R
H=2.150

1/100

1/100

SINRIJALA RIVER
NO 22-26

