

PLAN
SCALE A

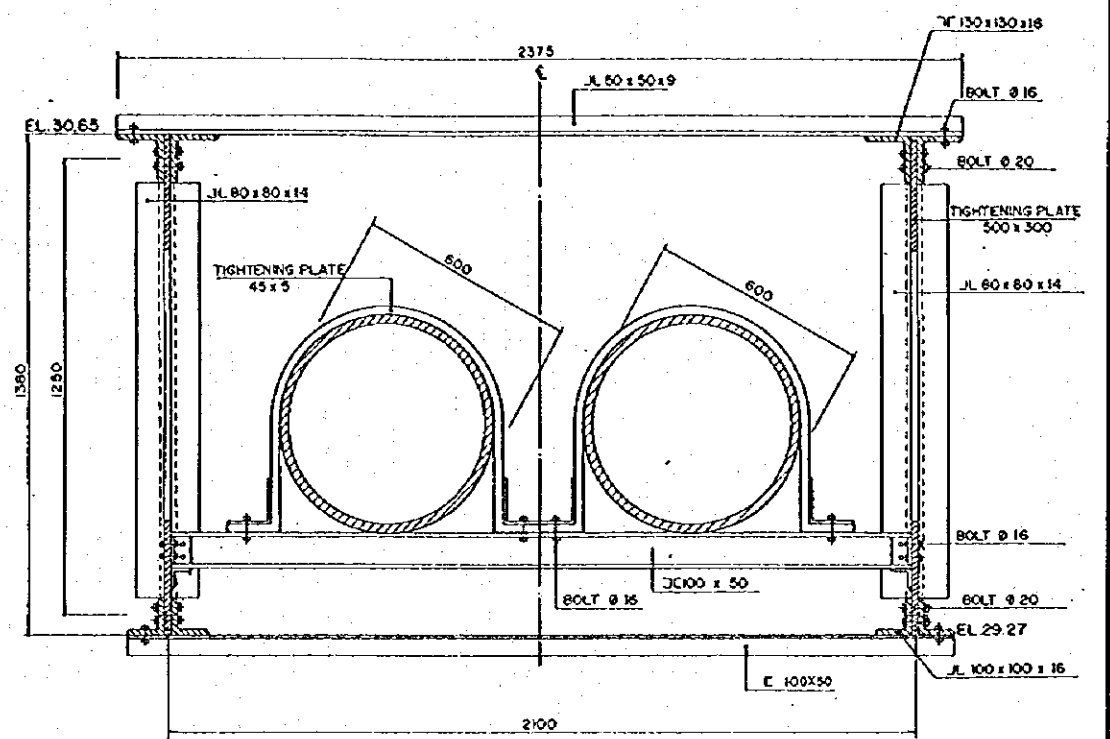

SECTION B-B
SCALE C

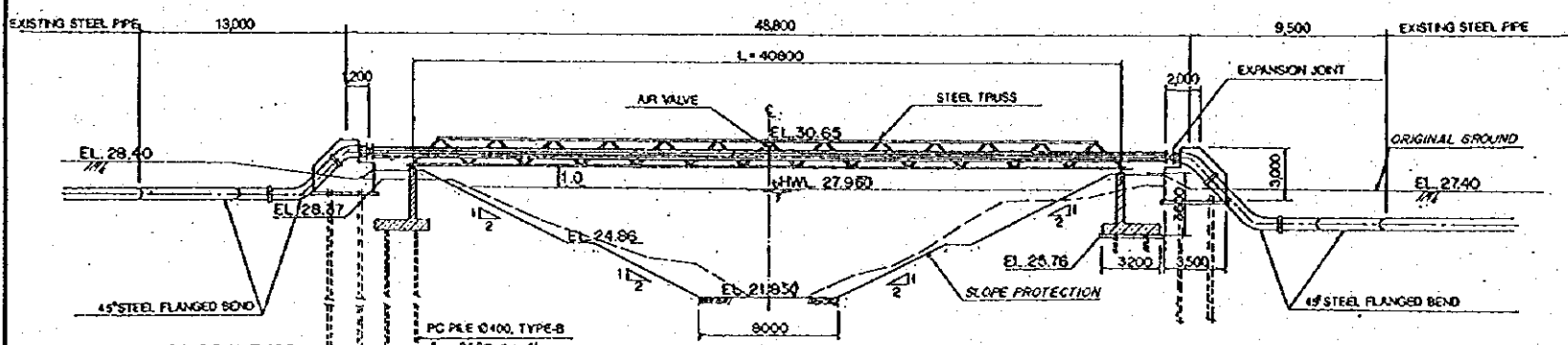

SECTION A-A
SCALE A

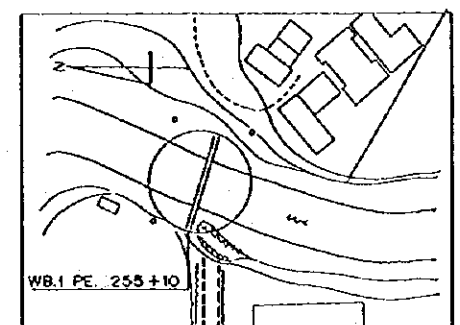

KEY PLAN
NOT TO SCALE

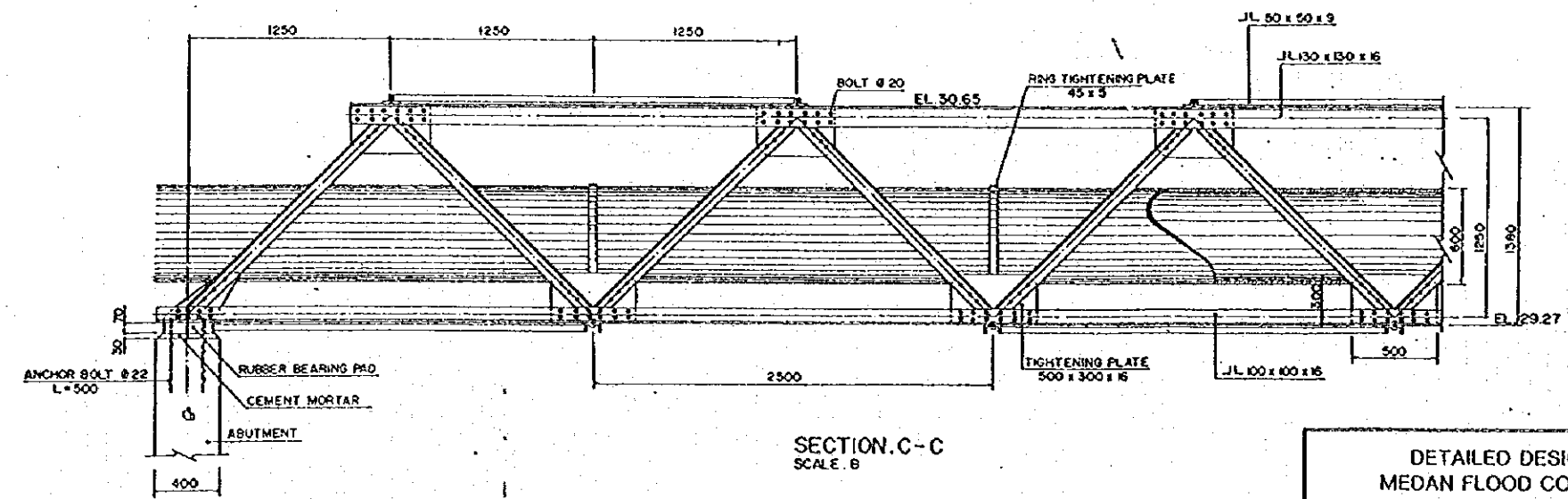
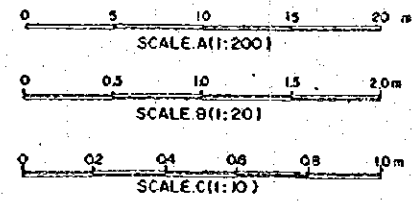

SECTION C-C
SCALE B

<p>DETAILED DESIGN STUDY ON MEDAN FLOOD CONTROL PROJECT</p> <p>JAPAN INTERNATIONAL COOPERATION AGENCY</p>	<p>DWG. 4.35 GENERAL PLAN OF WATER PIPE BRIDGE (WB 1)</p>
---	---

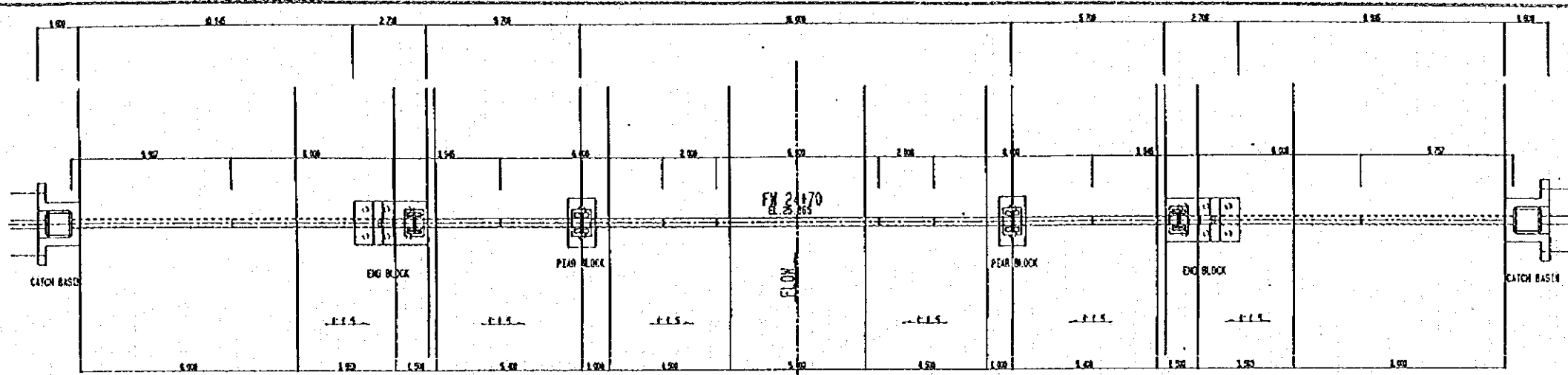

PLAN
SCALE 1

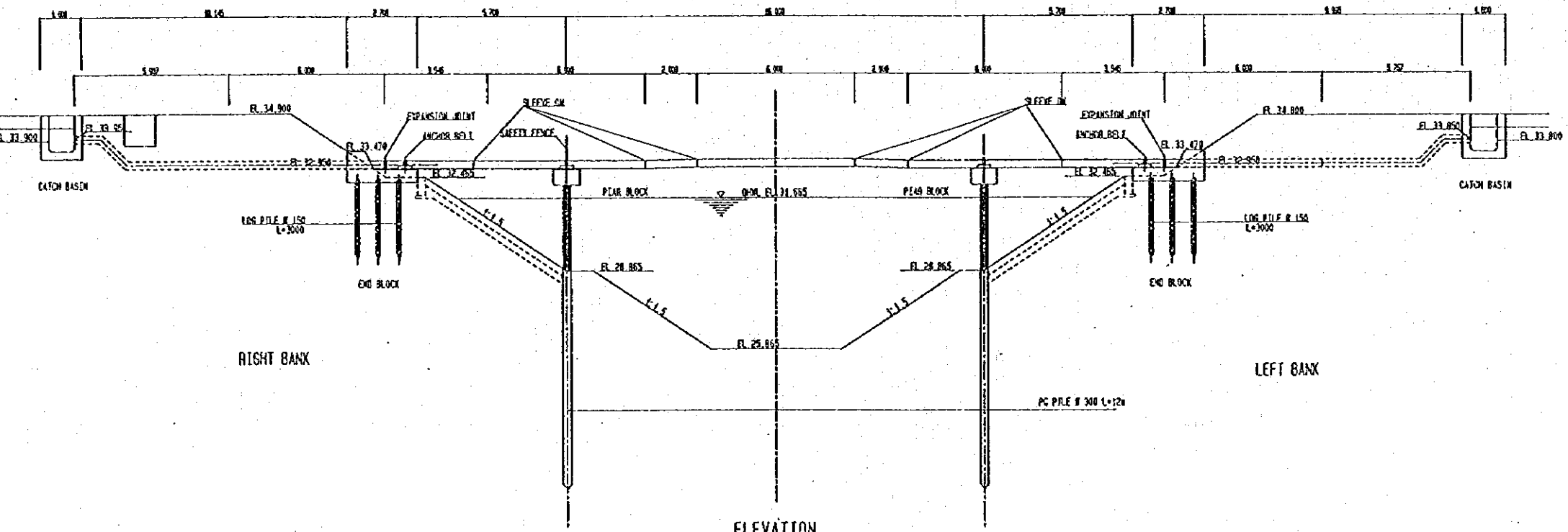

ELEVATION
SCALE 1

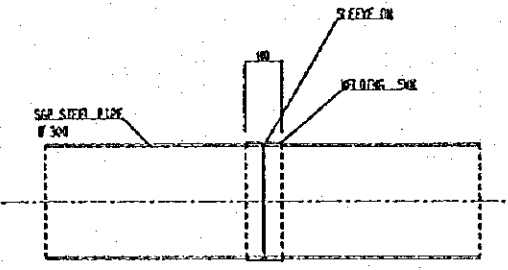

DETAIL OF SLEEVE ON
SCALE B

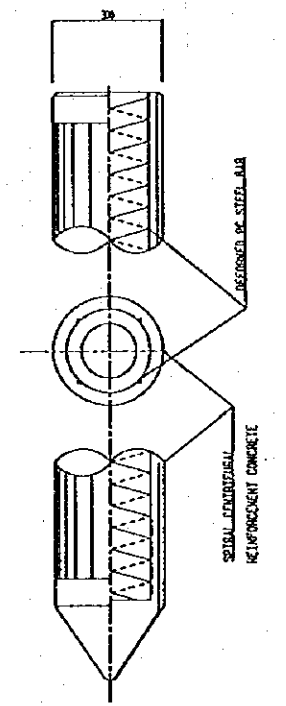

DETAIL OF PILE
SCALE C

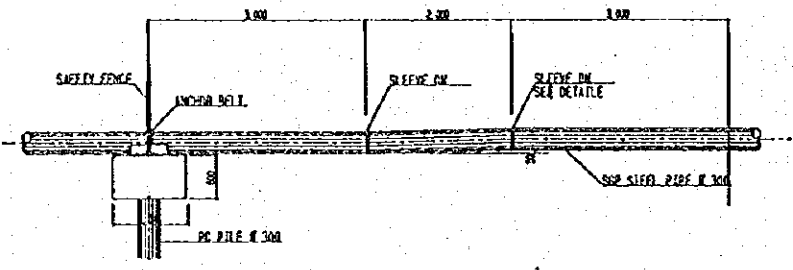

DETAIL OF PIPE JOINT
SCALE A

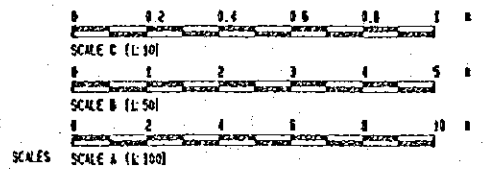

DETAILED DESIGN STUDY ON
MEDAN FLOOD CONTROL PROJECT
JAPAN INTERNATIONAL COOPERATION AGENCY

DWG. 4.36
GENERAL PLAN OF WATER PIPE BRIDGE
FOR IRRIGATION (WB 3)

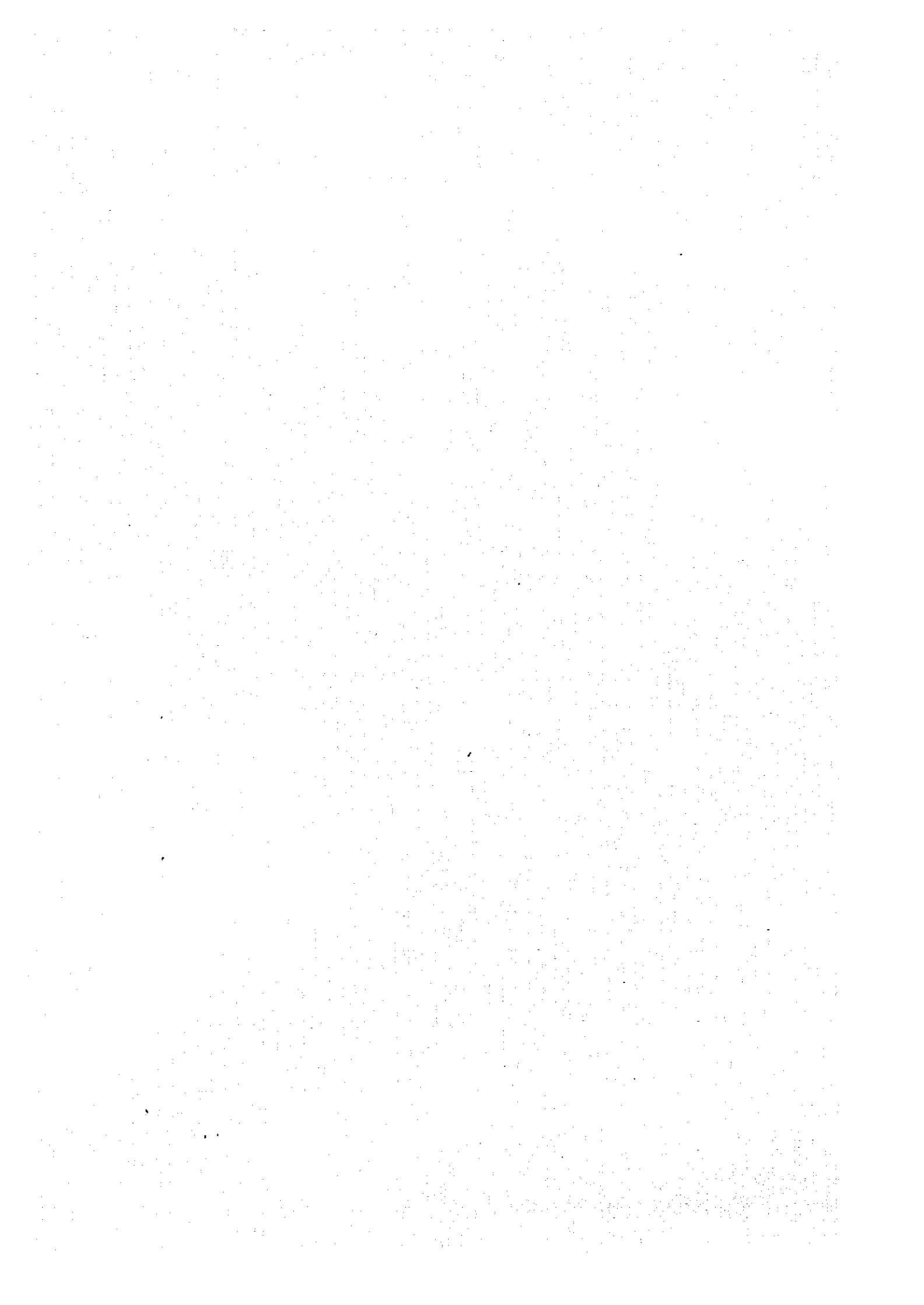



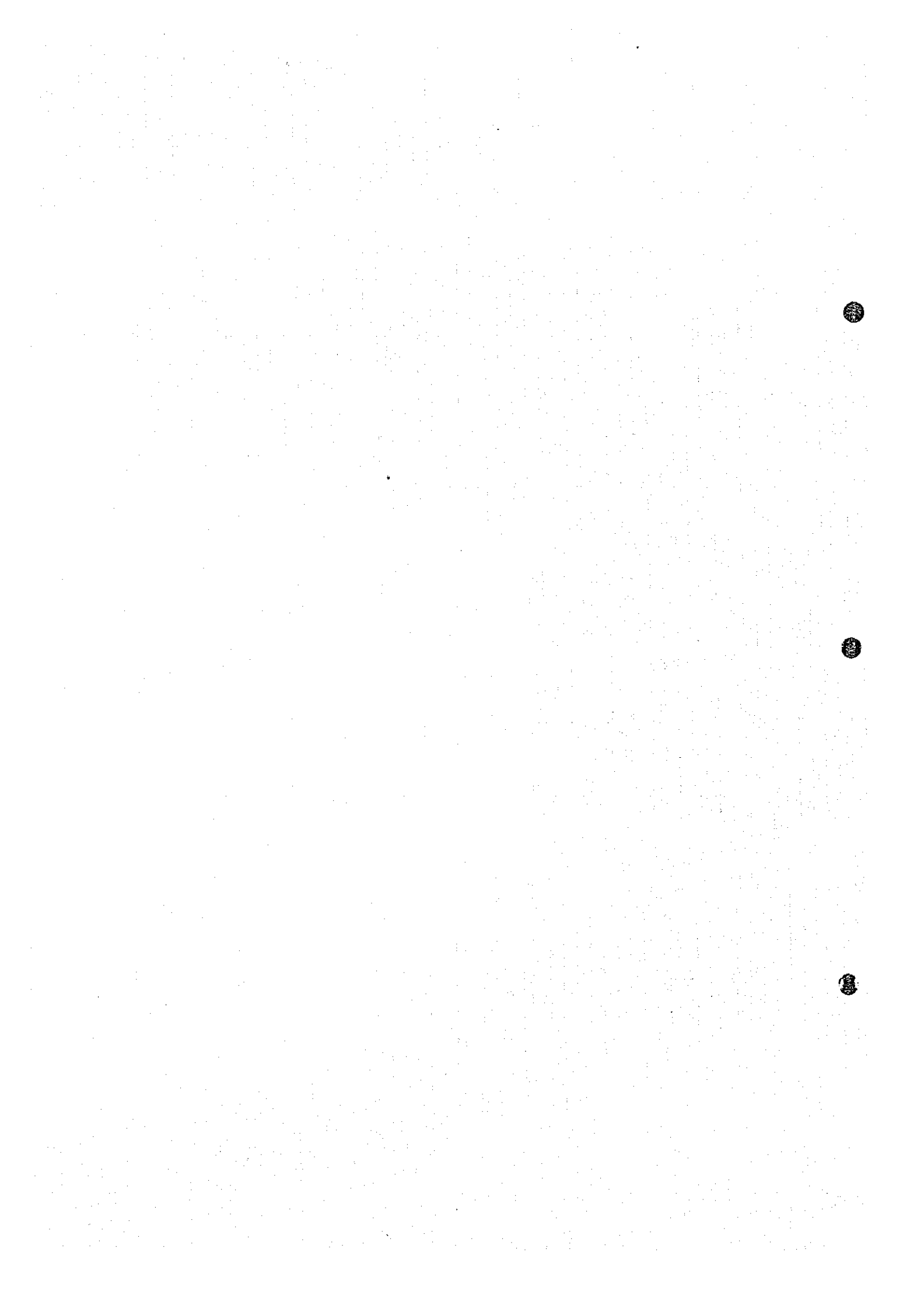

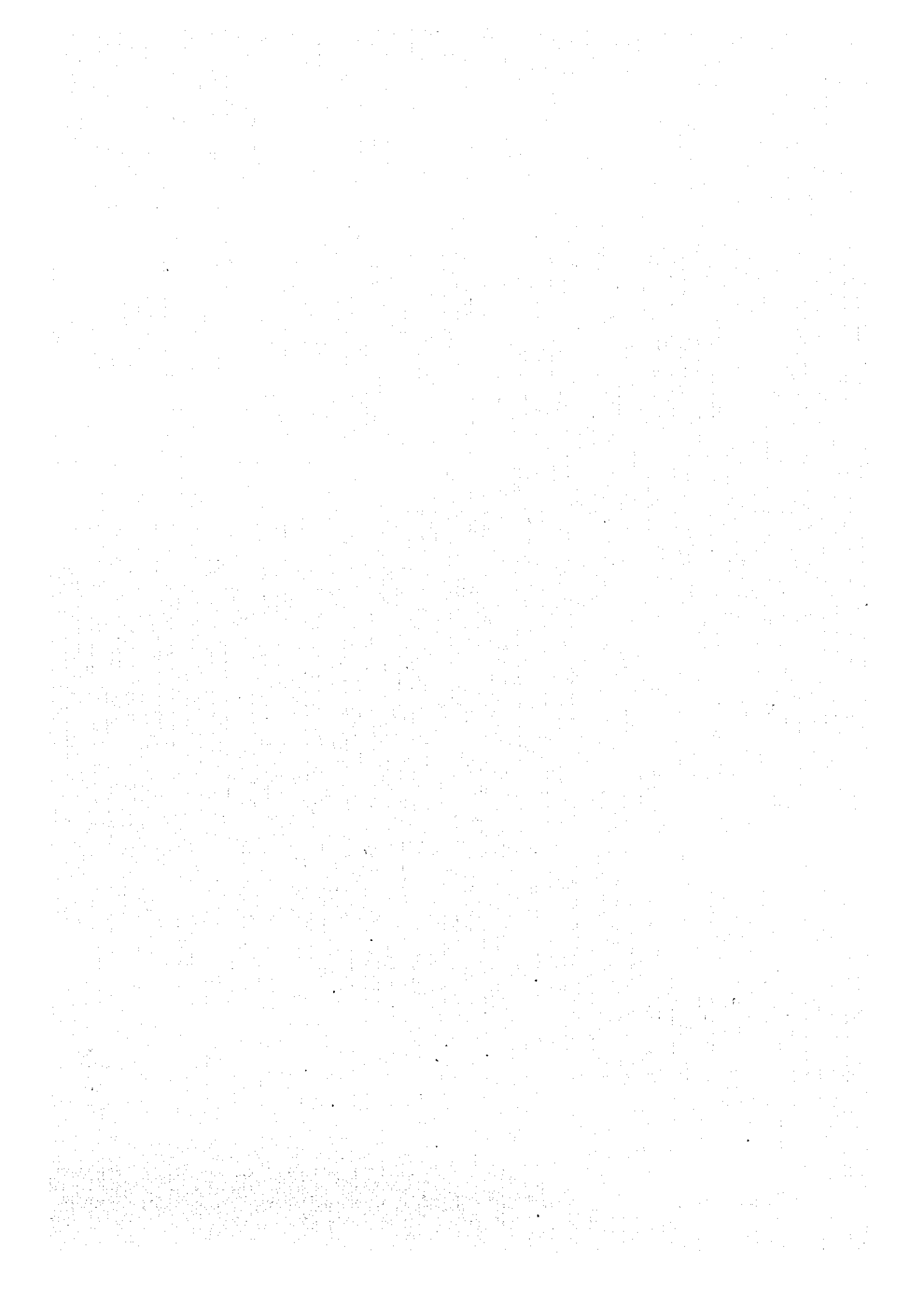

JICA