

鋼桁拱与对象橋梁一般図

Br. No. 4 Dong Vuong Bridge (General View of the Bridge)

PROFILE
SCALE = 1/200

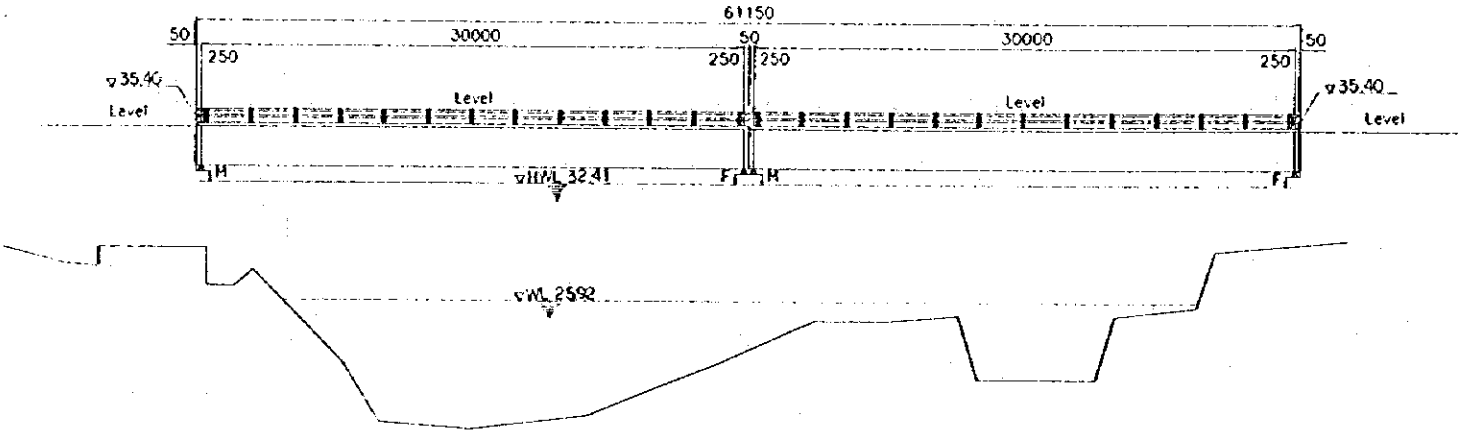

SECTION
SCALE = 1/100

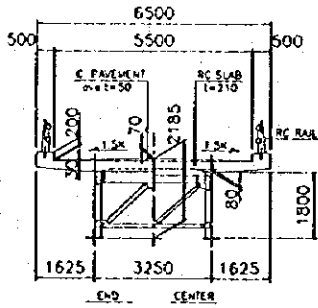

PLAN
SCALE = 1/200

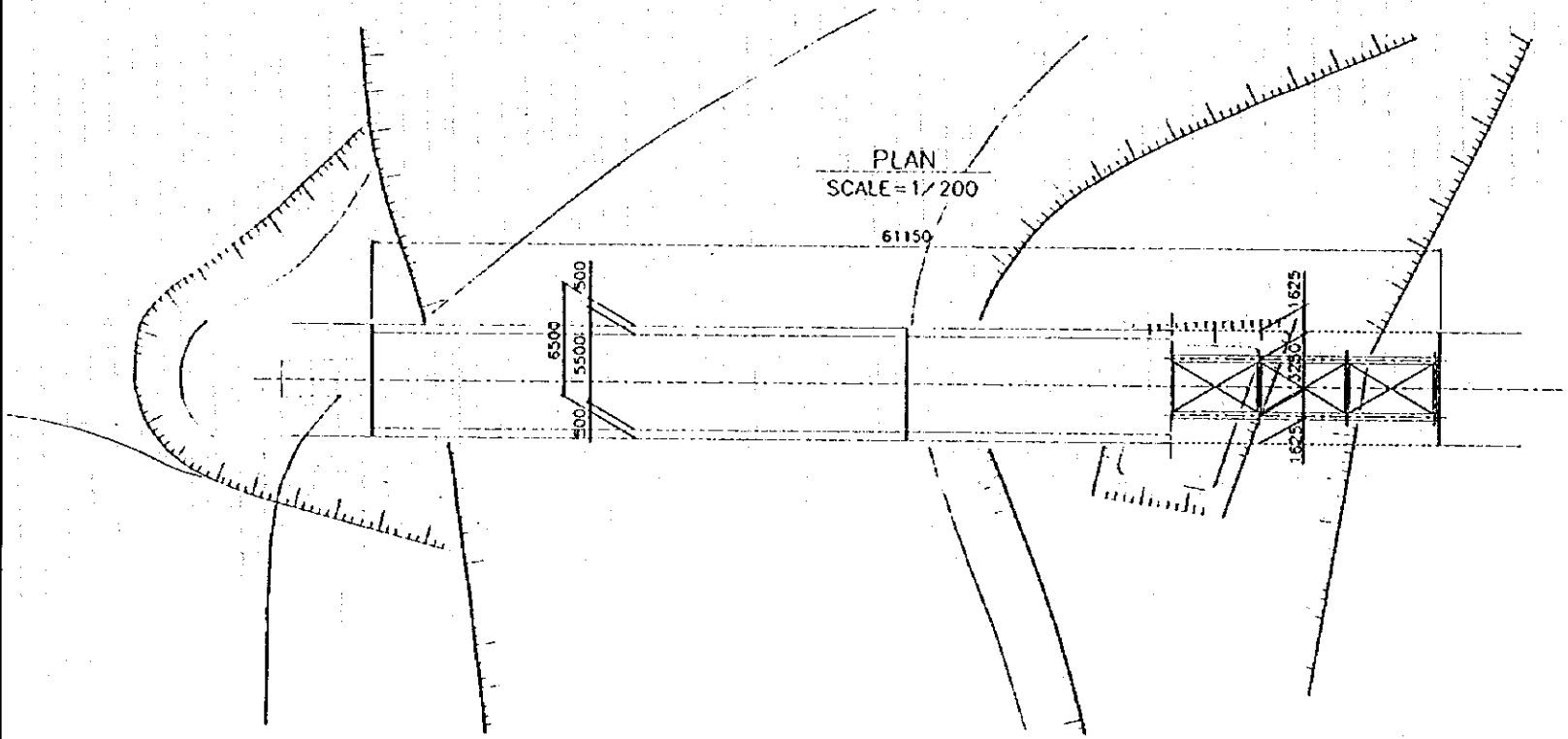

43

43

Br. No. 10 Tinh Bridge
(General View of the Bridge)

PROFILE
SCALE = 1/200

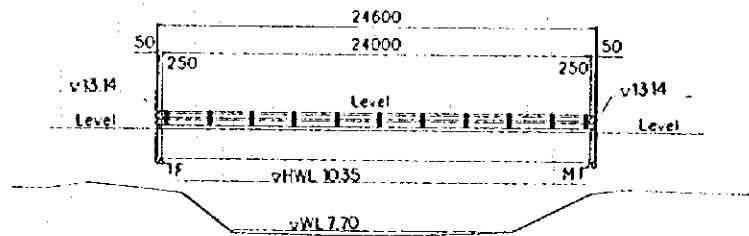

SECTION
SCALE = 1/100

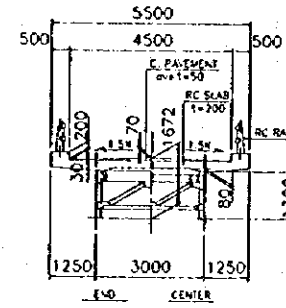

PLAN
SCALE = 1/200

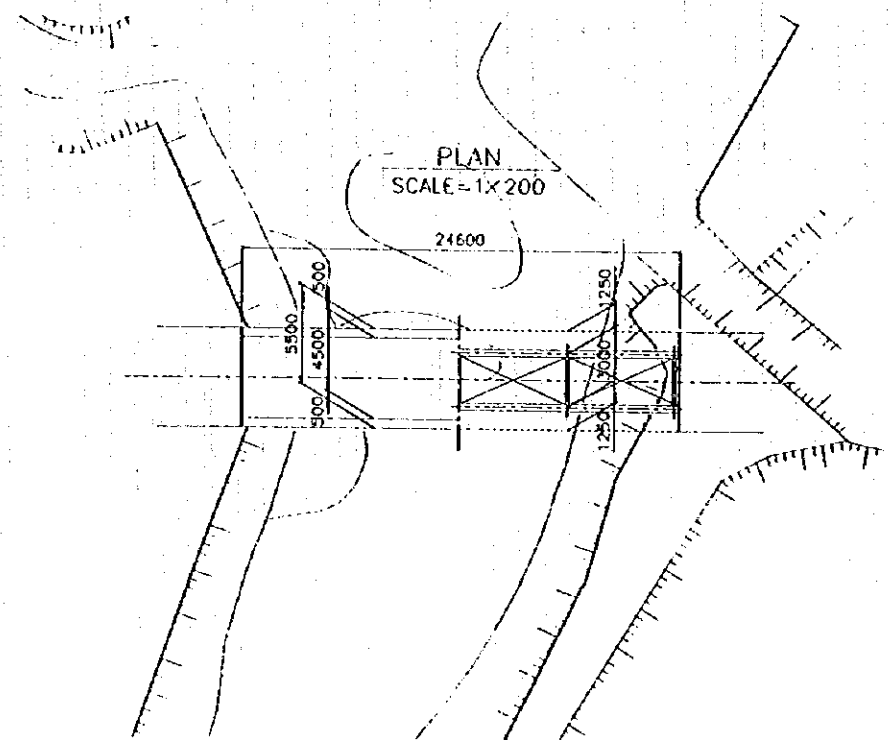

Br. No. 25 Lanh Bridge
(General View of the Bridge)

PROFILE
SCALE = 1/200

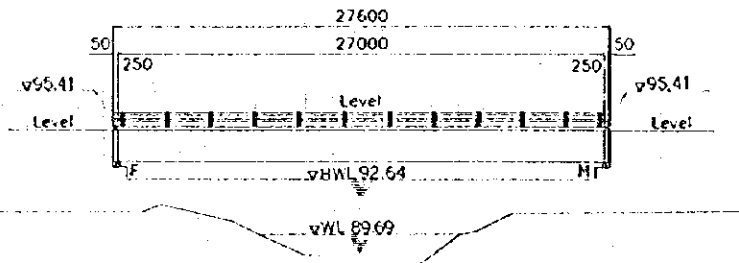

SECTION
SCALE = 1/100

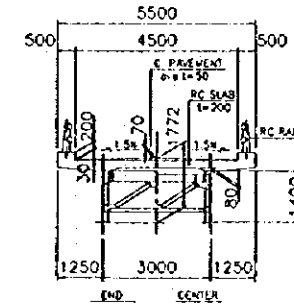

PLAN
SCALE = 1/200

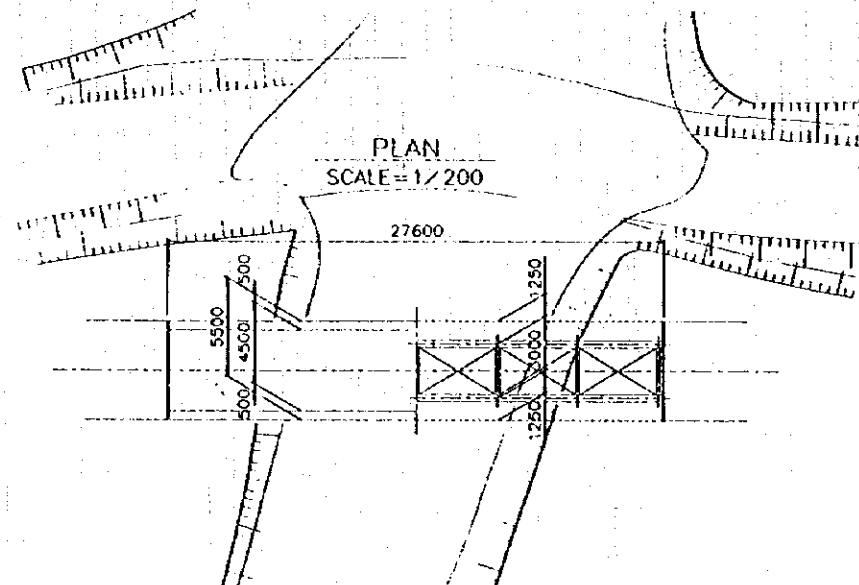

Br. No. 26 Vai Bridge
(General View of the Bridge)

PROFILE
SCALE = 1/200

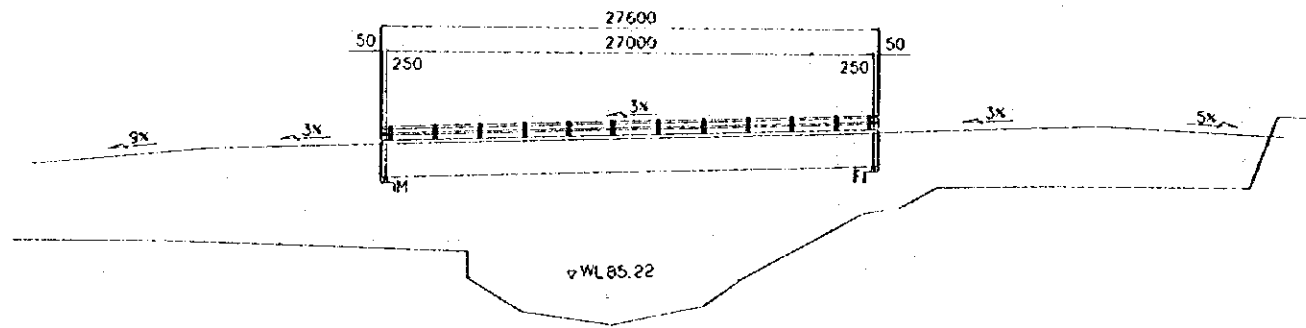

SECTION
SCALE = 1/100

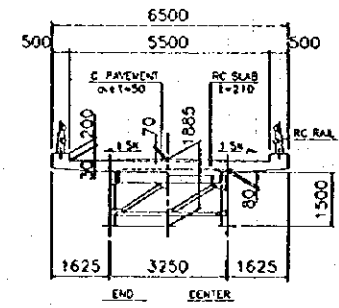

PLAN
SCALE = 1/200

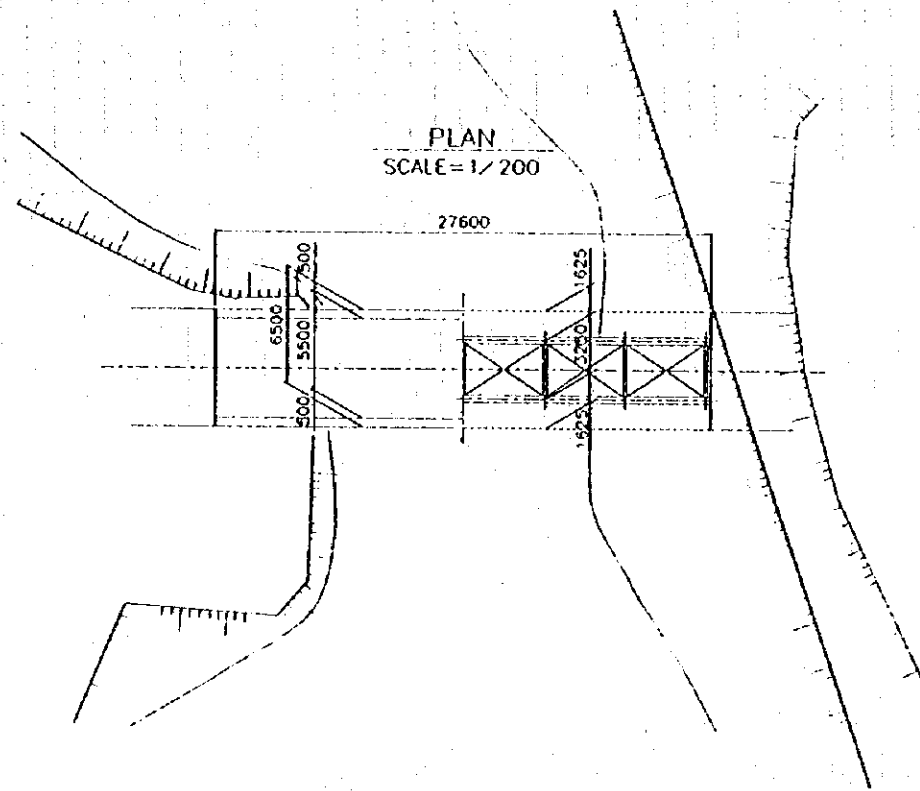

6/7

47

Br. No. 29 Ban Ai Bridge
(General View of the Bridge)

PROFILE
SCALE = 1/200

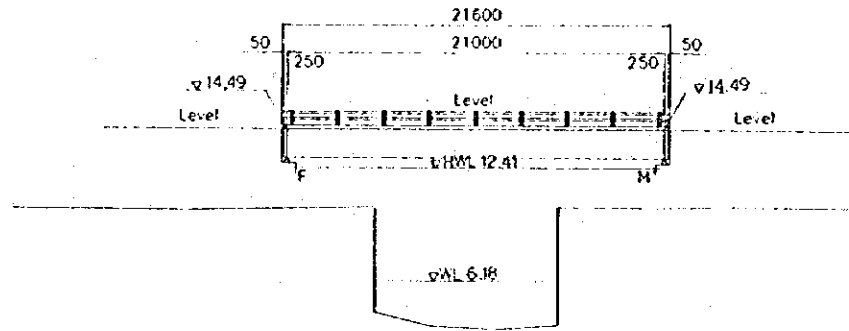

SECTION
SCALE = 1/100

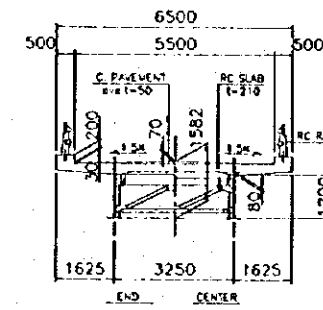

PLAN
SCALE = 1/200

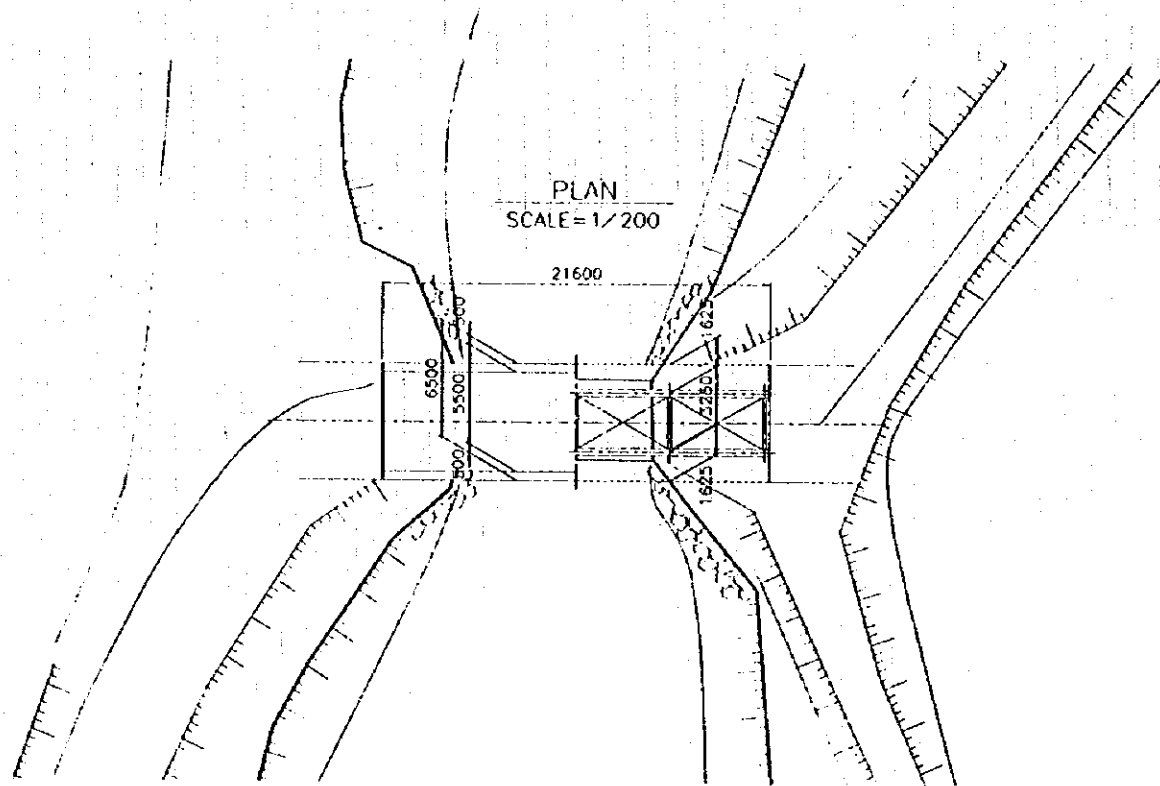

Br. No. 30 Ban Hinh Bridge (General View of the Bridge)

PROFILE
SCALE = 1/200

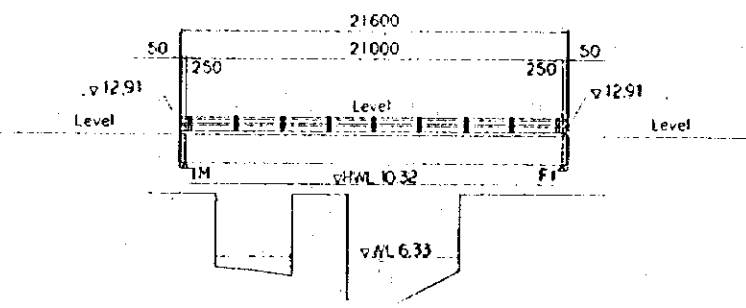

SECTION
SCALE = 1/100

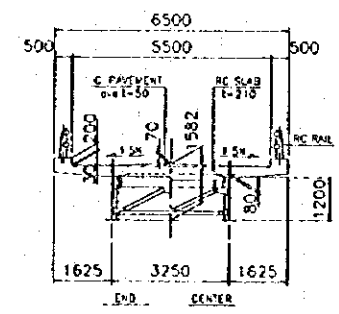

PLAN
SCALE = 1/200

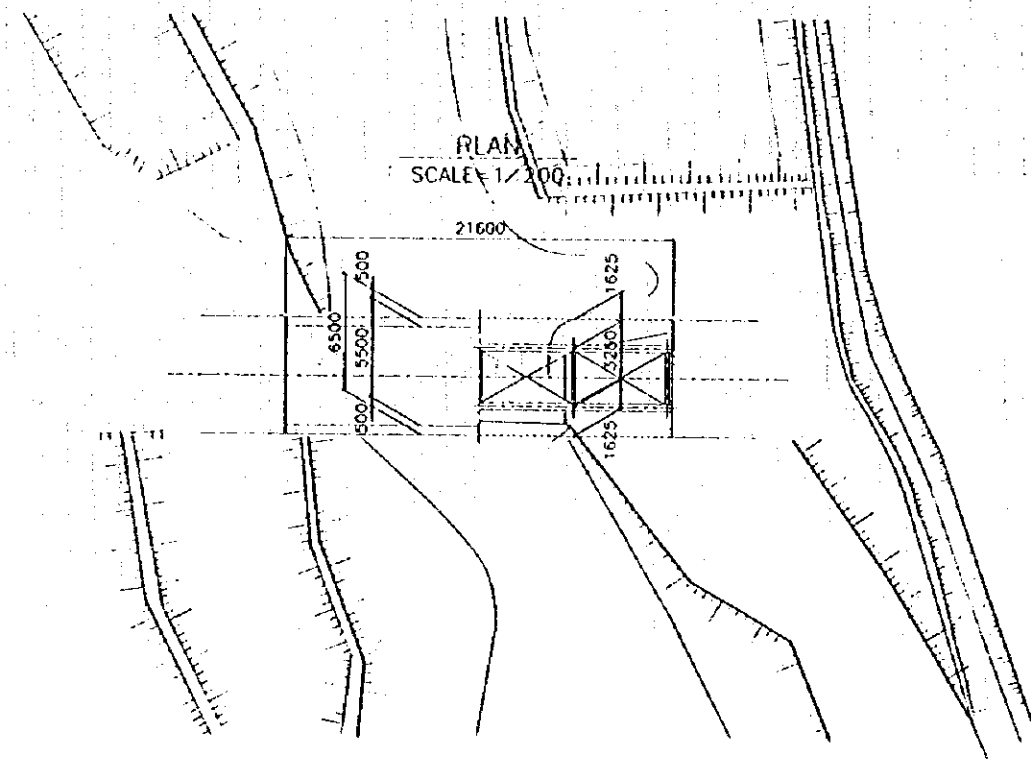

Br. No. 35 Ban Vuoc Bridge
(General View of the Bridge)

PROFILE
SCALE = 1/200

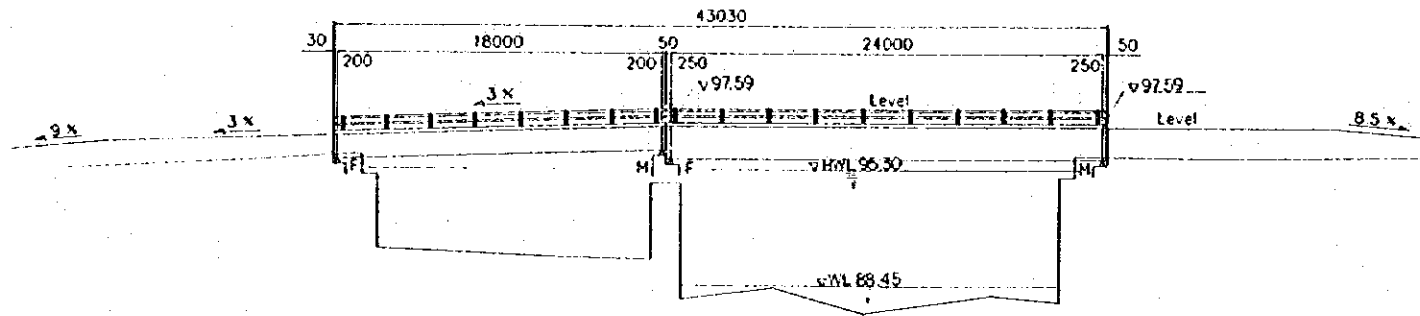

SECTION
SCALE = 1/100

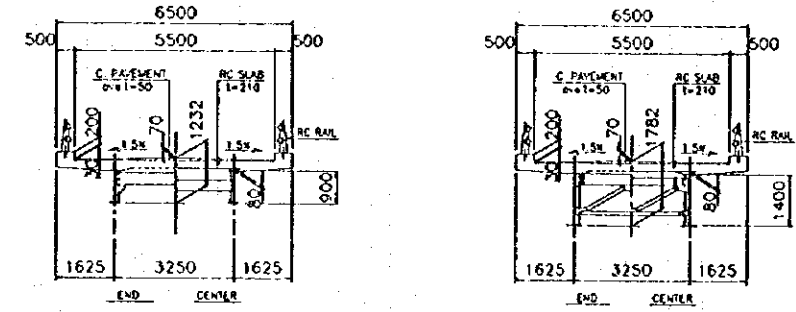

PLAN
SCALE = 1/200

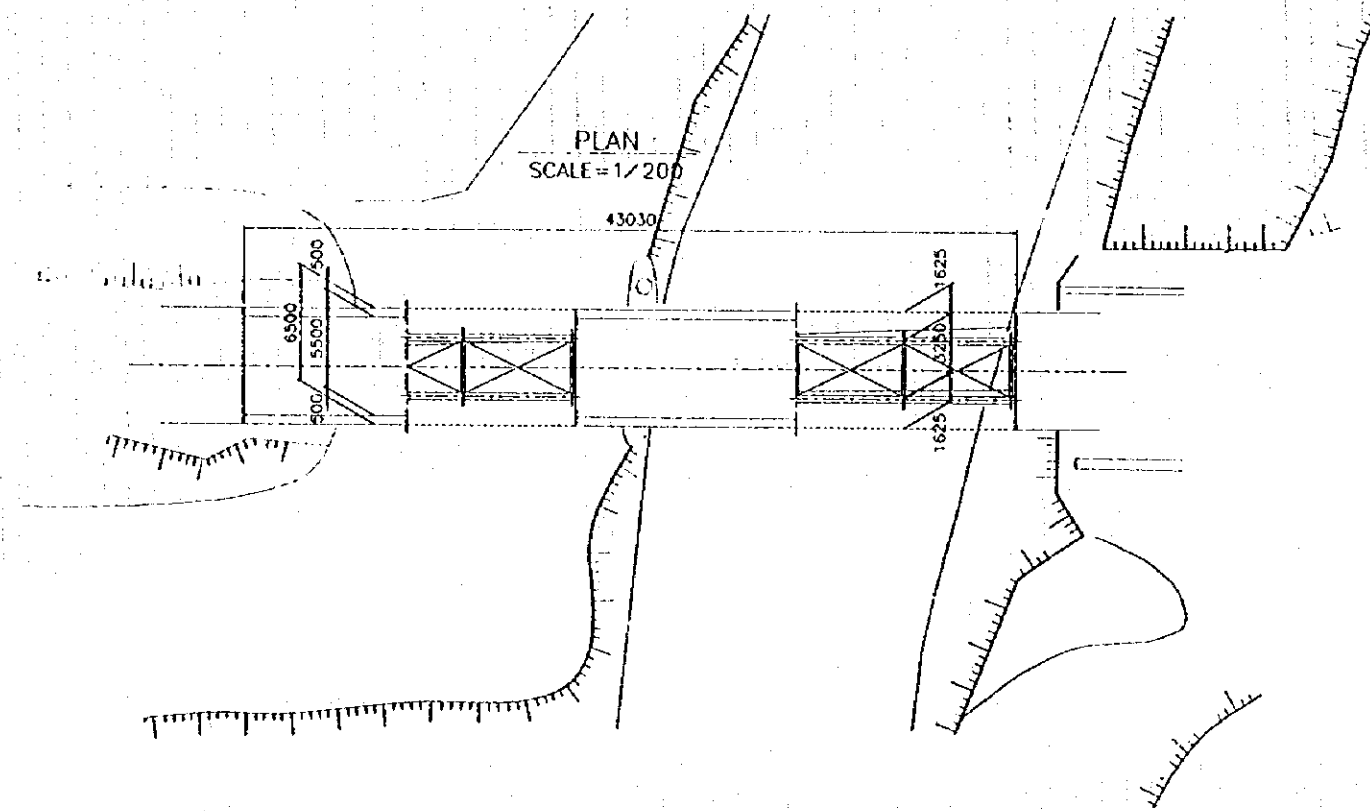

9. 収集資料リスト

タイトル	著者	年	発行者
STATISTICAL YEARBOOK 1993	Socialist Republic of Vietnam General Statistical Office (GSO)	1994	STATISTICAL PUBLISHING HOUSE
STATISTICAL DATA ON LABOUR AND SOCIAL AFFAIRS 1993		1994	STATISTICAL PUBLISHING HOUSE
Vietnam Bridge Design Code 22 TCN 018-79			
Design Criteria of Highway TCVN 4054-85			
TRANSPORT and MARKETING NO.5			CIVIL ENGINEERING COMPANY 810
LEGAL DOCUMENTS ON FOREIGN INVESTMENT AND PROTECTION OF INVESTMENT IN VIETNAM VOL. 1		1994	NATIONAL POLITICS PUBLISHERS
LEGAL DOCUMENTS ON FOREIGN INVESTMENT AND PROTECTION OF INVESTMENT IN VIETNAM VOL.2		1995	NATIONAL POLITICS PUBLISHERS
STATISTICAL YEARBOOK K.1992		1992	STATISTICAL PUBLISHING HOUSE
SATISTICAL YEARBOOK 1994		1994	STATISTICAL PUBLISHING HOUSE
VIETNAM CONSTRUCTION HANDBOOK		1995	DAVIS LANGDON & SEAH INTERNATIONAL
DON GIA XAY DUNG CO BAN IPHANOI (ハノイ市積算単価)		1994	ハノイ市人民委員会
DON GIA XAY DUNG CO BAN HA GIANG (ハジヤン州積算単価)		1994	ハジヤン州人民委員会
DON GIA XAY DUNG CO BAN NINH BINH (ニンビン州積算単価)		1994	ニンビン州人民委員会
DON GIA XAY DUNG CO BAN HA BAC (ハバック州積算単価)		1994	ハバック州人民委員会
DON GIA XAY DUNG CO BAN LAO CAI (ラオカイ州積算単価)		1994	ラオカイ州人民委員会
DON GIA XAY DUNG CO BAN BAC THAI (ハバックタイ州積算単価)		1994	ハバックタイ州人民委員会
DON GIA XAY DUNG CO BAN VINH PHU (ビンフ州積算単価)		1994	ビンフ州人民委員会



JICA