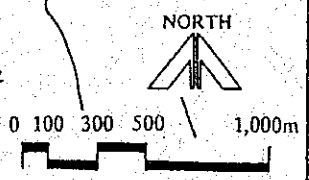


- LEGEND**
- INDUSTRIAL ESTATE**
- Main Road
 - Sub-main Road
 - Collector Road
 - Traffic Signal
 - Area of Industrial Estate
- REGIONAL DEVELOPMENT**
- Ring Road / Regional Road (w=32.5m)
 - Interchange
 - Traffic Signal
 - Bridge Reconstruction
- OTHERS**
- Existing Road
 - Existing Railway



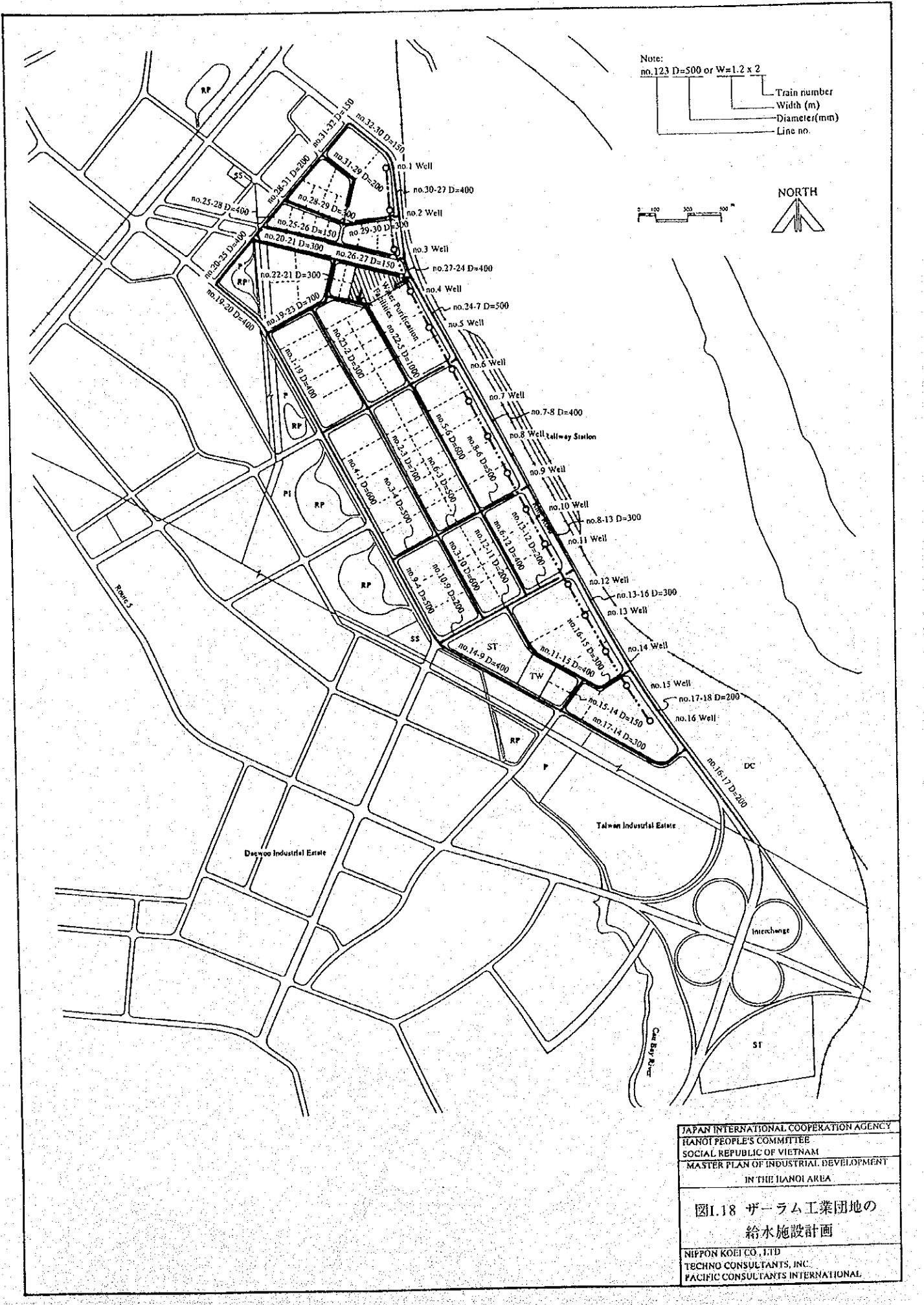
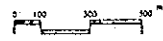
JAPAN INTERNATIONAL COOPERATION AGENCY
 HANOI PEOPLE'S COMMITTEE
 SOCIALIST REPUBLIC OF VIETNAM
 MASTER PLAN OF INDUSTRIAL DEVELOPMENT
 IN THE HANOI AREA

図I.17 ザーラム工業団地の道路網

NIPPON KOEI CO., LTD.
 TECHNICO CONSULTANTS, INC.
 PACIFIC CONSULTANTS INTERNATIONAL

Note:
 no.123 D=500 or W=1.2 x 2

Train number
 Width (m)
 Diameter (mm)
 Line no.



JAPAN INTERNATIONAL COOPERATION AGENCY
 HANOI PEOPLE'S COMMITTEE
 SOCIAL REPUBLIC OF VIETNAM
 MASTER PLAN OF INDUSTRIAL DEVELOPMENT
 IN THE HANOI AREA

図I.18 ザーラム工業団地の
 給水施設計画

NIFFON KOEI CO., LTD
 TECHNO CONSULTANTS, INC.
 PACIFIC CONSULTANTS INTERNATIONAL

Note:
 No. 23 Ds 500 or Wp 1, 2, 3, 4, 5
 Train number
 Width (m)
 Diameter (mm)
 Pipe (m)

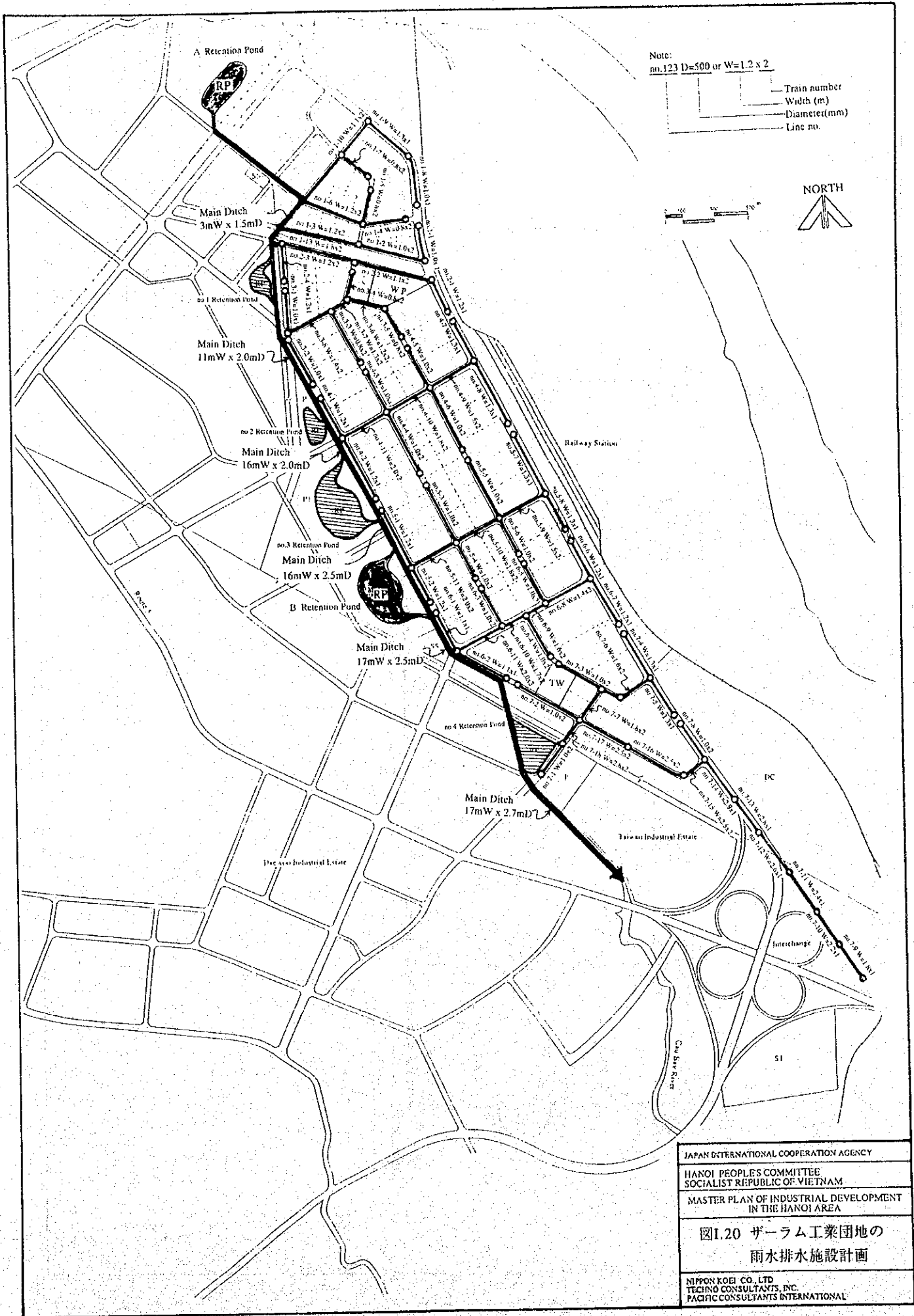


JAPAN INTERNATIONAL COOPERATION AGENCY
 JAPAN PEOPLE'S COMMUNE THE
 SOCIAL REPUBLIC OF VIETNAM
 MAINTENANCE INDUSTRIAL DEVELOPMENT
 IN THE HANOI AREA
 HANOI, VIETNAM

図1.19 ガーラム工業団地の
 の汚水処理施設設計画

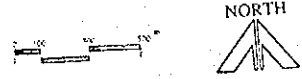
SHIMIZU KENJI CO., LTD.
 HONGKONG, HONG KONG





Note:
no.123 D=500 or W=1.2 x 2

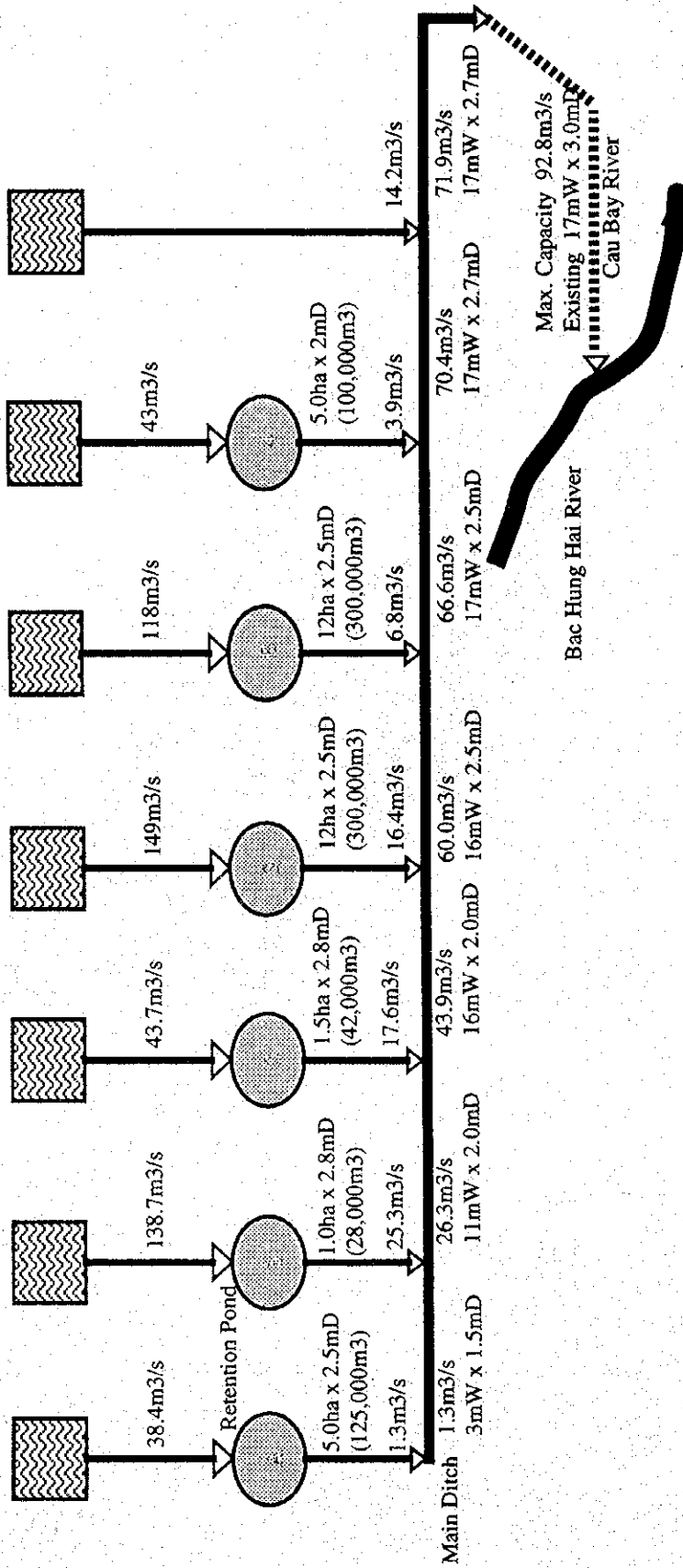
— Train number
— Width (m)
— Diameter (mm)
— Line no.



JAPAN INTERNATIONAL COOPERATION AGENCY
HANOI PEOPLES COMMITTEE SOCIALIST REPUBLIC OF VIETNAM
MASTER PLAN OF INDUSTRIAL DEVELOPMENT IN THE HANOI AREA
図I.20 ザーラム工業団地の 雨水排水施設計画
NIPPON KOGI CO., LTD TECHNO CONSULTANTS, INC. PACIFIC CONSULTANTS INTERNATIONAL

Basin-A	Basin-1	Basin-2	Basin-3	Basin-B	Basin-4	Basin-5
A = 116ha C = 0.8	A = 117ha C = 0.8	A = 132ha C = 0.8	A = 478ha C = 0.8	A = 358ha C = 0.8	A = 130ha C = 0.8	A = 43ha C = 0.8

Catchment Basin



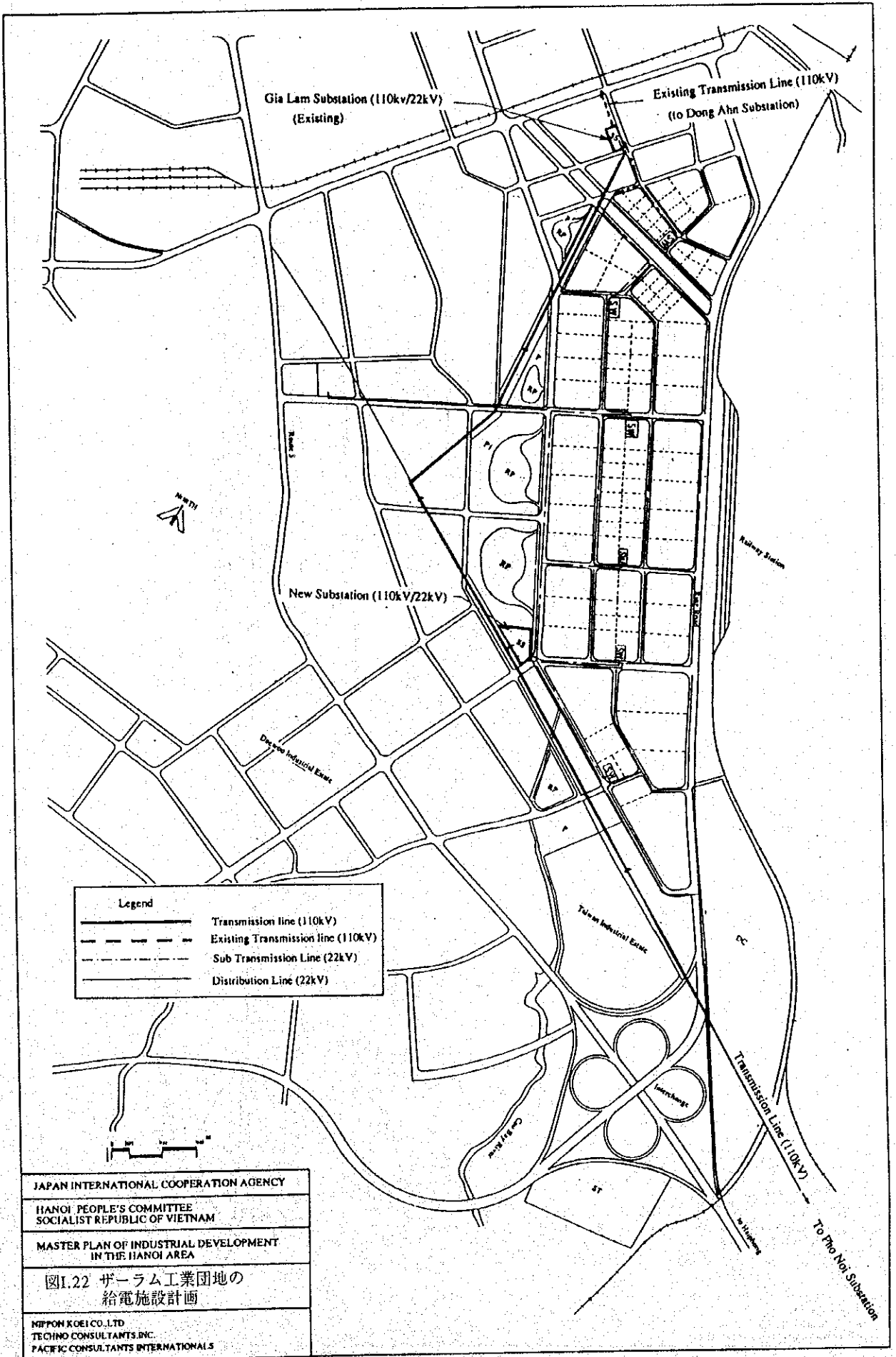
JAPAN INTERNATIONAL COOPERATION AGENCY

HANOI PEOPLE'S COMMITTEE
SOCIALIST REPUBLIC OF VIETNAM





MASTER PLAN OF INDUSTRIAL DEVELOPMENT IN THE
HANOI AREA

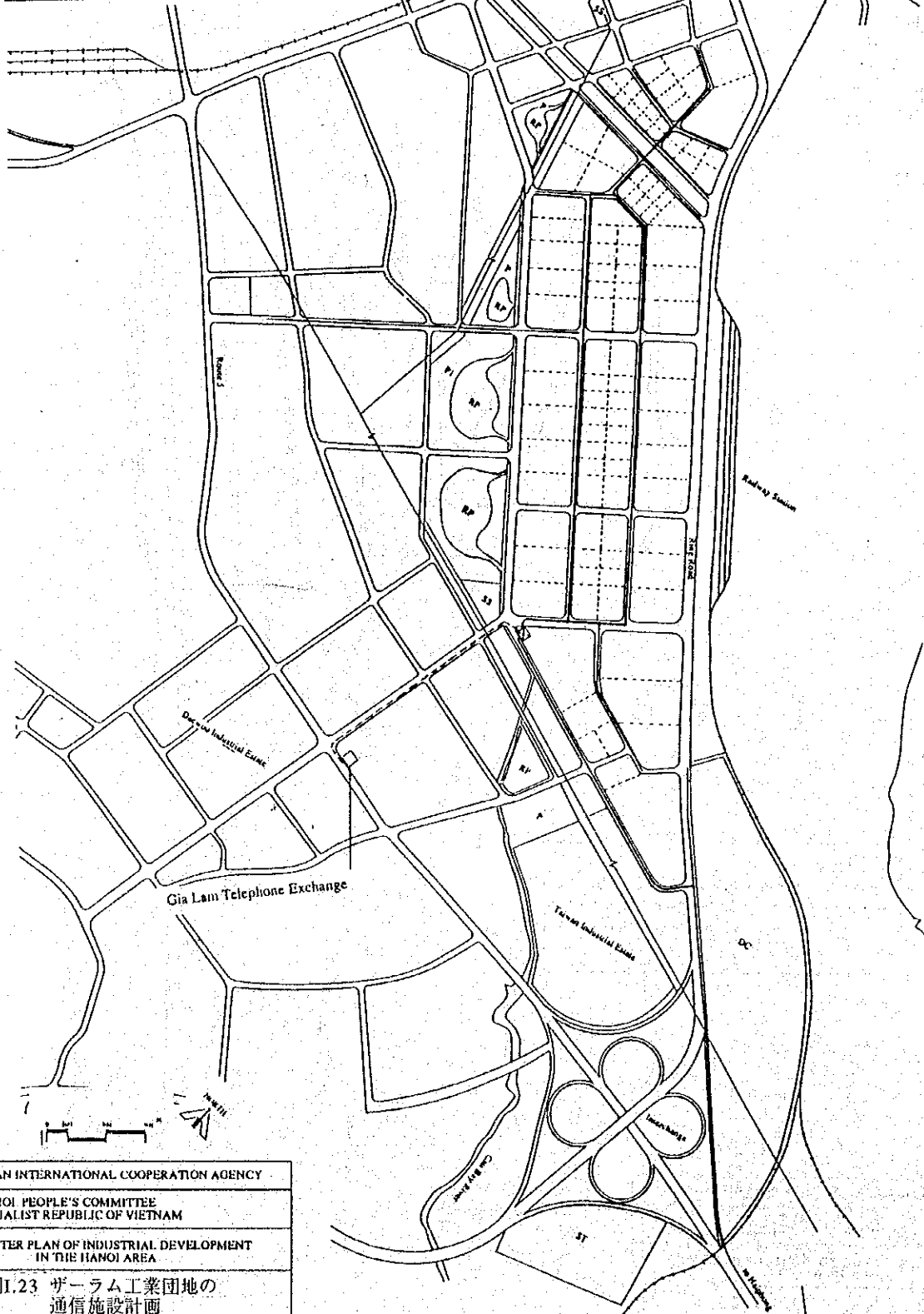
図 1.21 ガーラムコミュニケーションの
雨水処理フローダイヤグラム

SHIMIZU KOBAYASHI CO., LTD.
TECHNICO CONSULTANTS, INC.
PACIFIC CONSULTANTS INTERNATIONAL



JAPAN INTERNATIONAL COOPERATION AGENCY
 HANOI PEOPLE'S COMMITTEE
 SOCIALIST REPUBLIC OF VIETNAM
 MASTER PLAN OF INDUSTRIAL DEVELOPMENT
 IN THE HANOI AREA
 図I.22 ガーラム工業団地の
 給電施設計画
 NIPPON KOEI CO., LTD.
 TECHNICO CONSULTANTS INC.
 PACIFIC CONSULTANTS INTERNATIONALS

Legend	
	Optical Fider Line
	Main Metallic Cable Line
	Branch Metallic Cable Line
	Remote OLTE Station



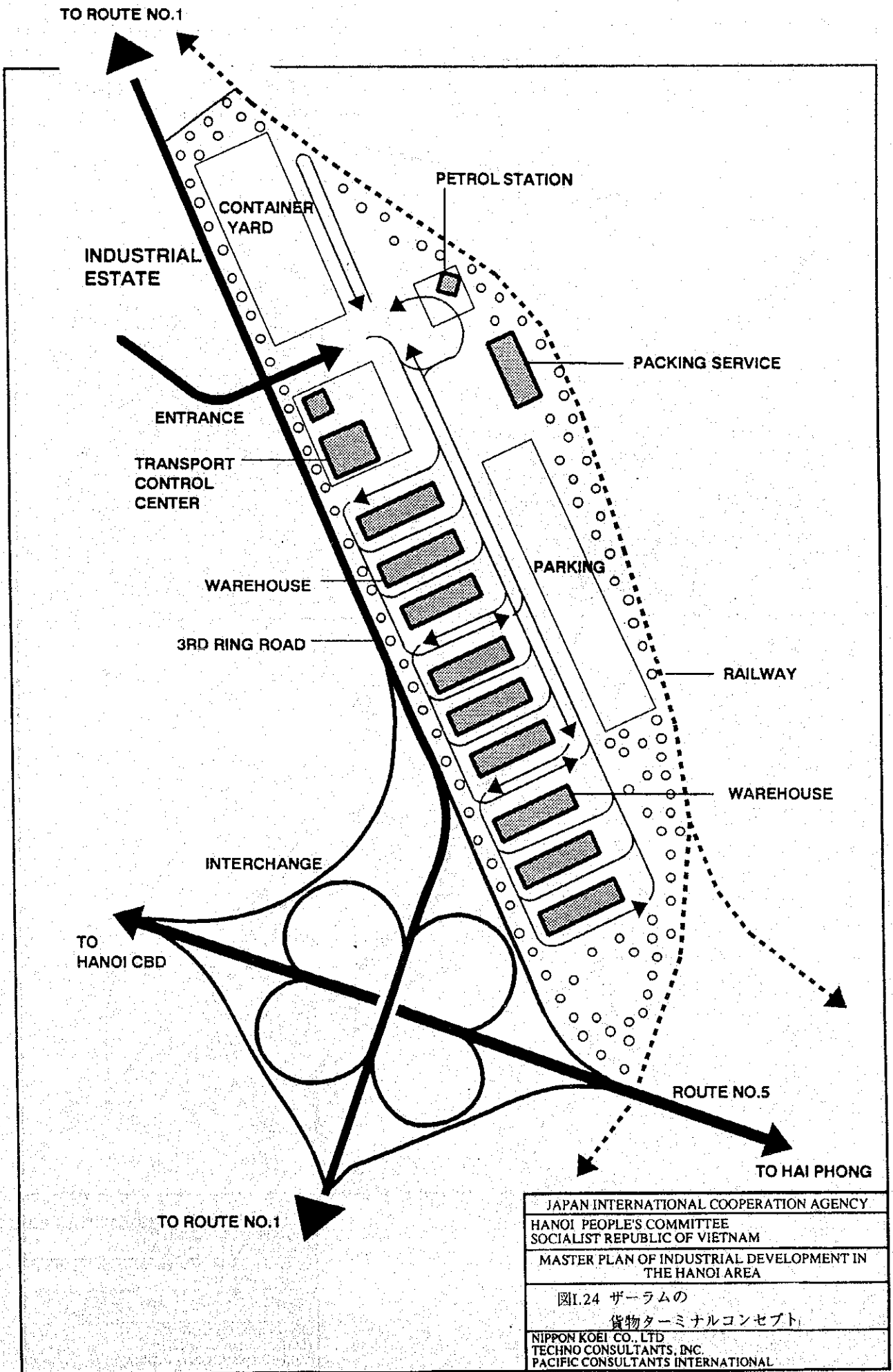
JAPAN INTERNATIONAL COOPERATION AGENCY

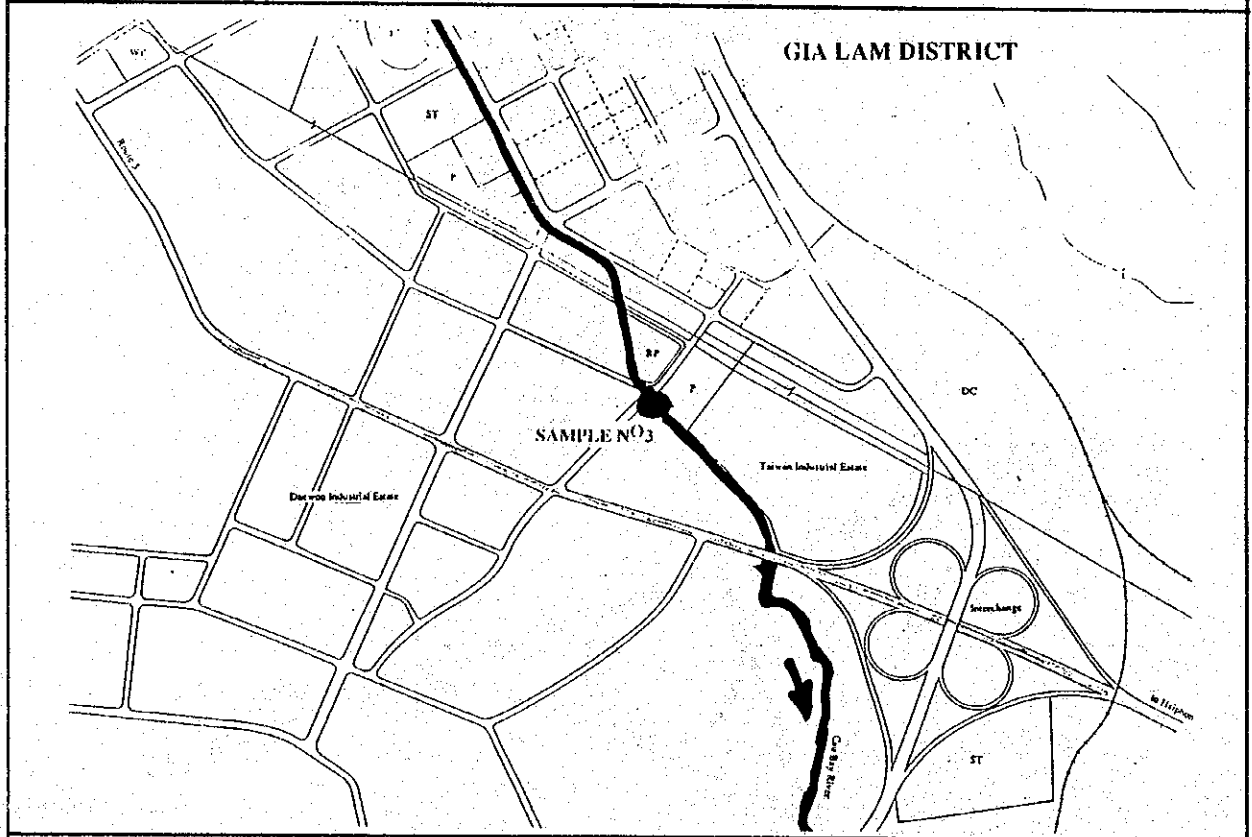
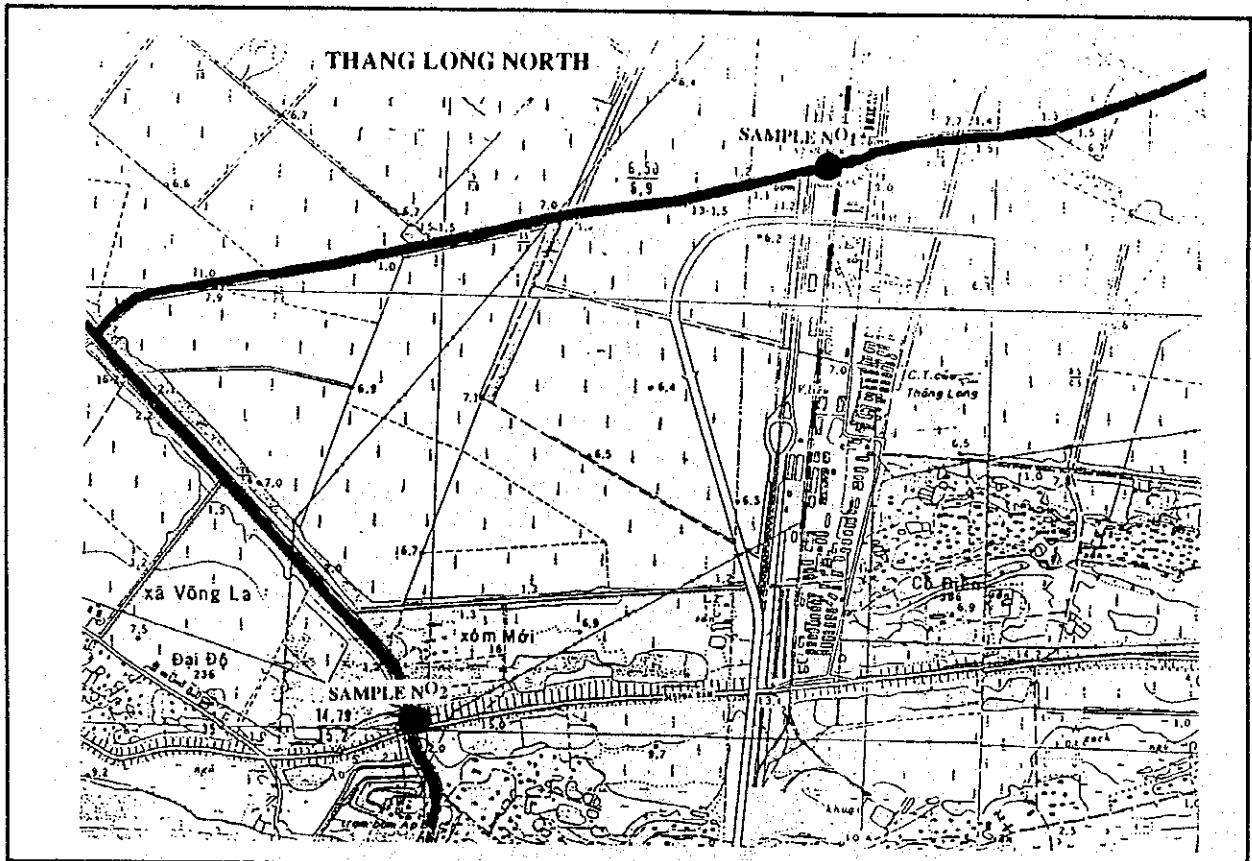
HANOI PEOPLE'S COMMITTEE
SOCIALIST REPUBLIC OF VIETNAM

MASTER PLAN OF INDUSTRIAL DEVELOPMENT
IN THE HANOI AREA

図I.23 ザーラム工業団地の
通信施設計画

NIPPON KOEI CO., LTD.
TECHNO CONSULTANTS, INC.
PACIFIC CONSULTANTS INTERNATIONALS





JAPAN INTERNATIONAL COOPERATION AGENCY
 HANOI PEOPLE'S COMMITTEE
 SOCIAL REPUBLIC OF VIETNAM
 MASTER PLAN OF INDUSTRIAL, DEVELOPMENT
 IN THE HANOI AREA

図I.25 水質サンプリング地点

NIPPON KOEI CO., LTD
 TECHNO CONSULTANTS, INC.
 PACIFIC CONSULTANTS INTERNATIONAL

図 1.26 タンロン北工業団地の開発スケジュール

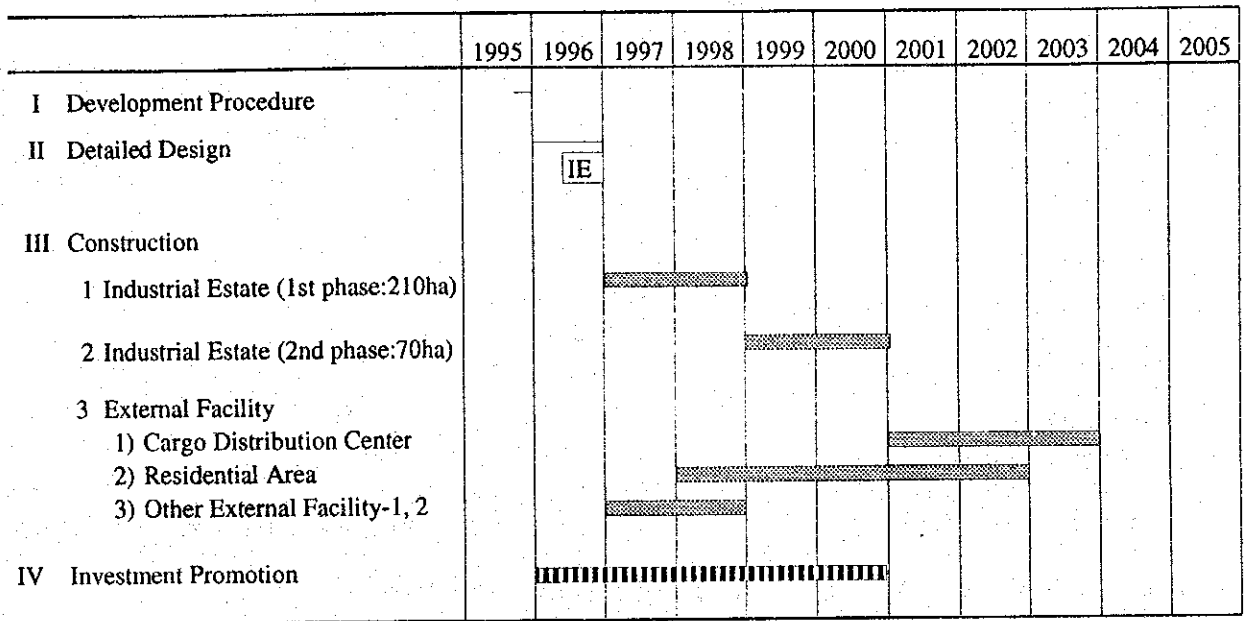


図 I.27 ザーラム工業団地の開発スケジュール

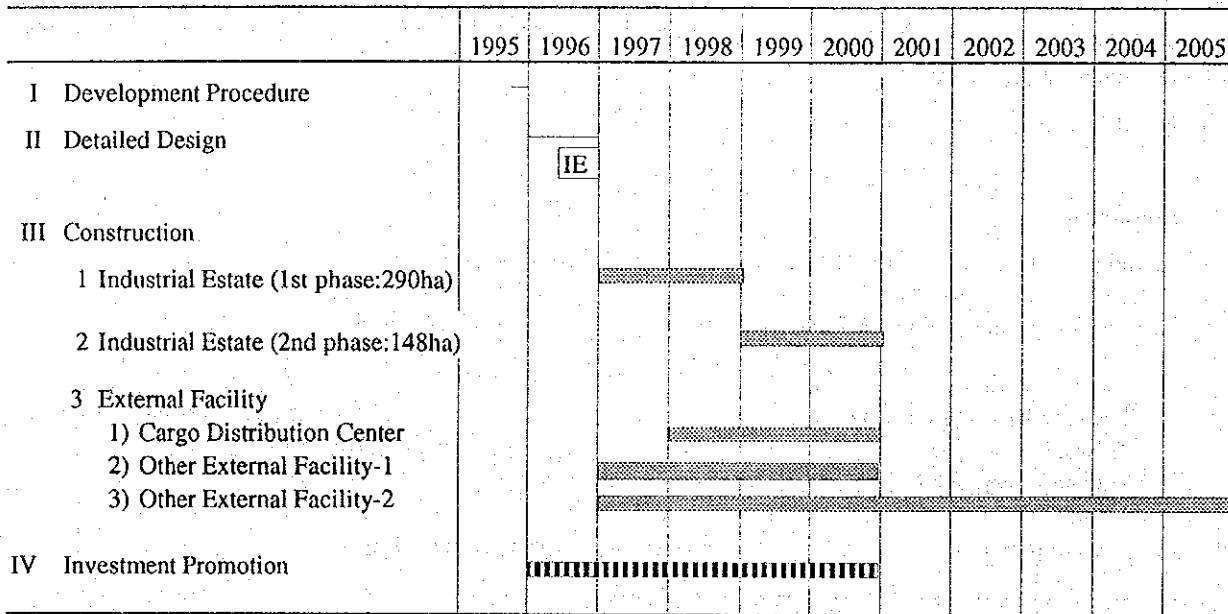
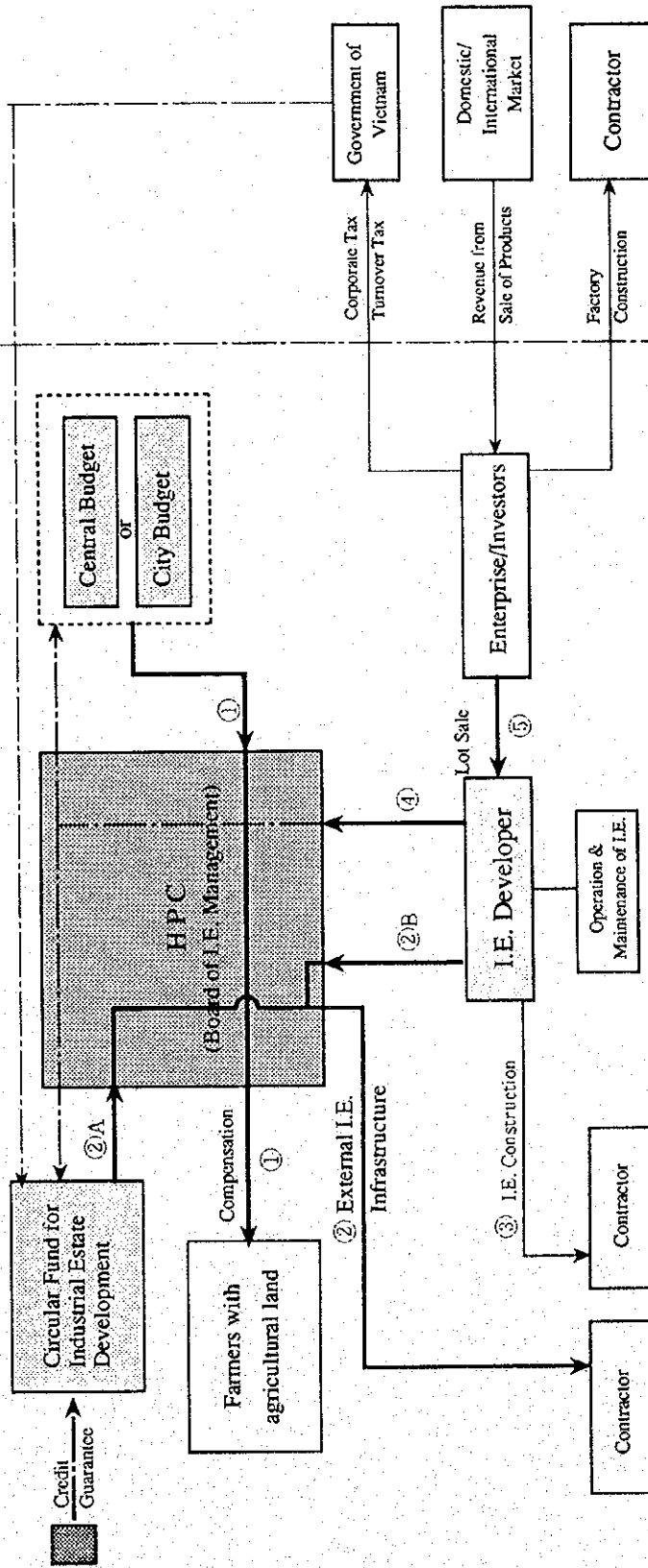


Figure 1.28 SCHEMATIC FUND FLOW for the Industrial Estate Development



Work Items	HPC		I.E. Developer	
	Cash outflows	Cash inflows	Cash outflows	Cash inflows
Compensation	○ 1			
External Infrastructure	○ 2			
I.E. Construction			○ 3	
Rental Fees		○ 4	○ 4	
Lot Sale				○ 5

JAPAN INTERNATIONAL COOPERATION AGENCY
 HANOI PEOPLES COMMITTEE
 SOCIALIST REPUBLIC OF VIETNAM
 MASTER PLAN OF INDUSTRIAL DEVELOPMENT
 IN THE HANOI AREA
 図 1.28 工業団地開発のための
 資金の流れ
 NIPPON KAI TO KEN RUI
 PACIFIC CONSULTANTS INTERNATIONAL

JICA