

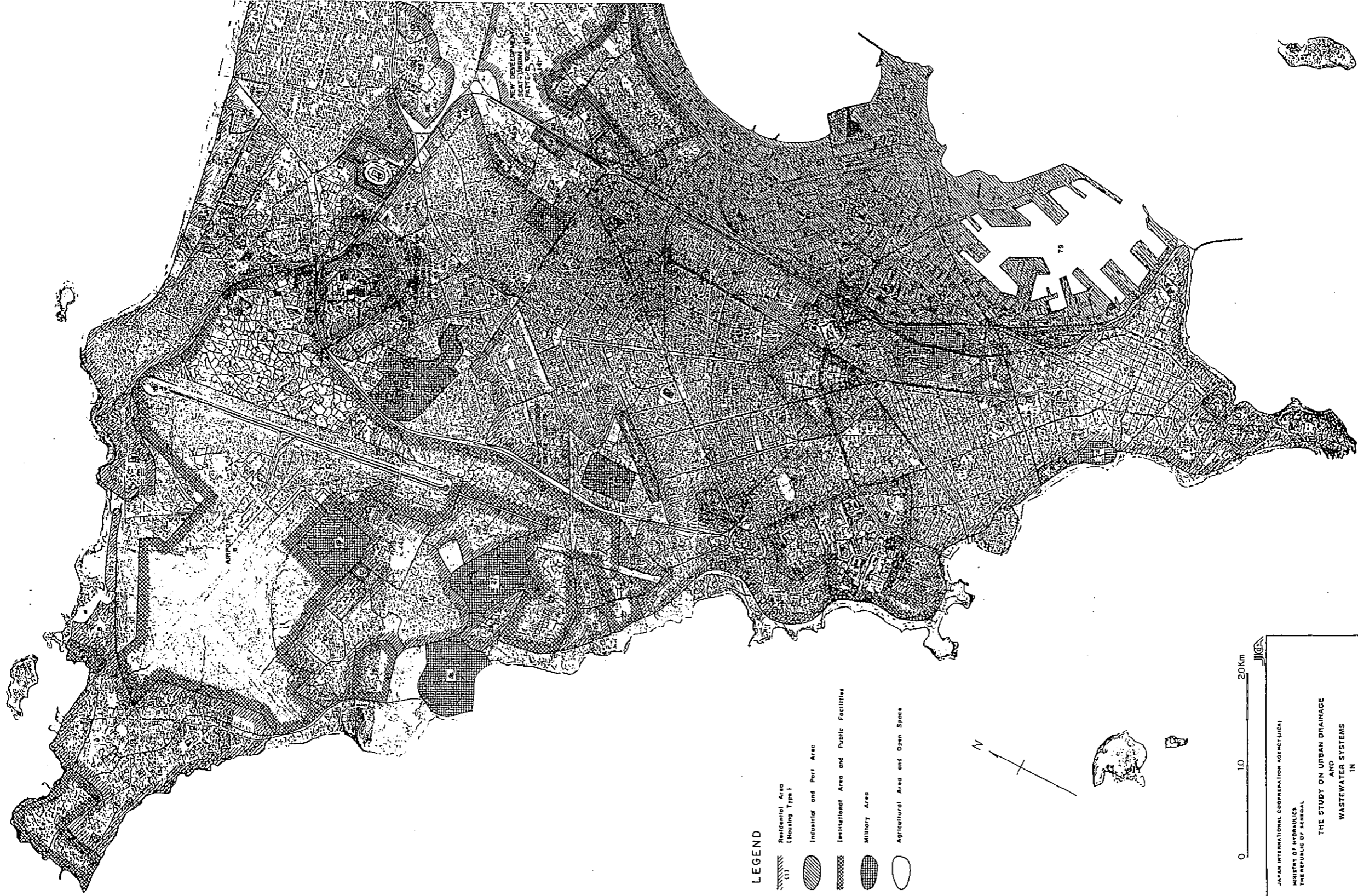





WASTEWATER SYSTEM



LEGEND

-  Residential Area (Housing Type 1)
-  Industrial and Port Area
-  Institutional Area and Public Facilities
-  Military Area
-  Agricultural Area and Open Space

0 10 20km

JICA
 JAPAN INTERNATIONAL COOPERATION AGENCY (JICA)
 MINISTRY OF INFRASTRUCTURE
 THE REPUBLIC OF SENEGAL

THE STUDY ON URBAN DRAINAGE
 AND
 WASTEWATER SYSTEMS
 IN
 DAKAR CITY AND ITS SURROUNDINGS

LAND USE PLAN (2010) (1/2)

1:110,000

PACIFIC CONSULTANTS INTERNATIONAL, TOKYO
 15-1-1000-1000
 TOKYO ENGINEERING CONSULTANTS CO., LTD., TOKYO

1984



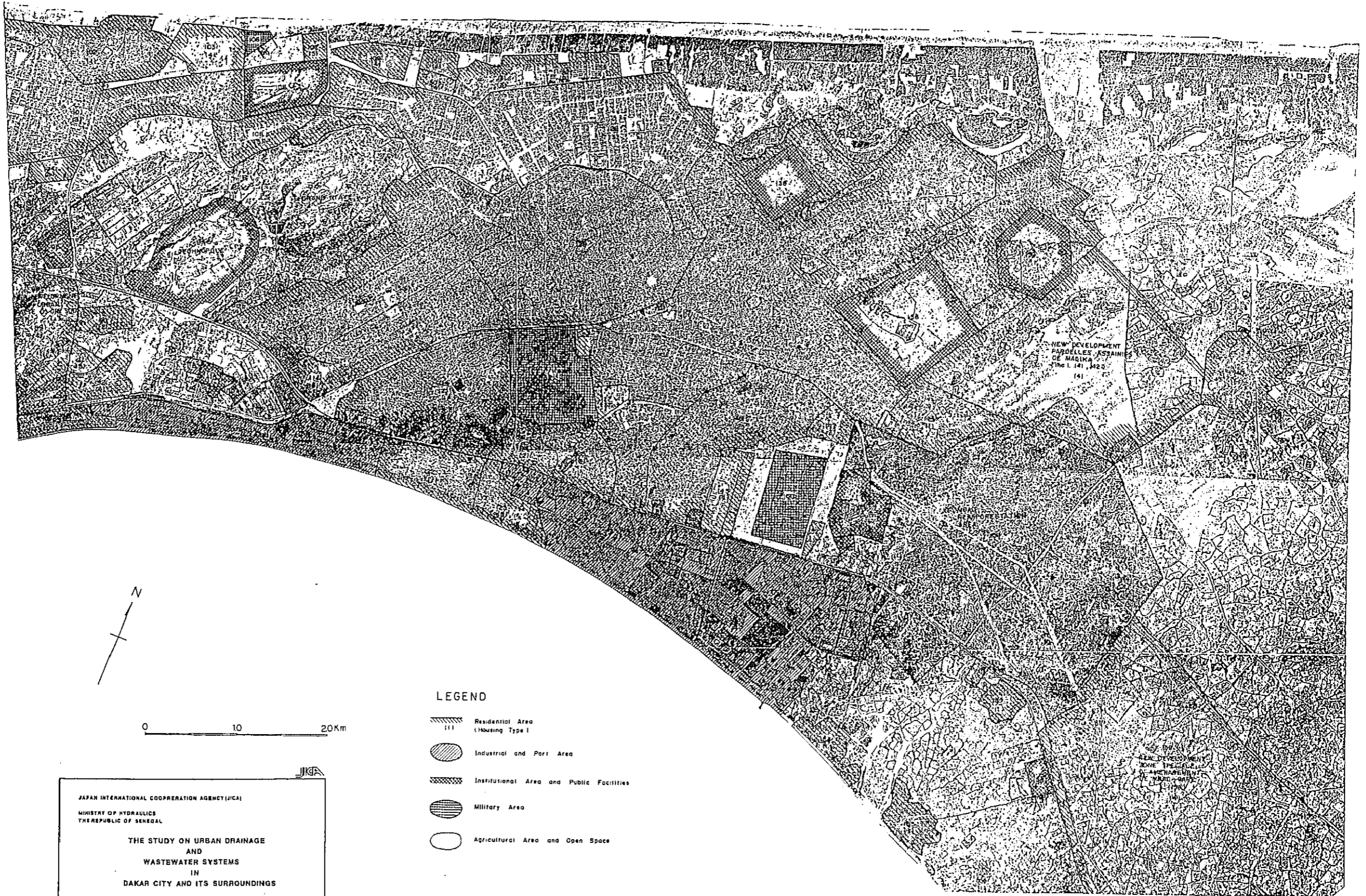

LEGEND

- Residential Area (Housing Type I)
- Industrial and Port Area
- Institutional Area and Public Facilities
- Military Area
- Agricultural Area and Open Space

 JAPAN INTERNATIONAL COOPERATION AGENCY (JICA)
 MINISTRY OF HYDRAULICS
 THE REPUBLIC OF SENEGAL

**THE STUDY ON URBAN DRAINAGE
 AND
 WASTEWATER SYSTEMS
 IN
 DAKAR CITY AND ITS SURROUNDINGS**

LAND USE PLAN (2010) (2/2)
S-1/15.704
 PACIFIC CONSULTANTS INTERNATIONAL, TOKYO 1994
IN COOPERATION WITH
 TOKYO ENGINEERING CONSULTANTS CO. LTD., TOKYO

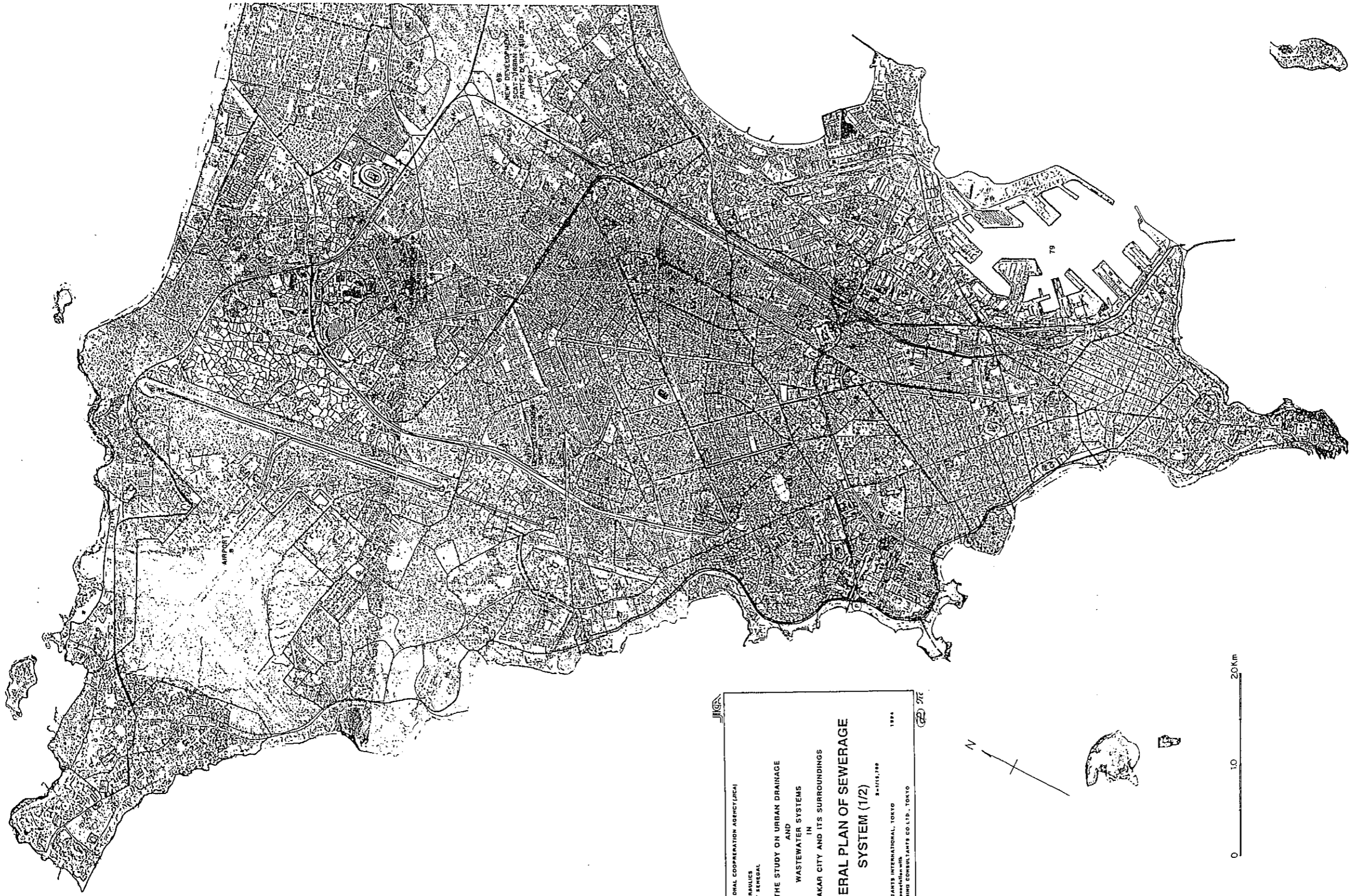

1:50,000
 MAP OF SENEGAL
 SCALE 1:50,000
 PART 1: DAKAR AND VICINITY
 1963

JICA
 JAPAN INTERNATIONAL COOPERATION AGENCY (JICA)
 MINISTRY OF FINANCES
 THE REPUBLIC OF SENEGAL
 THE STUDY ON URBAN DRAINAGE
 AND
 WASTEWATER SYSTEMS
 IN
 DAKAR CITY AND ITS SURROUNDINGS
 GENERAL PLAN OF SEWERAGE
 SYSTEM (1/2)
 8-1115, 1300
 1984
 PACIFIC CONSULTANTS INTERNATIONAL, TOKYO
 in association with
 TOKYO ENGINEERING CONSULTANTS CO. LTD., TOKYO

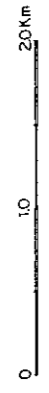
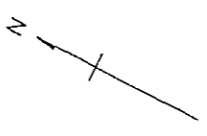

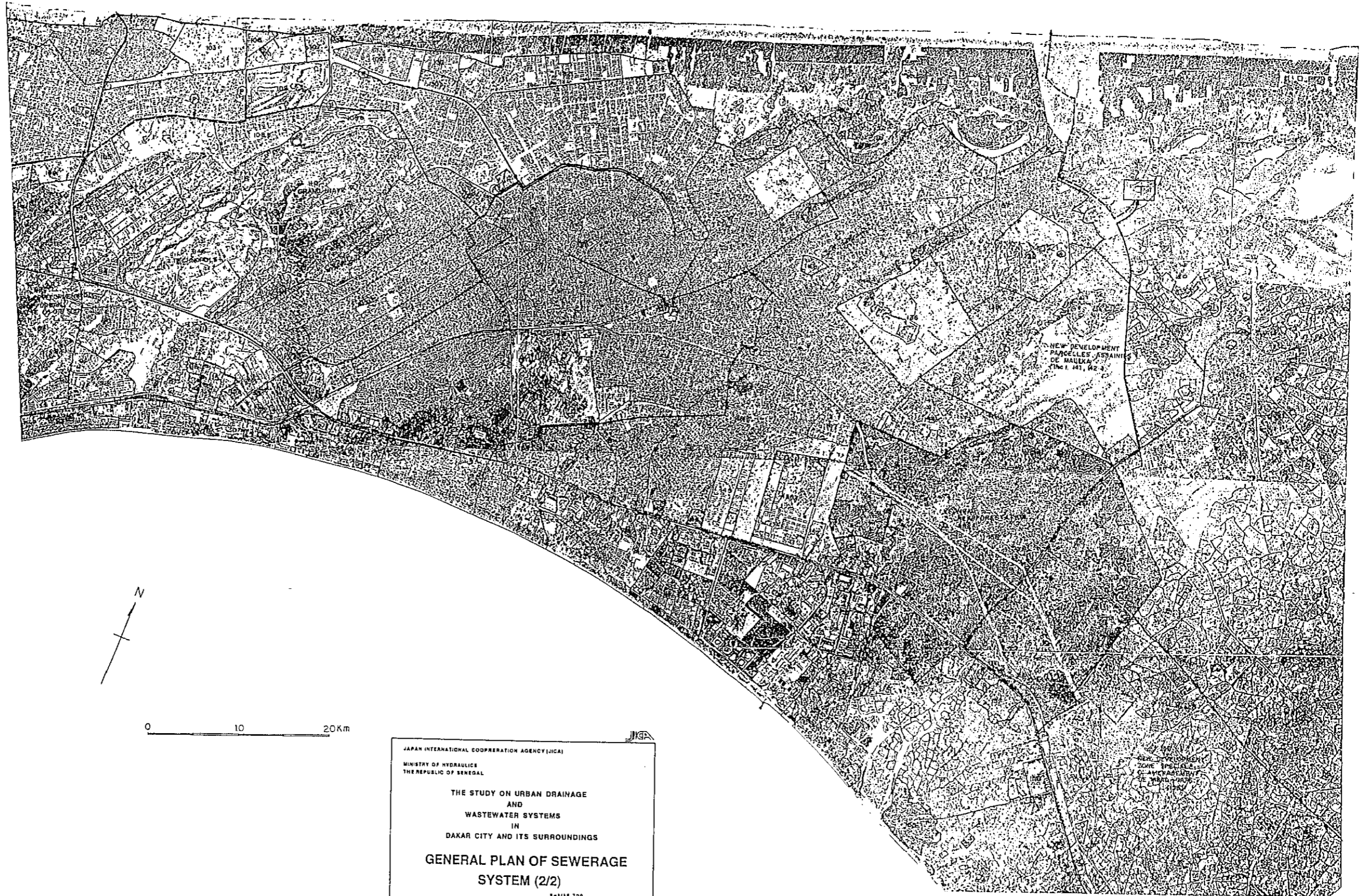

0 10 20km

JICA
JAPAN INTERNATIONAL COOPERATION AGENCY (JICA)
MINISTRY OF HYDRAULICS
THE REPUBLIC OF SENEGAL

THE STUDY ON URBAN DRAINAGE
AND
WASTEWATER SYSTEMS
IN
DAKAR CITY AND ITS SURROUNDINGS

GENERAL PLAN OF SEWERAGE
SYSTEM (2/2)

Scale 1:50,000

PACIFIC CONSULTANTS INTERNATIONAL, TOKYO
IN ASSOCIATION WITH
TOKYO ENGINEERING CONSULTANTS CO., LTD., TOKYO

1984

THE STUDY ON URBAN DRAINAGE AND WASTEWATER SYSTEMS IN DAKAR CITY AND ITS SURROUNDINGS

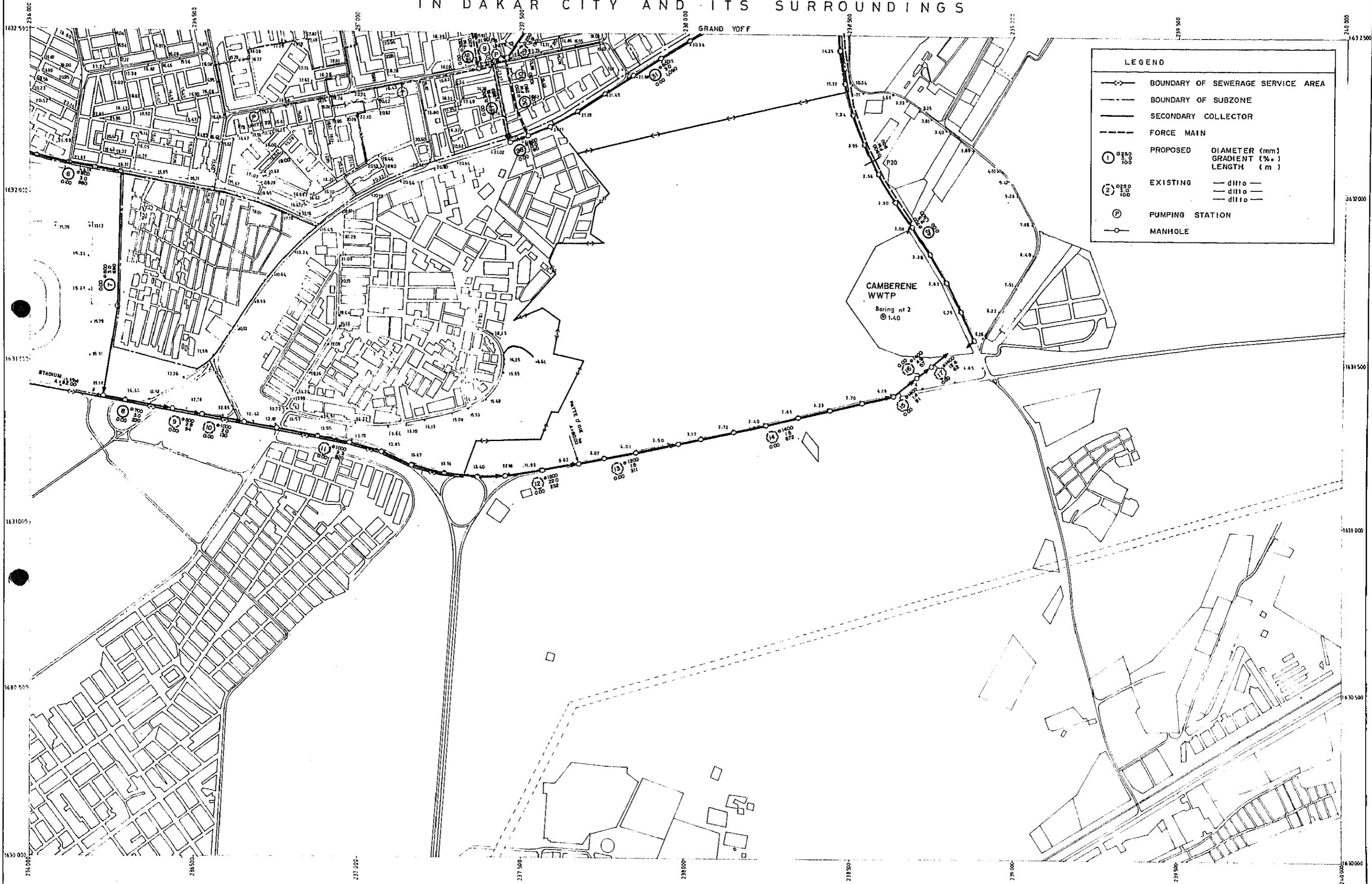

LEGEND	
	BOUNDARY OF SEWERAGE SERVICE AREA
	BOUNDARY OF SUBZONE
	SECONDARY COLLECTOR
	FORCE MAIN
	PROPOSED
	DIAMETER (mm)
	GRADIENT (%)
	LENGTH (m)
	EXISTING
	— d110 —
	— d150 —
	— d180 —
	PUMPING STATION
	MANHOLE

THE STUDY ON URBAN DRAINAGE AND WASTEWATER SYSTEMS IN DAKAR CITY AND ITS SURROUNDINGS

PARCELLES ASSAINIES - CAMBÉRÈNE



LEGEND	
	BOUNDARY OF SEWERAGE SERVICE AREA
	BOUNDARY OF SUBZONE
	SECONDARY COLLECTOR
	FORCE MAIN
	PROPOSED DIAMETER (mm) GRADIENT (%) LENGTH (m)
	EXISTING — ditto — — ditto — — ditto —
	PUMPING STATION
	MANHOLE

4
3 1

THE STUDY ON URBAN DRAINAGE AND WASTEWATER SYSTEMS
IN DAKAR CITY AND ITS SURROUNDINGS

KEUR NIEUSSE - MA

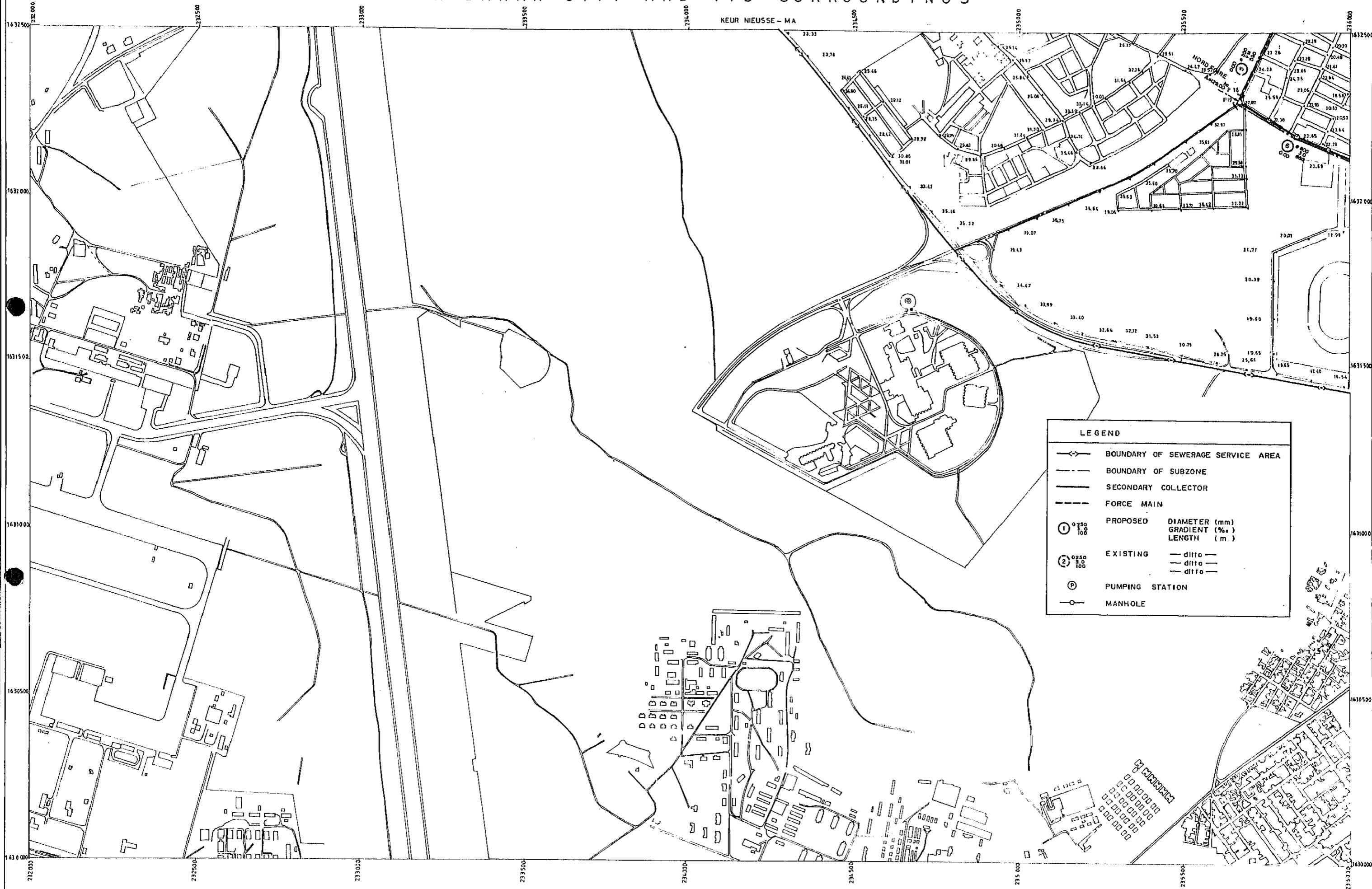

LEGEND

- BOUNDARY OF SEWERAGE SERVICE AREA
- BOUNDARY OF SUBZONE
- SECONDARY COLLECTOR
- FORCE MAIN
- ① $\frac{0.250}{100}$ PROPOSED DIAMETER (mm) GRADIENT (%) LENGTH (m)
- ② $\frac{0.250}{100}$ EXISTING ditto ditto ditto
- Ⓟ PUMPING STATION
- MANHOLE

4	2
③	1

THE STUDY ON URBAN DRAINAGE AND WASTEWATER SYSTEMS IN DAKAR CITY AND ITS SURROUNDINGS

YOFF - PARCELLES ASSAINIES



LEGEND	
	BOUNDARY OF SEWERAGE SERVICE AREA
	BOUNDARY OF SUBZONE
	SECONDARY COLLECTOR
	FORCE MAIN
	PROPOSED DIAMETER (mm) GRADIENT (%) LENGTH (m)
	EXISTING — ditto — — ditto — — ditto —
	PUMPING STATION
	MANHOLE

4	2
3	1

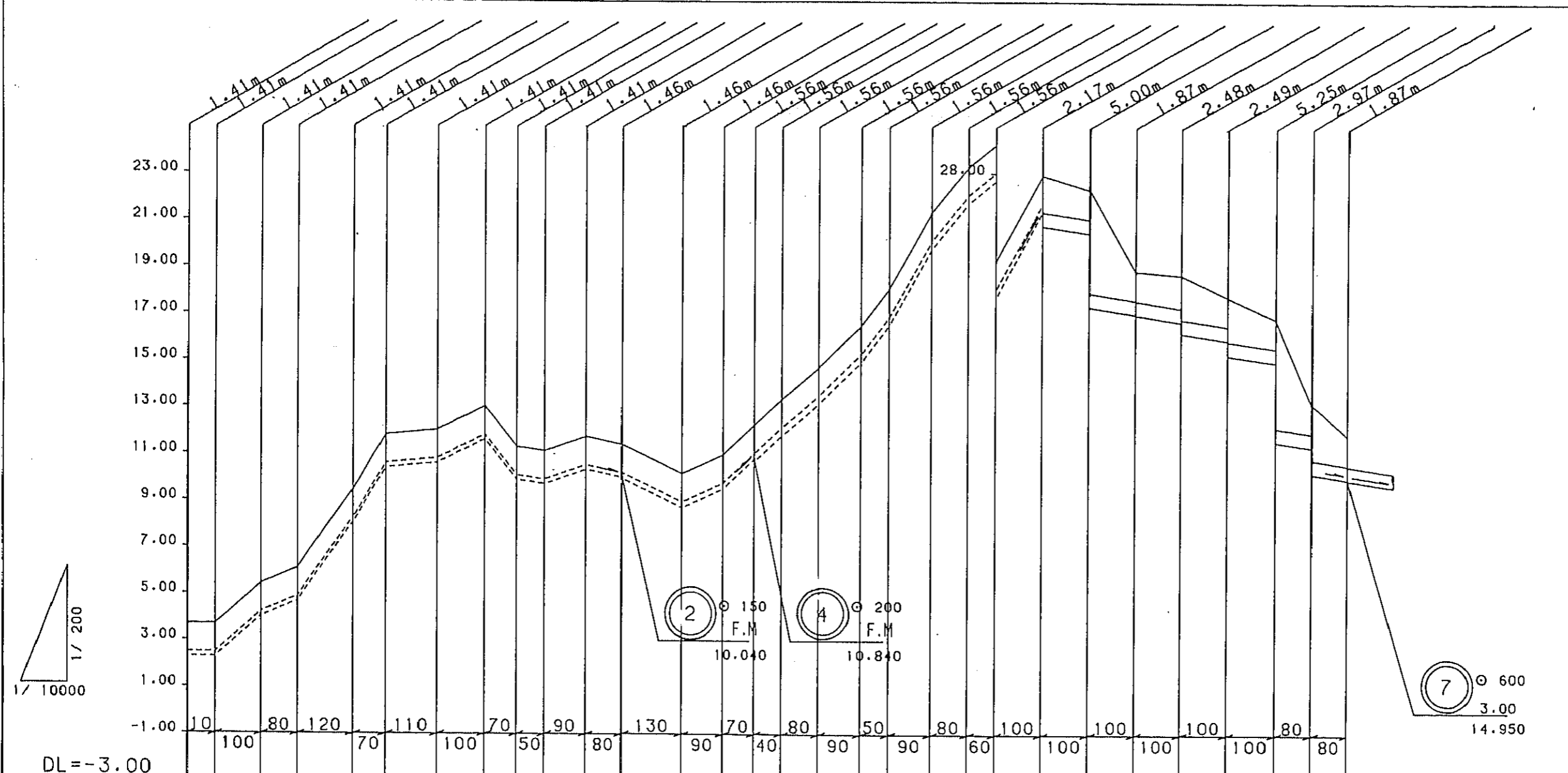

1	3	5	6

Sewer Number	1										3				5				6											
Diameter (mm)	Ø 200										Ø 250				Ø 350				Ø 600											
Slope (%)	F.M										F.M				F.M				3.00											
Length (m)	880										290				590				660											
Elevation (m)	3.70	3.70	5.44	6.09	9.43	11.79	12.00	13.01	11.28	11.11	11.73	11.40	10.16	10.98	12.25	13.35	14.71	16.48	18.07	21.31	23.26	24.23	27.92	27.30	23.85	23.69	22.76	21.82	18.18	16.82
Grand Surface	3.70	3.70	5.44	6.09	9.43	11.79	12.00	13.01	11.28	11.11	11.73	11.40	10.16	10.98	12.25	13.35	14.71	16.48	18.07	21.31	23.26	24.23	27.92	27.30	23.85	23.69	22.76	21.82	18.18	16.82
Earth Covering (m)	1.20	1.20	1.20	1.20	1.20	1.20	1.20	1.20	1.20	1.20	1.20	1.20	1.20	1.20	1.20	1.20	1.20	1.20	1.20	1.20	1.20	1.20	1.32	1.30	1.22	1.36	1.84	1.20	2.32	1.20
Sewer Invert Elevation (m)	2.290	2.290	4.030	4.680	8.020	10.380	10.590	11.600	9.870	9.700	10.320	9.990	8.700	9.520	10.790	11.787	13.147	14.917	16.507	19.747	21.697	22.667	26.357	25.450	22.000	21.580	20.910	19.970	16.330	14.970
Total Length (m)	0	10	110	190	310	380	490	590	660	710	800	880	1010	1100	1170	1210	1290	1380	1430	1520	1600	1660	1760	1860	1960	2060	2160	2260	2340	2420

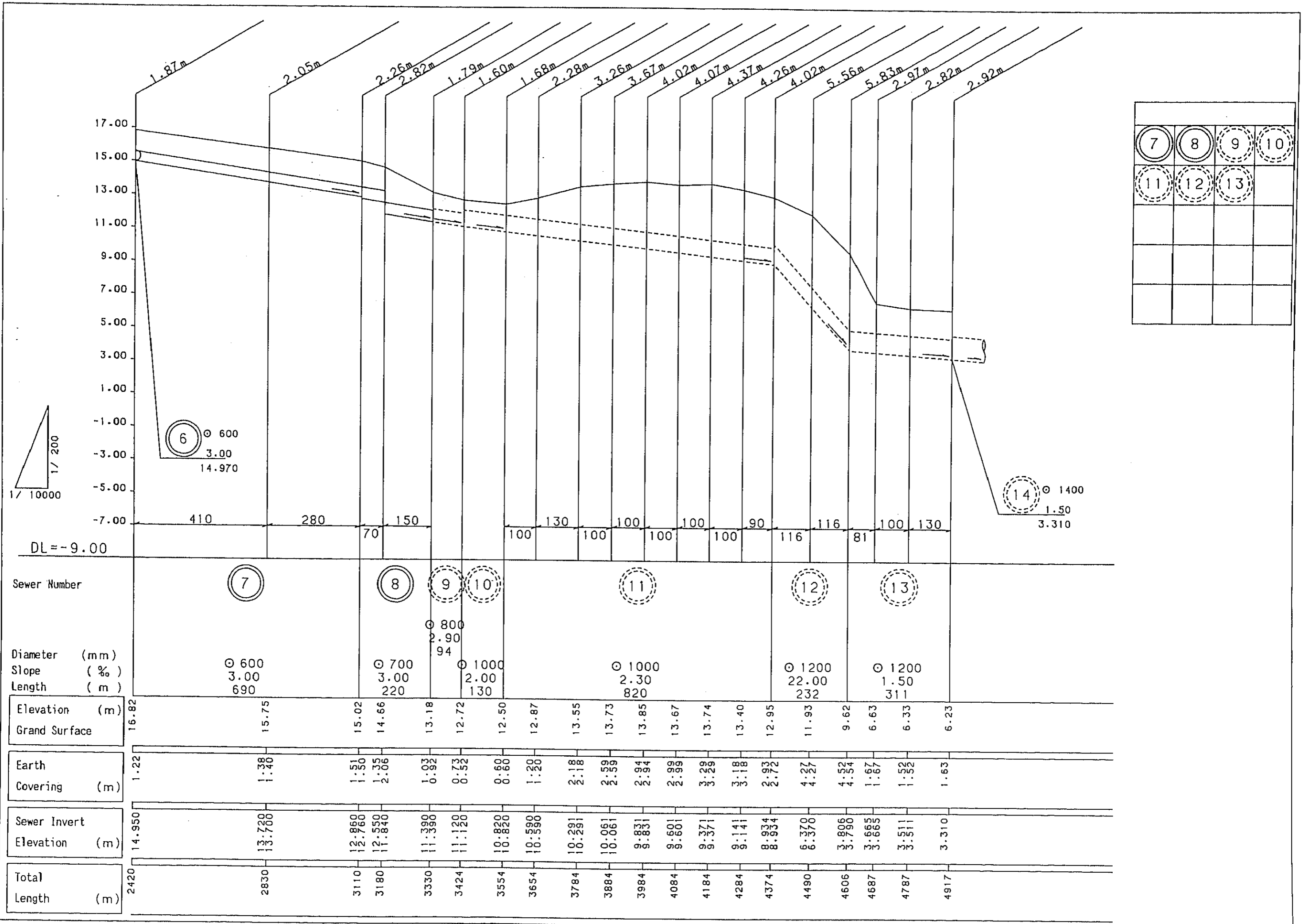

7	8	9	10
11	12	13	

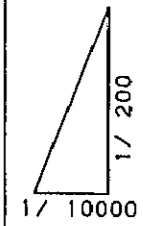

	410	280	70	150	100	130	100	100	100	100	90	116	116	81	100	130					
DL = -9.00																					
Sewer Number	7	8	9	10	11				12	13											
Diameter (mm)	600	700	800	1000	1000				1200	1200											
Slope (%)	3.00	3.00	2.90	2.00	2.30				22.00	1.50											
Length (m)	690	220	94	130	820				232	311											
Elevation (m)	16.82	15.75	15.02	14.66	13.18	12.72	12.50	12.87	13.55	13.73	13.85	13.67	13.74	13.40	12.95	11.93	9.62	6.63	6.33	6.23	
Grand Surface																					
Earth Covering (m)	1.22	1.38	1.51	1.35	0.92	0.73	0.60	1.20	2.18	2.59	2.94	2.99	3.29	3.18	2.93	4.27	4.52	4.54	1.67	1.52	1.63
Sewer Invert Elevation (m)	14.950	13.730	12.960	12.760	11.390	11.120	10.820	10.590	10.291	10.061	9.831	9.601	9.371	9.141	8.934	6.370	3.806	3.790	3.665	3.511	3.310
Total Length (m)	2420	2830	3110	3180	3330	3424	3554	3654	3784	3884	3984	4084	4184	4284	4374	4490	4606	4687	4787	4917	

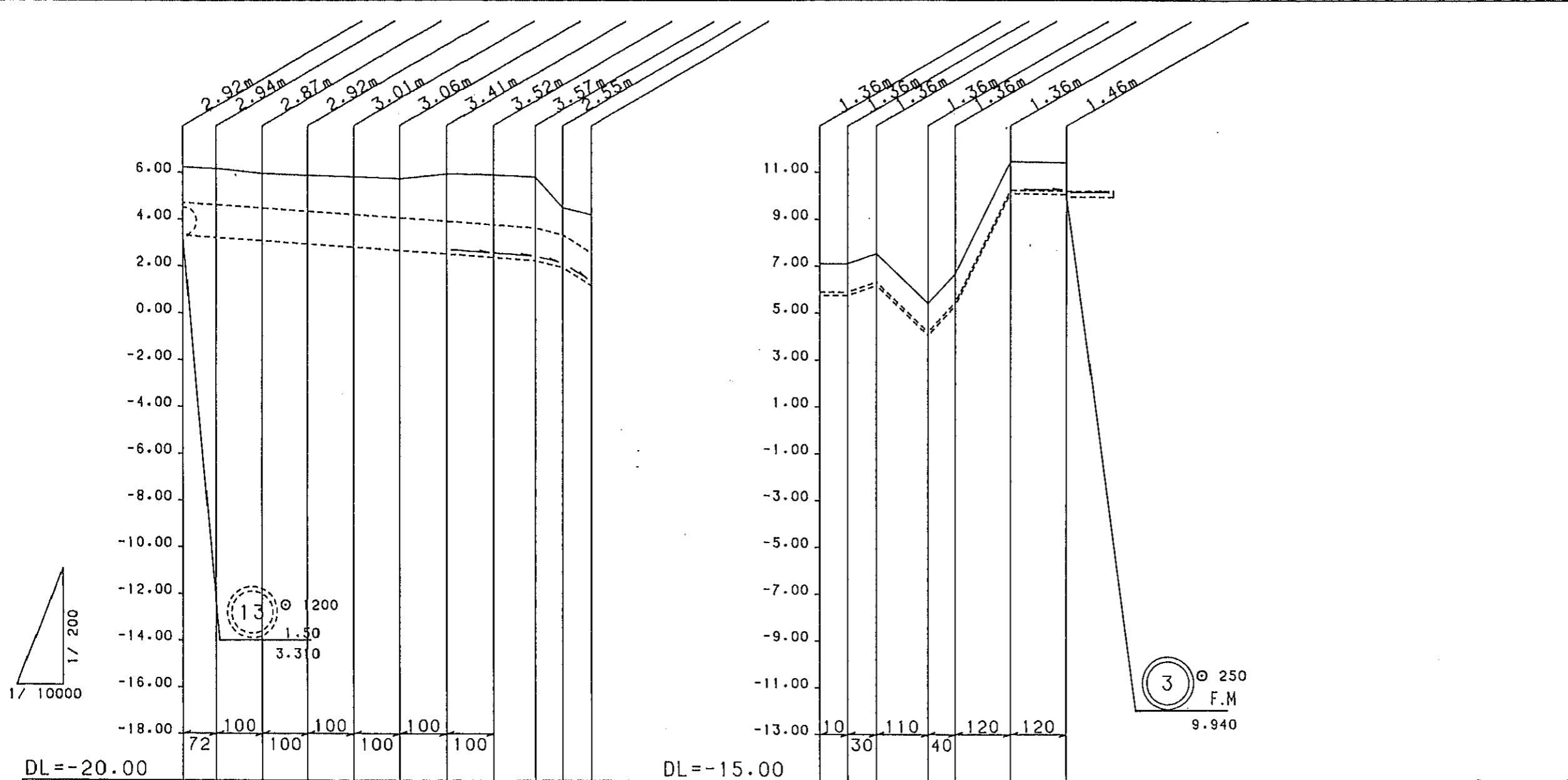

2	14	15	16
17			

Sewer Number	14										15			16		17		2						
Diameter (mm)	Ø 1400										Ø 1400			Ø 1400		Ø 1400		Ø 150						
Slope (%)	1.50										.40			12.60				F.M						
Length (m)	672										91			62		430								
Elevation (m) Grand Surface	6.23	6.15	5.93	5.84	5.78	5.69	5.90	5.86	5.78	4.48	4.19							7.10	7.10	7.53	5.40	6.67	11.44	11.40
Earth Covering (m)	1.41	1.43	1.36	1.41	1.49	1.55	1.90	2.01	2.06	1.04	1.59							1.20	1.20	1.20	1.20	1.20	1.20	1.20
Sewer Invert Elevation (m)	3.310	3.206	3.062	2.918	2.774	2.630	2.486	2.340	2.213	1.930	1.150							5.740	5.740	6.170	4.040	5.310	10.080	10.040
Total Length (m)	4917	4989	5089	5189	5289	5389	5489	5589	5680	5737	5799							0	10	40	150	190	310	430

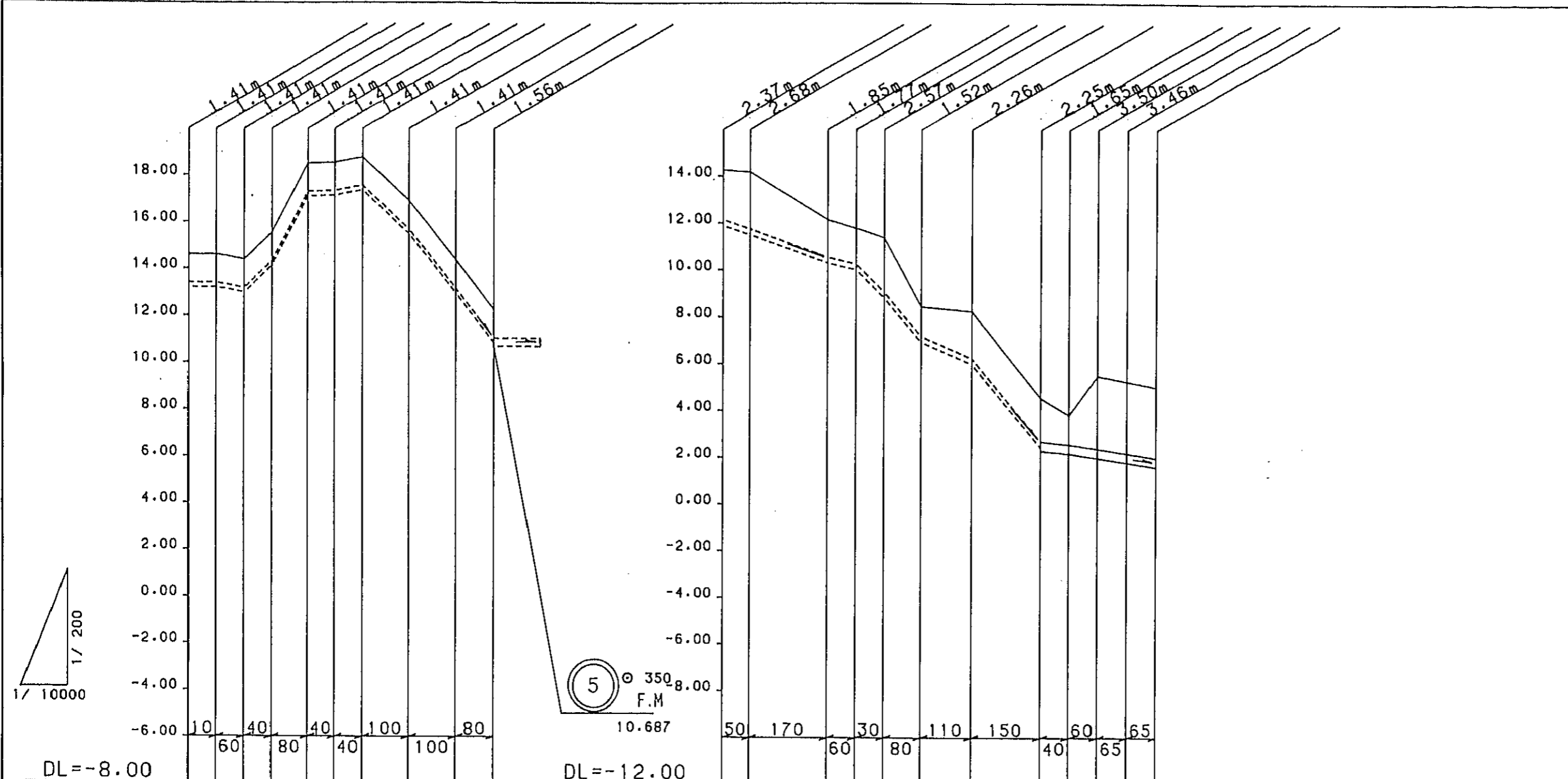

4	18	19	20

DL = -8.00									DL = -12.00													
Sewer Number	4								18		19		20									
Diameter (mm)	Ø 200								Ø 250		Ø 250		Ø 400									
Slope (%)	F.M								5.00		5.00		3.00									
Length (m)	550								220		430		230									
Elevation (m)																						
Grand Surface	14.60	14.60	14.38	15.52	18.48	18.52	18.75	16.88	14.36	12.25	14.25	14.17	12.13	11.76	11.36	8.41	8.22	4.53	3.81	5.48	5.24	5.00
Earth Covering (m)	1.20	1.20	1.20	1.20	1.20	1.20	1.20	1.20	1.20	1.20	2.09	2.40	1.57	1.49	2.29	1.24	1.98	1.82	1.22	3.07	3.02	2.98
Sewer Invert Elevation (m)	13.190	13.190	12.970	14.110	17.070	17.110	17.340	15.470	12.950	10.840	11.880	11.490	10.280	9.990	8.790	6.890	5.960	2.430	2.160	1.980	1.785	1.590
Total Length (m)	0	10	70	110	190	230	270	370	470	550	0	50	220	280	310	390	500	650	690	750	815	880

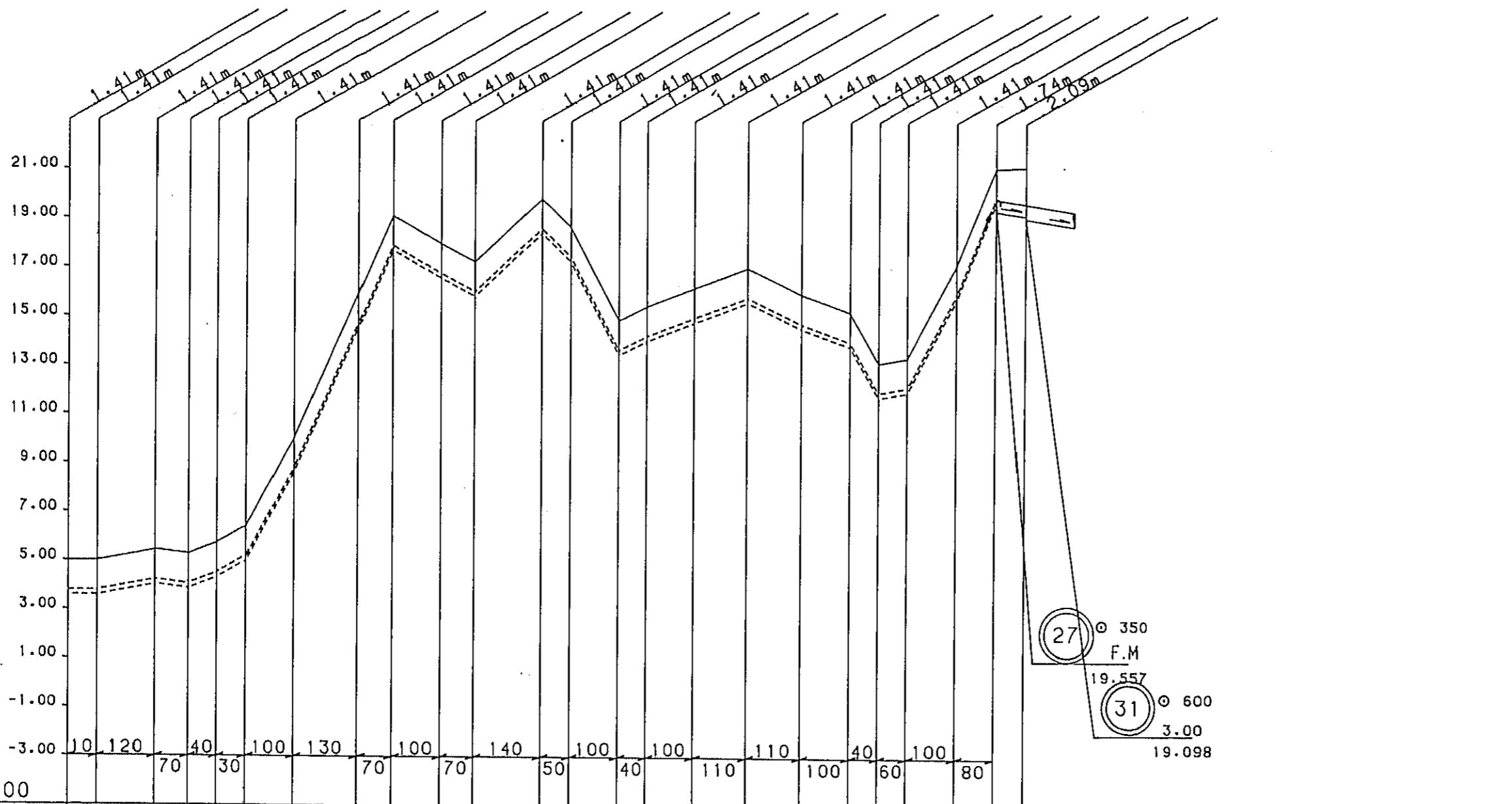
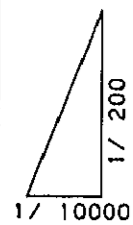

\odot 21	\odot 28		

Sewer Number	\odot 21																	\odot 28						
Diameter (mm)	\odot 200																	\odot 500						
Slope (%)	F.M																	3.00						
Length (m)	1770																	60						
Elevation (m) Grand Surface	5.00	5.00	5.44	5.27	5.73	6.40	10.01	15.91	19.09	17.96	17.24	19.81	18.66	14.87	15.44	16.18	17.00	15.93	15.21	13.15	13.37	17.16	21.12	21.19
Earth Covering (m)	1.20	1.20	1.20	1.20	1.20	1.20	1.20	1.20	1.20	1.20	1.20	1.20	1.20	1.20	1.20	1.20	1.20	1.20	1.20	1.20	1.20	1.20	1.20	1.45
Sewer Invert Elevation (m)	3.590	3.590	4.030	3.860	4.320	4.990	8.600	14.500	17.680	16.550	15.830	18.400	17.250	13.460	14.030	14.770	15.590	14.520	13.800	11.740	11.960	15.750	19.710	19.378
Total Length (m)	0	10	130	200	240	270	370	500	570	670	740	880	930	1030	1070	1170	1280	1390	1490	1530	1590	1690	1770	1830

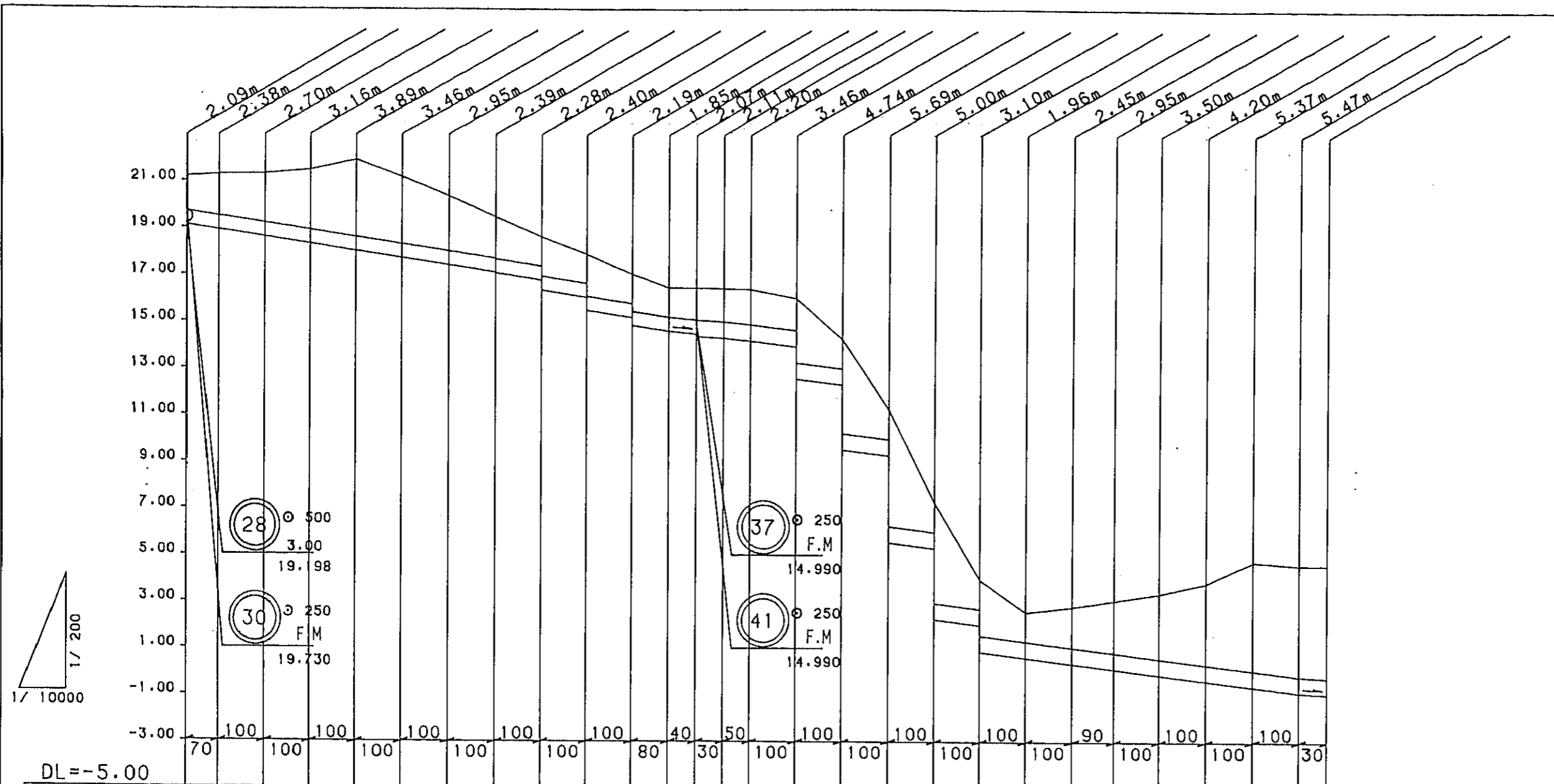

31	42		

Sewer Number	31										42																									
Diameter (mm)	Ø 600										Ø 700																									
Slope (%)	3.00										2.50																									
Length (m)	1090										1300																									
Elevation (m) Grand Surface	21.19	21.27	21.29	21.45	21.88	21.15	20.34	19.45	18.61	17.88	17.03	16.45	16.45	16.42	16.38	16.00	14.25	11.22	7.24	3.95	2.56	2.80	3.08	3.38	3.83	4.75	4.60	4.60								
Earth Covering (m)	1.44	1.73	2.05	2.51	3.24	2.81	2.30	1.71	1.63	1.20	1.54	1.20	1.32	1.36	1.44	1.31	3.20	4.93	4.24	2.34	1.20	1.69	2.20	2.75	3.45	4.62	4.72	4.79								
Sewer Invert Elevation (m)	19.098	18.888	18.588	18.288	17.988	17.688	17.388	17.088	16.760	16.530	16.030	15.480	15.180	14.840	14.600	14.380	14.305	14.180	12.930	12.542	12.292	9.512	9.262	5.532	5.282	2.242	1.992	0.852	0.602	0.352	0.127	-0.123	-0.373	-0.623	-0.873	-0.948
Total Length (m)	1830	1900	2000	2100	2200	2300	2400	2500	2600	2700	2800	2880	2920	2950	3000	3100	3200	3300	3400	3500	3600	3700	3790	3890	3990	4090	4190	4220								

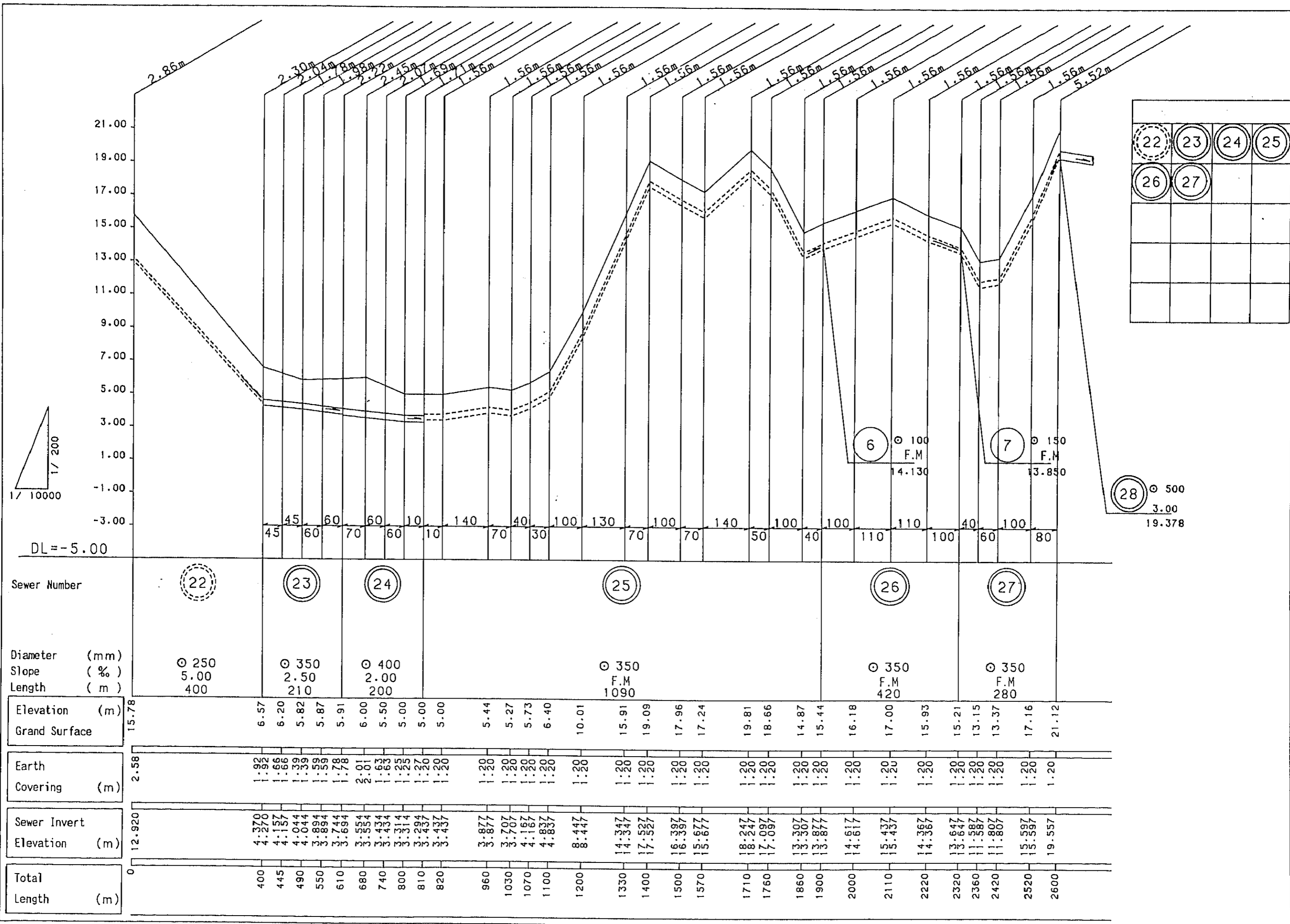

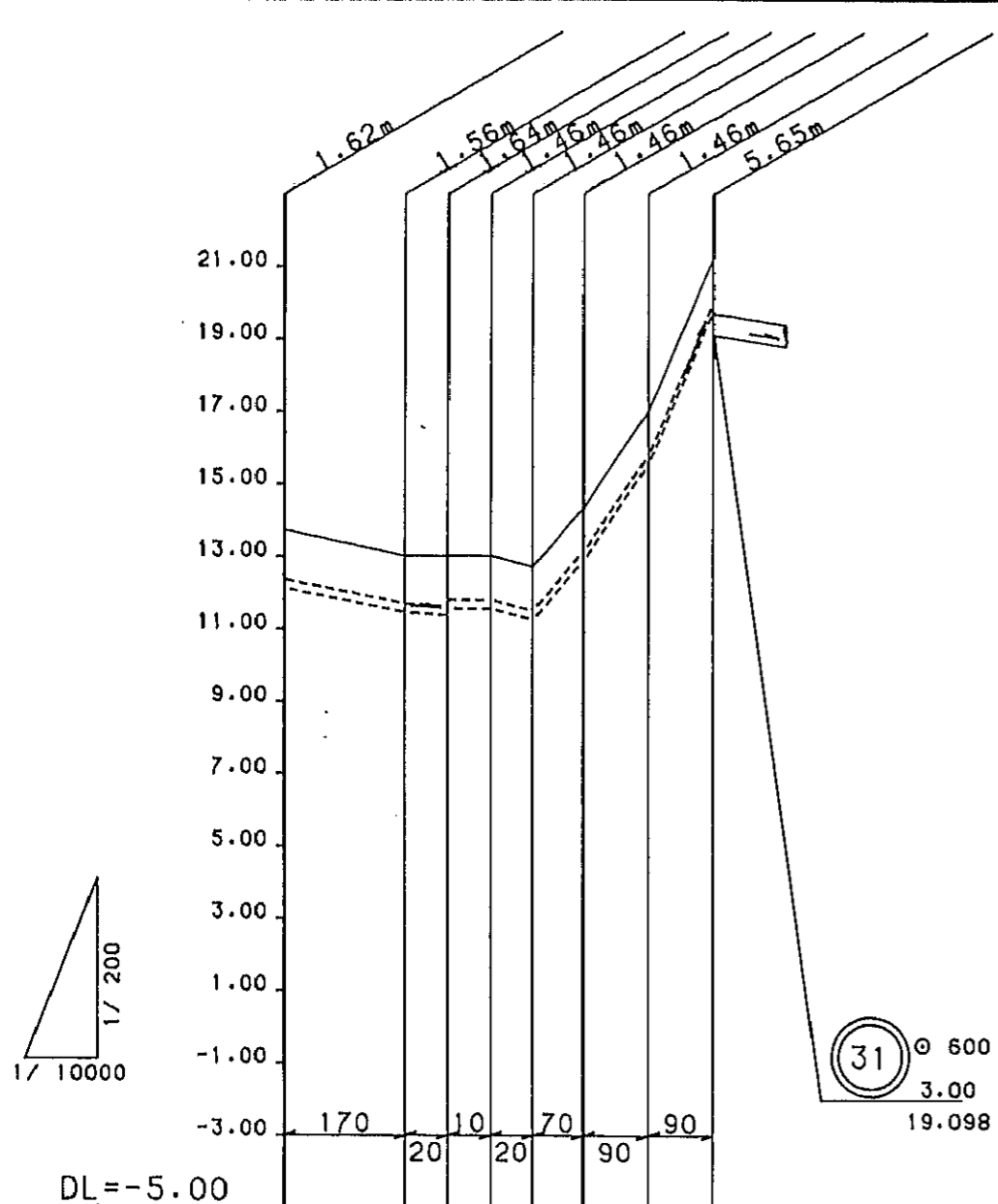

	29	30		

Sewer Number	29		30					
Diameter (mm)	Ø 250		Ø 250					
Slope (%)	3.90		F.M					
Length (m)	190		280					
Elevation (m)	13.73	13.00	13.00	13.00	12.70	14.33	17.00	21.19
Grand Surface								
Earth Covering (m)	1.34	1.28	1.36	1.20	1.20	1.20	1.20	1.20
Sewer Invert Elevation (m)	12.110	11.440	11.361	11.540	11.540	11.240	12.870	15.540
Total Length (m)	0	170	190	200	220	290	380	470

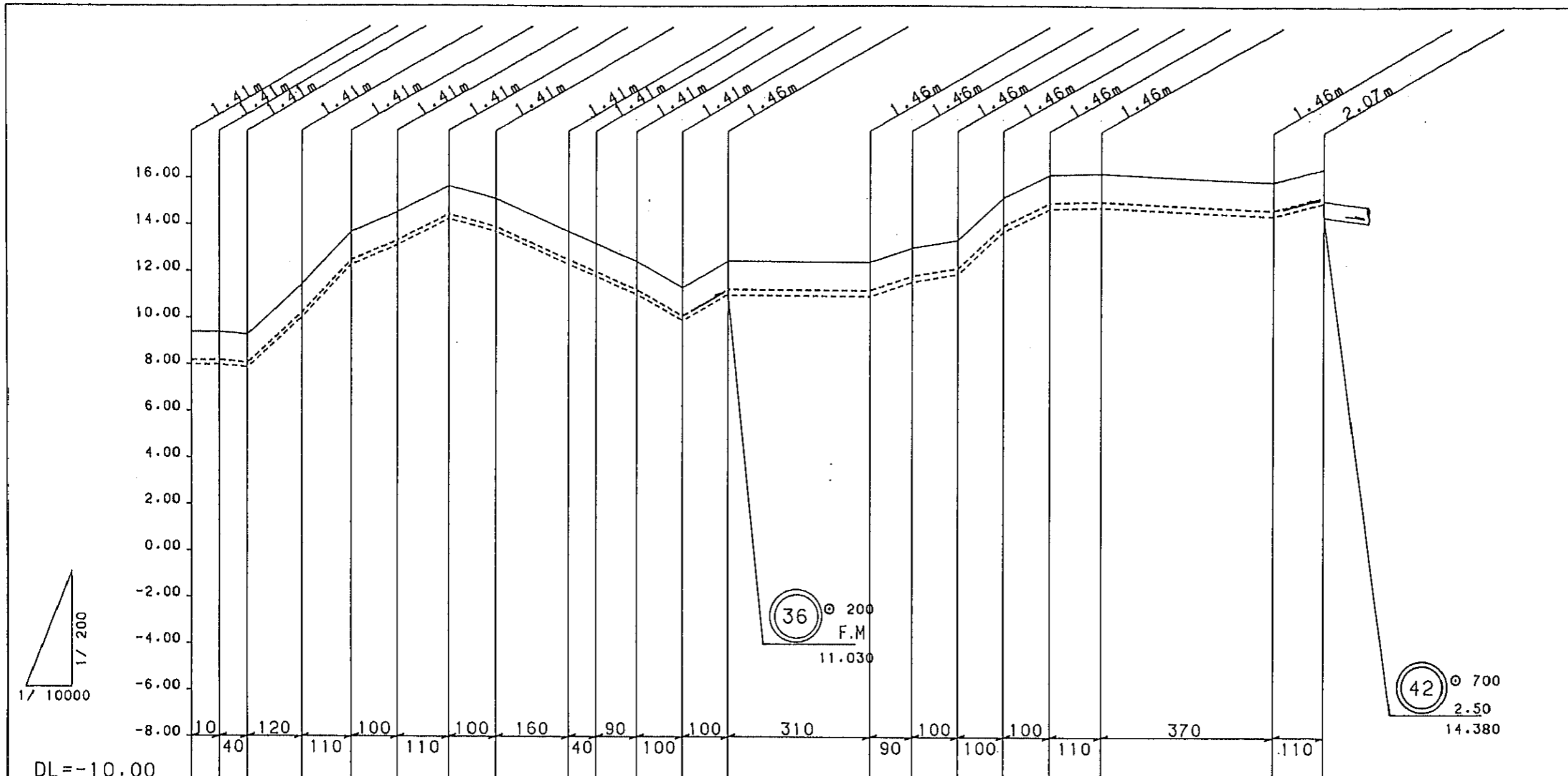

32	37		

Sewer Number	32										37										
Diameter (mm)	ϕ 200										ϕ 250										
Slope (%)	F.M										F.M										
Length (m)	1080										1290										
Elevation (m) Grand Surface	9.38	9.38	9.26	11.40	13.66	14.50	15.62	15.09	13.69	13.18	12.42	11.30	12.44	12.37	12.98	13.31	15.14	16.13	16.20	15.88	16.45
Earth Covering (m)	1.20	1.20	1.20	1.20	1.20	1.20	1.20	1.20	1.20	1.20	1.20	1.20	1.20	1.20	1.20	1.20	1.20	1.20	1.20	1.20	1.20
Sewer Invert Elevation (m)	7.970	7.970	7.850	9.990	12.250	13.090	14.210	13.680	12.280	11.770	11.010	9.890	10.980	10.910	11.520	11.850	13.680	14.670	14.740	14.420	14.990
Total Length (m)	0	10	50	170	280	380	490	590	750	790	880	980	1080	1390	1480	1580	1680	1780	1890	2260	2370

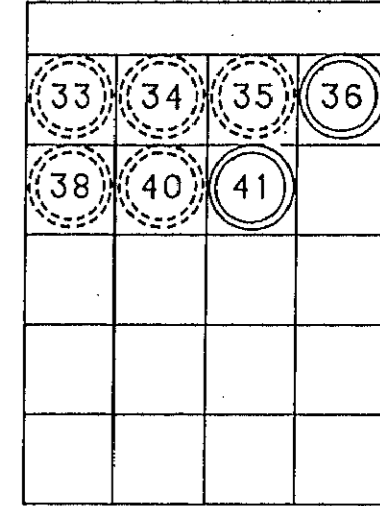
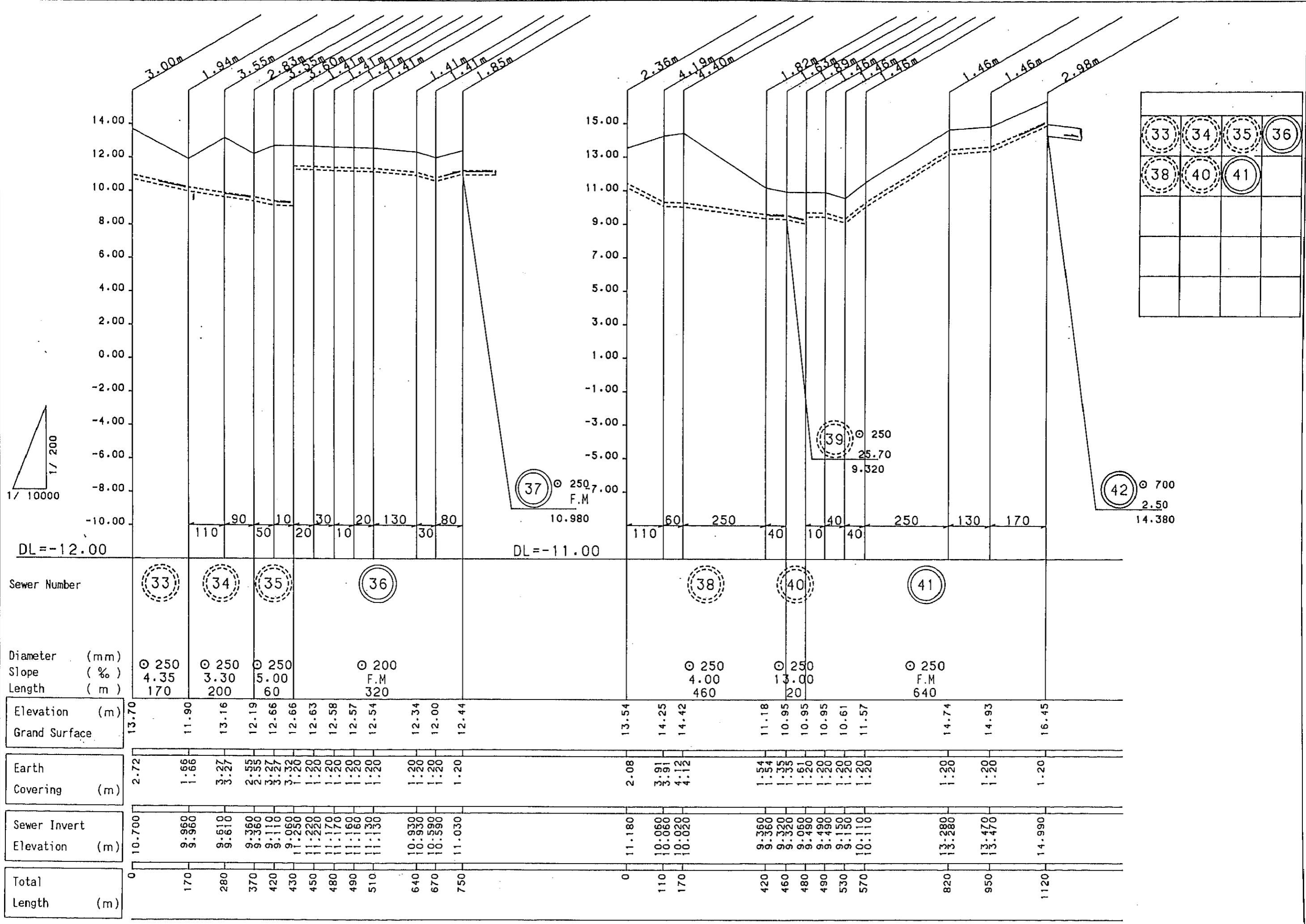

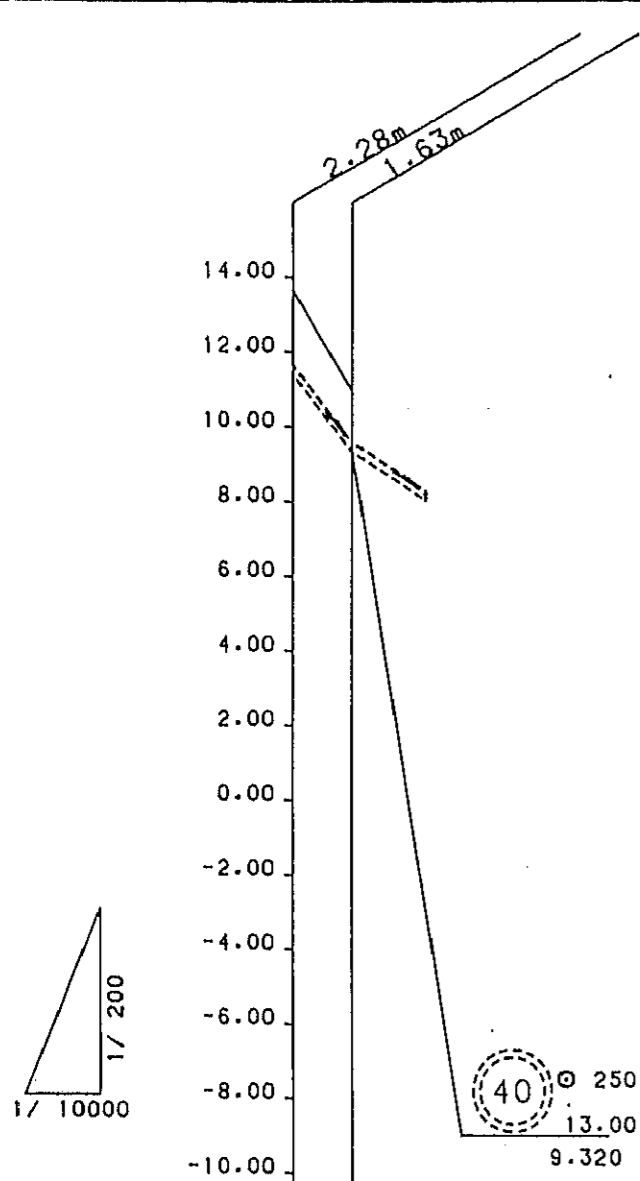

39			

Sewer Number 39

Diameter (mm) 250

Slope (%) 25.70

Length (m) 80

Elevation (m)	13.66	10.95
Grand Surface		
Earth Covering (m)	2.00	1.35
Sewer Invert Elevation (m)	11.380	9.320
Total Length (m)	0	80