

GENERAL PLAN s-1/7,000

SITE PLAN	DRWG. NO.
全体配置図	1

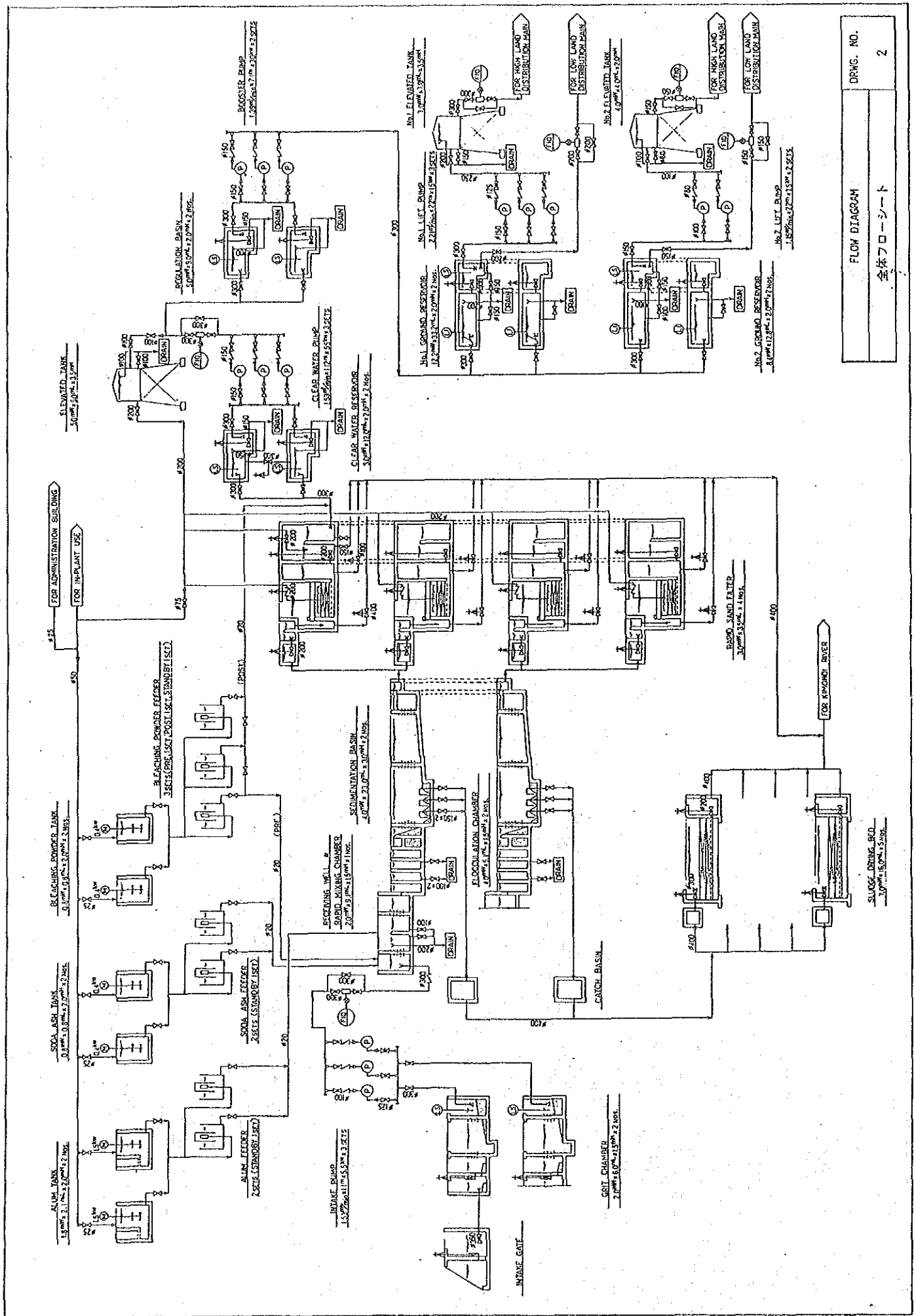

FLOW DIAGRAM
 全体フローシート

DRWG. NO.
 2

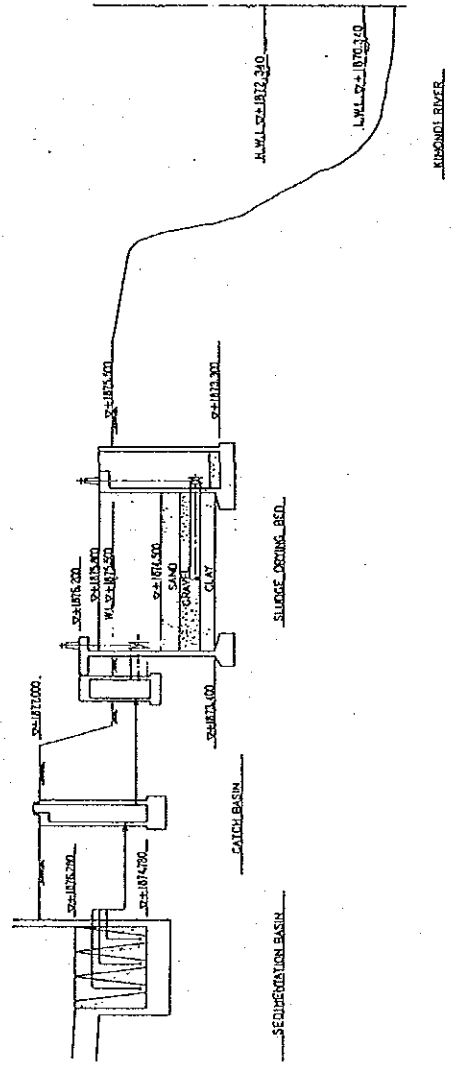
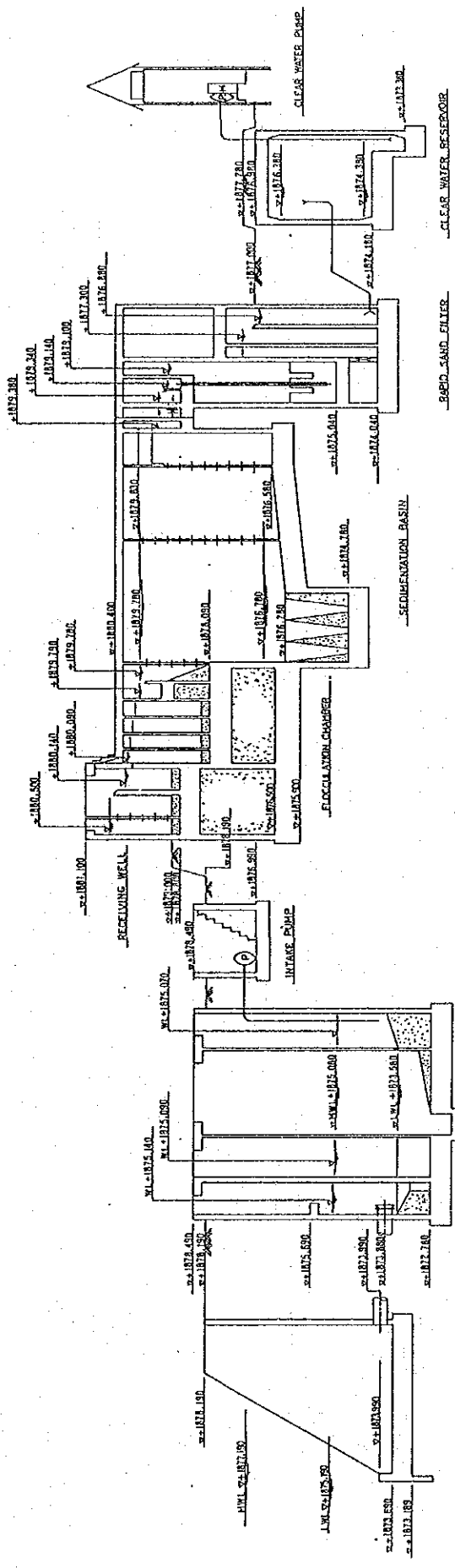

HYDRAULIC PROFILE	DRWG. NO.
水位高线图	3

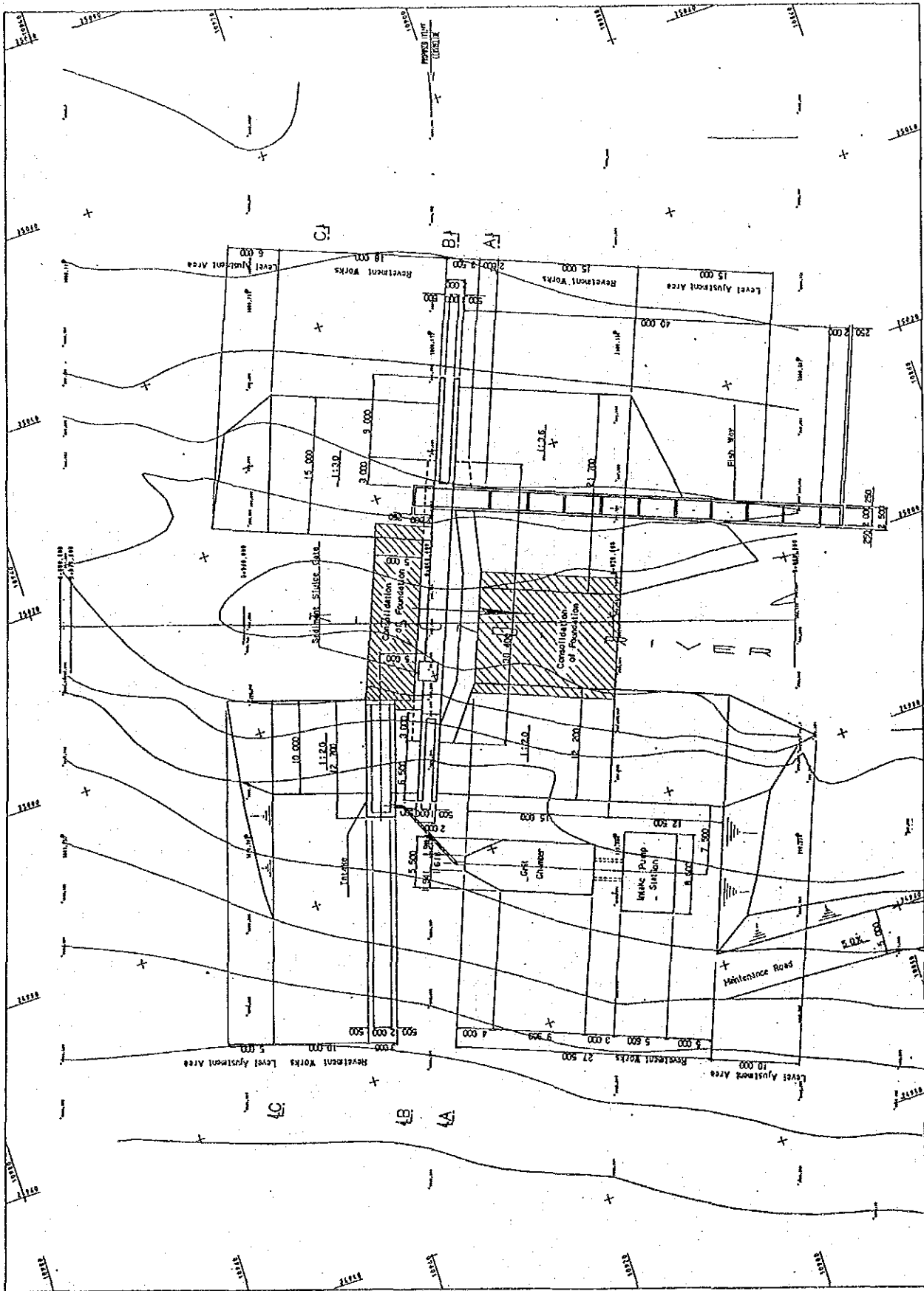

INTAKE FACILITIES - PLOT PLAN
取水施設一般平面図

DRWG. NO. 4

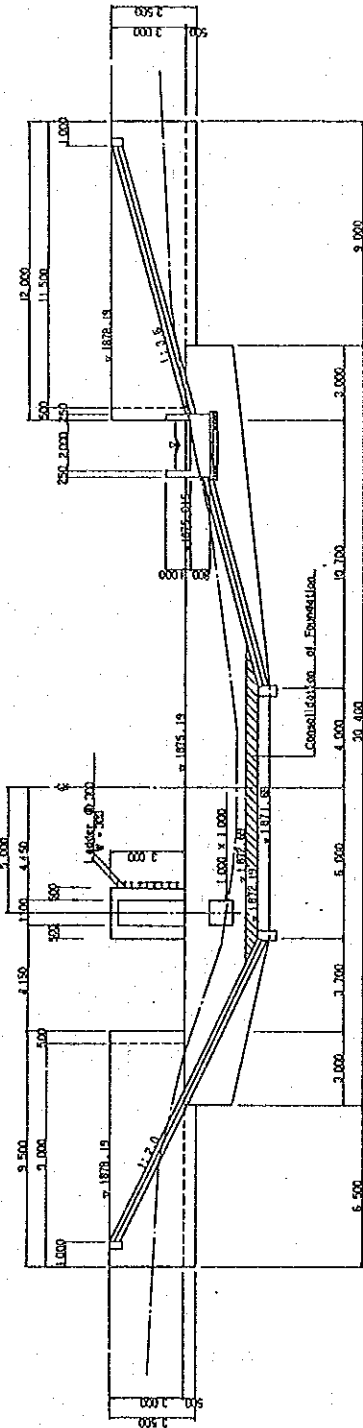

Section A-A Scale 1:100

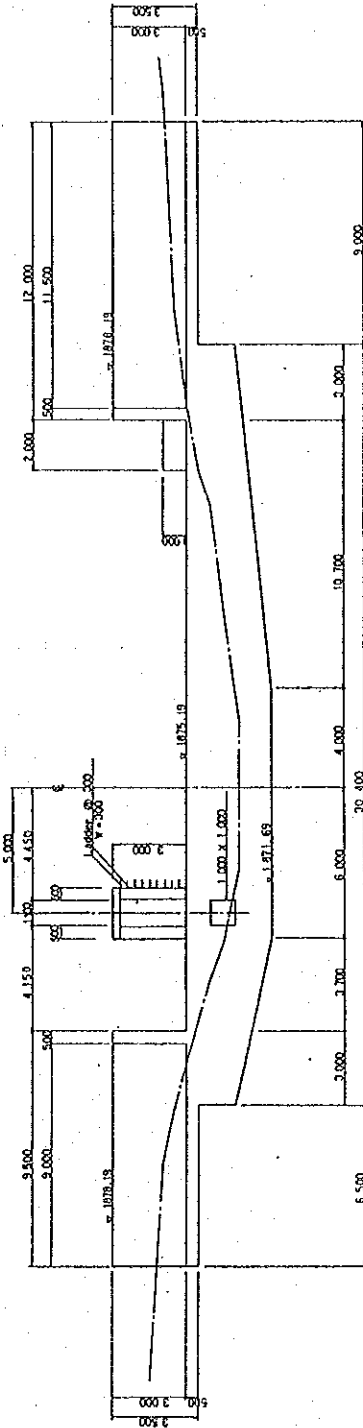

Section B-B Scale 1:100

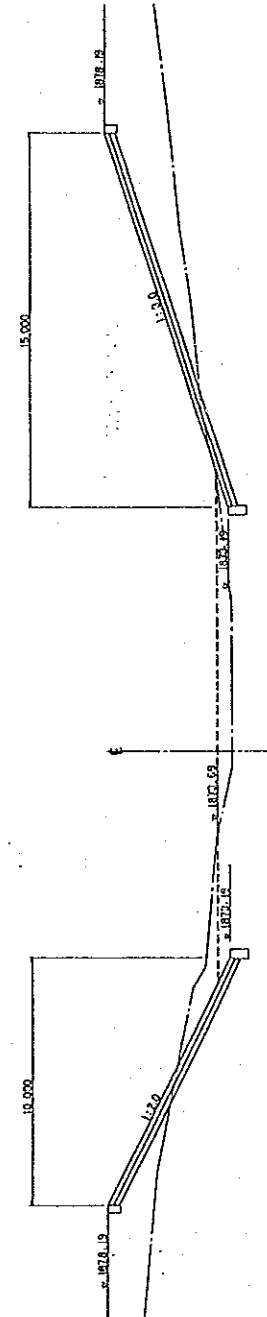

Section C-C Scale 1:100

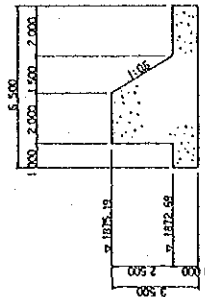

Weir Section Scale 1:100

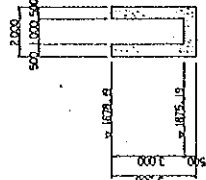

Retaining Wall Section Scale 1:100

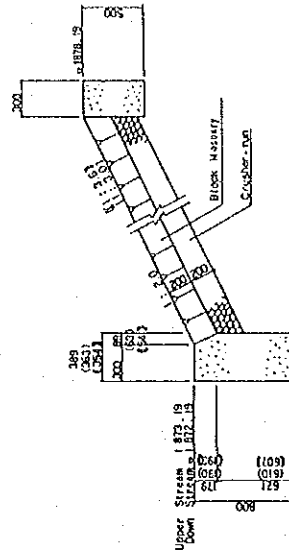

Revetment Works Structure Scale 1:20

INTAKE WEIR	取水堰	DRWG. NO.	5
-------------	-----	-----------	---

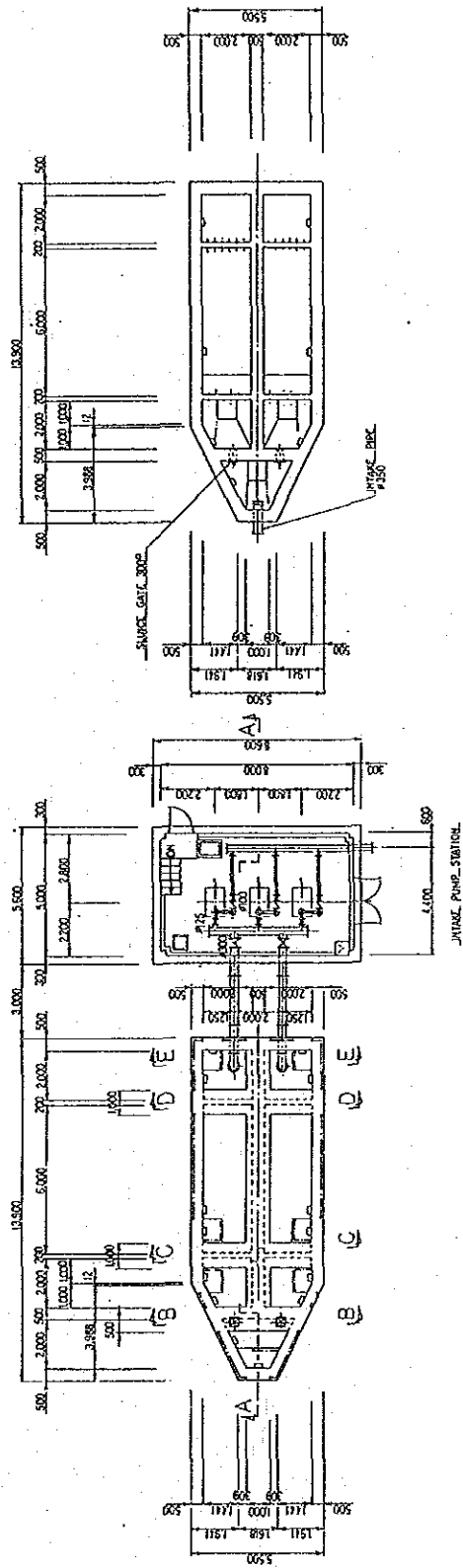

PLAN OF GRIT CHAMBER
SCALE 1:100

BOTTOM PLAN
SCALE 1:100

GRIT CHAMBER & INTAKE PUMP STATION (1)	DRWG. NO.
沈砂池・取水ポンプ棟 (その1)	7

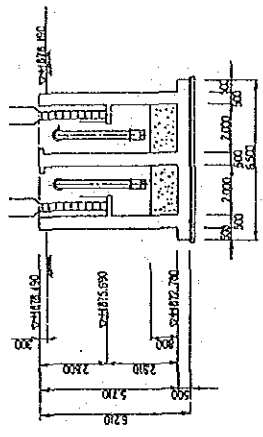
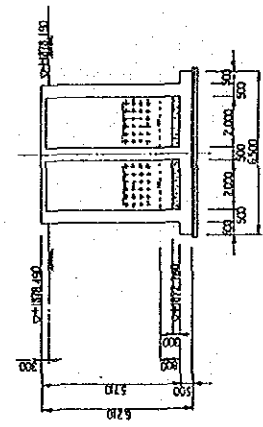
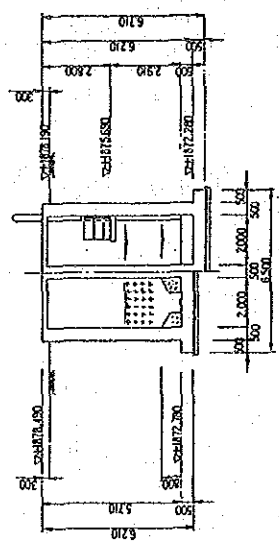
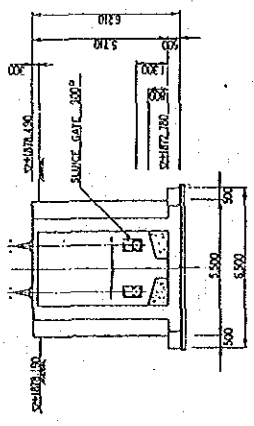
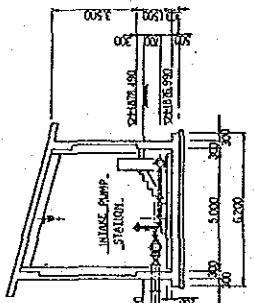
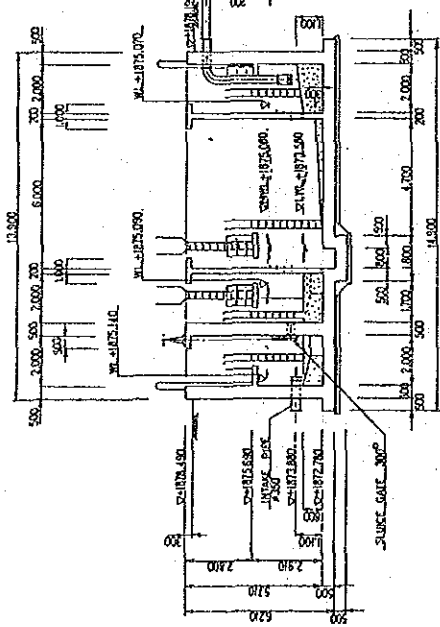

GRIT CHAMBER & INTAKE PUMP STATION (2)	DRWG. NO.
沈砂池・取水ポンプ棟 (その2)	8

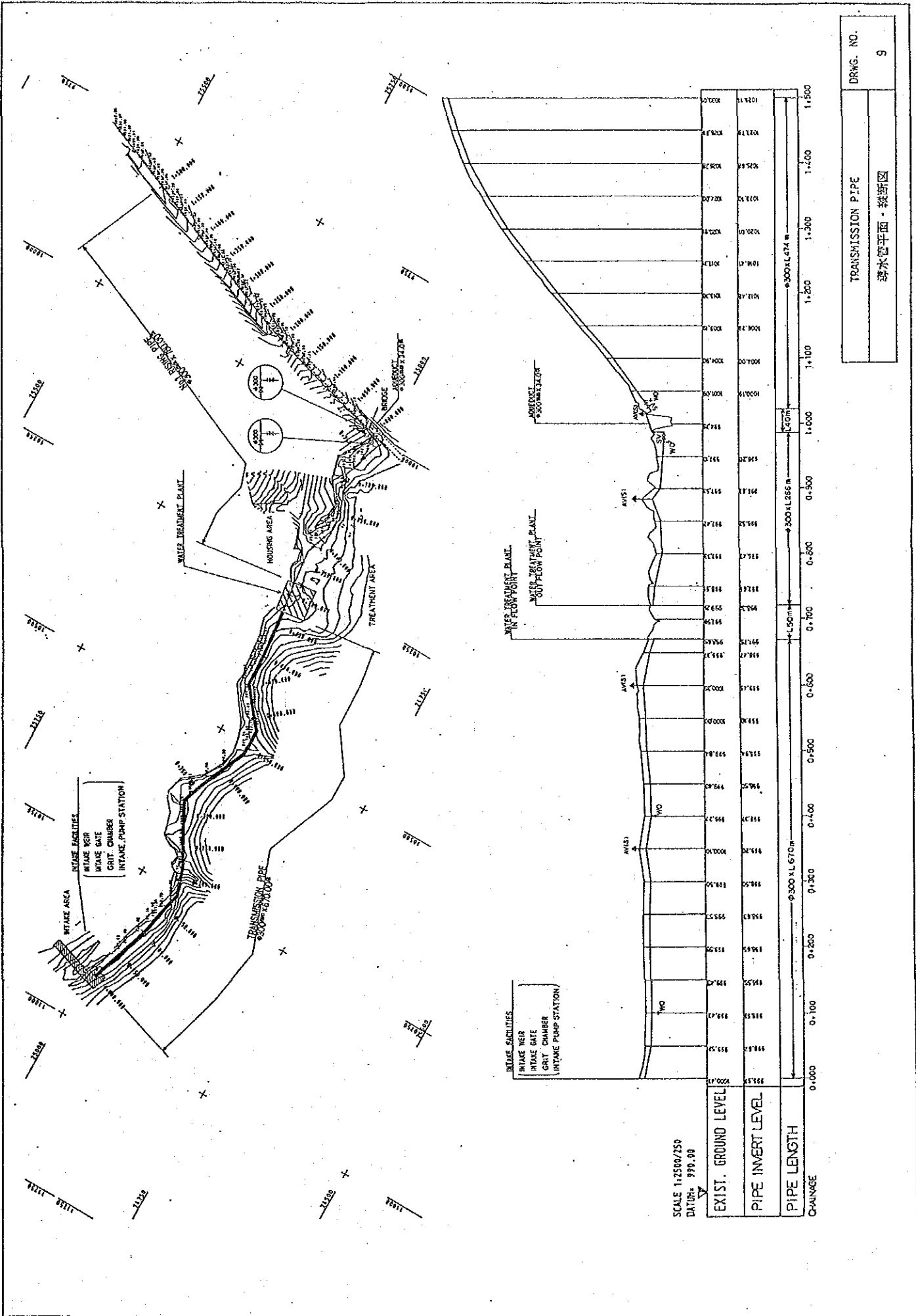

TRANSMISSION PIPE
 透水管平面 - 縱断面
 DRWG. NO. 9

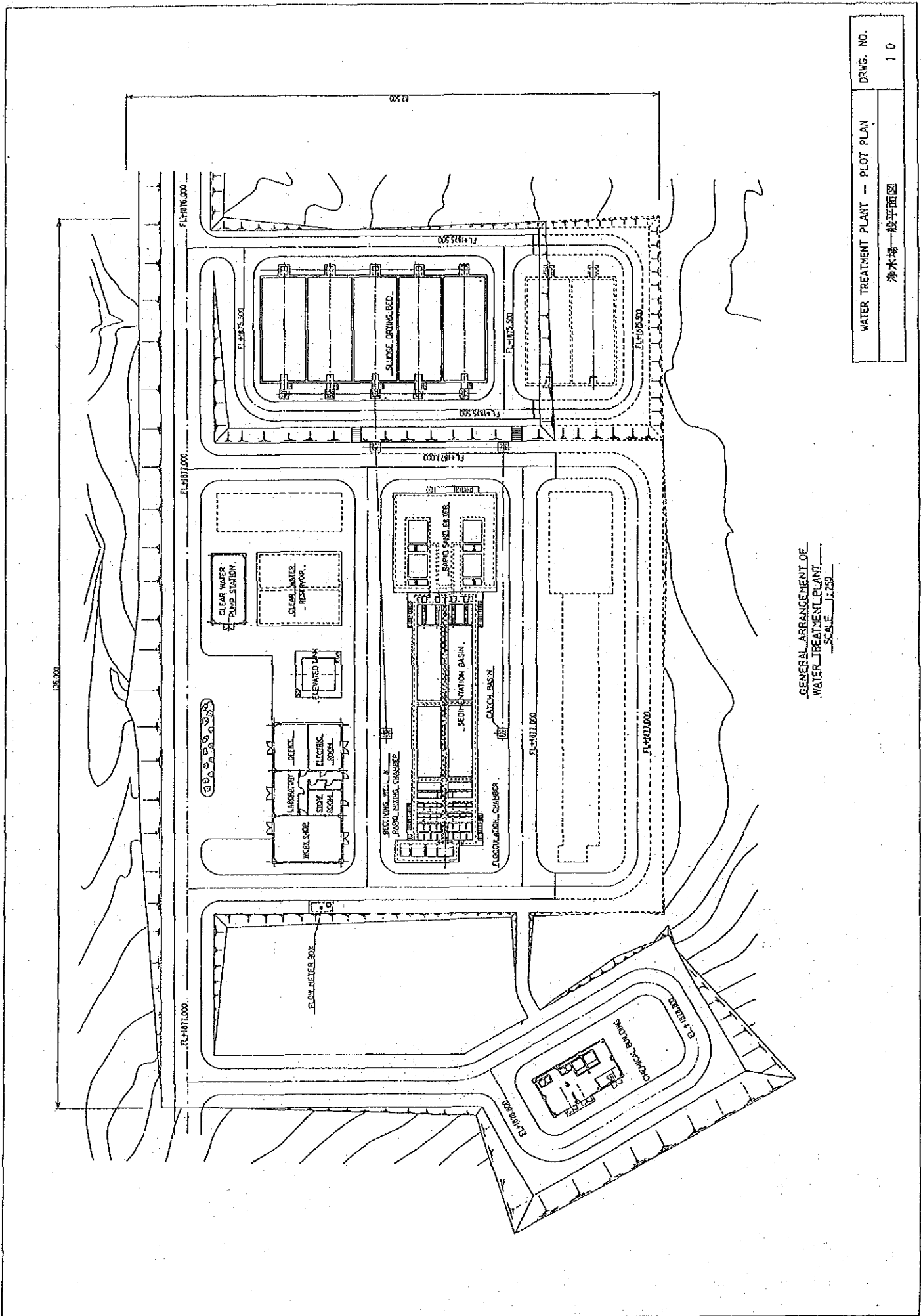

GENERAL ARRANGEMENT OF
WATER TREATMENT PLANT
SCALE 1:250

WATER TREATMENT PLANT — PLOT PLAN	DRWG. NO.
浄水場一般平面図	10

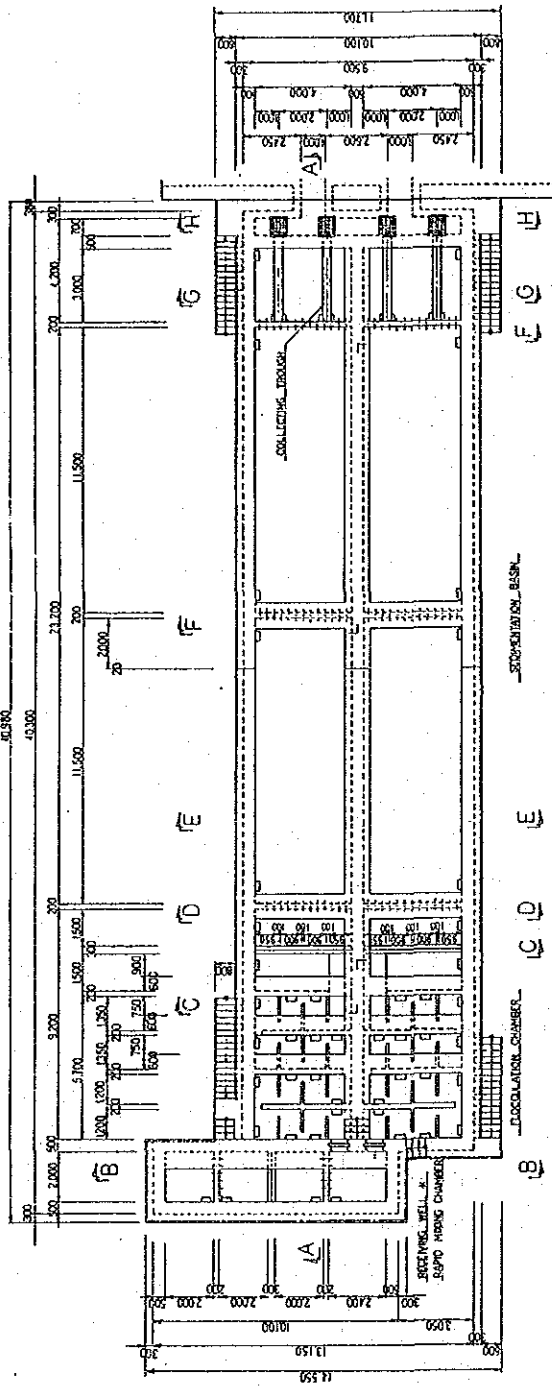

PLAN OF SEDIMENTATION BASIN
SCALE 1:100

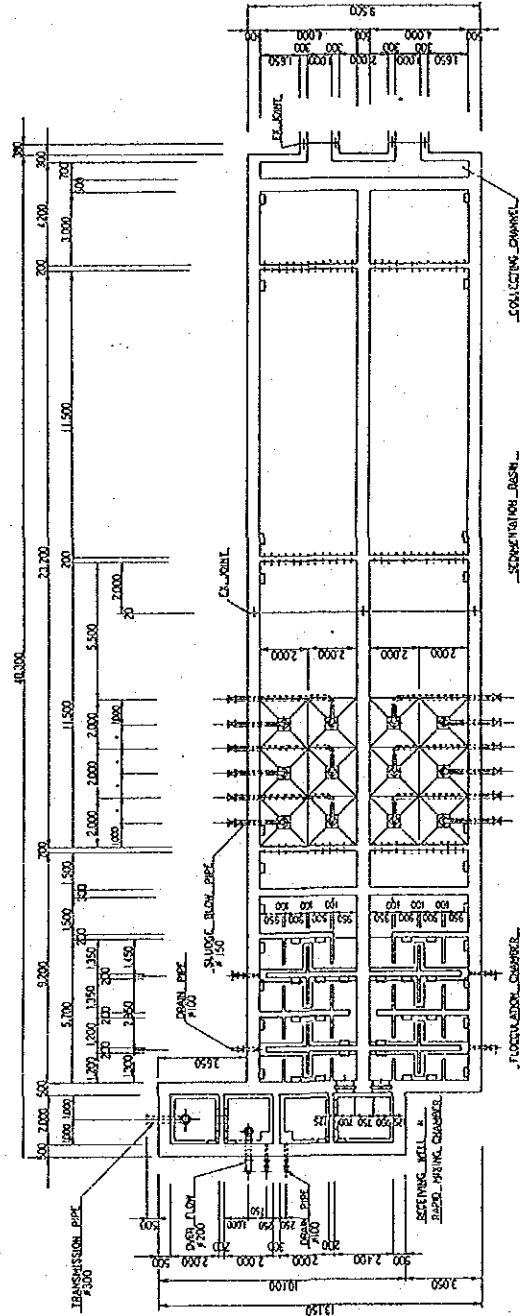

SECTION PLAN
SCALE 1:100

COAGULATION & SEDIMENTATION BASIN (1)	DRWG. NO.
凝集・沈殿池(その1)	11

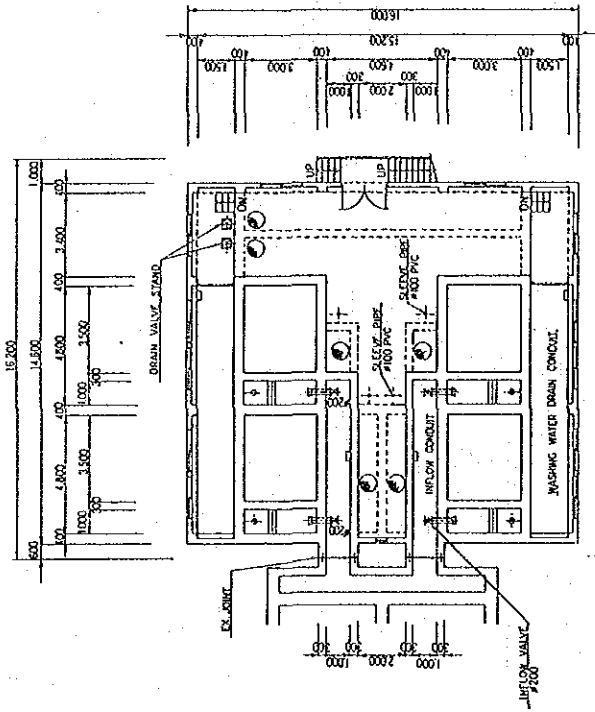

BOTTOM PLAN
SCALE 1:100

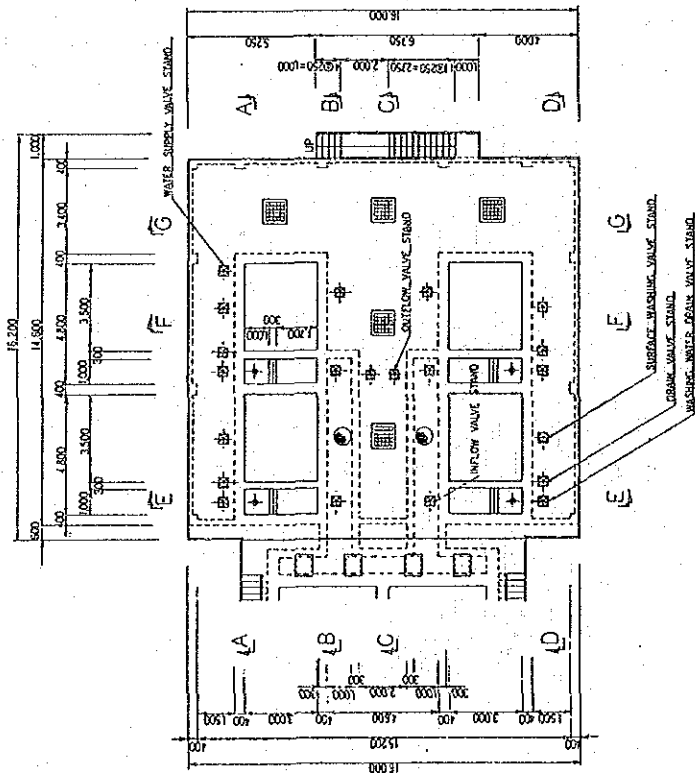

PLAN OF RAPID SAND FILTER
SCALE 1:100

RAPID SAND FILTER (1)	DRWG. NO.
急速ろ過池 (その1)	14

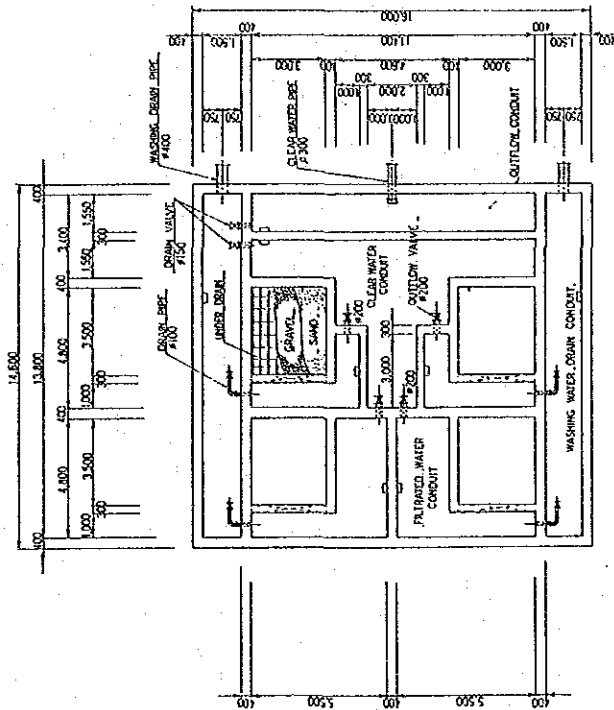

BOTTOM PLAN SCALE: 1:100

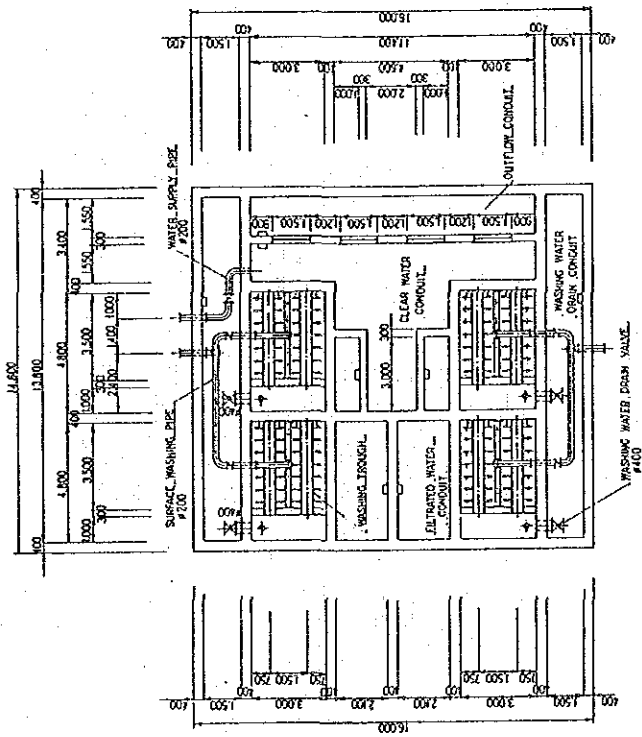

BOTTOM PLAN SCALE: 1:100

RAPID SAND FILTER (2)	DRWG. NO.
急速ろ過池 (その2)	15

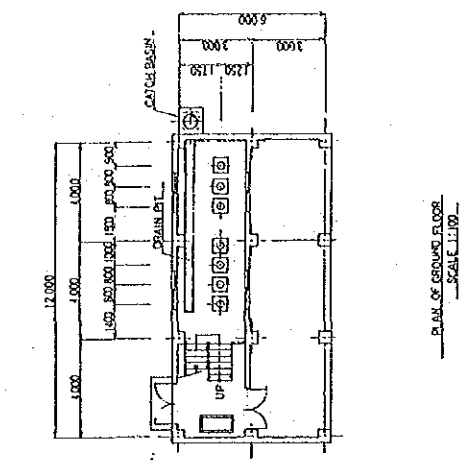

PLAN OF GROUND FLOOR
SCALE 1:100

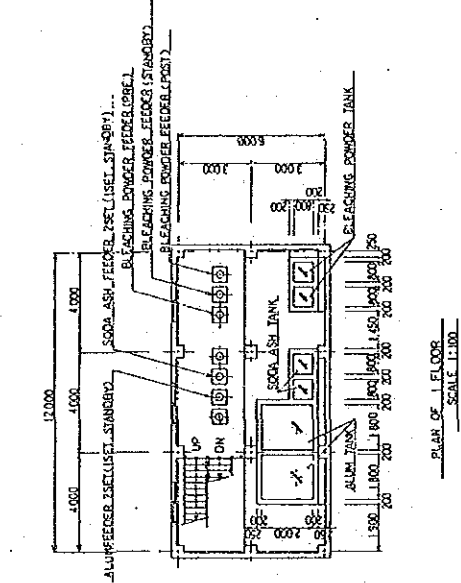

PLAN OF 1 FLOOR
SCALE 1:100

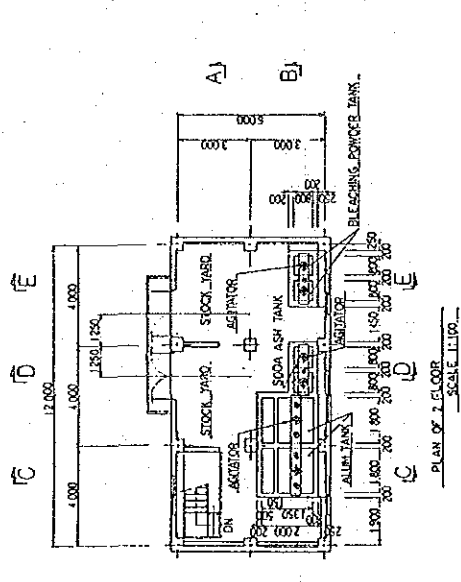

PLAN OF 2 FLOOR
SCALE 1:100

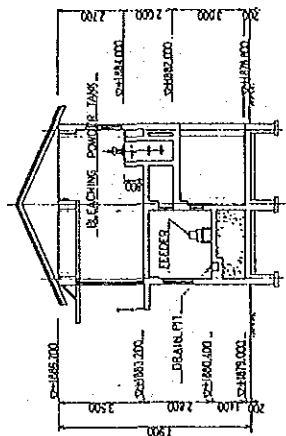

SECTION E-E
SCALE 1:100

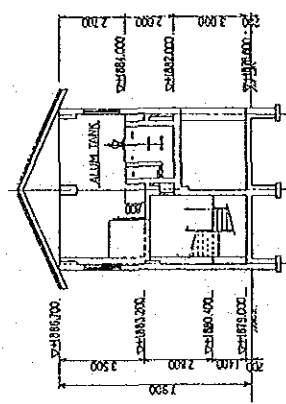

SECTION C-C
SCALE 1:100

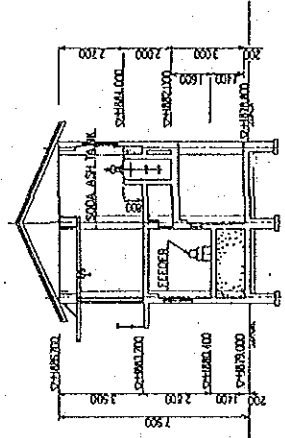

SECTION D-D
SCALE 1:100

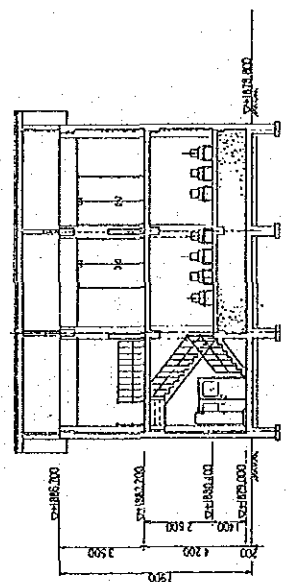

SECTION A-A
SCALE 1:100

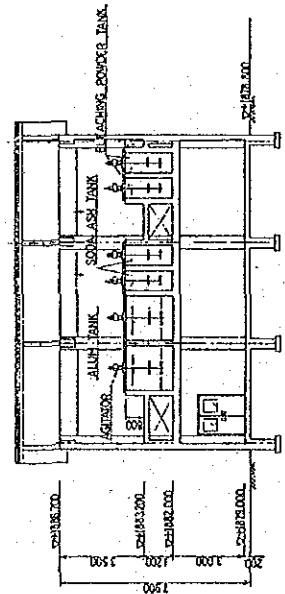

SECTION B-B
SCALE 1:100

CHEMICAL BUILDING	DRWG. NO.
茶注棟	22

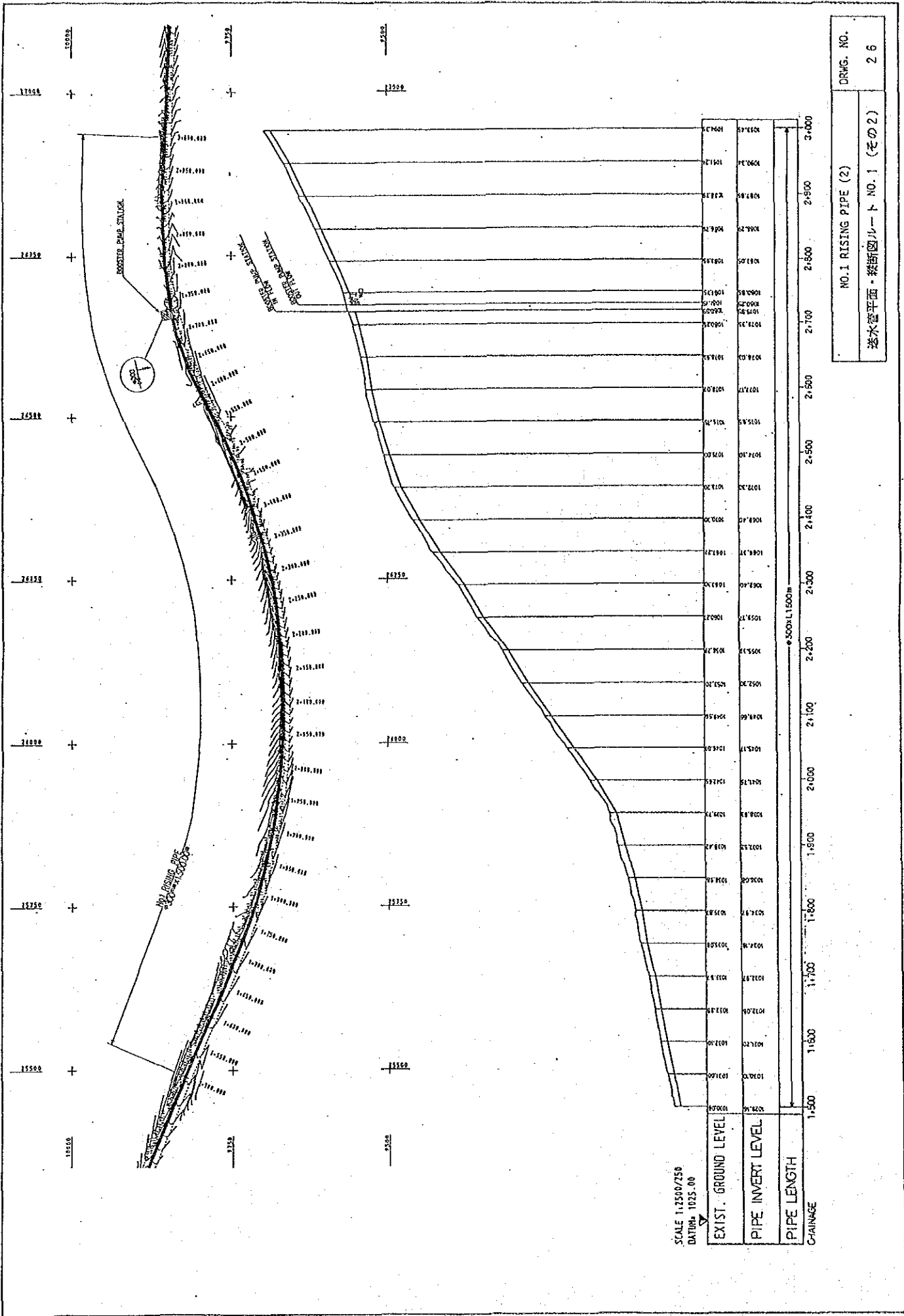

DRWG. NO.
 NO. 1 RISING PIPE (2)
 透水管平面・縦断図ルート NO. 1 (その 2)
 2 6

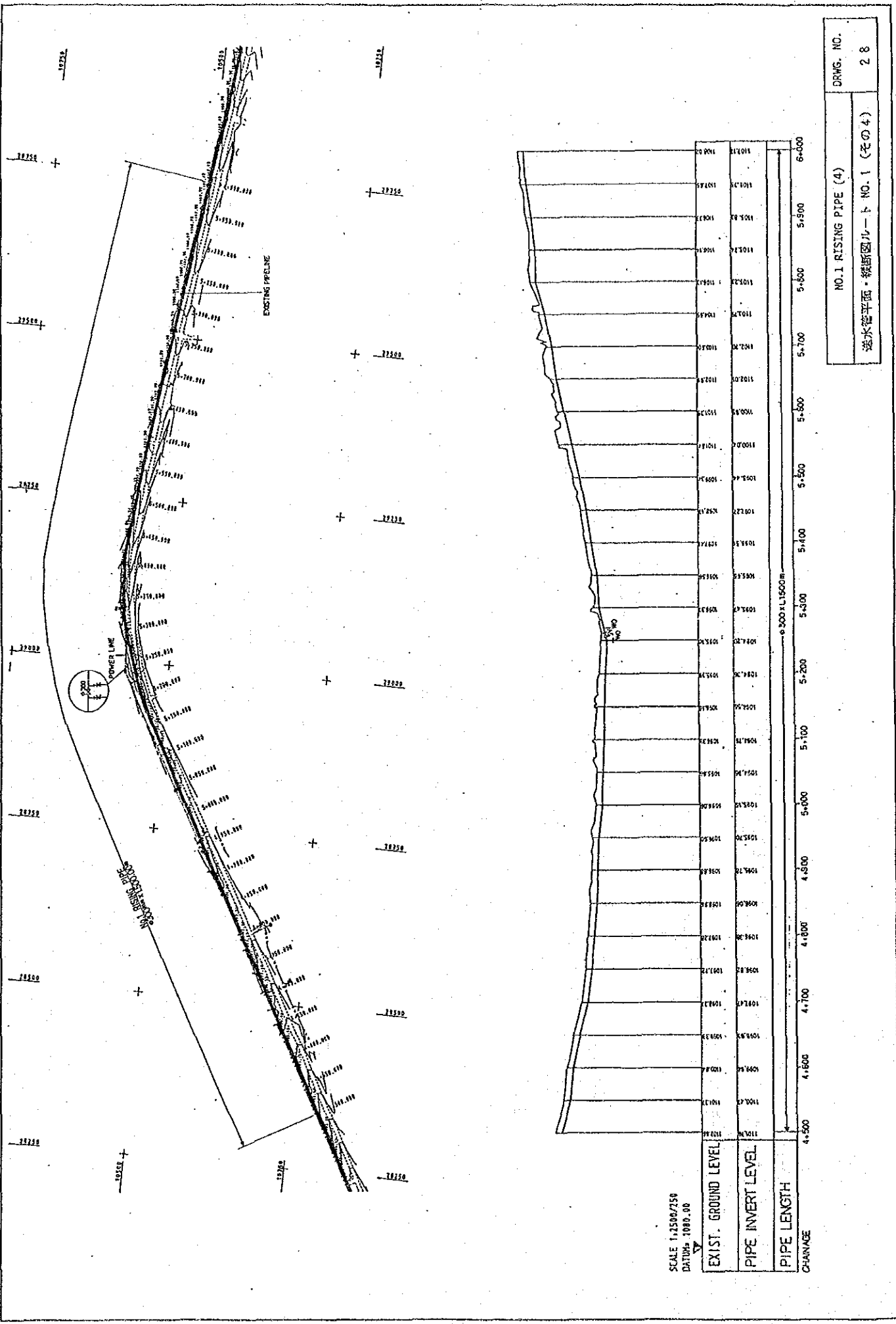

SCALE 1:2500/250
 DATUM: 1000.00

EXIST. GROUND LEVEL	PIPE INVERT LEVEL	PIPE LENGTH
102.70	102.70	0+000
102.70	102.70	0+100
102.70	102.70	0+200
102.70	102.70	0+300
102.70	102.70	0+400
102.70	102.70	0+500
102.70	102.70	0+600
102.70	102.70	0+700
102.70	102.70	0+800
102.70	102.70	0+900
102.70	102.70	1+000
102.70	102.70	1+100
102.70	102.70	1+200
102.70	102.70	1+300
102.70	102.70	1+400
102.70	102.70	1+500
102.70	102.70	1+600
102.70	102.70	1+700
102.70	102.70	1+800
102.70	102.70	1+900
102.70	102.70	2+000
102.70	102.70	2+100
102.70	102.70	2+200
102.70	102.70	2+300
102.70	102.70	2+400
102.70	102.70	2+500
102.70	102.70	2+600
102.70	102.70	2+700
102.70	102.70	2+800
102.70	102.70	2+900
102.70	102.70	3+000
102.70	102.70	3+100
102.70	102.70	3+200
102.70	102.70	3+300
102.70	102.70	3+400
102.70	102.70	3+500
102.70	102.70	3+600
102.70	102.70	3+700
102.70	102.70	3+800
102.70	102.70	3+900
102.70	102.70	4+000
102.70	102.70	4+100
102.70	102.70	4+200
102.70	102.70	4+300
102.70	102.70	4+400
102.70	102.70	4+500
102.70	102.70	4+600
102.70	102.70	4+700
102.70	102.70	4+800
102.70	102.70	4+900
102.70	102.70	5+000
102.70	102.70	5+100
102.70	102.70	5+200
102.70	102.70	5+300
102.70	102.70	5+400
102.70	102.70	5+500
102.70	102.70	5+600
102.70	102.70	5+700
102.70	102.70	5+800
102.70	102.70	5+900
102.70	102.70	6+000

NO.1 RISING PIPE (4)
 送水管平面・縦断図ルート NO.1 (その4)
 DRWG. NO. 28

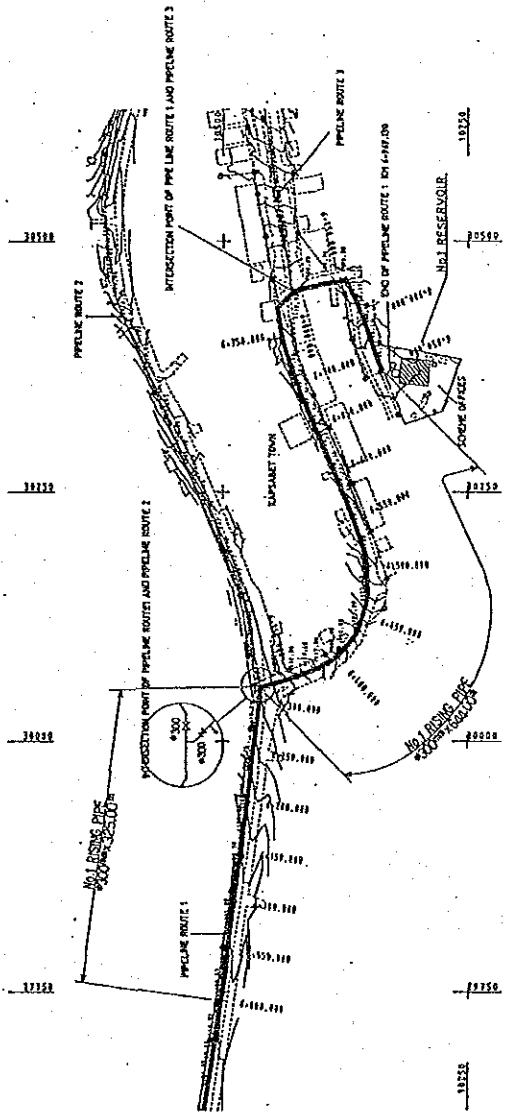

NOTE ONLY BUILDING FOOTPRINTS ACCURATELY SURVEYED

CHAINAGE	EXIST. GROUND LEVEL	PIPE INVERT LEVEL	PIPE LENGTH
6+000	1102.1	1080.1	22.0
6+100	1104.0	1082.0	22.0
6+200	1106.0	1084.0	22.0
6+300	1108.0	1086.0	22.0
6+400	1110.0	1088.0	22.0
6+500	1112.0	1090.0	22.0
6+600	1114.0	1092.0	22.0
6+700	1116.0	1094.0	22.0
6+800	1118.0	1096.0	22.0
6+900	1120.0	1098.0	22.0

SCALE 1:2500/250
DATE 11/08/00

NO.1 RISING PIPE (5)
 送水窓平面・縦断面ルート NO.1 (その5)
 DRWG. NO. 29

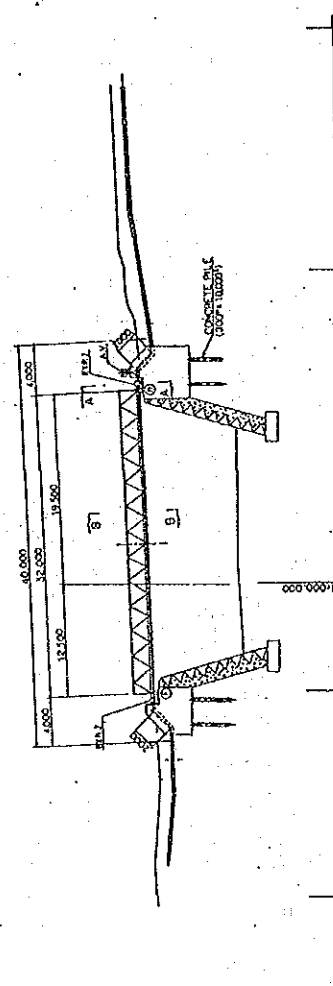
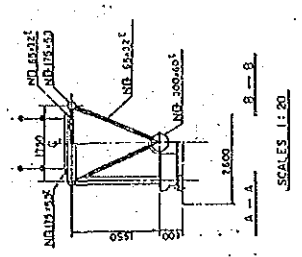
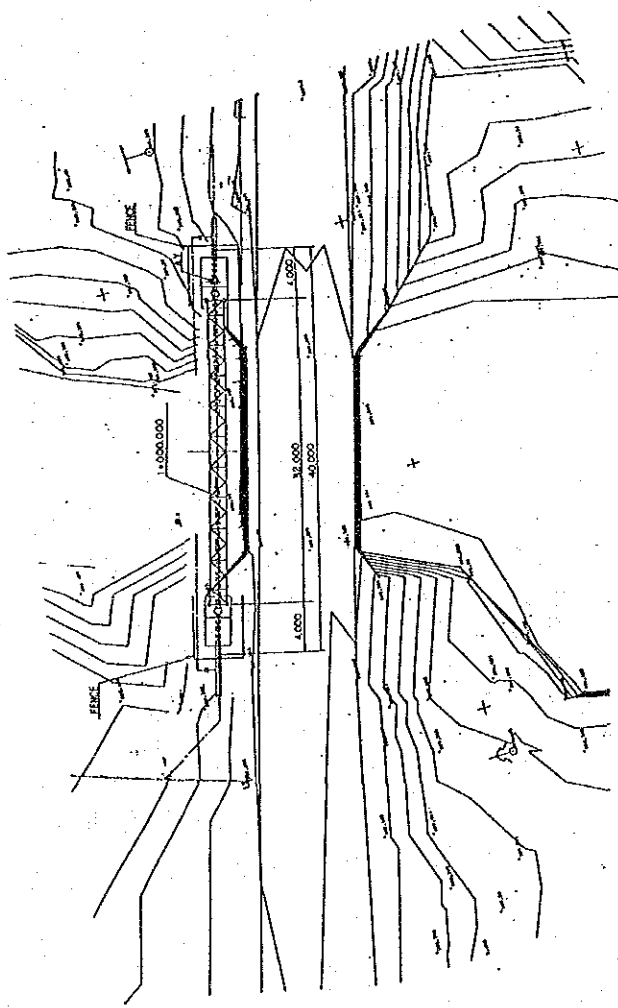

AQUEDUCT 水蓋橋構造図	DWG. NO. 30
--------------------	----------------

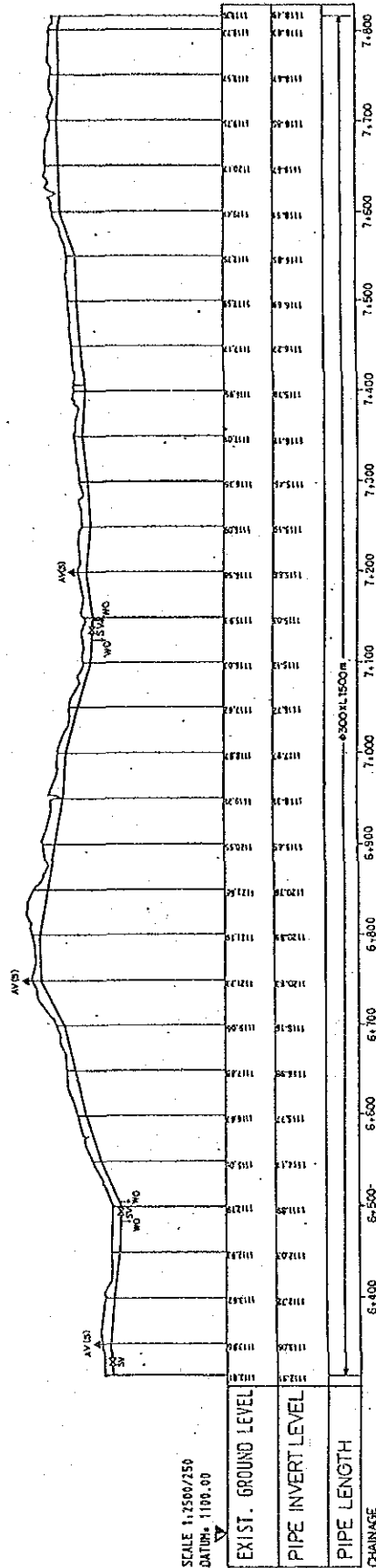
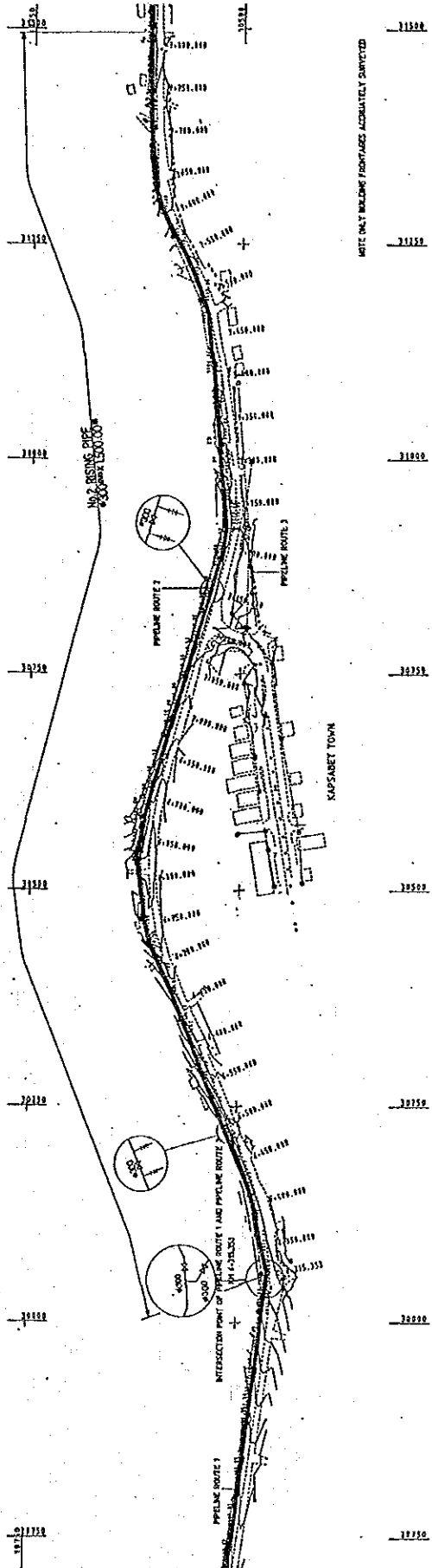

DRWG. NO.
NO. 2 RISING PIPE (1)
送水管平面・縦断シート NO. 2 (その1)
31

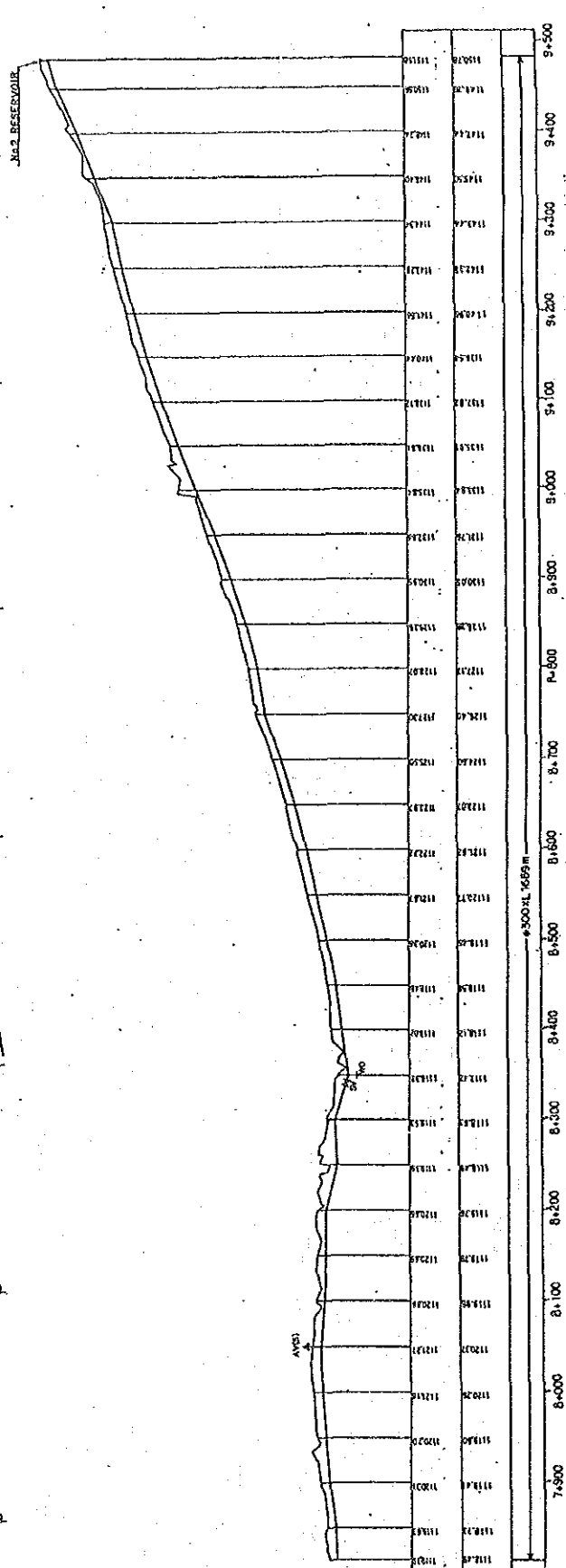
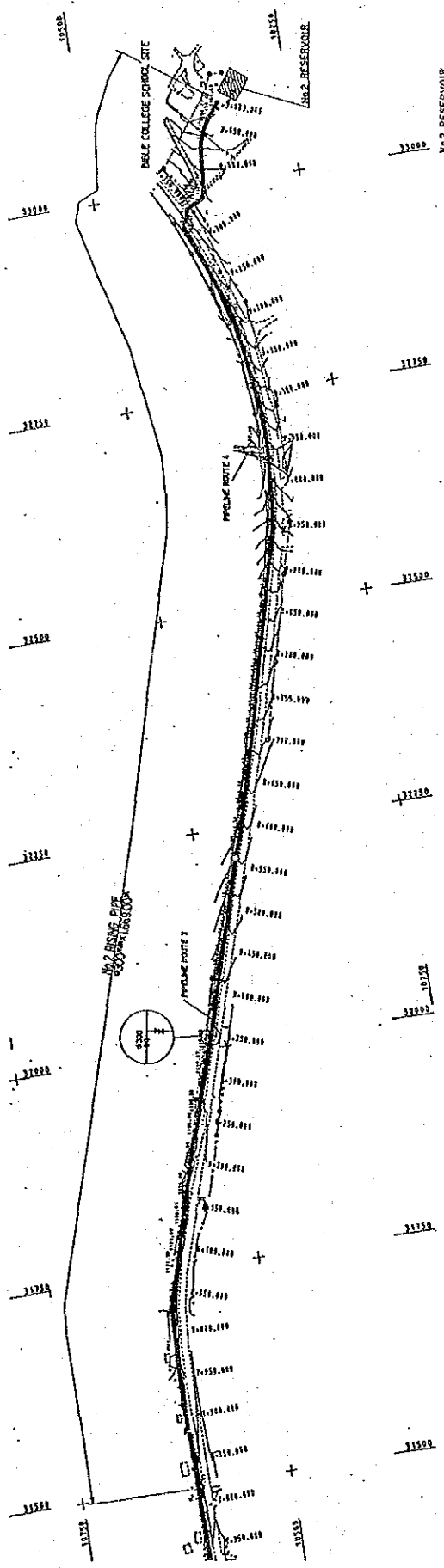

SCALE 1:250/250
 DATUM= 1110.00

EXIST. GROUND LEVEL	PIPE INVERT LEVEL	PIPE LENGTH
9111.1	8205.1	9+500
9091.1	8195.1	9+400
9071.1	8185.1	9+300
9051.1	8175.1	9+200
9031.1	8165.1	9+100
9011.1	8155.1	9+000
8991.1	8145.1	8+900
8971.1	8135.1	8+800
8951.1	8125.1	8+700
8931.1	8115.1	8+600
8911.1	8105.1	8+500
8891.1	8095.1	8+400
8871.1	8085.1	8+300
8851.1	8075.1	8+200
8831.1	8065.1	8+100
8811.1	8055.1	8+000
8791.1	8045.1	7+900

NO. 2 RISING PIPE (2)
 送水管平順・縦断図ルート NO. 2 (その 2)
 DRAWG. NO. 3 2

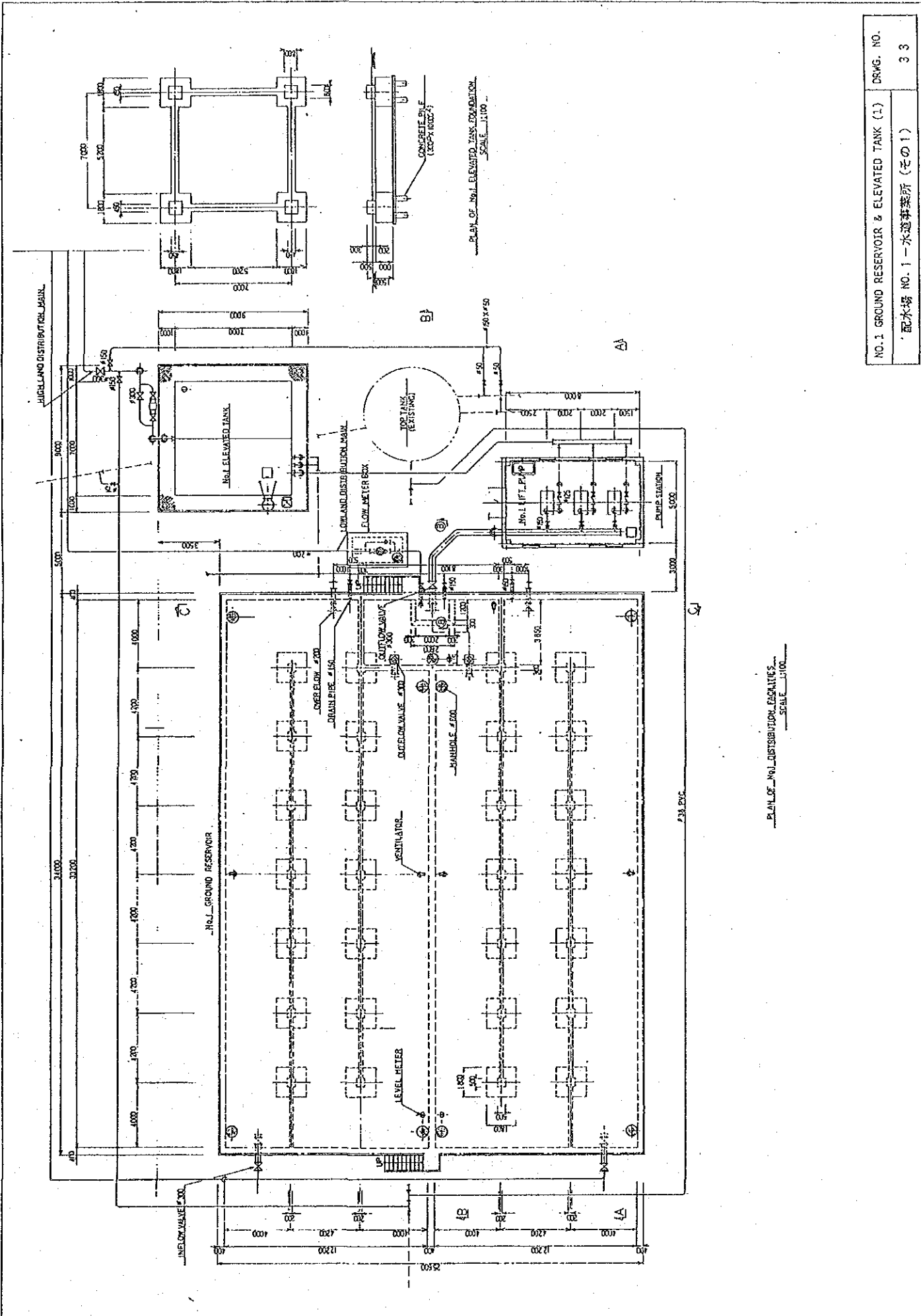

PLAN OF NO.1 DISTRIBUTION FACILITIES
SCALE 1:100

PLAN OF NO.1 ELEVATED TANK EXPANSION
SCALE 1:100

NO.1 GROUND RESERVOIR & ELEVATED TANK (1)	DRWG. NO.
配水池 NO.1 - 水送事業所 (その1)	33

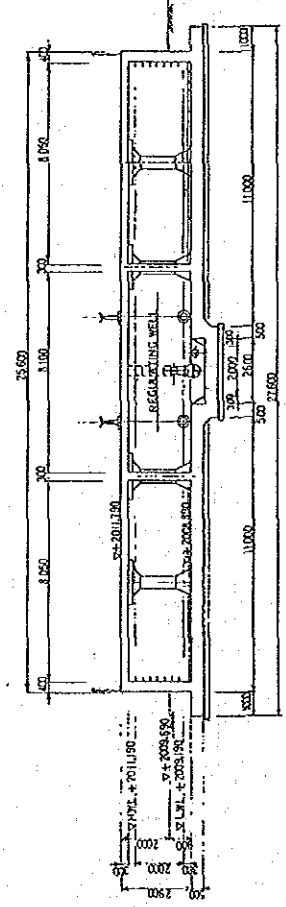
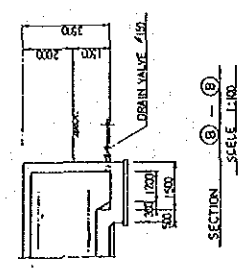
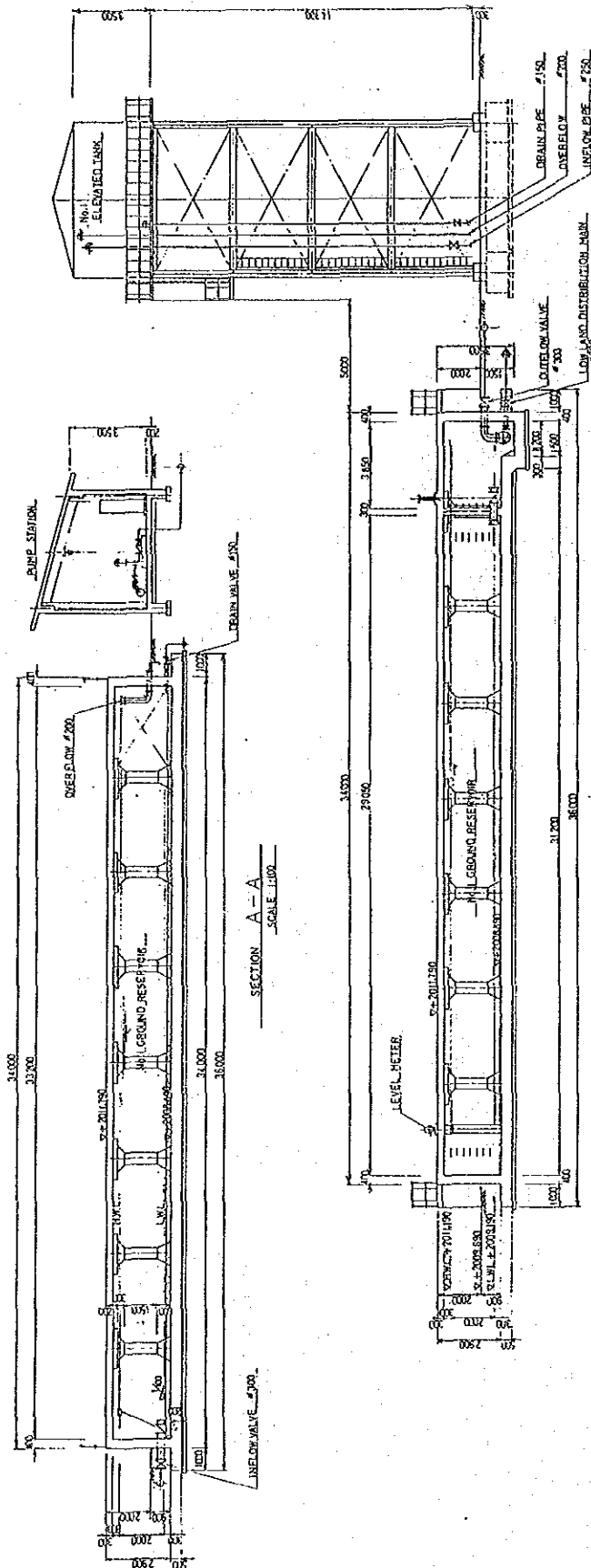

NO. 1 GROUND RESERVOIR & ELEVATED TANK (2)
 配水場 NO. 1 - 水道事業所 (その 2)
 DRWG. NO. 34

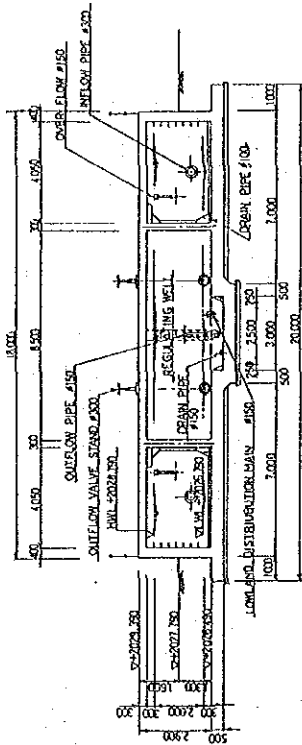

SECTION C-C
SCALE 1:100

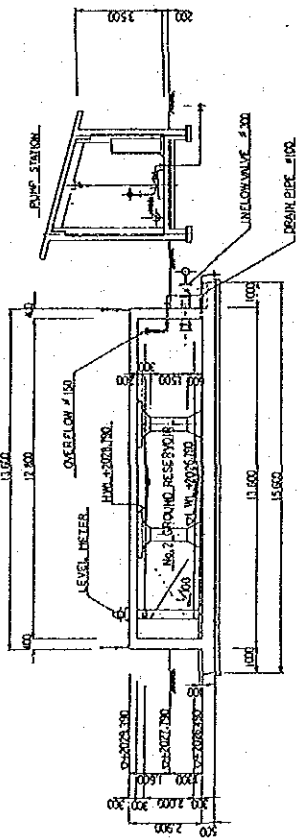

SECTION A-A
SCALE 1:100

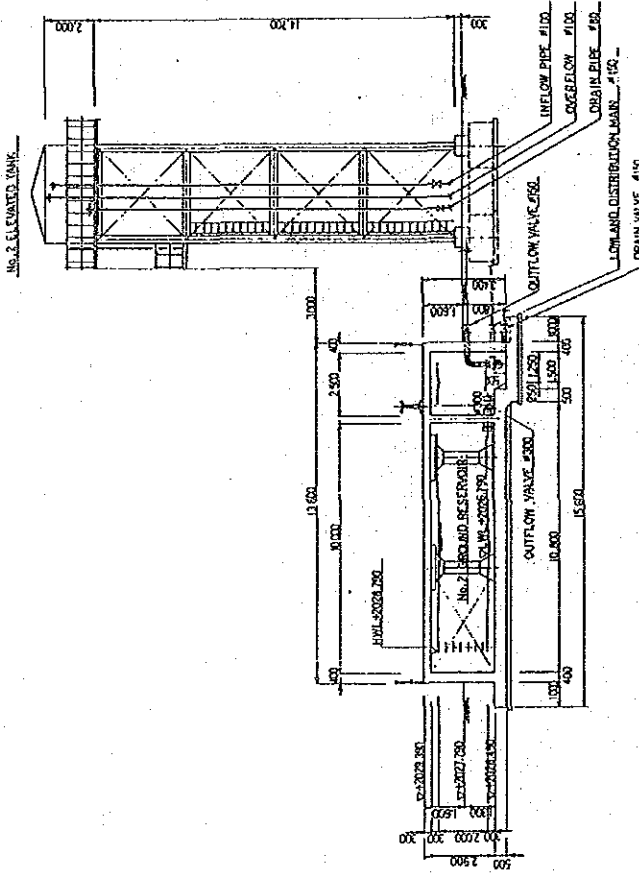

SECTION B-B
SCALE 1:100

NO. 2 GROUND RESERVOIR & ELEVATED TANK (2)	DRWG. NO.
配水塔 NO. 2 - ハイブール・スクール (その 2)	36

Boundary of Water Distribution FROM SHEME GEIDE FROM ERON ERBLE SCHOOL

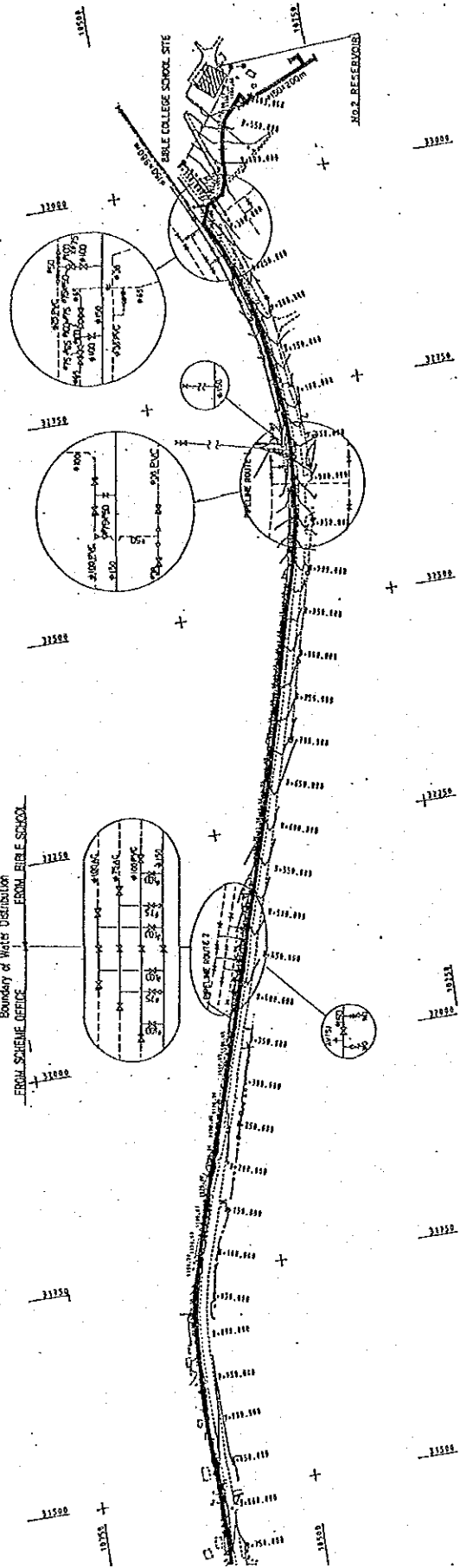

DISTRIBUTION MAIN (2)	DRWG. NO.
配水管平面図 (その2)	38

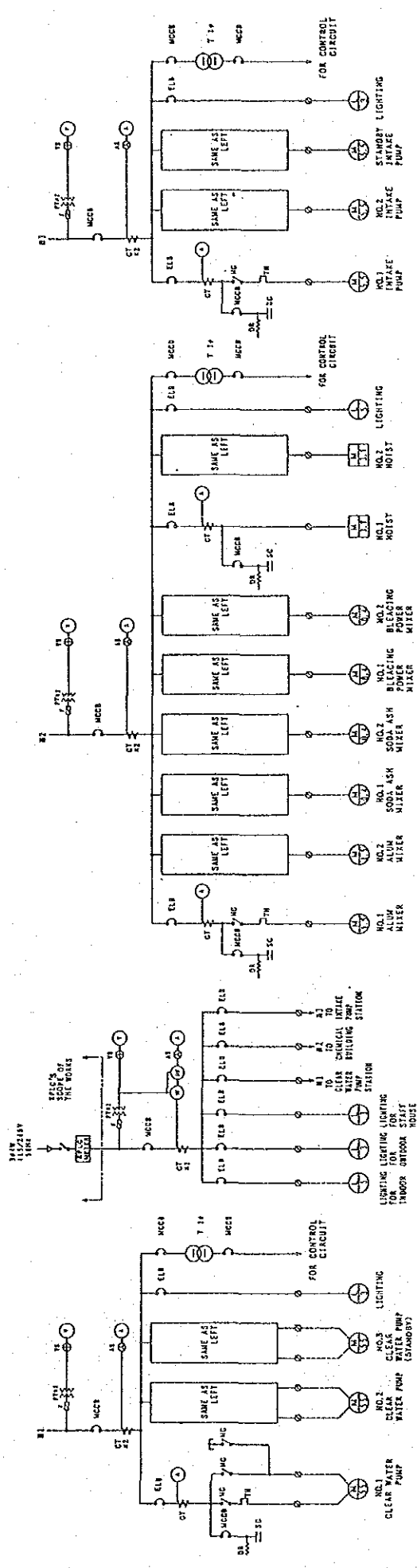

INTAKE PUMP STATION
 CHEMICAL BUILDING
 ADMINISTRATION BUILDING
 CLEAR WATER PUMP STATION

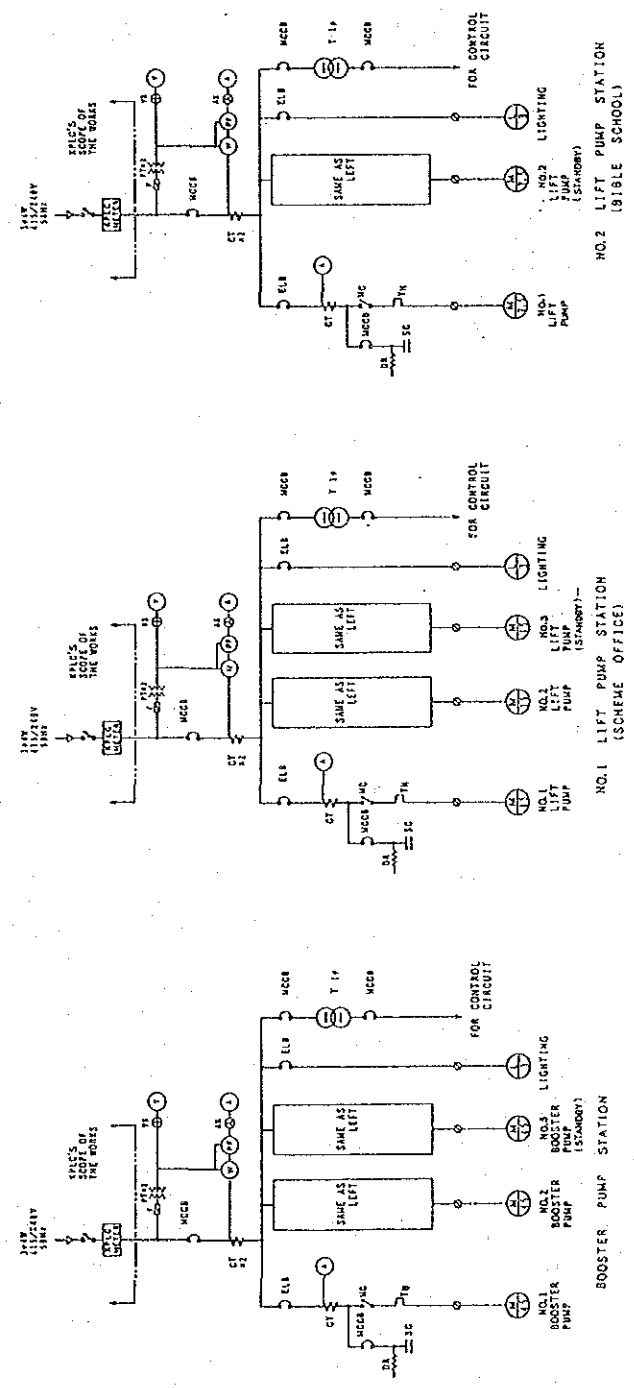

BOOSTER PUMP STATION
 NO. 1 LIFT PUMP STATION (SCHEME OFFICE)
 NO. 2 LIFT PUMP STATION (BIBLE SCHOOL)

LEGEND

SYMBOL	DESCRIPTION
V	VOLTMETER
A	AMMETER
VS	VOLTMETER CHANGE-OVER SWITCH
AS	AMMETER CHANGE-OVER SWITCH
TT	TEMPERATURE TRANSFORMER
CT	CURRENT TRANSFORMER
F	FUSE
MCCB	MOLDED CASE CIRCUIT BREAKER
ELB	RESIDUAL CURRENT CIRCUIT BREAKER
T	TRANSFORMER FOR CONTROL
MC	ELECTROMAGNETIC CONTACTOR
TN	THERMAL OVERLOAD RELAY
SC	MEDIUM VOLTAGE POWER CAPACITOR
DR	DISCHARGE RESISTOR
W	WATT METER
PF	POWER FACTOR METER

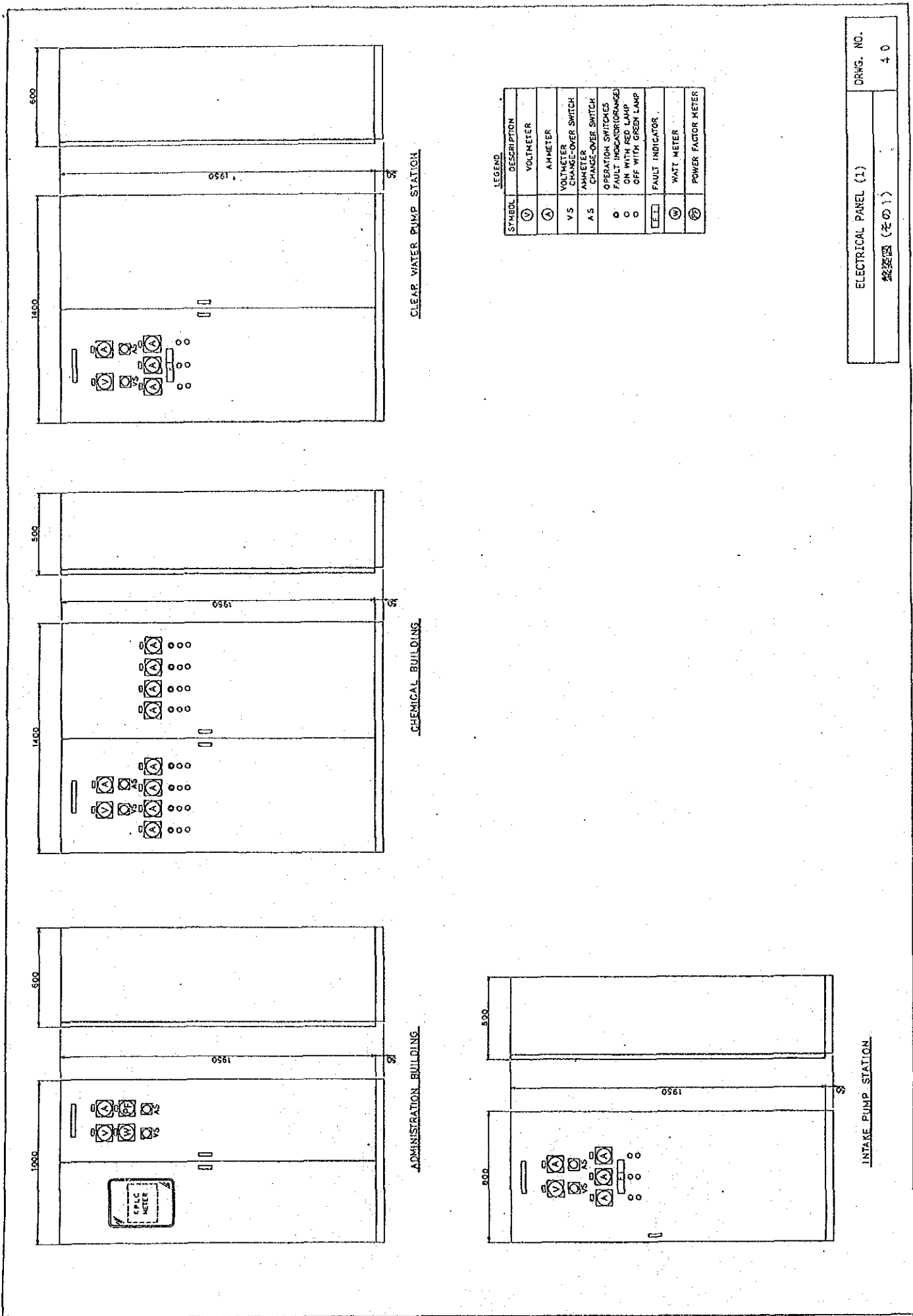

ADMINISTRATION BUILDING

CHEMICAL BUILDING

CLEAR WATER PUMP STATION

LEGEND

SYMBOL	DESCRIPTION
⊖	VOLTMETER
⊕	AMMETER
VS	VOLTMETER CHANGE-OVER SWITCH
AS	AMMETER CHANGE-OVER SWITCH
○	OPERATION SWITCHES
○	FAULT INDICATOR (ORANGE)
○	ON WITH RED LAMP
○	OFF WITH GREEN LAMP
⊖	FAULT INDICATOR
⊕	WATT METER
⊕	POWER FACTOR METER

ELECTRICAL PANEL (1)	DRWG. NO.
電気図 (その1)	40

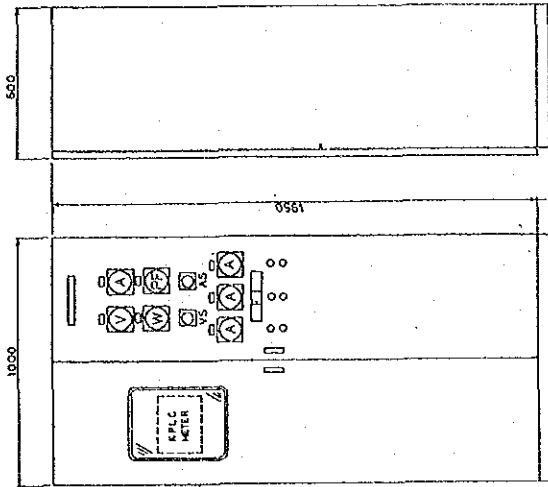

BOOSTER PUMP STATION

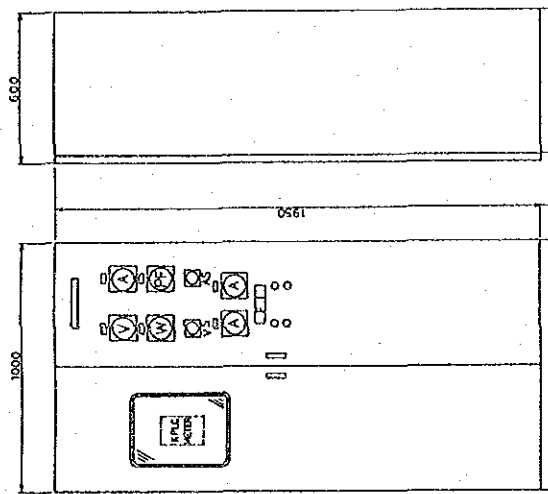

NO.2 LIFT PUMP STATION

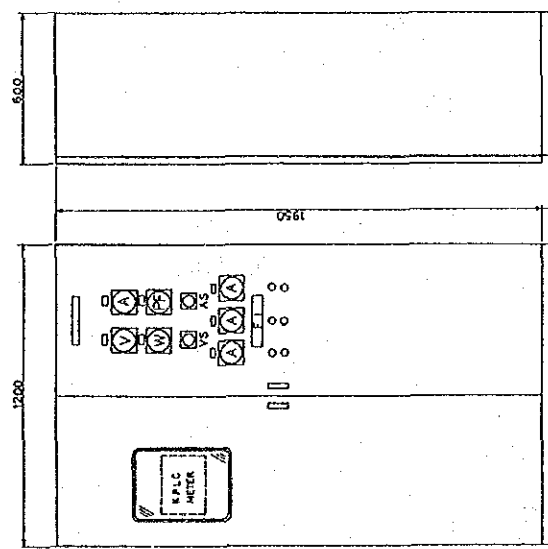

NO.1 LIFT PUMP STATION

LEGEND

SYMBOL	DESCRIPTION
⊖	VOLTMETER
⊙	AMMETER
V	VOLTMETER
VS	CHANGE-OVER SWITCH
A	AMMETER
AS	CHANGE-OVER SWITCH
○	OPERATION SWITCHES
○	ON WITH RED LAMP
○	OFF WITH GREEN LAMP
□	FAULT INDICATOR
⊖	WATT METER
⊙	POWER FACTOR METER

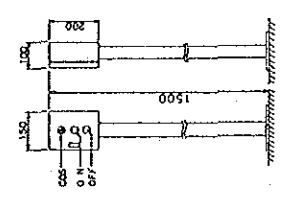

LOCAL CONTROL BOARD

ELECTRICAL PANEL (2)	DRWG. NO.
盤架図 (その2)	41

JICA