

1952

THE UNIVERSITY OF CHICAGO

THE DIVISION OF THE PHYSICAL SCIENCES

(THE UNIVERSITY OF CHICAGO PRESS
54 EAST LAUREL STREET
CHICAGO, ILLINOIS 60607)

PHYSICS DEPARTMENT

1. The first part of the document discusses the importance of maintaining accurate records of all transactions and activities. It emphasizes that proper record-keeping is essential for transparency and accountability, particularly in the context of public administration and financial management. The text notes that without reliable data, it is difficult to assess performance, identify trends, and make informed decisions.

2. The second section focuses on the challenges associated with data collection and analysis. It highlights that while digital tools have improved the efficiency of data gathering, they also introduce new risks, such as data breaches and system downtime. Additionally, the complexity of integrating data from various sources remains a significant hurdle. The document suggests that investing in robust IT infrastructure and training staff in data literacy are crucial steps to overcome these challenges.

3. The third part of the document addresses the ethical implications of data usage. It stresses that while data can provide valuable insights, it must be handled responsibly to protect individual privacy and prevent discrimination. Clear policies and guidelines should be established to ensure that data is used only for its intended purposes and that individuals have control over their own information. Regular audits and oversight mechanisms are also recommended to ensure compliance with relevant laws and regulations.

4. The final section discusses the future of data-driven decision-making. It predicts that as technology continues to advance, the volume and variety of data will increase exponentially. This will necessitate the development of more sophisticated analytical tools and techniques, such as artificial intelligence and machine learning. The document concludes by encouraging organizations to embrace a data-driven culture, where data is not just a byproduct of operations but a central element in strategic planning and execution.

INTRODUCTION TO
TRACTORS IN FOREST WORK

2767y
JICA LIBRARY

111978111

INTERNATIONAL COOPERATION

国際協力事業団



1. FEATURES OF TRACTOR OPERATION

There are advantages and disadvantages in any work using machines.

Therefore, it is advisable to exert all efforts to maximize the advantages and minimize the disadvantages. The followings are some of the features of tractor work.

- (1) Regardless of size, all tractors are considered heavy vehicles. Unfit for long distance operation, they are most efficiently used in short distance heavy work. The most appropriate operating radius is considered to be below 500 meters in logging and under 50 meters in earth-work, thus are regarded as apt cycle distances.
- (2) Tractors enable a one-man operation. The operator can work at ease if there is no-one near the work site. Since a tractor produces a large noise, the operator finds it extremely difficult to hear voices of others.
- (3) As tractors do not require any permanent fixtures, the work area of the machines is flexible.
- (4) As the tractors move about freely, they can continuously improve working conditions, such as construction of spur roads to facilitate operations.
- (5) As a single tractor serves many functions, it is used for logging, spur road construction, forest road maintenance and banking ground construction.
- (6) The grade limit of ground logging is 25° on earth road and 15° on snowy road. This shows that the tractor logging is more handy than cable logging in gentle slope areas.

(7) Tractors are omnipotence when mounted or equipped with various kinds of attachments such as dozers, rake-dozers, augers and rotary-slashers. New types of attachments are also expected to increase in the futures.

2. TRACTORS FOR USE IN FOREST

(1) Crawler Type and Wheel Type

The crawler types are convenient for use in forest work, in general, except the wheel type tractors with pivot steering mechanisms.

- (a) A tractor's dead load is important as the ground contact pressure often gets into matter when towing heavy objects. As the ground contact pressure of the crawler type is small, it is apt for work in mellow or damp grounds and on snowy surface.
 - (b) When compared with the engine, the tractive ability of the wheel type tractors for farm use is small.
 - (c) The crawler type, on the other hand, easily goes over rough terrain. As the height of the center of gravity is low, it assures steady operation on normal slopes. Even on mid slope, the crawler type finds no danger of slipping like the wheel type.
 - (d) Generally, the wheel types require larger turning radius.
 - (e) As a certain amount of earthwork, including spur road construction, is required in the forest, the crawler type is more apt for such operation.
 - (f) On the other hand, the purchasing cost and the maintenance fee of the crawler types are more expensive, which are not fit for hauling work involving long distance travelling at speeds at about 10 Km/h on the road. For long distance operation, generally a sled or a trailer or a truck is introduced.
- Furthermore, as newly developed super-size low-pressure tires are being developed and used in Canada, a new division will

inevitably be opened up for wheel type tractors exclusively for logging.

(2) Large Sized Tractors and Middle-and-Small Sized Tractor.

The small and middle sized tractors are regarded the most appropriate for use in forests in the north-eastern region of the United States, although depending upon the purpose of operation. In Japan, the middle sized units are considered most useful, too, when they are not required to exclusively tow a full stem length logging of king size logs.

(a) The tractors normally work an average of 700 to 1000 hours yearly. The efficiency rate of tractors is computed by real working hours based on the number of work days and the term, of work periods. When moving a tractor with a trailer truck to another field upon completion of work, it takes two days to arrange a trailer truck thus wasting nine hours of operating time. Therefore, the actual work time efficiency will drop between 1 and 1.5 percent. This, in turn, will further deteriorate per-working-hour depreciation.

In short, large sized tractors bring gains only when fully used at a single work site. As full stem length logging is preferred in logging and as operation sometimes require earth work and snow removing work, tractors that can readily be transported to another job site by an ordinary sized truck and yet are mounted with reasonably powerful engines are the most convenient.

- (b) Limited loads of bridges found along the way often become important factors in determining the size of tractors.
- (c) Also the size of tractors must be required the units to follow a zigzag course to avoid obstacles in the forests for selection work in logging.
- (d) In forest operations, tractors are frequently required to do earthwork such as spur road construction to the necessary sites. And the width of a tractor is utilized to cut soil. However, when the width is widen 50 centimeters, the soil cutting volume generally increases between 50 to 70 percent. But to heighten work efficiency of the main operation, it is recommended to minimize secondary work as possible to save both time and money.
- (e) Earthwork within about 5 meters in radius produces the most efficient work cycle in forest land. And the large sized crawler type tractors can not exercise full capacity to do such work.
- (f) Tractor operation always includes a process of ground logging and pre logging work. As the reaction force against ground logging sometimes doubles the log's dead load, it is necessary to hold down the reaction force to about 1.3 times of the log's weight. The towing ability of the winch should naturally be utilized, but if the weight of tractor is too light, it deteriorates work efficiency.
- (g) The best method to reduce the cost of work is to instruct people at the job site to thoroughly master manipulation of tractors of a size smaller than those requested by them.

Instead of speaking in the abstract, it is necessary to probe further into the subject with actual figures with regards operating costs in each operational area.

(3) Performance of Tractors

(a) The following list shows tractors widely used in forest work in Japan.

TABLE-1 PERFORMANCE OF ANGLE DOZERS USED
IN FOREST WORK

Item	Model	Iwate-Fuji CT - 35	Komatsu D - 40	Komatsu D - 50
Gross Weigh	Kg	6,770	9,320	11,880
Dimensions				
Overall length	mm	4,660	4,250	4,355
Width of unit	"	1,730	2,250	2,340
Overall width	"	2,600	3,150	3,720
Overall height	"	2,580	2,620	2,860
Ground clearance	"	320	360	325
Distance between Center of tracks	"	1,330	1,540	1,880
Length of tracks on ground	"	1,795	2,060	2,200
Width of tracks's shoe	"	400	400	510
Pressure on ground	kg/cm ²	0.45	0.57	0.59
Climbing ability	degree	35	30	30
Main clutch		Single disc type	Double disc type	Double disc type

Steering		Controlled planetary differential type	Clutch and Brake Type	Clutch and Brake Type
Suspension system		Equalizer beam type	Equalizer beam type	Equalizer beam type
Running Speed				
Forward 1st	km/h	2.5	2.5	2.6
2nd		3.6	3.3	3.7
3rd		5.4	5.2	5.4
4th		9.3	9.5	9.1
Reverse 1st	km/h	2.9	3.3	3.5
2nd		6.0	4.9	5.5
3rd			7.7	7.9
Maximum Drawbar pulls	kg	6,570	9,870	13,270
Engine				
Model		Isuzu 6BB1	Komatsu 4D-105	Komatsu 4D-130
Rated horsepower	ps.	63/2,000	80/1,400	110/1,900
Starter system		Electromotor	Electromotor	Electromotor
Dozer & Blade				
Width	mm	2,600	3,150	3,720
Height		700	746	875

TABLE-2 WINCH PERFORMANCE

Item	Tractor Model		Iwate-Fuji CT - 35	Komatsu D - 40	Komatsu D - 50
		mm	2106x3906x220	230x510x300	same as D-40
Drum size					
Winding capacity			88m/14mm rope	122/20	
Brake system			Band, differential	Band, ordinary	
Pulls/speed/min			7,000kg/29m	12,300kg/29m	
Weight		kg	430	840	

(Note) Differential brake: A type that is effective in reverse direction and not in the winding direction.

(b) Glossary.

Gross Weight Total weight of tractor with an operator, and full tank cooling water, engine oil and fuel, placed in a condition for readily use.

Width of Unit ... The outside width of shoes of tractor. It is relevant to the size of truck or trailer transporting the tractor.

Ground Clearance..Space between ground surface and the lowest point of unit to cope with unexpected obstacles when going over rough forest lands.

Width of Shoe ... The width of shoe on each side.

Generally the width is referred in inches but officially it should be in millimeters.

14 inches = 356 millimeters,

15 inches = 381 millimeters,

16 inches = 406 millimeters.

Average Pressure

on Ground It shows the pressure on ground. And it can be obtained by the following equation:

$$\text{Pressure on Ground} = \frac{\text{Gross Weight}}{2 \times \text{Width of Shoe} \times \text{Ground contact length}}$$

When wider shoes are replaced, the pressure on ground decreases. The pressure on ground of a man standing on his one leg is roughly 0.3 kg/cm^2 , resembling a crawler type tractor. The pressure on ground of a horse is roughly 1.4 kg/cm^2 or similar to a wheel type tractor.

Climbing Ability. It shows the maximum grade a tractor can possibly climb. Actually the ability differs according to ground condition. Generally, the grade is between 30 and 35 degrees.

(4) Drawbar Pull

1. Maximum Pulling Ability

The maximum drawbar pull of each transmission gear, which is obtained when engine is on.

It is possible to calculate the maximum pulling ability, although actually it is limited within actual adhesion pull.

$$DP_m = T_m \times \lambda \times \frac{1}{R} \times \eta$$

DP_m : Maximum drawbar pull (kg)

T_m : Maximum engine torque (kg·m)

λ : Total reduction rate (n of 1:n)

R : Radius of driving wheel (m)

In wheel type, rolling radius of driving wheel.

η : Coefficient of machine (0.7 - 0.8)

2.. Adhesion Drawbar Pull

The maximum adhesion drawbar pull is subjected to change by actual ground conditions. Despite of large engine capacity, a drawbar pull is not obtainable when slips occur. Slip occurs the moment when the pulling load surpasses the limit pull at low speed gear. Therefore, the limit of the haul is generally the limit of the adhesion drawbar pull.

$$DP_m = W \times \mu$$

W : Gross weight of tractor (kg)

Load on Driving Wheel, in case of wheel type

μ : Coefficient of adhesion.

Generally in farm lands, the μ is 0.85 in the crawler type and 0.55 in the wheel type. But with regards forest lands, the FAO references says in Table-3.

TABLE-3 COEFFICIENT OF ADHESION OF TRACTORS

Type of Surface		Crawler	Rubber Tires
Sand Clay	(Dry)	0.56	0.35
	(Wet)	0.42	0.20

(5) Performance of engine by altitude

In general the performance of engine is indicated under normal climatic condition (Atmosphere: 760 mm Hg, Temperature 20° centigrade).

The engine power is in proportion to the inlet air pressure and in inverse proportion to the square root of temperature.

When atmospheric pressure drops 10mm Hg, the engine output drops 1.6 percent. And when air temperature drops 5.6°C the engine output increases 2 percent.

The simple equation for correction coefficient by FAO is:

$$K = 100 \left(1 - \frac{h - 300}{10,000} \right)$$

K : Horsepower correction coefficient

h : Altitude (Height from sea level : m)

When the altitude increases each 100 meters, the engine output decreases 1 percent.

(6) Conditions for Selecting Tractors to Purchase.

1. Scale of work

Frequency of tractor transportation. Work content.

2. Topography and Foundation

Grade of slope, damp land, craggy area, snowy surface and altitude of job site.

3. Work Machinery

Equipment of necessary work machinery.

4. Involvement in Sub-Operation

The actual schedul of tractors involved in other work to increase total work efficiency.

5. Operating Technique

Degree of technology including driving technique and maintenance.

6. Economic Effect

Cost Study of each process, fixed expenditures and variable expenses.

It is important to conduct researches on costs before deciding on models of tractors to purchase.

3. EQUIPMENTS AND IMPLEMENTS FOR FOREST OPERATION

(1) Dozer, Log Loader and Shovel.

Figure 1.

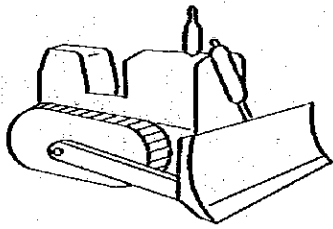

a. Dozer

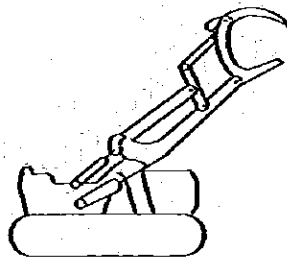

b. Log Loader

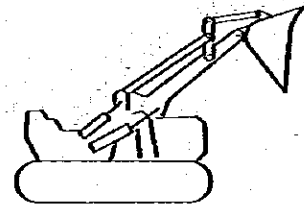

c. Tractor Shovel

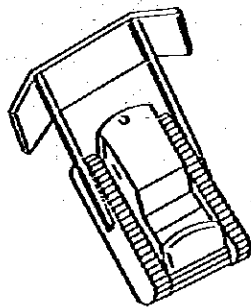

e. Back-dozer type
Chip Dozer

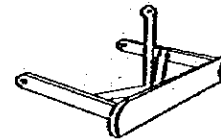

d. Dozer for Tractor
Shovel and
Log Loading

a. Dozer

The Dozer is the most representative implement of all serving various purposes. Tractors mounted with dozers are called bulldozers.

The dozers are movable up and down by either the cable-controlled method or the hydraulic system. Bulldozers of middle and small sizes are normally mounted with a hydraulic system which is easy to manipulate and to conduct intricate work. As the dozers can

be forced down, they excel in soil cutting performance.

The cable controlled dozer tractors, on the other hand, often slip when running against obstacles and therefore are subjected to slide. Since slipping never occurs in the hydraulic dozer tractors, the bull-dozers are often charged against obstacles. But this can also cause damage if overdone.

When a blade is fixed at right angle with the tractor's advancing direction, it is called a straight dozer. And when a dozer is fixed at an angle of between 25 and 30 degrees, it is called angle-dozer. The angle dozer is most effective in side-cut operation. However, in general, an angle dozer attached to a tractor of below 3 tons often invites overstrain.

To slant the dozer upwards or downwards is to tilt. And the distance and height of the tilt for small and medium sized tractors are between 100 and 200 mm.

Figure 2.

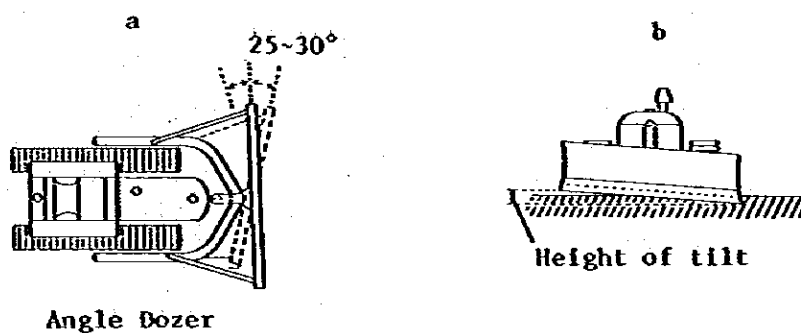

A dozer at a sight seems unnecessary in logging operation. But by moving the dozer downwards, the center of weight is lowered and gives stability to the tractor especially when descending

a slope. The dozer is indispensable for removing obstacles (found scattered) in the forest land, for pulling out bamboo, for log pushing in banking ground and for other logging work.

A backdozer is a reversed dozer frequently used for gathering imported wood chip inside a hull of ship. To maximize the gathering volume, a large dozer is mounted with a certain distance between the tractor unit.

b. Log Loader

This is a unit used for log loading and short distance carrying operations. The unit excels as follows:

- i) One man operation in banking ground is possible.
- ii) Loading and unloading of logs on trucks can be done at optional site.
- iii) Log selection work can easily and readily be done.
- iv) Logs collected by full stem length logging can be loaded onto trucks without injury of sticks.
- v) Unloading of frozen logs is possible with the use of fork attached to the front of a tractor, to replace the hazardous backbreaking work hitherto done by man.

Furthermore, by simply changing the fork of a log loader with a bucket, it can be used as a tractor shovel. And by attaching a dozer to the lower part of the fork, the unit can be used for snow removing in forest roads and earth removing at landslide areas.

c. Shovel

Formerly called a bucket-loader, it was mainly used for loading earth, rock and gravels. But today, improvements are made to enable the unit to conduct excavation work.

The bucket capacity is between 0.5 and 1.0 m³ for tractors for forest use. The size of bucket is changable accoring to the type of work for rock, clay, sand, iron ore, coal and pulverized coal. It is also considered apt for conveyance of chips at pulp plants.

A tractor shovel not only conducts dump work with bucket on foward and backward but also on one side. There is an over shot type to conduct dump work from the front to rear. The use of tractor shovel is becoming more and more widespread in earthwork today.

Also, a dozer can be attached to the lower part of the shovel to conduct earth removing work.

d. Scarifier

Hard ground foundation sometimes makes excavation work by dozers and shovels impossible. To cope with this situation, a scarifier is attached to the rear part of the tractor to facilitate working of the machines positioned in the front of the tractor to scarify earth. By attaching this unit to small and middle sized tractors, the work efficiency of tractors can be further hightened.

Figure 3

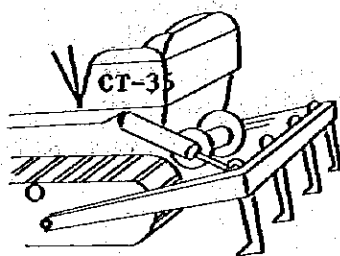

Scarifier

e. Back Hoe

A back hoe can be equipped at the rear part of tractor for digging or for side drain excavation work to lay pipes. It is also apt for side drain excavation work of ballast road, forest road grading work and digging to lay concrete open drain. Digging of plantation holes is also possible.

Figure 4

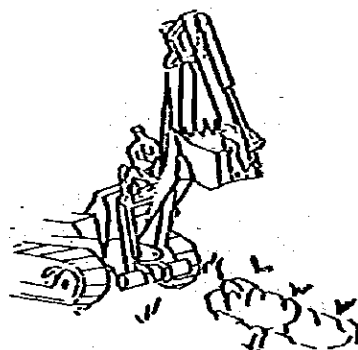

Back hoe





(Attachement) Tractor Shoe

All kinds of shoes are available as attachments for tractors. Since forest work requires long distance running of tractors than construction work, shoes for general use are easily worn out.

Therefore, a rolled three growth type is used for CT-35.

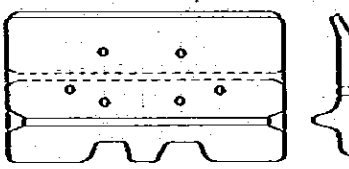
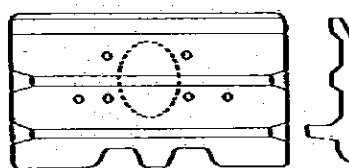
Furthermore, snow-shoes with a oval hole in the center are used for work in snow and swampy grounds. Spiked shoes can also be prepared for work at icy grounds.

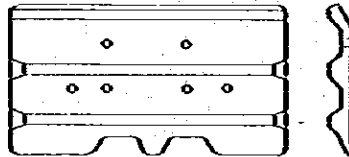
Figure - 5 Types of Track Plates

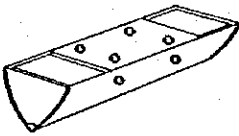
1		With lug	Conventional type
2		With lug Three-growth type	Used in CT-35 Model from November 1962. Standard type for angle dozer.  Configuration of hole for snow shoe.
3		Three-growth type Straight type	Standard type for CT-35 log loader CT-35 tractor shovel
4		Single growth type Snow type	
5		Swamp shoe	For damp and mellow ground.

(Note) Attachment of ice-spikes is possible in 1 to 4.

(2) Winch

Winch is indispensable for tractors in forest work.

- a. A winch is indispensable for pre-logging operations such as pulling out of logs from rough terrains and from below the side of roads.
- b. When tractors are impossible to pull up logs along steep slopes or logs trapped in muddy roads, a winch wire rope is used. In this case, a tractor takes up its position on a solid ground to pull the logs. Thus, the pulling power of a wire rope gives an additional 50 to 80% traction ability to the tractor than direct pulling of logs.

Winches for forest use

- a. When the logs are pulled near the winch drum, the brake is applied. When the pull ends, the clutch is released. But if the brake can be applied automatically and simultaneously with the release of the clutch, it is most convenient. (CT-35 winch, made in Japan). This method is needed when a sulky is used for logging. Otherwise, the hanging of logs can not be smoothly conducted.

- b. Use of fare lead.

There is no guarantee that the tractors can be positioned to aptly face the best direction for logging. In this case, as the wire rope can not be wound straightly around the winch drum, the flange of the drum is often scraped causing damage to both the rope and drum. To prevent all these, a fare lead with three rollers is used.

There is also a unit facilitating ground logging by raising the point of the wire rope using the upper roller.

Figure 6

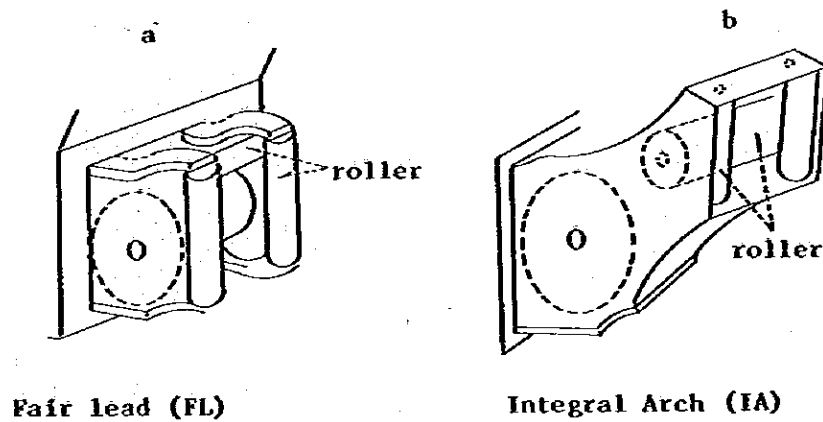

- c. It is advisable to be prepared with only the necessary length of wire rope and not longer. When too much rope is wound round the drum, it is often squeezed violently underneath the drum when logs are pulled in or a tensile rope is liable to trap itself between loosely wound rope to cause damage. When the wire rope of proper length is directly wound round the drum face (should leave wire rope for two more winds), the pull force is most effective. The standard size should be Filler Type 7 x 7 + 6 x Fi (19+6) IWRC that can withstand rope deformation. A shackle is attached on one end of the wire.

(3) Sulky, etc.

a. Sulky

Sulky is available in the tire type and the crawler type (also referred to as: logging arch).

The latter is generally used for large sized models. Sulky is convenient for logging by hooking up one end of the log and logging the tail end on the ground.

Also in pre-logging, as the rope's point is high, the work is done much easier than ground logging methods. As a sulky is a kind of a hauling unit, it is difficult to change directions and to run in reverse direction on rough ground. When empty, a sulky is loaded on a tractor.

Figure - 7

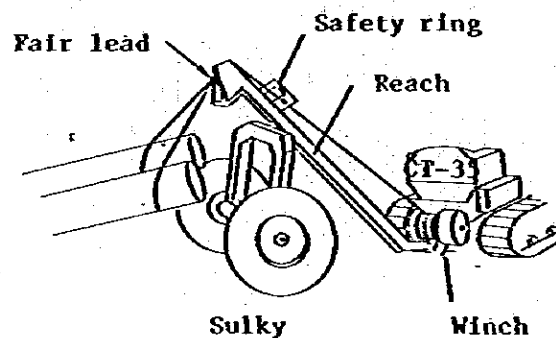

b. Sled

There are times when the tips of logs are rested on sled for logging. Unlike sulky, that pulls the logs with a winch and hooks them up for logging in one process, the sled requires two processes of pre-logging and loading, thus requires manpower.

(4) Tools

a. Choker hook, sling rope and 5-way hook.

Figure - 8

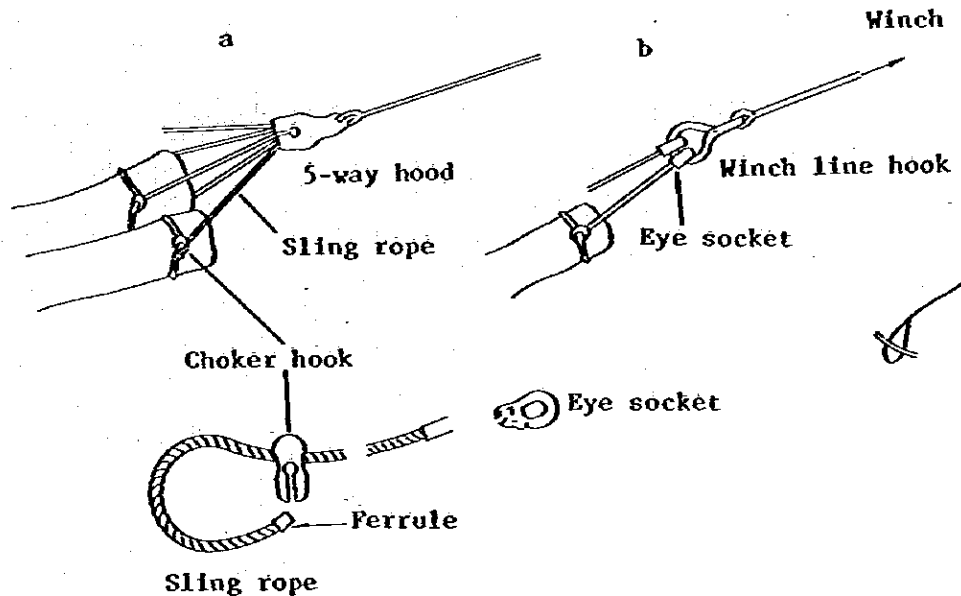

From the standpoint of efficiency and safety of logging, it is recommended to introduce winding or binding tools that are exclusively made for the purpose.

Since sling-rope must withstand severe use, a special rope 7 x 7 + 6 Fi (19 + 6) IWRC must be prepared with both ends attached with ferrules to be connected to choker hooks, eye sockets or 5-way hooks. The length of a sling rope should be between 1.5 and 6 meters depending on the size of logs to be handled.

b. Automatic Snatch Block

Figure - 9

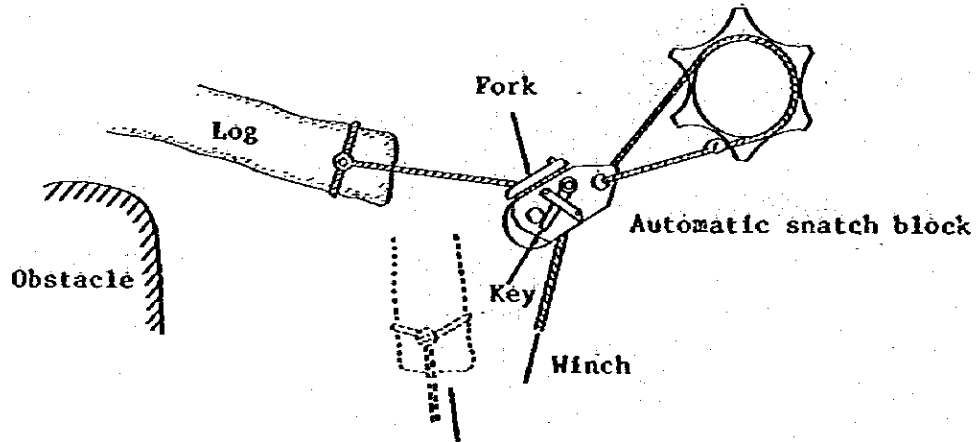

When logs can not be pulled directly toward a tractor owing to an obstacle, this automatic snatch block conveniently expedites work. Also, when the logs skid away from the center line of the sulky, the sulky is liable to overturn. In this case, this automatic snatch block can position logging along the center line. Furthermore, only the snatch block allows logging to avoid selection sites where young trees grow in profusion.

The side boards of a snatch block can be opened easily. Therefore when the winch line is to be extended toward the logging direction, the line can first be placed through the block and then be connected with a log. When the log comes in contact with the fork of the block, the side boards automatically open to release the rope from the block. Then the logs are pulled in another direction. To promote logging facility, this block at least one is necessary for a tractor.

4. GENERAL SUGGESTIONS REGARDS TRACTOR DRIVING

A. Notes when handling new models.

New tractors require 'breaking in' more than new cars. The good or bad of the initial break-in running makes a great difference in the durability of the tractors.

Generally, new vehicles are limited with many things until the first 1,000 kilometers of operation. Until the first 60 to 100 hours (about one month), tractors must be operated between 50 and 70 percent of load capacity.

B. Tractor Handling and Servicing Points by the Japanese Forestry Agency.

- 2.1 Pre-driving points.
- 2.2 Manipulation of each lever.
- 2.3 Driving points.
- 2.4 Driving under various conditions.
- 2.5 Transportation.
- 2.6 Post-driving points.

(Driving Notes)

- (1) When changing speed, the tractor must come to a total stop before shifting gears.
- (2) The operational lever should be used full stroke, and half clutch and half brake should be avoided.
- (3) After confirming that the steering lever (steering clutch) is working, the steering pedal (steering brake) should be stepped on. And the pedal must first be released before returning the lever to its original position.

However, when tractor is mounted with a double differential gear steering system, only the steering lever is to be released.

- (4) Before starting the tractor, check all directions to confirm safety.
(To check that no one is around)
- (5) If something wrong is felt during operation, the tractor must be promptly stopped to readily check or conduct troubleshooting.
- (6) Ascending and descending of inclined surface and steep slope.
 1. The climb should be done in low gear. And the gear should never be changed.
 2. Never go aslant or traverse a steep slope. The tractor not only side-slips or skates down the slope but there is also a great danger of overturning after bumping against a stump or a rock. When on a verge of slipping down, quickly maneuver the tractor to face the slope direction.
 3. When descending a steep slope, always apply the engine brake from start and be on the alert for any reverse turn*. When hauling a load, exert extra care in steering.

*Reverse turn means when you are going downslope by applying a clutch-brake type steering system, the load of tractor or logs forces the tractor to turn reversly.

Tractors mounted with a double differential gear steering system has no danger of reverse turn as they are power steered.

4. The dozer must be faced downwards to be used as an emergency brake.

5. When crossing a river, the water level generally should never exceed the top level of shoes. However, some models differ in water limit levels according to the heights of oil supply holes and electric components.
6. Always sit at the driver's seat. It should be totally prohibited to allow others to ride on the equipped working machine and pulling objects.
7. When it is necessary to push a fallen tree, always push from the root side. When the push is applied from the tree-top side, the tree often bends and springs back with a strong force by slipping away from the dozer.

5. LOGGING BY TRACTORS AND WORK PROCESS

A. Kinds of Tractor Logging Methods

Tractor logging methods vary according to types of work as follows:

(1) Ground Skidding

This is a method to directly pull logs with a tractor by using a sling rope, X-hook, etc.

a. Short distance logging

The logs are gathered by winch to be pulled directly by tractors. This method is effective in ground logging of between 120 and 130 meters.

b. Steep Slope Logging

Ground skidding is effective on steep slopes which other logging methods find it extremely difficult to keep logs controlled. The cut end of a log can hamper slips by piercing into the ground. This normally happens when ground logging is conducted along the slope direction. Therefore, it is rather advisable to construct spur roads aslant to the slope face when logging is conducted in large quantity to prevent the logs from destroying the forest ground surface and the logs themselves.

(2) Wide Sled Logging

This is a method to rest one end of a log on a steel sled for logging. The use of sled enables an increased work load of about 30 percent than ground logging.

In case of mellow ground logging

The sled is used when the wheels of a sulky come to a standstill by sinking into a mellow ground. In this case, however, logs can not be loaded directly onto the sled after being collected by a winch, and requires the help of loader-men. Also at the unloading deck, manpower is required to unload the logs. However, this is not a swift working method as it is difficult to back away with an empty sled or to make sharp turns.

(3) Sulky Or Arch Logging

Instead of a sulky with wheels, the arch has shoes of small ground contact pressure. As it is heavier and larger, it is seldom used in Japan.

As a sulky heightens the wire rope rewinding point of the winch to hang logs, pre-logging and logging work can be handled by a single tractor consistently.

The logs are pulled one by one by the winch, then are grouped together and slung by the sulky to leave the log tails dragging along the way.

When winding winch, it is suggested to minimize the possibility of logs being caught in the field. Also it is wise to elongate the length of logs to increase the volume of logging by sulky.

(4) Sled or Trailer Transportation

This is a method to transport logs by totally carrying them on sleds and trailers. A method popularly used in the early days

of tractors. However, this method consumes time and money in constructing sled and trailer paths and also in the loading and unloading work.

Except when transporting short length pulp materials or fuel wood on snowy area, this method can not compete with log transporting by trucks.

(5) Other Logging Methods

The U.S.S.R's TDT Tractors or U.S.A's Tom Carts are tractors exclusively for logging designed to load the end of logs onto the back part of the tractors. About half of the load's weight is utilized to give additional traction ability to the light tractors. Also as the tractors do not pull any working machines, they can nimbly move about to expedite work.

However, tractors at forest lands are required to serve various purposes instead of only logging.

When viewing the various working methods, the sulky logging method is considered most useful but when selecting work machines and work methods, due considerations must also be given to the topography, ground condition, logging distance, work scale, season, and types of logs.

B. Order of Work for Tractor Logging

(1) Construction of spur roads for tractors

Although tractors move freely about, it is necessary to construct spur roads to heighten efficiency of work.

- a. A solid spur road should be built where it is closer to the unloading deck. At tree felling sites where tractors do not frequent, spur roads are not necessary. However, where tractors do frequent, good solid spur road construction is a must. Since there are possibilities for trucks to penetrate deeper into the forest land, it is wise to reinforce spur roads to expedite work. In this instance, due considerations must be given to the road slope gradients where trucks are required to go over.
- b. When designing a loading and unloading deck, consideration must be given to allow smooth flow of tractors. By trying to avoid as possible the switch back driving of tractors, it is important to design the decks as close to the shape of a loop by combining the U-shaped, loop and L-shaped roads. The U-shaped road should allow flexible work cycle of logging in accordance with the frequency of banking ground treatment by combining the far and near sites. The road in the embankment should be wide enough to allow two-way traffic of tractors.

Figure 16: Tractor Roads

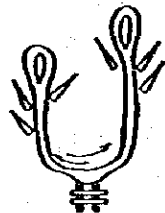

a. U-shaped road



b. Loop road



c. L-shaped road

c. The width of spur roads, etc.

- 1) The width must be over 1.2 times that of the ground contact width of tractors.
- 2) The bending section of the road must have a radius of well over 1/2 of the length of logs.

In this instance, the road width is:

$$\text{Width} = \frac{(\text{length of log})^2}{(\text{radius of road's curve}) \times 8} \text{ or } \frac{L^2}{R \times 2}$$

(When the end of log moves freely) (When the end of log does not move freely)

Standers are left intact along the outside curve of road to prevent logs from rolling out.

Furthermore, to allow smooth passage of logs around the curve, the reverse contour enables the tails of logs to swing around the curve easily.

d. Logging road with steep slope

Although it depends on the ground condition, the grade limit of tractors in logging is 25° on a spur road. (Work Standard in Japan : Grade limit of logging road 25° in normal condition and 15° when covered with snow.)

However, it is near impossible for tractors to climb upslope by avoiding fallen trees. Therefore, some loop roads provide uphill roads and towing(down-hill) roads separately.

Figure - 17

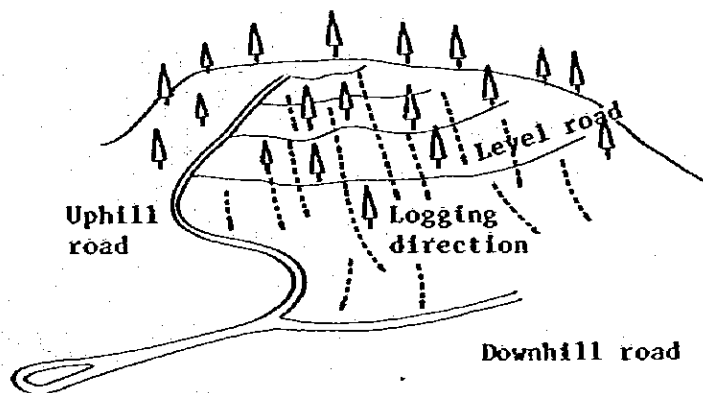

Uphill roads are provided for easy climbing slope, while simple level roads are built at 50 meter intervals on the logging slope. While the logs are driven downhill from the level roads, work can be conducted on the steep slope by full stem length skidding along the way.

- e. The density of spur roads must be high.

The pre-logging distance by winch rope of a tractor is normally between 20 and 30 meters. The work efficiency drops if this distance becomes longer. In Hokkaido, the density is usually 60 m/ha. The tractor is driven forward when nearing the log, then changes direction near the log and backs uphill with the winch facing the log.

- f. Combination of a tractor road and a truck road.

The efficient distance of logging by tractors is said to be between 350 and 400 meters. Therefore, it is necessary to make consideration of combining a truck road to facilitate operation. It is truly difficult from economic reasons to decide on the proportion of distances of tractor and truck roads to be built.

Table 4

Types of Forest	Truck Road Optimum Density	Length of Truck Road per 10,000m ³ of carrying amount	Remarks
Field Forest	30.1 m/ha	2,400m	Growing Stock per ha 123 m ³
Hill Forest	28.5	2,240	127
Mountain Forest	16.6	2,960	56

(2) Felling and bucking

No special method of felling or bucking is employed because the logs are dragged by tractors. However, to elevate efficiency of tractor operation, the following can be considered:

- a. It is generally regarded better to allow trees to fall at angles between 30 and 45 degrees from the road with the undercuts facing the road. Tools for pulling are sometimes used to control the direction of the falling trees of large size.
- b. If tree tops can be arranged to fall in the same direction, they facilitate logging operation.

Because:

1. It is easier to wind slings around tree tops.

The tractor drivers can do the job requiring no choker man.

Figure - 18

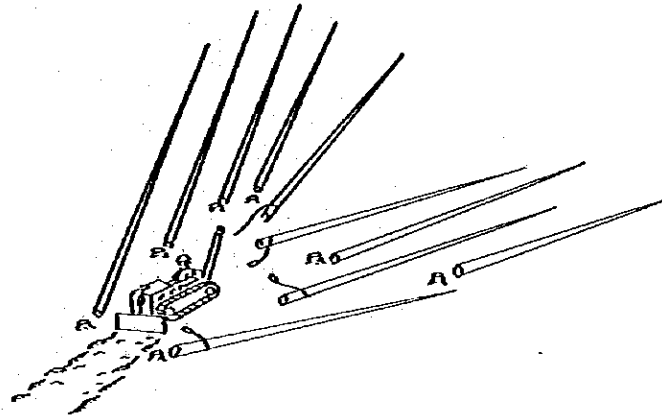
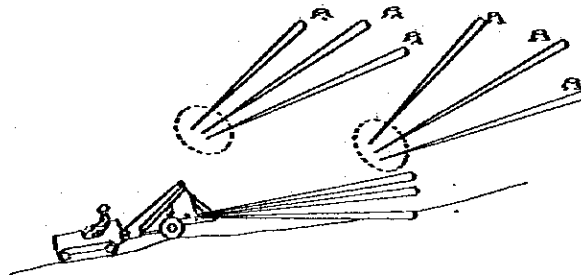

Figure - 19



2. The longer the trees, the shorter the logging distance.
3. When pre-logging is conducted by winch, the tree tops can be lifted from the ground, and thus no obstacle gets in the way.

In an artificially grown larch tree forest, the trees can be dragged with bucking branches. A considerable amount of branches will be snapped off by merely logging. There are times when the tree tops break away, but this will in no way affect the quality and volume of logs in conclusion.

4. A greater logs can be handled at one time.
5. They would cause less damage to the spur road.
6. They would cause less shock to the winch.

While there are advantages as mentioned above, there are disadvantages, too:

1. As the trees are fallen downslope, logs can be damaged.
 2. The diametes of tree tops must be about 10 centimeters to withstand the pull of slings. Sometimes the tree tops break away during logging.
 3. Towing reaction increases when logging.
- c. The stump should be cut as low as possible. Large stumps often become obstacles for tractor operation.
- d. Logging should be conducted in full stem length as possible. When trees of small diameters are abundant, it is sometimes better to trim off the branches before logging. Because of the branches, the number of trees dragged at a time can decrease.
- e. When work condition demands ground logging, the round undercut of log's cross section should decrease ground logging reaction.

(3) Logging

- a. Logging should be conducted down slope as possible by making the best use of the earth's gravity. When confronted with a countergradient or a mellow ground, the winch should be

loosened to temporarily stop logging. Then the tractor should take up a better position on a solid ground by extending the rope and resume logging.

- b. When running is conducted in the slope, it should follow the maximum direction of tilt as possible and avoid traversing the slope which is dangerous.

(4) Combination Logging by Yarders and Tractors

Some work areas allow the use of tractors for logging while others do not. Therefore combination of use of tractors and yarders must be considered for logging.

Due to topographical reasons, tractors are sometimes disassembled into pieces and transported deep into the forests by yarders. But due to difficult topographical undulation, only yarders can sometimes be used in the forest for logging.

When conducting cable loggings, an appropriate topography are hitherto looked for as a good unloading deck to commence logging operation. However, when tractors are usable, it is necessary to select a good ground for the yarder by considering the use of tractor for making an unloading deck.

In case of combining a yarder and a tractor in logging, either the yarder or the tractor can be chosen to play the major role according to topographical condition and economic reasons. However, when the project demands the work area to continuously penetrate deep in the woods, the tractors should play the major role. Furthermore, the important section of the tractor road

can be improved later as a truck road if the gradient of spur
road's slopes can be easily adjusted for trucks.

6. COMPUTATION OF COST OF LOGGING BY TRACTORS

(1) Theoretical Efficiency of Logging by Tractors

1. Efficiency (logging frequency)

$$N_H = \frac{60 \times \eta_o \times H}{T_o}$$

N_H Logging frequency per day when H hours of daily real working time.

η_o Average operation hour per day

H Real working hours per day (hour)

T_o Time required for one logging cycle (mins)

2. Efficiency (logging volume)

$$W = N_H \times W_o$$

W Volume of logging per day

W_o Average towing volume per one cycle

3. Time of logging cycle

$$T_o = m l_1 \cdot \left(\frac{1}{V_1} + \frac{1}{V} \right) + \frac{l_2}{0.75} \cdot \left(\frac{1}{V_2} + \frac{1}{V_3} \right) + \frac{0.3 l_2}{0.75 V_3} + (2m + 1)$$

T_o Logging cycle time (min)

m Winch line rewind frequency

l_1 Winch line rewind length (m) (pre-logging length)

l_2 Tractor's running distance (one way) (m)

V Winch line rewind speed by man power (m/min)

V_1 Winch line winding speed (m/min)

V_2 Maximum running speed of tractor logging (m/min)
(load, downhill)

V_3 Maximum running speed of dead load tractor (m/min)
(unload, uphill)

In general cases:

$$m = 1 \sim 5 \approx 3 \text{ (on the average)}$$

$$V_1 = V = 12 \text{ m/min}$$

$$V_2 = V_3 = 7 \text{ Km/Hr} = 117 \text{ m/min}$$

(Average maximum speed with load 5 Km/Hr and dead load 9 Km/Hr when using a sulky)

Then the equation will be as follows:

$$T_0 = 6 \frac{L_1}{V} + 3 \frac{L_2}{V_2} + 7$$

In this case, the efficiency curve of pre-logging distance and tractor's running distance will be as follow (Figure 20):

However, the daily operation time is

$$(8 - 1.5) \times 0.7 = 4.55 \text{ hours only.}$$

Figure 20

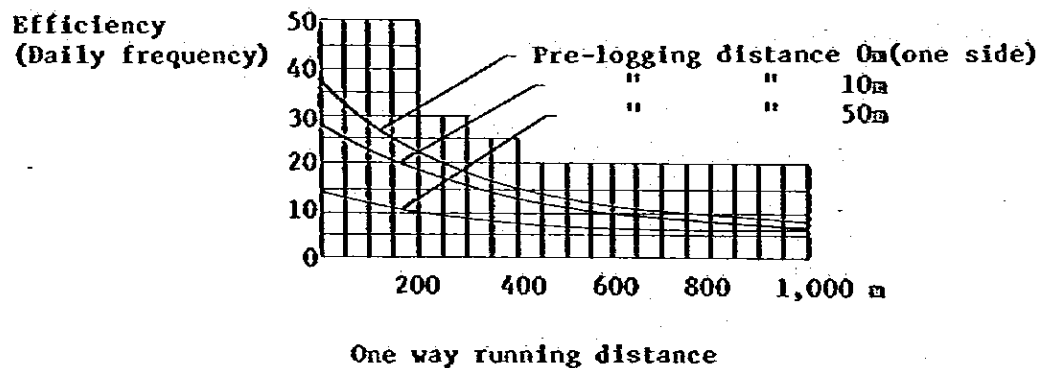

(2) Computation of Cost of Logging by Tractor

Although the logging cost differs according to prerequisites, a computation of cost of an example can be as follows:

1. Work efficiency

Tractor's running frequency (round trip) per day.

In each round (round trip), the pre-logging frequency is between 1 and 5 times, averaging 3 times. And when the tractor's constant running speed averages (with the use of sulky) 7 kilometers per hour. And from figure-20,

Table - 5

Round Trip for Logging per Day

One way running distance	Pre-logging by winch		
	0 m	10 m	20 m
100m	28 round	22 round	16 round
200	22	18	15
300	18	16	14
400	16	14	13
500	14	12	11
600	12	10	9

Logging volume per day:

When one way running is: 50~800 meters, averaging 400m and Winch Pre-logging distance 0 ~ 30 meter, averaging 20m the daily round trips will be 13 times, logging volume per trip $1.5 \sim 2.5 \text{ m}^3$, averaging 2 m^3 .

Then the daily logging volume will be 26 m^3 .

2. Hypothesis of tractor work days

Logging work	160 days
Spur road construction for logging	20 days
Servicing of tractors	20 days
Repair work	15 days
Days off	65 days
Non operating days	85 days
	<hr/>
	365 days

3. Breakdown of cost

Table - 6

Breakdown	Detail	Fixed Expenditure	Variable Expenses	Remarks
Tractor	Angle dozer	100 %	%	Depreciable in 6 years
Towing winch		100		"
Sulky		100		"
Wire rope	Winch line	100		2 years
	Sling Rope Set	100		1 year
Operator Guard		100		6 years
Block	Automatic Snatch Block	100		3 years
Labor cost	Drivers	100		
	Choker man.		100	
	Unloader man		100	
	Measuring man		100	
	Others	70	30	
Fuel, lubrication			100	
Maintenance & Repair of tractors			100	
Other expendables			100	

Table-7 Breakdown of Tractor Operation Cost

Item	Detail	Total Expense	Yearly Cost	Fixed Expense	Variable Expense	Remarks
Tractor	CT-35AD	¥5,350,000	¥891,667	¥891,667		Per day 26m ³ Yearly logging volume 4,160m ³
	Towing Winch	1,100,000	183,333	183,333		
	Operator Guard	490,000	81,667	81,667		
Sulky		500,000	83,334	83,334		
Blocks		20,000	3,333	3,333		
Wire rope	Winch line	21,000	3,500	3,500		
	Sling rope	69,000	11,500	11,500		
Sub-total		¥7,550,000	¥1,258,334	¥1,258,334		Annual Operation Days 180x¥7,000
Labor cost	Driver			1,260,000		Logging days 160x¥7,000x2
	Checker & Unloader man	2,240,000			2,240,000	Measuring man 60x¥6,000
	Measuring man	360,000			360,000	Others 10x¥4,000
	Others	40,000		28,000	12,000	
Sub-total		¥3,900,000		¥1,288,000	¥2,612,000	Shrx180daysx¥407
Fuel & Lubrication		366,300			366,300	3,250,000÷6
Maintenance & repair		3,250,000			541,667	Estimate 2 percent of labor and fuel and oil costs (3,900,000÷
Others		85,000			85,000	366,300)x0.02
Sub-total		¥3,701,300			¥992,967	
Total				¥2,546,334	¥3,604,967	
Average per 1m ³				612	867	1,479/m ³

4. An example of tractor attachments for logging and spur road construction

Table - 8

Item	Model	Unit	Unit Price	Total Price	Remarks
			Thousand yen	Thousand yen	
Angle dozer	CT - 35 AD	1	5,350	5,350	
Towing winch	TW	1	1,100	1,100	With Fare Lead
Winch Line	Winch Line ASSY	1	21.0	21.0	With 40m & hook
Sulky	LS-3	1	500		
Sling Rope Set		15		69.0	5 each of 2m, 3m, and 4m
Operator Guard	OG	1	490	490	
Automatic Snatch Block	BSA - 4	1	21.0	21.0	
Total				7,051.0	
Logging Tower	TC		444		
Double Winch	DN		200		

5. Estimation of fuel and oil consumption

Table-9 Fuel and Oil Consumption per hour

Item	Consumption volume per hour	Unit price	Total cost
Light oil	4 liters	46 yen	184 yen
Engine oil	0.15 liters	500 yen	75 yen
Gear oil	0.1 liters	1,200 yen	120 yen
Turbine oil	0.05 liters	180 yen	9 yen
Grease	0.04 kilograms	480 yen	19 yen
Total			407 yen

Year Expense: $Y407 \times 5h \times 180 \text{ days} = Y366,300$

Furthermore, the unit price of tax-free light oil for forestry use is between 43 and 47 yen per liter.

6. Maintenance and Repair Cost

Although the cost depends greatly on operating conditions, tractor handling techniques, daily upkeeping and other conditions, it differs greatly in each tractor.

Generally, the maintenance and repair cost is estimated within 50 to 100 percent of the purchasing price from experience during durable years.

According to the Caterpillar Handbook, the cost is set between 80 and 100 percent depending upon the conditions of being used, while the FAO Guidance Committee estimates the cost 100 percent.

Past records say Caterpillar 40PS in bad conditions requires ¥826 per hour (\$3.6/hour) for maintenance and repair.

The Japanese Forestry Agency estimates the maintenance and repair cost for CT-35 per hour as follows:

Maintenance and repair cost until renewal: ¥4,300,000 (81%)

Durable hours: 5 hours x 180 days x 6 years = 5,400 hours.

The cost per hour = ¥4,300,000 ÷ 5,400 hours = 797 yen.

Therefore, the total maintenance and repair cost is roughly estimated at ¥4,300,000.

7. GIST OF EARTHWORK BY BULLDOZERS

Tractors in forestry operation are always involved in earthwork in one way or the other such as spur road construction and banking ground construction.

Here is an itemized list of precautionary points and others with regards earthwork by bulldozers.

JUDGING OF WORK IF APPROPRIATE OR NOT

1. Based on soil analysis and moisture content, if work is judged inappropriate, bulldozers should never be used. And when considered suitable, bulldozers should be mobilized at once.
2. When soil is silt and wet clay, work should be conducted only on fine days.

BULLDOZER DRIVING

1. When attempting a climb, bulldozers must be driven straight up the slope. Be aware of icy slopes where grass and bamboo grow. They are very dangerous.

Figure - 21

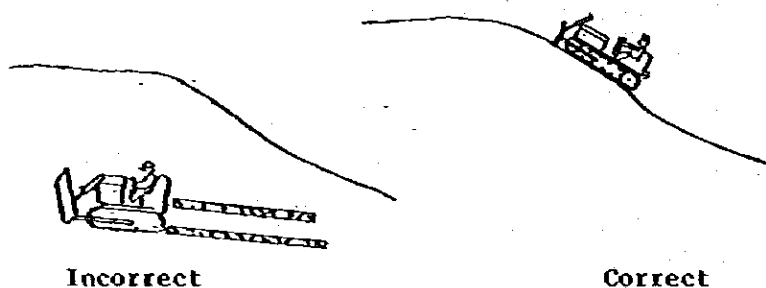

2. When transferring bulldozers, the units must be driven with the dozers lifted about 30 centimeters from the ground. This protects the crank-case from being damaged by obstacles. Be aware of obstacles of over 15 centimeters near the inside of the shoes.
3. When travelling over damp or mellow ground, the bulldozers must be driven half-throttle while softly applying the main clutch.
4. When travelling in water, the water level should never exceed the height of the top idler spindle.

Figure - 22

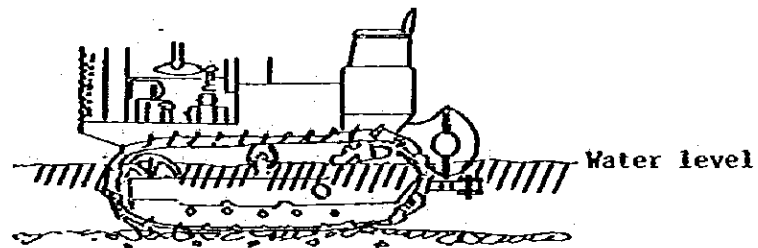

CHANGING OF DIRECTION DURING WORK

1. Bulldozers should never be steered under overloaded condition with dozerful of earth. It must first be backed down, then steered in the necessary direction and propelled forward to resume work.

Figure - 23

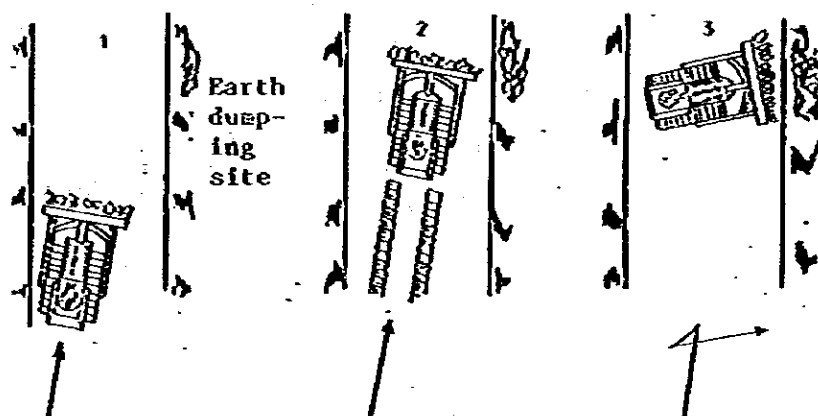

2. Never steer the bulldozer while backing down. (When soil preparing ground and embankment are mellow) It must be driven forward to the destination.
3. Never steer rapidly on sandy soil or gravels.
4. Steering should always be avoided when traveling in damp ground.

CUTTING AND CARRYING OF SOIL

1. When constructing spur roads or roadbeds along the slope, the work should commence from the top of slope. It is the basic rule of bulldozers to make the best use of gravity and work down the slope.
2. When the bulldozer is felt to be level with the ground, the dozer should be lowered to commence cutting or carrying of soil.
3. Always be prepared to make prompt judgement on the depth of cut according to the quality and moisture content of soil.
4. Exert efforts not to roughen ground surface to expedite drying of soil to be cut.
5. The thin dry layer of soil should be collected and used for embankment or road bed construction.
6. To avoid forming of water pools by rainfalls and others, cutting of soil must be conducted by leaving a gradient to allow natural drainage of water.
7. Carrying of soil, as a rule, must be conducted within a distance of 20 and 30 meters. If the distance exceeds 50 meters, the work efficiency deteriorates.

8. Maximum volume of soil must be carried at a time.
This is possible by first cutting soil one or two times, stocking them in the front and then carrying them together with the third cut soil.
9. Never forget to build a path for the bulldozer while carrying soil. Once an undulation occurs, it is painstaking to level the ground again.
10. Carrying of soil can be conducted at slow speed. But, when backing down the tractor, it must be conducted at high speed.
11. When carrying soil upslope, the limit of grade is 20 degrees.

EMBANKMENT AND COMPACTION

1. When dumping earth downhill, the push must be continued until the last piece of soil falls off. Then the bulldozer can back down.

Figure - 24

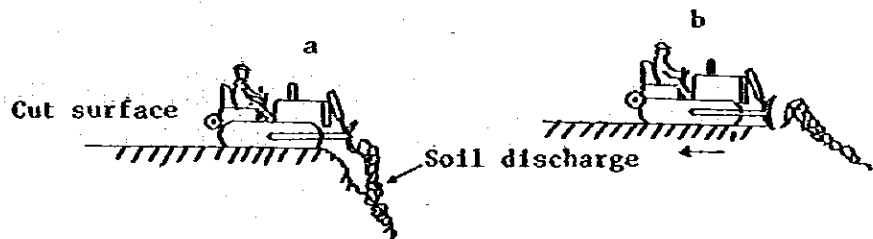

2. When a bulldozer travels backward up a soft embankment slope, the dozer must face downwards to serve as a brake in case of slipping down. When the dozer is lifted high up, it can cause damage to the steering system in general.

Figure - 25

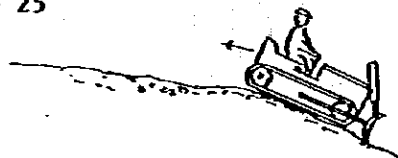

- When earth moving work is conducted along a single direction, an angle dozer can be fitted to run along the outside of the roadside at about 30 to 50 centimeters to allow earth to drop off from one end.

Figure - 26

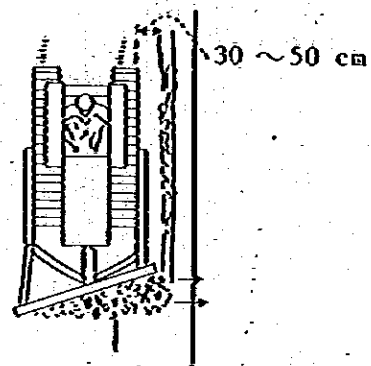

- When spreading earth, a reasonable amount of earth should be allowed to escape from underneath the dozer with a thickness apt for compaction.

Figure - 27

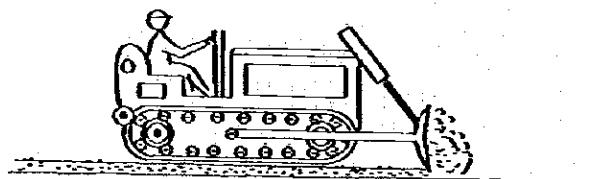

- To allow embankment and compaction work to proceed at the same time, the tamping of banking by shoes should be done at each 15 to 20 centimeters in thickness.

Figure - 28

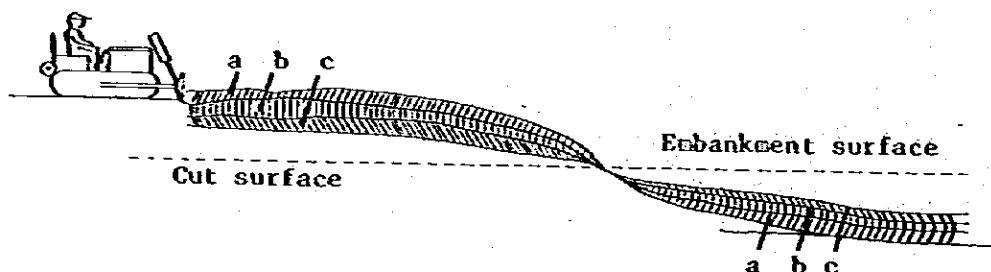

6. Where there is a clay layer, it is important to finish each rolled-fill layer surface convexly to prevent leaking of water into each layer of the embankment. When soil contains a large amount of clay, compaction must be conducted by bearing in mind the drainage of water. Otherwise, rainfalls can hamper even bulldozer operation. Earthwork on subsurface soil and clay should never be done during the rainy season and winter.
7. Although differing by soil conditions, compaction must be repeated at least 5 times at the same site. If deemed necessary, the tractors should be driven back and forth about 7 or 8 time.
8. Do not conduct compaction work when shoe tracks glisten or rolled-fill soil becomes colloidal.
9. When method that makes compaction difficult is employed, tamping becomes impossible at later time. Method which makes compaction impossible is when the height of embankment is too high as shown in the following figure:

Figure - 29

(Compaction is impossible when embankment is too high)

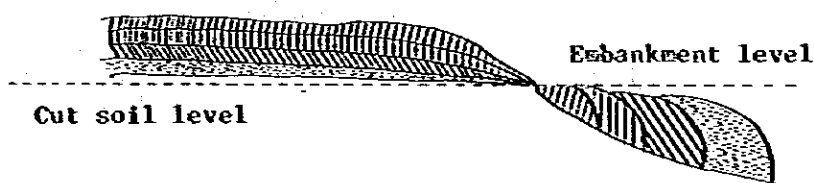

COMPLETING

1. When finishing a flat ground surface, confirm that the shoes are level with ground before lowering the dozer.
2. When smoothing rough ground, the dozer should carry about half a load of soil. By moving the dozer up and down in concert with the undulation of the ground surface, the earth escaping from underneath the dozer will evenly cover the ground surface.
3. For the final finish, the dozer is lowered to slightly be in contact with the ground, and then the tractor is driven backward.

FELLING

1. When felling trees of up to 10 or 15 centimeters in diameter, the dozer can be lifted to push the tree down. Then the dozer (tip-of-dozzer-blade) is lowered to uproot the trees.
2. Wind the wire rope at a proper position of the trunk, and fell the tree by pulling the rope with a winch.

DRAWING OF ROOT

1. For a stump having a diameter of less than 20 centimeters, first raise it by pushing the exposed portion with the blade and by the earth-moving plate. Then, force in the blade and under the root and push the stump as if to dig it out of the ground.
2. Before felling trees of between 40 and 100 centimeters in diameters, the root should be dug from all sides and then cut.
3. Roots that are hard for dozers to tackle can be uprooted with the help of wire ropes and heel blocks.

4. After tree felling, stumps can be left intact as standers.

It is better felling tree with stump than cutting stump before felling.

ROCKS

1. Large rocks must not be tackled squarely. A hole is dug at a side of the rock to allow the rock to roll by itself with its own weight.
2. When a large rock is trapped between small rocks, the small rocks must first be removed and then the large rock taken care of.
3. When pushing a rock over a slope, signboards indicating danger should be posted downhill and safety should be confirmed before commencing operation.

STEEP SLOPE OPERATION

1. Never traverse along the slope where gradient is steep.
2. When climbing a steep slope or a rocky hill, a wire rope should be fasten to a solid object to facilitate the climb by winding the winch. (backward driving)
3. When descending a steep slope, the dozer must be used as a brake.

Figure - 30

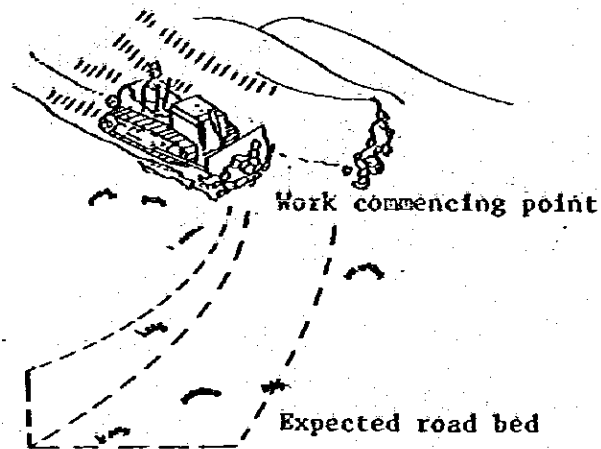

4. Where it is exceptionally steep, work must be conducted by anchoring wire rope of winch to the tractor.
5. When building roads in hill sides, the stakes along the top of slope should be used as a criteria for rough earth scraping. As the earth is repeatedly pushed over downhill, the earth scraping work continues until reaching the expected roadbed.

Figure - 31

Stake on top of slope

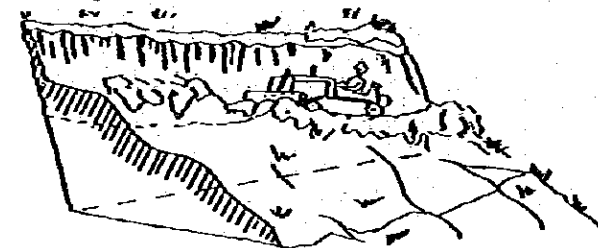

Expected road bed

6. The earth moving work must be conducted by bearing in mind the finishing gradient of the face of slope.

For example, when the grade of slope is to be 1:2, the earth is dug 30 centimeter deep at each 60 centimeter width interval forming a stepped foundation.

Figure - 32

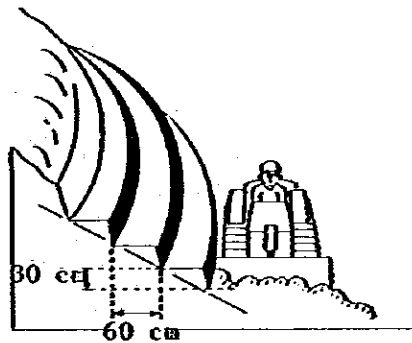

JUNCTION OF EMBANKMENT AND CUT

1. Especially plants and top-soil of the cut earth at the junction must be removed to prevent later landslides.
2. Thorough checking of water, leakage and inundation at the junction must be done. And measures must be taken to prevent breaking away of surface soil during compaction by providing drainage ditch, etc.
3. When employing a one-side-cut and one-side-embankment method, it is necessary to further scrape the finishing surface to completely conduct compaction of embankment.

Figure - 34

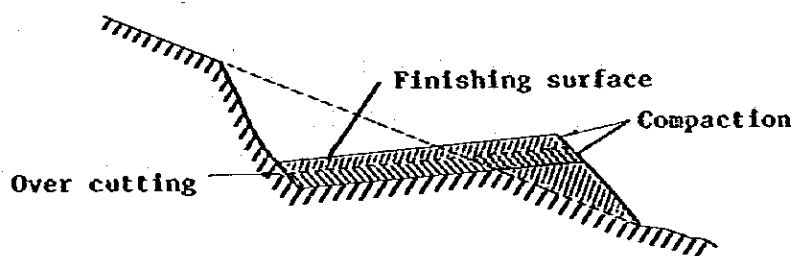

OTHERS

- 1. As road construction work in forest land is conducted in limited and narrow space, it is very inconvenient. However, if flat and spacious work area away from the road building site can be given and secured, it, in many cases, increases work efficiency of bulldozers.**

8. TO INCREASE WORK EFFICIENCY

(1) To Heighten Work Efficiency of Tractors

Despite excellent quality of tractors, elevation of work efficiency of the units is impossible if annual operating hour is small. In forestry work, it often happens that both the annual work days and annual operating hours of tractors are liable to decrease. If possible, efforts should be exerted to mark at least 1,000 hours as annual operating time.

To do this, a thorough pre-operational planning is necessary. The planning includes, selection of tractor models, various work arrangements at the job site, sufficient overhauling and servicing of tractors and well-organized total work plan minimizing sub-operational work, etc.

(2) Simplification of Work Program

For example, the conventional process of tree-felling, branch trimming, pre-logging and logging can be simplified into one work process of binding and winch winding based on full stem length logging method. Further, when sled becomes unnecessary, it eliminates loading work.

Also, building loop roads, eliminating switch back operation of tractors, and servicing spur roads, serve to simplify work program.

(3) One Man Operation

When a number of people are assigned to tractor work, it results in the increase of unnecessary work processes. And the more the manual work is involved in tractor operation, the more the total

work hour becomes unavailable for both the machines and people. This results in the decrease of productivity.

(4) Programming of Work To Elevate Tractor Work Efficiency

The days are gone when machines were considered substitutes of manpower or animal power. The application of a work order and program most appropriate for each work machine is the key to rapidly elevate machine work efficiency.

When a 48-ps class tractor was first used for full stem length logging, a man said it replaced the work of 15 horses. Then an American document says a 30-ps tractor does the work of 18 horses. In conclusion, the good or bad of a work setup makes a great difference in total work efficiency.

(5) Less Secondary Work

Despite improvement of tractor operation efficiency, if the machines are involved too much in secondary work such as travels and long-distance spur road construction, the work rate of the main operation drops to an unexpectedly low level. This is also true when work sites are spread sporadically and also when forest road density is small. When large sized tractors are used, they are liable to be used more frequently in secondary operations, thus drops average efficiency. Furthermore when work arrangement is bad, the main work operating efficiency also drops rapidly.

(6) Improvement of Driving Technique

- a. One of the prerequisites to improve machine work efficiency is thorough education of those manipulating the units.

It is important to introduce an incentive program to encourage drivers to constantly improve their driving techniques.

- b. If possible, the drivers should be instructed to read the operating manuals over and over for thorough understanding.

Especially, when drivers are newly replaced, this should be stressed. Also, the outgoing driver should hand over all necessary information with regards the peculiarity, servicing condition and other pointers of the machine to the incoming man. Mere possession of car driving technique is not enough.

- c. Each tractor should be assigned with one driver or a driver and an assistant driver. It helps a lot if each driver's name is posted at the body of his tractor. This method not only adds responsibility to each driver, but people at the work site will remember his name and will be encouraging to the driver.

Also when a tractor requires servicing, the serviceman from the manufacturing company knows who to exactly speak to and explain.

- d. By having a thorough knowledge of the tractor's features and capacities, the driver can learn to operate the machine efficiently within its limit. For the purpose of that the driver should sufficiently increase the engine's rotation. At any rate, a good driver knows how to minimize irregularity in work process and to save fuel consumption.

(7) Handling and Servicing of Tractor Should Be Thorough

a. New Machine

- (1) The driver in charge should read the operating manual repeatedly before trying the new machine.**
- (2) Until the first 60 to 100 hours of operation, a new machine should never be subjected to severe operation and full-capacity work.**
- (3) The engine, driving mechanism and other important parts should be occasionally checked for any loose bolts and nuts. If any, they must be readily re-tightened.**
- (4) Follow the indicators on the meters in changing engine oil and grease. As the good or bad of "break-in" running of new machines determines the life and running conditions of the units, experienced drivers should be assigned to the newly purchased tractors.**

b. Maintenance and Servicing

Regular maintenance and service of tractors are a prerequisite. The machines should always be housed in a condition to readily engage in operations.

1. Daily Servicing

Pre-work and post-operation check ups.

2. Weekly Servicing (or each 30 hours)

3. Monthly Servicing(or each 120 hours)

4. Seasonal Servicing

Changing of engine oil and grease of correct viscosities.

5. Overhaul

Overhaul should be conducted once every year or at each 1,000 - 1,500 hours of operation. This is to prevent mechanical failure of machines during peak periods of work.

c. Special Duty Work (Including working in water)

1. After the end of each day, parts that were in contact with water require oiling and greasing.
2. Check for any water leaks in the steering case, differential gear case and others to readily discharge water and oil.

d. Other

When a tractor's working condition deteriorates, something is always wrong. The work should be stopped at once to troubleshoot the cause to prevent secondary failures.

9. DISASTER PREVENTION OF TRACTOR LOGGING

1. Examples of Accidents

(1) Lack of understanding of tractor manipulation and mechanism.

- a. While a driver is away, an unauthorized chainsaw man can drive a machine over a cliff to die.
- b. A 30-degree angle is normally enough to overturn a tractor. And as the slopes are actually irregular, there are moments when tractors can lose balance and roll over.
- c. There is an actual case when a diesel engine turned reversely.

(2) Lack of signaling.

If signals are waved mechanically between a driver and a checker man, it is meaningless. When motioning signals, both men should confirm that everything is clear for safety.

(3) Lack of proper evacuation

When tractors are conducting pre-logging operations with winch, wire ropes can be cut by the snapping of pre-logging logs, withered trees in the area, tree branches and others. Due to misjudgements of the situation with regards the position and place of refuge, disasters occur.

(4) Poor Ground Conditions

When a driver alights and boards a tractor, he looks into the engine to check the running condition, he is liable to get hurt by slipping his feet. This is often true right after a rain. The driver must be careful of his footgear.

(5) Mistake in work method

A driver once attempted to move a wide steel sled upslope by pulling a wire rope through a standing tree. When he operated the winch, the sled bumped against a stump to cause the standing tree to fall on the driver's head to kill him.

FOR DISASTER PREVENTION

- (1) A tractor driver must be a license bearer.**
- (2) Only tractors that passed the legal inspection should be used.**
- (3) When conducting periodic overhaul of tractors, as a part of the driver's training program, the driver should serve as an assistant to the mechanics to receive lessons for safety sake.**
- (4) All workmen except drivers should wear red arm bands and be given a whistle. The arm bands can be used as red flags and also serve to brace up one's sleeves.**
- (5) A periodic monthly patrol team composed of specialists should be organized and dispatched to the various work sites to diagnose each machine, make simple repairs and offer technical guidance to the people on the job.**

2. Other points emphasized for disaster prevention.

- (1) Employee Training.**
- (2) Ground pre-logging by winch.**

It is necessary to pay special attention to the excessiveness of tractor's engine strength with regards the necessary output of

traction by towing winch. Depending upon the haul, although the r.p.m. of engine may decrease, it still may give excessive strength to traction causing side slip of logs or giving no time for workers to take refuge as they are pulled towards the winch.

(3) Breaking of winch rope.

(4) When blocks are used:

People should never enter the inside dead angle of ropes. And attempts should be made to only allow the standing trees to enter the inside dead angle.

Avoid using double block as possible. Although the block may double the traction strength, it also tugs in branches and roots of trees. When trying to remove them people can be caught in block to get hurt.

10. SPECIAL WHEEL TYPE LOGGING TRACTORS

The activity of the Timber Jack tractors in Canada has triggered a world-wide boom. Similar special type tractors are being mass produced the world over. The features of this type tractor will be explained in the following four sections.

1. Characteristic of logging tractors.
2. Features of a logging tractor.
3. Wheel tractors viewed from logging efficiency.
4. Position of 'logging work' in the future.

(1) Characteristic of logging tractors.

The main point here is whether the characteristics of the tractors required for the logging work is ability to do heavy work in limited narrow places like Japanese sumo-wrestlers, or to run a long distance like athletes.

- a) Records of logging work in Hokkaido in the past (around 1957) show that the longest logging distance was about 2,000 meters and the average distance was about 800 meters, quite a long distance.

However, in recent years, records show that the longest distance is about 800 meters while the average is between 350 and 400 meters or less.

During the days when long distance logging was required, the tendency was to construct forest roads of higher density as possible. This shows that the tractors have started to be

recognized as wrestlers to do logging instead of athletes running a long distance. This can be easily understood by the fact that the crawler-type bulldozer widely used in logging was considered the most representative heavy machine for heavy duty work such as earthmoving, etc.

- b) Although the logging function of crawler tractors was highly recognized, they were not totally free from doing long distance running work. This afflicted the crawler tractors and also those who wished to plan an economical layout of a network of forest roads.

To add a 'running' function to a wrestler type tractor, for instance, the CT-35 models were designed with a driving mechanism of a class larger to fit in various forest work.

However, to expect wrestler-type crawler tractors the activity to come near a fallen tree deep in the woods where the terrain is irregular and the mobility to follow each different route of differing ground conditions were nearly impossible.

But to strengthen the function of approaching a fallen tree in deep woods by shortening the logging distance, the tractors will strongly bear the nature of being 'running' types.

- c) Logging work by tractors is not limited to pre-logging and logging but also includes spur road construction, earth work and even forest road building for trucks.

When studying the 1965 figures of tractor operation engaged in work at Japanese National forests, 35 percent of total work days were taken up by work besides logging. The logging tractor is required to do wrestler's work by all these secondary heavy operations.

d) Wheel tractors, more or less, belong to the "runner" type, and they were hitherto considered unfit for logging and hillside operations. The main reasons were:

1. Ground contact pressure is high.
2. Driving force is small.
3. It slips easily and thus dangerous.
4. Turning radius is large.

Naturally, other reasons were quoted. But if all these problems can be solved, the wheel type tractors have a great potential to drastically improve logging efficiency.

e) 'Logging', a forestry term, in general, means to transport loads. Pre-logging means to gather cargo while the hauling machine is resting. And log dragging means transportation.

In cargo transporting industry, as a part of its rationalization program, containerization and palletization are becoming widespread by uniforming the size and volume of cargo.

However, logs bear the nature of being the opposite.

Although pulp materials can partly be palletized, the majority of logs are irregular in size. And if attempts

are made to regulate their size, it may lead to the increase in production cost. And, perhaps, the development of machines exclusively for logging may help a little in solving these problems.

Mechanization of forestry work was hitherto considered as the increase in use of general purpose machines in all facets of work to realize improvement of work efficiency. But, machines should be made to thoroughly conduct the main work first, and then be used for other secondary operations. The time has come for those concerned in the industry not to expect too much from the general purpose units to drastically lower production cost.

f) However, on the other hand, special purpose machines may not be able to satisfy sub-work in the main operation. For example, the following types of work are suitable for crawler type tractors:

- * When work require more traction than speed. For instance, road construction, embankment construction, etc.
- * Climbing of steep slopes (The speed, a feature of a wheel tractor, will be canceled out.)
- * Winch winding work at a steep slope.
- * Work at sites where ground contact pressure should be extremely low.

(2) Features of logging tractors

Wheel tractors exclusively for logging are becoming rapidly popular throughout the world. Here, T-50 is explained.

(A) Features of its structure and its characteristics.

1. Employment of articulated structure (joint type)

- (a) The duck walking type by swaying to left and right prevents slipping of tractor on slope and increases climbing ability and ability to escape from sea of mud.**
- (b) Pivot steering shortens turning radius. And riding comfort increases as the rear tires follow the front tire tracks.**
- (c) Easy to face winch load by swaying of body even when making a stop.**

2. Employment of ultra-low pressure giant-size tires.

(Inflation pressure: 1.2 - 1.5 Kg/cm², outer diameter is about 1.5 meters)

- (a) Low ground contact pressure.**
- (b) Low running resistance.**
- (c) High ability to climb over obstacles.**
- (d) Guaranteed traction power.**
- (e) Improved riding comfort.**
- (f) Less repair work.**

A number of tractor makers abroad list the employment of giant-size, low pressure tire at the top of all features.

3. Employment of oscillating front axle, no-spin rear axle and four-wheel drive.

(a) All four wheels are always in contact with ground enabling the ground contact pressure of all wheels to be the same and thus prevents racing and gives additional ability to escape from muddy ground.

(b) The ability of each single wheel to climb over obstacles has increased.

4. Employment of special logger's tire.

(a) Structure of shredded wire prevents punctures and blow outs to increase longevity of tires.

(b) Special tread pattern prevents clogging, increases traction with additional mud discharging ability, prevents slipping and strengthens ability to climb over obstacles.

5. Employment of center brake

A single disc brake positioned at a certain height serves as a center brake system preventing damage of hydraulic piping caused by tree top branches of felling trees.

6. Employment of integral arch.

By mounting the function of trailer-type sulky, the mobility force increased.

7. Introduction of a special blade.

The blade lifting height is 1.3 meters (two times that of the crawler type tractors). This has drastically increased her performance to neatly arrange the full-stem length logs at the bucking yards. This also enables easy measuring and bucking of logs by confirming their defects (cracks, rots, depressions, dents) to simplify the work process from chainsawing to bucking.

(B) Comparison with crawler type tractors.

When comparing the T-50 model with a crawler type model of the same class, it will be as follow:

Item	Crawler	T-50	Remarks
1. Running speed (Km/h)	2.5 10	2.2 27	⊙
2. Transportability			⊙
3. Minimum ground clearance (cm)	30	49	⊙
4. Mobility			⊙
5. Obstacle climbing over height (cm)	25	49	⊙
6. Single wheel obstacle climbing over height (cm)		56	⊙
7. Trafficability			○ To repeatedly run on the same road
8. Escapability			⊙ Ability to clear away from muddy ground where crawler slips.
9. Muddy ground (cm)	40	60	
10. Wading depth (cm)	50	80	
11. Fresh snow depth (cm)	40	60	

12. Backward driving ability			⊙	When compared with crawler type with sulky
13. Ground contact pressure (Kg/cm ²)	0.4~0.6	1.2~1.5		Ordinary truck tire is between 6 and 6.5
14. Adhesion drawbar pull	○			
15. Climbing ability	○			
16. Easy manipulation			○	
17. Riding comfort			⊙	
18. Earthwork performance of blade	⊙			
19. Lifting of logs	70~80 cm	130 cm	⊙	
20. Rope height of integral arch (cm)	100	219		In case of winch fare lead
	200			In case of sulky
21. Maintenance & Repair Fee			⊙	
22. Working rate			○	

(3) Wheel Tractor When Viewed From Logging Efficiency

$$\text{Logging cost} = \frac{(\text{Cost per unit time}) \times (\text{Cycle time} + \text{idling time})}{\text{Logging volume at each time}}$$

When the volume of logging at a time is the same, the following points are necessary to improve efficiency:

A: Decrease of cost per hour.

B: Decrease of cycle time and idling time.

a. Shortening of extension distance of winch line.

b. Decreasing of detours and direction changings.

c. Increasing of running speed.

d. Decreasing of running distance. (But, when the total cost is the same, a larger work efficiency can sometimes be

gained by longer running distance.)

(A) Decrease of cost per hour.

The existing state of things is that of all tractor expenses (repayment expense, maintenance and repair expense, fuel and oil expense, and driver's wage, etc.) the repayment and maintenance and repair expenditures account for 65 to 70 percent. The repair costs especially become a problem. With regards the repair expense rate during durable years, both the FAO Guidance Committee and Caterpillar Company set it at 100 percent for the crawler type and 60 percent for the wheel type. In short, the wheel type is by far less expensive in repair than the crawler type.

This is, perhaps, relevant to the number of parts used to make up the tractors. For example, T-50 is made up of about 4,000 parts while a crawler-type tractor of the same capacity of about 6,000.

Also, the on-the spot inspection which continued for three months revealed that not a single bolt loose was found in T-50, another good feature of this type. Incidentally, it is commonly regarded that the majority of mechanical failures are said to derive from loose bolts.

It is anticipated that labor costs will continue to climb in the years to come. However, as logging tractors can make their way closer to the tree felling site, tractor drivers will soon be able to conduct binding work to open the way for one-man operation in the near future.

(B) Decrease of cycle time and idling time.

(a) Shortening of winch line extension.

In case of a tractor pulling a sulky, pre-logging work occupies about 30% of the cycle time. And the work is quite irregular.

In case of a crawler-type tractor pulling a sulky, when there are obstacles like tree branches in its way at the approach, it has to repeatedly switch gears back and forth to remove the obstacles with a dozer or to make a detour. Moreover, it has to change directions at the best point and back down the sulky towards the logs for about 5 - 40 meters (the average distance is between 10 and 15 meters). This distance at places where tractors find difficulty in making an approach requires extra rewinding of winch rope to worsen efficiency.

On the other hand, in case of a logging tractor, as it can near the tree felling site much easier than the crawler type, winch wire extension distance can be reduced drastically. Also when arriving near the tree felling site, lifting of one end of the log can be done much earlier to decrease ground logging reaction and to enable full-stem length logging of king sized trees.

(b) Decreasing of detours and direction changing operations.

Detours can be minimized if tractors have ability to

climb over obstacles such as tree branches and stumps. Also, backward driving at rough terrains can be minimized owing to easy direction changing operations.

(c) Increasing of tractor's running speed.

Actual running tests of T-50 in Numata, it has excellences in running speed than the crawler type as follow:

12° slope climbing speed: 44% faster than crawler type.

12° slope descending speed: 27% faster than crawler type.

16° slope climbing speed: 30% faster than crawler type.

Running speed at tree felling site (820 tree stumps per ha) of rough terrain: 30% faster than crawler type.

According to reports compiled in West Virginia in the U.S.A, wheel skidders were twice faster than crawler skidders when pulling loads, and three times faster when returning to the logging site with dead load.

(d) Tractor's running distance

To reduce only the cost of logging by tractors, it is desirable that the operating distance be shorter.

But when viewed from work efficiency, the running speeds of tractors in both ways have a great bearing.

Also, in view of the fact that it excels greatly in the ability to climb over obstacles than crawler types, the lengthening of logging distance may help in improving work efficiency.

The results obtained from the running tests in Numata show that when the logging distance was doubled, the cycle time only increased 1.57 times.

According to various reports by users of Tree Formers, an American counterpart of T-50, the common logging distance is between 120 and 2,000 meters which is long distance. Examples of logging in a broad leaf mountain forest in West Virginia show that the cost dropped between 10 and 15% when logging distance was over 400 and up to 1,200 meters.

If the speed and mobility, the great features of wheel type tractors, are to be fully utilized, it is necessary to give a second look at the problem of logging distance by tractors.

Also, a quantitative analysis of the economical and operational proficiency of wheel tractors should be conducted to increase productivity of logging at the lowly accumulated forests in South Asia, which are giving rise to a new problem.

(4) Position of Logging Work in the future.

The period of logging machines bearing the characteristic of being independent units is passing by. It is true that logging is only one extracting process of the total lumbering work. But as 'pre-logging' and 'logging' involve a number of difficult factors with the nature of work being irregular and inconsistent,

the logging process hitherto was regarded as the keypoint of all work, and separated from others. Therefore, the work processes immediately preceding and following were contrived to concert with the independent logging process.

However, the introduction of full stem length logging, a result of technical innovation, has given rise to a new problem: confusion and inefficiency of various work at bucking yard.

In the early days, processes preceding logging, (involving branch trimming, length measuring, bucking, diameter measuring, tree-top pruning, and log sorting.) were performed at a hillside.

But today, these processes become done in the logging yard.

The logging yard hitherto considered as a site to pool the logs have taken up a new role. It has to take care of a number of important functions at one time.

Although the work at the tree felling site has been simplified only to tree felling and binding, the work at the logging yard has become diversified and complicated.

To orderly arrange all work in a direct line or in parallel lines and to readily expedite each work process, the introduction of automatic multi-functional processing machines become inevitable. When this is realized, the logging machines, totally divorced from the conventional single function concept, will drastically improve the situation and boost mobility and productivity of all lumbering work.

The wheel-type logging tractors have potentials to advance into this direction. And those concerned should make the best use of these tractors to realize mechanization at the logging yards to boost performance.

In short, it is necessary to make comparative studies on new ideas with regards concept of forest road network layout and arrangement of work method.

