

F. DRAWINGS OF MONITORING STATIONS

F.3 Site C

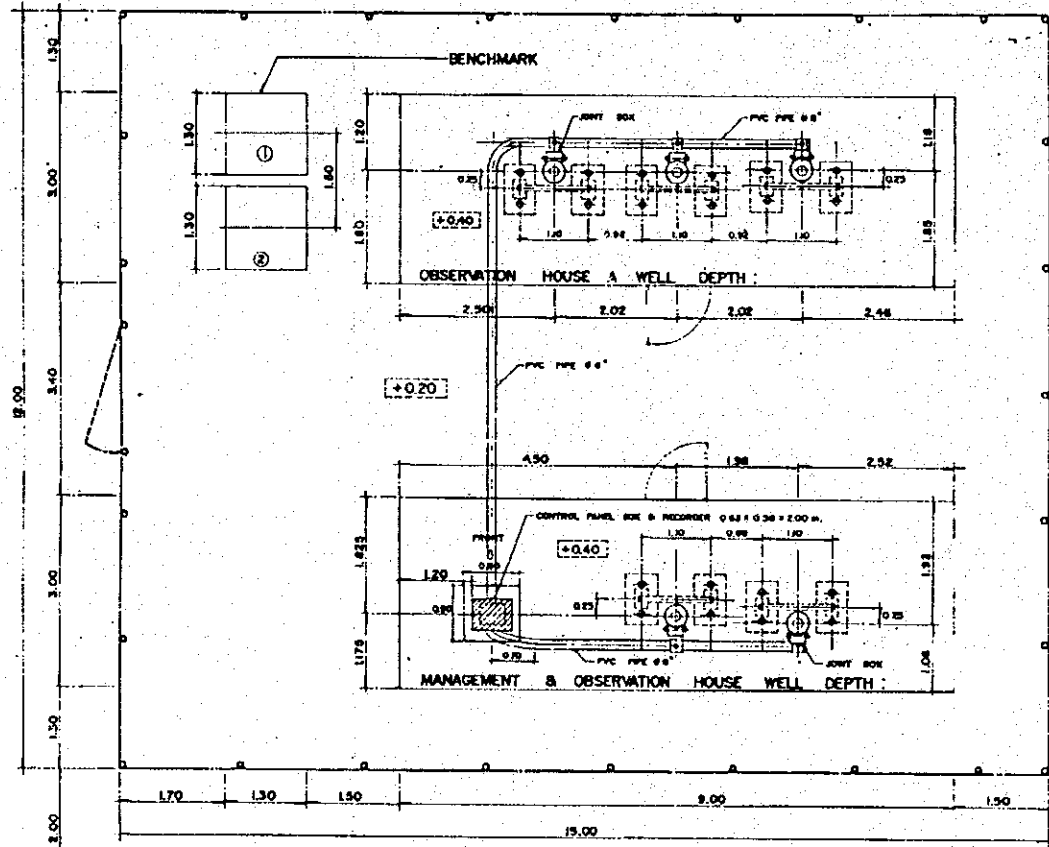

LAYOUT PLAN OF THE OBSERVATION HOUSE SITE C (KLONG KRU)

ROAD ±0.00

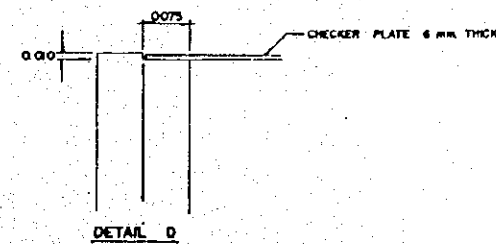
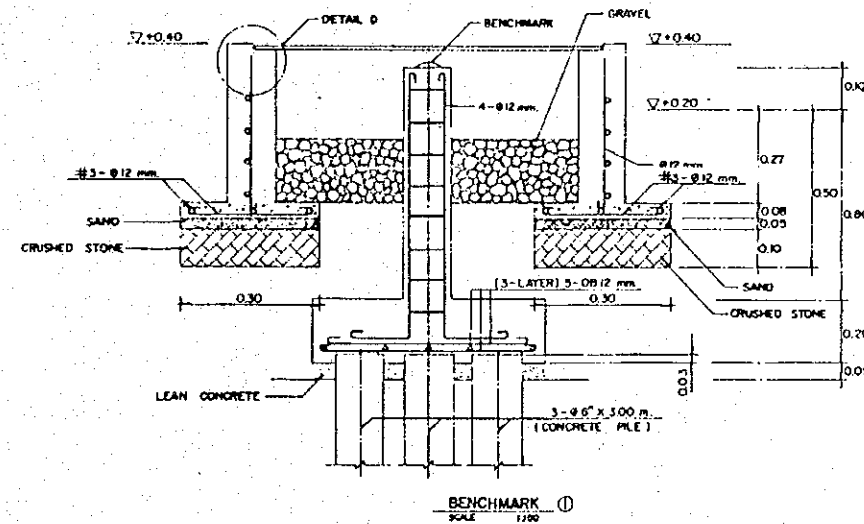
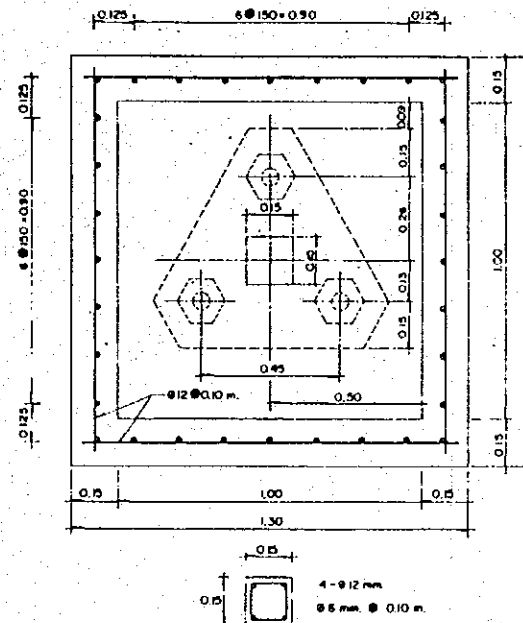

PROJECT: SITE C (KLONG KRU)		
SHOWN	LAYOUT PLAN	REVISION
SCALE	1:50	① 7-6-93
DATE	19-5-93	
CONTRACTOR	SIAM TONE CO., LTD.	DWG. NO. 1/4

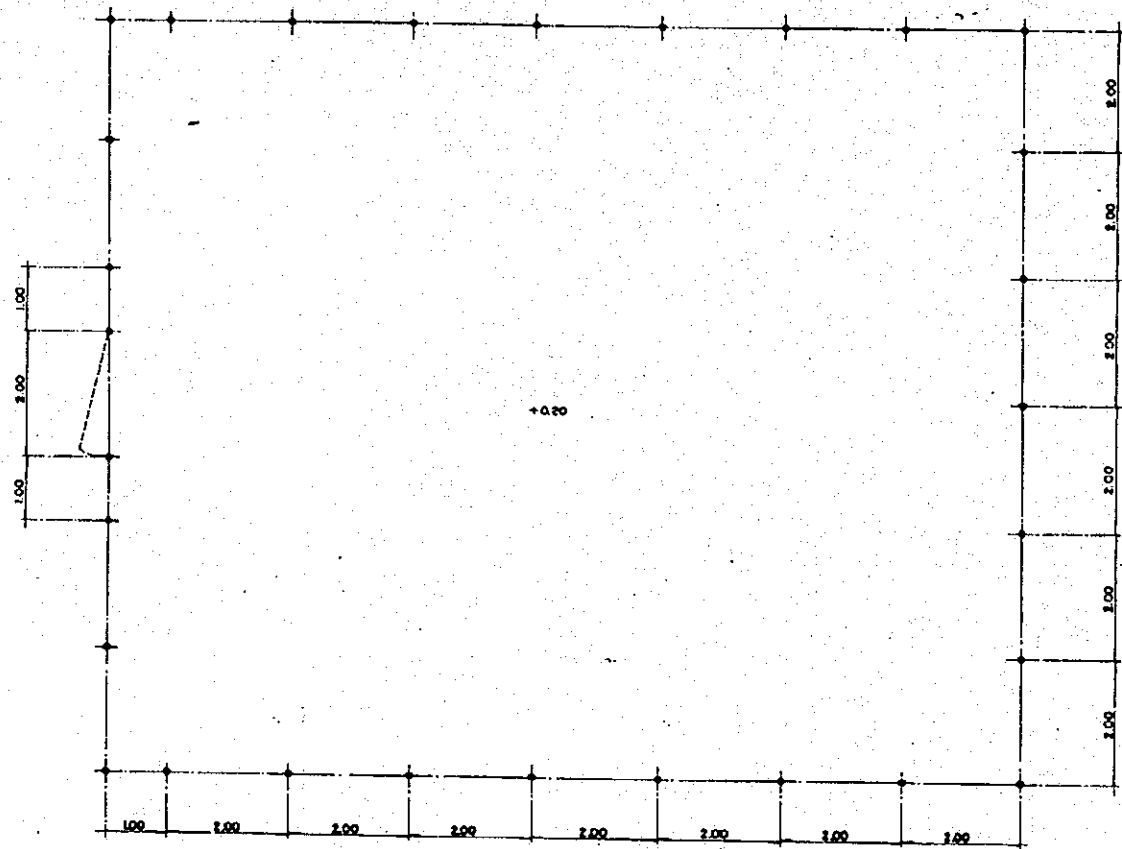

STEEL NET FENCE  
SCALE 1:50

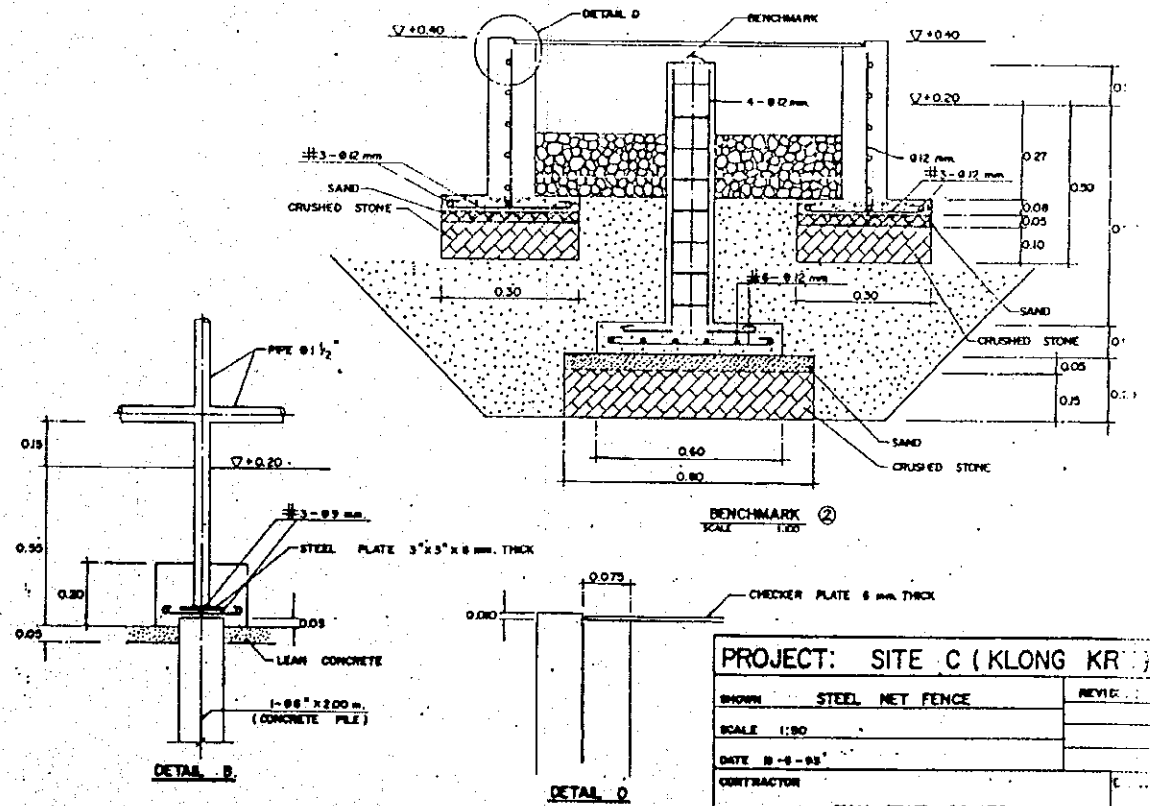
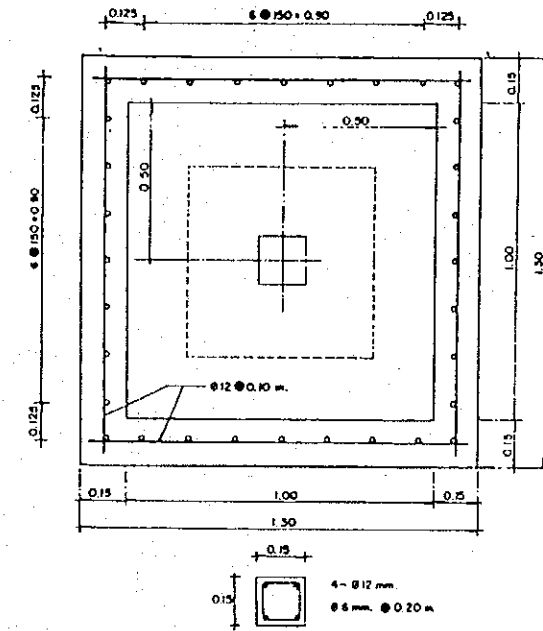
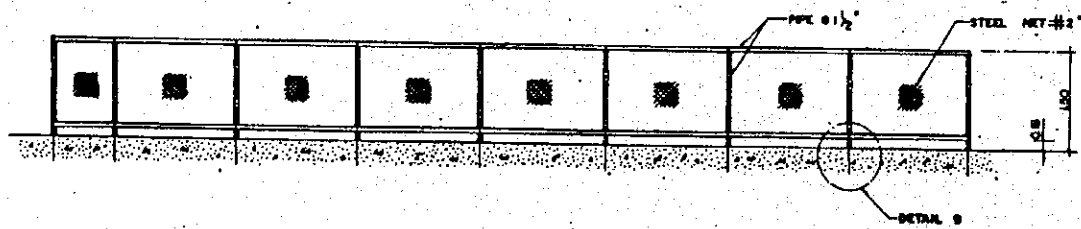

PROJECT: SITE C (KLONG KR...)	
SHOWN: STEEL NET FENCE	REVIEW:
SCALE: 1:50	
DATE: 8-8-98	
CONTRACTOR: SIAM TONE CO., LTD.	

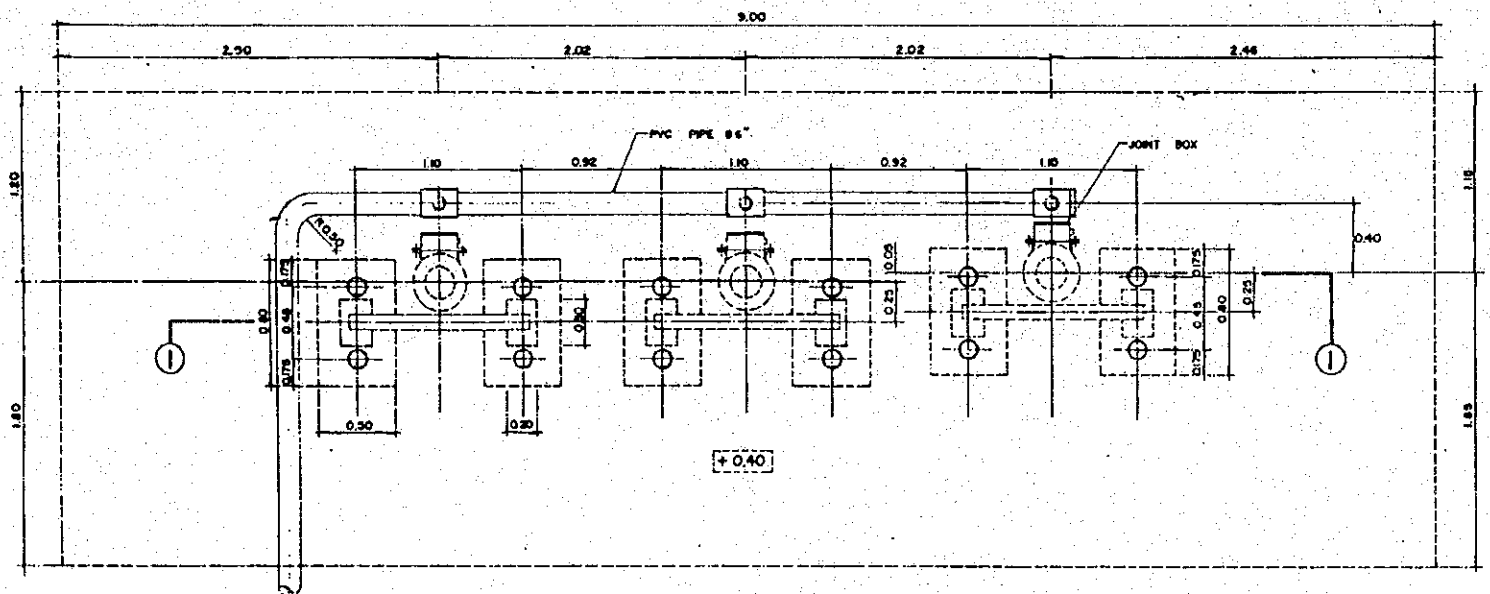

**OBSERVATION HOUSE A**  
SCALE 1:20

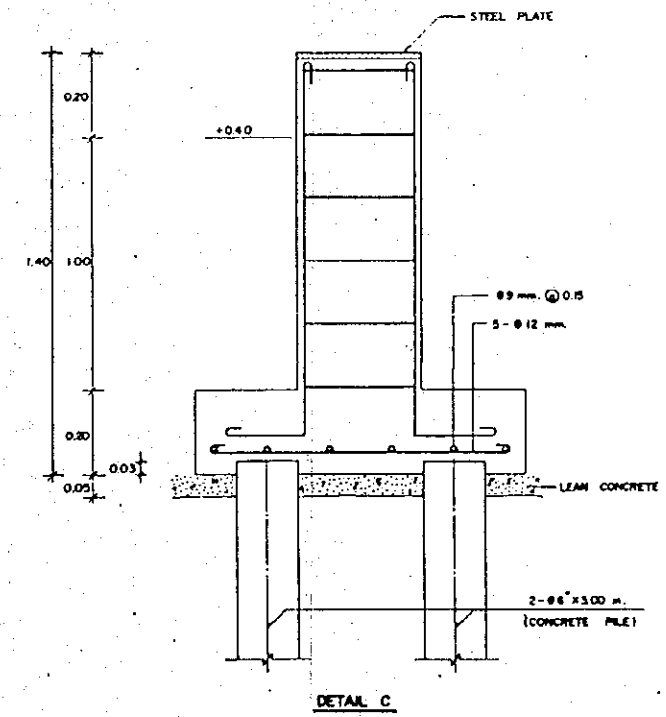
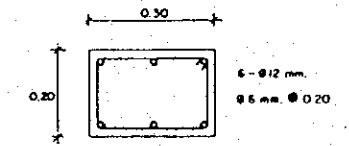
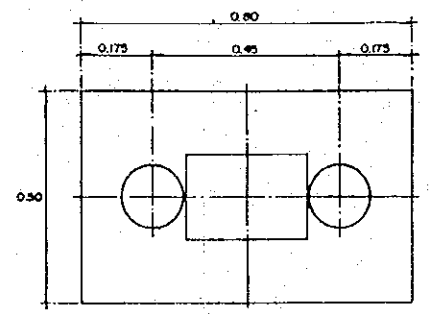

**DETAIL C**

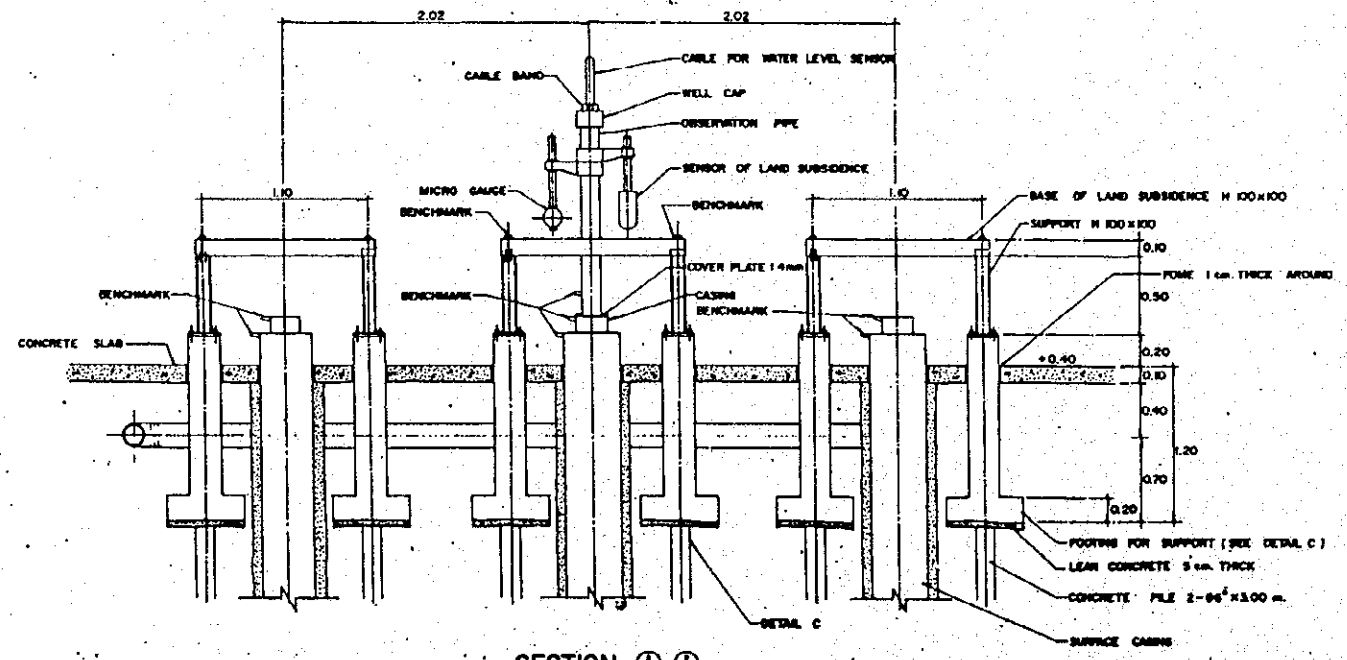

**SECTION ①-①**

<b>PROJECT: SITE C (KLONG KRU)</b>	
SHOWS DETAIL OF EQUIPMENT SETTING OF OBSERVATION HOUSE A	REVISION
SCALE 1:20	① 6-5-55
DATE 6-5-55	② 7-6-55
CONTRACTOR	DWG. NO.
<b>SIAM-TONE CO., LTD.</b>	<b>3/4</b>
<small>9/75 Mod (Ea) (S) Supp. Vol. Prod. Dept., Bangkok, Siam-Tone Co., Ltd. No. 54518-500 Tel. 545504</small>	

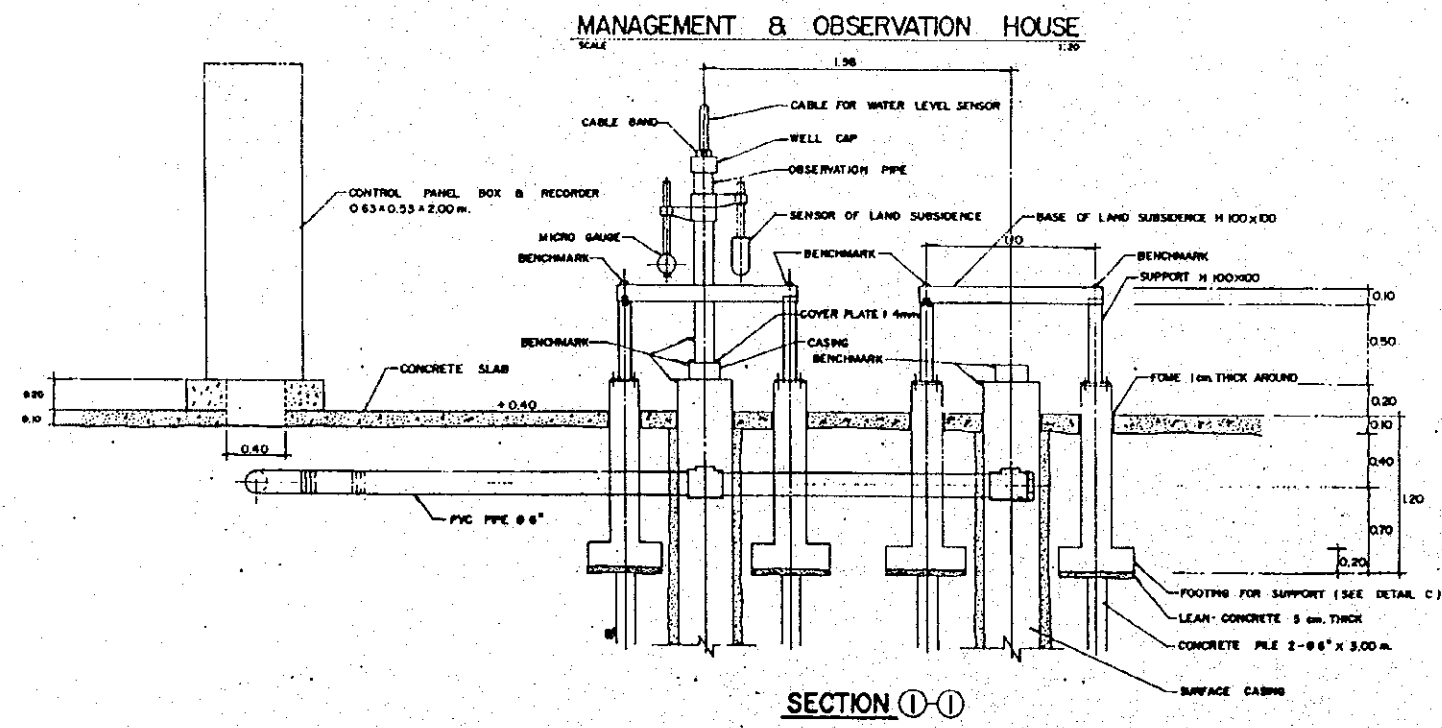
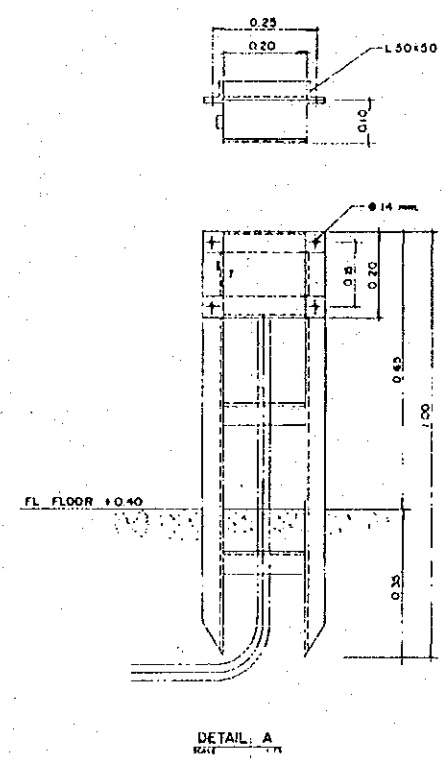
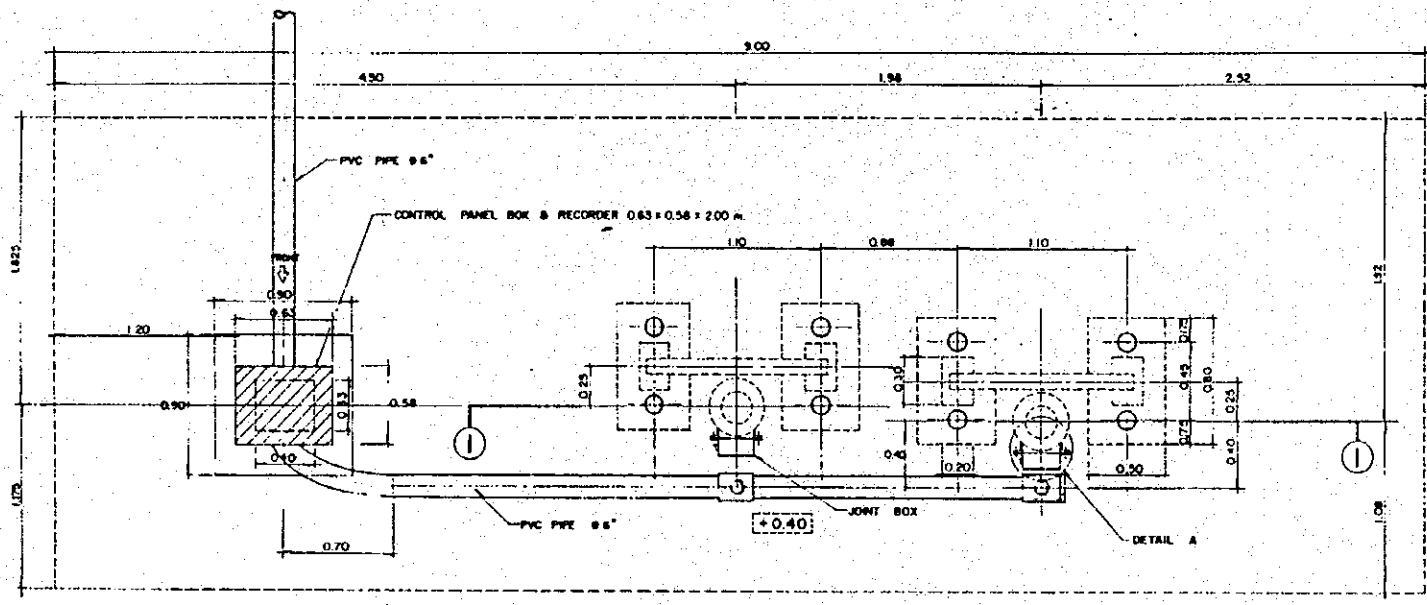

PROJECT: SITE C (KLONG KRU)	
DETAIL OF EQUIPMENT SETTING	
SHOWN OF MANAGEMENT & OBSERVATION HOUSE	REVISION
SCALE 1:20	① 7-6-93
DATE 19-3-93	
CONTRACTOR	DWG. NO.
SIAM TONE CO., LTD.	4/4

37/8 Moo 612A/51 Bangna - Sea Road, Bangkok, Siam 10740 Tel. 323374

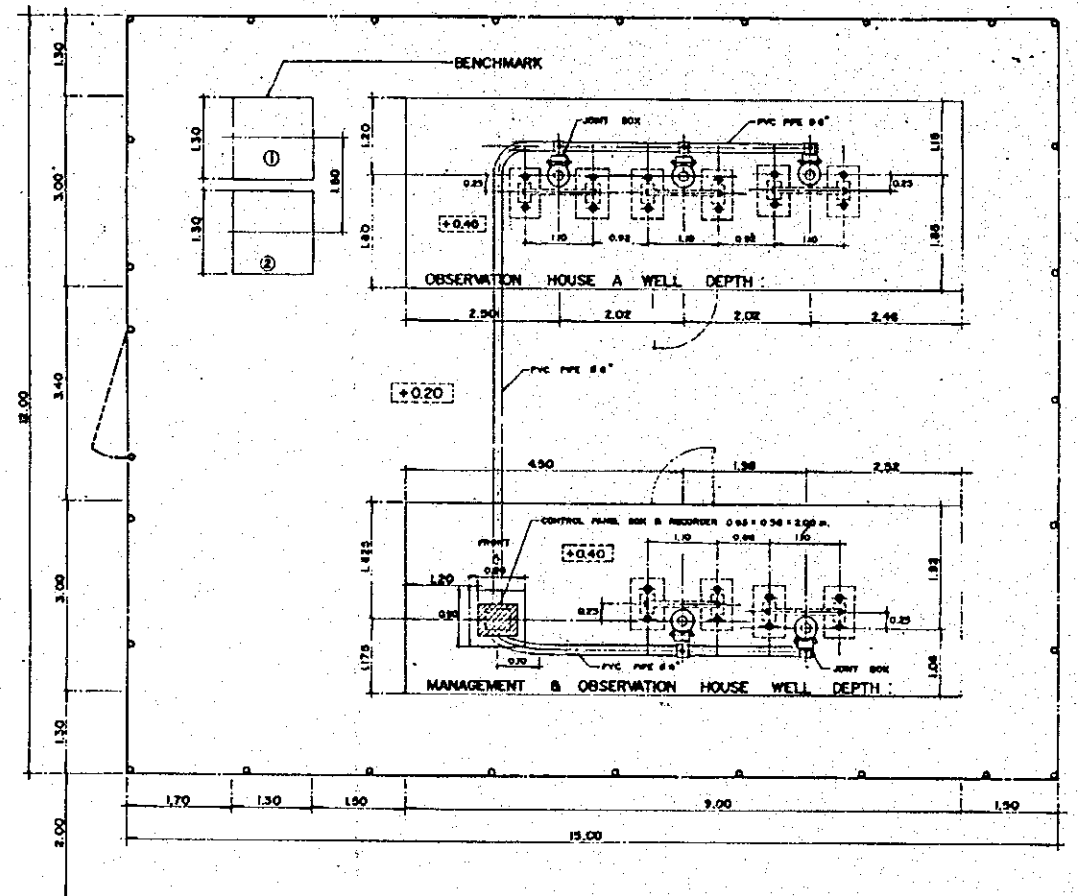

LAYOUT PLAN OF THE OBSERVATION HOUSE SITE C (KLONG KRU)  
SCALE 1:20

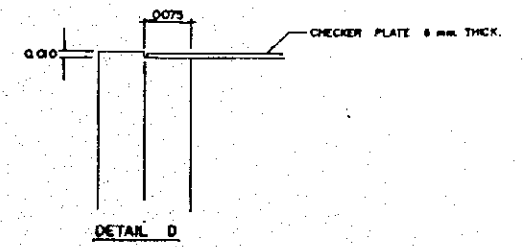
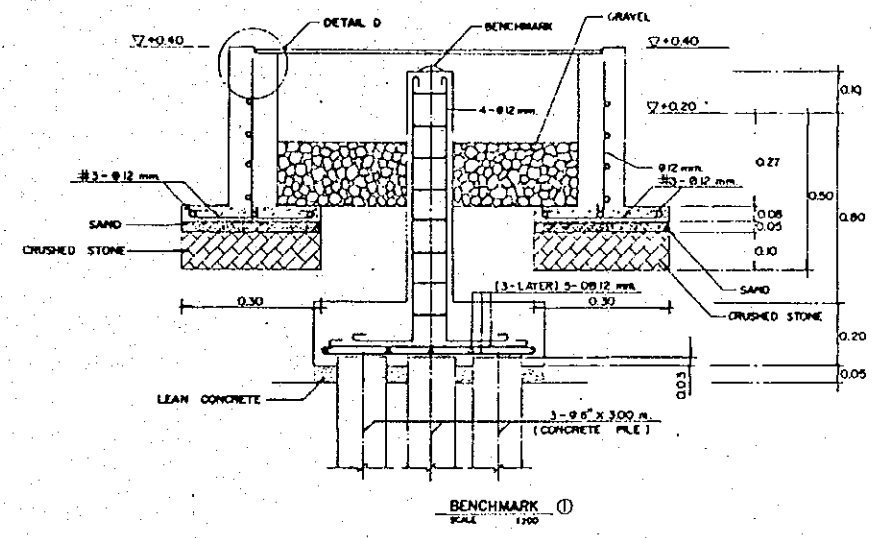
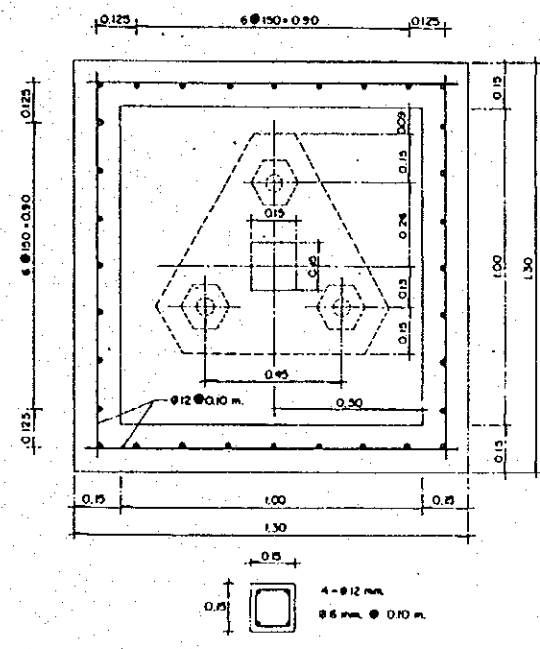

PROJECT: SITE C (KLONG KRU)		
SHOW	LAYOUT PLAN	REVISION
SCALE	1:20	① 7-6-95
DATE	19-5-95	
CONTRACTOR	SIAM TONE CO., LTD.	DWG. NO. 1/4
<small>5/13 Mass 18 m. 153 Bangkok - New Road, Bangkok, Telephone 02-440 375104</small>		

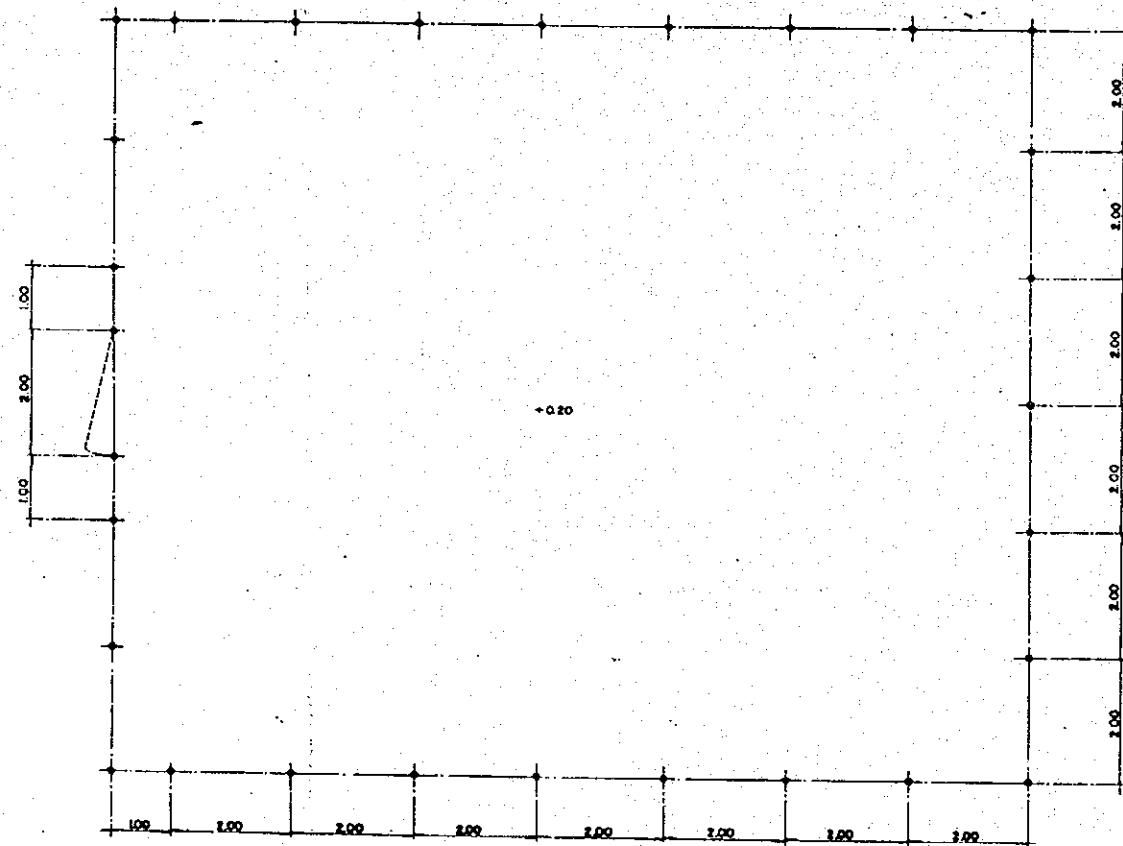

STEEL NET FENCE  
SCALE 1:30

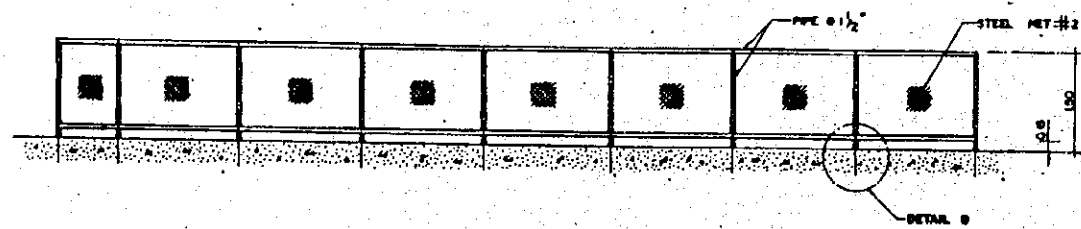

DETAIL B

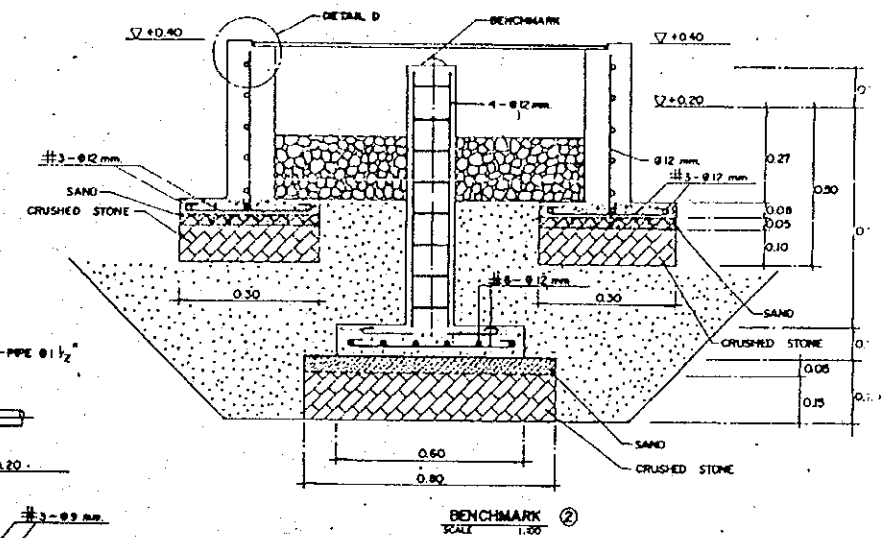
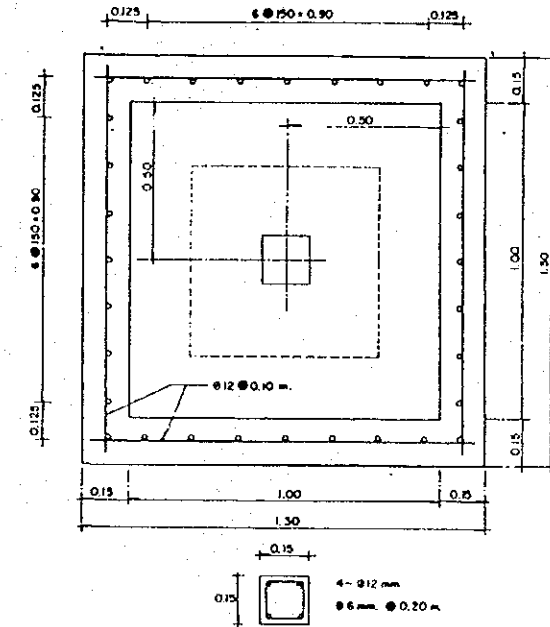

BENCHMARK  
SCALE 1:30

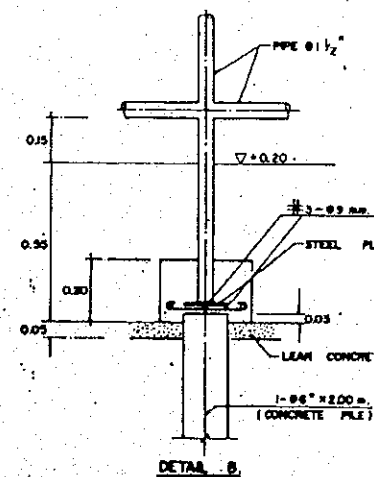

DETAIL B

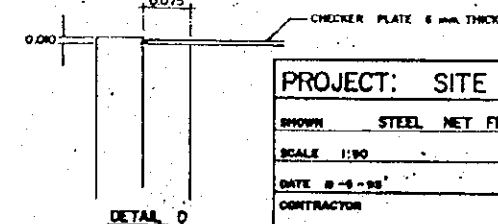

DETAIL D

PROJECT: SITE C (KLONG KR)		
SHOWN	STEEL NET FENCE	REVIC
SCALE	1:30	
DATE	10-6-99	
CONTRACTOR	SIAM TONE CO., LTD.	

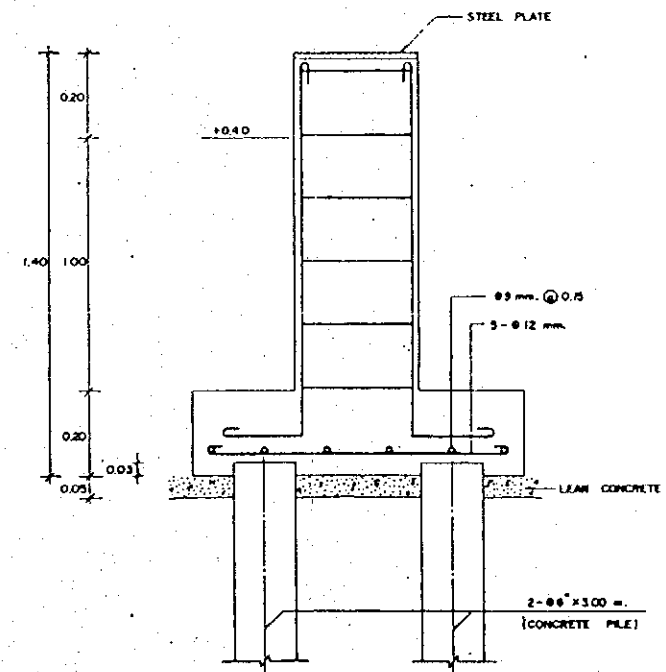
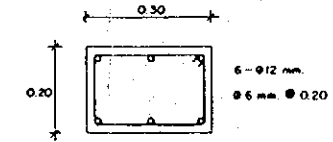
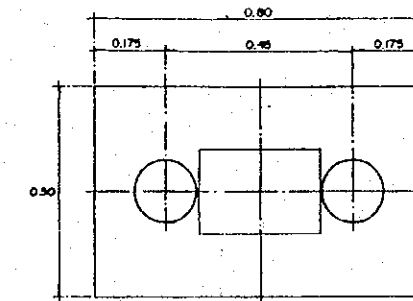
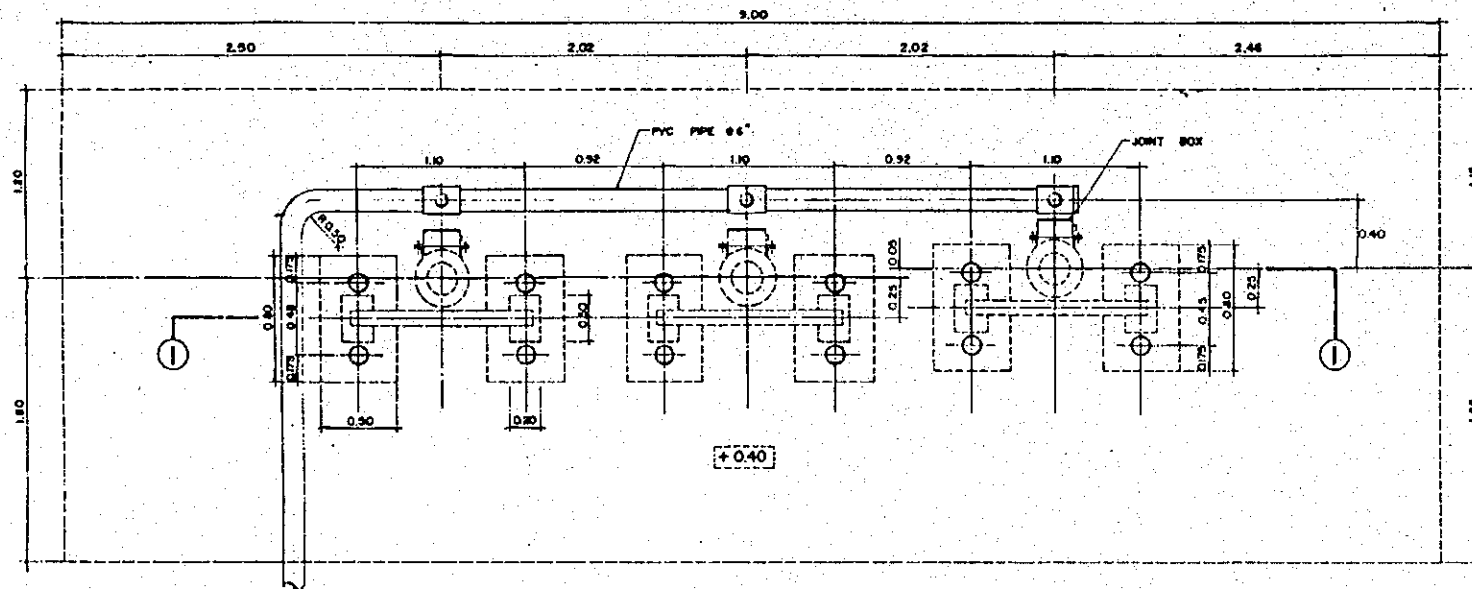

OBSERVATION HOUSE A  
SCALE 1/20

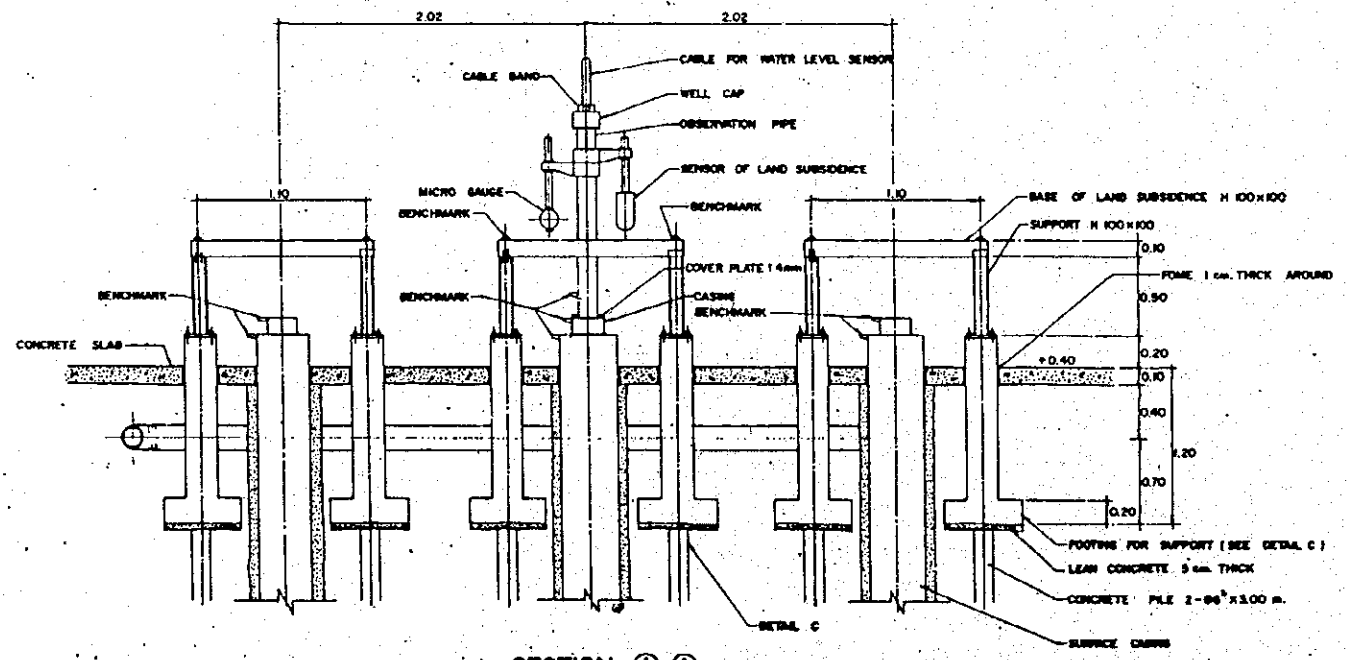

SECTION 1-1

PROJECT: SITE C (KLONG KRU)	
DESIGN BY: BETA OF EQUIPMENT	REVISION
SHOWN: SETTING OF OBSERVATION HOUSE A	① 6-5-55
SCALE: 1:20	② 7-6-55
DATE: 11-5-55	
CONTRACTOR: SIAM TONE CO., LTD.	DWG. NO.: 3/4
S/S Model (A) Paper: Prof. Pong, Bangkok, September 1956 No. 34330-300 Rev. 3/5/56	



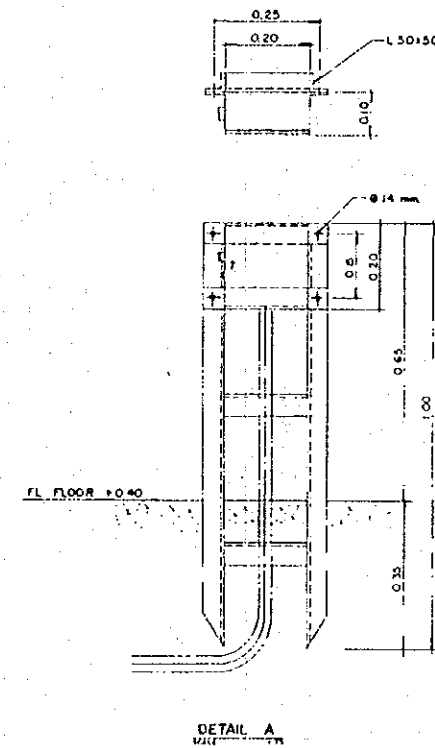
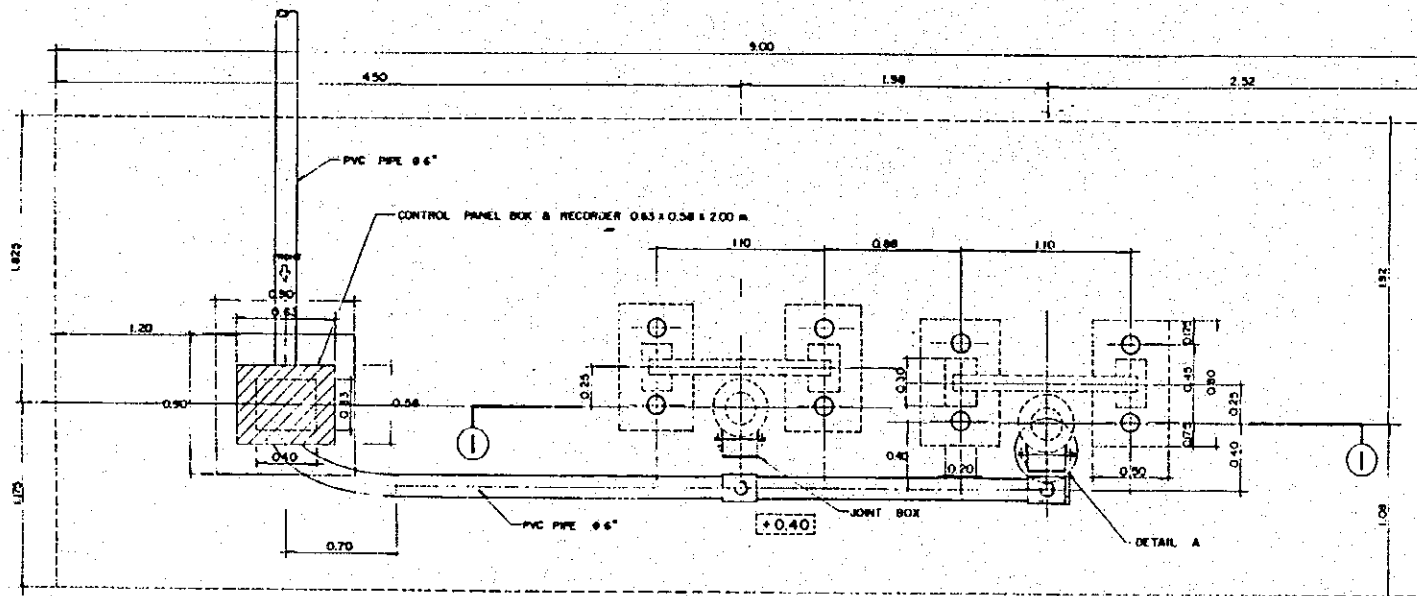

**MANAGEMENT & OBSERVATION HOUSE**  
SCALE 1/20

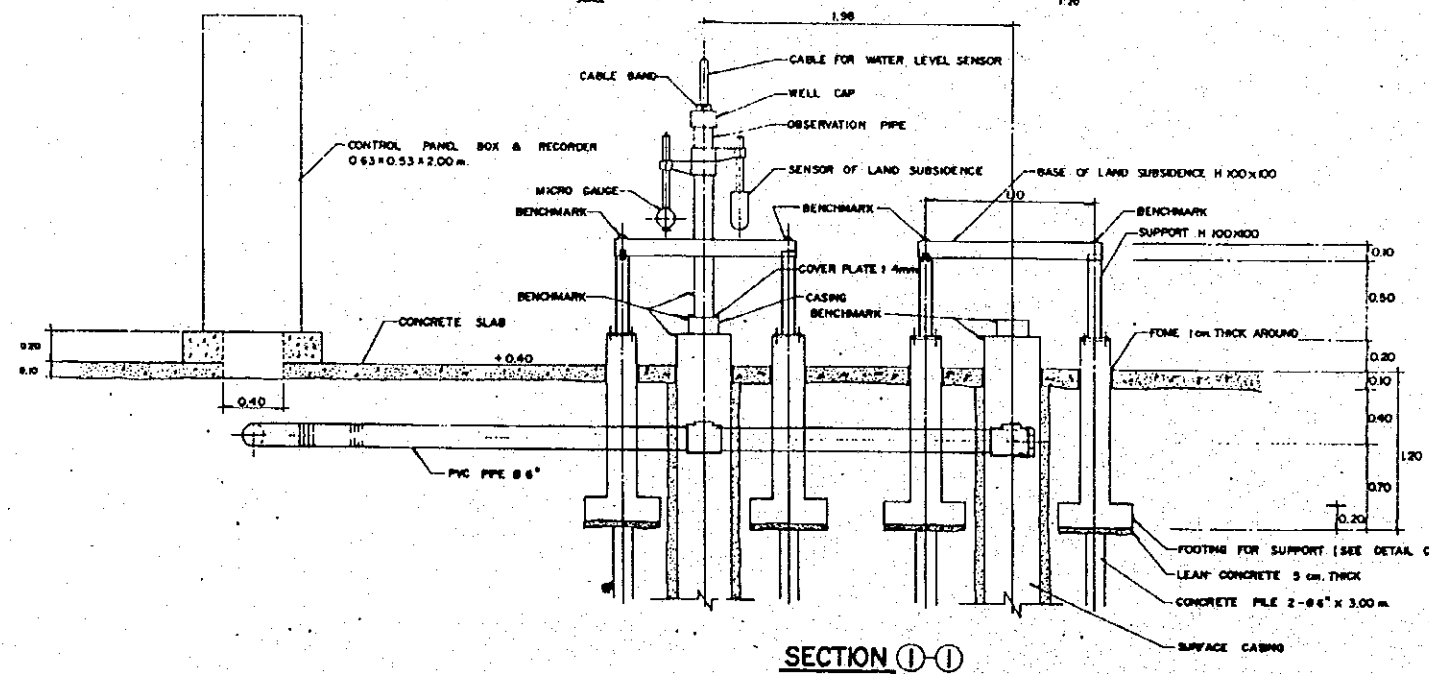

PROJECT: SITE C (KLONG KRUI)	
DETAIL OF EQUIPMENT SETTING SHOWN OF MANAGEMENT & OBSERVATION HOUSE	REVISION ① 7-6-93
SCALE 1:20	
DATE 19-5-93	
CONTRACTOR SIAM TONE CO., LTD.	DWG. NO. 4/4
S/O. No. 6 (11-13) Bangkok - West Road, Bangkok, Telephone: 02290 Fax: 923304	

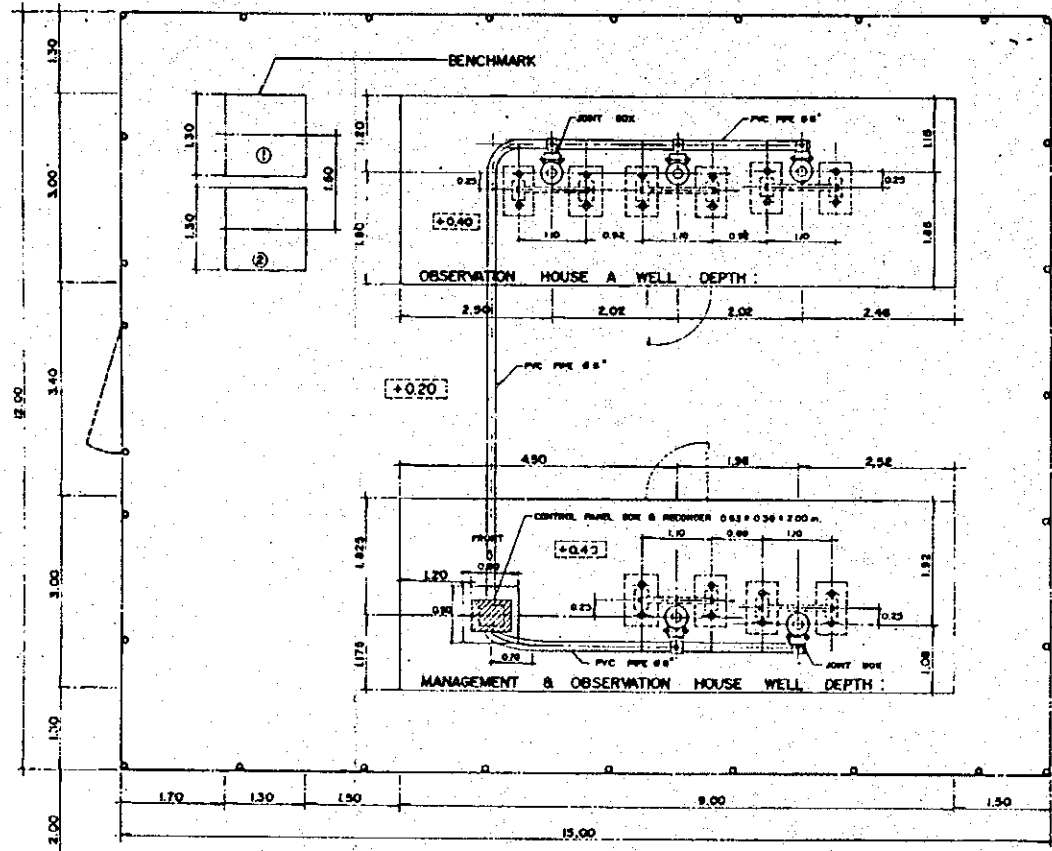

LAYOUT PLAN OF THE OBSERVATION HOUSE SITE C (KLONG KRU)  
SCALE 1:30

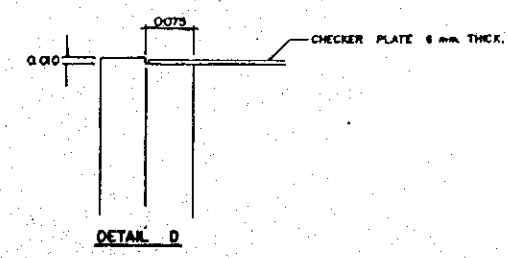
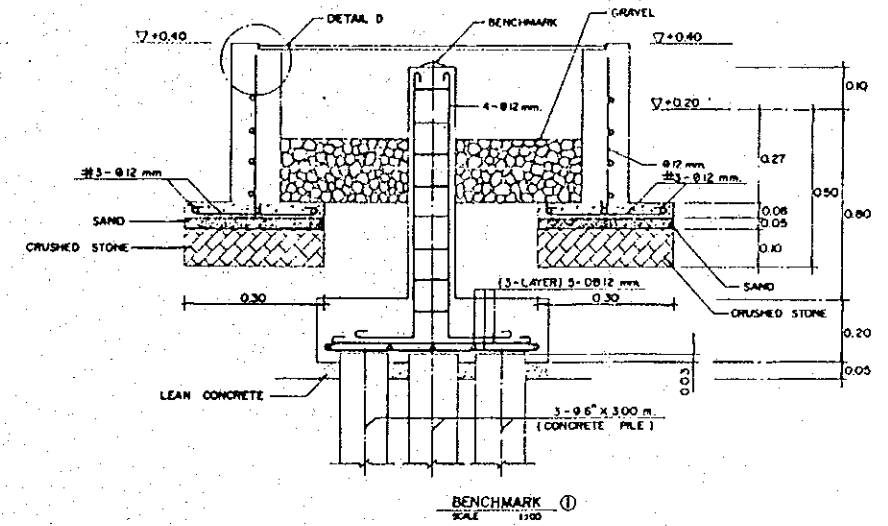
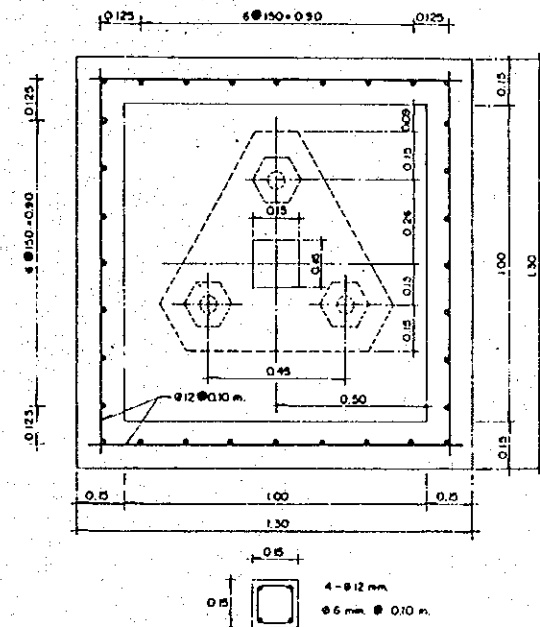

PROJECT: SITE C (KLONG KRU)		
SHOWN	LAYOUT PLAN	REVISION
SCALE	1:30	① 7-6-93
DATE	10-3-93	
CONTRACTOR	SIAM TONE CO., LTD.	DWG. NO. 1/4
S/15 Mac 8 (18 x 15) Reprint - Not Used, Reprint - Specifications 0540 Rev. 3/23/04		

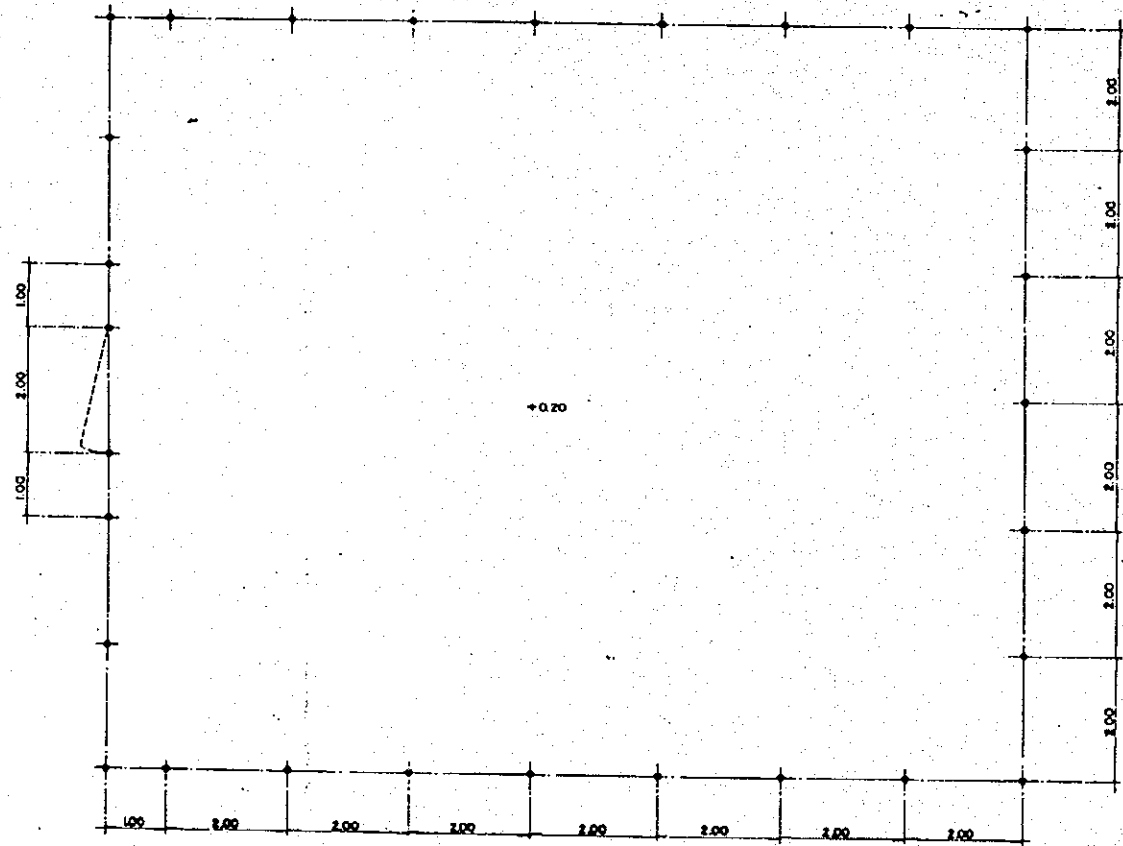

STEEL NET FENCE  
SCALE 1:50

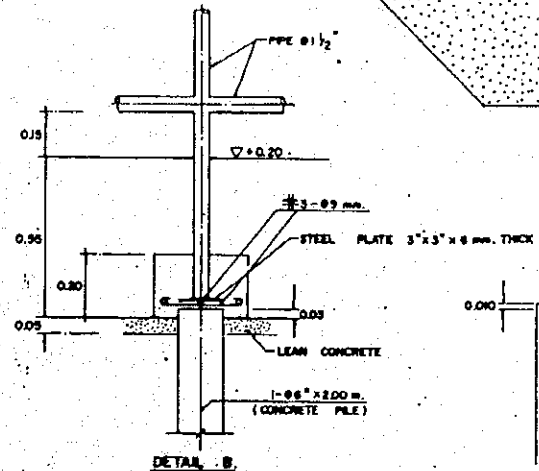
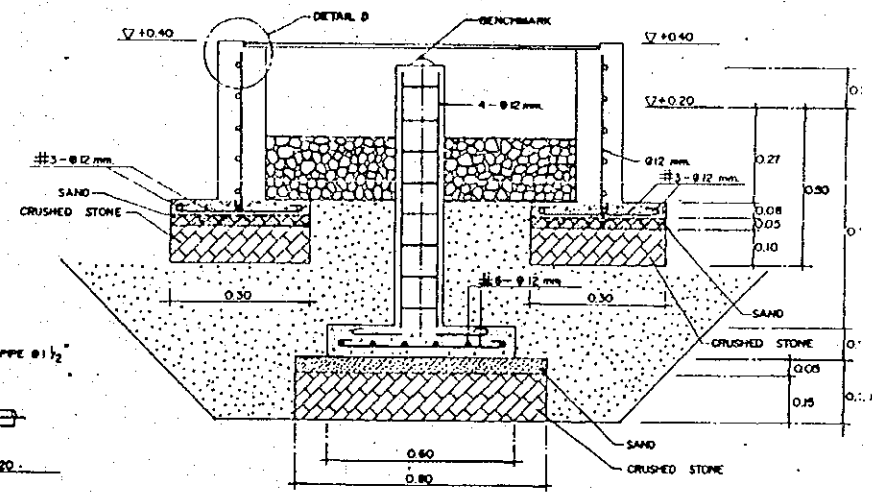
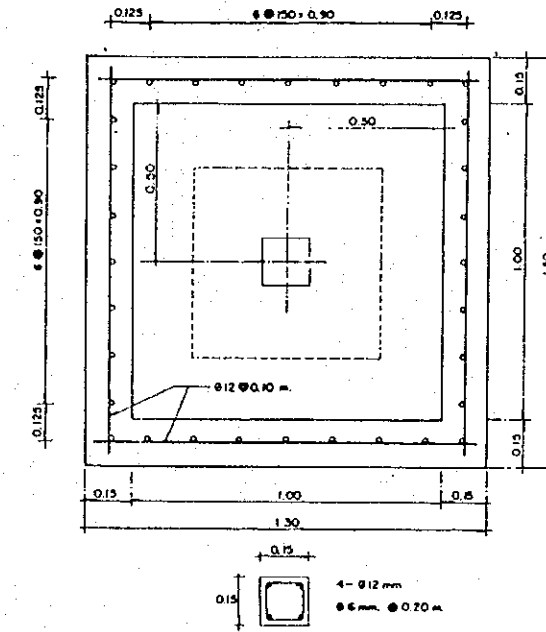
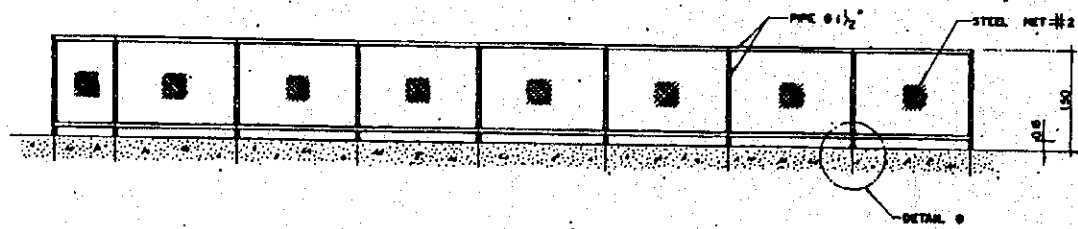

DETAIL D

PROJECT: SITE C (KLONG KR...)	
BY: STEEL NET FENCE	REVIEW:
SCALE: 1:50	
DATE: 11-11-55	
CONTRACTOR: SIAM TONE CO., LTD.	

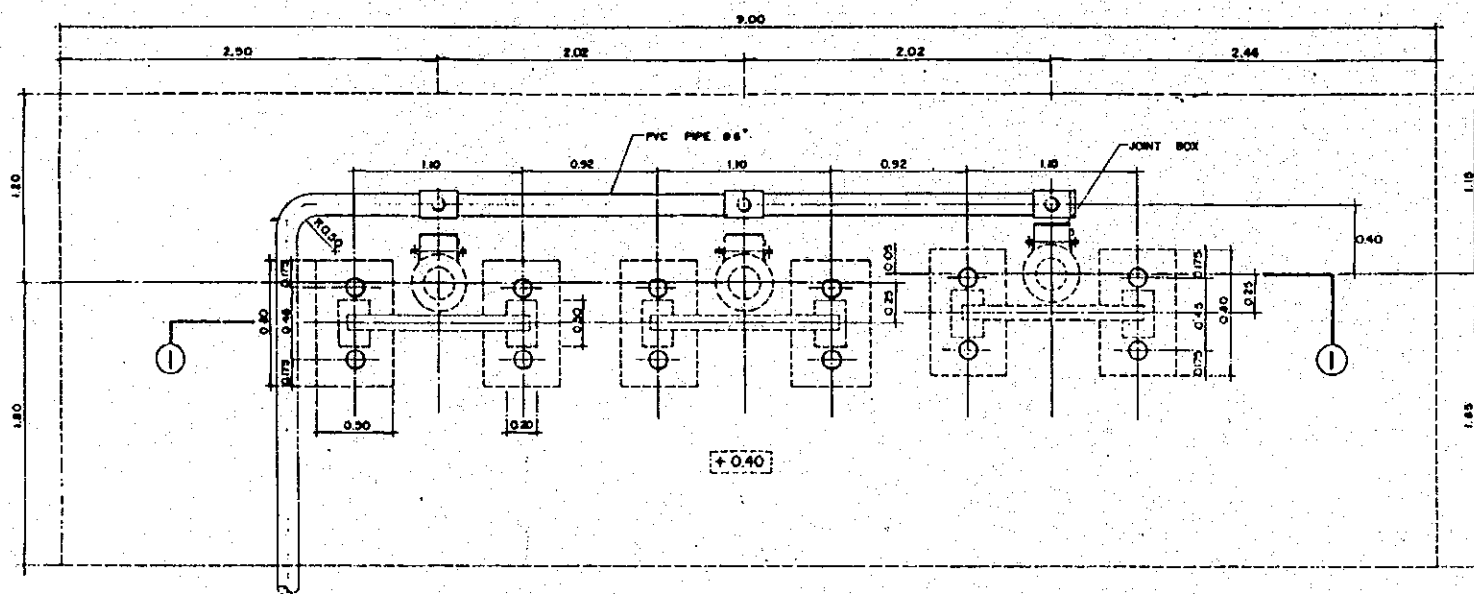

**OBSERVATION HOUSE A**  
SCALE 1:30

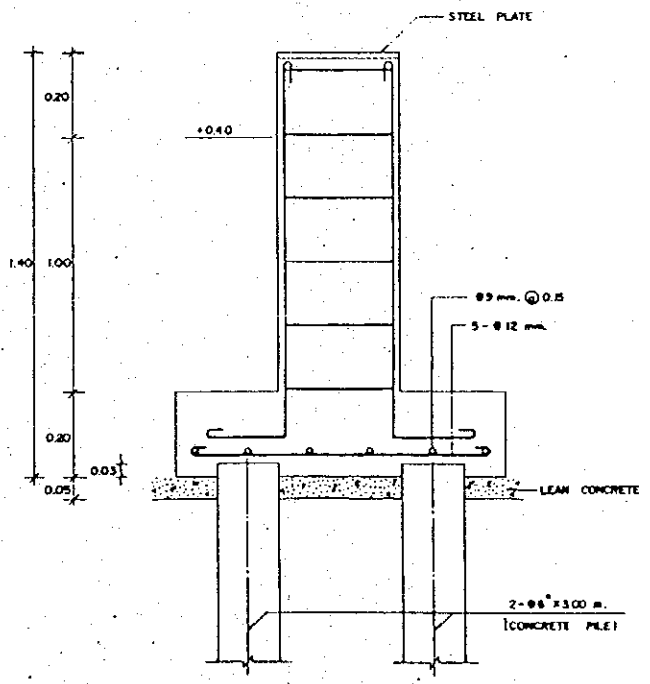
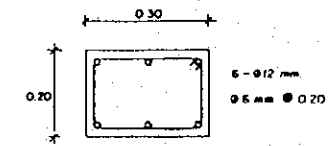
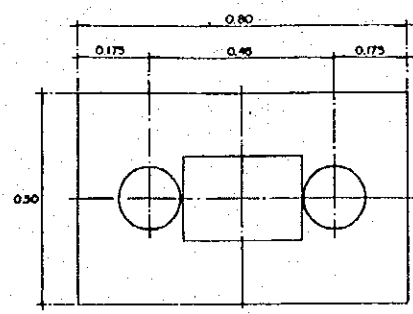

**DETAIL C**

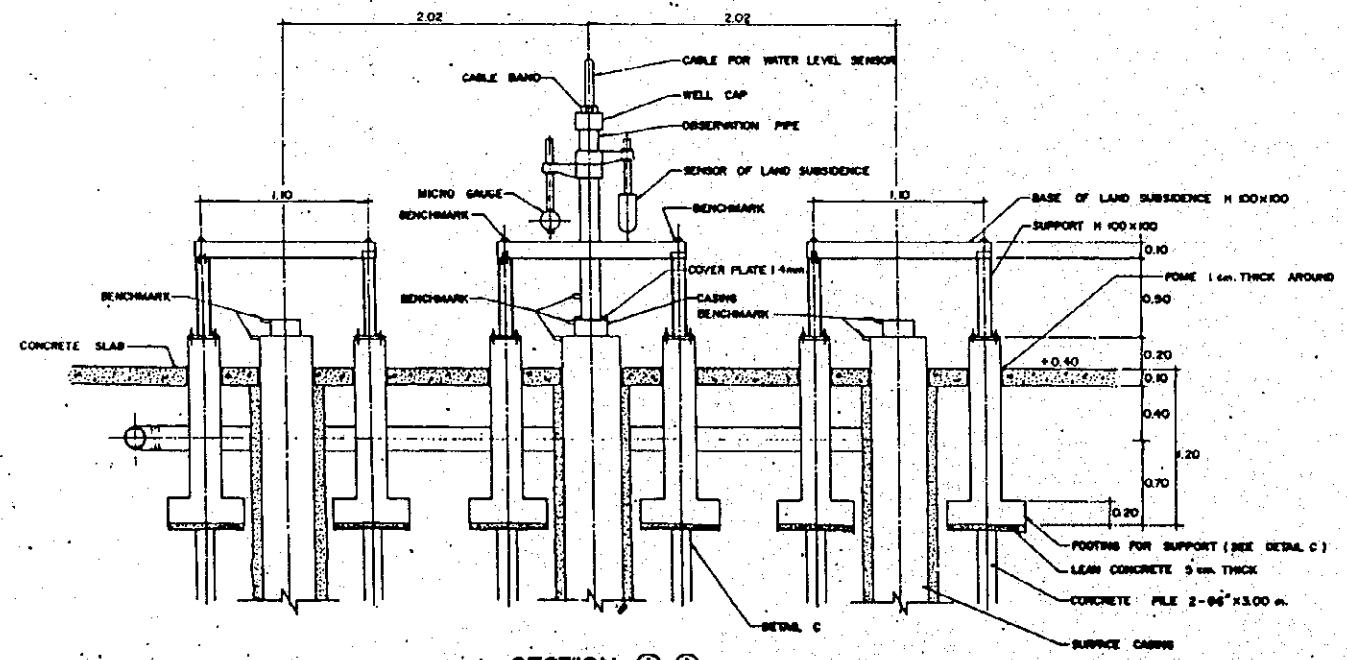

**SECTION 1-1**

<b>PROJECT: SITE C (KLONG KRU)</b>	
DETAIL OF EQUIPMENT SETTING OF OBSERVATION HOUSE A	REVISION
SCALE 1:20	① 6-5-53
DATE 9-5-53	② 7-6-53
CONTRACTOR <b>SIAM TONE CO., LTD.</b>	DWG. NO. <b>3/4</b>
S/8 New-Siam Co. (Pvt.) Ltd., Bangkok, Telephone 10548 W. 342500-100 No. 312, 304	

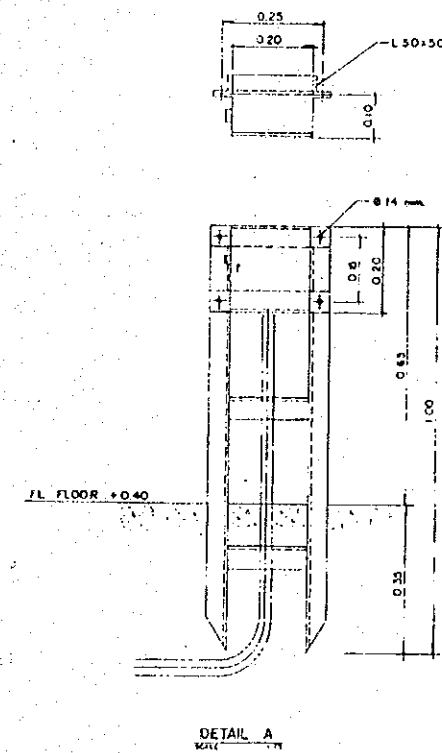
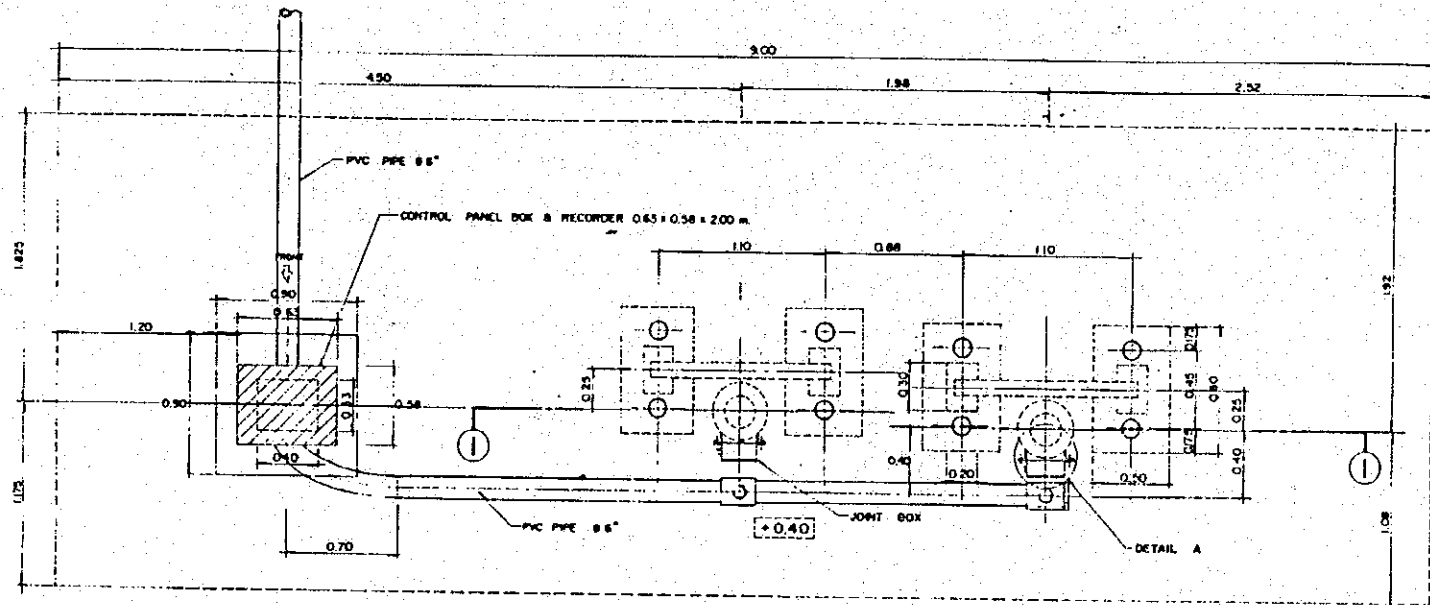

**MANAGEMENT & OBSERVATION HOUSE**

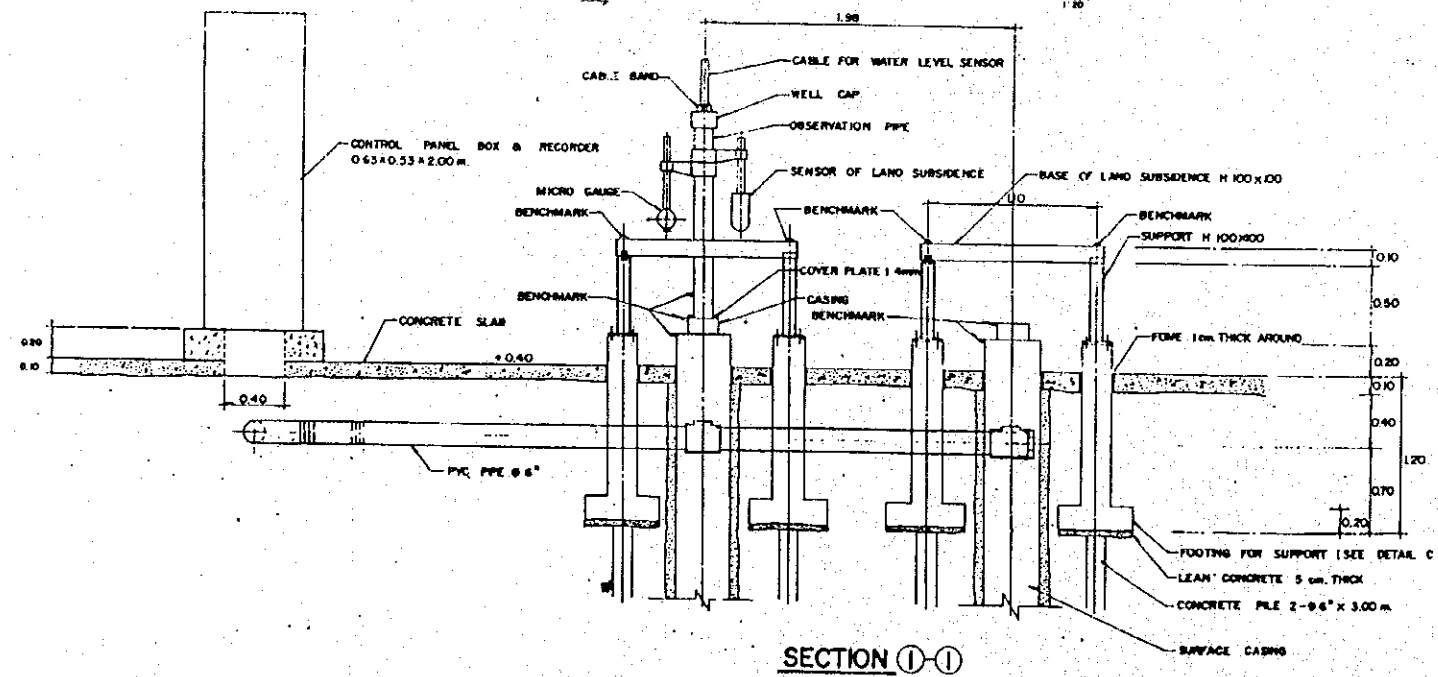

PROJECT: SITE C (KLONG KRUI)	
DETAIL OF EQUIPMENT SETTING	REVISION
SHOW OF MANAGEMENT & OBSERVATION HOUSE	① 7-6-93
SCALE 1:20	
DATE 19-5-93	
CONTRACTOR	DWG. NO.
SIAM TONE CO., LTD.	4/4

~

111