

国際協力事業団

キリバス共和国

公共事業・エネルギー省

キリバス共和国太陽光発電
 地方電化計画調査
 ファイナルレポート
 付属資料一 I

平成 6 年 3 月

株式会社 四電技術コンサルタント

鉦調資
J R
94-086

国際協力事業団
キリバス共和国太陽光発電地方電化計画調査ファイナルレポート 付属資料一 I

平成 6 年 3 月

四電技術コン

203
443
MPN
RARY

14-086

JICA LIBRARY



1119187111

27479

国際協力事業団

キリバス共和国

公共事業・エネルギー省

キリバス共和国太陽光発電
地方電化計画調査
ファイナルレポート
付属資料一 I

平成 6 年 3 月

株式会社 四電技術コンサルタント

国際協力事業団

27479

キリバス共和国太陽光発電地方電化計画

ファイナルレポート

付属資料－I：

個別システムの詳細設計内容

キリバス共和国地方電化計画

太陽光発電システム設備台帳

このプロジェクトにおいて設置された太陽光発電システムの運用および保守管理が今後円滑に行えるよう、本設備台帳を作成しキリバス共和国政府ならびに太陽エネルギー株式会社に提出する事とする。

キリバス共和国地方電化計画
実施時 電灯希望需要家名簿

VILLAGE	NO	CODE NO	CUSTOMER NAME	REMARK
TARATAI	1	R 17	Tetika	
	2		Tabobo	
NOTOUE	1	N 1	Arebonto	
	2	N 3	Bentara	
	3	N10	Keeti	
	4	N16	Mikaere Timaia	
	5	N30	Terinaki	
	6	N32	Tikanro	
	7	N35	Utimawa	
	8	N36	Waire	
	9	N37	Iotebwa	
	10	N38	Airin	
	11		Roniiti Tetabo	
	12		Taukaban Ioane	
	13		Tamuera Karebanga	
	14		Tebike Neneia	
	15		Tiibau	
ABAOKORO	1	A 1	Abakuka	
	2	A 4	Beia Toara	
	3	A 5	Ekeieta Ititaake	
	4	A 9	Loui Namane	
	5	A10	Natiria Tamton	
	6	A11	Obeta	
	7	A16	Tebarine Boobu	
	8	A17	Tebuaka	
	9	A18	Tekakiabo	
	10	A21	Temarawa Kawitu	
	11	A27	Makin Ngatau	
	12	A29	Taukaban	
	13	A32	Ribati (KPC)	
	14	A33	Boua Tekaa	
	15	A35	Abaua	
	16	A36	Bwenawa	
	17	A37	Matiota	
	18		Ambou	
	19		Bauro (Tika)	
	20		Kaobunang	
	21		Tekatau	
	22		Tekeraoi	
	23		Tenagimau (TEACHER)	
	24		Tetake	
	25		Biita	
MARENANUKA	1	M 1	Beia Ruaia	
	2	M 4	Moauuea	
	3	M 7	Ten Taateraka	
TABONIBARA	1	T 6	Rabangaki Matimara	
	2	T18	Toani Takaio	
	3	T23	Teaoti Ngoia	
	4		Maeuea	
	5		Tabeia	
	6		Tutu Tiribo	
KAINABA	1	K 4	Birikaua Tabokai	
	2	K10	Taake Tetaua	
	3	K11	Tebuatei Abiete	
	4	K14	Ueanna Temanikaai	
			Maneaba	

File of PV system Facility for Private House

1. Name of householder : T e n T e t i k a
2. Code NO : R 1 7
3. Name of village : T a r a t a i
4. Drawing of PV Facility

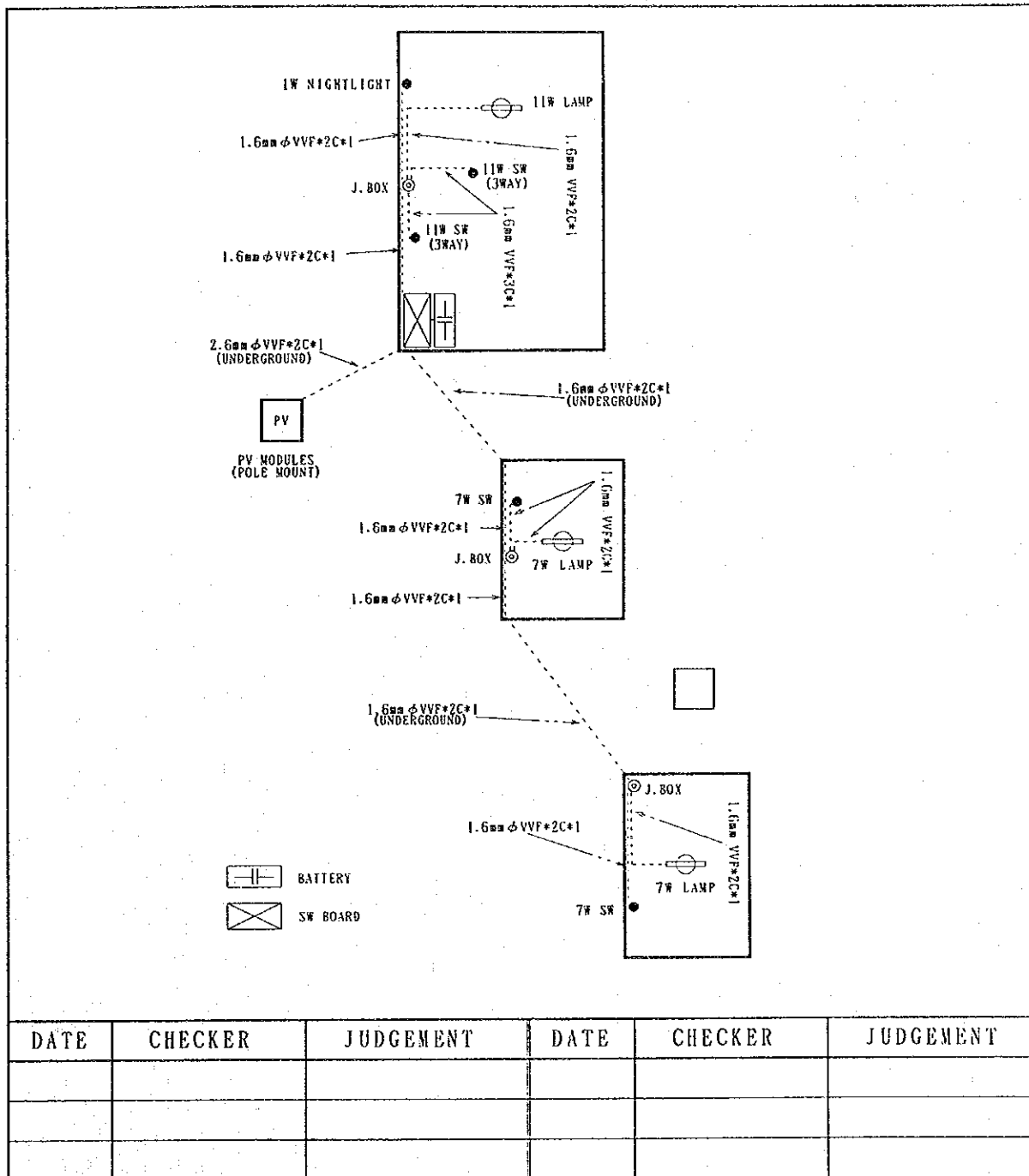

5. List of main equipment

	Equipment Item	Quantity		Equipment Item	Quantity
1	PV Module	2 pcs	8	1W LED night light	1 ea
2	Pole Mount	1 set	9	No Fuse Braker(10(A))	1 ea
3	Charge Controller	1 ea	10	Main switch(30(A))	3 ea
4	Battery(12V-100Ah)	1 ea	11	Protection Fuse(15(A))	1 ea
5	Battery Box	1 ea	12	Junction Box	3 pcs
6	Fluorescent Lamp(11w)	1 ea	13	Switch(7(W))	2 pcs
7	Fluorescent Lamp(7w)	2 pcs	14	3Way switch(11(W))	2 pcs

File of PV system Facility for Private House

1. Name of householder : T a b o b o
2. Code NO :
3. Name of village : T a r a t a i
4. Drawing of PV Facility

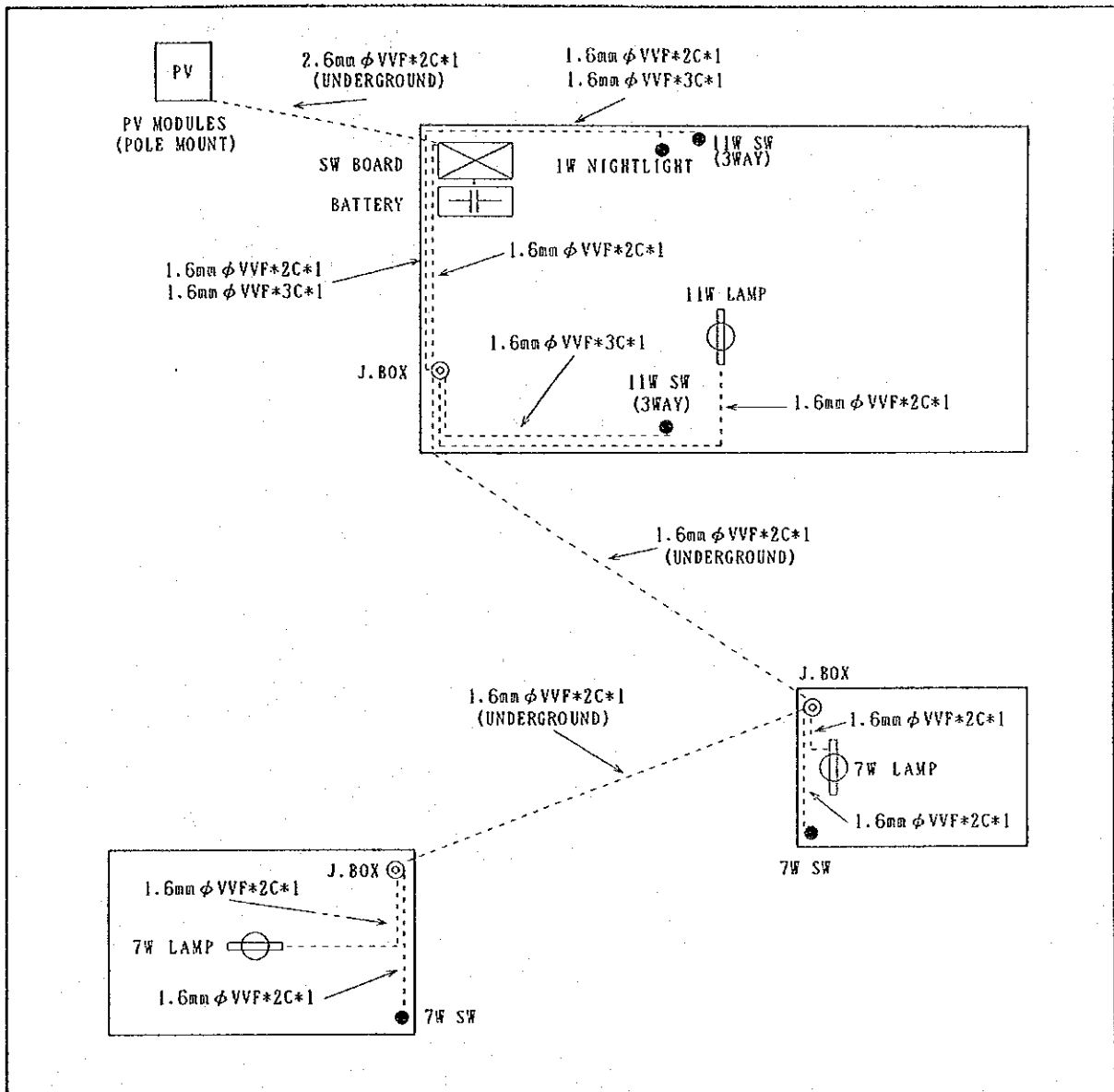

DATE	CHECKER	JUDGEMENT	DATE	CHECKER	JUDGEMENT

5. List of main equipment

No	Equipment Item	Quantity	No	Equipment Item	Quantity
1	PV Module	2 pcs	8	1W LED night light	1 ea
2	Pole Mount	1 set	9	No Fuse Braker(10(A))	1 ea
3	Charge Controller	1 ea	10	Main switch(30(A))	3 ea
4	Battery(12V-100Ah)	1 ea	11	Protection Fuse(15(A))	1 ea
5	Battery Box	1 ea	12	Junction Box	3 pcs
6	Fluorescent Lamp(11w)	1 ea	13	Switch(7(W))	2 pcs
7	Fluorescent Lamp(7w)	2 pcs	14	3way switch(11(W))	2 pcs

File of PV system Facility for Private House

1. Name of householder : A r e b o n t o
2. Code NO : N 1
3. Name of village : N o t o u e
4. Drawing of PV Facility

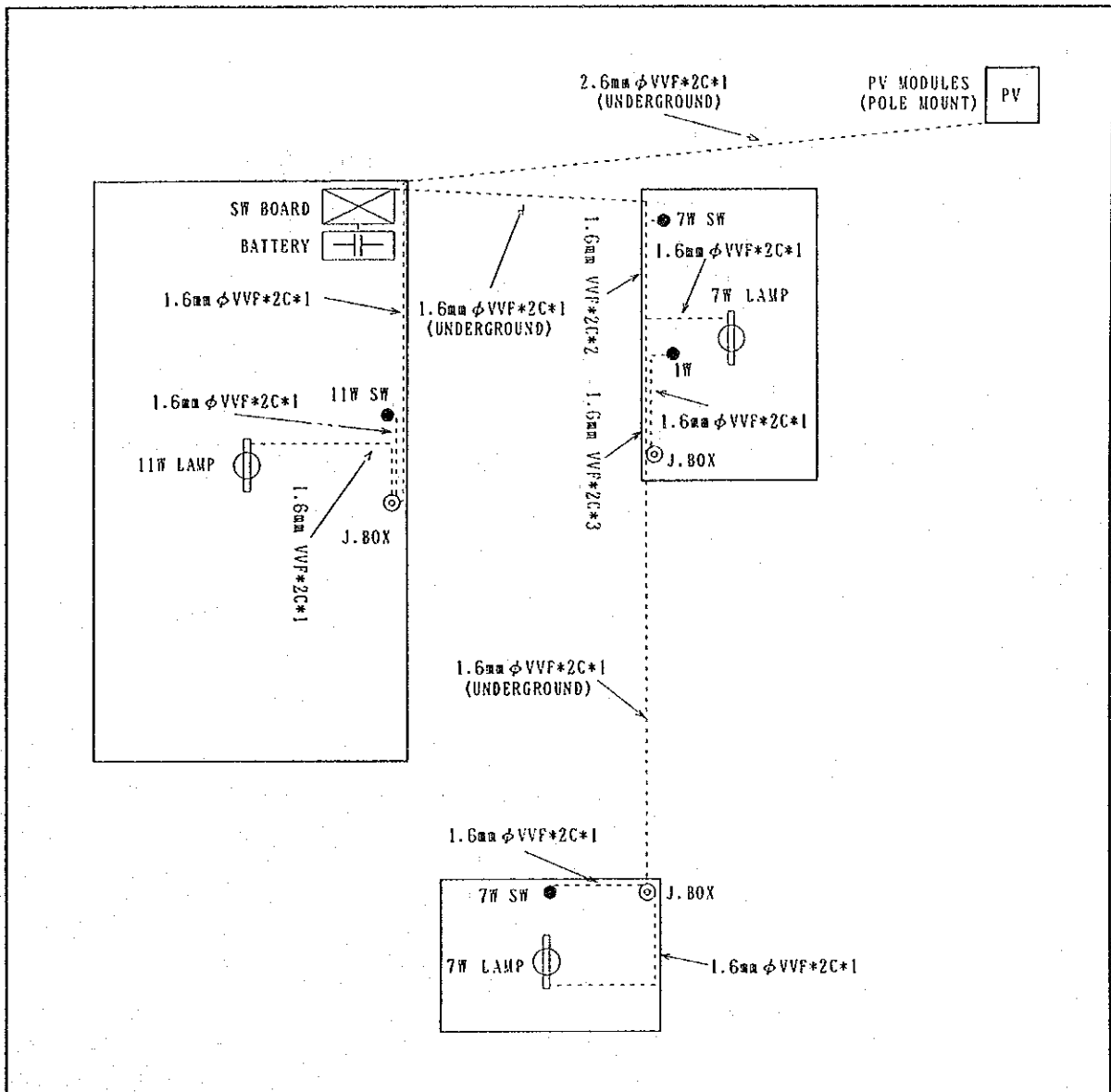

DATE	CHECKER	JUDGEMENT	DATE	CHECKER	JUDGEMENT

5. List of main equipment

No.	Equipment Item	Quantity	No.	Equipment Item	Quantity
1	PV Module	2 pcs	8	1W LED night light	1 ea
2	Pole Mount	1 set	9	No Fuse Braker(10(A))	1 ea
3	Charge Controller	1 ea	10	Main switch(30(A))	3 ea
4	Battery(12V-100Ah)	1 ea	11	Protection Fuse(15(A))	1 ea
5	Battery Box	1 ea	12	Junction Box	3 pcs
6	Fluorescent Lamp(11w)	1 ea	13	Switch(7(W))	2 pcs
7	Fluorescent Lamp(7w)	2 pcs	14	Switch(11(W))	1 pcs

File of PV system Facility for Private House

1. Name of householder : B e n t a r a
2. Code NO : N 3
3. Name of village : N o t o u e
4. Drawing of PV Facility

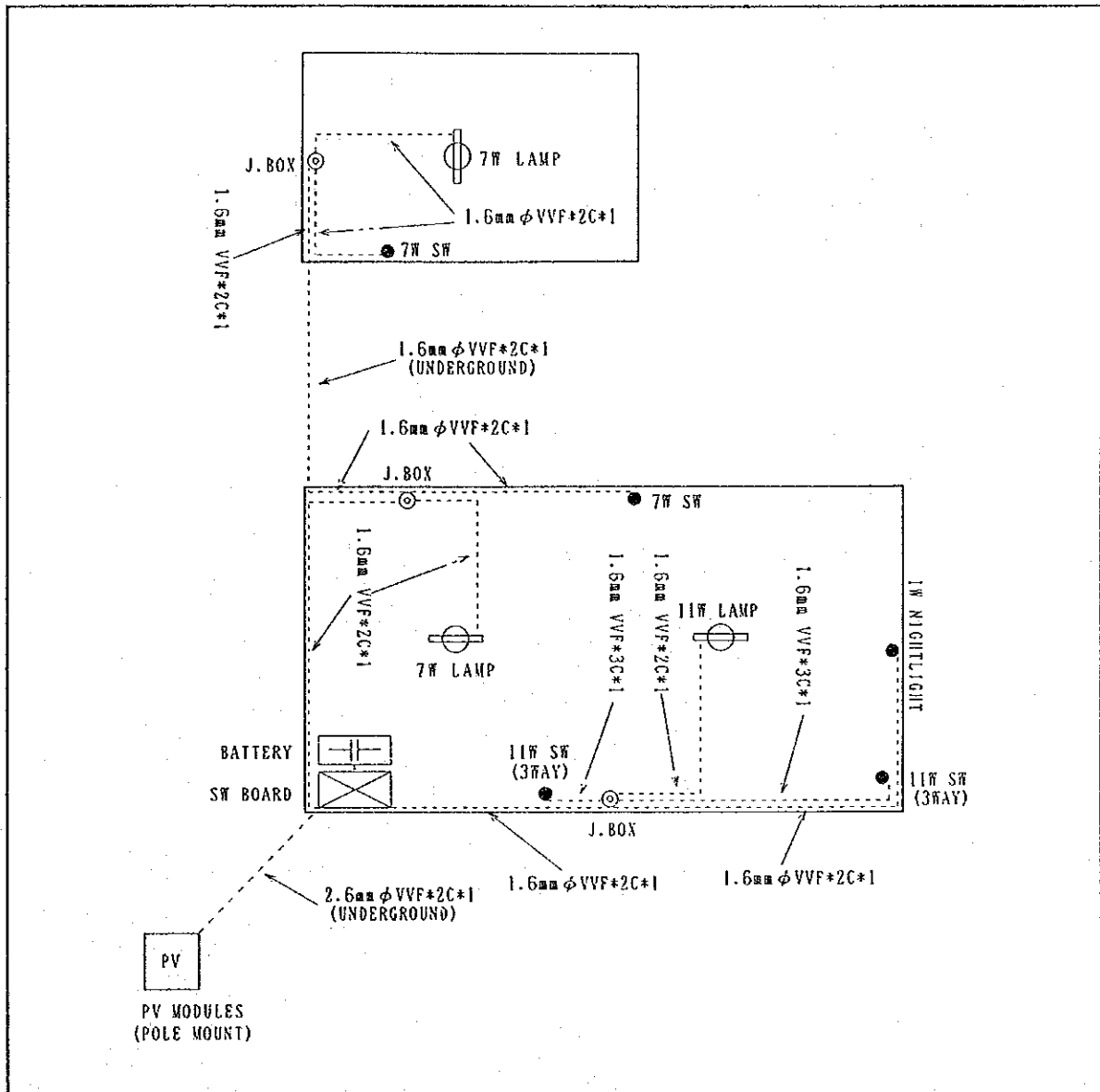

DATE	CHECKER	JUDGEMENT	DATE	CHECKER	JUDGEMENT

5. List of main equipment

	Equipment Item	Quantity		Equipment Item	Quantity
1	PV Module	2 pcs	8	1W LED night light	1 ea
2	Pole Mount	1 set	9	No Fuse Braker(10(A))	1 ea
3	Charge Controller	1 ea	10	Main switch(30(A))	3 ea
4	Battery(12V-100Ah)	1 ea	11	Protection Fuse(15(A))	1 ea
5	Battery Box	1 ea	12	Junction Box	3 pcs
6	Fluorescent Lamp(11w)	1 ea	13	Switch(7(W))	2 pcs
7	Fluorescent Lamp(7w)	2 pcs	14	3way switch(11(W))	2 pcs

File of PV system Facility for Private House

1. Name of householder : Keiti
2. Code NO : N10
3. Name of village : Notoue
4. Drawing of PV Facility

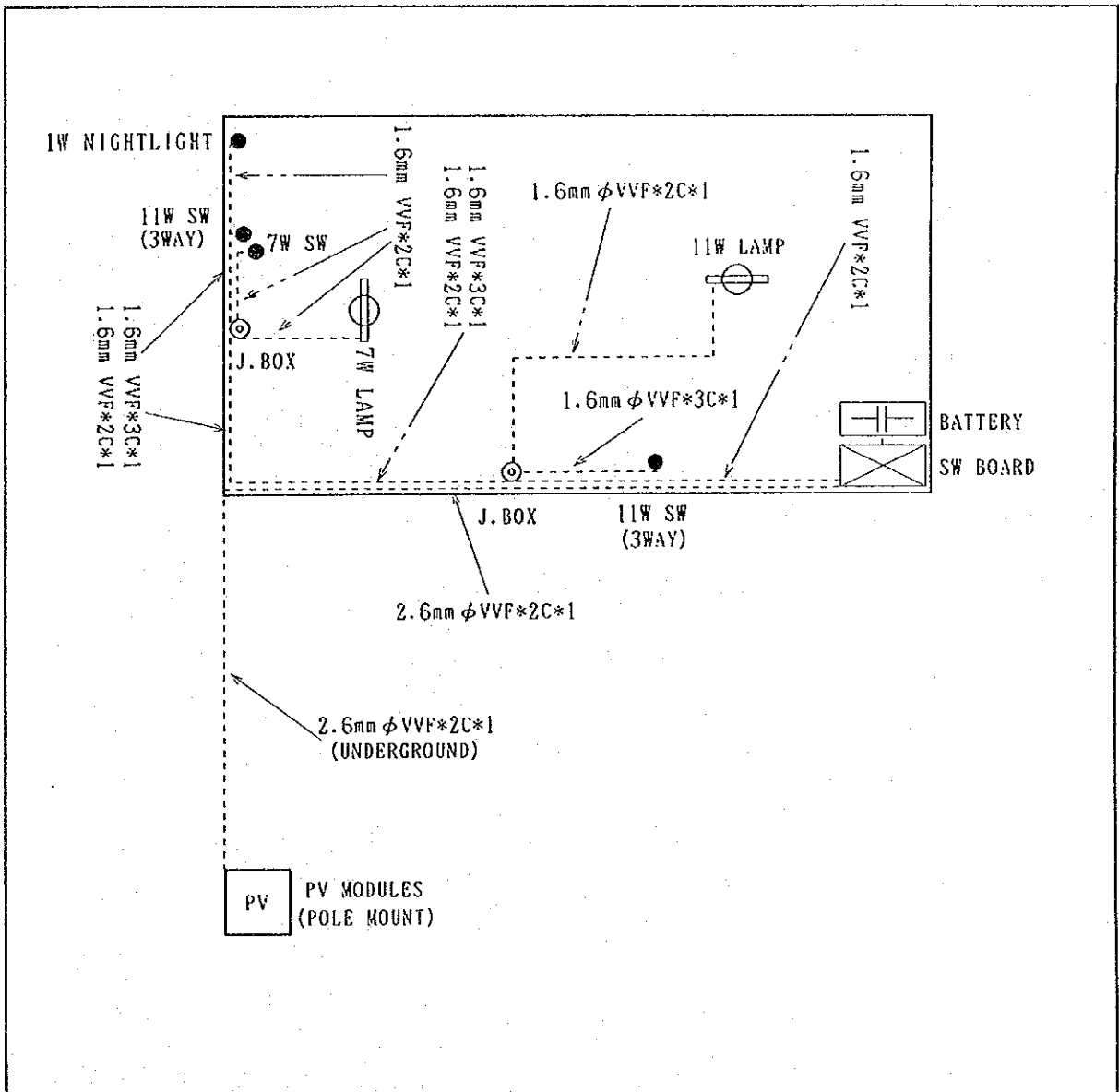

DATE	CHECKER	JUDGEMENT	DATE	CHECKER	JUDGEMENT

5. List of main equipment

	Equipment Item	Quantity		Equipment Item	Quantity
1	PV Module	2 pcs	8	1W LED night light	1 ea
2	Pole Mount	1 set	9	No Fuse Braker(10(A))	1 ea
3	Charge Controller	1 ea	10	Main switch(30(A))	3 ea
4	Battery(12V-100Ah)	1 ea	11	Protection Fuse(15(A))	1 ea
5	Battery Box	1 ea	12	Junction Box	2 pcs
6	Fluorescent Lamp(11w)	1 ea	13	Switch(7(W))	1 pcs
7	Fluorescent Lamp(7w)	1 pcs	14	3way switch(11(W))	2 pcs

File of PV system Facility for Private House

1. Name of householder : M i k a e r e T i m a i a
2. Code NO : N 1 6
3. Name of village : N o t o u e
4. Drawing of PV Facility

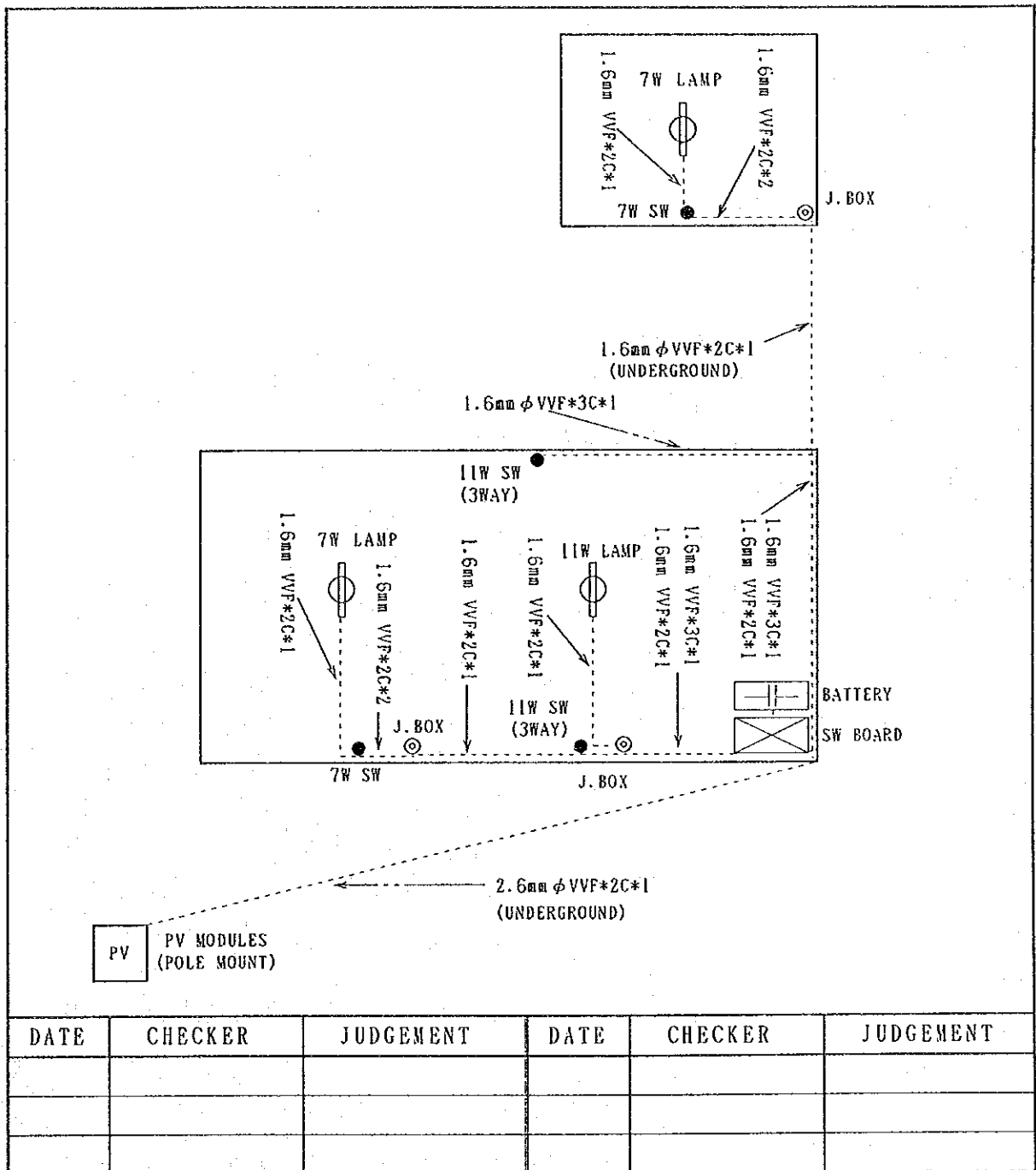

5. List of main equipment

Equipment Item	Quantity	Equipment Item	Quantity
1 PV Module	2 pcs	8 1W LED night light	1 ea
2 Pole Mount	1 set	9 No Fuse Braker(10(A))	1 ea
3 Charge Controller	1 ea	10 Main switch(30(A))	3 ea
4 Battery(12V-100Ah)	1 ea	11 Protection Fuse(15(A))	1 ea
5 Battery Box	1 ea	12 Junction Box	3 pcs
6 Fluorescent Lamp(11w)	1 ea	13 Switch(7(W))	2 pcs
7 Fluorescent Lamp(7w)	2 pcs	14 3way switch(11(W))	2 pcs

File of PV system Facility for Private House

1. Name of householder : Terinaki
2. Code NO : N30
3. Name of village : Notoue
4. Drawing of PV Facility

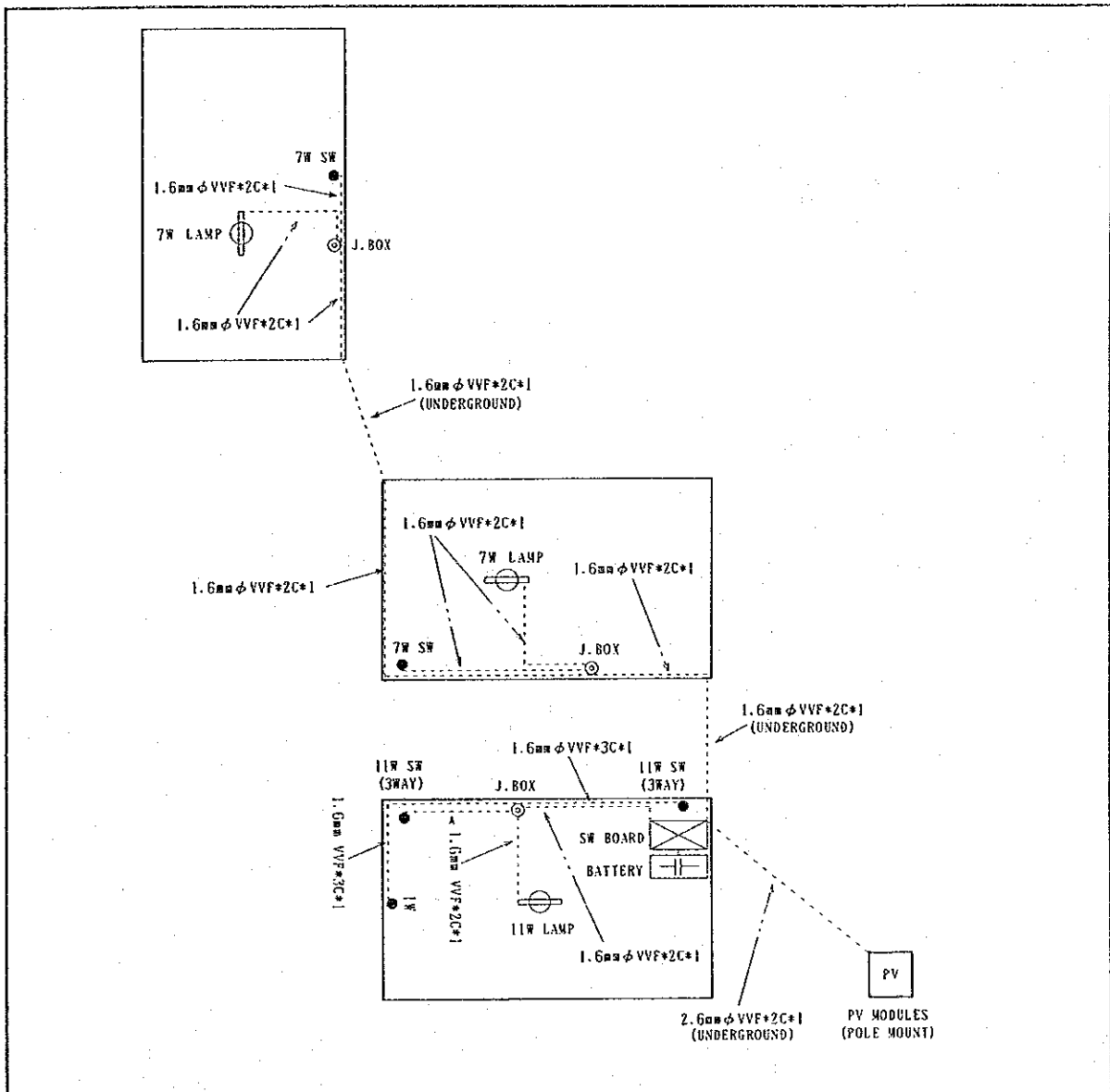

DATE	CHECKER	JUDGEMENT	DATE	CHECKER	JUDGEMENT

5. List of main equipment

Equipment Item	Quantity	Equipment Item	Quantity
1 PV Module	2 pcs	8 1W LED night light	1 ea
2 Pole Mount	1 set	9 No Fuse Braker(10(A))	1 ea
3 Charge Controller	1 ea	10 Main switch(30(A))	3 ea
4 Battery(12V-100Ah)	1 ea	11 Protection Fuse(15(A))	1 ea
5 Battery Box	1 ea	12 Junction Box	3 pcs
6 Fluorescent Lamp(11w)	1 ea	13 Switch(7(W))	2 pcs
7 Fluorescent Lamp(7w)	2 pcs	14 3way switch(11(W))	2 pcs

File of PV system Facility for Private House

1. Name of householder : T i k a n r o
2. Code NO : N 3 2
3. Name of village : N o t o u e
4. Drawing of PV Facility

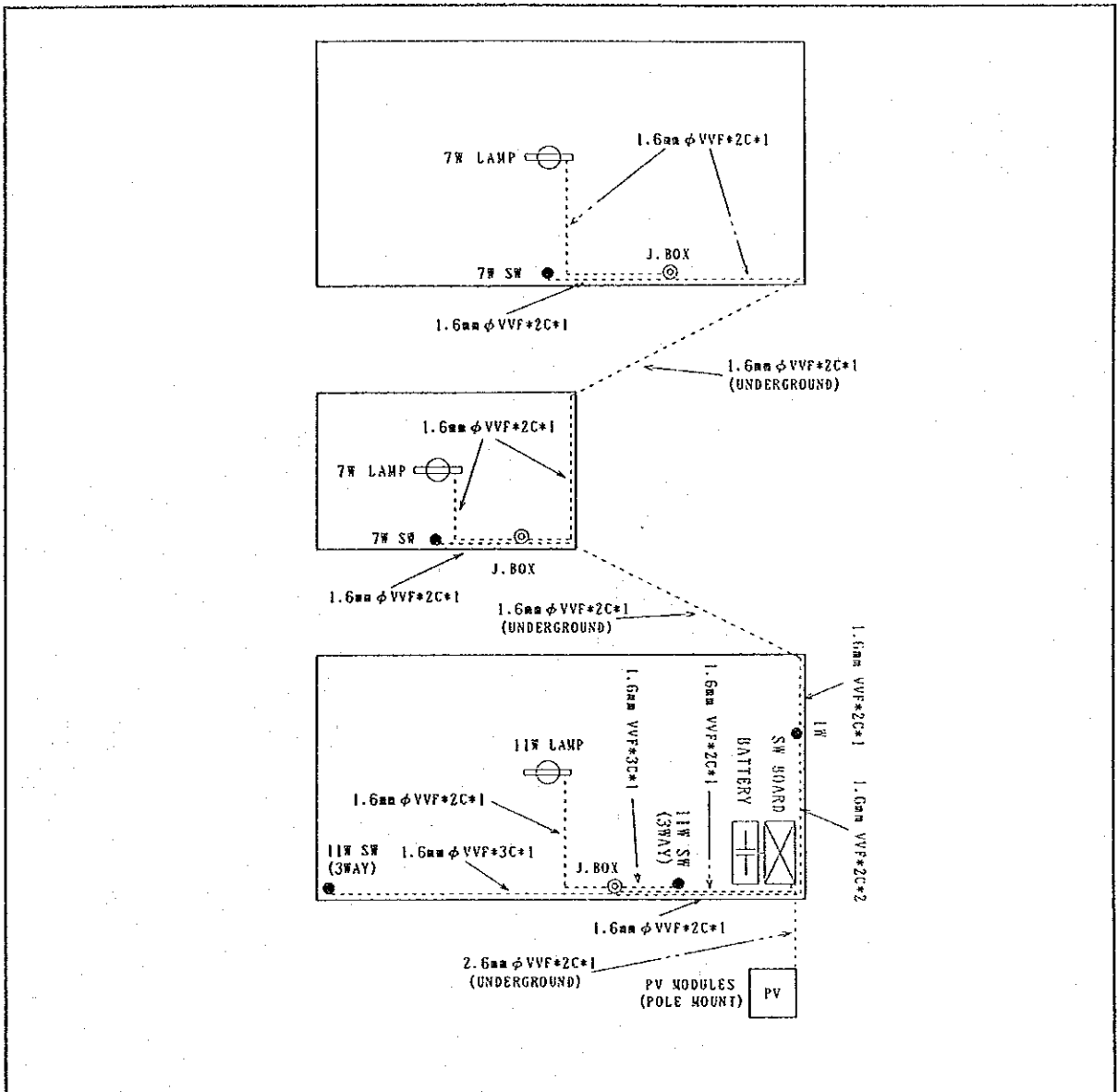

DATE	CHECKER	JUDGEMENT	DATE	CHECKER	JUDGEMENT

5. List of main equipment

No	Equipment Item	Quantity	No	Equipment Item	Quantity
1	PV Module	2 pcs	8	1W LED night light	1 ea
2	Pole Mount	1 set	9	No Fuse Braker(10(A))	1 ea
3	Charge Controller	1 ea	10	Main switch(30(A))	3 ea
4	Battery(12V-100Ah)	1 ea	11	Protection Fuse(15(A))	1 ea
5	Battery Box	1 ea	12	Junction Box	3 pcs
6	Fluorescent Lamp(11w)	1 ea	13	Switch(7(W))	2 pcs
7	Fluorescent Lamp(7w)	2 pcs	14	3way switch(11(W))	2 pcs

File of PV system Facility for Private House

1. Name of householder : U t i m a w a
2. Code NO : N 3 5
3. Name of village : N o t o u e
4. Drawing of PV Facility

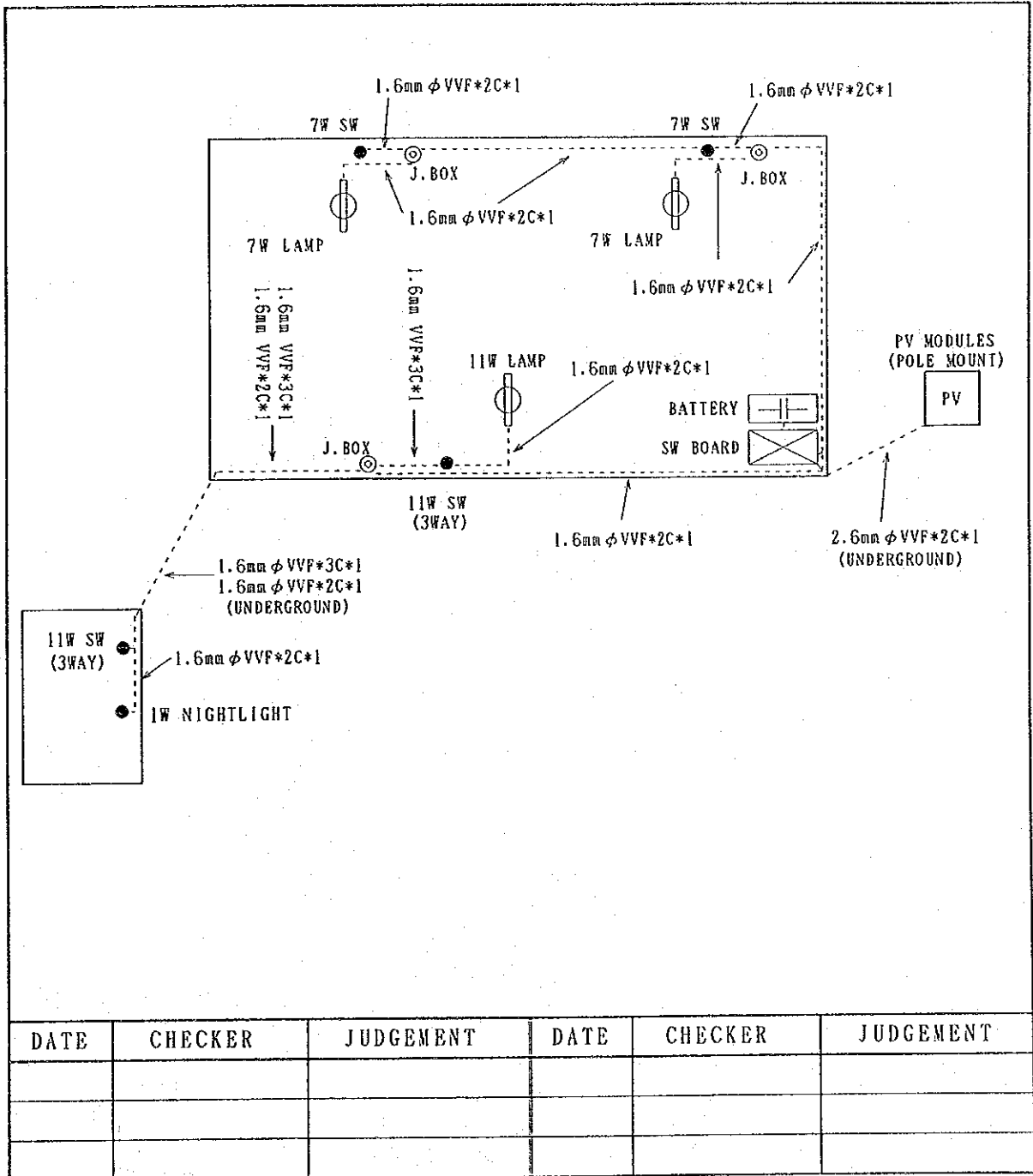

5. List of main equipment

Equipment Item	Quantity	Equipment Item	Quantity
1 PV Module	2 pcs	8 1W LED night light	1 ea
2 Pole Mount	1 set	9 No Fuse Braker(10(A))	1 ea
3 Charge Controller	1 ea	10 Main switch(30(A))	3 ea
4 Battery(12V-100Ah)	1 ea	11 Protection Fuse(15(A))	1 ea
5 Battery Box	1 ea	12 Junction Box	3 pcs
6 Fluorescent Lamp(11w)	1 ea	13 Switch(7(W))	2 pcs
7 Fluorescent Lamp(7w)	2 pcs	14 3Way switch(11(W))	2 pcs

File of PV system Facility for Private House

1. Name of householder : W a i r e
2. Code NO : N 3 6
3. Name of village : N o t o u e
4. Drawing of PV Facility

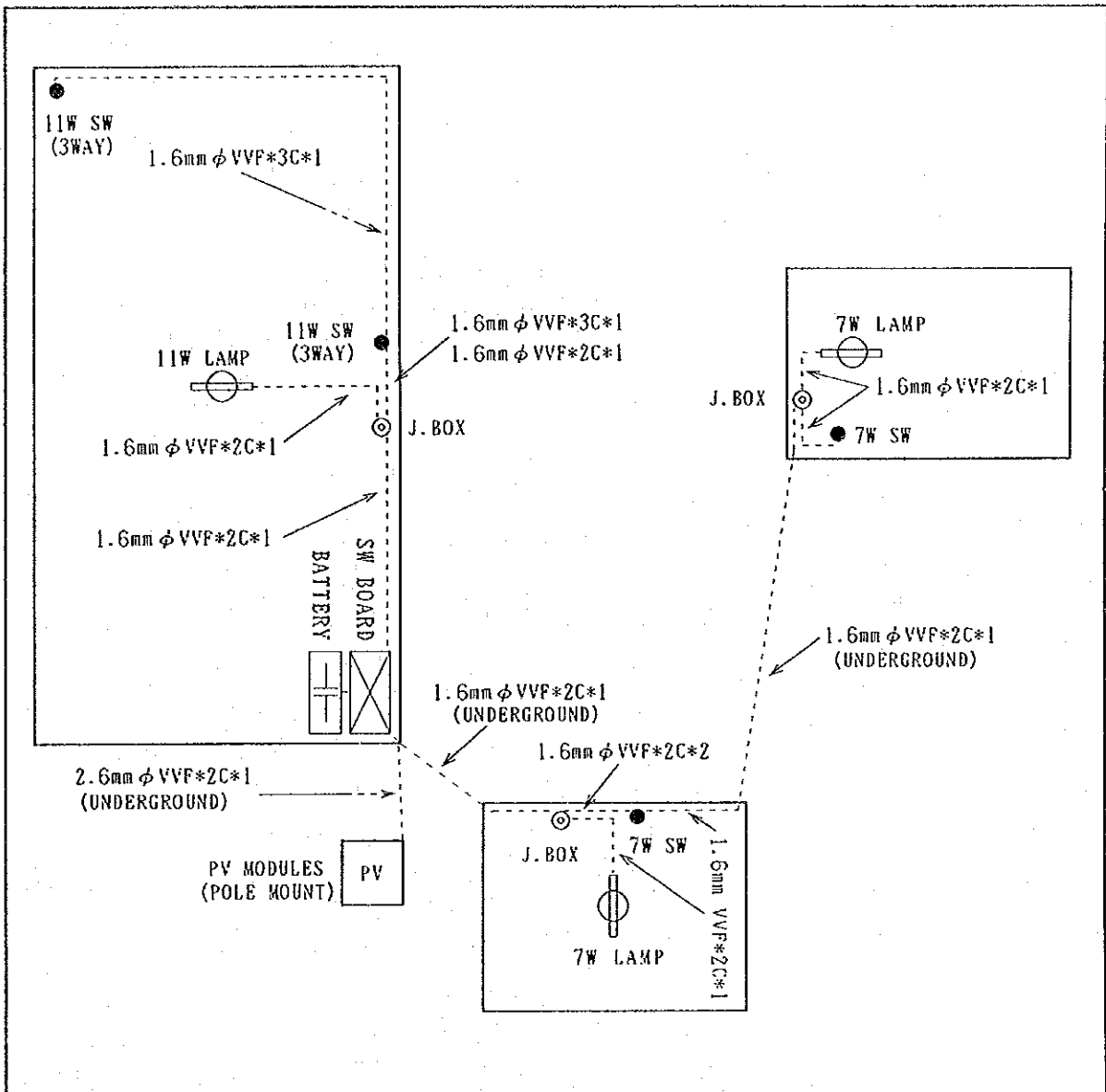

DATE	CHECKER	JUDGEMENT	DATE	CHECKER	JUDGEMENT

5. List of main equipment

No	Equipment Item	Quantity	No	Equipment Item	Quantity
1	PV Module	2 pcs	8	1W LED night light	1 ea
2	Pole Mount	1 set	9	No Fuse Braker(10(A))	1 ea
3	Charge Controller	1 ea	10	Main switch(30(A))	3 ea
4	Battery(12V-100Ah)	1 ea	11	Protection Fuse(15(A))	1 ea
5	Battery Box	1 ea	12	Junction Box	3 pcs
6	Fluorescent Lamp(11w)	1 ea	13	Switch(7(W))	2 pcs
7	Fluorescent Lamp(7w)	2 pcs	14	3Way switch(11(W))	2 pcs

File of PV system Facility for Private House

1. Name of householder : I o t e b w a
2. Code NO : N 3 7
3. Name of village : N o t o u e
4. Drawing of PV Facility

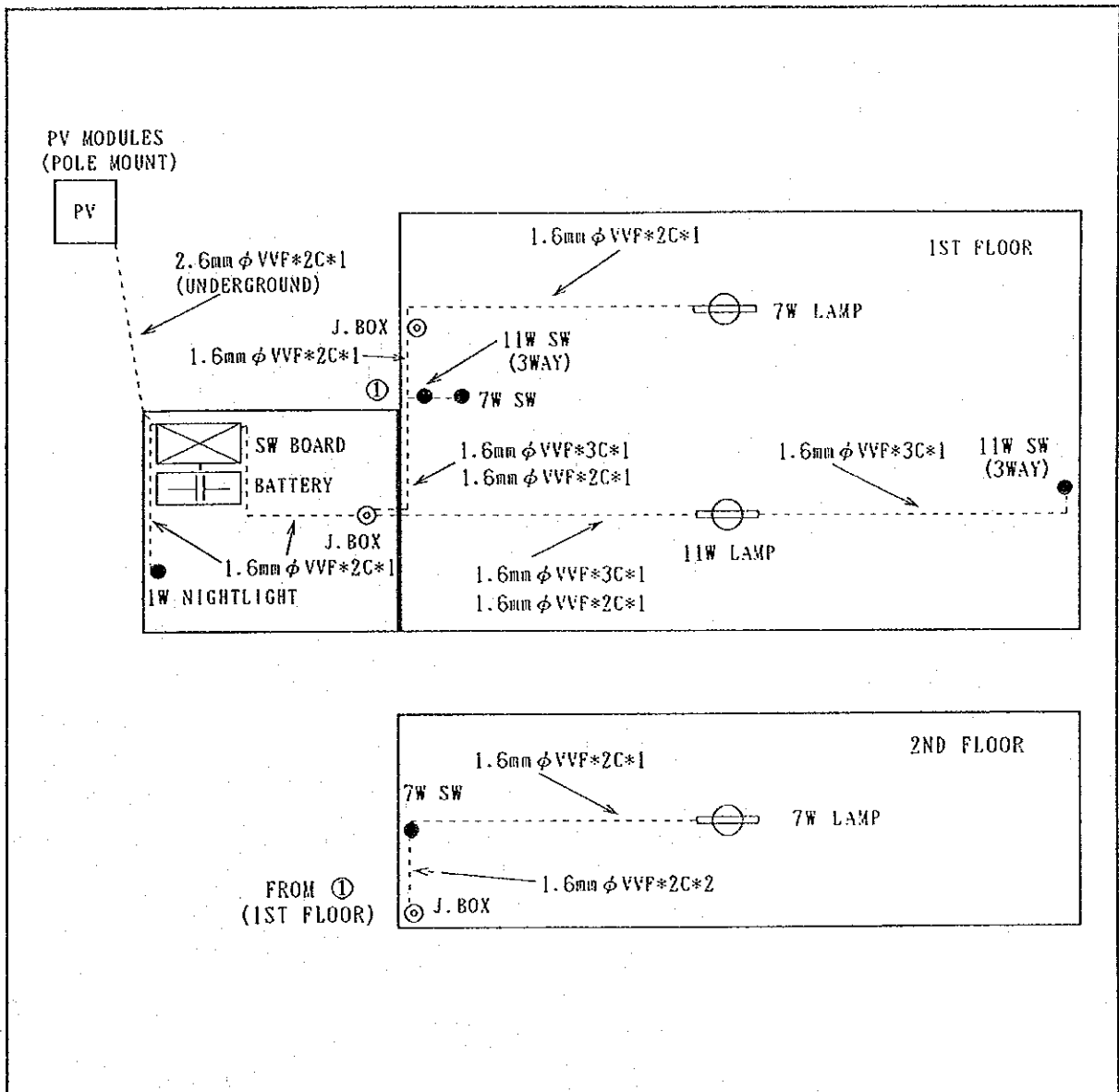

DATE	CHECKER	JUDGEMENT	DATE	CHECKER	JUDGEMENT

5. List of main equipment

No	Equipment Item	Quantity	No	Equipment Item	Quantity
1	PV Module	2 pcs	8	1W LED night light	1 ea
2	Pole Mount	1 set	9	No Fuse Braker(10(A))	1 ea
3	Charge Controller	1 ea	10	Main switch(30(A))	3 ea
4	Battery(12V-100Ah)	1 ea	11	Protection Fuse(15(A))	1 ea
5	Battery Box	1 ea	12	Junction Box	3 pcs
6	Fluorescent Lamp(11w)	1 ea	13	Switch(7(W))	2 pcs
7	Fluorescent Lamp(7w)	2 pcs	14	3Way switch(11(W))	2 pcs

File of PV system Facility for Private House

1. Name of householder : A i r i n
2. Code NO : N 3 8
3. Name of village : N o t o u e
4. Drawing of PV Facility

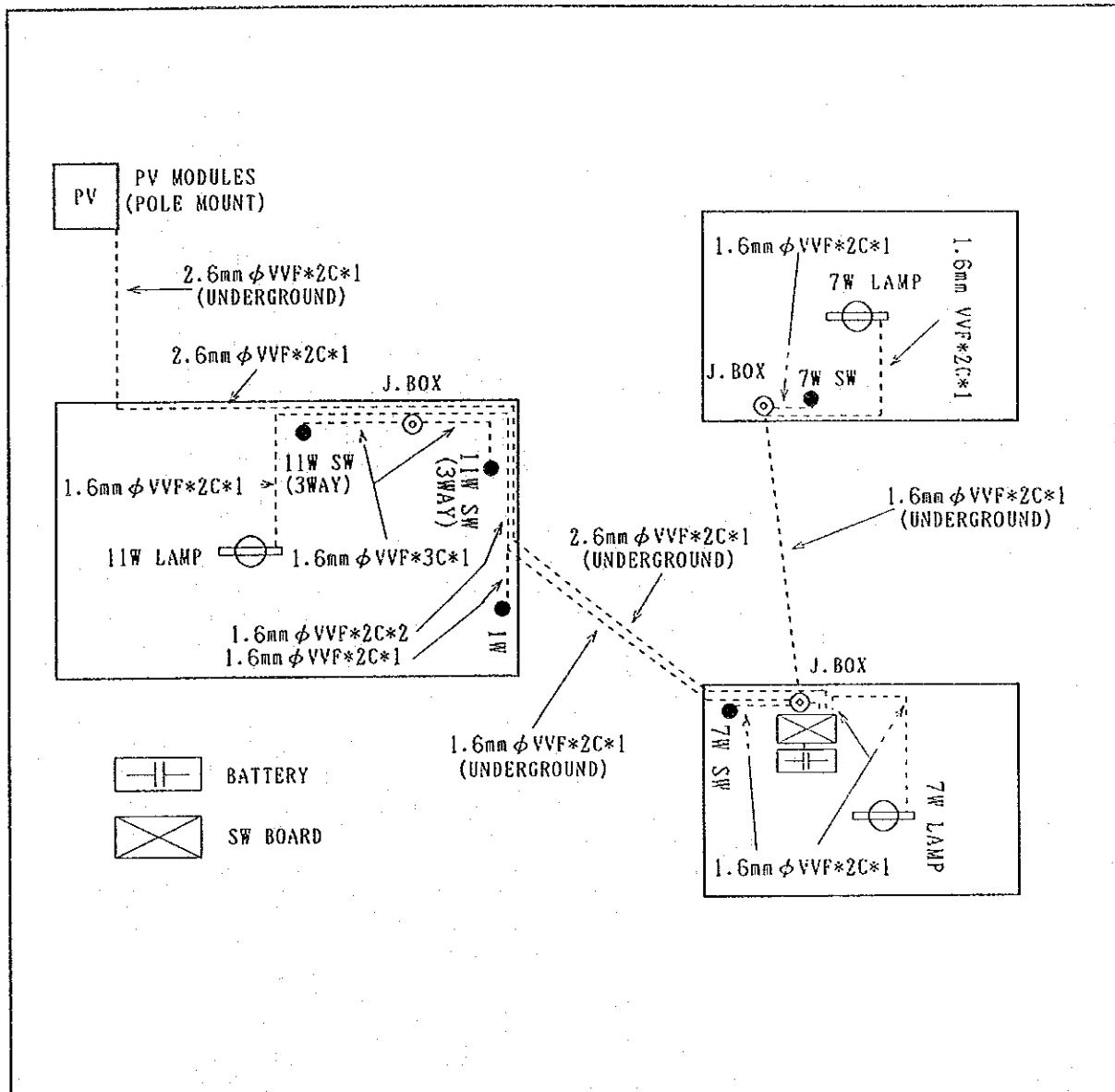

DATE	CHECKER	JUDGEMENT	DATE	CHECKER	JUDGEMENT

5. List of main equipment

Equipment Item	Quantity	Equipment Item	Quantity
1 PV Module	2 pcs	8 1W LED night light	1 ea
2 Pole Mount	1 set	9 No Fuse Braker(10(A))	1 ea
3 Charge Controller	1 ea	10 Main switch(30(A))	3 ea
4 Battery(12V-100Ah)	1 ea	11 Protection Fuse(15(A))	1 ea
5 Battery Box	1 ea	12 Junction Box	3 pcs
6 Fluorescent Lamp(11w)	1 ea	13 Switch(7(W))	2 pcs
7 Fluorescent Lamp(7w)	2 pcs	14 3Way switch(11(W))	2 pcs

File of PV system Facility for Private House

1. Name of householder : Roniiti Tetabo
2. Code NO :
3. Name of village : Notou e
4. Drawing of PV Facility

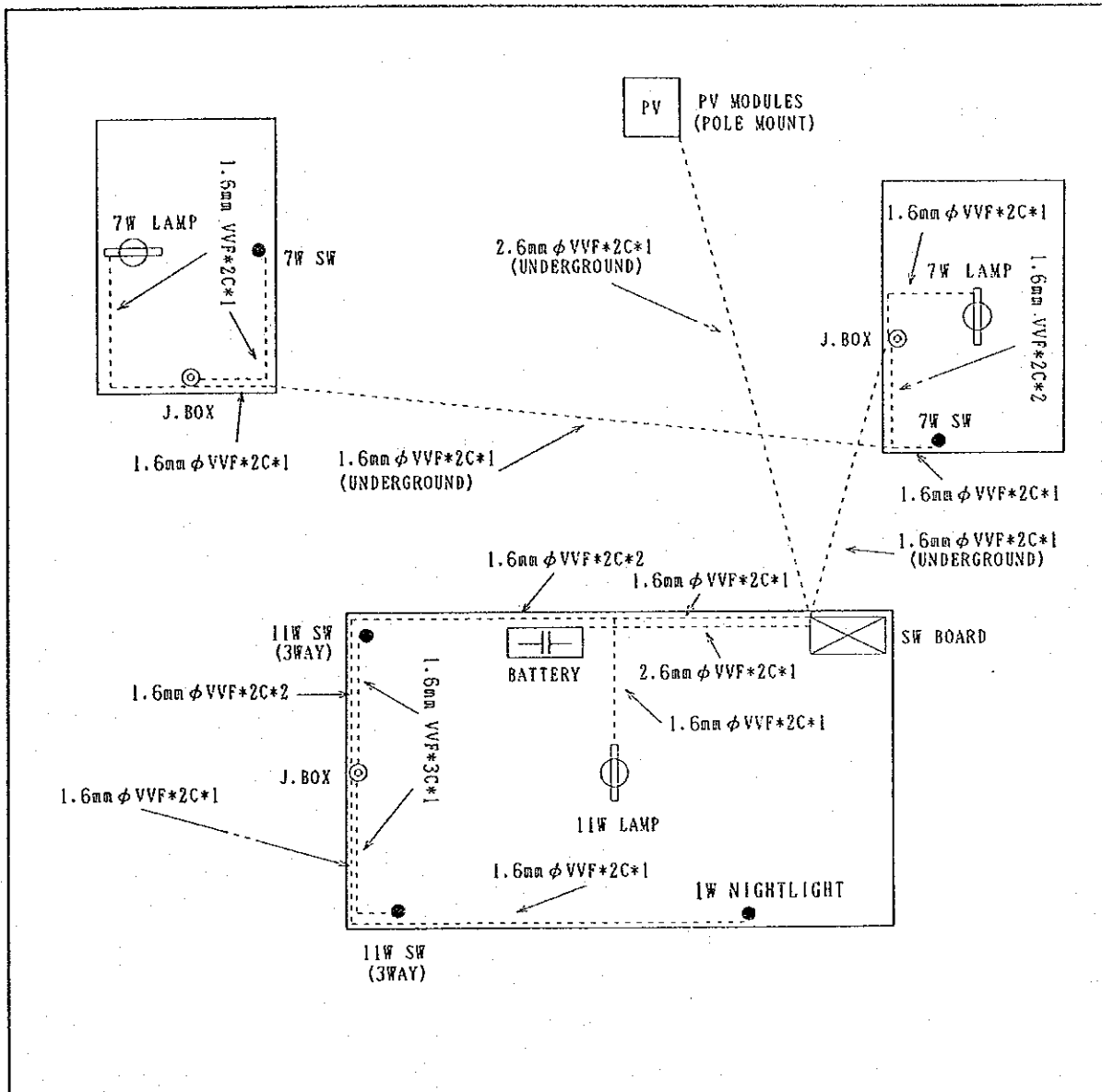

DATE	CHECKER	JUDGEMENT	DATE	CHECKER	JUDGEMENT

5. List of main equipment

No	Equipment Item	Quantity	No	Equipment Item	Quantity
1	PV Module	2 pcs	8	1W LED night light	1 ea
2	Pole Mount	1 set	9	No Fuse Braker(10(A))	1 ea
3	Charge Controller	1 ea	10	Main switch(30(A))	3 ea
4	Battery(12V-100Ah)	1 ea	11	Protection Fuse(15(A))	1 ea
5	Battery Box	1 ea	12	Junction Box	3 pcs
6	Fluorescent Lamp(11w)	1 ea	13	Switch(7(W))	2 pcs
7	Fluorescent Lamp(7w)	2 pcs	14	3Way switch(11(W))	2 pcs

File of PV system Facility for Private House

1. Name of householder : T a u k a b a n I o a n e
2. Code NO :
3. Name of village : N o t o u e
4. Drawing of PV Facility

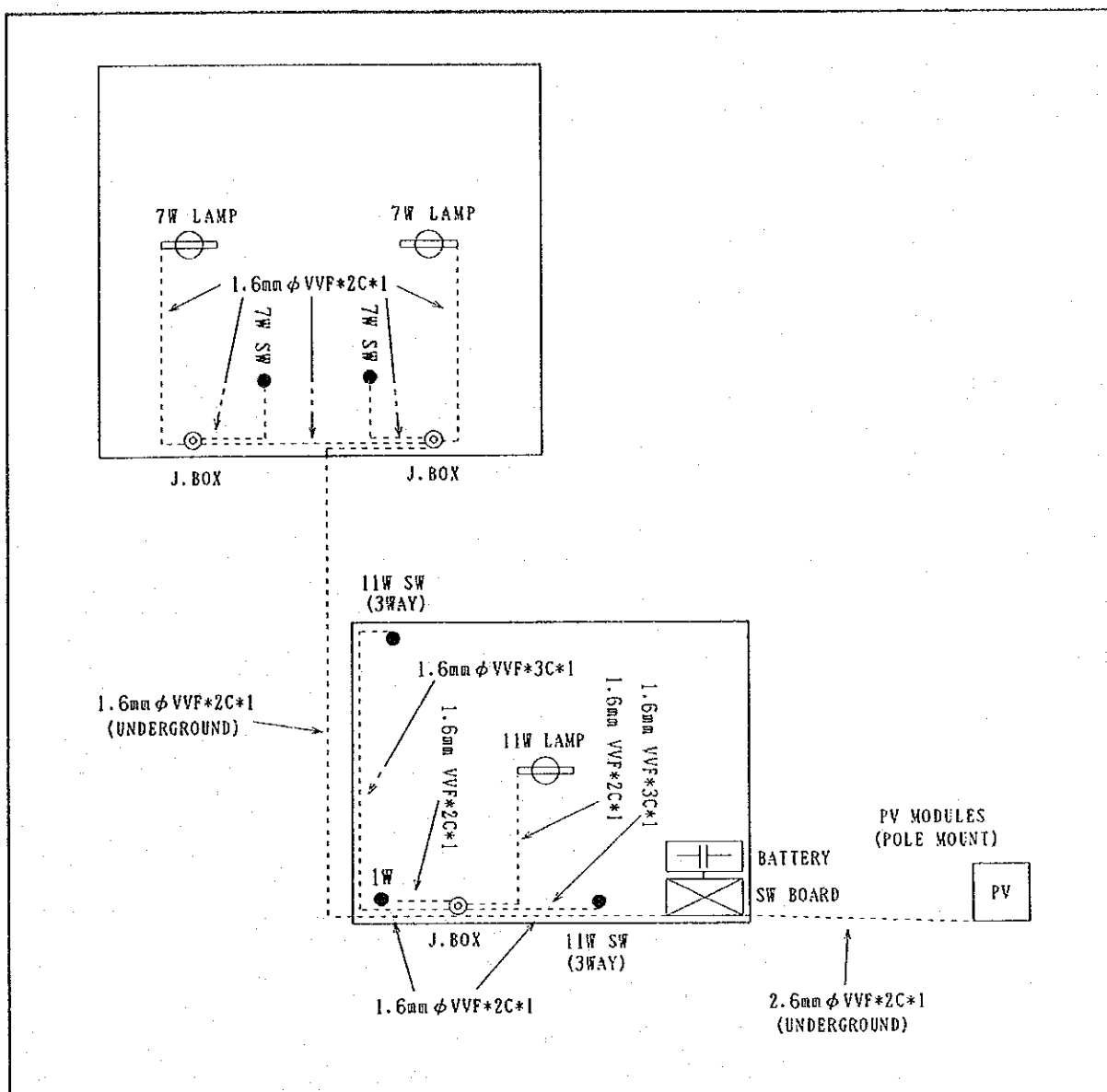

DATE	CHECKER	JUDGEMENT	DATE	CHECKER	JUDGEMENT

5. List of main equipment

No	Equipment Item	Quantity	No	Equipment Item	Quantity
1	PV Module	2 pcs	8	1W LED night light	1 ea
2	Pole Mount	1 set	9	No Fuse Braker(10(A))	1 ea
3	Charge Controller	1 ea	10	Main switch(30(A))	3 ea
4	Battery(12V-100Ah)	1 ea	11	Protection Fuse(15(A))	1 ea
5	Battery Box	1 ea	12	Junction Box	3 pcs
6	Fluorescent Lamp(11w)	1 ea	13	Switch(7(W))	2 pcs
7	Fluorescent Lamp(7w)	2 pcs	14	3Way switch(11(W))	2 pcs

File of PV system Facility for Private House

1. Name of householder : Tamuera Karebanga
2. Code NO :
3. Name of village : Notoue
4. Drawing of PV Facility

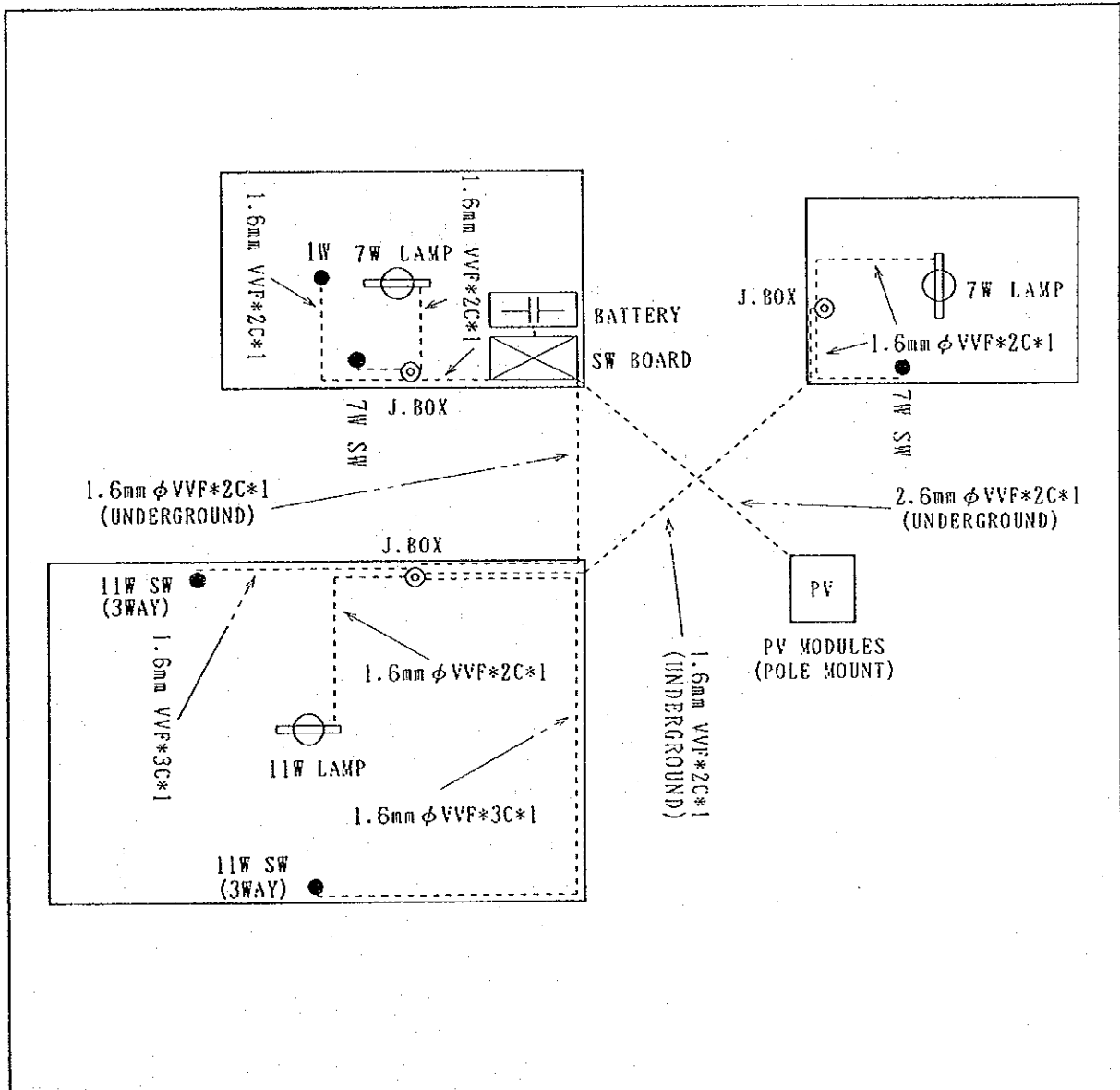

DATE	CHECKER	JUDGEMENT	DATE	CHECKER	JUDGEMENT

5. List of main equipment

	Equipment Item	Quantity		Equipment Item	Quantity
1	PV Module	2 pcs	8	1W LED night light	1 ea
2	Pole Mount	1 set	9	No Fuse Braker(10(A))	1 ea
3	Charge Controller	1 ea	10	Main switch(30(A))	3 ea
4	Battery(12V-100Ah)	1 ea	11	Protection Fuse(15(A))	1 ea
5	Battery Box	1 ea	12	Junction Box	3 pcs
6	Fluorescent Lamp(11w)	1 ea	13	Switch(7(W))	2 pcs
7	Fluorescent Lamp(7w)	2 pcs	14	3Way switch(11(W))	2 pcs

File of PV system Facility for Private House

1. Name of householder : T e b i k e N e n e i a
2. Code NO :
3. Name of village : N o t o u e
4. Drawing of PV Facility

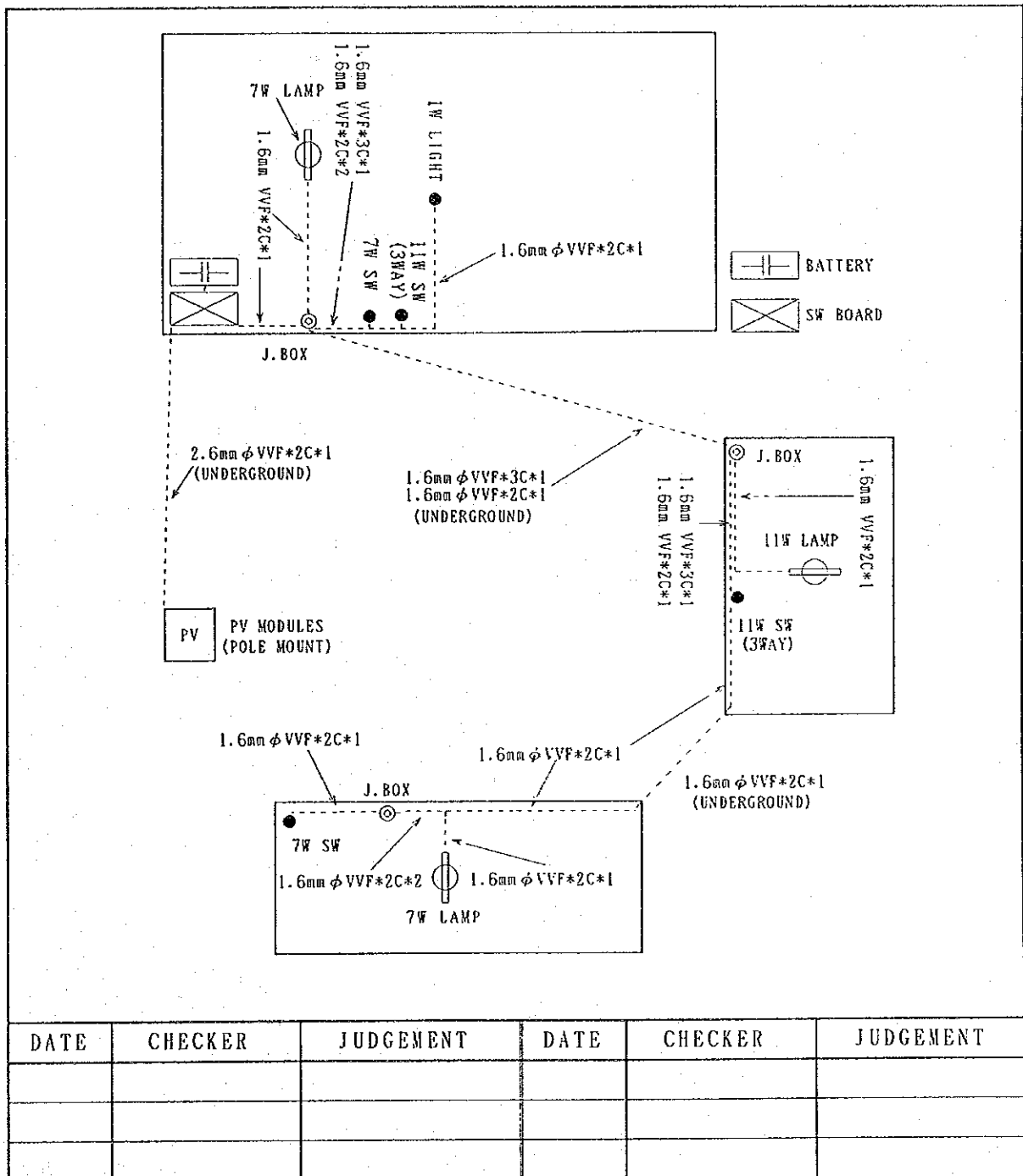

5. List of main equipment

Equipment Item	Quantity	Equipment Item	Quantity
1 PV Module	2 pcs	8 1W LED night light	1 ea
2 Pole Mount	1 set	9 No Fuse Braker(10(A))	1 ea
3 Charge Controller	1 ea	10 Main switch(30(A))	3 ea
4 Battery(12V-100Ah)	1 ea	11 Protection Fuse(15(A))	1 ea
5 Battery Box	1 ea	12 Junction Box	3 pcs
6 Fluorescent Lamp(11w)	1 ea	13 Switch(7(W))	2 pcs
7 Fluorescent Lamp(7w)	2 pcs	14 3Way switch(11(W))	2 pcs

File of PV system Facility for Private House

1. Name of householder : T i i b a u
2. Code NO :
3. Name of village : N o t o u e
4. Drawing of PV Facility

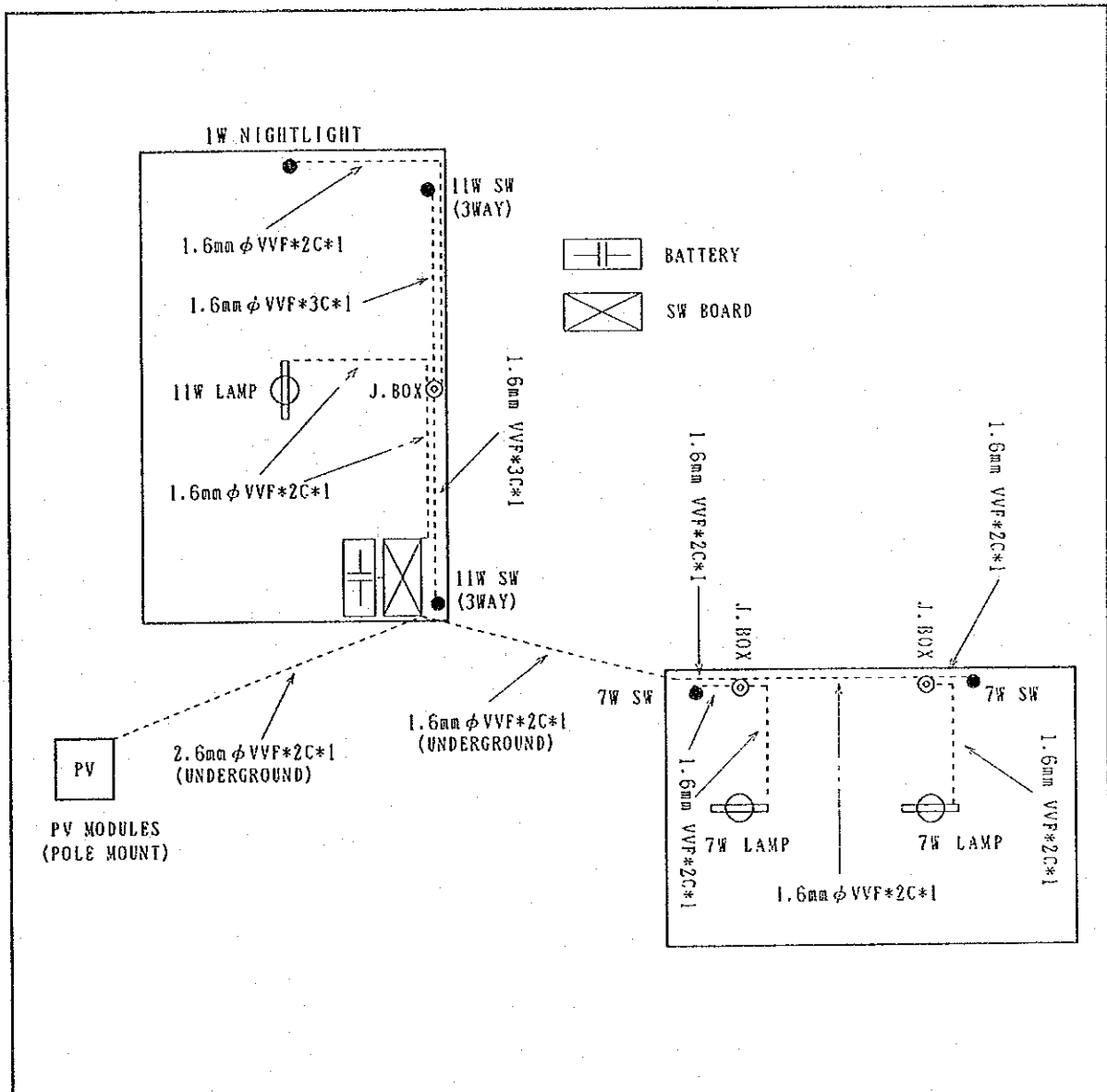

DATE	CHECKER	JUDGEMENT	DATE	CHECKER	JUDGEMENT

5. List of main equipment

No	Equipment Item	Quantity	No	Equipment Item	Quantity
1	PV Module	2 pcs	8	1W LED night light	1 ea
2	Pole Mount	1 set	9	No Fuse Braker(10(A))	1 ea
3	Charge Controller	1 ea	10	Main switch(30(A))	3 ea
4	Battery(12V-100Ah)	1 ea	11	Protection Fuse(15(A))	1 ea
5	Battery Box	1 ea	12	Junction Box	3 pcs
6	Fluorescent Lamp(11w)	1 ea	13	Switch(7(W))	2 pcs
7	Fluorescent Lamp(7w)	2 pcs	14	3Way switch(11(W))	2 pcs

File of PV system Facility for Private House

1. Name of householder : A b a k u k a
2. Code NO : A 1
3. Name of village : A b a o k o r o
4. Drawing of PV Facility

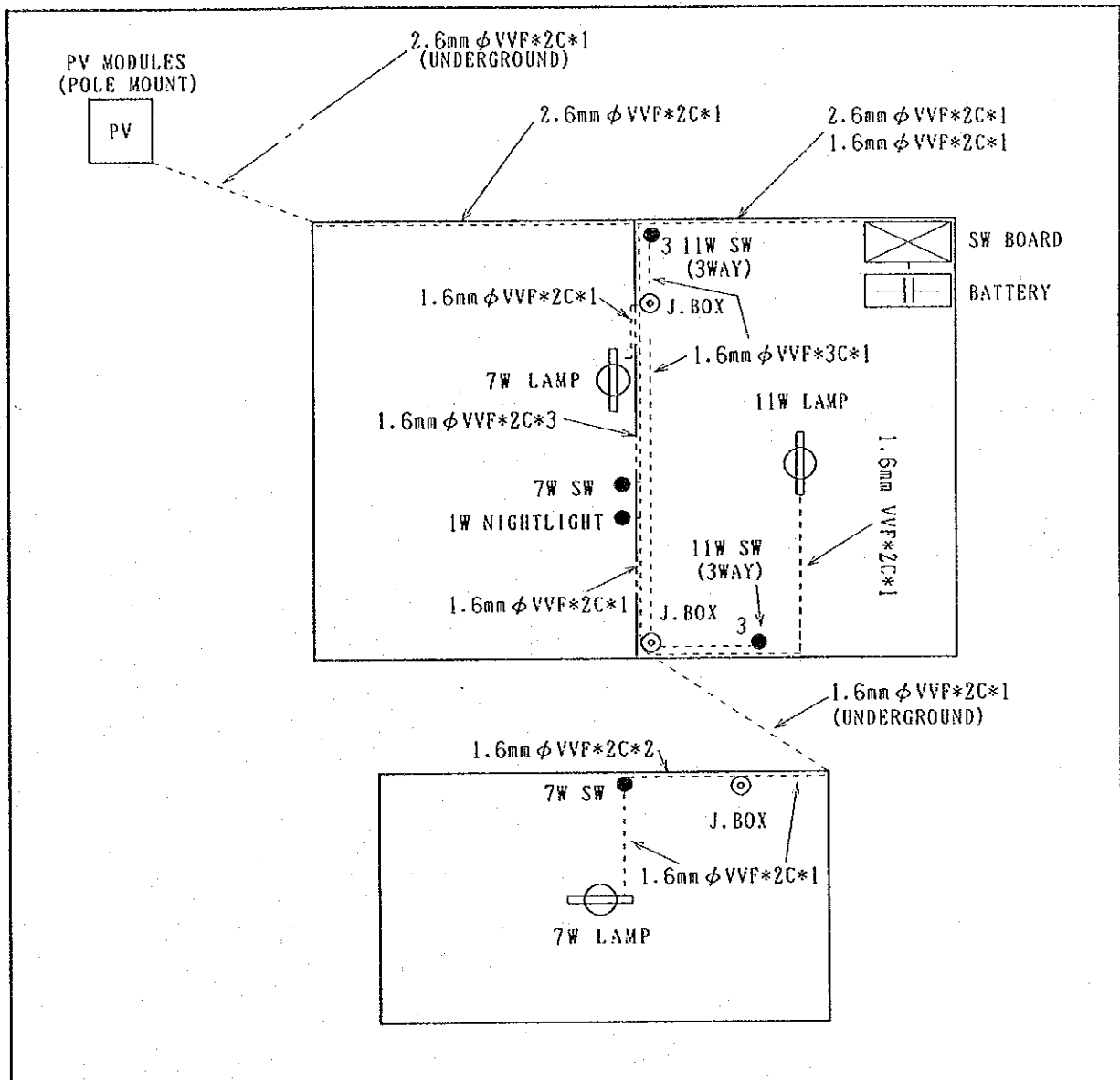

DATE	CHECKER	JUDGEMENT	DATE	CHECKER	JUDGEMENT

5. List of main equipment

No	Equipment Item	Quantity	No	Equipment Item	Quantity
1	PV Module	2 pcs	8	1W LED night light	1 ea
2	Pole Mount	1 set	9	No Fuse Braker(10(A))	1 ea
3	Charge Controller	1 ea	10	Main switch(30(A))	3 ea
4	Battery(12V-100Ah)	1 ea	11	Protection Fuse(15(A))	1 ea
5	Battery Box	1 ea	12	Junction Box	3 pcs
6	Fluorescent Lamp(11w)	1 ea	13	Switch(7(W))	2 pcs
7	Fluorescent Lamp(7w)	2 pcs	14	3Way switch(11(W))	2 pcs

File of PV system Facility for Private House

1. Name of householder : B e i a T o a r a
2. Code NO : A 4
3. Name of village : A b a o k o r o
4. Drawing of PV Facility

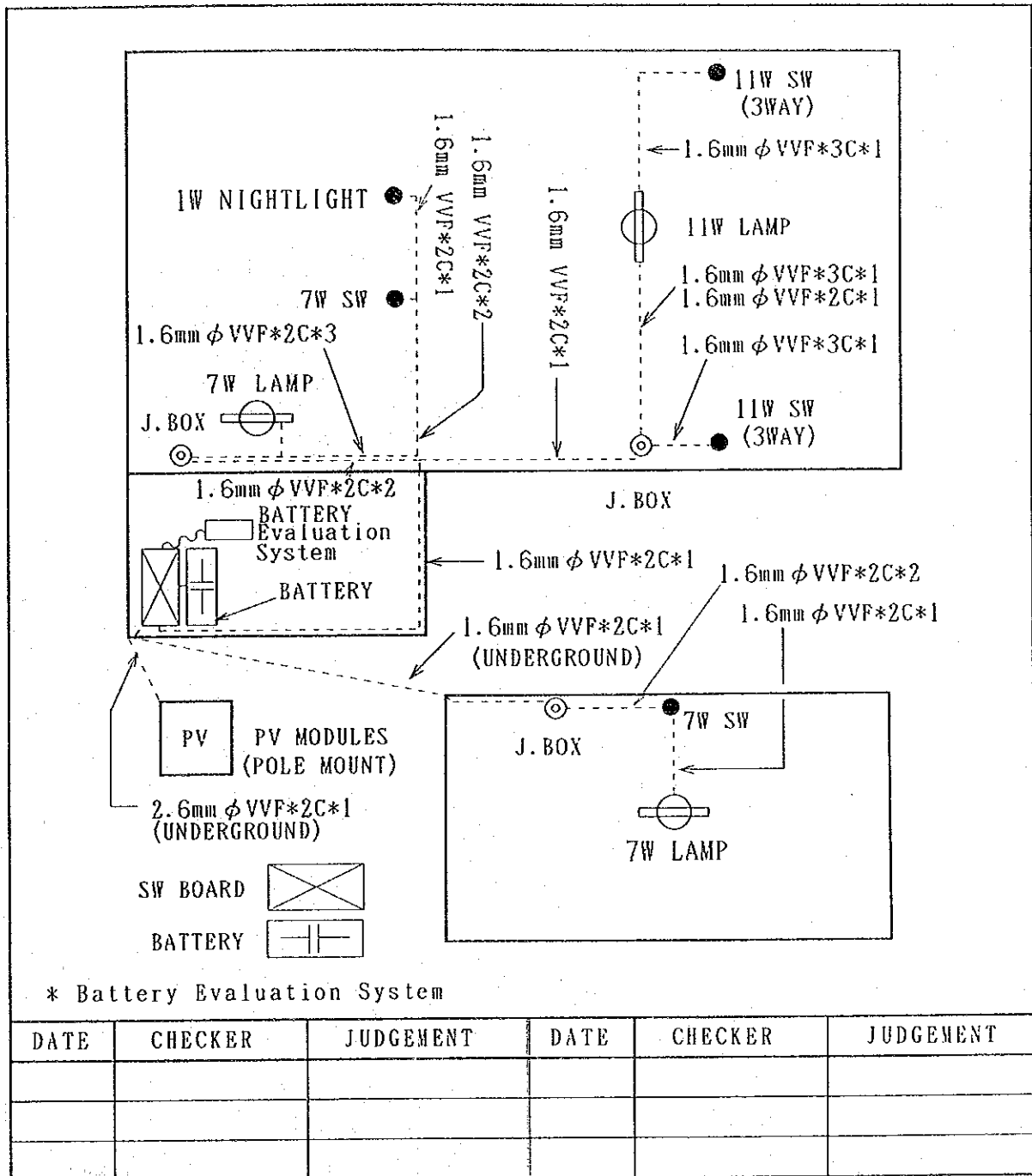

5. List of main equipment

Equipment Item	Quantity	Equipment Item	Quantity
1 PV Module	2 pcs	8 1W LED night light	1 ea
2 Pole Mount	1 set	9 No Fuse Braker(10(A))	1 ea
3 Charge Controller	1 ea	10 Main switch(30(A))	3 ea
4 Battery(12V-100Ah)	1 ea	11 Protection Fuse(15(A))	1 ea
5 Battery Box	1 ea	12 Junction Box	3 pcs
6 Fluorescent Lamp(11w)	1 ea	13 Switch(7(W))	2 pcs
7 Fluorescent Lamp(7w)	2 pcs	14 3Way switch(11(W))	2 pcs

File of PV system Facility for Private House

1. Name of householder : Ekeieta Ititake
2. Code NO : A 5
3. Name of village : Abaokoro
4. Drawing of PV Facility

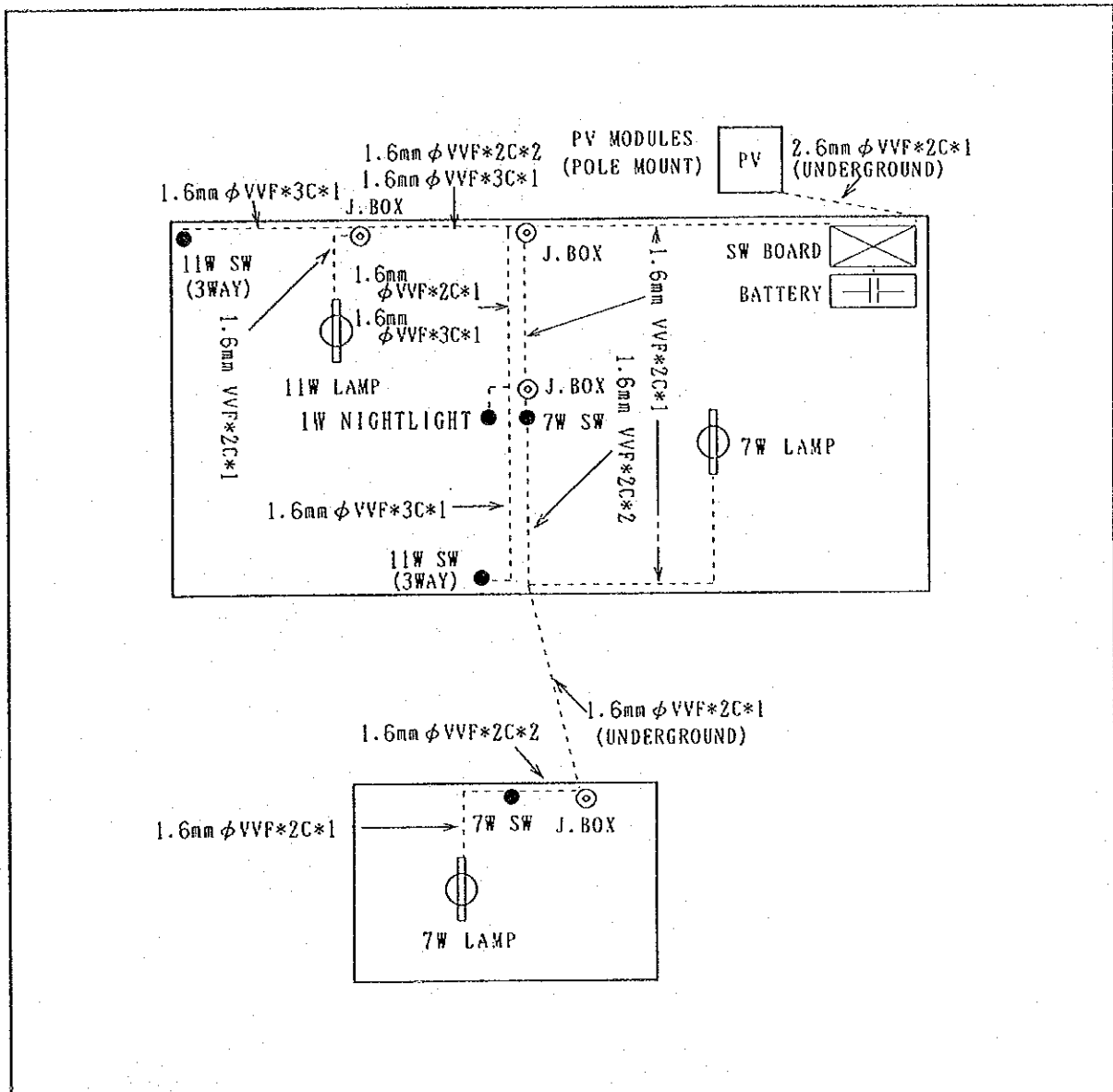

DATE	CHECKER	JUDGEMENT	DATE	CHECKER	JUDGEMENT

5. List of main equipment

	Equipment Item	Quantity		Equipment Item	Quantity
1	PV Module	2 pcs	8	1W LED night light	1 ea
2	Pole Mount	1 set	9	No Fuse Braker(10(A))	1 ea
3	Charge Controller	1 ea	10	Main switch(30(A))	3 ea
4	Battery(12V-100Ah)	1 ea	11	Protection Fuse(15(A))	1 ea
5	Battery Box	1 ea	12	Junction Box	3 pcs
6	Fluorescent Lamp(11w)	1 ea	13	Switch(7(W))	2 pcs
7	Fluorescent Lamp(7w)	2 pcs	14	3way switch(11(W))	2 pcs

File of PV system Facility for Private House

1. Name of householder : L o u i N a m a n e
2. Code NO : A 9
3. Name of village : A b a o k o r o
4. Drawing of PV Facility

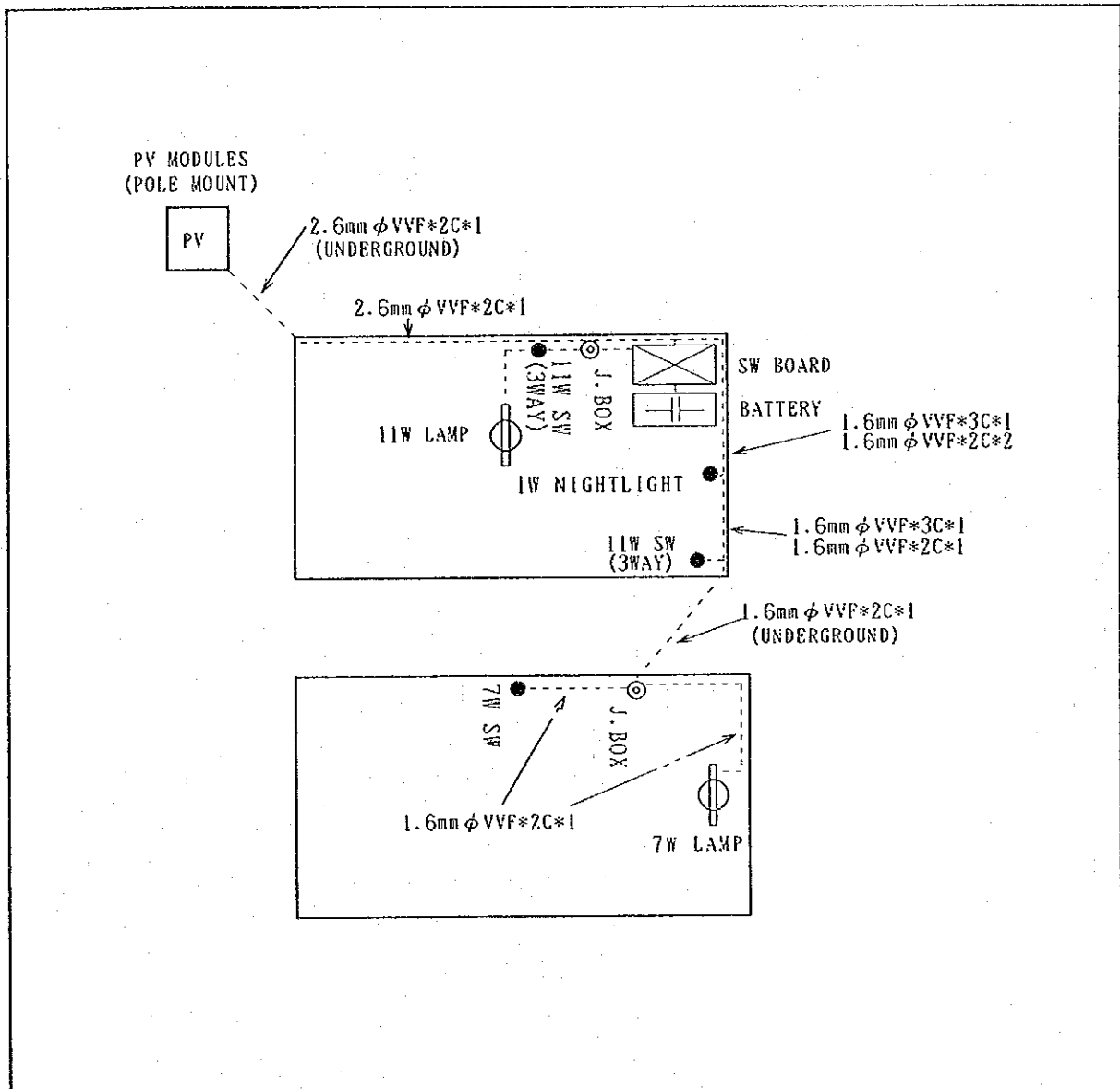

DATE	CHECKER	JUDGEMENT	DATE	CHECKER	JUDGEMENT

5. List of main equipment

Equipment Item	Quantity	Equipment Item	Quantity
1 PV Module	2 pcs	8 1W LED night light	1 ea
2 Pole Mount	1 set	9 No Fuse Braker(10(A))	1 ea
3 Charge Controller	1 ea	10 Main switch(30(A))	3 ea
4 Battery(12V-100Ah)	1 ea	11 Protection Fuse(15(A))	1 ea
5 Battery Box	1 ea	12 Junction Box	3 pcs
6 Fluorescent Lamp(11w)	1 ea	13 Switch(7(W))	1 pcs
7 Fluorescent Lamp(7w)	1 pcs	14 3Way switch(11(W))	2 pcs

File of PV system Facility for Private House

1. Name of householder : Natiria Tamton
2. Code NO : A10
3. Name of village : Abaokoro
4. Drawing of PV Facility

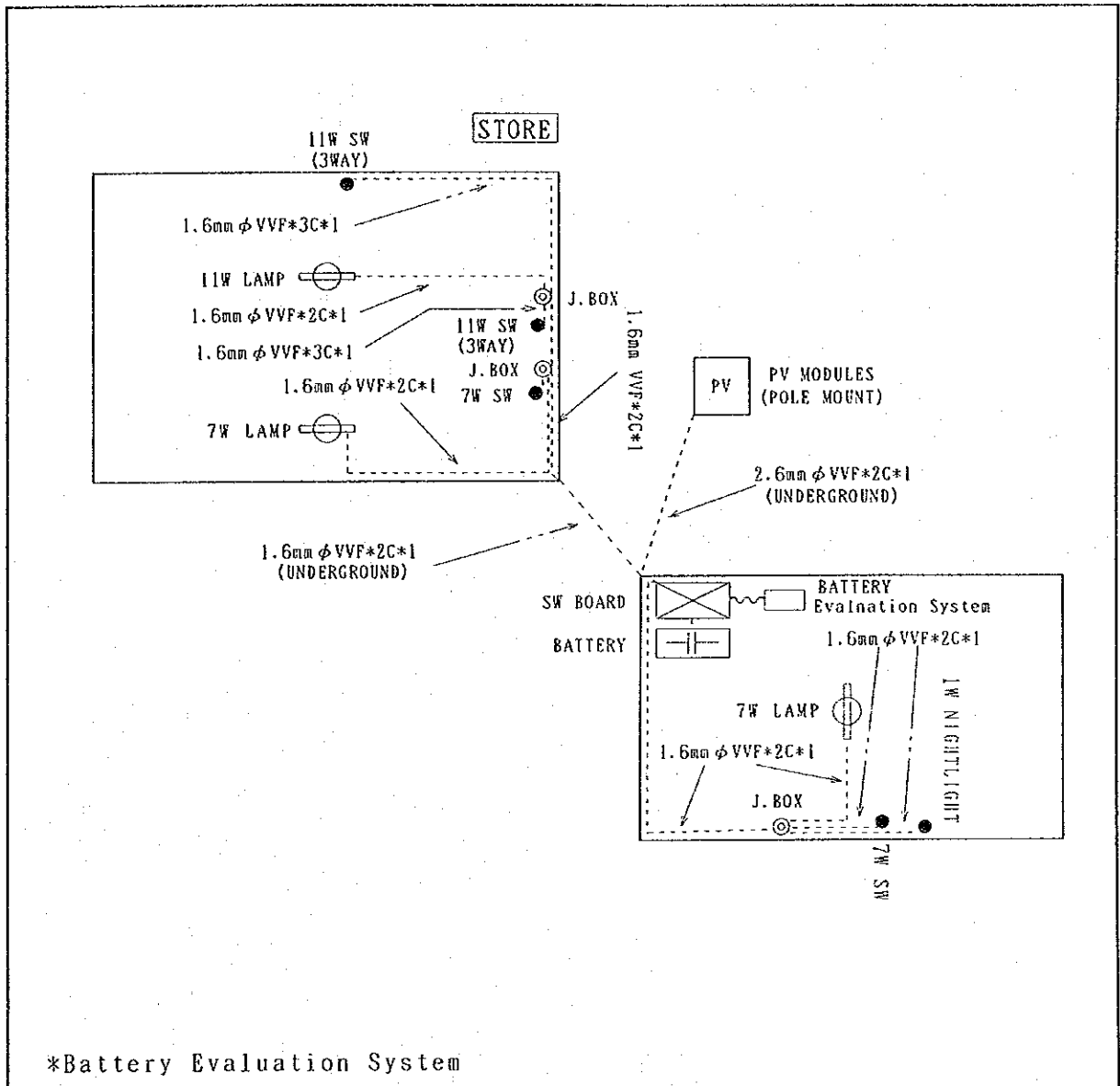

DATE	CHECKER	JUDGEMENT	DATE	CHECKER	JUDGEMENT

5. List of main equipment

	Equipment Item	Quantity		Equipment Item	Quantity
1	PV Module	2 pcs	8	1W LED night light	1 ea
2	Pole Mount	1 set	9	No Fuse Braker(10(A))	1 ca
3	Charge Controller	1 ea	10	Main switch(30(A))	3 ca
4	Battery(12V-100Ah)	1 ea	11	Protection Fuse(15(A))	1 ea
5	Battery Box	1 ea	12	Junction Box	3 pcs
6	Fluorescent Lamp(11w)	1 ea	13	Switch(7(W))	2 pcs
7	Fluorescent Lamp(7w)	2 pcs	14	3Way switch(11(W))	2 pcs

File of PV system Facility for Private House

1. Name of householder : O b e t a
2. Code NO : A 1 1
3. Name of village : A b a o k o r o
4. Drawing of PV Facility

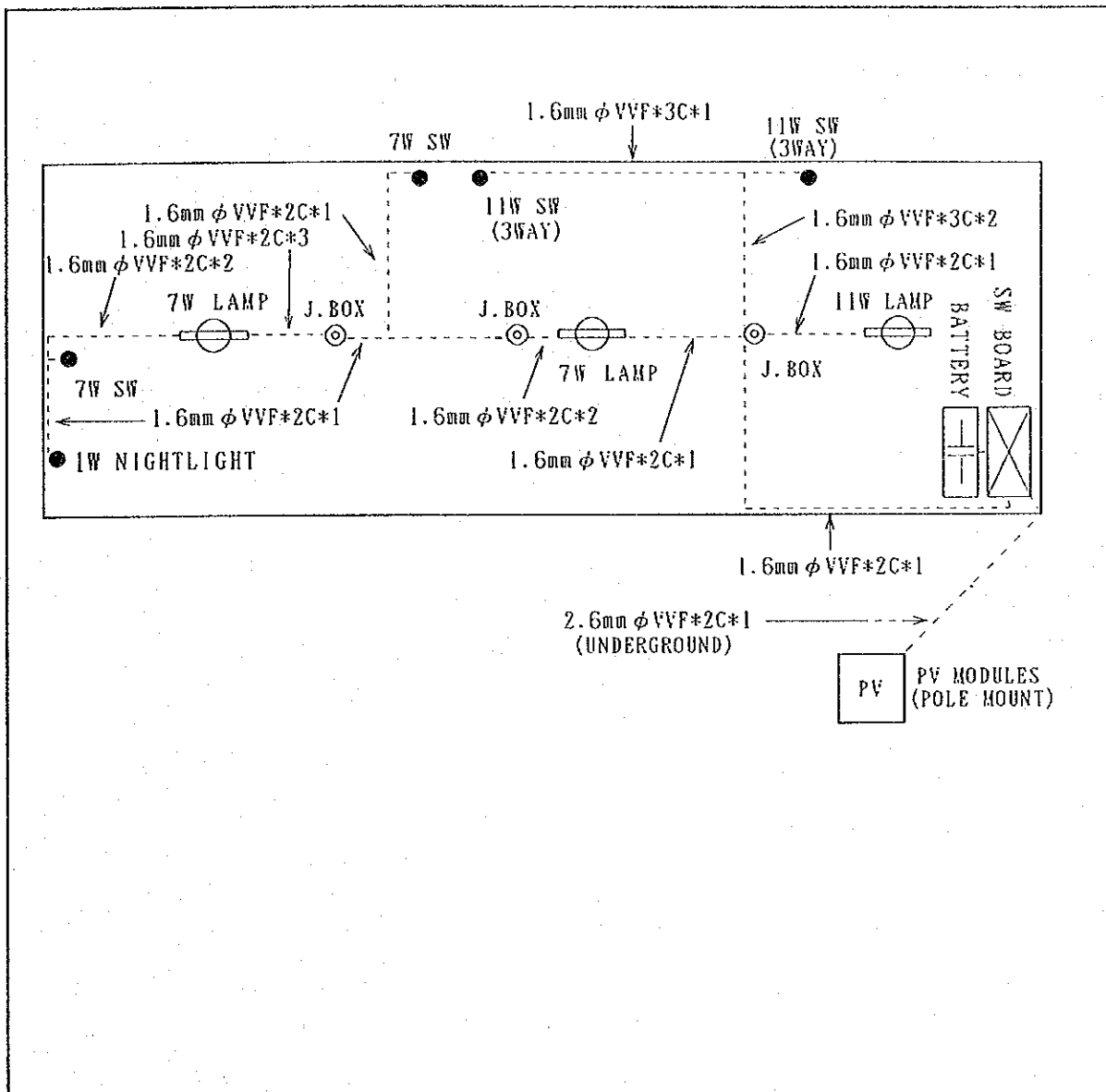

DATE	CHECKER	JUDGEMENT	DATE	CHECKER	JUDGEMENT

5. List of main equipment

No	Equipment Item	Quantity	No	Equipment Item	Quantity
1	PV Module	2 pcs	8	1W LED night light	1 ea
2	Pole Mount	1 set	9	No Fuse Braker(10(A))	1 ea
3	Charge Controller	1 ea	10	Main switch(30(A))	3 ea
4	Battery(12V-100Ah)	1 ea	11	Protection Fuse(15(A))	1 ea
5	Battery Box	1 ea	12	Junction Box	3 pcs
6	Fluorescent Lamp(11w)	1 ea	13	Switch(7(W))	2 pcs
7	Fluorescent Lamp(7w)	2 pcs	14	3Way switch(11(W))	2 pcs

File of PV system Facility for Private House

1. Name of householder : I e r u b a a r a
2. Code NO : A 1 6
3. Name of village : A b a o k o r o
4. Drawing of PV Facility

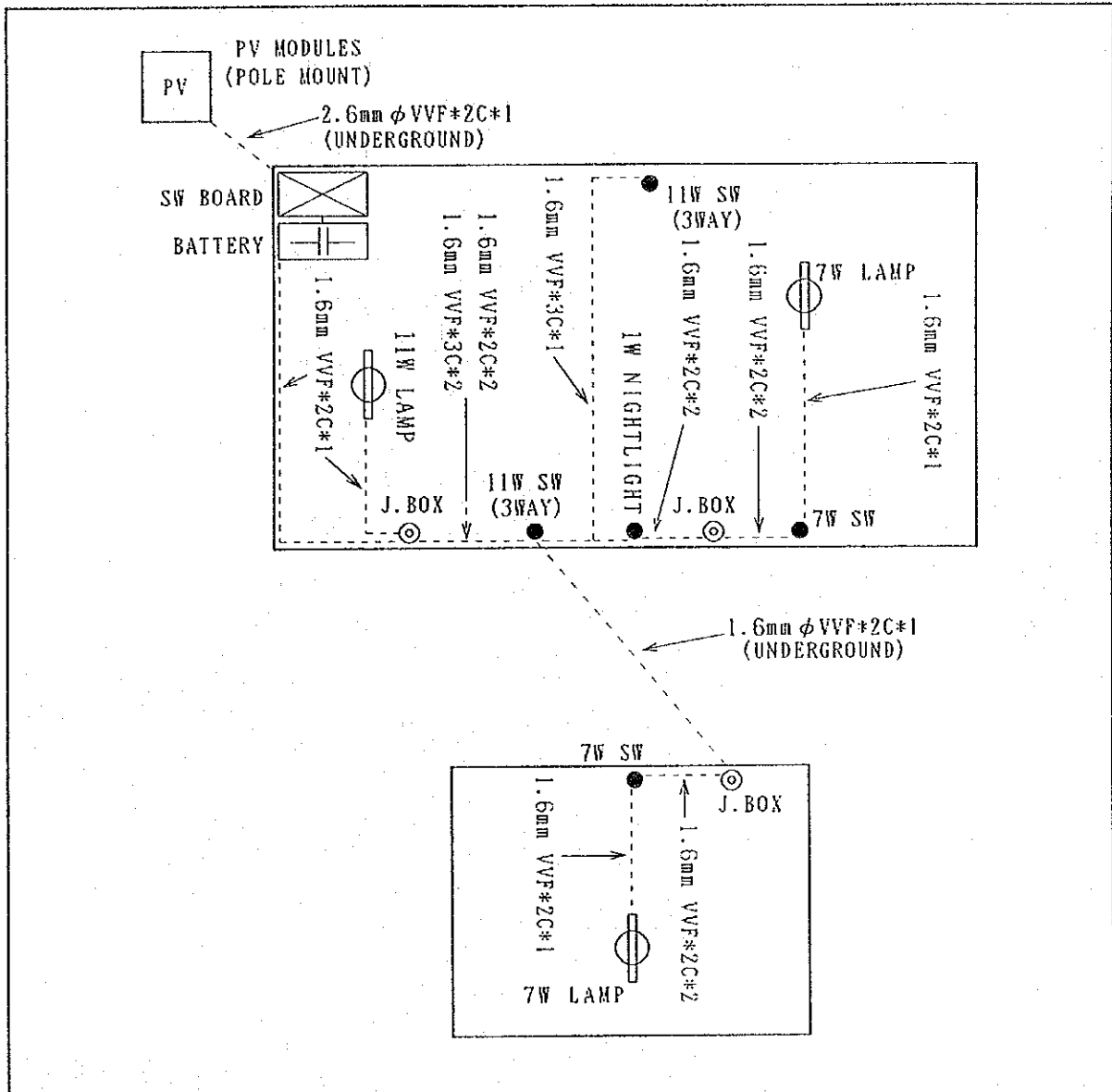

DATE	CHECKER	JUDGEMENT	DATE	CHECKER	JUDGEMENT

5. List of main equipment

No	Equipment Item	Quantity	No	Equipment Item	Quantity
1	PV Module	2 pcs	8	1W LED night light	1 ea
2	Pole Mount	1 set	9	No Fuse Braker(10(A))	1 ea
3	Charge Controller	1 ea	10	Main switch(30(A))	3 ea
4	Battery(12V-100Ah)	1 ea	11	Protection Fuse(15(A))	1 ea
5	Battery Box	1 ea	12	Junction Box	3 pcs
6	Fluorescent Lamp(11w)	1 ea	13	Switch(7(W))	2 pcs
7	Fluorescent Lamp(7w)	2 pcs	14	3Way switch(11(W))	2 pcs

File of PV system Facility for Private House

1. Name of householder : T e b u a k a
2. Code NO : A 1 7
3. Name of village : A b a o k o r o
4. Drawing of PV Facility

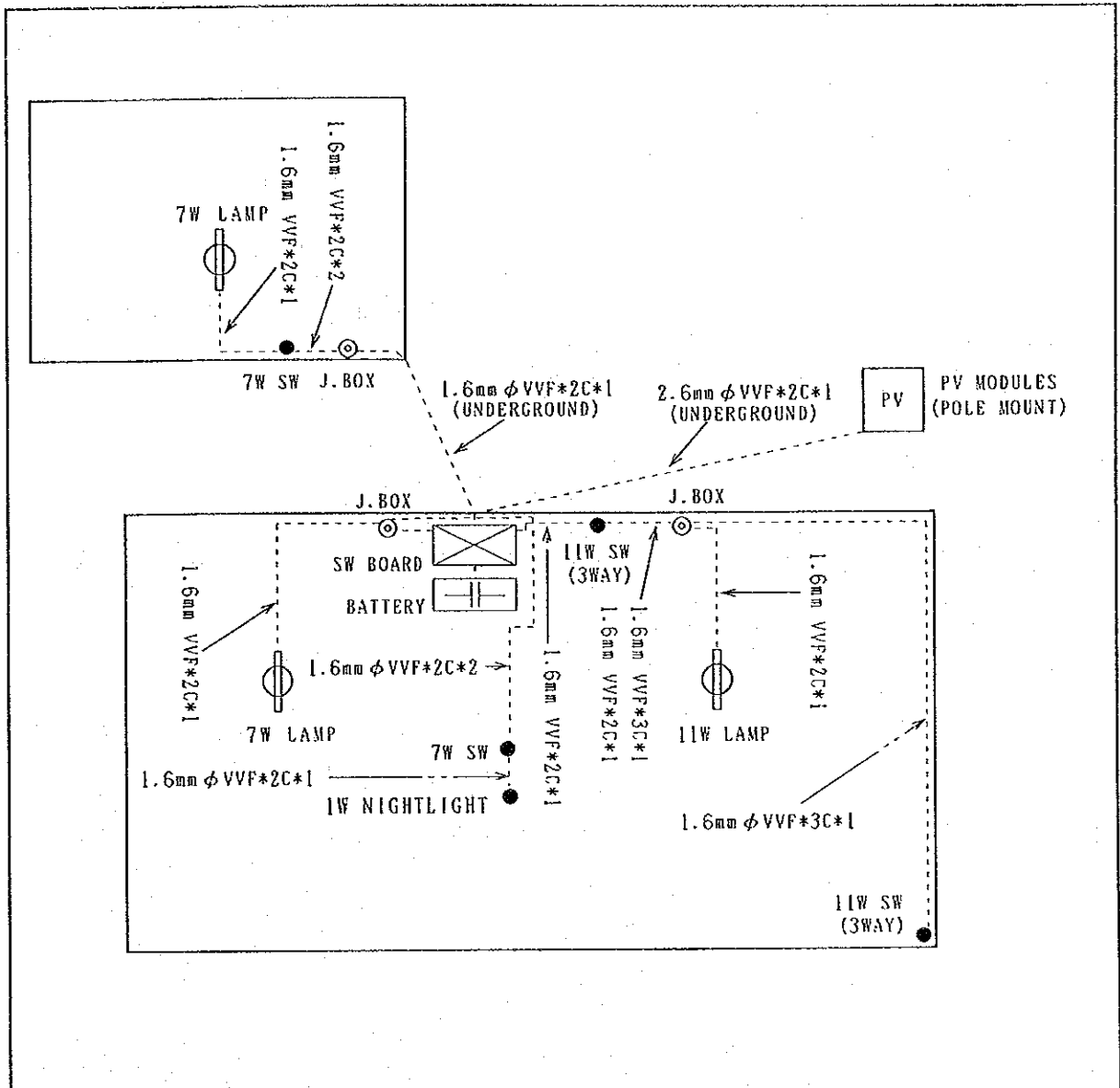

DATE	CHECKER	JUDGEMENT	DATE	CHECKER	JUDGEMENT

5. List of main equipment

	Equipment Item	Quantity		Equipment Item	Quantity
1	PV Module	2 pcs	8	1W LED night light	1 ea
2	Pole Mount	1 set	9	No Fuse Braker(10(A))	1 ea
3	Charge Controller	1 ea	10	Main switch(30(A))	3 ea
4	Battery(12V-100Ah)	1 ea	11	Protection Fuse(15(A))	1 ea
5	Battery Box	1 ea	12	Junction Box	3 pcs
6	Fluorescent Lamp(11w)	1 ea	13	Switch(7(W))	2 pcs
7	Fluorescent Lamp(7w)	2 pcs	14	3Way switch(11(W))	2 pcs

File of PV system Facility for Private House

1. Name of householder : T e k a k i a b o
2. Code NO : A 1 8
3. Name of village : A b a o k o r o
4. Drawing of PV Facility

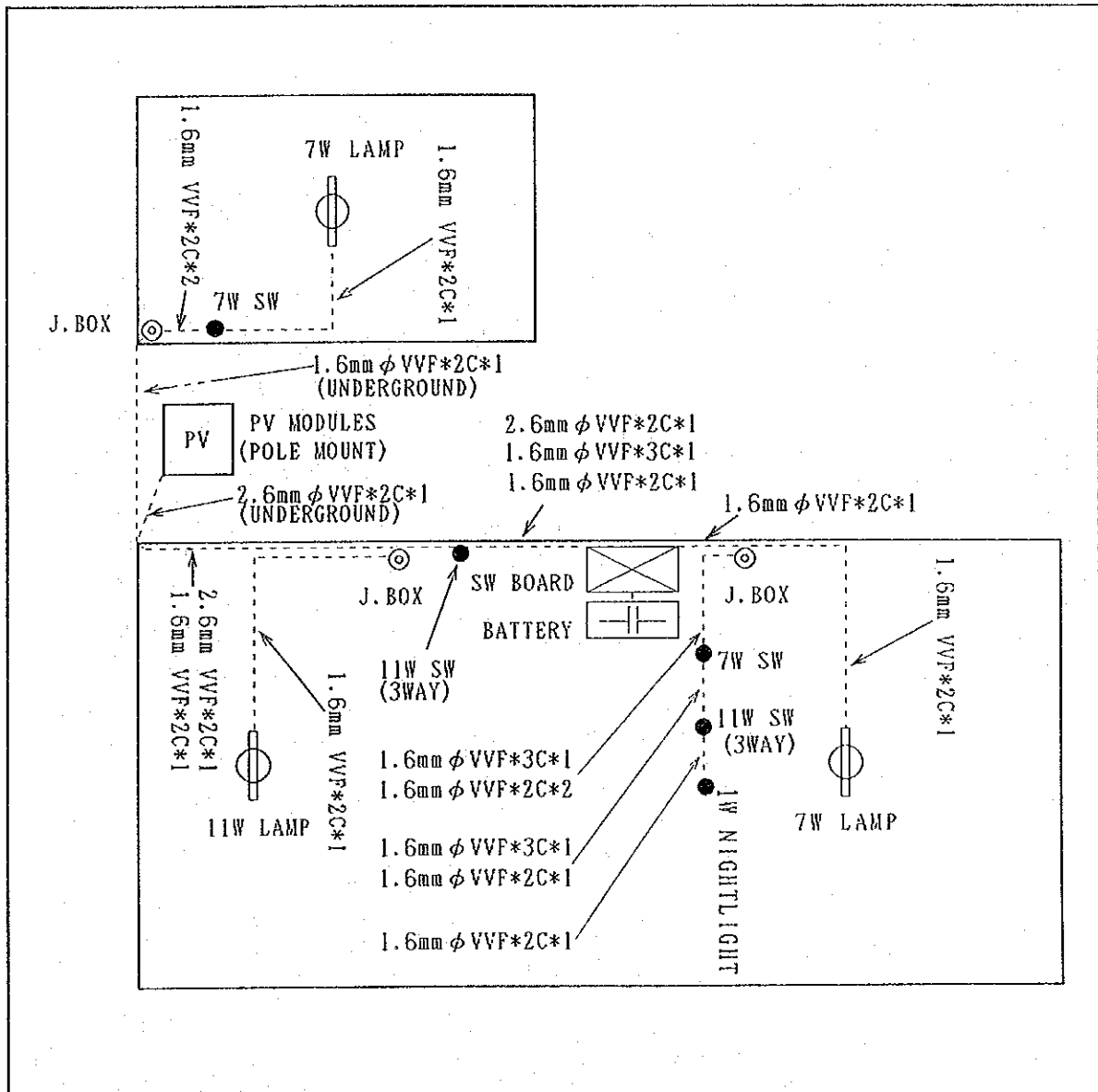

5. List of main equipment

	Equipment Item	Quantity		Equipment Item	Quantity
1	PV Module	2 pcs	8	1W LED night light	1 ea
2	Pole Mount	1 set	9	No Fuse Braker(10(A))	1 ea
3	Charge Controller	1 ea	10	Main switch(30(A))	3 ea
4	Battery(12V-100Ah)	1 ea	11	Protection Fuse(15(A))	1 ea
5	Battery Box	1 ea	12	Junction Box	3 pcs
6	Fluorescent Lamp(11w)	1 ea	13	Switch(7(W))	2 pcs
7	Fluorescent Lamp(7w)	2 pcs	14	3Way switch(11(W))	2 pcs

File of PV system Facility for Private House

1. Name of householder : Temarawa Kawitu
2. Code NO : A 2 1
3. Name of village : Abaokoro
4. Drawing of PV Facility

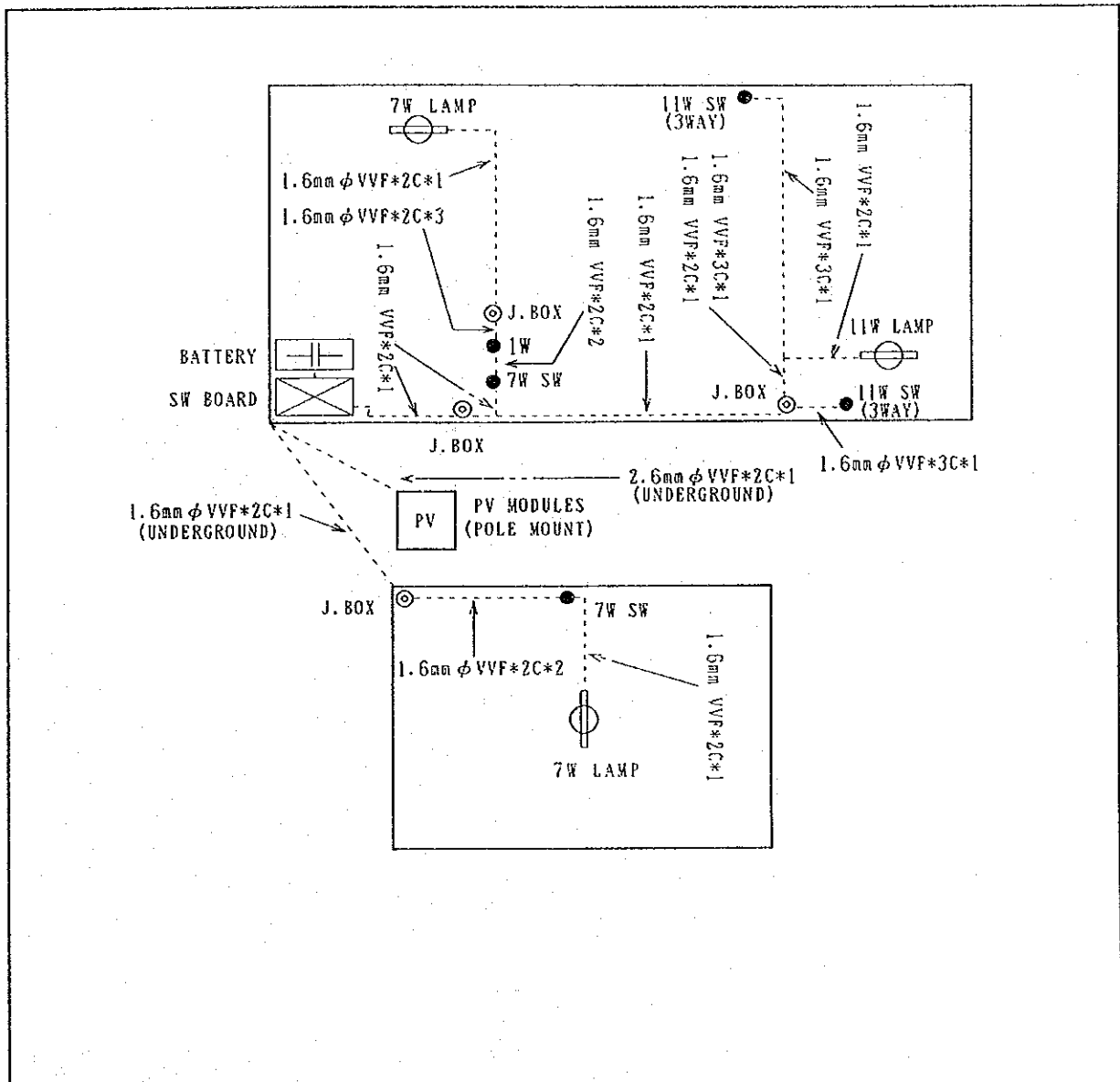

DATE	CHECKER	JUDGEMENT	DATE	CHECKER	JUDGEMENT

5. List of main equipment

	Equipment Item	Quantity		Equipment Item	Quantity
1	PV Module	2 pcs	8	1W LED night light	1 ea
2	Pole Mount	1 set	9	No Fuse Braker(10(A))	1 ea
3	Charge Controller	1 ea	10	Main switch(30(A))	3 ea
4	Battery(12V-100Ah)	1 ea	11	Protection Fuse(15(A))	1 ea
5	Battery Box	1 ea	12	Junction Box	3 pcs
6	Fluorescent Lamp(11w)	1 ea	13	Switch(7(W))	2 pcs
7	Fluorescent Lamp(7w)	2 pcs	14	3Way switch(11(W))	2 pcs

File of PV system Facility for Private House

1. Name of householder : M a k i n N g a t a u
2. Code NO : A 2 7
3. Name of village : A b a o k o r o
4. Drawing of PV Facility

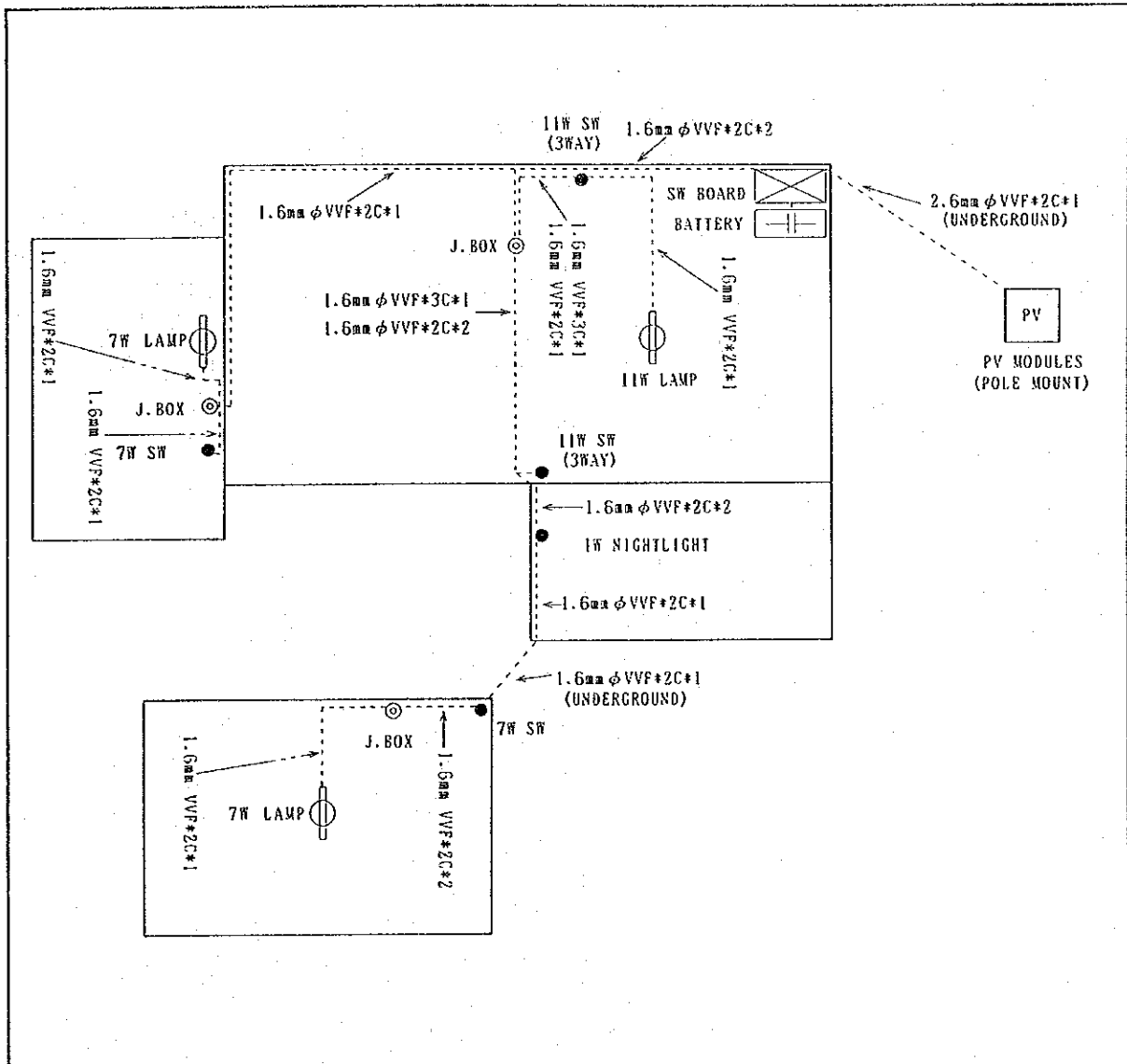

*SYSTEM Evaluation Facility

DATE	CHECKER	JUDGEMENT	DATE	CHECKER	JUDGEMENT

5. List of main equipment

Equipment Item	Quantity	Equipment Item	Quantity
1 PV Module	2 pcs	8 1W LED night light	1 ea
2 Pole Mount	1 set	9 No Fuse Braker(10(A))	1 ea
3 Charge Controller	1 ea	10 Main switch(30(A))	3 ea
4 Battery(12V-100Ah)	1 ea	11 Protection Fuse(15(A))	1 ea
5 Battery Box	1 ea	12 Junction Box	3 pcs
6 Fluorescent Lamp(11w)	1 ea	13 Switch(7(W))	2 pcs
7 Fluorescent Lamp(7w)	2 pcs	14 3Way switch(11(W))	2 pcs

File of PV system Facility for Private House

1. Name of householder : T a u k a b a n
2. Code NO : A 2 9
3. Name of village : A b a o k o r o
4. Drawing of PV Facility

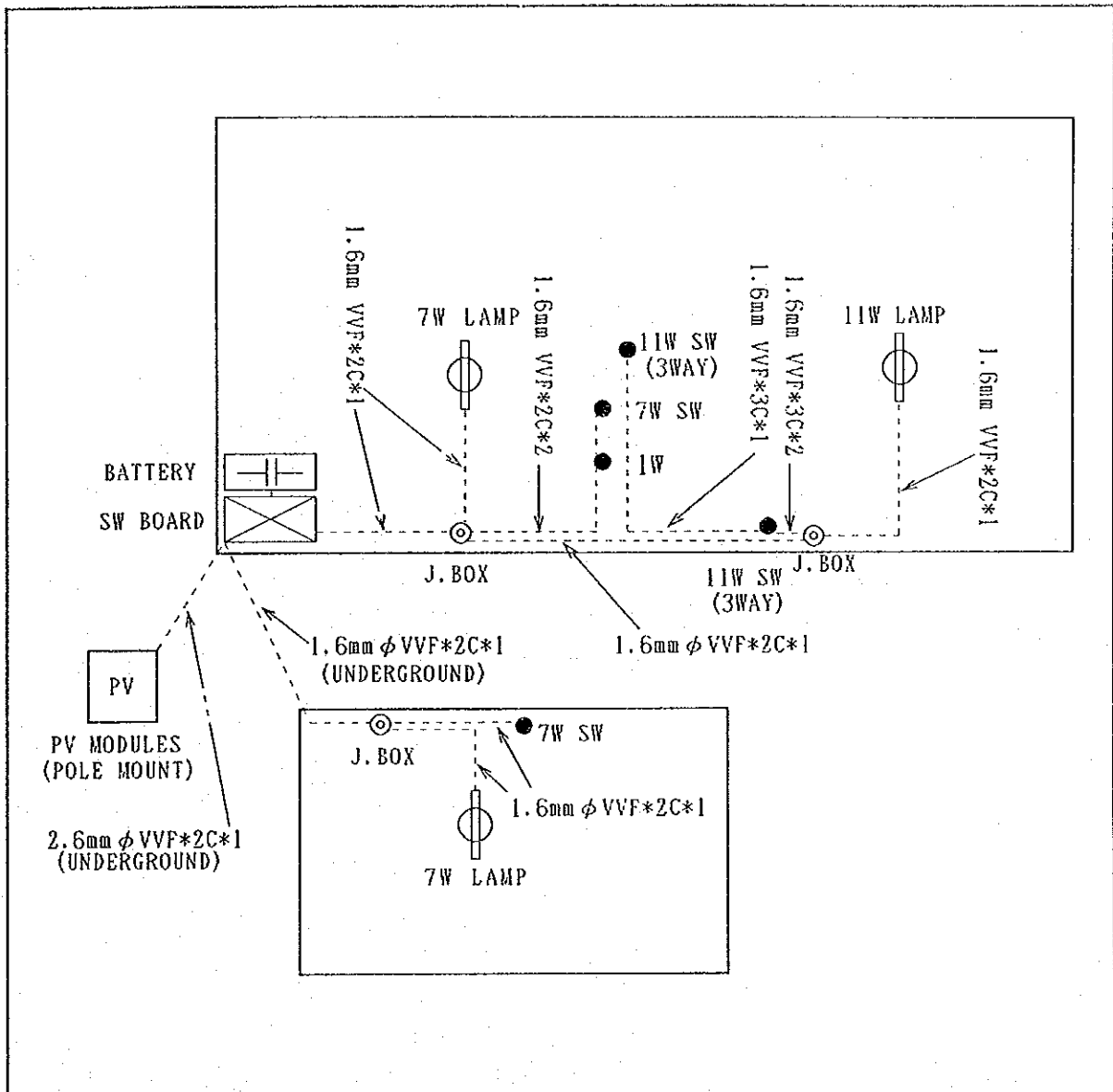

DATE	CHECKER	JUDGEMENT	DATE	CHECKER	JUDGEMENT

5. List of main equipment

No	Equipment Item	Quantity	No	Equipment Item	Quantity
1	PV Module	2 pcs	8	1W LED night light	1 ea
2	Pole Mount	1 set	9	No Fuse Braker(10(A))	1 ea
3	Charge Controller	1 ea	10	Main switch(30(A))	3 ea
4	Battery(12V-100Ah)	1 ea	11	Protection Fuse(15(A))	1 ea
5	Battery Box	1 ea	12	Junction Box	3 pcs
6	Fluorescent Lamp(11w)	1 ea	13	Switch(7(W))	2 pcs
7	Fluorescent Lamp(7w)	2 pcs	14	3Way switch(11(W))	2 pcs

File of PV system Facility for Private House

1. Name of householder : Ribati (KPC)
2. Code NO : A 3 2
3. Name of village : Abakoro
4. Drawing of PV Facility

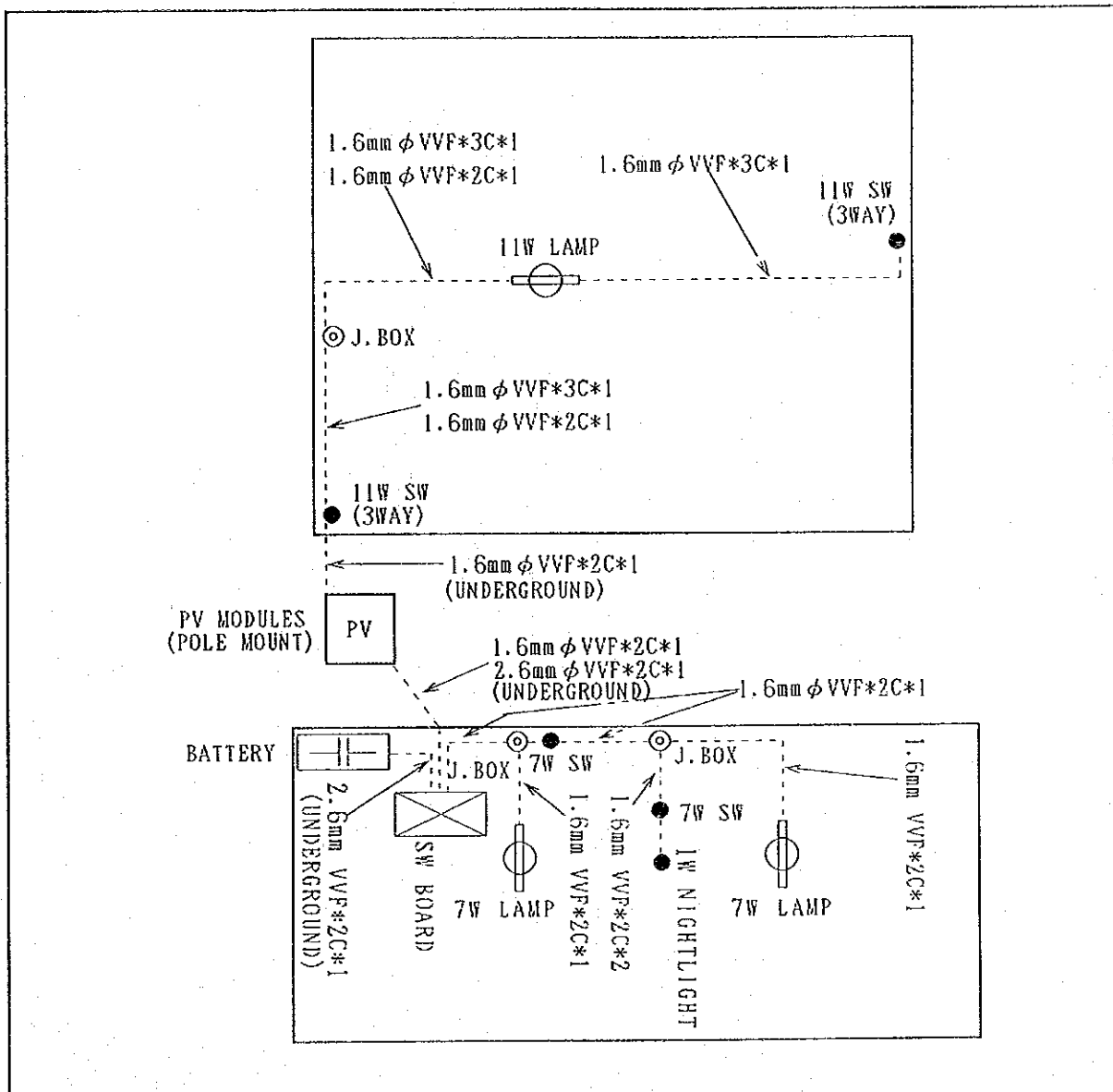

DATE	CHECKER	JUDGEMENT	DATE	CHECKER	JUDGEMENT

5. List of main equipment

No	Equipment Item	Quantity	No	Equipment Item	Quantity
1	PV Module	2 pcs	8	1W LED night light	1 ea
2	Pole Mount	1 set	9	No Fuse Braker(10(A))	1 ea
3	Charge Controller	1 ea	10	Main switch(30(A))	3 ea
4	Battery(12V-100Ah)	1 ea	11	Protection Fuse(15(A))	1 ea
5	Battery Box	1 ea	12	Junction Box	3 pcs
6	Fluorescent Lamp(11w)	1 ea	13	Switch(7(W))	2 pcs
7	Fluorescent Lamp(7w)	2 pcs	14	3Way switch(11(W))	2 pcs

File of PV system Facility for Private House

1. Name of householder : T i o t i
2. Code NO : A 3 3
3. Name of village : A b a o k o r o
4. Drawing of PV Facility

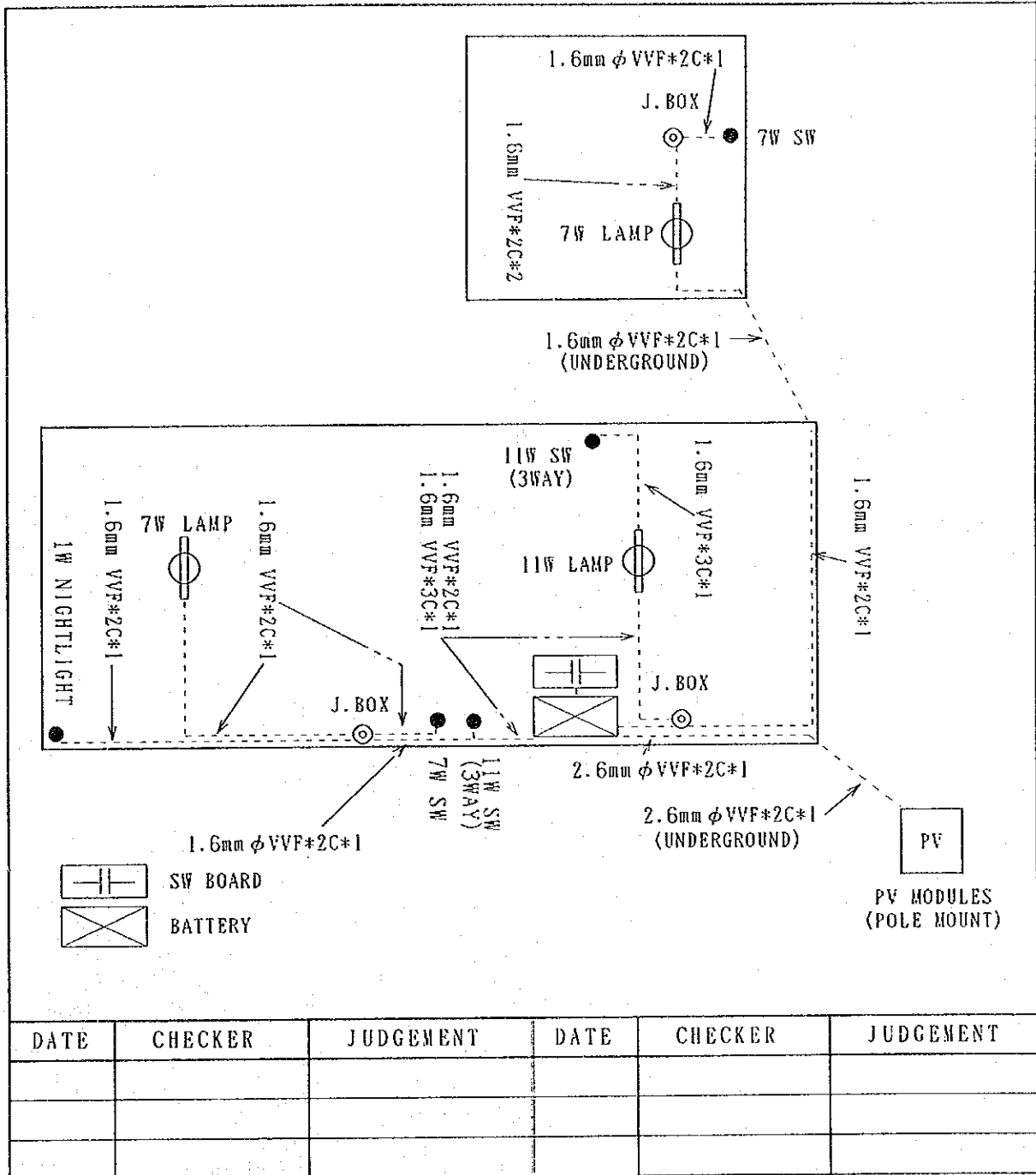

5. List of main equipment

Equipment Item	Quantity	Equipment Item	Quantity
1 PV Module	2 pcs	8 1W LED night light	1 ea
2 Pole Mount	1 set	9 No Fuse Braker(10(A))	1 ea
3 Charge Controller	1 ea	10 Main switch(30(A))	3 ea
4 Battery(12V-100Ah)	1 ea	11 Protection Fuse(15(A))	1 ea
5 Battery Box	1 ea	12 Junction Box	3 pcs
6 Fluorescent Lamp(11w)	1 ea	13 Switch(7(W))	2 pcs
7 Fluorescent Lamp(7w)	2 pcs	14 3Way switch(11(W))	2 pcs

File of PV system Facility for Private House

1. Name of householder : A b a u a
2. Code NO : A 3 5
3. Name of village : A b a o k o r o
4. Drawing of PV Facility

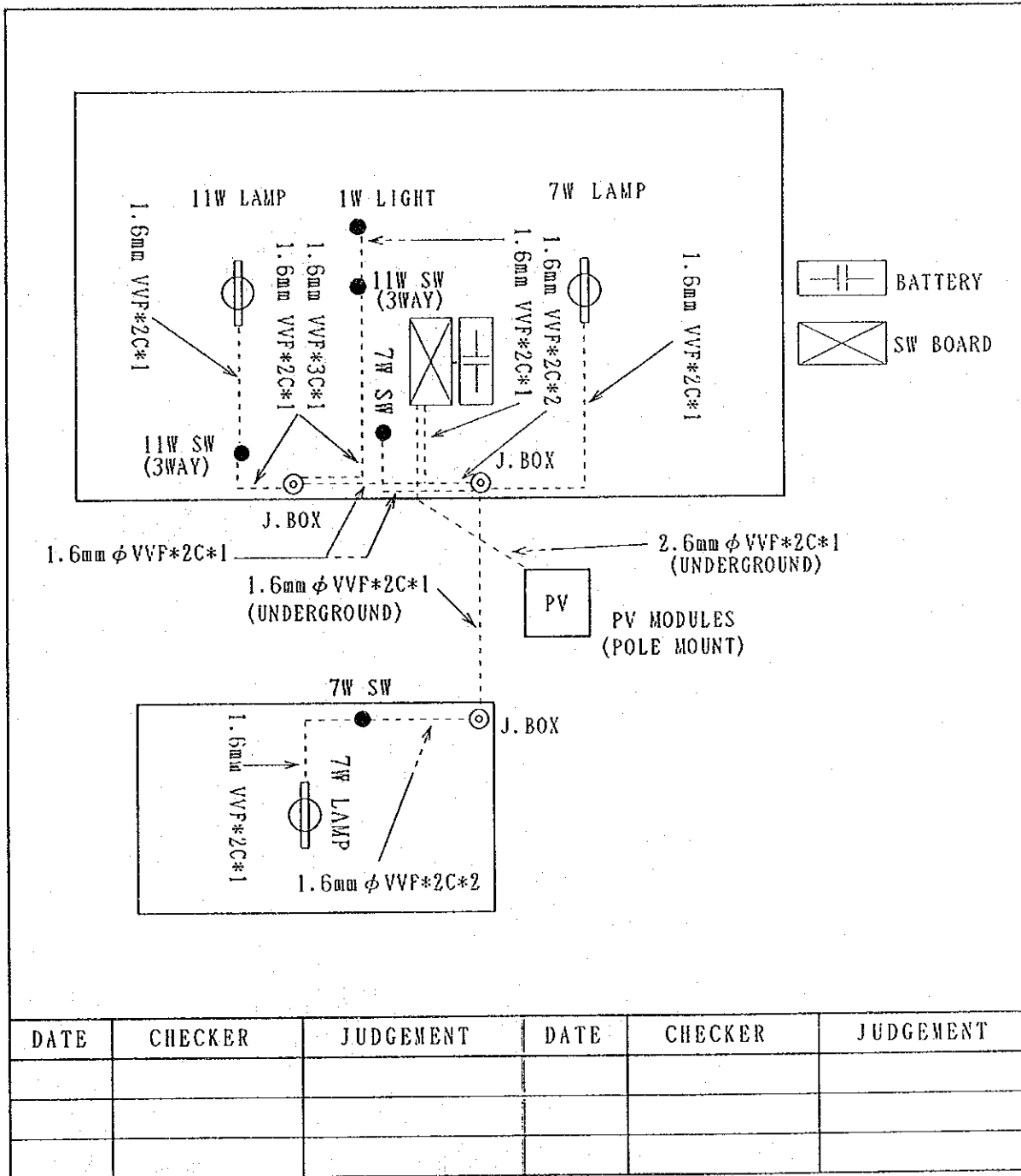

5. List of main equipment

Equipment Item	Quantity	Equipment Item	Quantity
1 PV Module	2 pcs	8 1W LED night light	1 ea
2 Pole Mount	1 set	9 No Fuse Braker(10(A))	1 ea
3 Charge Controller	1 ea	10 Main switch(30(A))	3 ea
4 Battery(12V-100Ah)	1 ea	11 Protection Fuse(15(A))	1 ea
5 Battery Box	1 ea	12 Junction Box	3 pcs
6 Fluorescent Lamp(11w)	1 ea	13 Switch(7(W))	2 pcs
7 Fluorescent Lamp(7w)	2 pcs	14 3Way switch(11(W))	2 pcs

File of PV system Facility for Private House

1. Name of householder : Danny
2. Code NO : A 3 6
3. Name of village : A b a o k o r o
4. Drawing of PV Facility

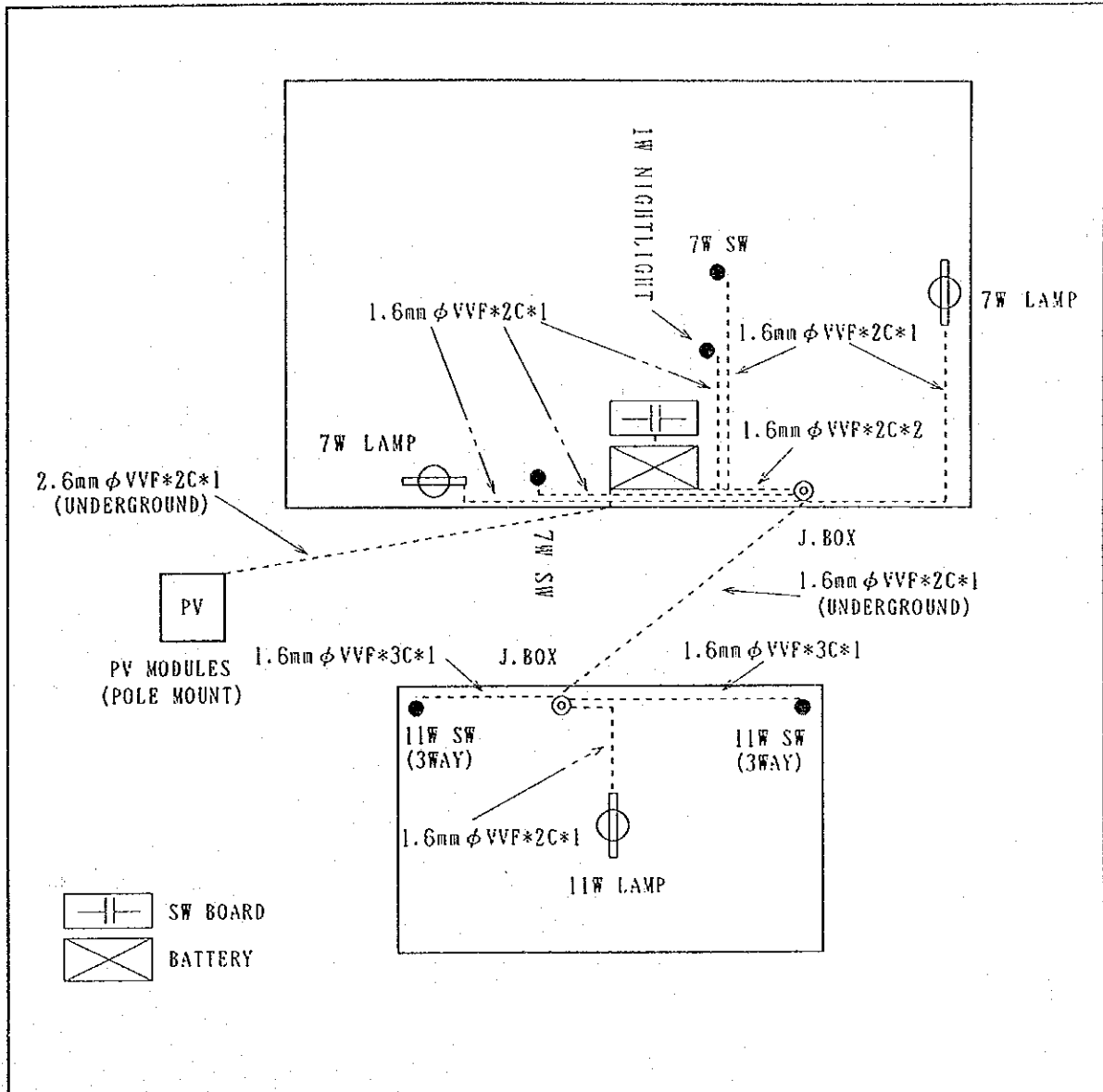

DATE	CHECKER	JUDGEMENT	DATE	CHECKER	JUDGEMENT

5. List of main equipment

	Equipment Item	Quantity		Equipment Item	Quantity
1	PV Module	2 pcs	8	1W LED night light	1 ea
2	Pole Mount	1 set	9	No Fuse Braker(10(A))	1 ea
3	Charge Controller	1 ea	10	Main switch(30(A))	3 ea
4	Battery(12V-100Ah)	1 ea	11	Protection Fuse(15(A))	1 ea
5	Battery Box	1 ea	12	Junction Box	3 pcs
6	Fluorescent Lamp(11w)	1 ea	13	Switch(7(W))	2 pcs
7	Fluorescent Lamp(7w)	2 pcs	14	3Way switch(11(W))	2 pcs

File of PV system Facility for Private House

1. Name of householder : M a t i o t a
2. Code NO : A 3 7
3. Name of village : A b a o k o r o
4. Drawing of PV Facility

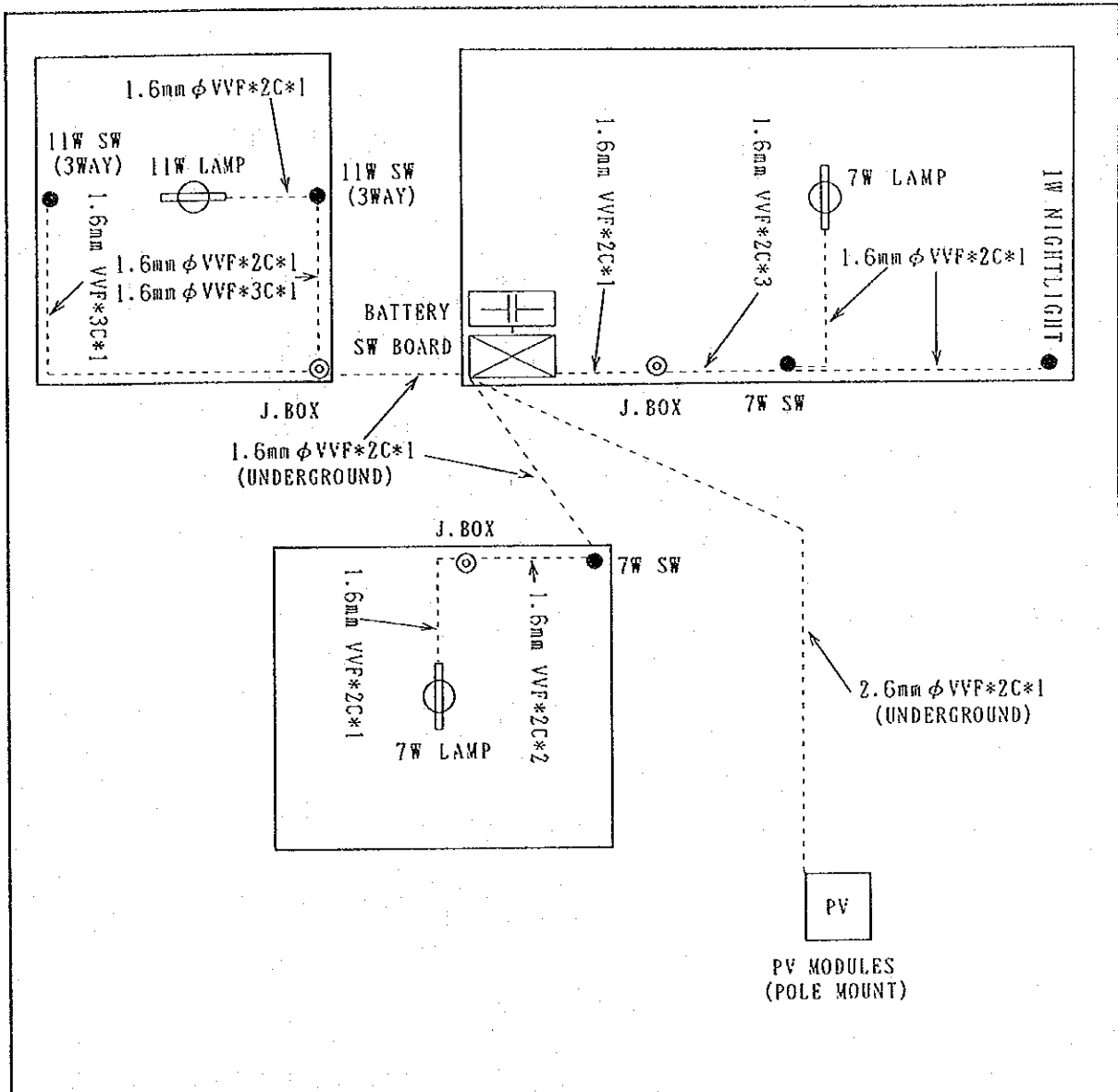

DATE	CHECKER	JUDGEMENT	DATE	CHECKER	JUDGEMENT

5. List of main equipment

No	Equipment Item	Quantity	No	Equipment Item	Quantity
1	PV Module	2 pcs	8	1W LED night light	1 ea
2	Pole Mount	1 set	9	No Fuse Braker(10(A))	1 ea
3	Charge Controller	1 ea	10	Main switch(30(A))	3 ea
4	Battery(12V-100Ah)	1 ea	11	Protection Fuse(15(A))	1 ea
5	Battery Box	1 ea	12	Junction Box	3 pcs
6	Fluorescent Lamp(11w)	1 ea	13	Switch(7(W))	2 pcs
7	Fluorescent Lamp(7w)	2 pcs	14	3Way switch(11(W))	2 pcs

File of PV system Facility for Private House

1. Name of householder : A m b o u
2. Code NO :
3. Name of village : A b a o k o r o
4. Drawing of PV Facility

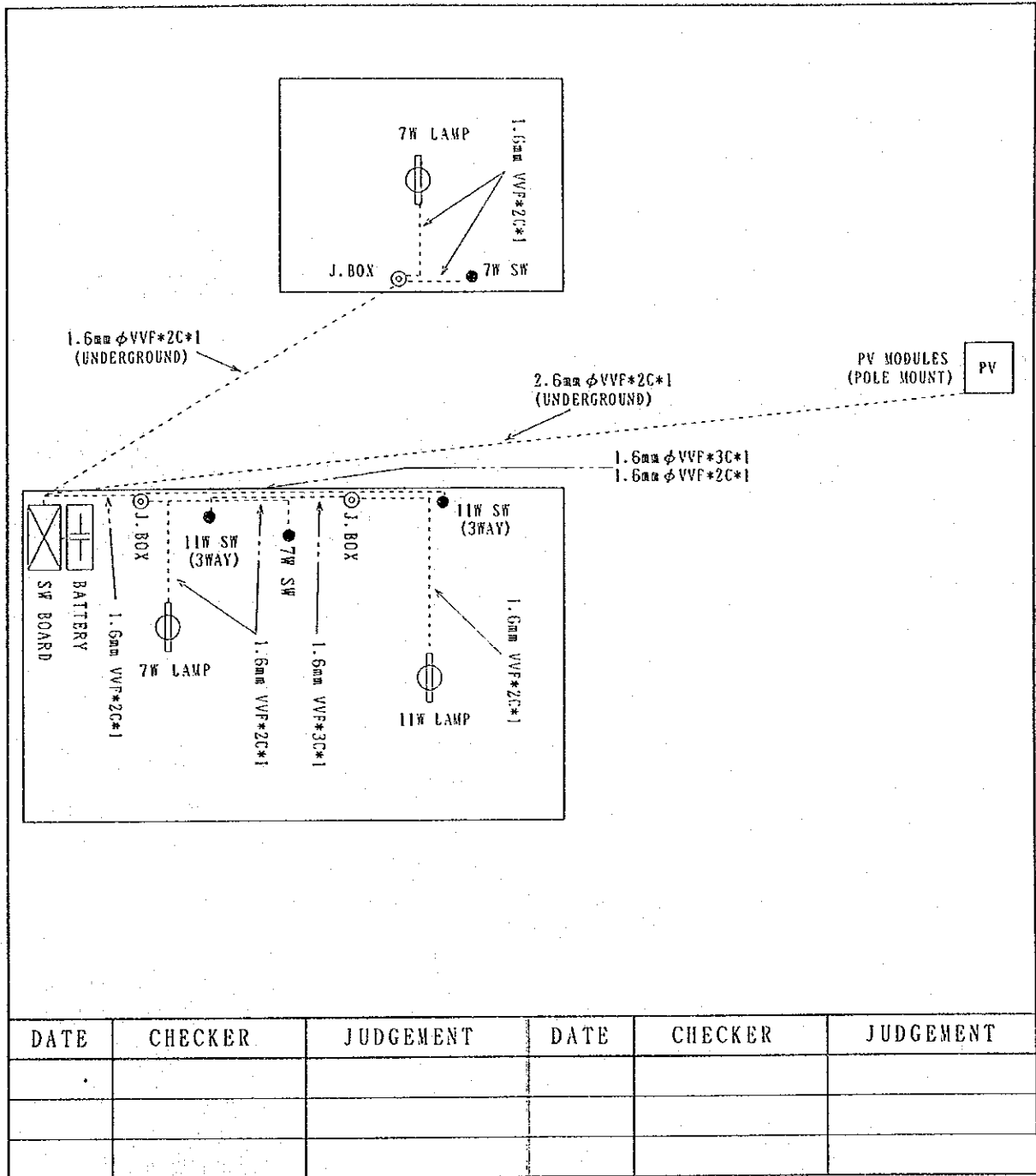

DATE	CHECKER	JUDGEMENT	DATE	CHECKER	JUDGEMENT

5. List of main equipment

	Equipment Item	Quantity		Equipment Item	Quantity
1	PV Module	2 pcs	8	1W LED night light	1 ea
2	Pole Mount	1 set	9	No Fuse Braker(10(A))	1 ea
3	Charge Controller	1 ea	10	Main switch(30(A))	3 ea
4	Battery(12V-100Ah)	1 ea	11	Protection Fuse(15(A))	1 ea
5	Battery Box	1 ea	12	Junction Box	3 pcs
6	Fluorescent Lamp(11w)	1 ea	13	Switch(7(W))	2 pcs
7	Fluorescent Lamp(7w)	2 pcs	14	3Way switch(11(W))	2 pcs

File of PV system Facility for Private House

1. Name of householder : B a u r o
2. Code NO :
3. Name of village : A b a o k o r o
4. Drawing of PV Facility

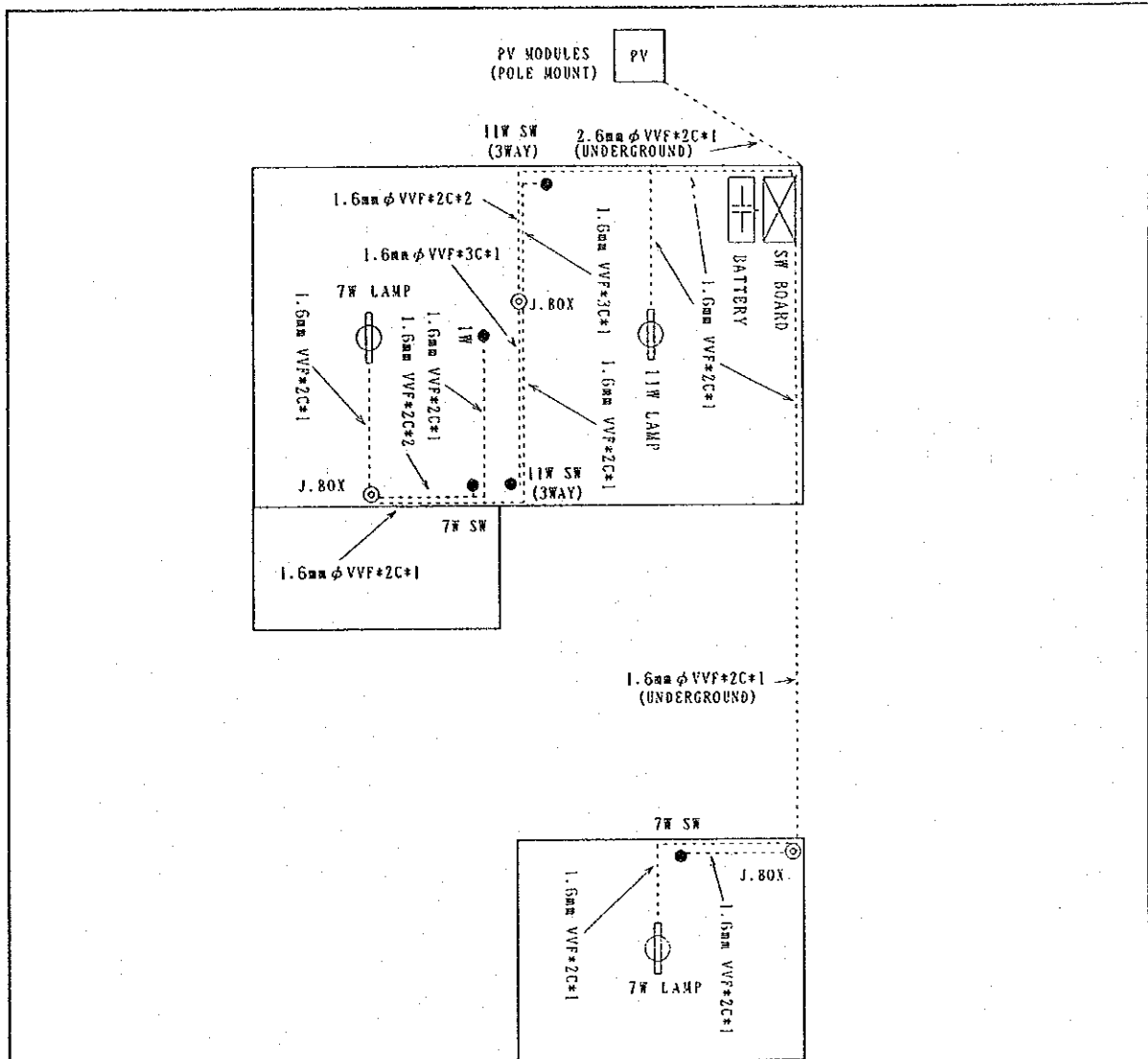

*System Evaluation facility

DATE	CHECKER	JUDGEMENT	DATE	CHECKER	JUDGEMENT

5. List of main equipment

No	Equipment Item	Quantity	No	Equipment Item	Quantity
1	PV Module	2 pcs	8	1W LED night light	1 ea
2	Pole Mount	1 set	9	No Fuse Braker(10(A))	1 ea
3	Charge Controller	1 ea	10	Main switch(30(A))	3 ea
4	Battery(12V-100Ah)	1 ea	11	Protection Fuse(15(A))	1 ea
5	Battery Box	1 ea	12	Junction Box	3 pcs
6	Fluorescent Lamp(11w)	1 ea	13	Switch(7(W))	2 pcs
7	Fluorescent Lamp(7w)	2 pcs	14	3Way switch(11(W))	2 pcs

File of PV system Facility for Private House

1. Name of householder : Kaobunang
2. Code NO :
3. Name of village : Abackoro
4. Drawing of PV Facility

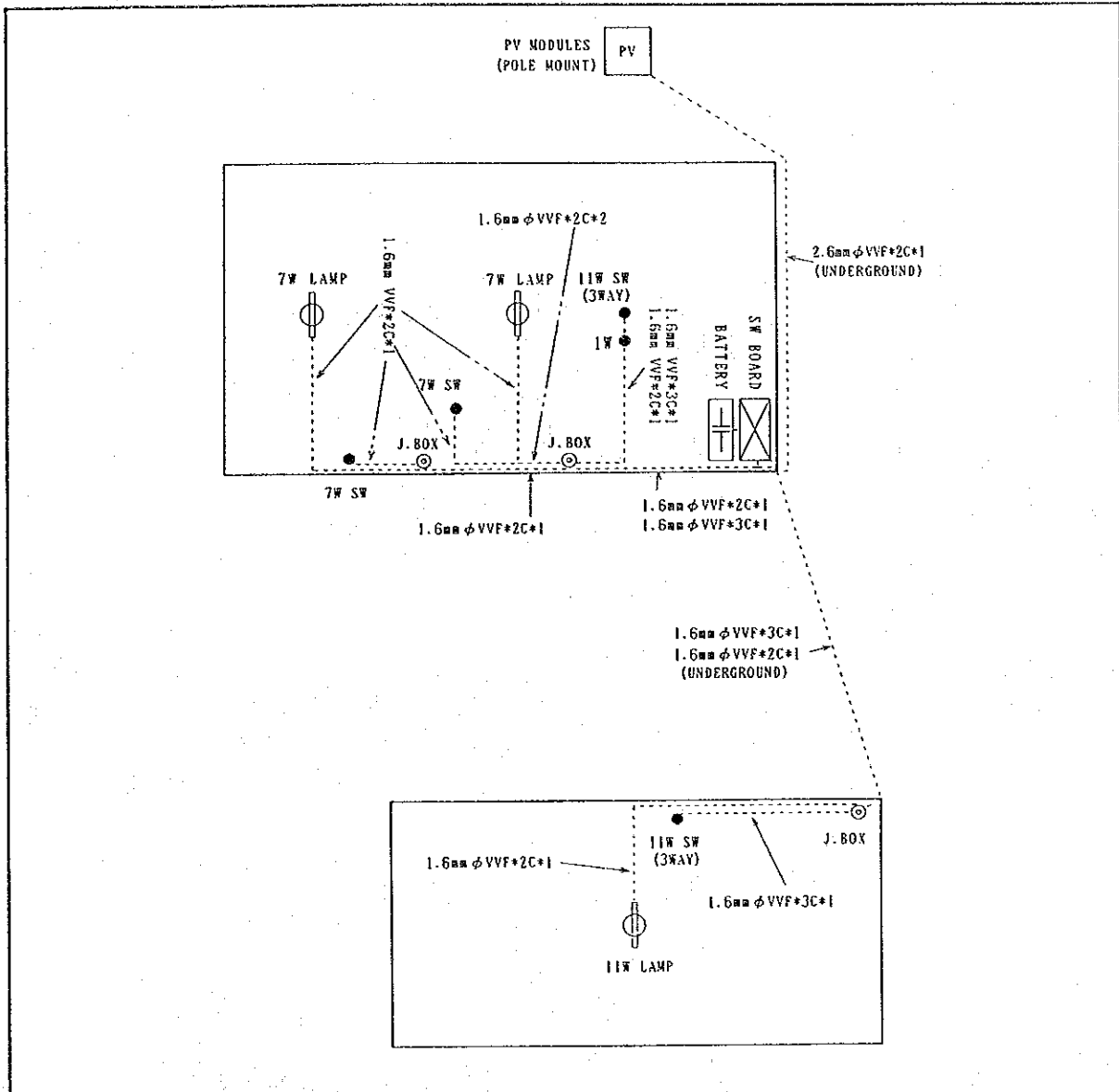

DATE	CHECKER	JUDGEMENT	DATE	CHECKER	JUDGEMENT

5. List of main equipment

No	Equipment Item	Quantity	No	Equipment Item	Quantity
1	PV Module	2 pcs	8	1W LED night light	1 ea
2	Pole Mount	1 set	9	No Fuse Braker(10(A))	1 ea
3	Charge Controller	1 ea	10	Main switch(30(A))	3 ea
4	Battery(12V-100Ah)	1 ea	11	Protection Fuse(15(A))	1 ea
5	Battery Box	1 ea	12	Junction Box	3 pcs
6	Fluorescent Lamp(11w)	1 ea	13	Switch(7(W))	2 pcs
7	Fluorescent Lamp(7w)	2 pcs	14	3Way switch(11(W))	2 pcs

File of PV system Facility for Private House

1. Name of householder : T e k a t a u
2. Code NO :
3. Name of village : A b a o k o r o
4. Drawing of PV Facility

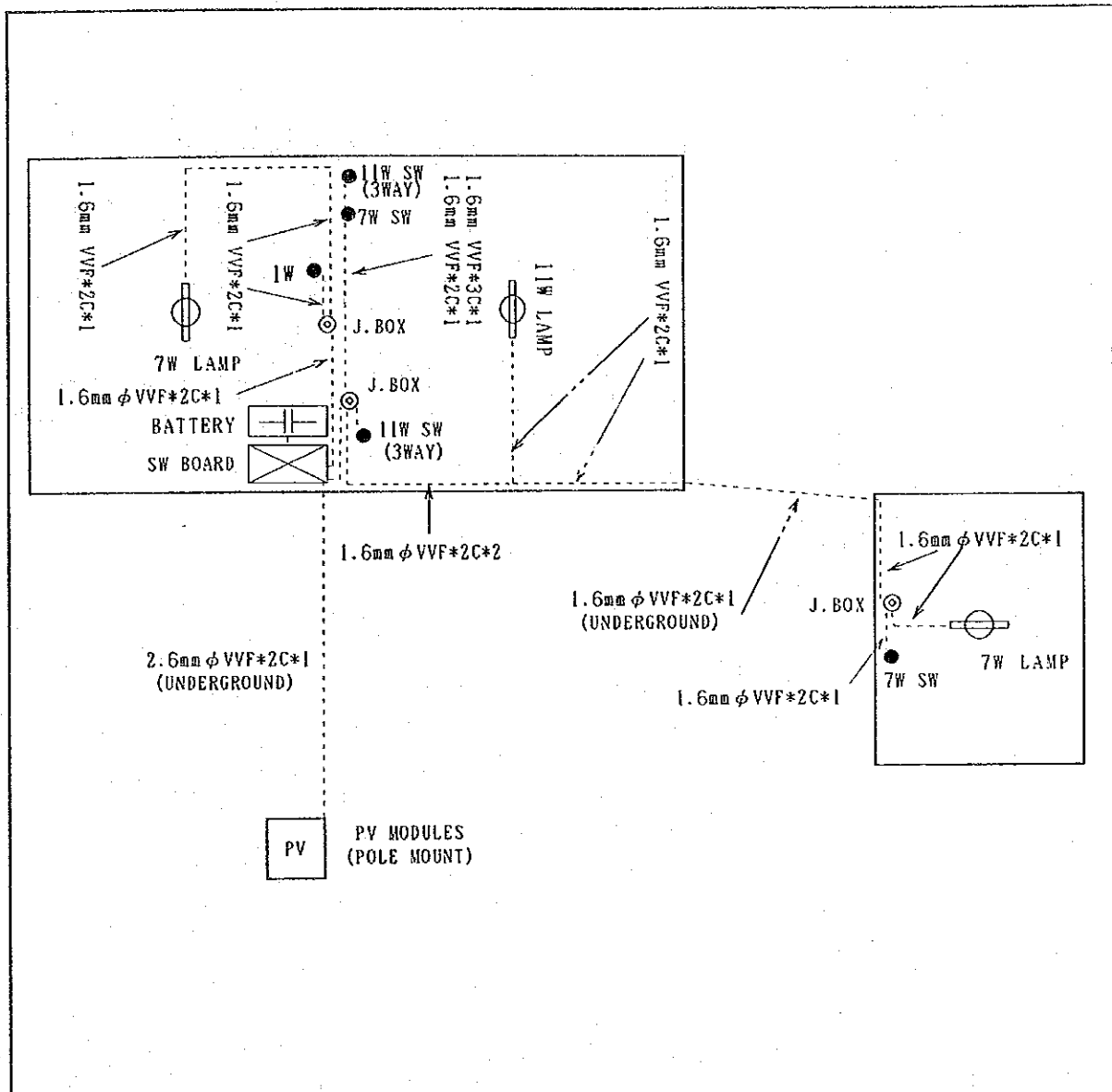

DATE	CHECKER	JUDGEMENT	DATE	CHECKER	JUDGEMENT

5. List of main equipment

	Equipment Item	Quantity		Equipment Item	Quantity
1	PV Module	2 pcs	8	1W LED night light	1 ea
2	Pole Mount	1 set	9	No Fuse Braker(10(A))	1 ea
3	Charge Controller	1 ea	10	Main switch(30(A))	3 ca
4	Battery(12V-100Ah)	1 ea	11	Protection Fuse(15(A))	1 ea
5	Battery Box	1 ea	12	Junction Box	3 pcs
6	Fluorescent Lamp(11w)	1 ea	13	Switch(7(W))	2 pcs
7	Fluorescent Lamp(7w)	2 pcs	14	3Way switch(11(W))	2 pcs

File of PV system Facility for Private House

1. Name of householder : T e k e r a o i
2. Code NO : :
3. Name of village : A b a o k o r o
4. Drawing of PV Facility

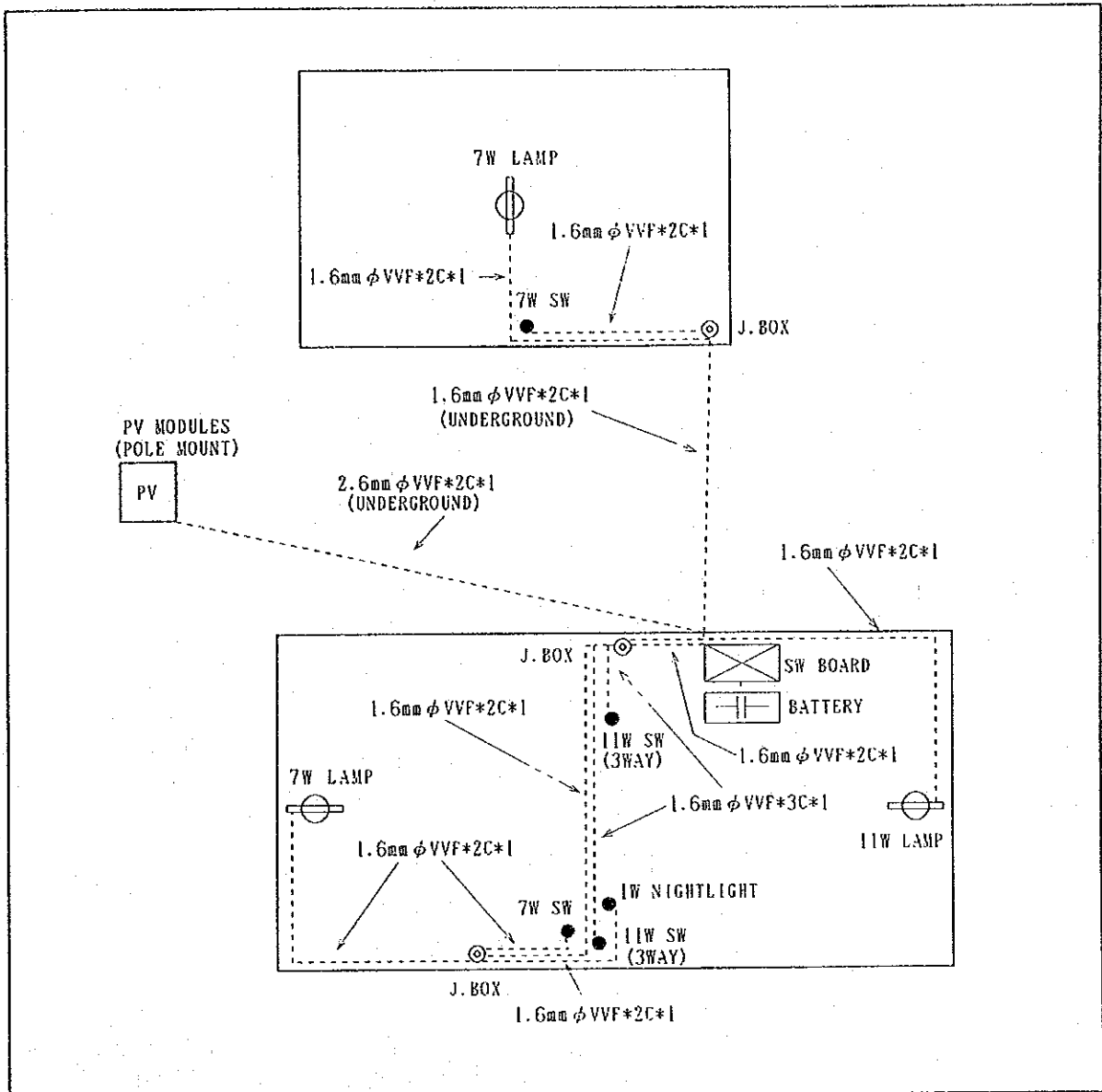

DATE	CHECKER	JUDGEMENT	DATE	CHECKER	JUDGEMENT

5. List of main equipment

No.	Equipment Item	Quantity	No.	Equipment Item	Quantity
1	PV Module	2 pcs	8	1W LED night light	1 ea
2	Pole Mount	1 set	9	No Fuse Braker(10(A))	1 ea
3	Charge Controller	1 ea	10	Main switch(30(A))	3 ea
4	Battery(12V-100Ah)	1 ea	11	Protection Fuse(15(A))	1 ea
5	Battery Box	1 ea	12	Junction Box	3 pcs
6	Fluorescent Lamp(11w)	1 ea	13	Switch(7(W))	2 pcs
7	Fluorescent Lamp(7w)	2 pcs	14	3Way switch(11(W))	2 pcs

File of PV system Facility for Private House

1. Name of householder : T e n a g i m a u
2. Code NO :
3. Name of village : A b a o k o r o
4. Drawing of PV Facility

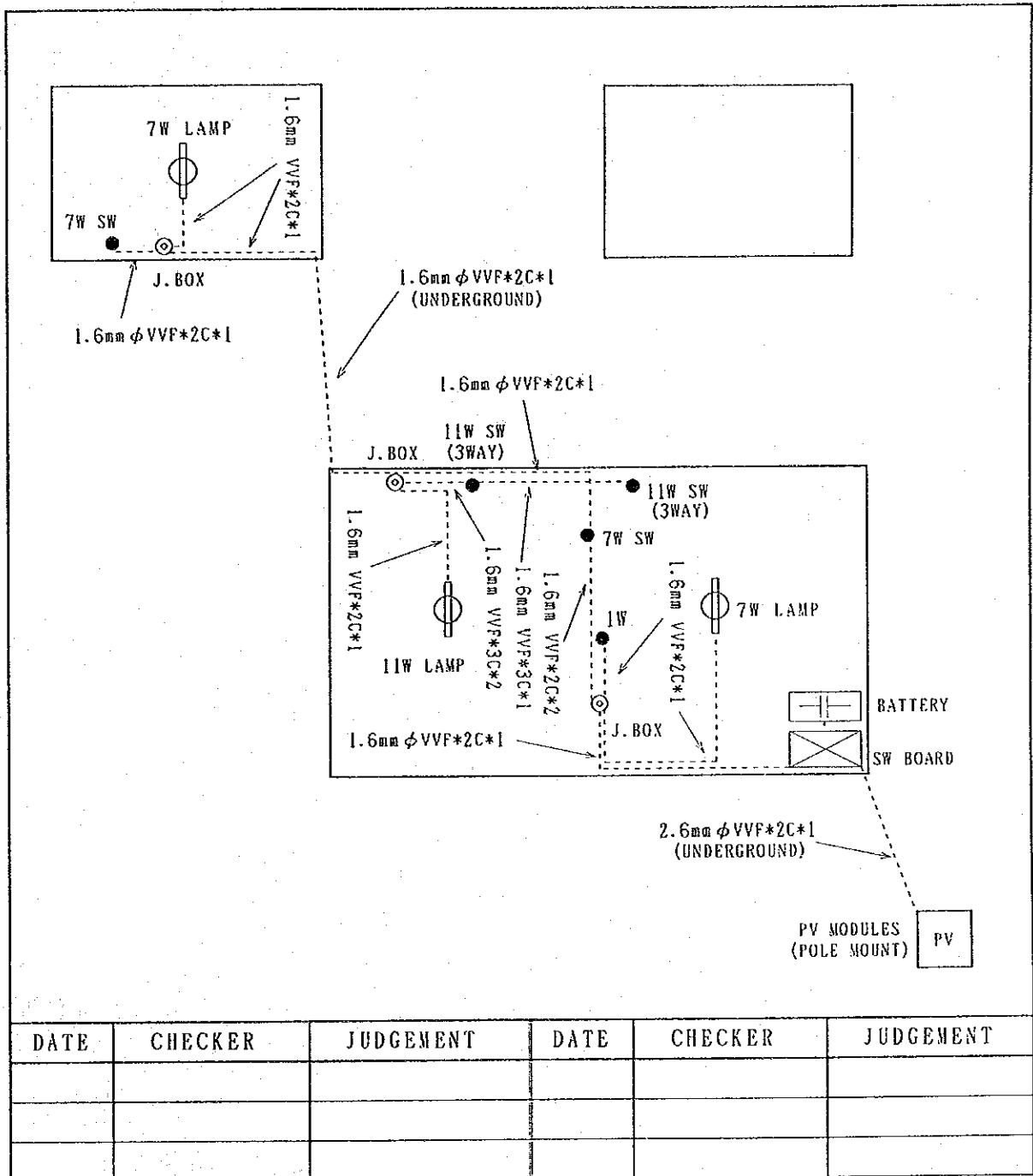

5. List of main equipment

Equipment Item	Quantity	Equipment Item	Quantity
1 PV Module	2 pcs	8 1W LED night light	1 ea
2 Pole Mount	1 set	9 No Fuse Braker(10(A))	1 ea
3 Charge Controller	1 ea	10 Main switch(30(A))	3 ea
4 Battery(12V-100Ah)	1 ea	11 Protection Fuse(15(A))	1 ea
5 Battery Box	1 ea	12 Junction Box	3 pcs
6 Fluorescent Lamp(11w)	1 ea	13 Switch(7(W))	2 pcs
7 Fluorescent Lamp(7w)	2 pcs	14 3Way switch(11(W))	2 pcs

File of PV system Facility for Private House

1. Name of householder : T e t a k e
2. Code NO
3. Name of village : A b a o k o r o
4. Drawing of PV Facility

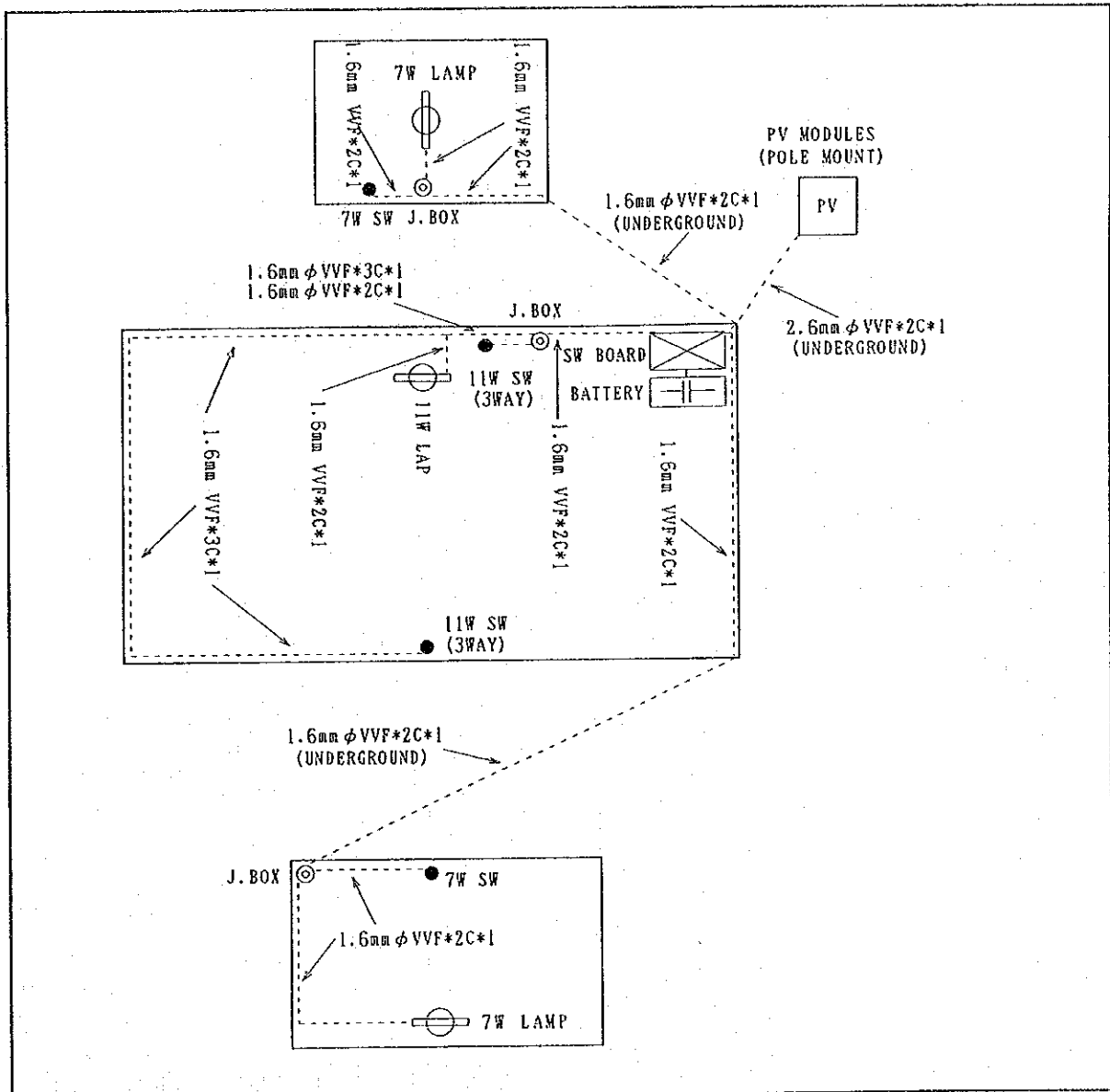

DATE	CHECKER	JUDGEMENT	DATE	CHECKER	JUDGEMENT

5. List of main equipment

	Equipment Item	Quantity		Equipment Item	Quantity
1	PV Module	2 pcs	8	1W LED night light	1 ea
2	Pole Mount	1 set	9	No Fuse Braker(10(A))	1 ea
3	Charge Controller	1 ea	10	Main switch(30(A))	3 ea
4	Battery(12V-100Ah)	1 ea	11	Protection Fuse(15(A))	1 ea
5	Battery Box	1 ea	12	Junction Box	3 pcs
6	Fluorescent Lamp(11w)	1 ea	13	Switch(7(W))	2 pcs
7	Fluorescent Lamp(7w)	2 pcs	14	3Way switch(11(W))	2 pcs

File of PV system Facility for Private House

1. Name of householder : B i i t a
2. Code NO :
3. Name of village : A b a o k o r o
4. Drawing of PV Facility

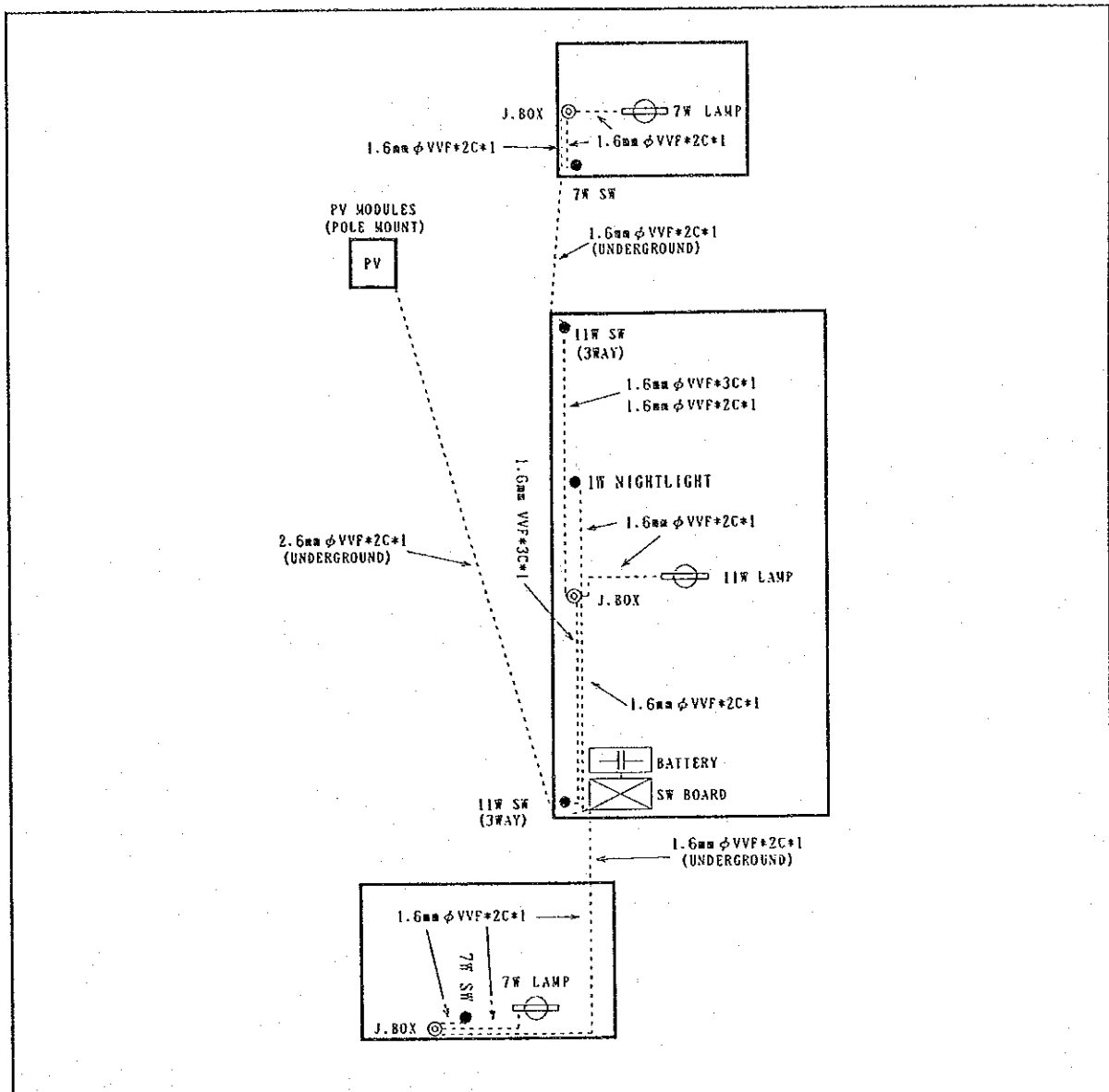

5. List of main equipment

No.	Equipment Item	Quantity	No.	Equipment Item	Quantity
1	PV Module	2 pcs	8	1W LED night light	1 ea
2	Pole Mount	1 set	9	No Fuse Braker(10(A))	1 ea
3	Charge Controller	1 ea	10	Main switch(30(A))	3 ea
4	Battery(12V-100Ah)	1 ea	11	Protection Fuse(15(A))	1 ea
5	Battery Box	1 ea	12	Junction Box	3 pcs
6	Fluorescent Lamp(11w)	1 ea	13	Switch(7(W))	2 pcs
7	Fluorescent Lamp(7w)	2 pcs	14	3Way switch(11(W))	2 pcs

File of PV system Facility for Private House

1. Name of householder : B e i a R u a i a
2. Code NO : M 1
3. Name of village : M a r e n a n u k a
4. Drawing of PV Facility

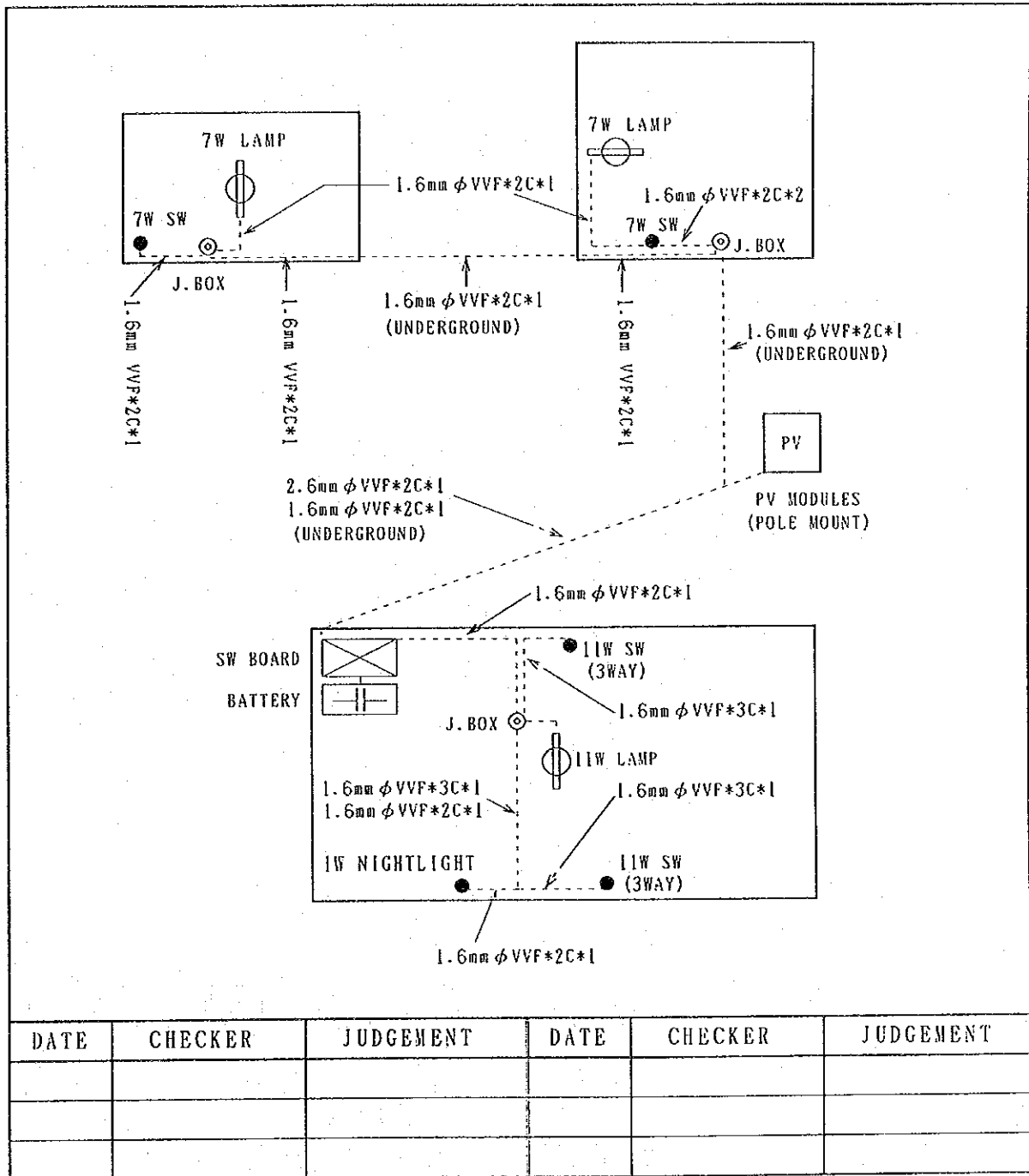

5. List of main equipment

Equipment Item	Quantity	Equipment Item	Quantity
1 PV Module	2 pcs	8 1W LED night light	1 ea
2 Pole Mount	1 set	9 No Fuse Braker(10(A))	1 ea
3 Charge Controller	1 ea	10 Main switch(30(A))	3 ea
4 Battery(12V-100Ah)	1 ea	11 Protection Fuse(15(A))	1 ea
5 Battery Box	1 ea	12 Junction Box	3 pcs
6 Fluorescent Lamp(11w)	1 ea	13 Switch(7(W))	2 pcs
7 Fluorescent Lamp(7w)	2 pcs	14 3Way switch(11(W))	2 pcs

File of PV system Facility for Private House

1. Name of householder : M o a u e a
2. Code NO : M 4
3. Name of village : M a r e n a n u k a
4. Drawing of PV Facility

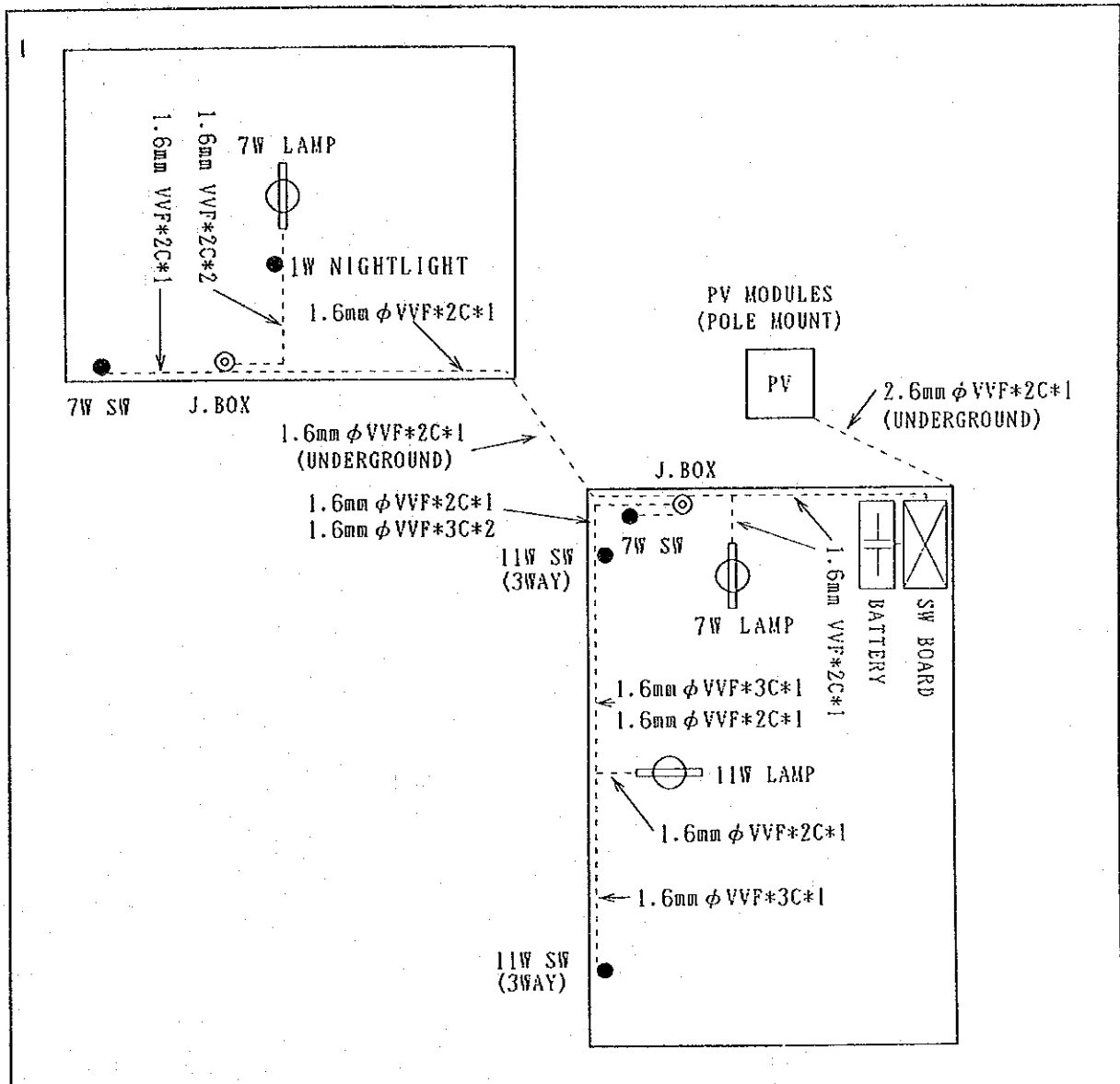

DATE	CHECKER	JUDGEMENT	DATE	CHECKER	JUDGEMENT

5. List of main equipment

	Equipment Item	Quantity		Equipment Item	Quantity
1	PV Module	2 pcs	8	1W LED night light	1 ea
2	Pole Mount	1 set	9	No Fuse Braker(10(A))	1 ea
3	Charge Controller	1 ea	10	Main switch(30(A))	3 ea
4	Battery(12V-100Ah)	1 ea	11	Protection Fuse(15(A))	1 ea
5	Battery Box	1 ea	12	Junction Box	3 pcs
6	Fluorescent Lamp(11w)	1 ea	13	Switch(7(W))	2 pcs
7	Fluorescent Lamp(7w)	2 pcs	14	3way switch(11(W))	2 pcs

File of PV system Facility for Private House

1. Name of householder : T e n T a t e r a k a
2. Code NO : M 7
3. Name of village : M a r e n a n u k a
4. Drawing of PV Facility

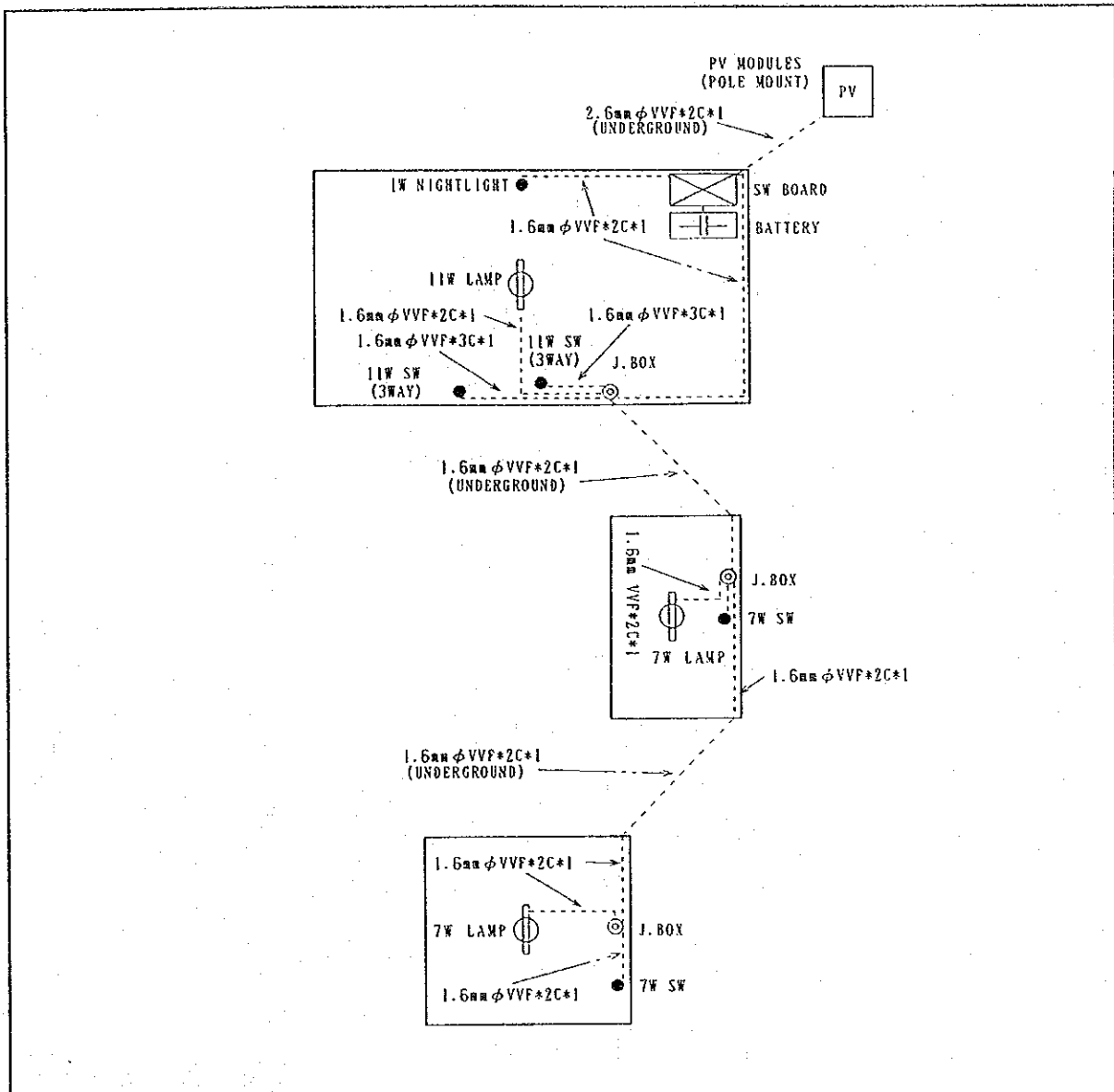

DATE	CHECKER	JUDGEMENT	DATE	CHECKER	JUDGEMENT

5. List of main equipment

	Equipment Item	Quantity		Equipment Item	Quantity
1	PV Module	2 pcs	8	1W LED night light	1 ea
2	Pole Mount	1 set	9	No Fuse Braker(10(A))	1 ea
3	Charge Controller	1 ea	10	Main switch(30(A))	3 ea
4	Battery(12V-100Ah)	1 ea	11	Protection Fuse(15(A))	1 ea
5	Battery Box	1 ea	12	Junction Box	3 pcs
6	Fluorescent Lamp(11w)	1 ea	13	Switch(7(W))	2 pcs
7	Fluorescent Lamp(7w)	2 pcs	14	3Way switch(11(W))	2 pcs

File of PV system Facility for Private House

1. Name of householder : R a b a n g a k i M a t i m a r a
2. Code NO : T 6
3. Name of village : T a b o n i b a r a
4. Drawing of PV Facility

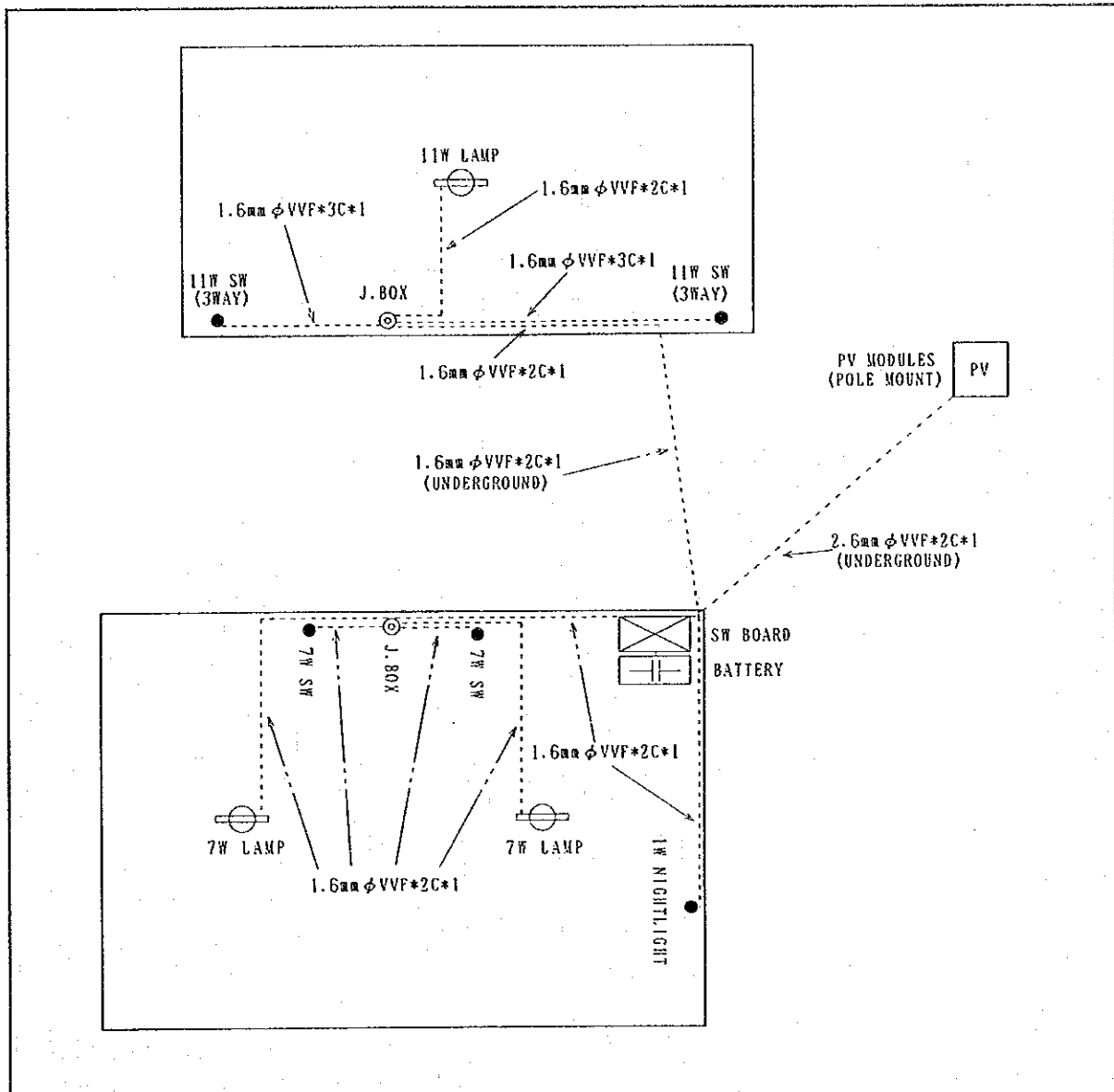

DATE	CHECKER	JUDGEMENT	DATE	CHECKER	JUDGEMENT

5. List of main equipment

No	Equipment Item	Quantity	No	Equipment Item	Quantity
1	PV Module	2 pcs	8	1W LED night light	1 ea
2	Pole Mount	1 set	9	No Fuse Braker(10(A))	1 ea
3	Charge Controller	1 ea	10	Main switch(30(A))	3 ea
4	Battery(12V-100Ah)	1 ea	11	Protection Fuse(15(A))	1 ea
5	Battery Box	1 ea	12	Junction Box	3 pcs
6	Fluorescent Lamp(11w)	1 ea	13	Switch(7(W))	2 pcs
7	Fluorescent Lamp(7w)	2 pcs	14	3Way switch(11(W))	2 pcs

File of PV system Facility for Private House

1. Name of householder : T o a n i T a k a i o
2. Code NO : T 1 8
3. Name of village : T a b o n i b a r a
4. Drawing of PV Facility

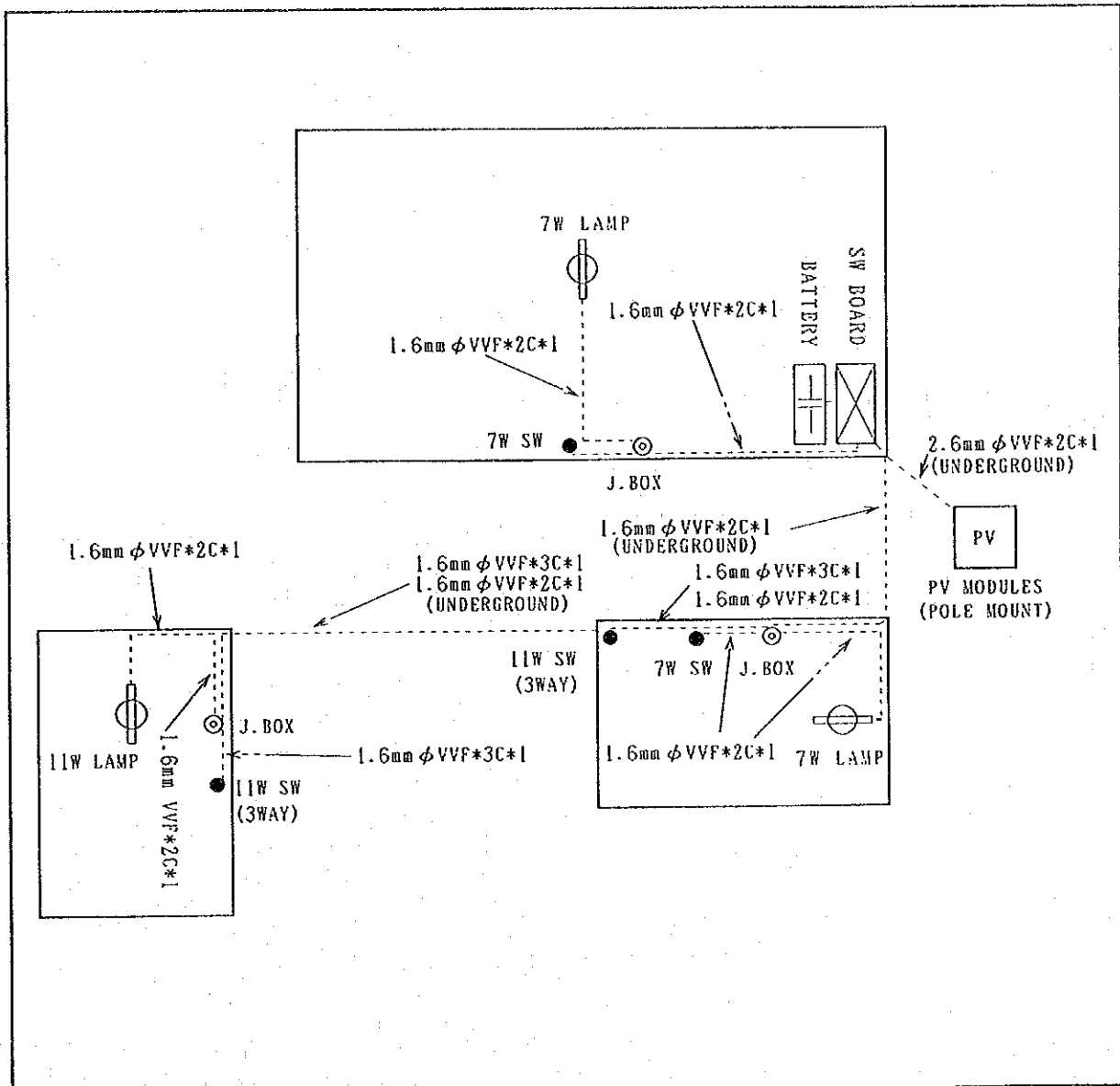

DATE	CHECKER	JUDGEMENT	DATE	CHECKER	JUDGEMENT

5. List of main equipment

No.	Equipment Item	Quantity	No.	Equipment Item	Quantity
1	PV Module	2 pcs	8	1W LED night light	1 ea
2	Pole Mount	1 set	9	No Fuse Braker(10(A))	1 ea
3	Charge Controller	1 ea	10	Main switch(30(A))	3 ea
4	Battery(12V-100Ah)	1 ea	11	Protection Fuse(15(A))	1 ea
5	Battery Box	1 ea	12	Junction Box	3 pcs
6	Fluorescent Lamp(11w)	1 ea	13	Switch(7(W))	2 pcs
7	Fluorescent Lamp(7w)	2 pcs	14	3Way switch(11(W))	2 pcs

File of PV system Facility for Private House

1. Name of householder : Teaoti Ngoia
2. Code NO : T 2 3
3. Name of village : Tabonibara
4. Drawing of PV Facility

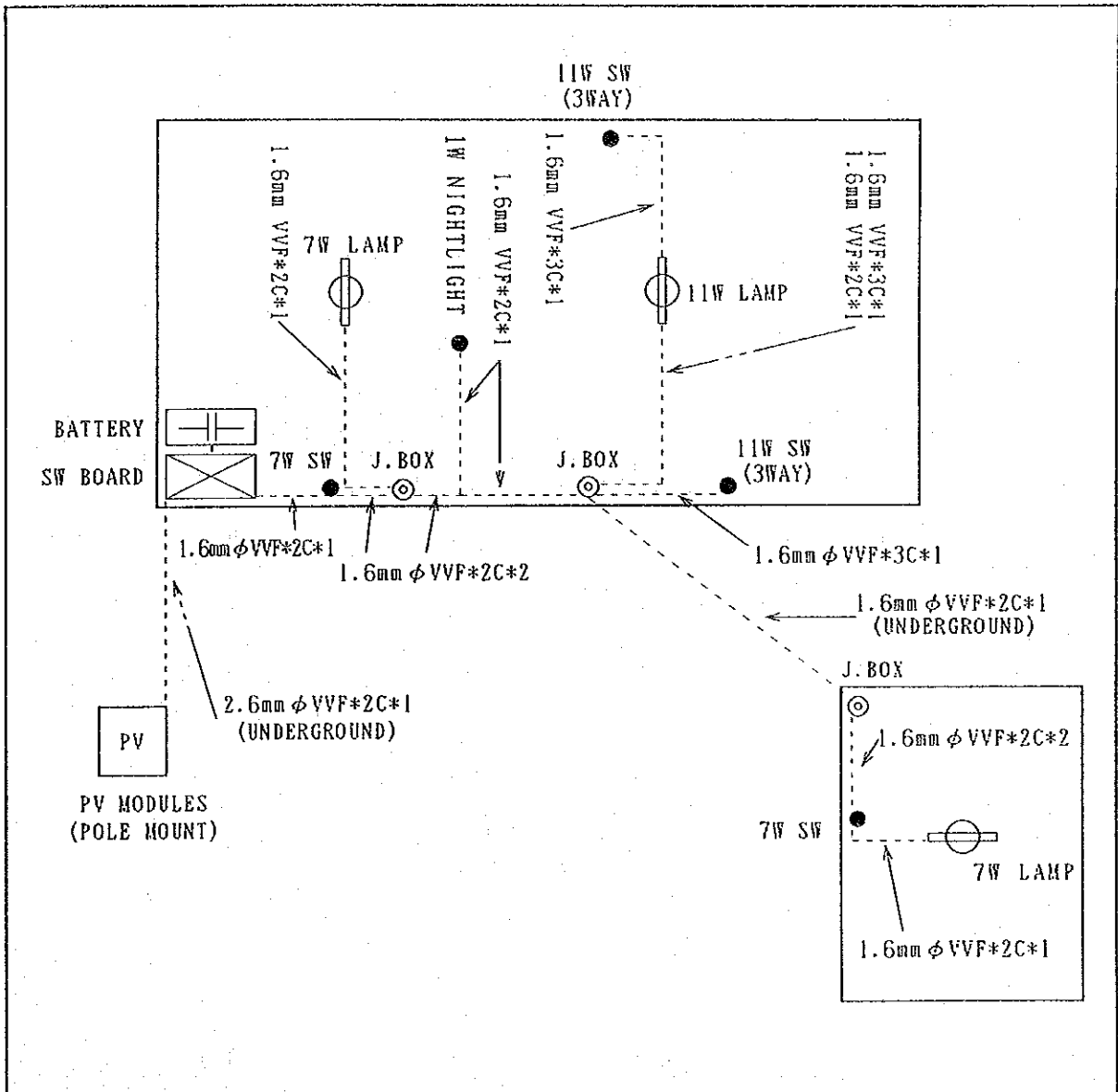

DATE	CHECKER	JUDGEMENT	DATE	CHECKER	JUDGEMENT

5. List of main equipment

No	Equipment Item	Quantity	No	Equipment Item	Quantity
1	PV Module	2 pcs	8	1W LED night light	1 ea
2	Pole Mount	1 set	9	No Fuse Braker(10(A))	1 ea
3	Charge Controller	1 ea	10	Main switch(30(A))	3 ea
4	Battery(12V-100Ah)	1 ea	11	Protection Fuse(15(A))	1 ea
5	Battery Box	1 ea	12	Junction Box	3 pcs
6	Fluorescent Lamp(11w)	1 ea	13	Switch(7(W))	2 pcs
7	Fluorescent Lamp(7w)	2 pcs	14	3Way switch(11(W))	2 pcs

File of PV system Facility for Private House

1. Name of householder : M a e u c a
2. Code NO :
3. Name of village : T a b o n i b a r a
4. Drawing of PV Facility

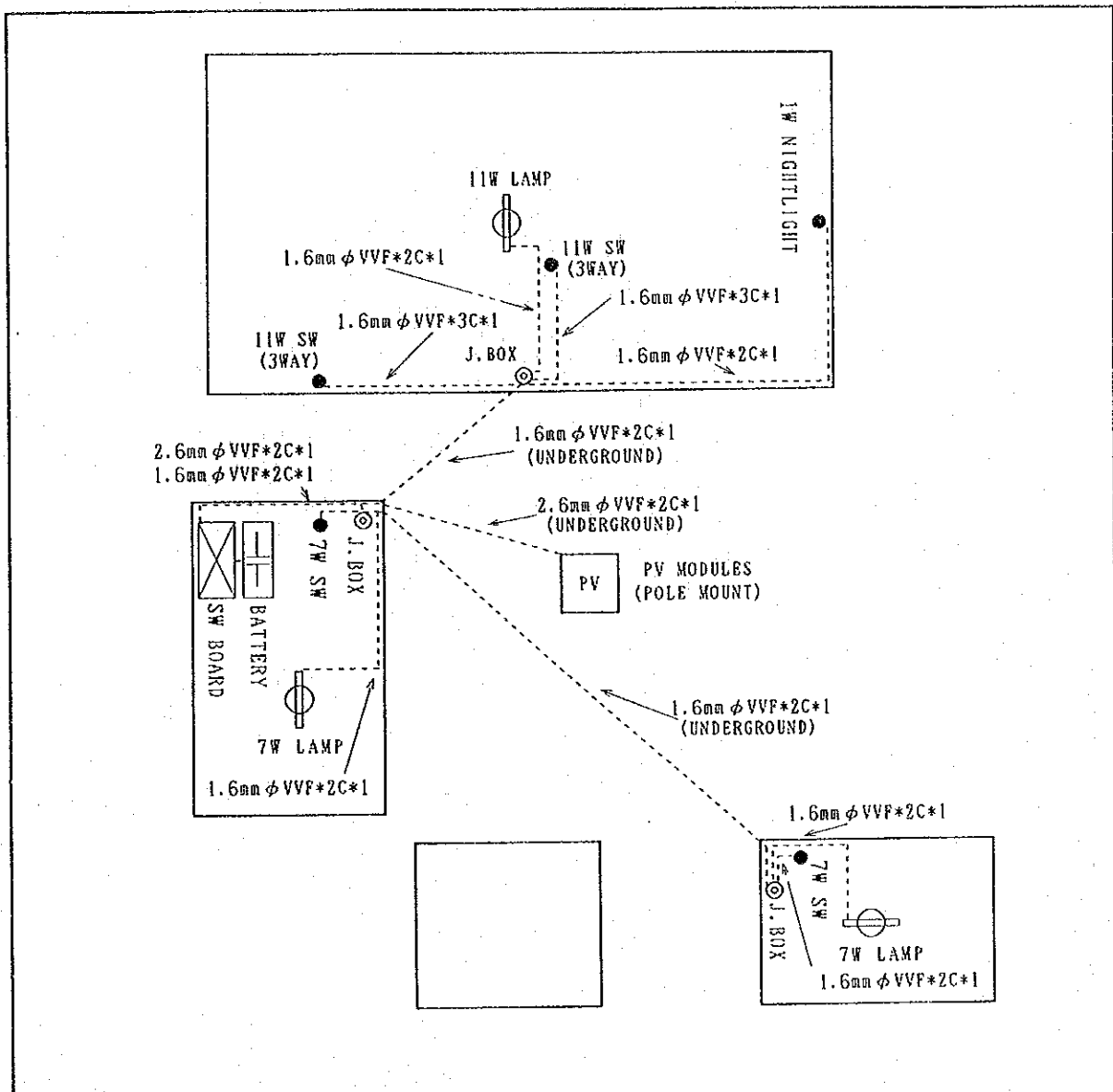

DATE	CHECKER	JUDGEMENT	DATE	CHECKER	JUDGEMENT

5. List of main equipment

Equipment Item	Quantity	Equipment Item	Quantity
1 PV Module	2 pcs	8 1W LED night light	1 ea
2 Pole Mount	1 set	9 No Fuse Braker(10(A))	1 ea
3 Charge Controller	1 ea	10 Main switch(30(A))	3 ea
4 Battery(12V-100Ah)	1 ea	11 Protection Fuse(15(A))	1 ea
5 Battery Box	1 ea	12 Junction Box	3 pcs
6 Fluorescent Lamp(11w)	1 ea	13 Switch(7(W))	2 pcs
7 Fluorescent Lamp(7w)	2 pcs	14 3Way switch(11(W))	2 pcs

File of PV system Facility for Private House

1. Name of householder : T a b e i a
2. Code NO :
3. Name of village : T a b o n i b a r a
4. Drawing of PV Facility

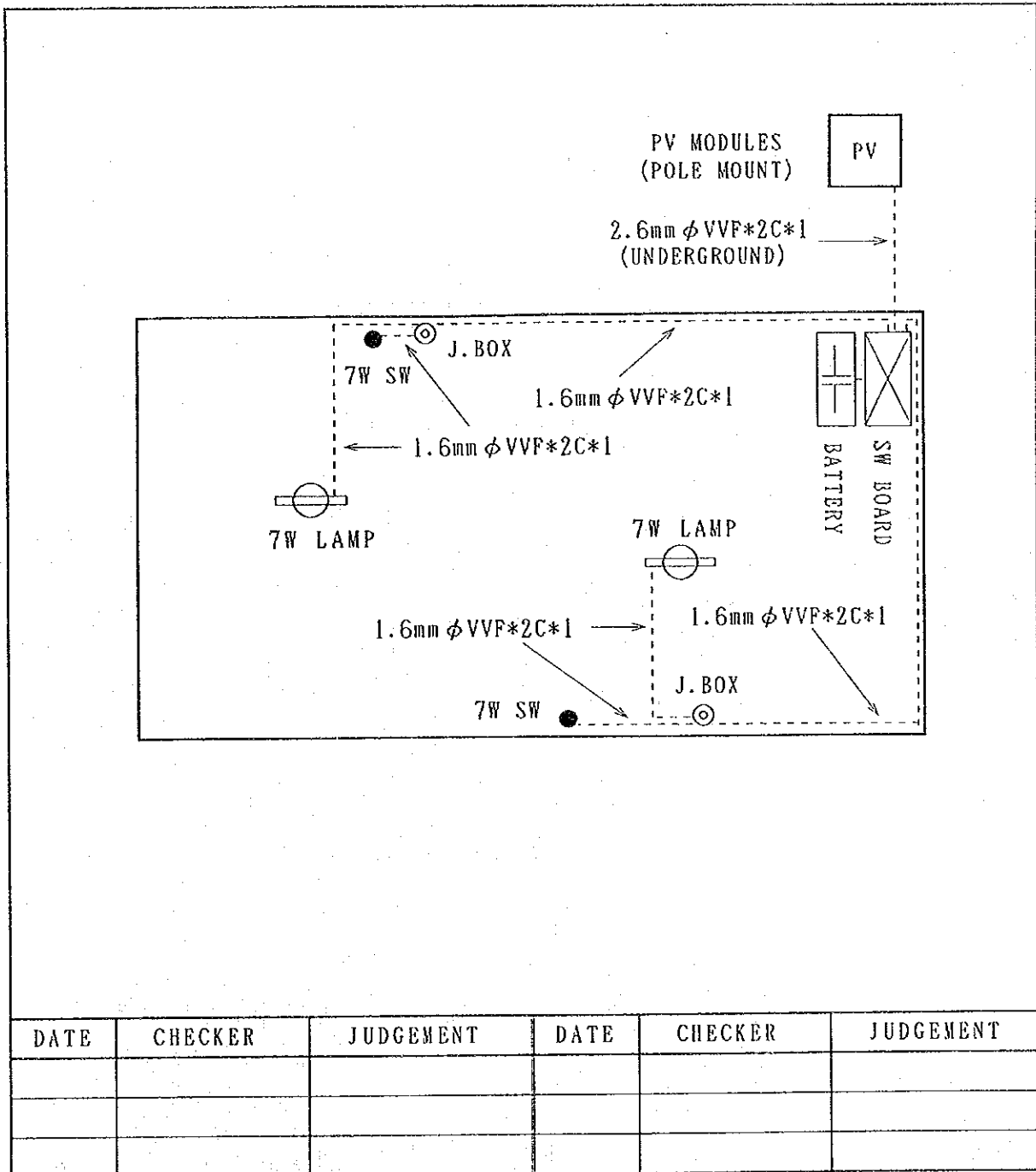

5. List of main equipment

	Equipment Item	Quantity		Equipment Item	Quantity
1	PV Module	2 pcs	8	1W LED night light	1 ea
2	Pole Mount	1 set	9	No Fuse Braker(10(A))	1 ea
3	Charge Controller	1 ea	10	Main switch(30(A))	3 ea
4	Battery(12V-100Ah)	1 ea	11	Protection Fuse(15(A))	1 ea
5	Battery Box	1 ea	12	Junction Box	2 pcs
6	Fluorescent Lamp(11w)	ea	13	Switch(7(W))	2 pcs
7	Fluorescent Lamp(7w)	2 pcs	14	3Way switch(11(W))	pcs

File of PV system Facility for Private House

1. Name of householder : T u t u T i r i b o
2. Code NO :
3. Name of village : T a b o n i b a r a
4. Drawing of PV Facility

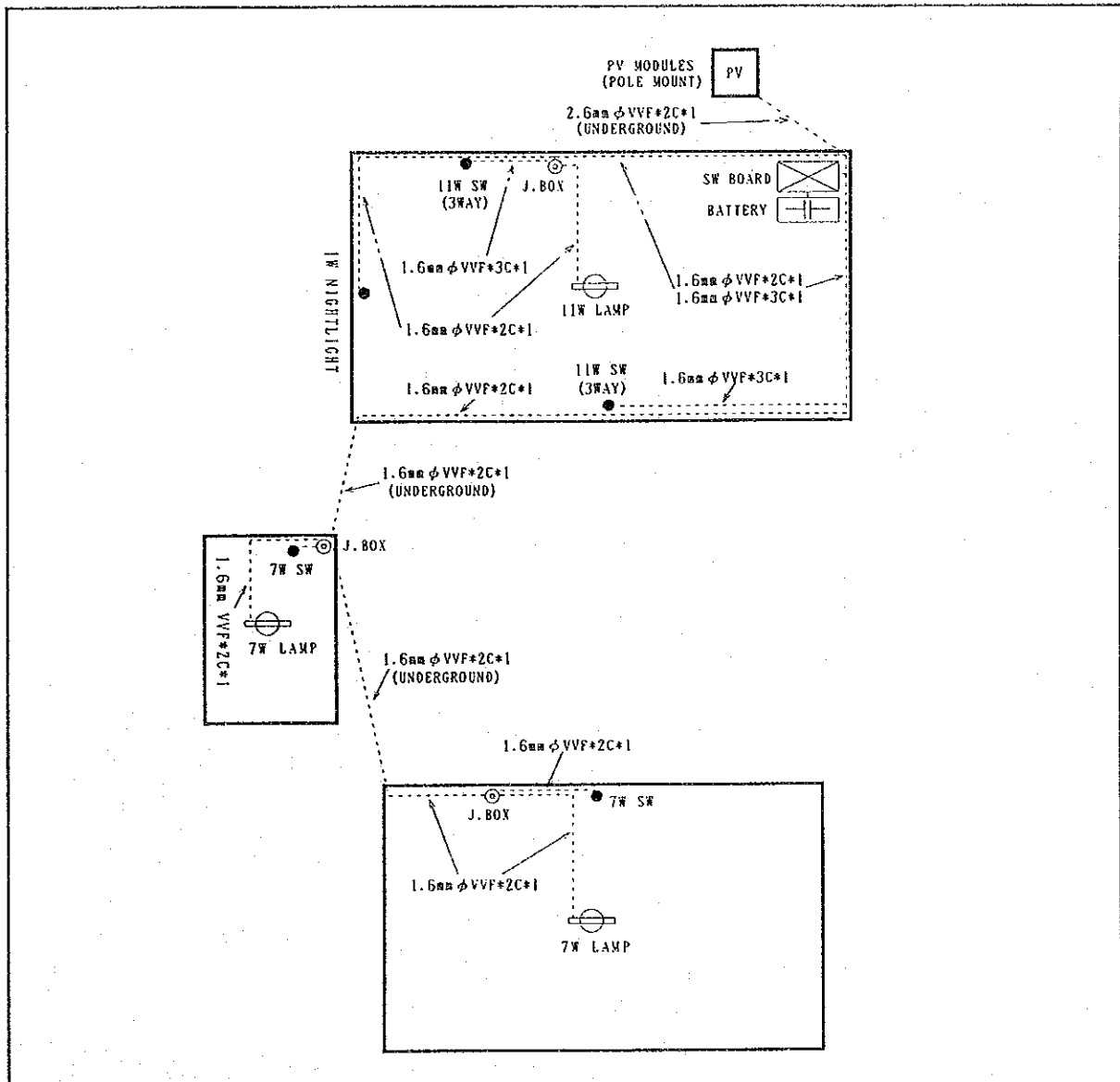

DATE	CHECKER	JUDGEMENT	DATE	CHECKER	JUDGEMENT

5. List of main equipment

	Equipment Item	Quantity		Equipment Item	Quantity
1	PV Module	2 pcs	8	1W LED night light	1 ea
2	Pole Mount	1 set	9	No Fuse Braker(10(A))	1 ea
3	Charge Controller	1 ea	10	Main switch(30(A))	3 ea
4	Battery(12V-100Ah)	1 ea	11	Protection Fuse(15(A))	1 ea
5	Battery Box	1 ea	12	Junction Box	3 pcs
6	Fluorescent Lamp(11w)	1 ea	13	Switch(7(W))	2 pcs
7	Fluorescent Lamp(7w)	2 pcs	14	3Way switch(11(W))	2 pcs

File of PV system Facility for Private House

1. Name of householder : B i r i k a u a T a b o k a i
2. Code NO : K 4
3. Name of village : K a i n a b a
4. Drawing of PV Facility

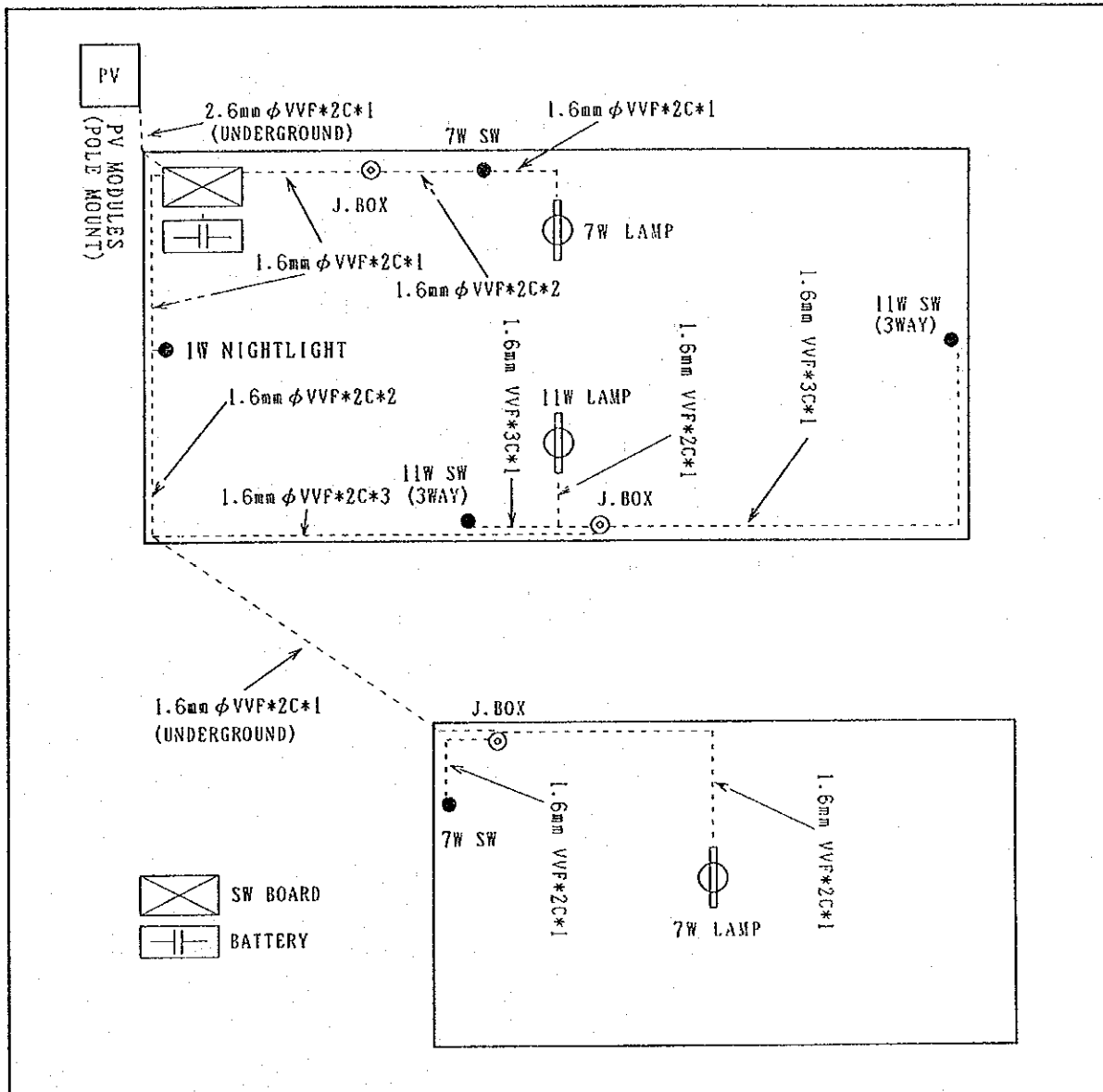

DATE	CHECKER	JUDGEMENT	DATE	CHECKER	JUDGEMENT

5. List of main equipment

	Equipment Item	Quantity		Equipment Item	Quantity
1	PV Module	2 pcs	8	1W LED night light	1 ea
2	Pole Mount	1 set	9	No Fuse Braker(10(A))	1 ea
3	Charge Controller	1 ea	10	Main switch(30(A))	3 ea
4	Battery(12V-100Ah)	1 ea	11	Protection Fuse(15(A))	1 ea
5	Battery Box	1 ea	12	Junction Box	3 pcs
6	Fluorescent Lamp(11w)	1 ea	13	Switch(7(W))	2 pcs
7	Fluorescent Lamp(7w)	2 pcs	14	3Way switch(11(W))	2 pcs

File of PV system Facility for Private House

1. Name of householder : T a a k e T e t a u a
2. Code NO : K 1 0
3. Name of village : K a i n a b a
4. Drawing of PV Facility

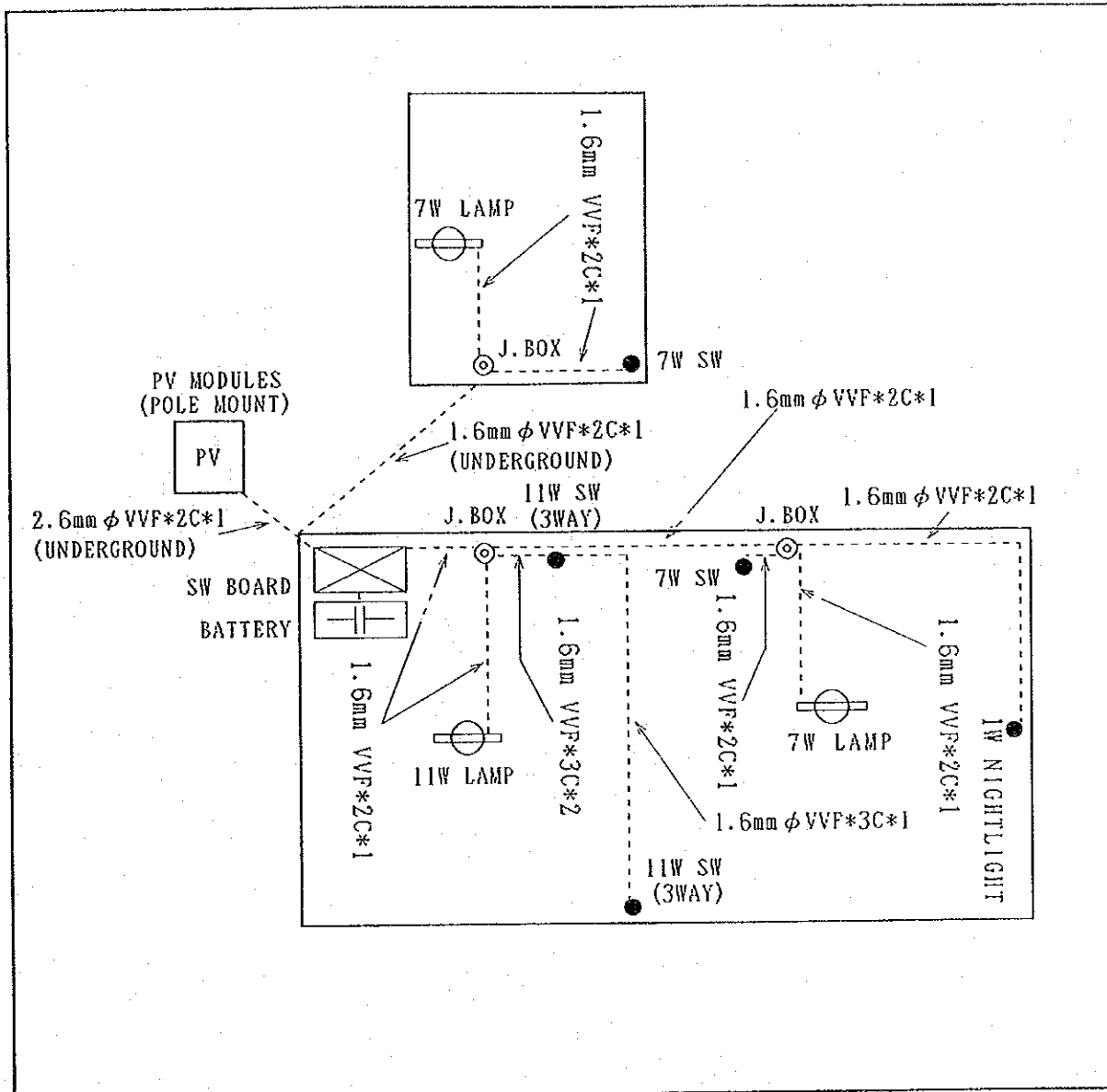

DATE	CHECKER	JUDGEMENT	DATE	CHECKER	JUDGEMENT

5. List of main equipment

Equipment Item	Quantity	Equipment Item	Quantity
1 PV Module	2 pcs	8 1W LED night light	1 ea
2 Pole Mount	1 set	9 No Fuse Braker(10(A))	1 ea
3 Charge Controller	1 ea	10 Main switch(30(A))	3 ea
4 Battery(12V-100Ah)	1 ea	11 Protection Fuse(15(A))	1 ea
5 Battery Box	1 ea	12 Junction Box	3 pcs
6 Fluorescent Lamp(11w)	1 ea	13 Switch(7(W))	2 pcs
7 Fluorescent Lamp(7w)	2 pcs	14 3Way switch(11(W))	2 pcs

File of PV system Facility for Private House

1. Name of householder : Te bu a t e i A b i e t e
2. Code NO : K 1 1
3. Name of village : K a i n a b a
4. Drawing of PV Facility

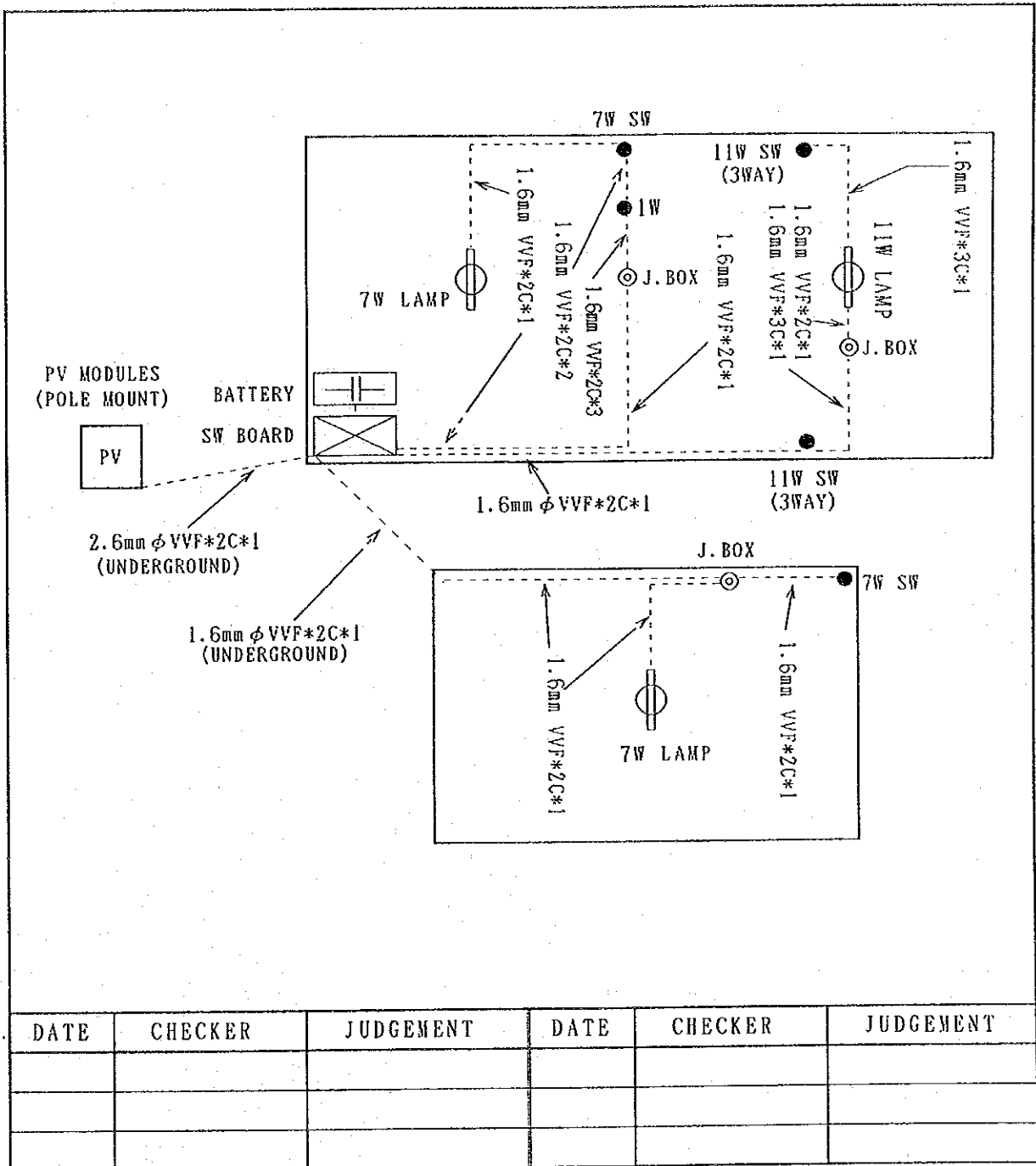

DATE	CHECKER	JUDGEMENT	DATE	CHECKER	JUDGEMENT

5. List of main equipment

	Equipment Item	Quantity		Equipment Item	Quantity
1	PV Module	2 pcs	8	1W LED night light	1 ea
2	Pole Mount	1 set	9	No Fuse Braker(10(A))	1 ea
3	Charge Controller	1 ea	10	Main switch(30(A))	3 ea
4	Battery(12V-100Ah)	1 ea	11	Protection Fuse(15(A))	1 ea
5	Battery Box	1 ea	12	Junction Box	3 pcs
6	Fluorescent Lamp(11w)	1 ea	13	Switch(7(W))	2 pcs
7	Fluorescent Lamp(7w)	2 pcs	14	3way switch(11(W))	2 pcs

File of PV system Facility for Private House

1. Name of householder : U e a n n a T e m a n i k a a i
2. Code NO : K 1 4
3. Name of village : K a i n a b a
4. Drawing of PV Facility

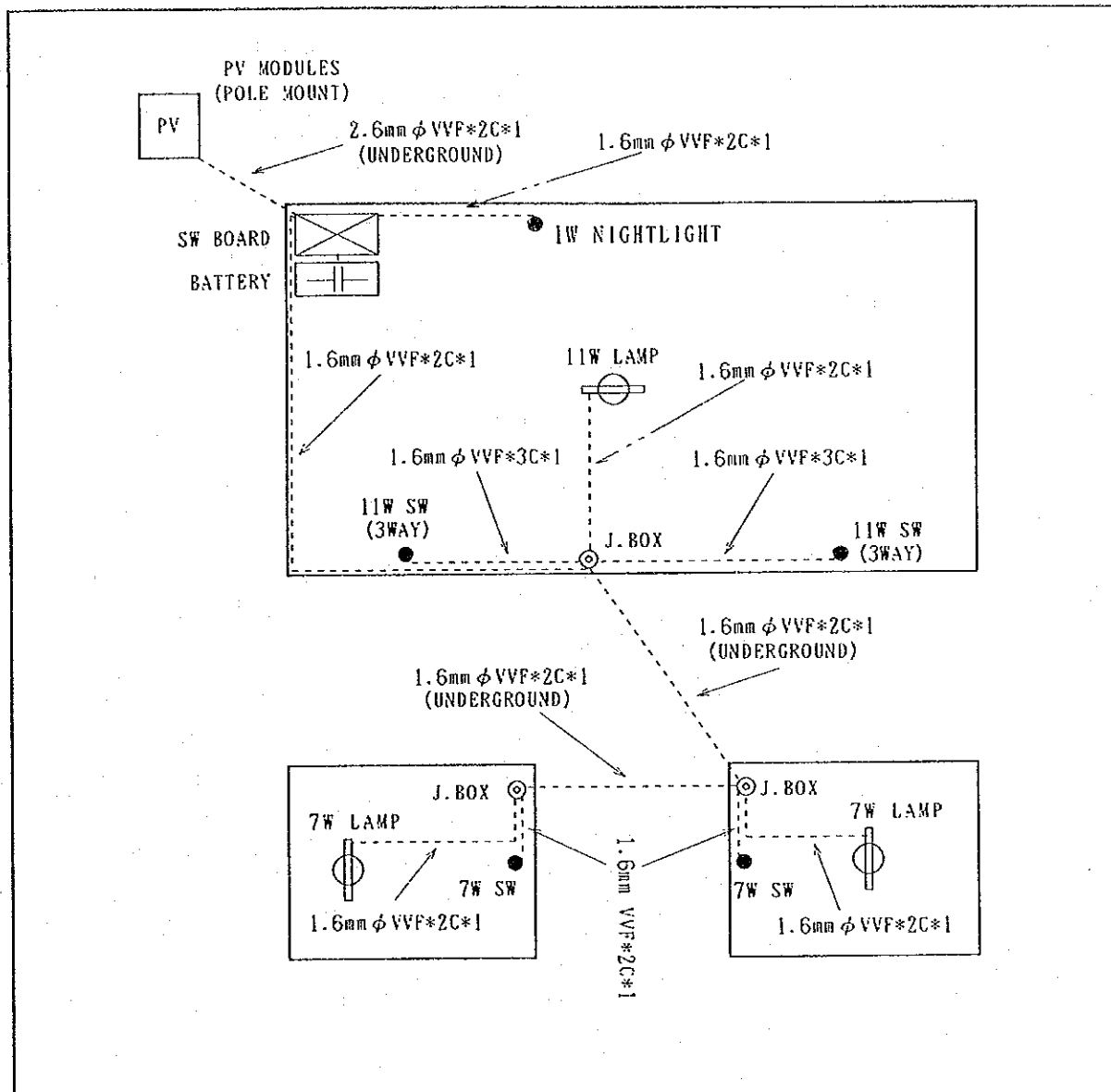

DATE	CHECKER	JUDGEMENT	DATE	CHECKER	JUDGEMENT

5. List of main equipment

No	Equipment Item	Quantity	No	Equipment Item	Quantity
1	PV Module	2 pcs	8	1W LED night light	1 ea
2	Pole Mount	1 set	9	No Fuse Braker(10(A))	1 ea
3	Charge Controller	1 ea	10	Main switch(30(A))	3 ea
4	Battery(12V-100Ah)	1 ea	11	Protection Fuse(15(A))	1 ea
5	Battery Box	1 ea	12	Junction Box	3 pcs
6	Fluorescent Lamp(11w)	1 ea	13	Switch(7(W))	2 pcs
7	Fluorescent Lamp(7w)	2 pcs	14	3Way switch(11(W))	2 pcs

File of PV system Facility for Maneaba

1. Name of householder : M a n c a b a
2. Code NO :
3. Name of village : K a i n a b a
4. Drawing of PV Facility

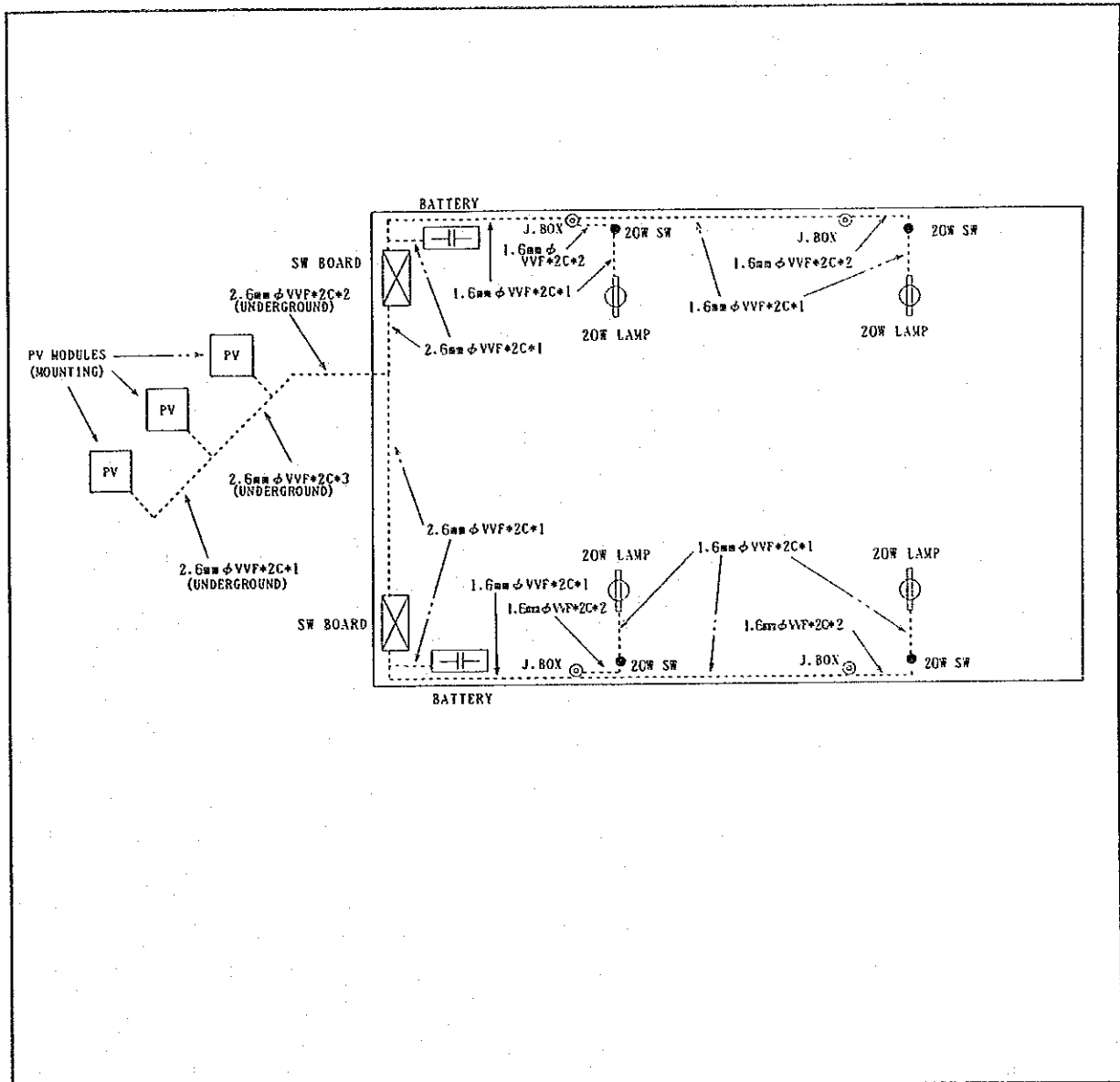

DATE	CHECKER	JUDGEMENT	DATE	CHECKER	JUDGEMENT

5. List of main equipment

	Equipment Item	Quantity		Equipment Item	Quantity
1	PV Module	12 pcs	8	Main switch(30(A))	6 ea
2	Mounting	3 set	9	Protection Fuse(15(A))	2 ea
3	Charge Controller	2 ea	10	Junction Box	4 pcs
4	Battery(12V-100Ah)	4 ea	11	Switch(20(W))	4 pcs
5	Battery Box	4 ea	12		
6	Fluorescent Lamp(20w)	4 ea	13		
7	No Fuse Braker(10(A))	2 ea	14		

JICA

U
LIE
E