

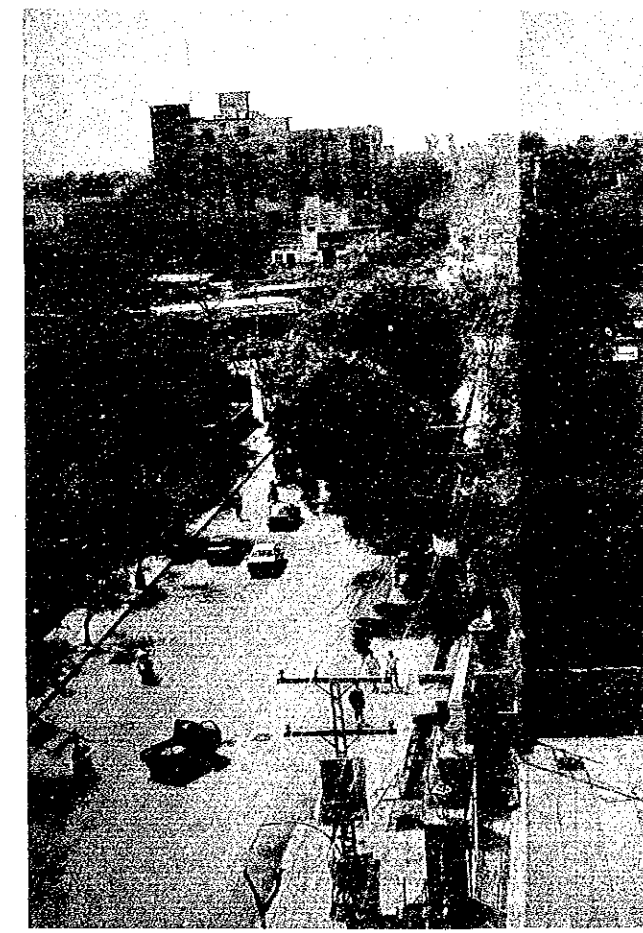

9

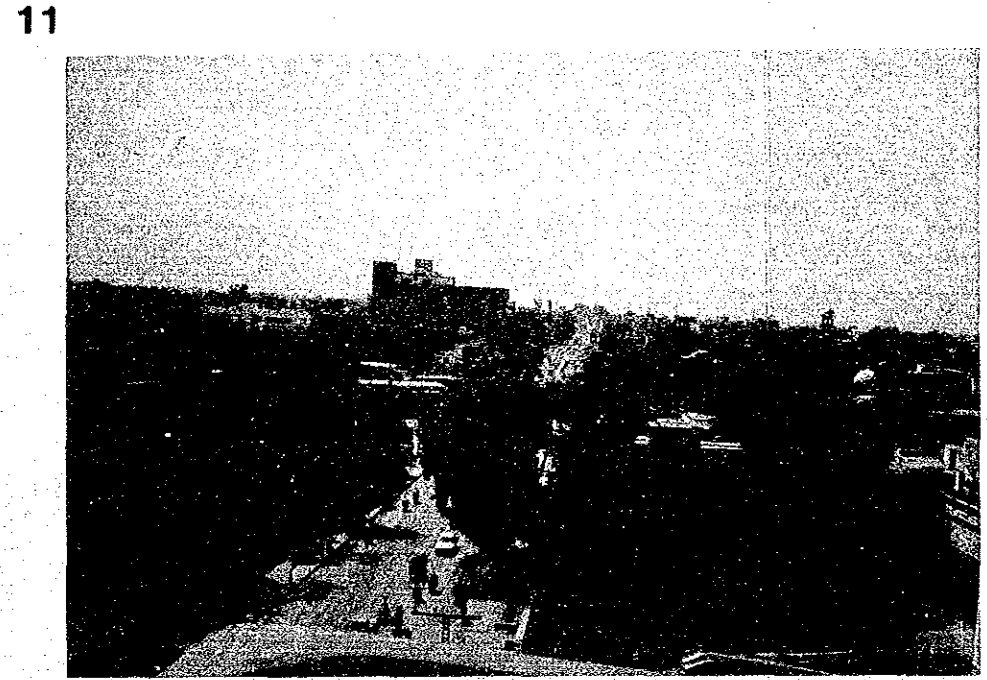

10

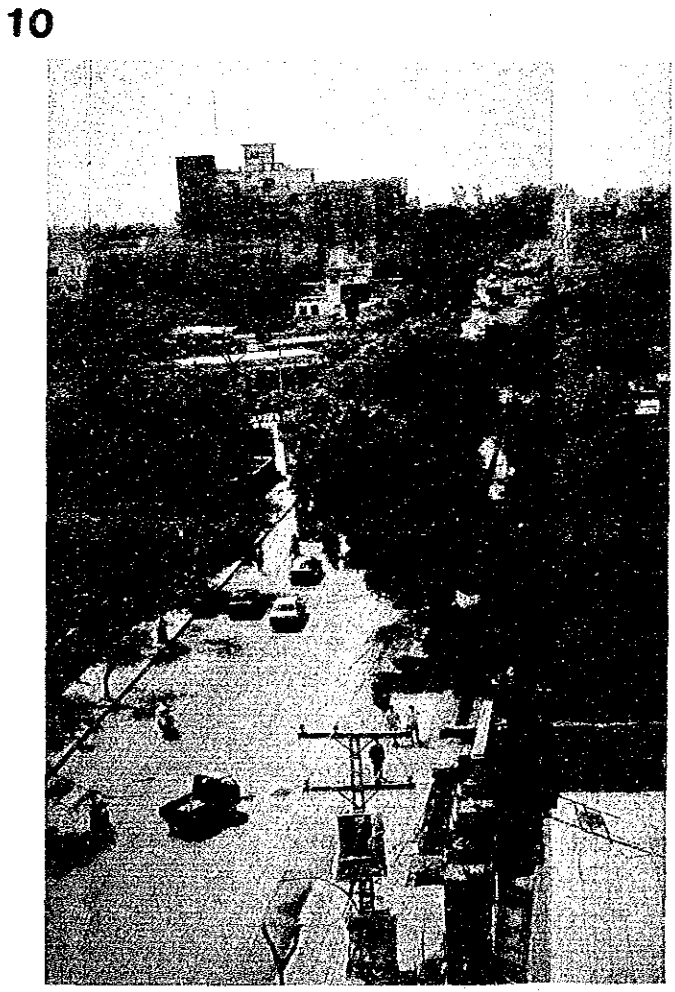
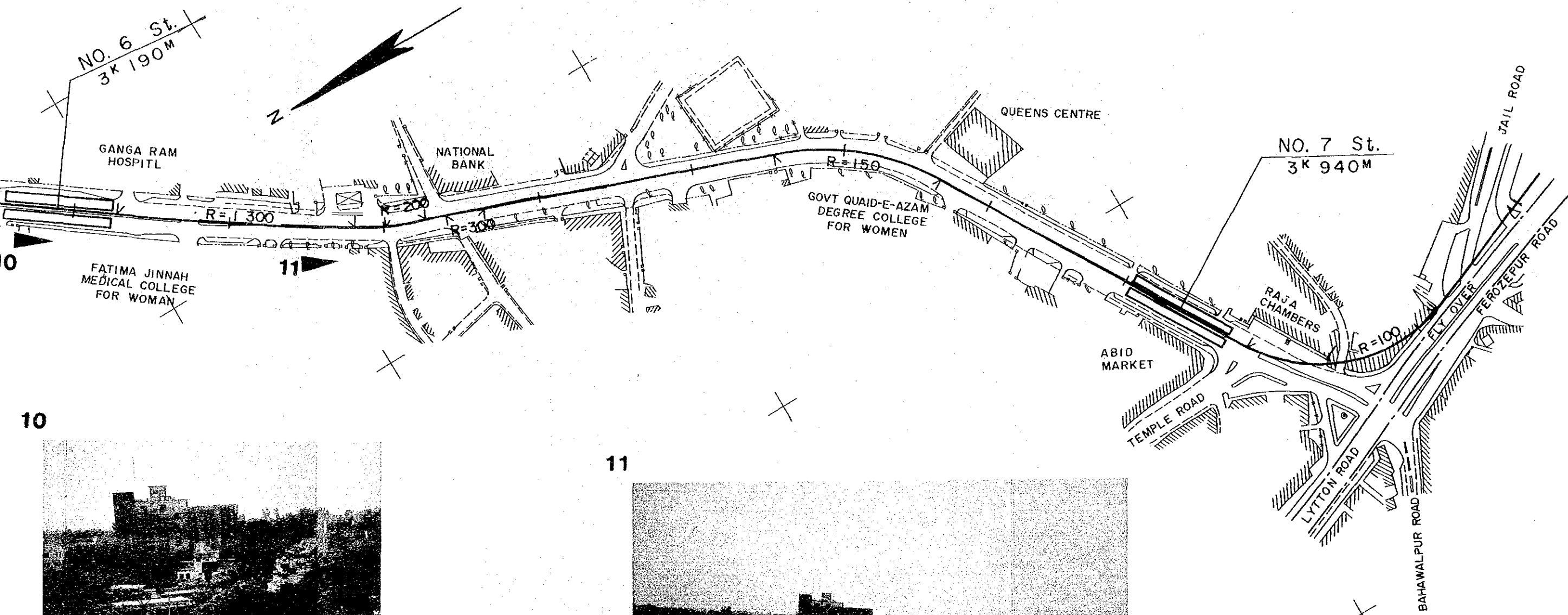



	COMPREHENSIVE STUDY ON TRANSPORTATION SYSTEM IN LAHORE JICA-TEPA-LDA	ROUTE PLAN OF LRT (3)	DWG NO.
		Scale 1: 2 500	14

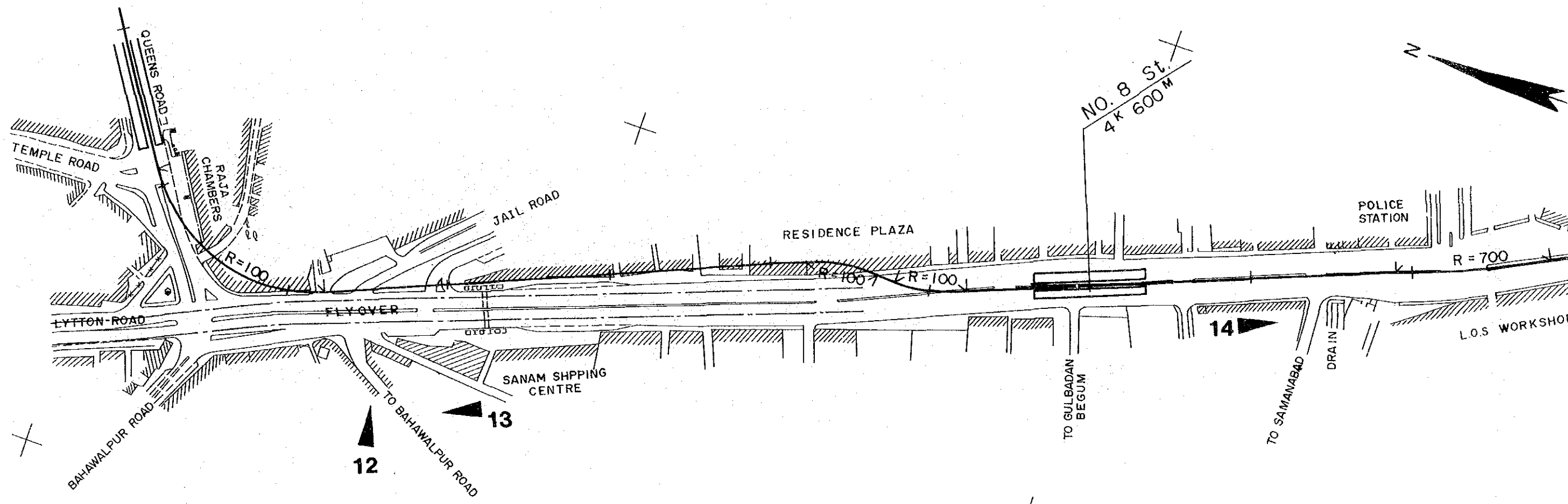

12

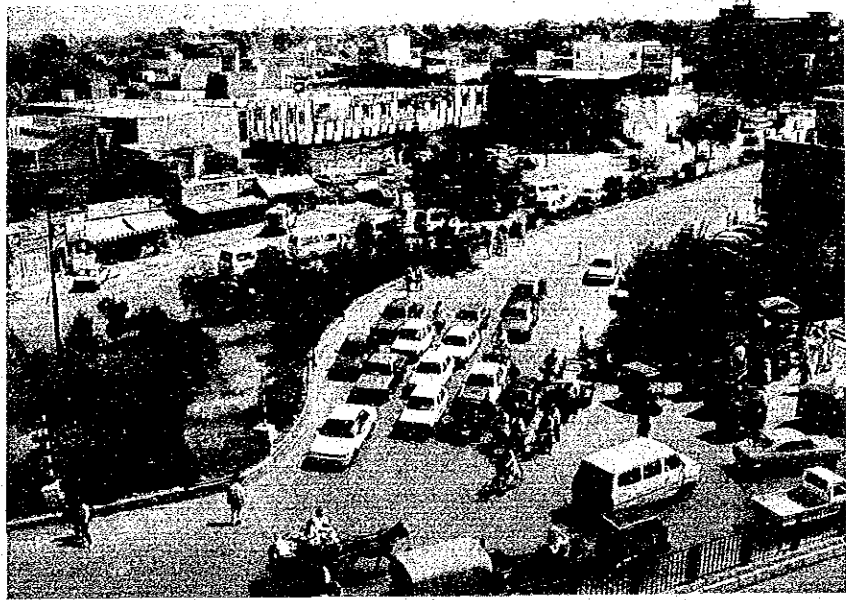

13



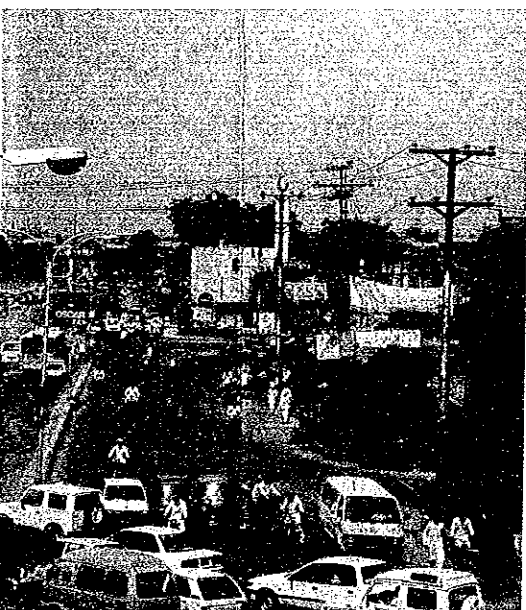
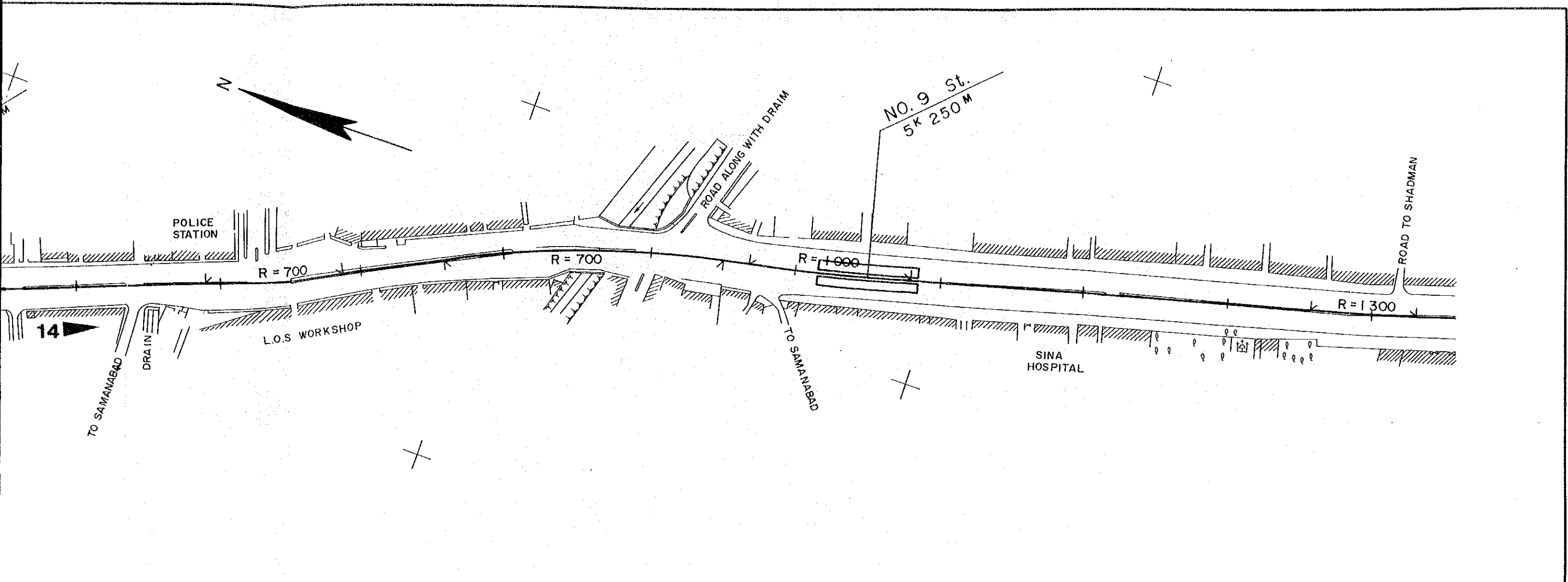

14

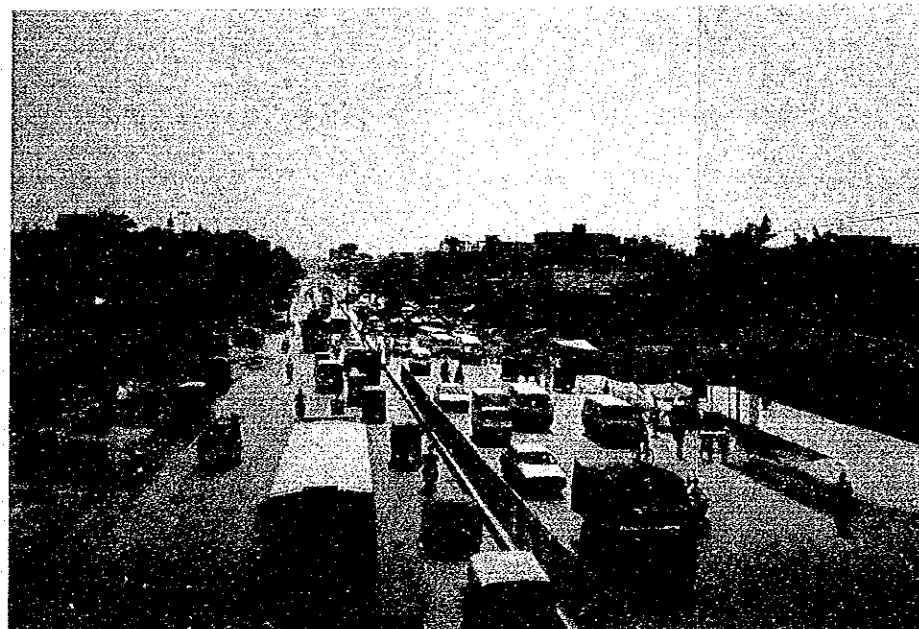

COMPREHENSIVE STUDY ON
TRANSPORTATION SYSTEM IN LAHORE
JICA-TEPA-LDA

ROUTE PLAN OF LRT (4)

Scale 1 : 2 500

DWG NO.

15

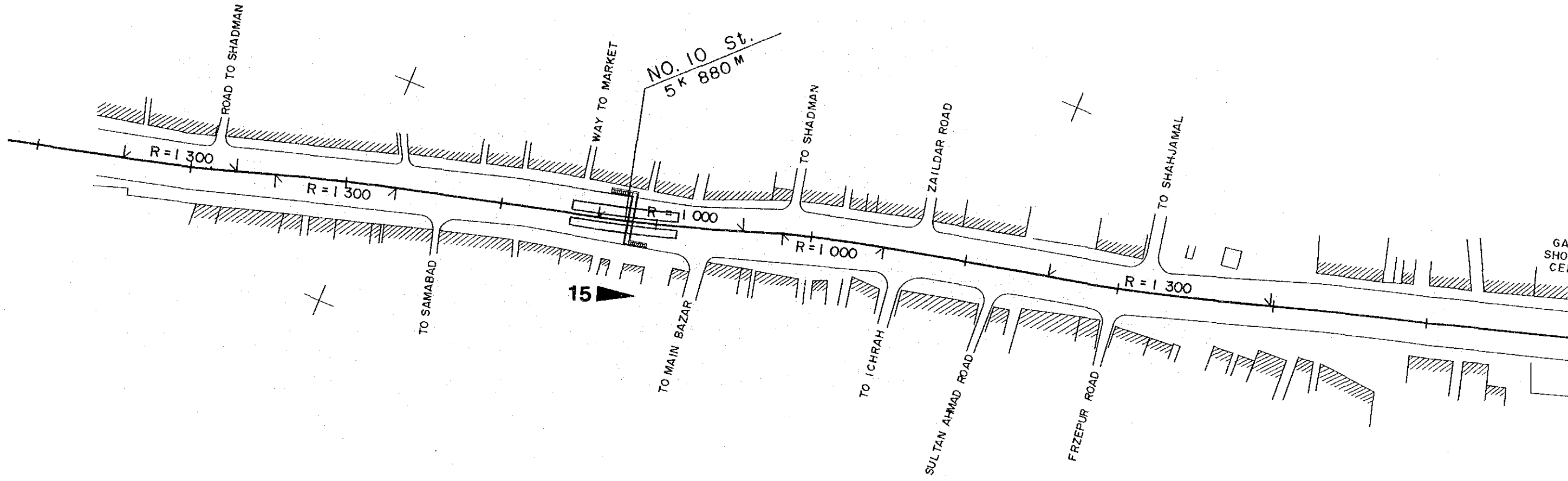

15

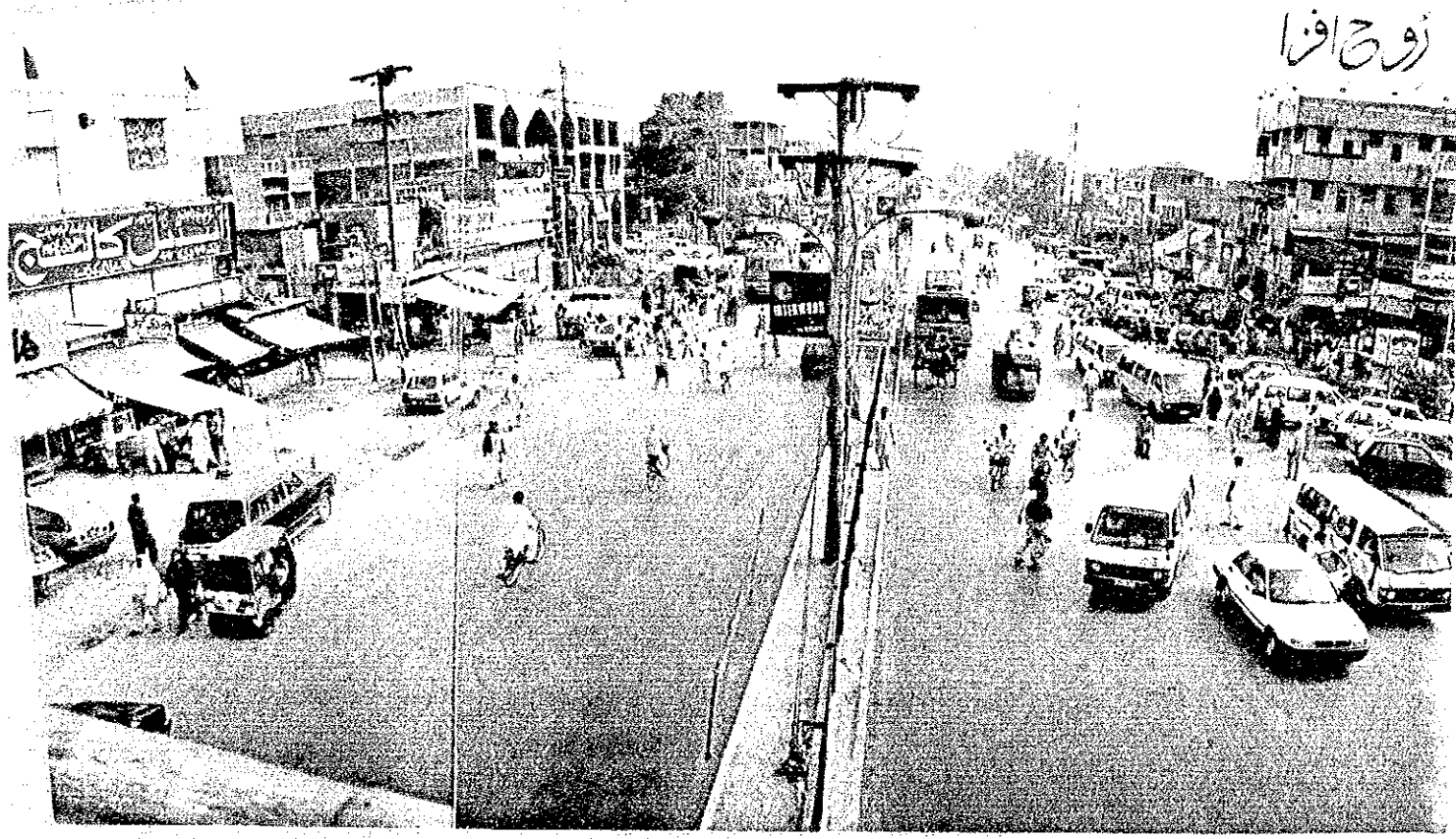

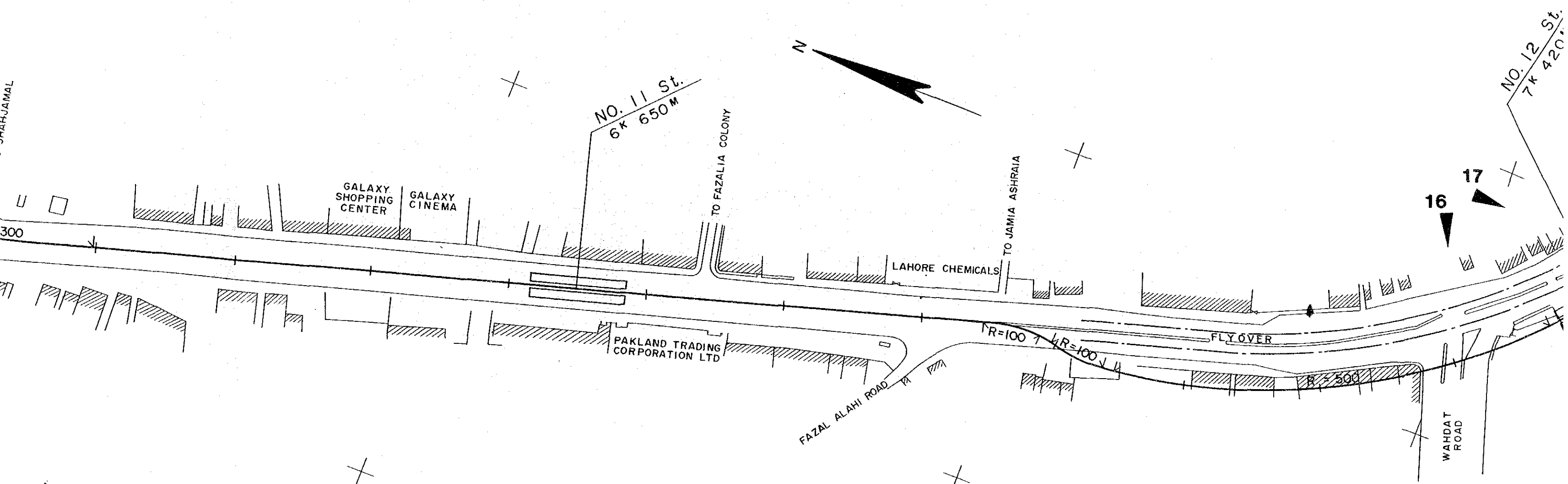

16

17

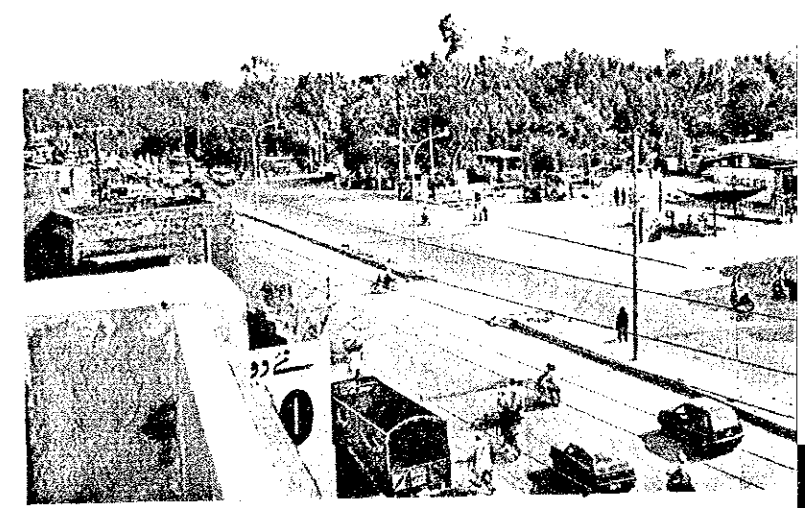
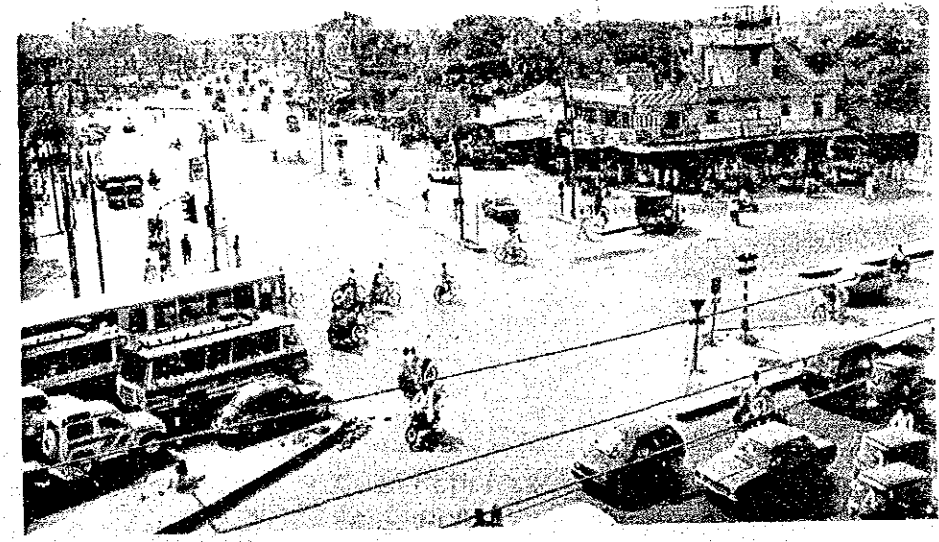

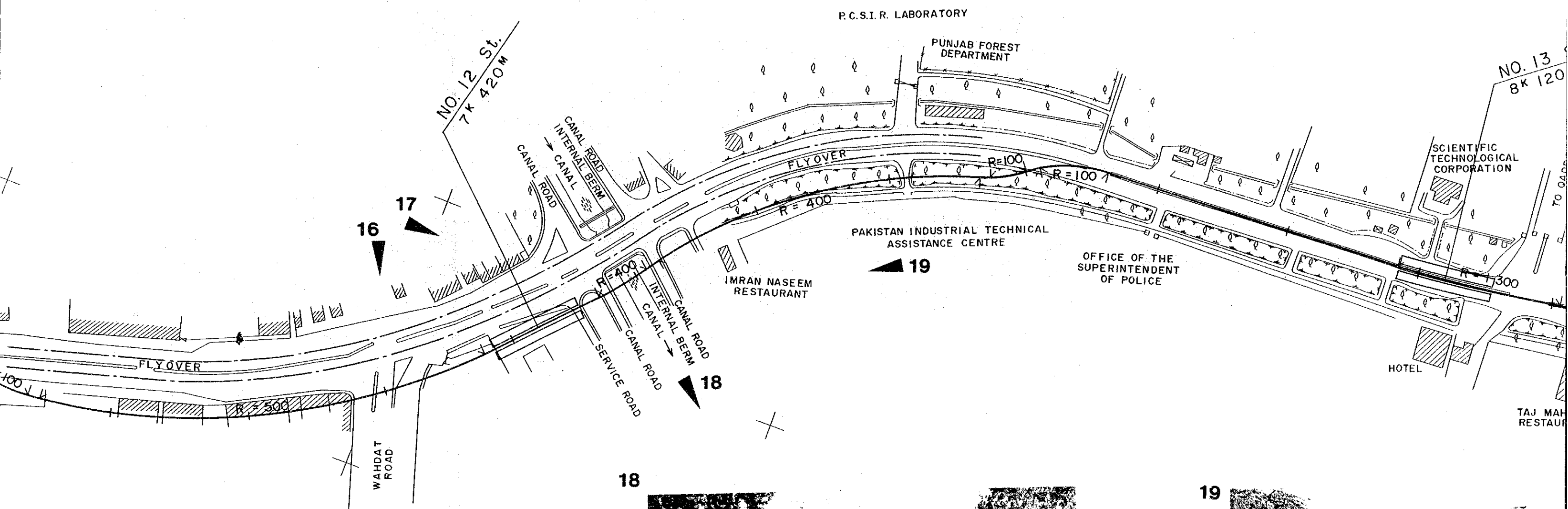

17

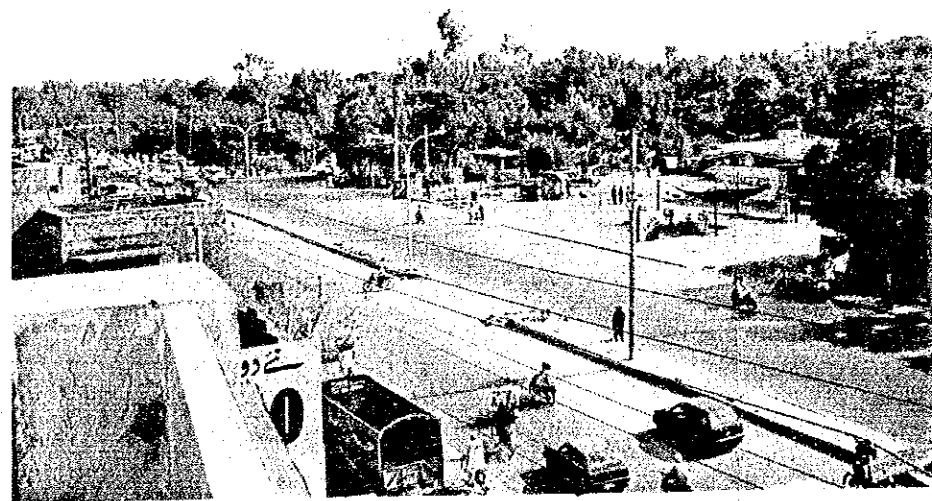

18

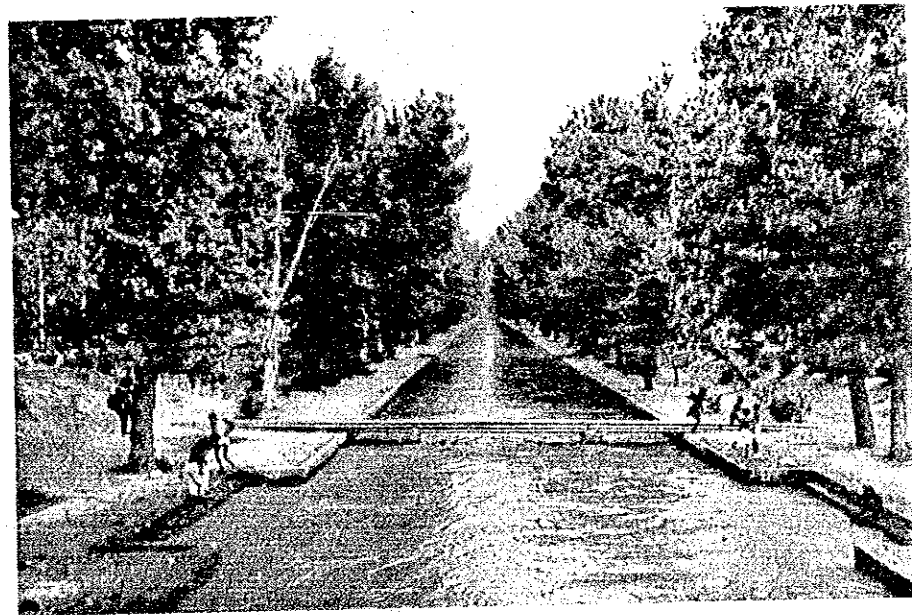

19

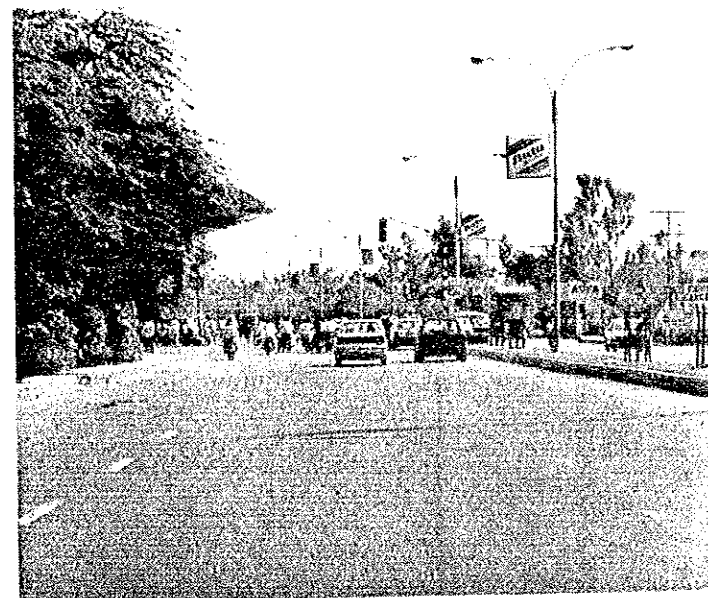

 COMPREHENSIVE STUDY ON
 TRANSPORTATION SYSTEM IN LAHORE
 JICA-TEPA-LDA

ROUTE PLAN OF
 Scale 1:2

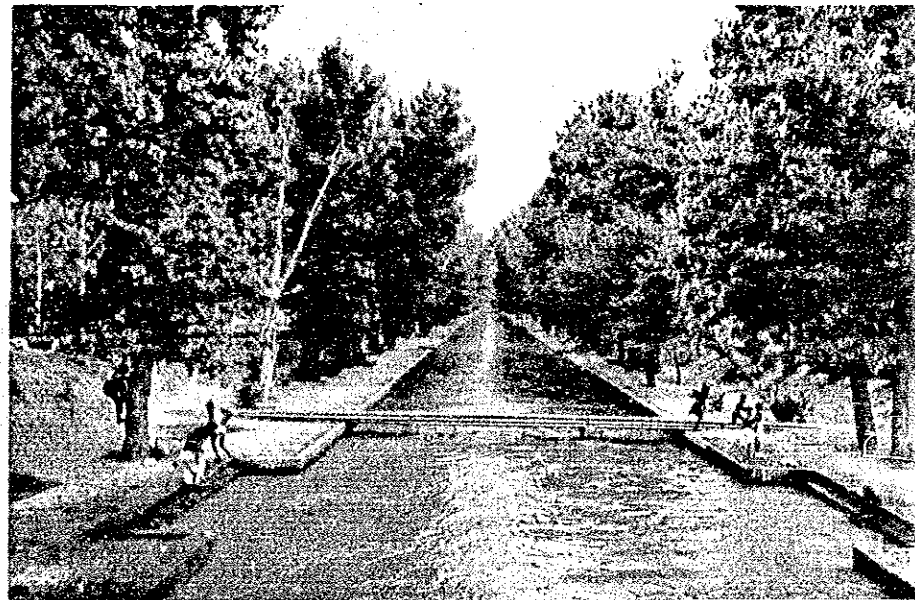
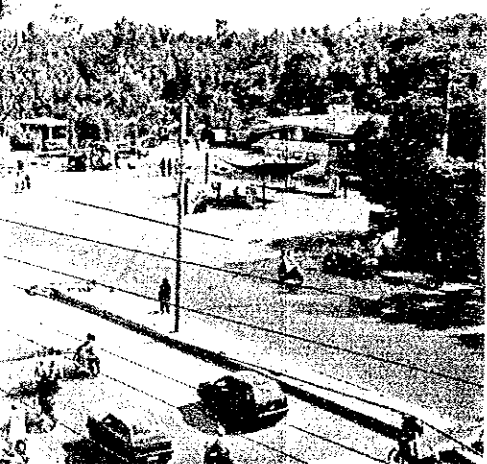
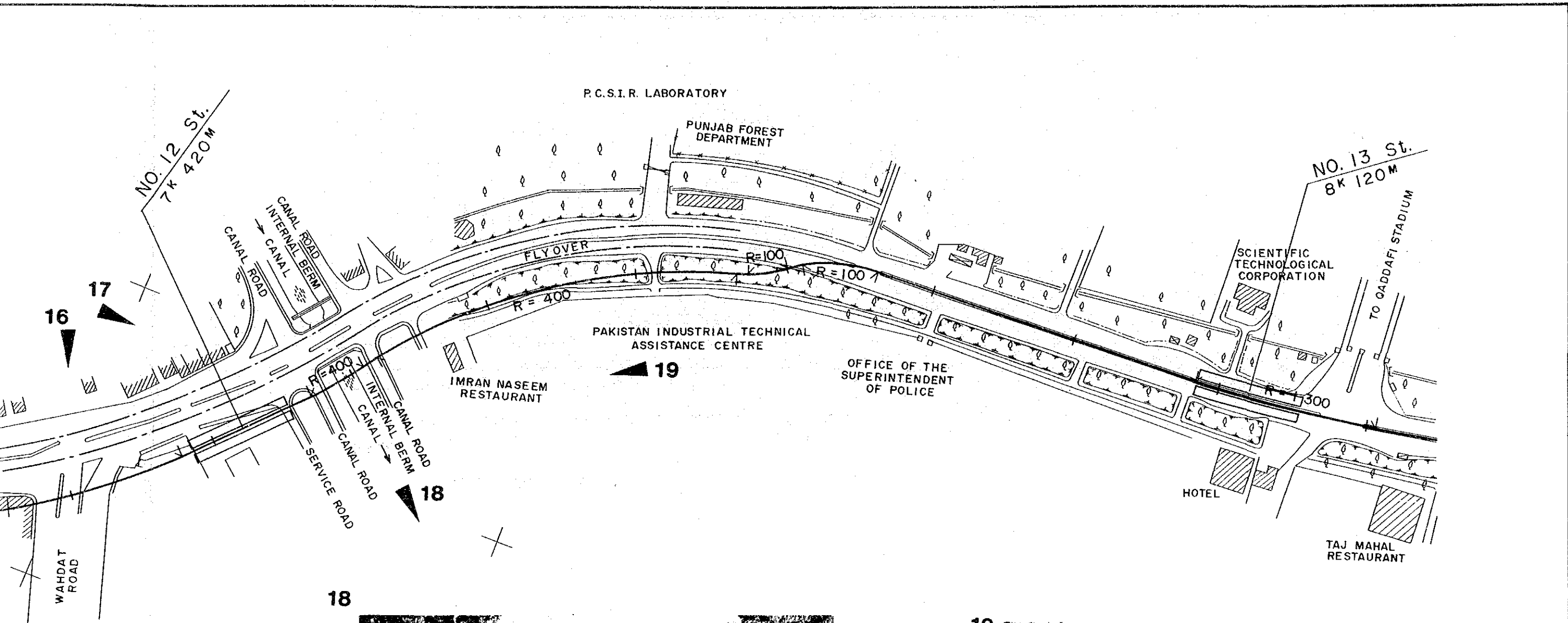

COMPREHENSIVE STUDY ON
TRANSPORTATION SYSTEM IN LAHORE
JICA-TEPA-LDA

ROUTE PLAN OF LRT (5)

Scale 1 : 2 500

DWG NO.

16

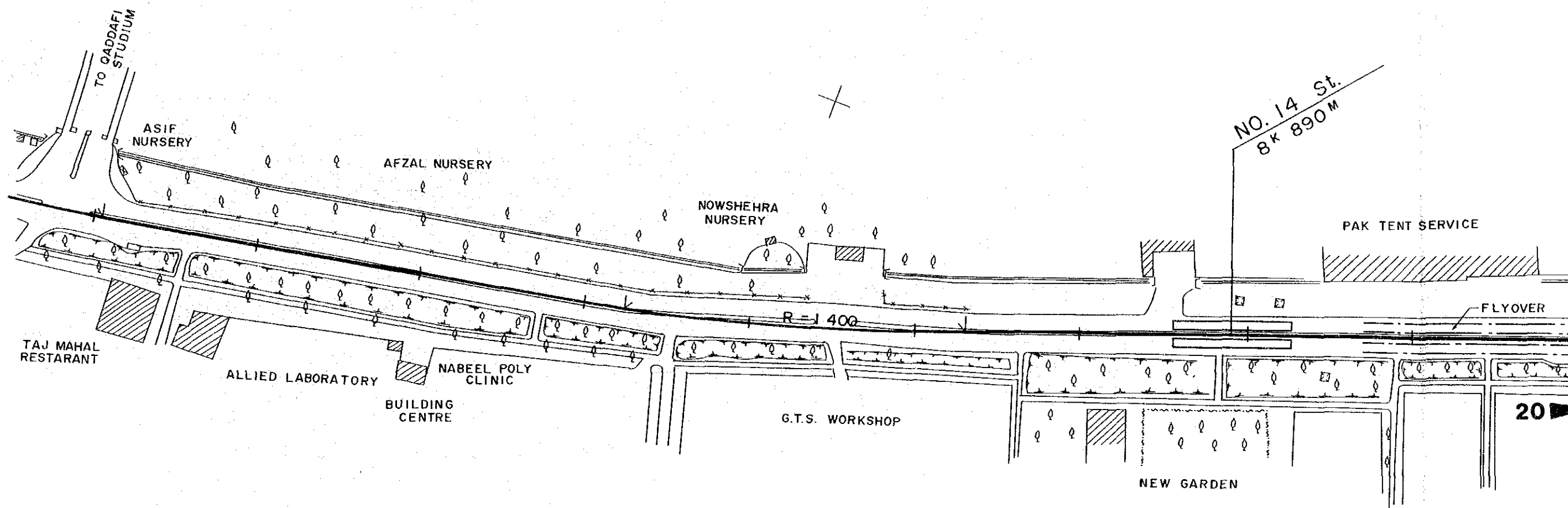

20



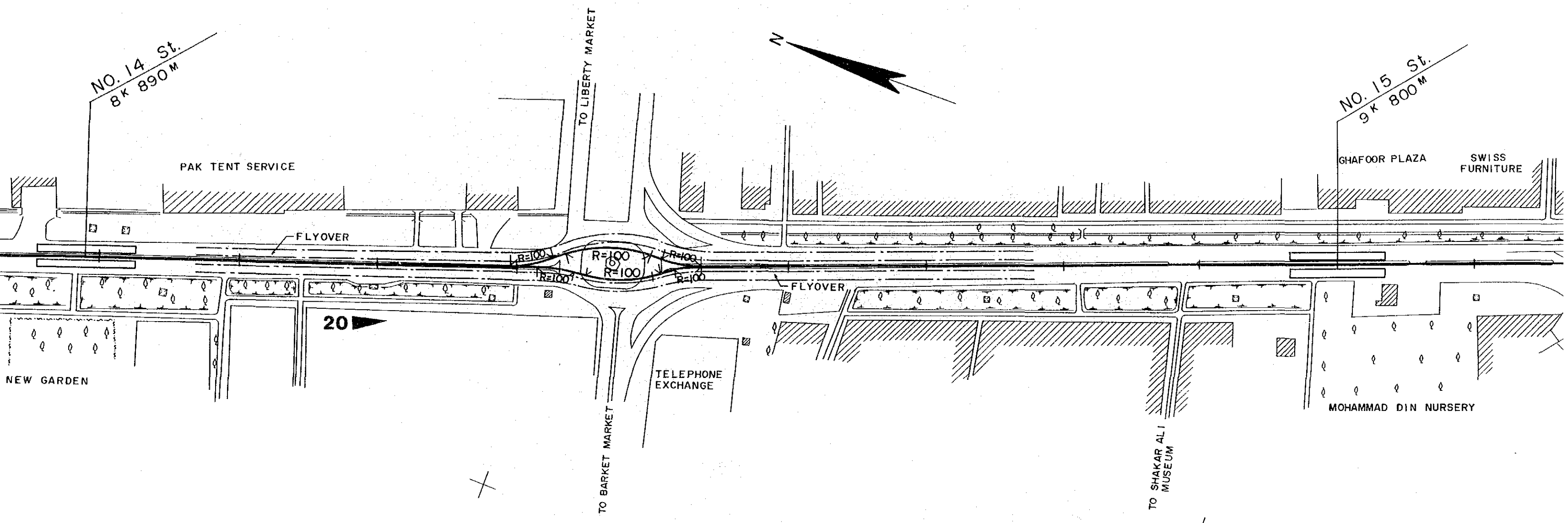

20

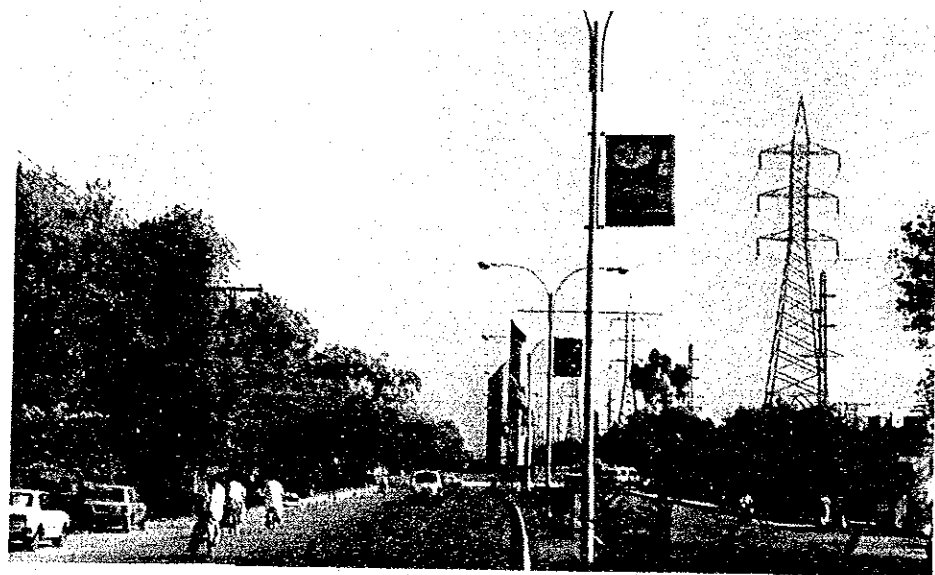

21



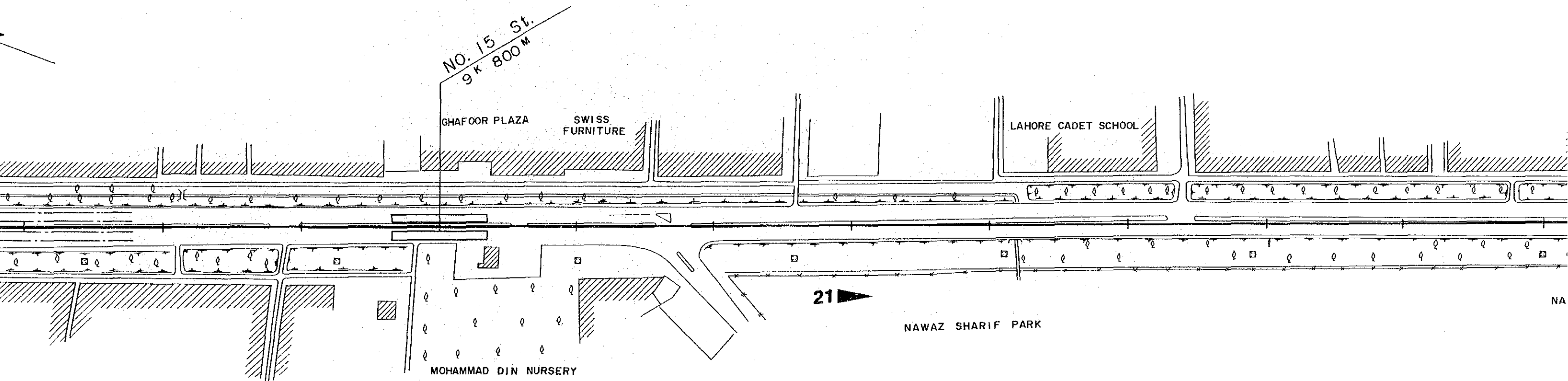

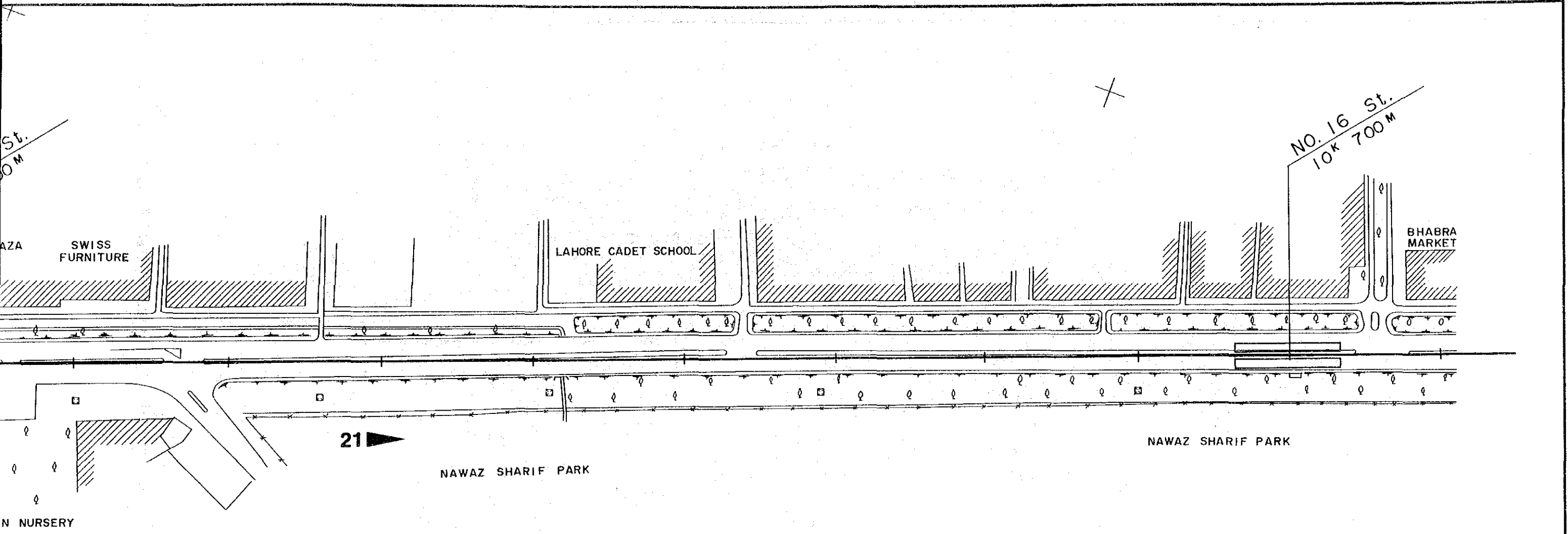

	COMPREHENSIVE STUDY ON TRANSPORTATION SYSTEM IN LAHORE 	ROUTE PLAN OF LRT (6)	DWG NO.
		Scale 1 : 2 500	17

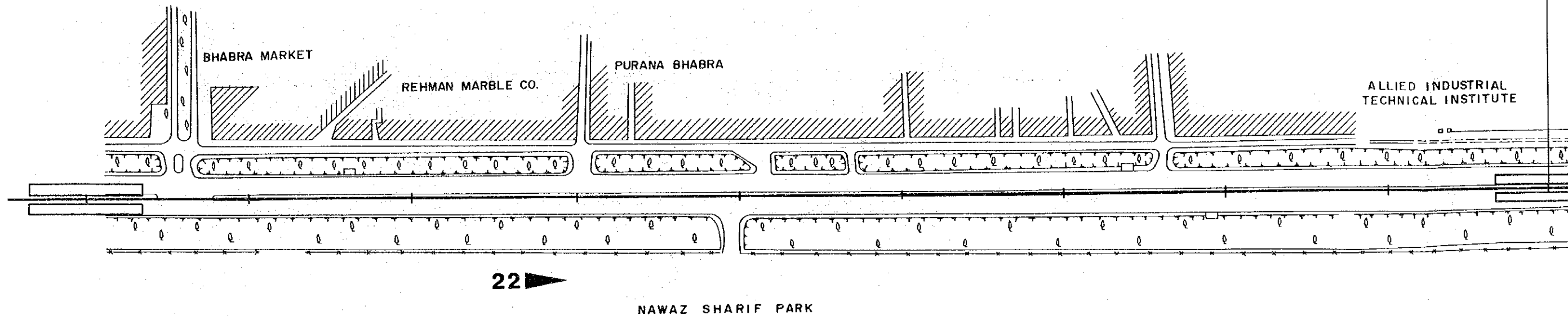

22

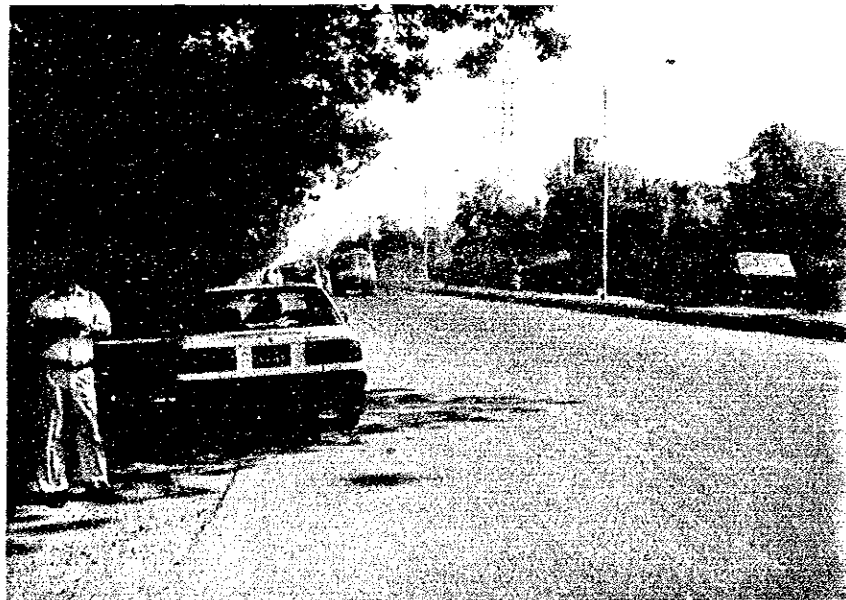

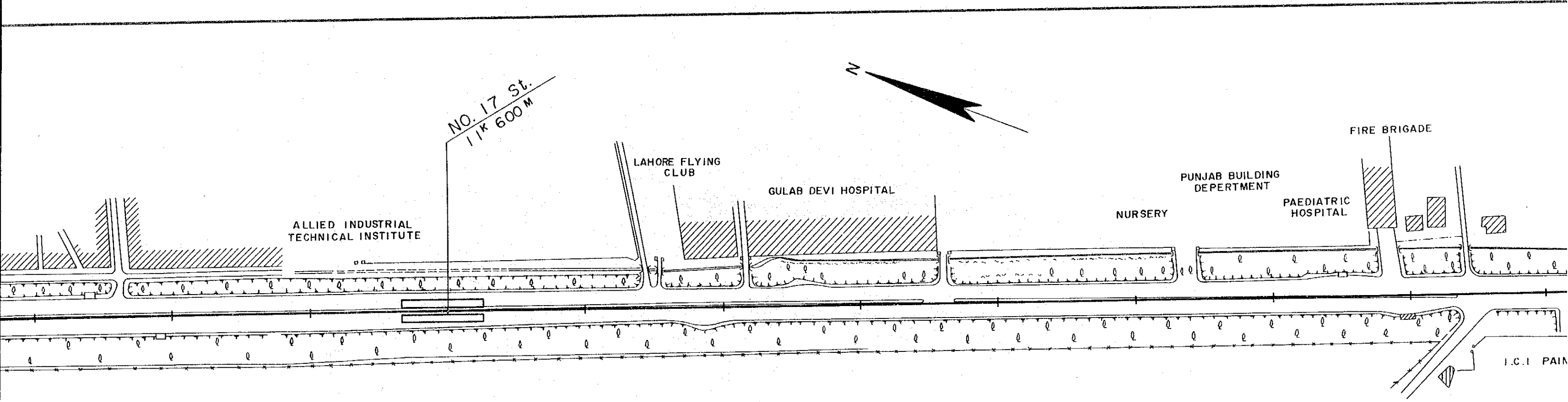

NAWAZ SHARIF PARK

23



24

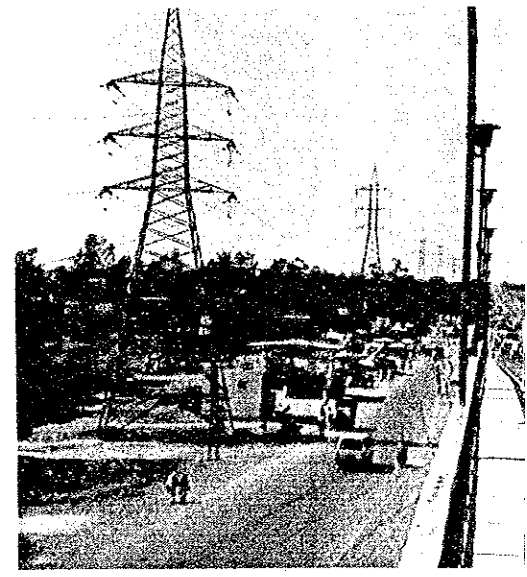

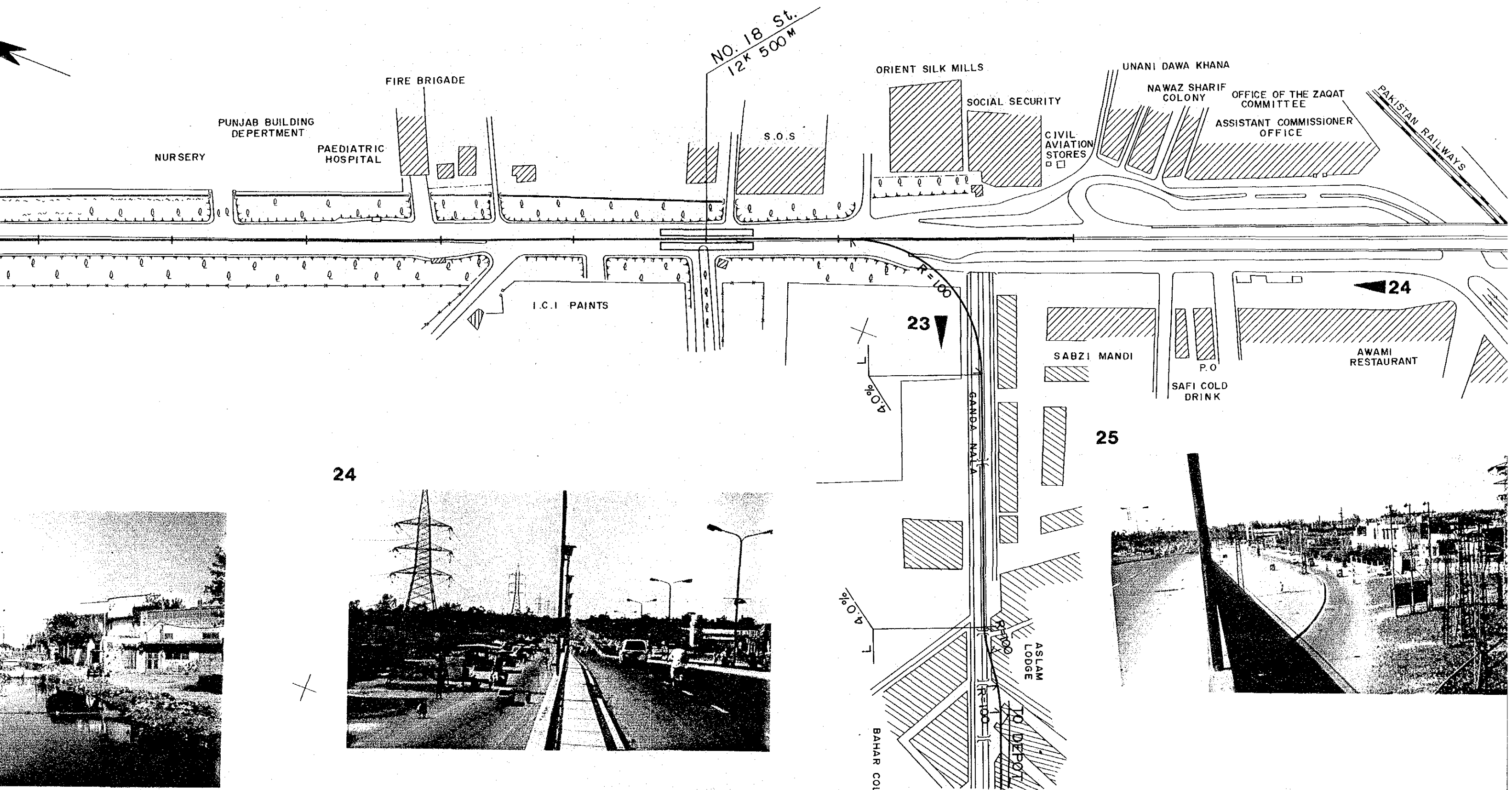

24



COMPREHENSIVE STUDY ON
TRANSPORTATION SYSTEM IN LAHORE

JICA-TEPA-LDA

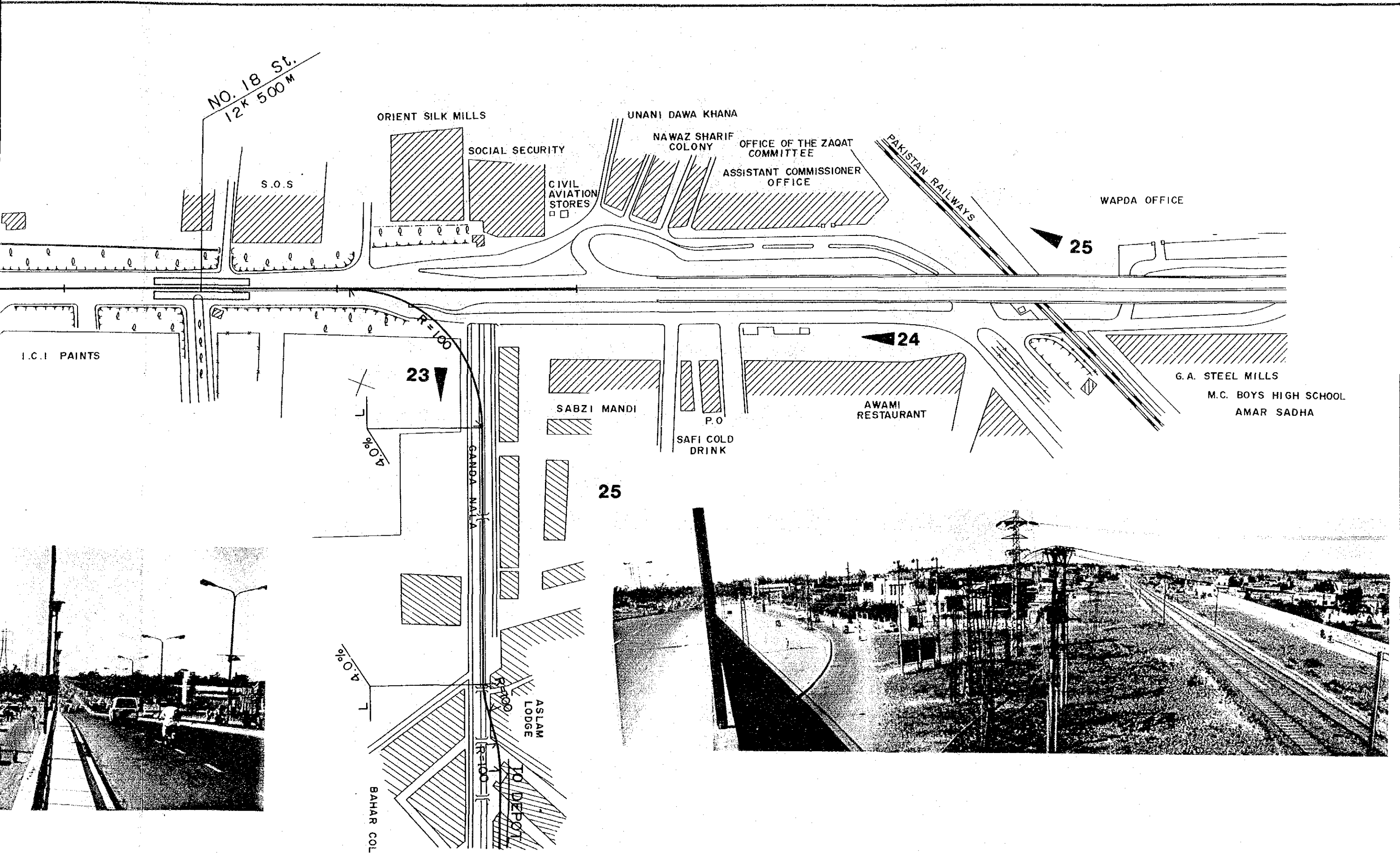

	COMPREHENSIVE STUDY ON TRANSPORTATION SYSTEM IN LAHORE JICA-TEPA-LDA	ROUTE PLAN OF LRT (7)	DWG NO.
		Scale 1 : 2 500	18

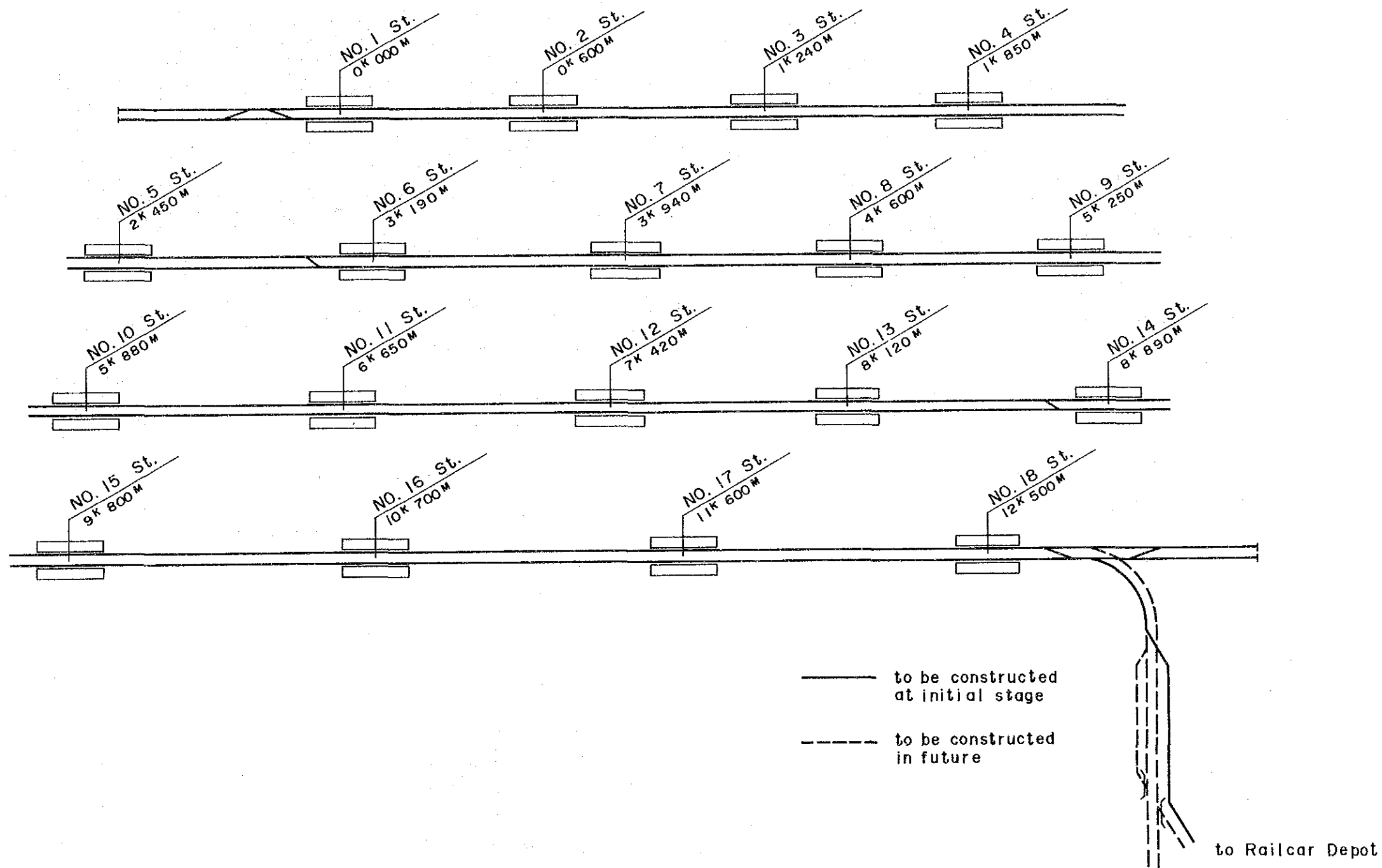

COMPREHENSIVE STUDY ON
 TRANSPORTATION SYSTEM IN LAHORE
 JICA-TEPA-LDA

TRACK LAYOUT

DWG NO.

19

SIDE VIEW

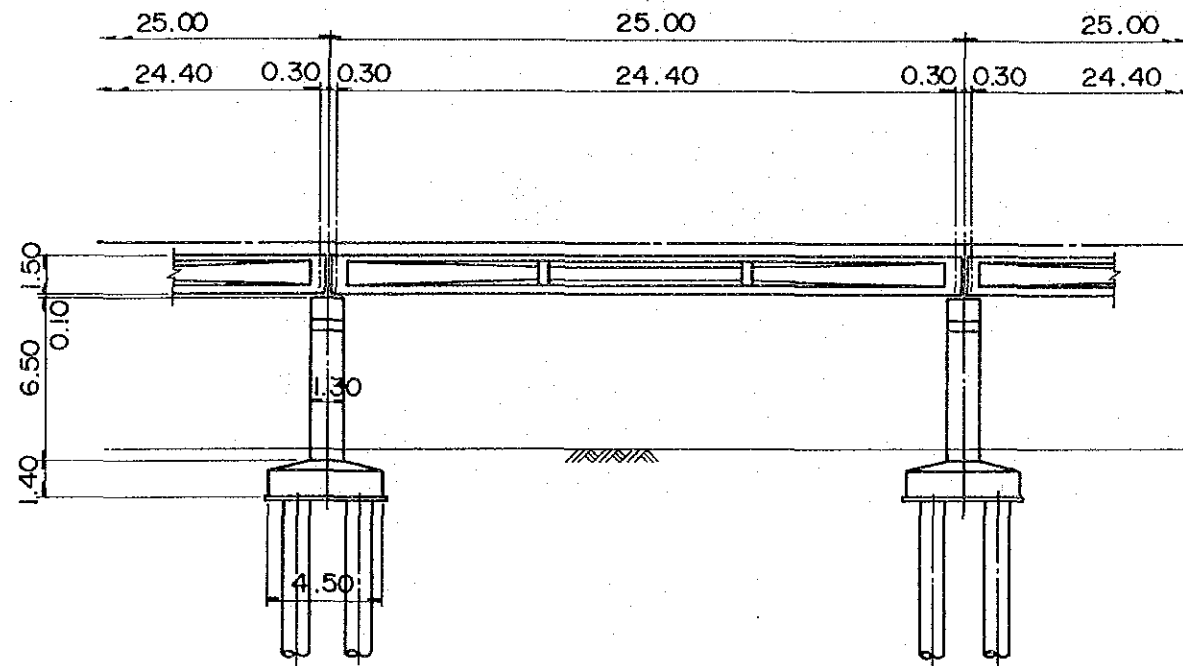

CROSS SECTION

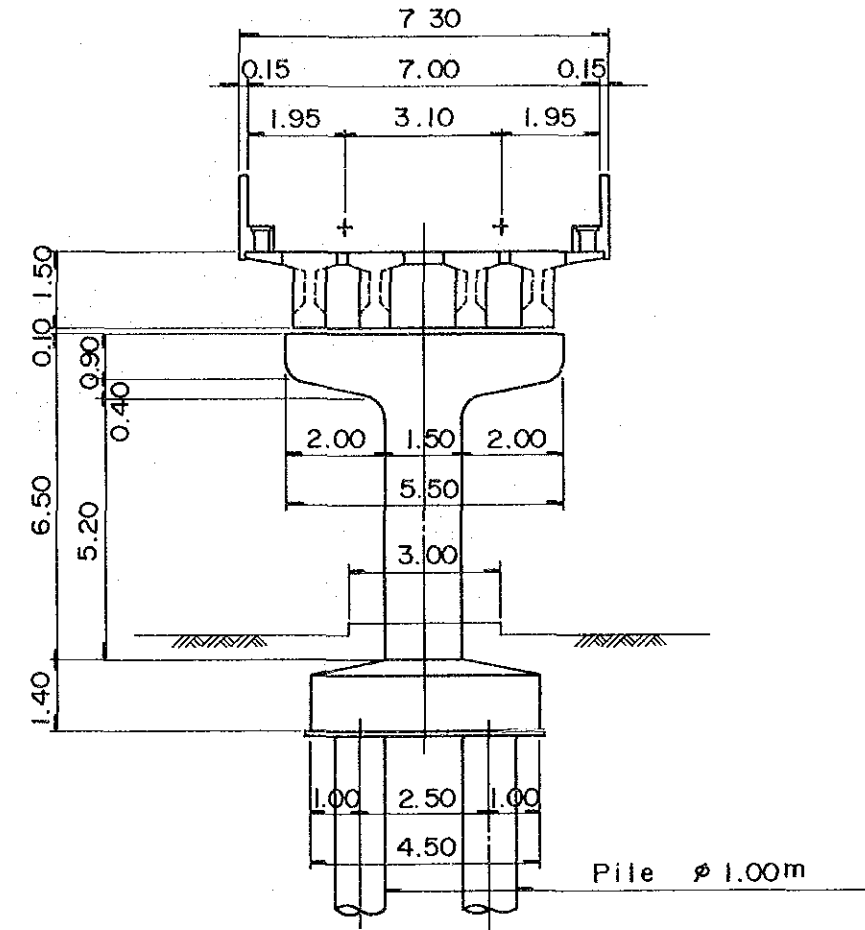

PLAN

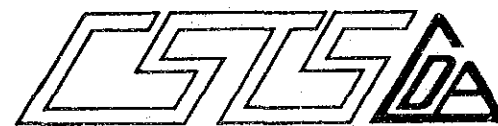
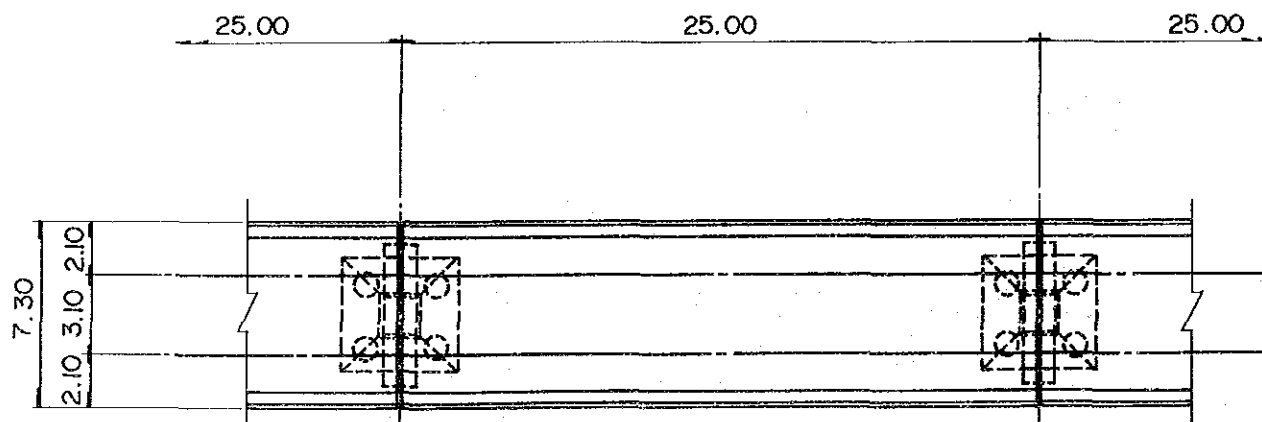

COMPREHENSIVE STUDY ON
TRANSPORTATION SYSTEM IN LAHORE
JICA-TEPA-LDA

**GENERAL PLAN
OF STANDARD STRUCTURE**
Scale

DWG NO.
20

SIDE VIEW

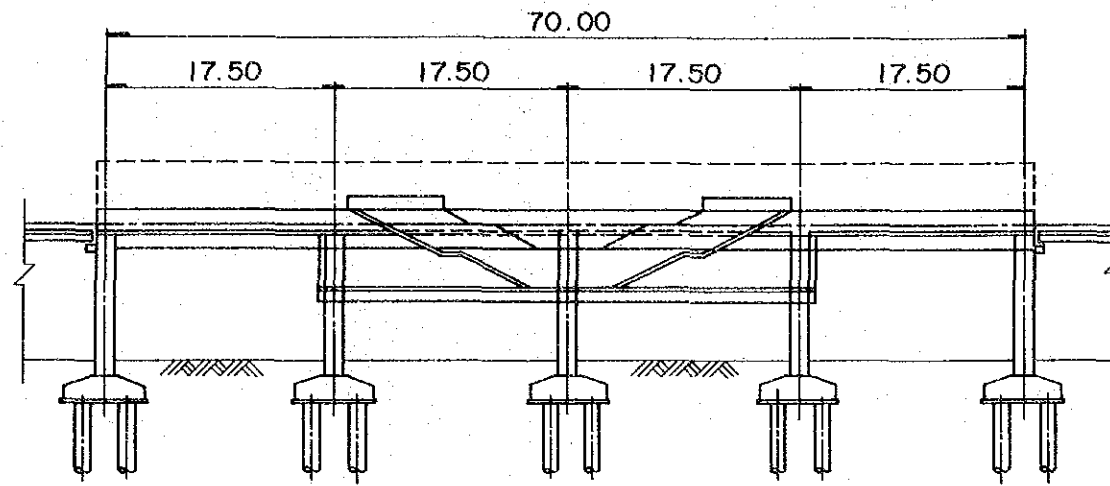

PLAN OF PLATFORM

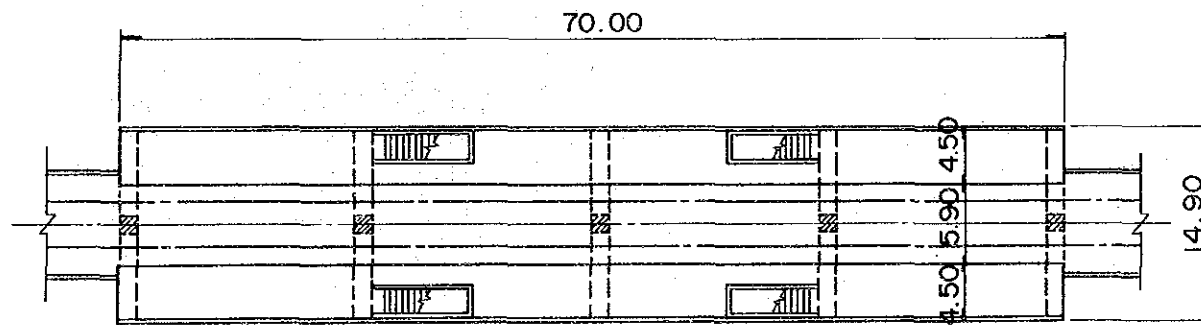

PLAN OF CONCOURSE

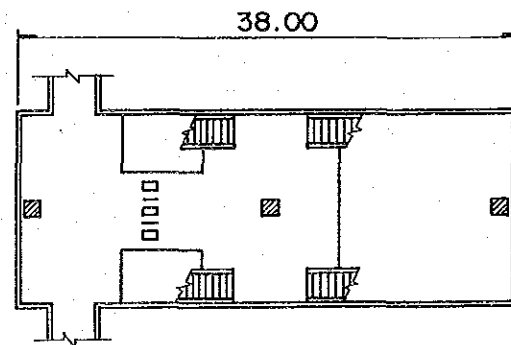

CROSS SECTION

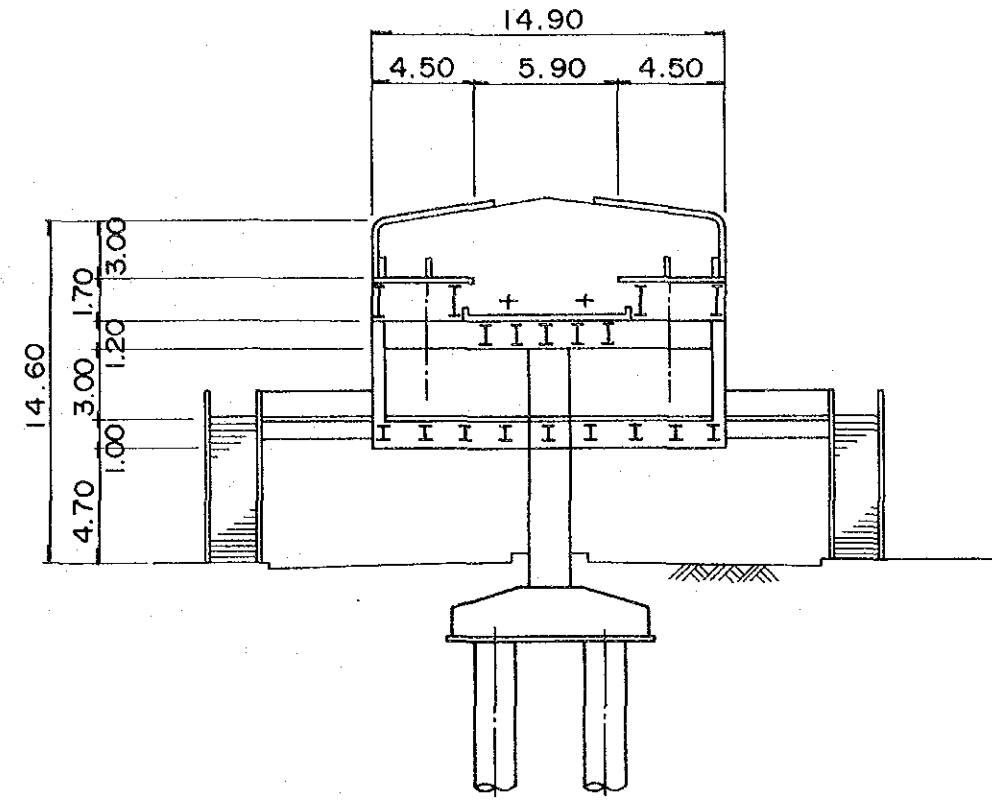

COMPREHENSIVE STUDY ON
TRANSPORTATION SYSTEM IN LAHORE
JICA-TEPA-LDA

GENERAL PLAN
OF STANDARD STATION

DWG NO.

21

CROSS SECTION

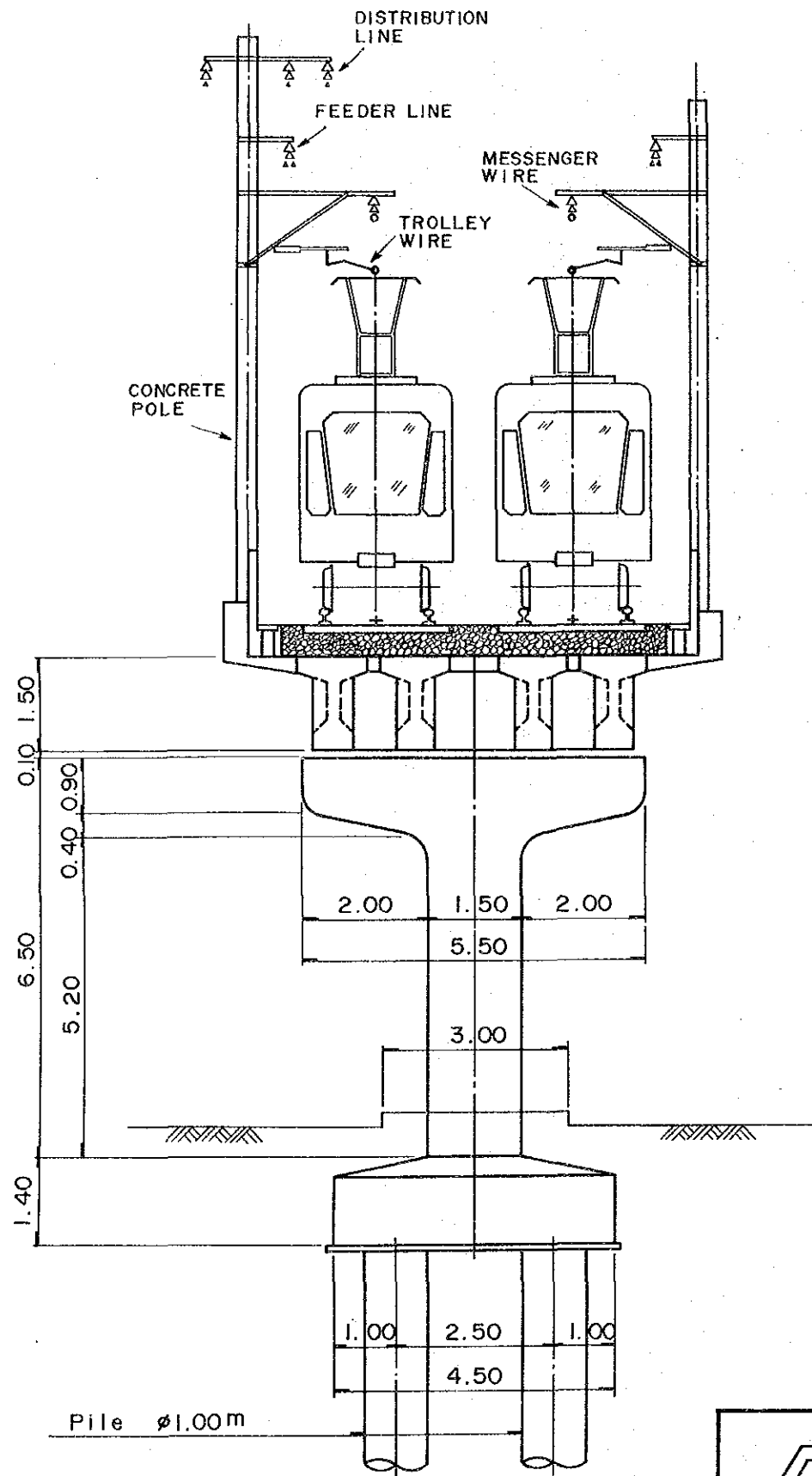

ELECTRIC POWER SUPPLY SYSTEM

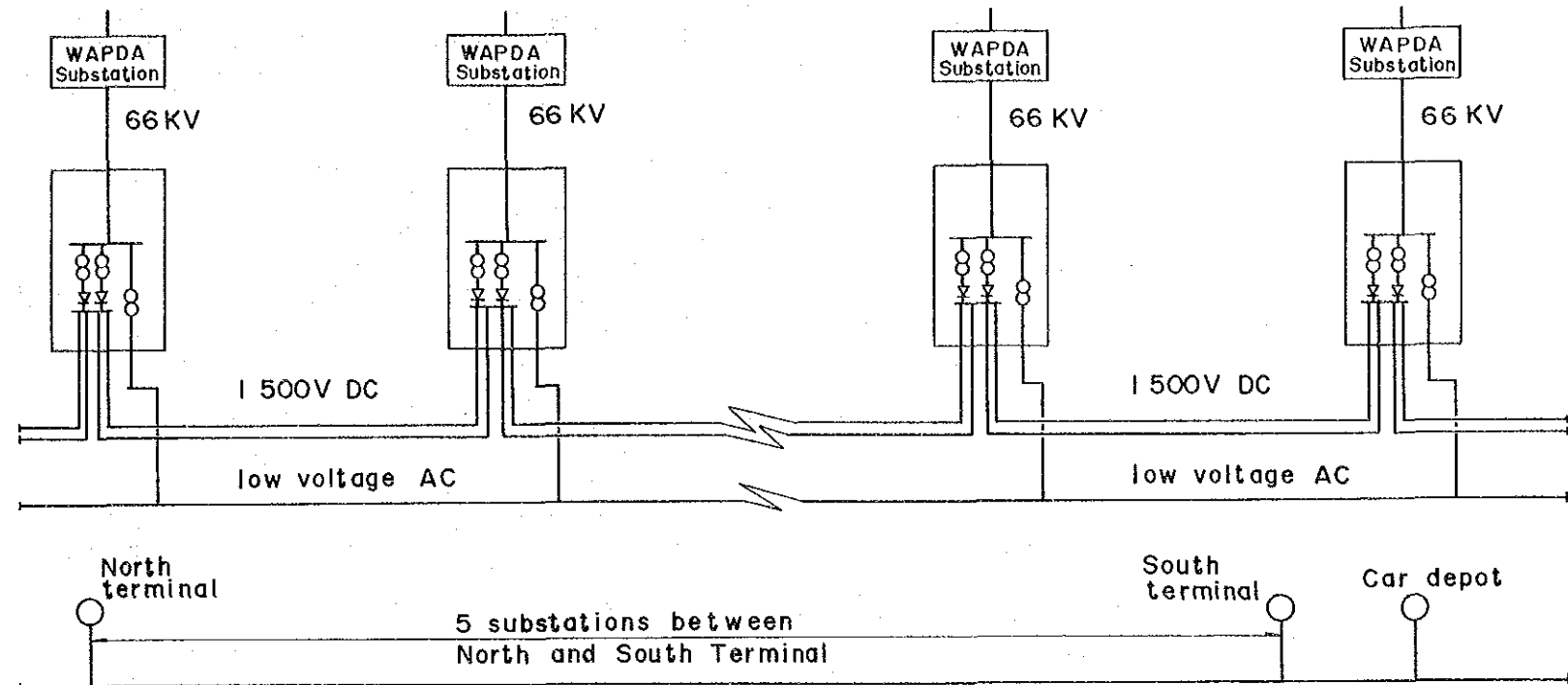

SIDE VIEW OF SIMPLE CATENARY

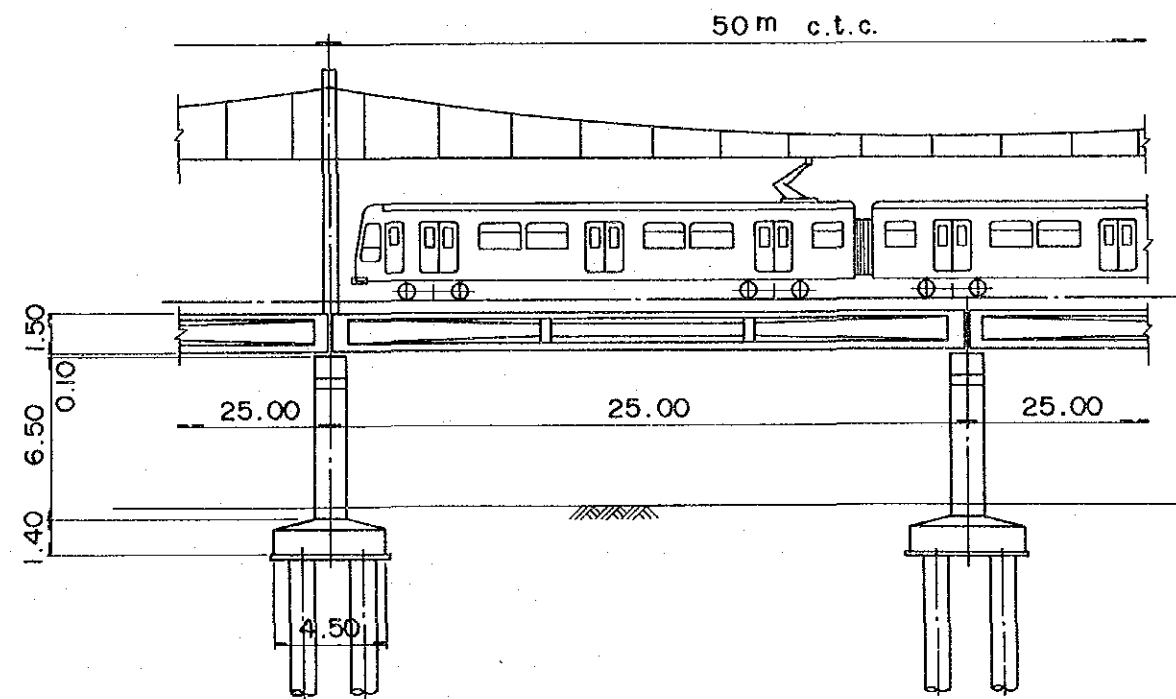

COMPREHENSIVE STUDY ON
TRANSPORTATION SYSTEM IN LAHORE
JICA-TEPA-LDA

ELECTRIC POWER
SUPPLY SYSTEM
Scale 1:100, 1:200

DWG NO.
22

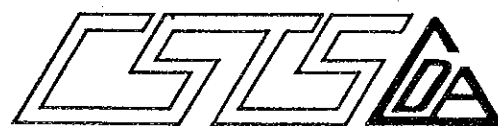
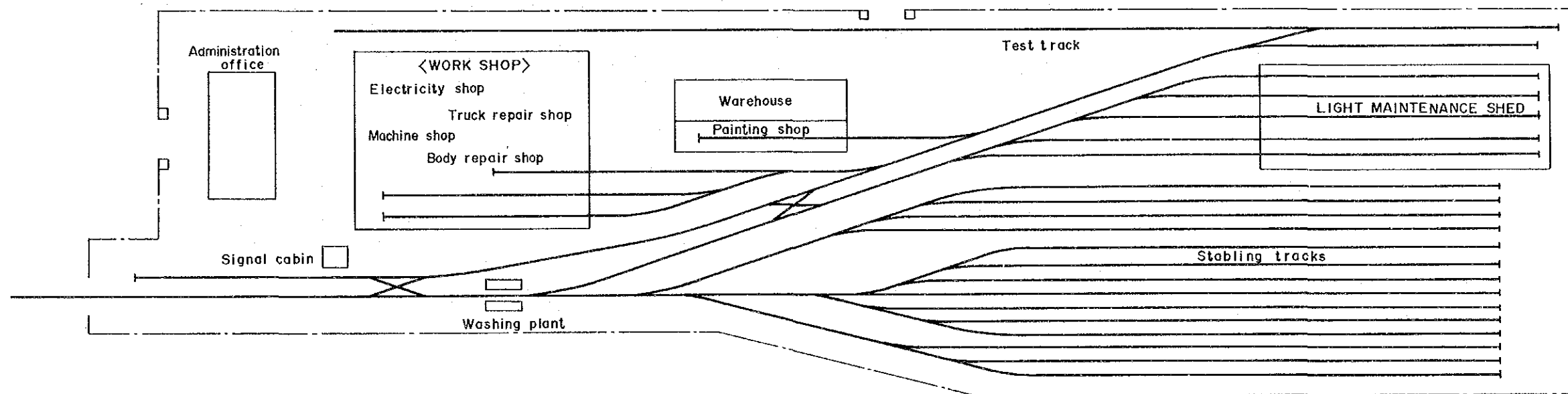

COMPREHENSIVE STUDY ON
TRANSPORTATION SYSTEM IN LAHORE
JICA-TEPA-LDA

RAILCAR DEPOT

Scale 1:5 000

DWG NO.

23

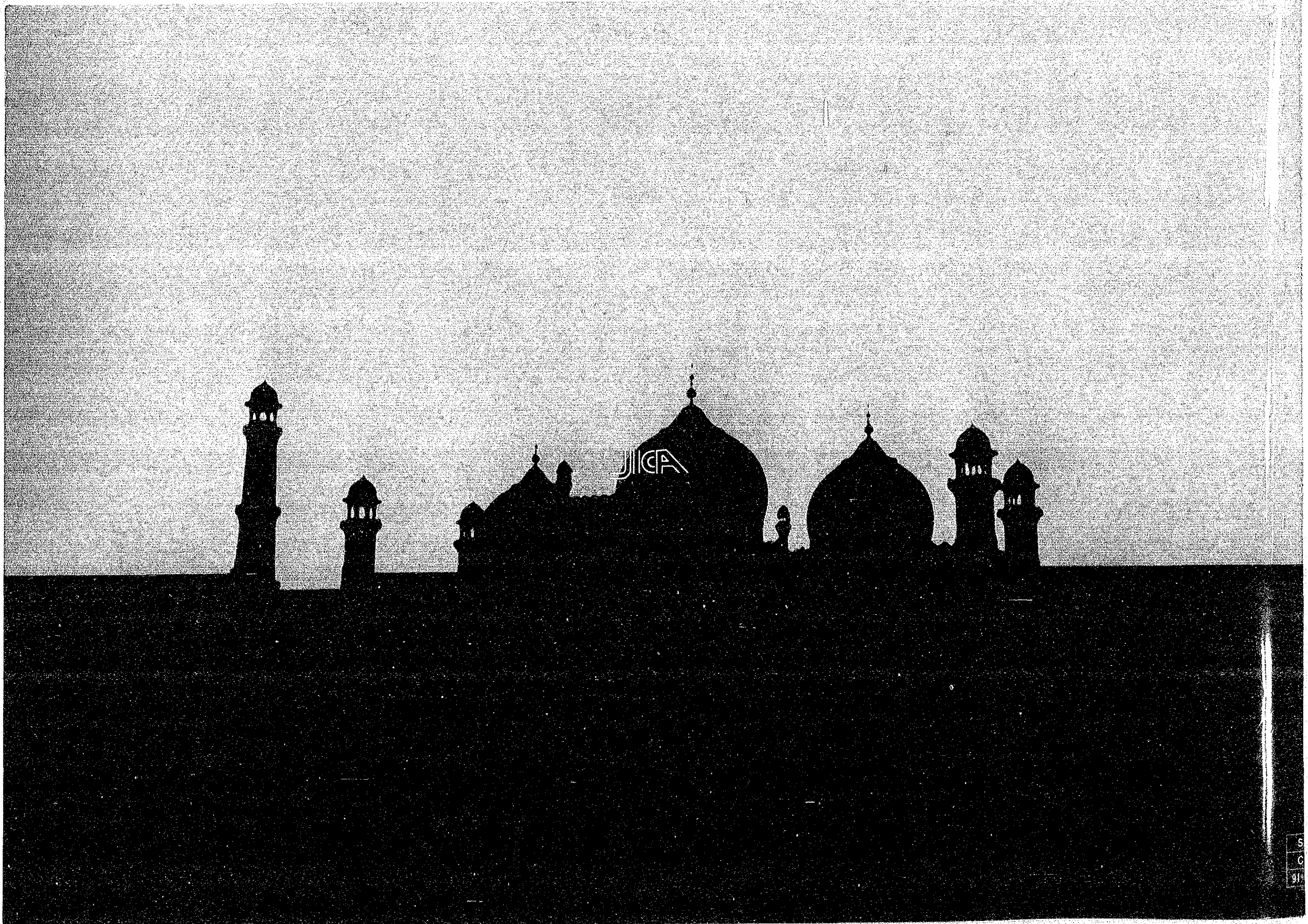

JICA