

The Locations of Investigation & The Topographical Feature

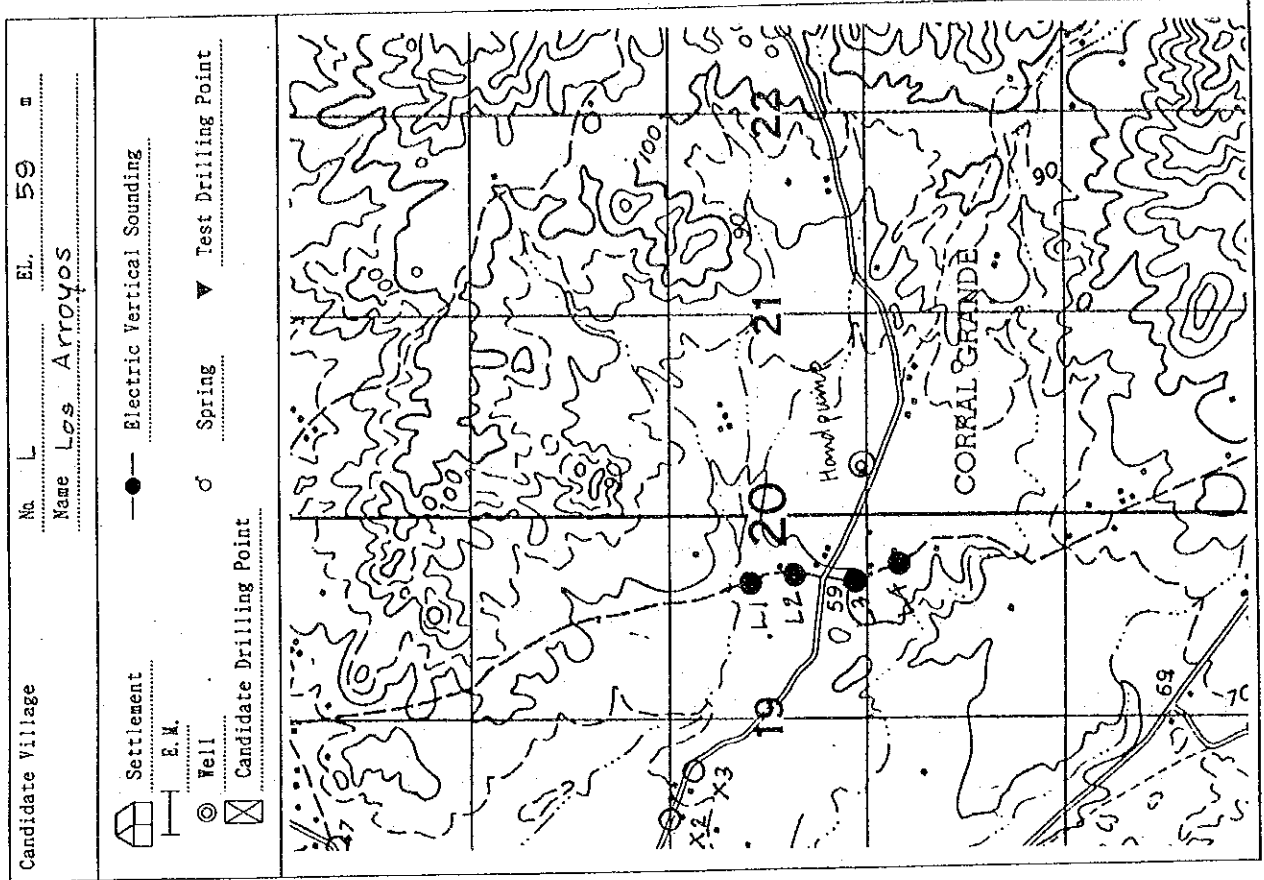

Line L

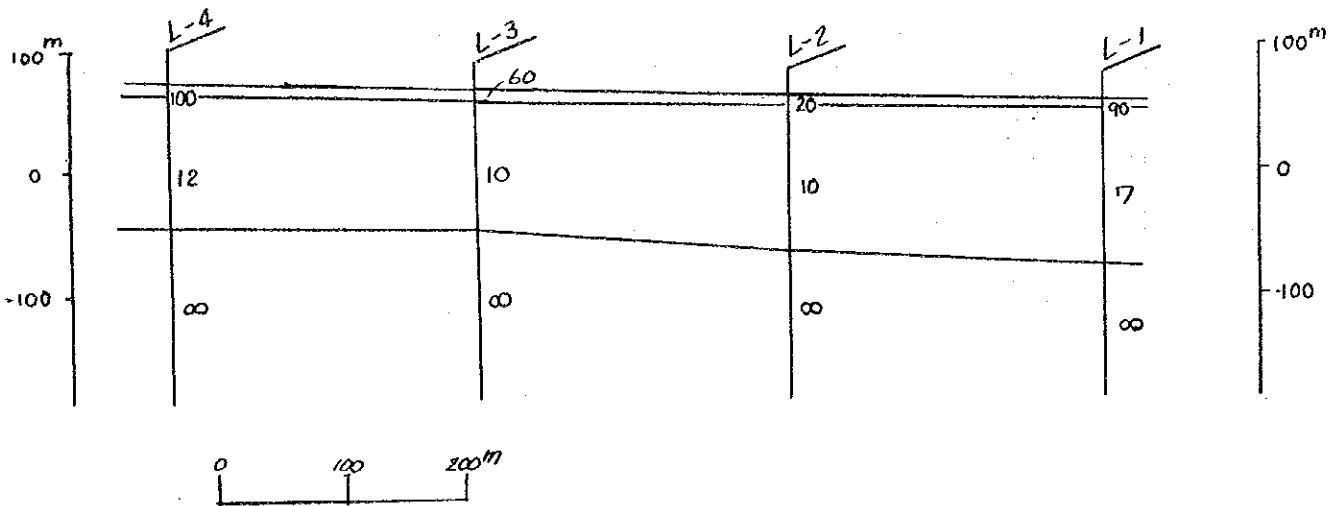

The Locations of Investigation & The Topographical Feature

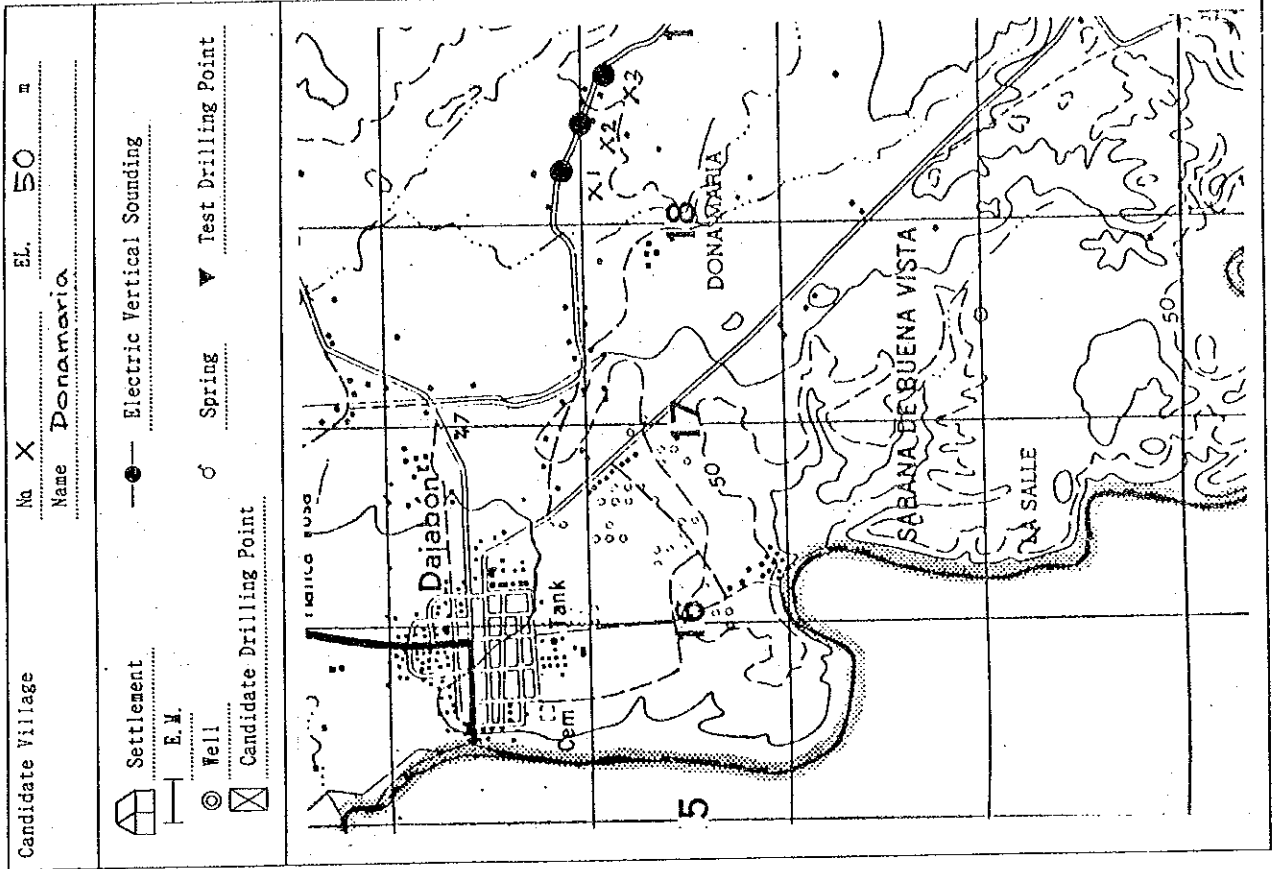

Line X

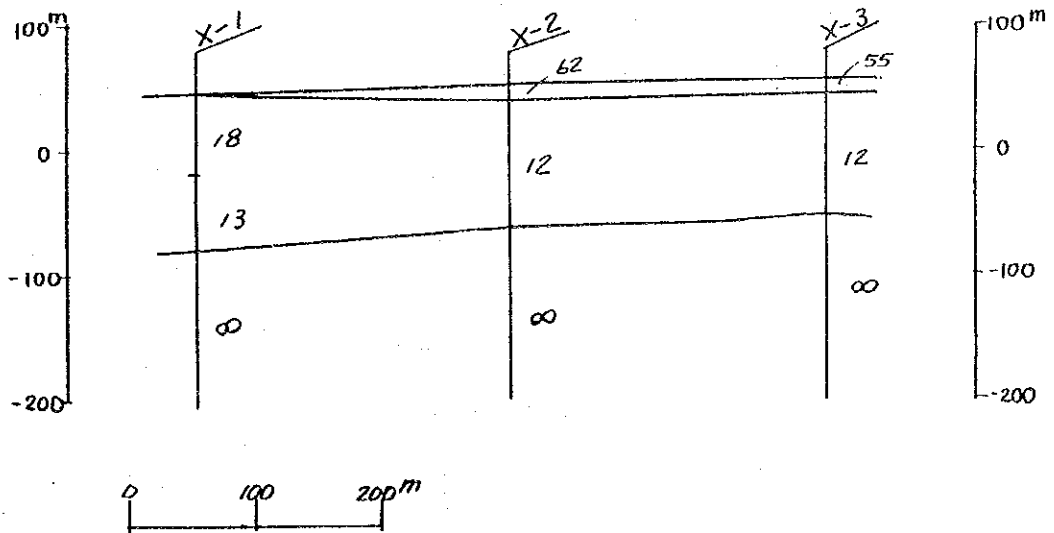

The Locations of Investigation & The Topographical Feature

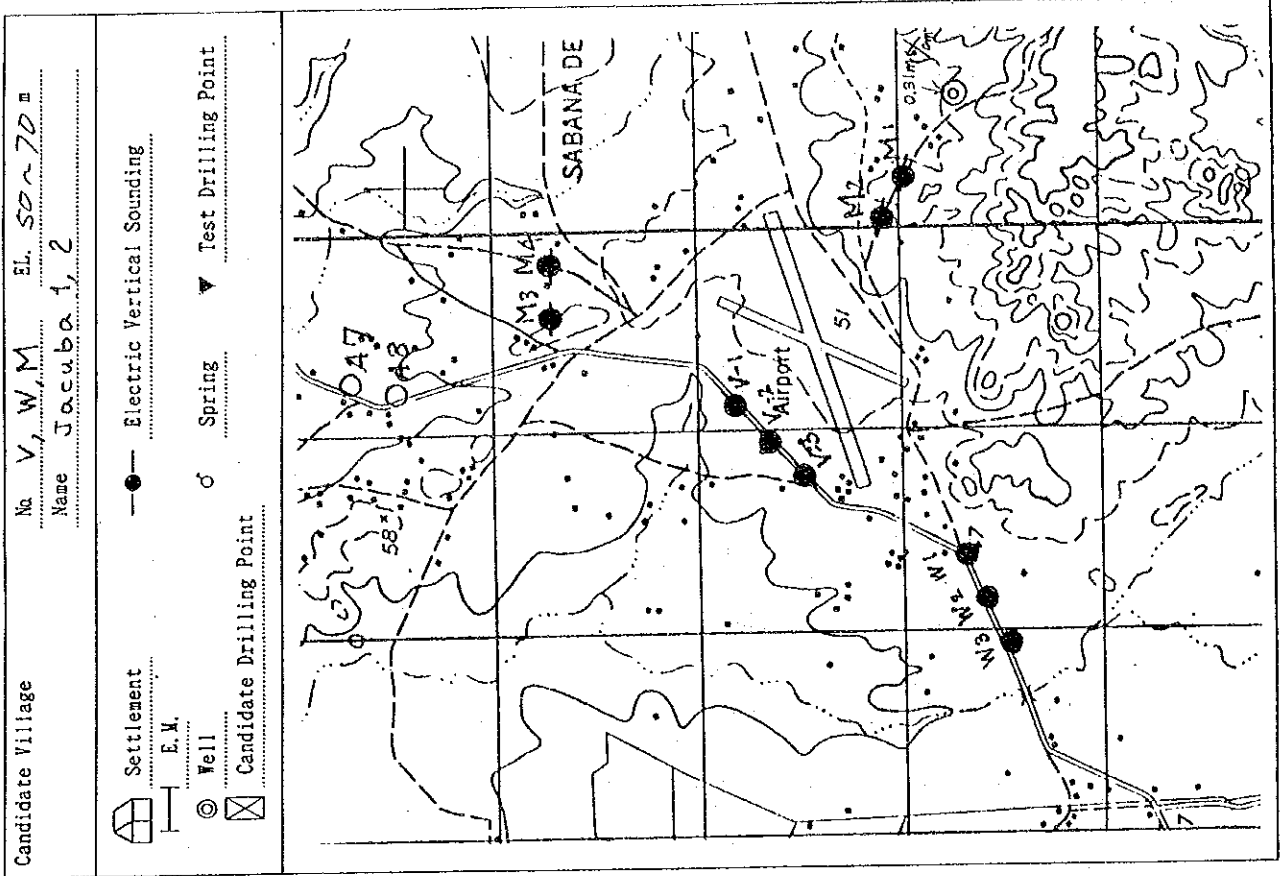

Line V

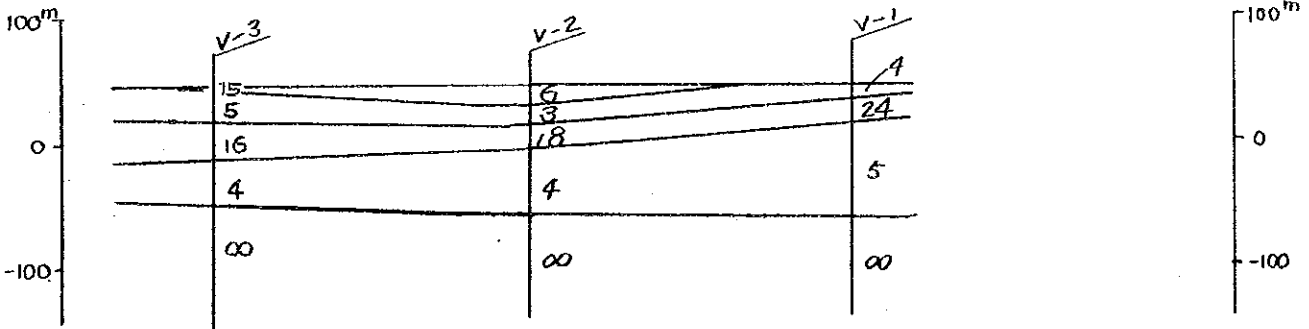

Line M (3,4)

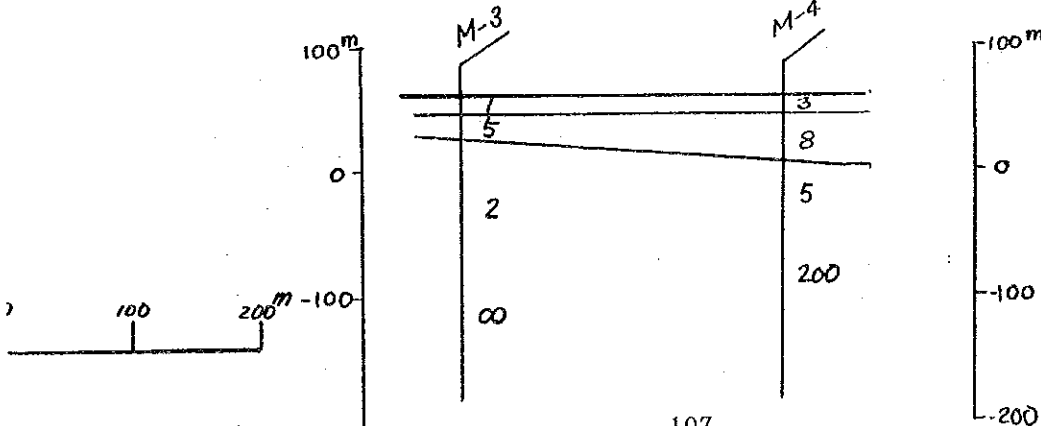

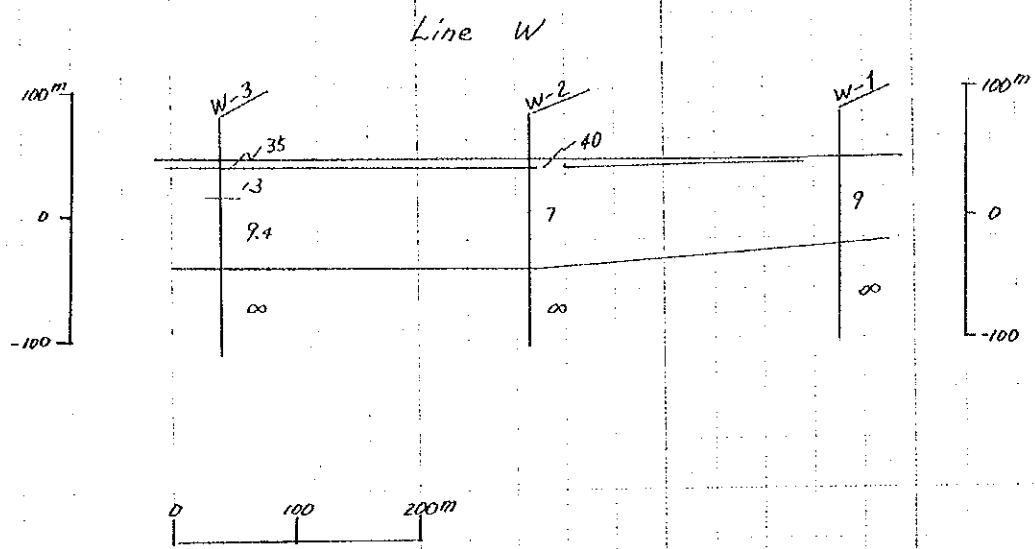

Line M (1,2)

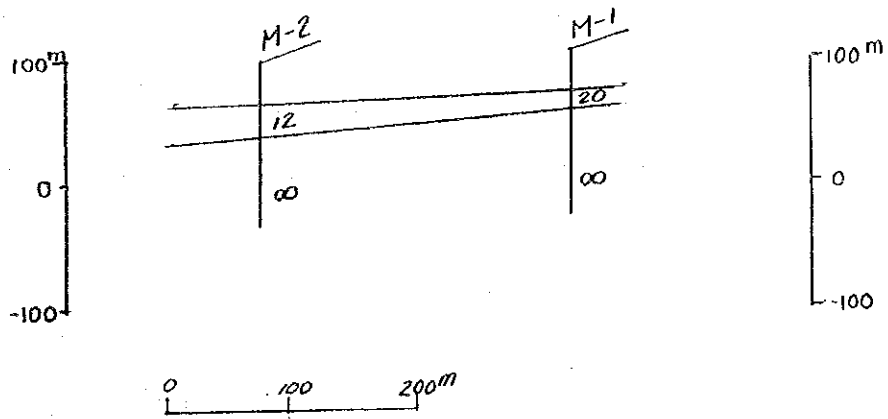

The Locations of Investigation & The Topographical Feature

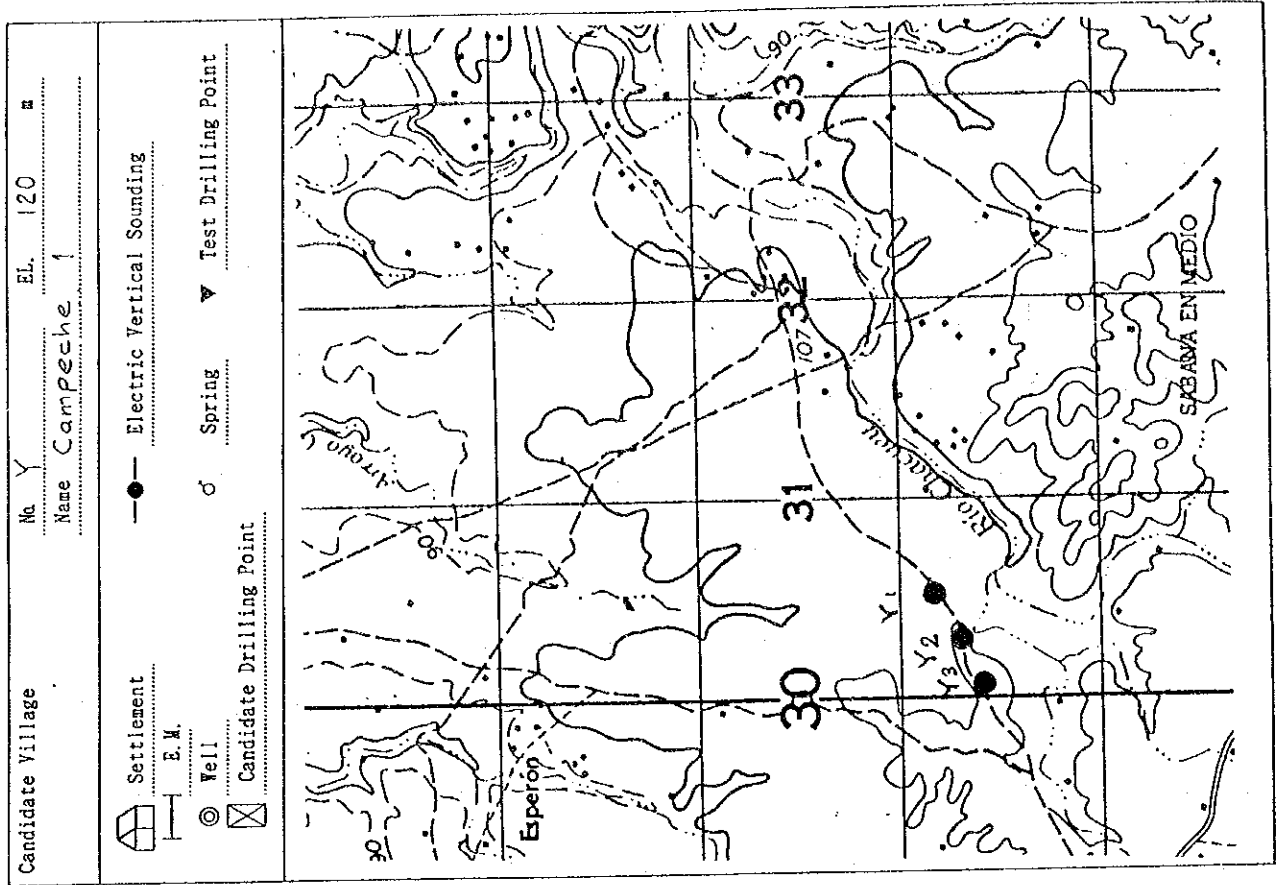

Line Y

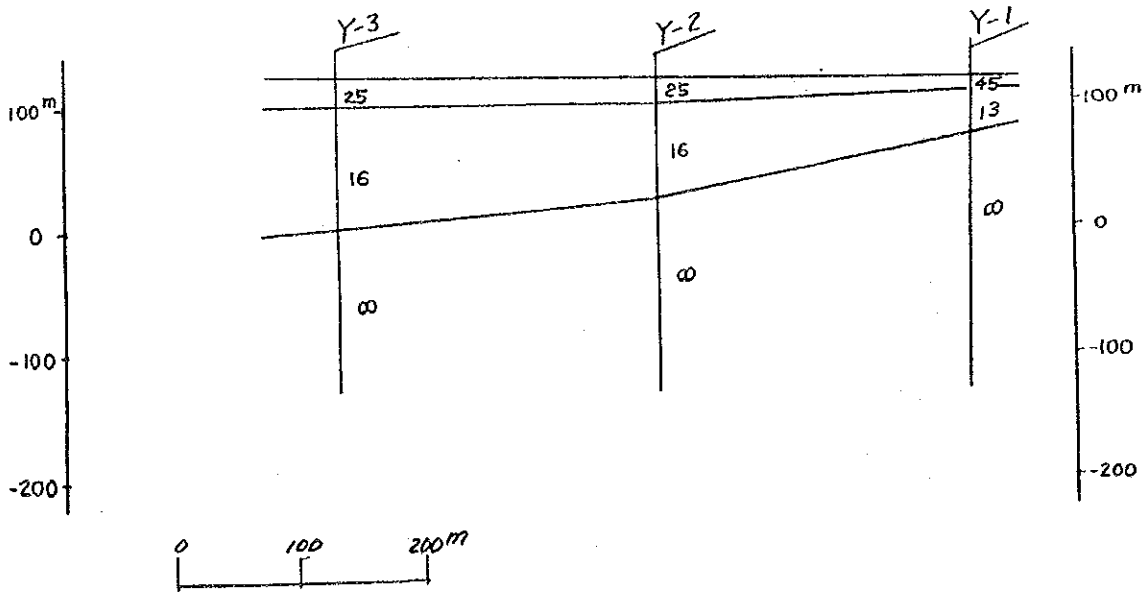

407

The Locations of Investigation & The Topographical Feature

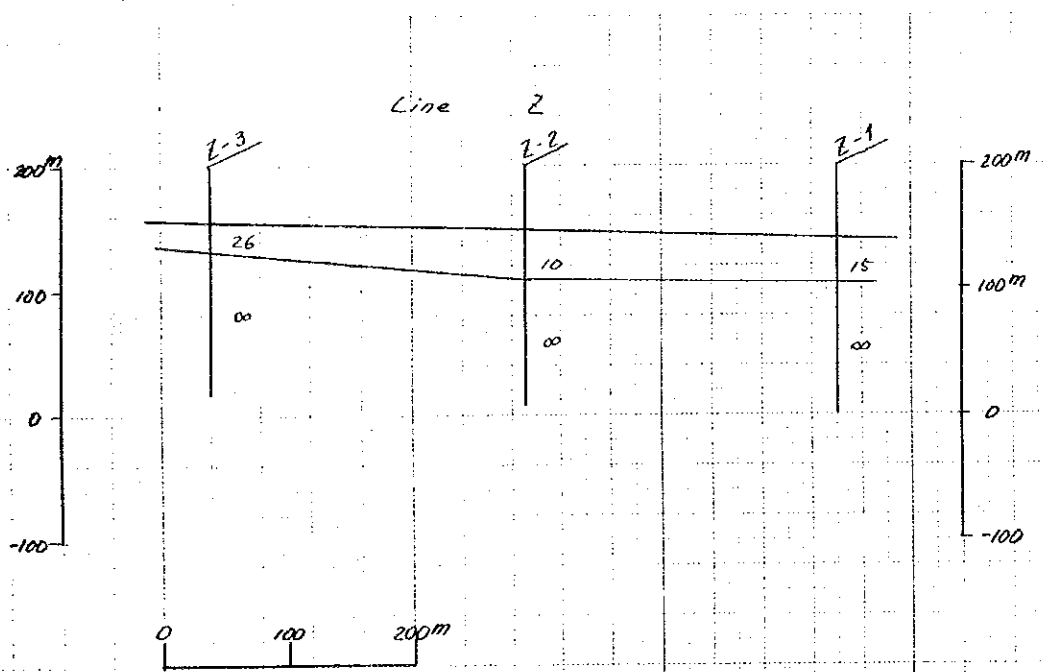
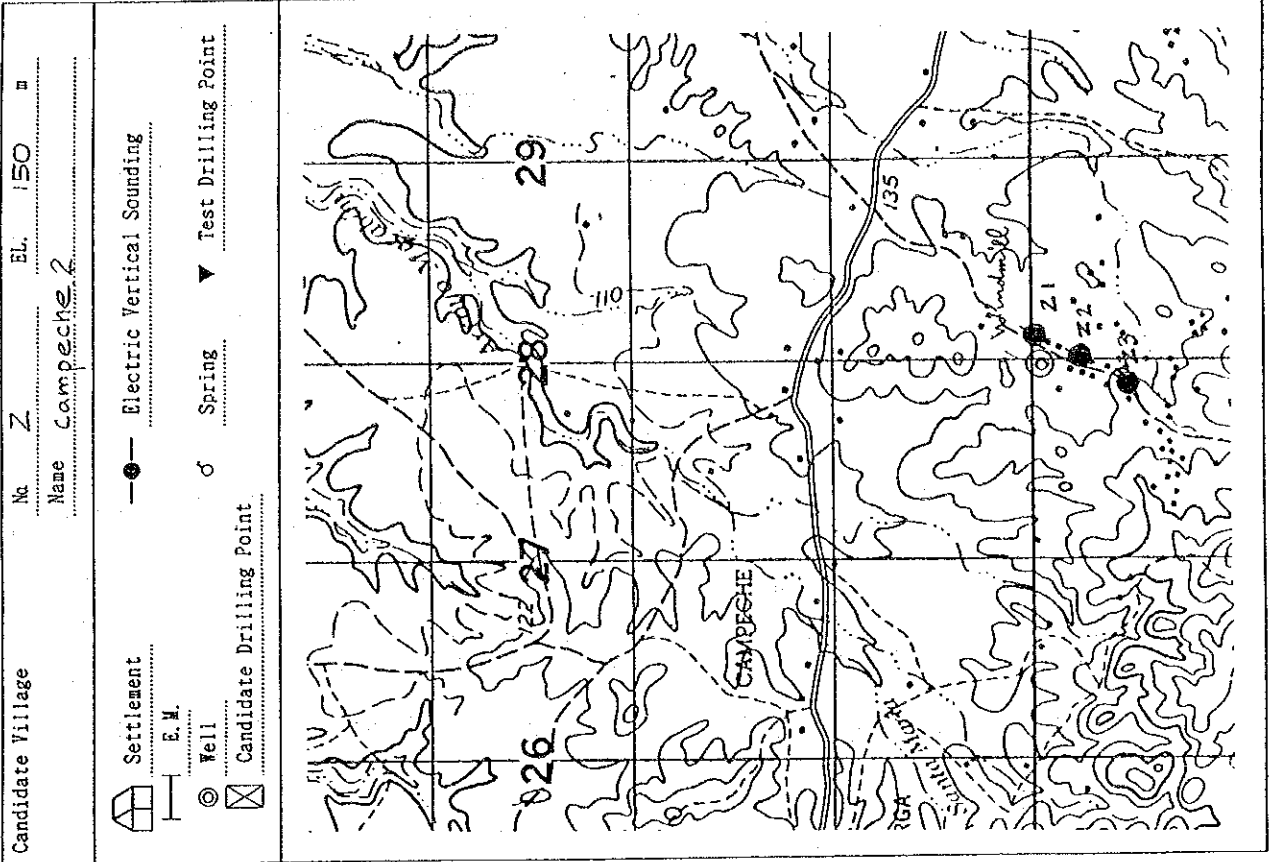

100



The Locations of Investigation & The Topographical Feature

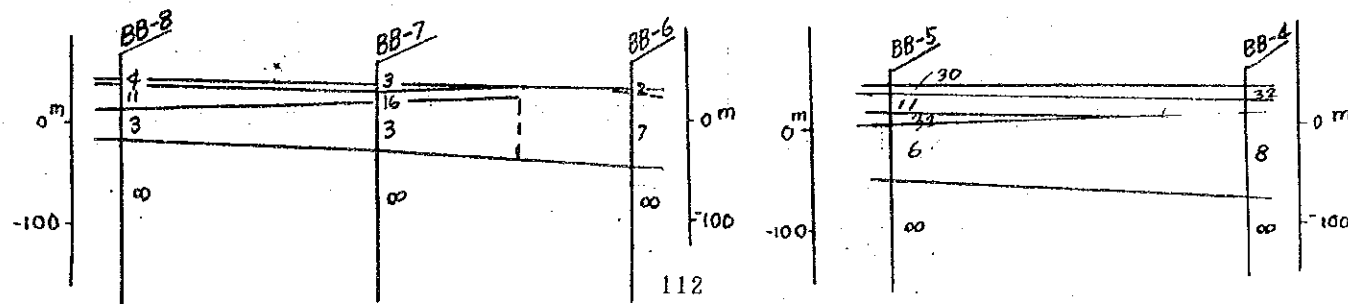
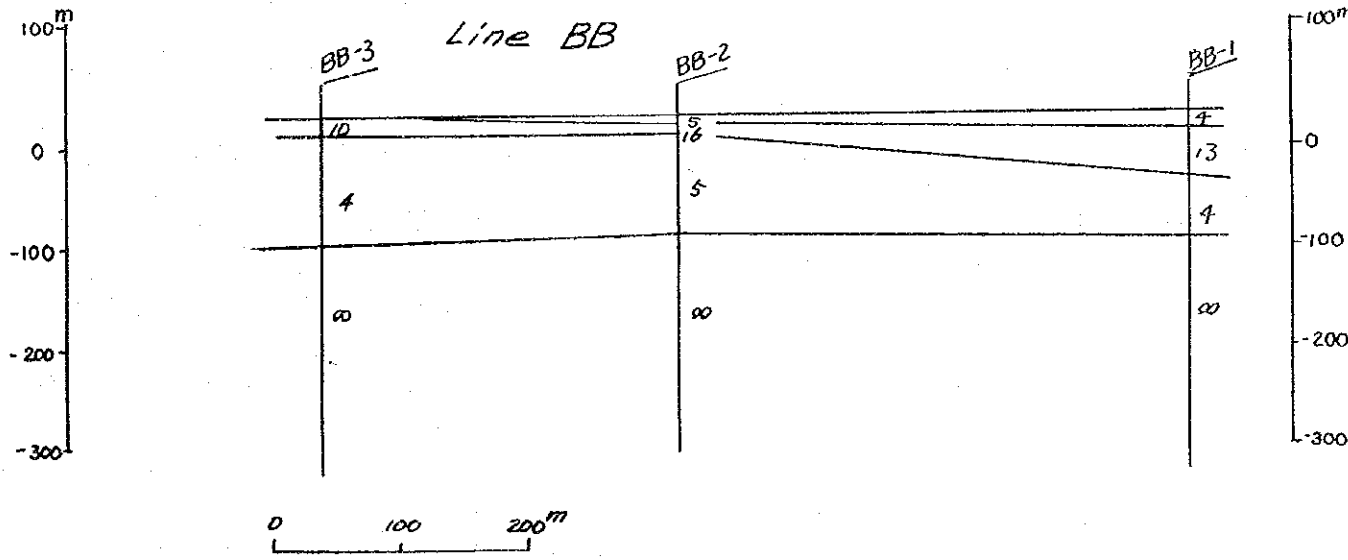
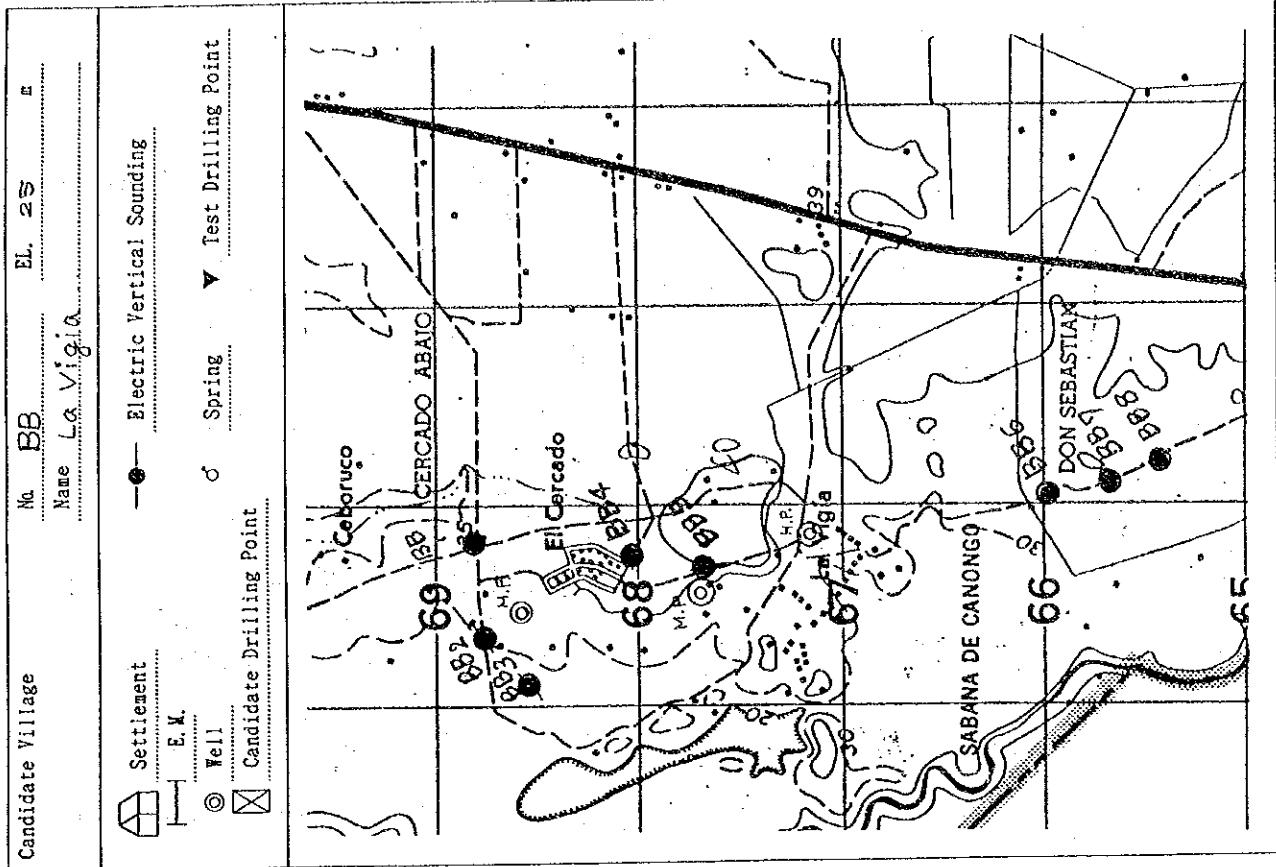

Est



The Locations of Investigation & The Topographical Feature

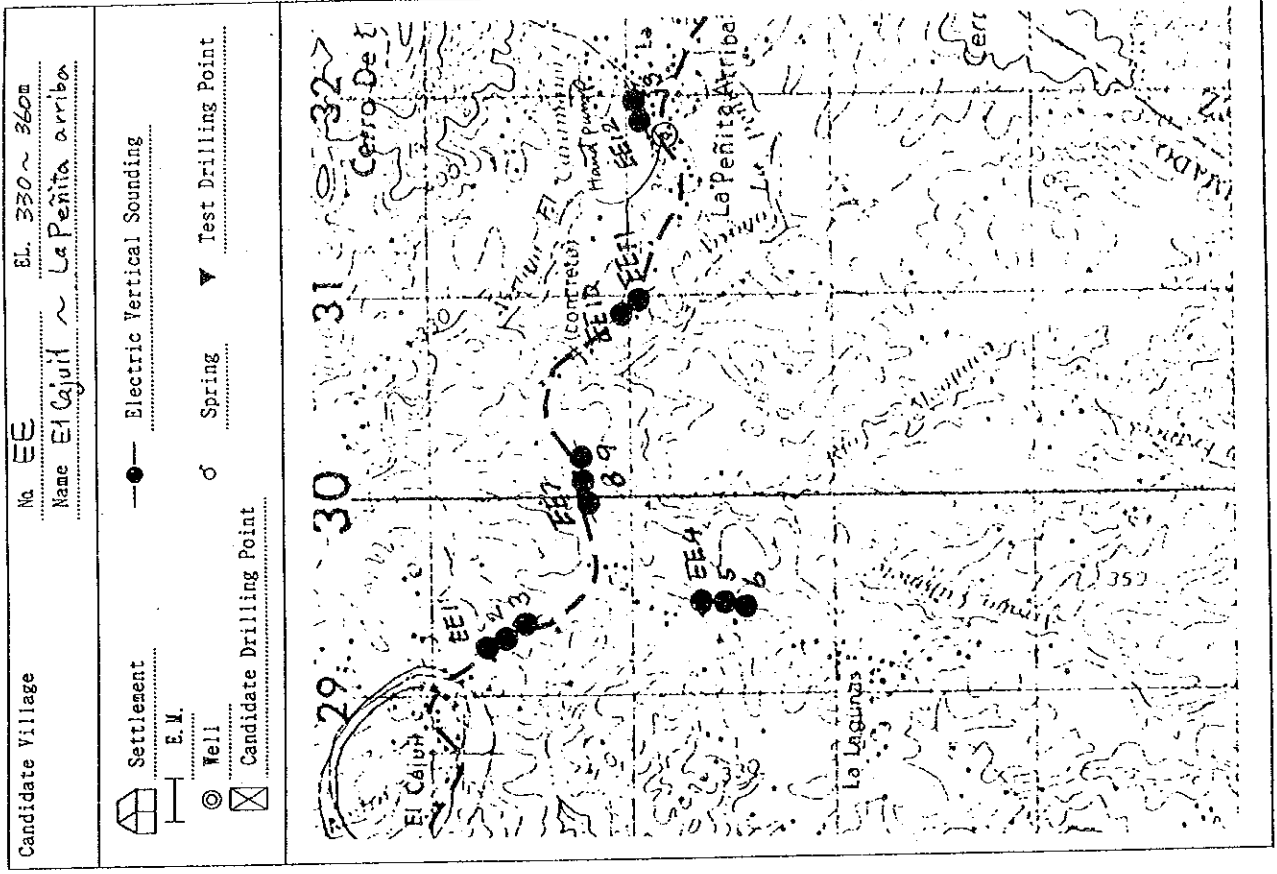

Line EE

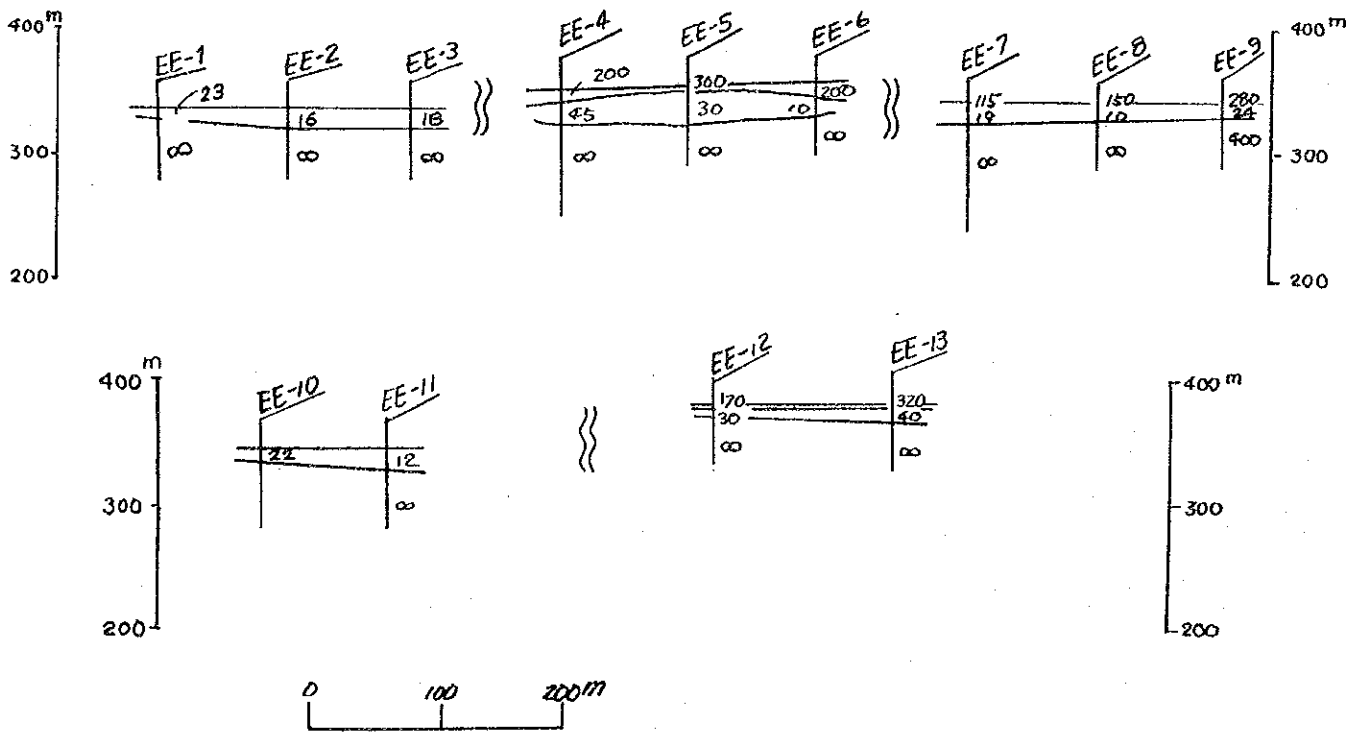





The Locations of Investigation & The Topographical Feature



Candidate Village

No. **FF, EM-4** EL. **280**

Name **El Aguacate**

---

 Settlement  
 E.V.  
 Well  
 Candidate Drilling Point

 Electric Vertical Sounding  
 Spring  
 Test Drilling Point

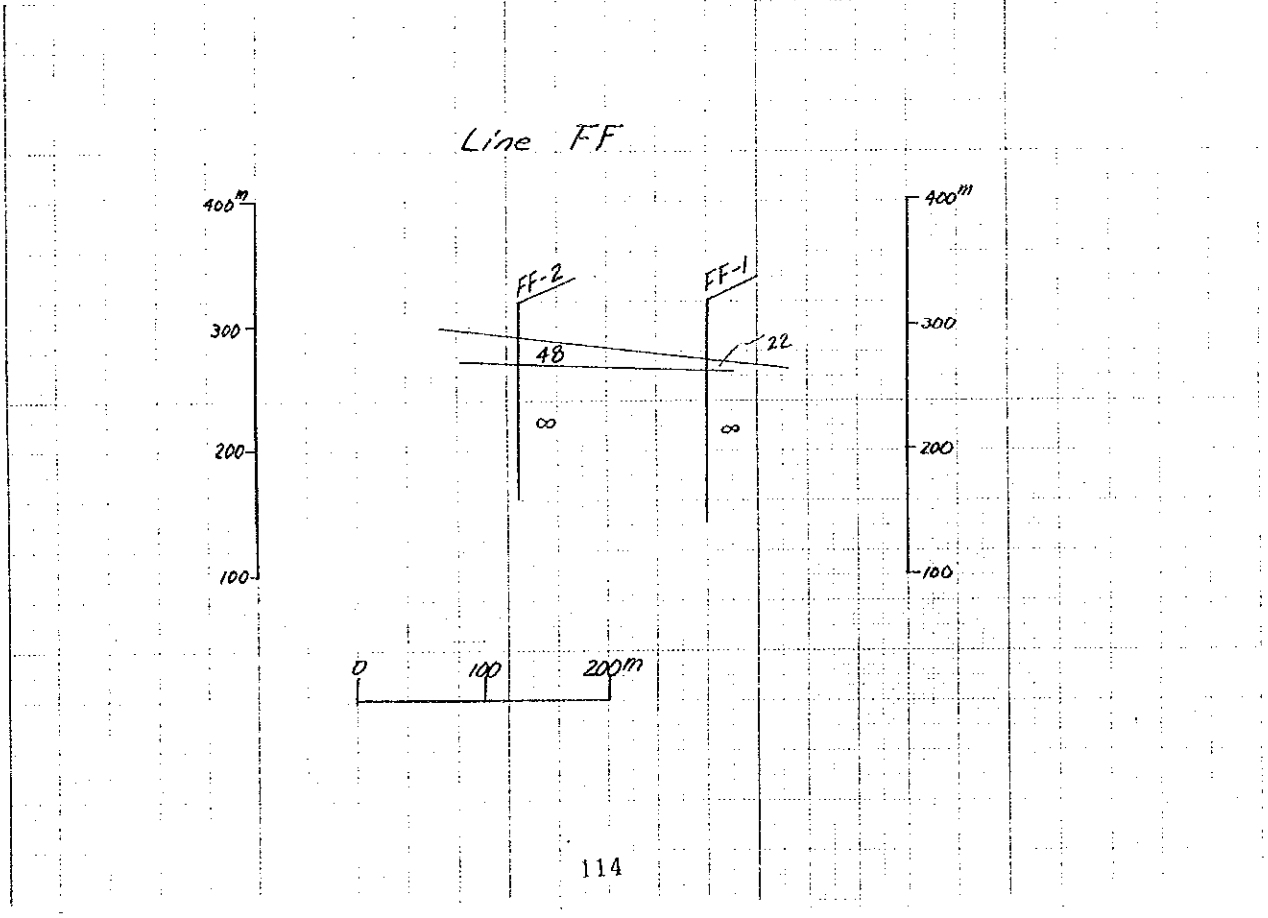
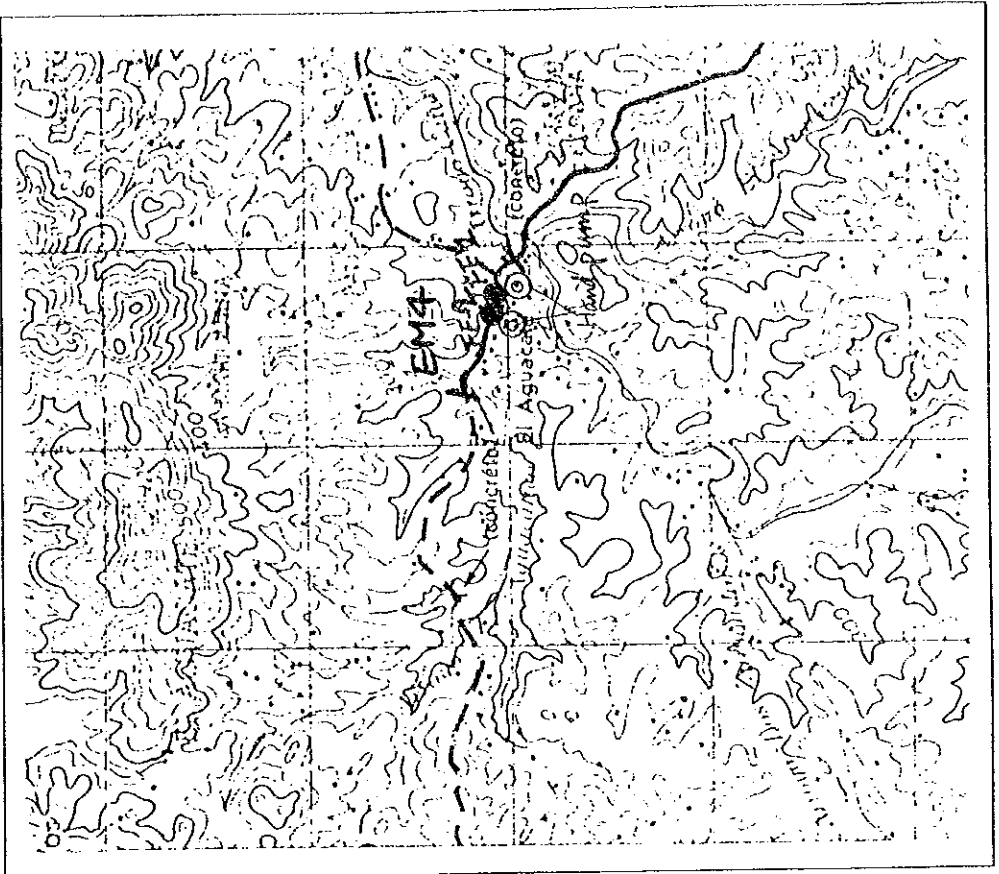

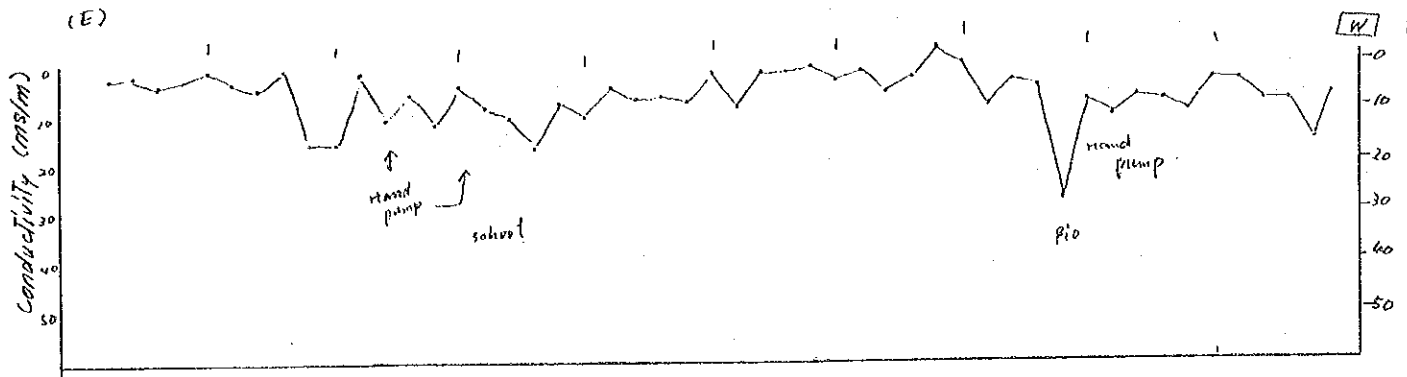

EM-9 EL AQUACATE  
 Electrode spacing 20 m  
 Station Interval 20 m

The Locations of Investigation & The Topographical Feature

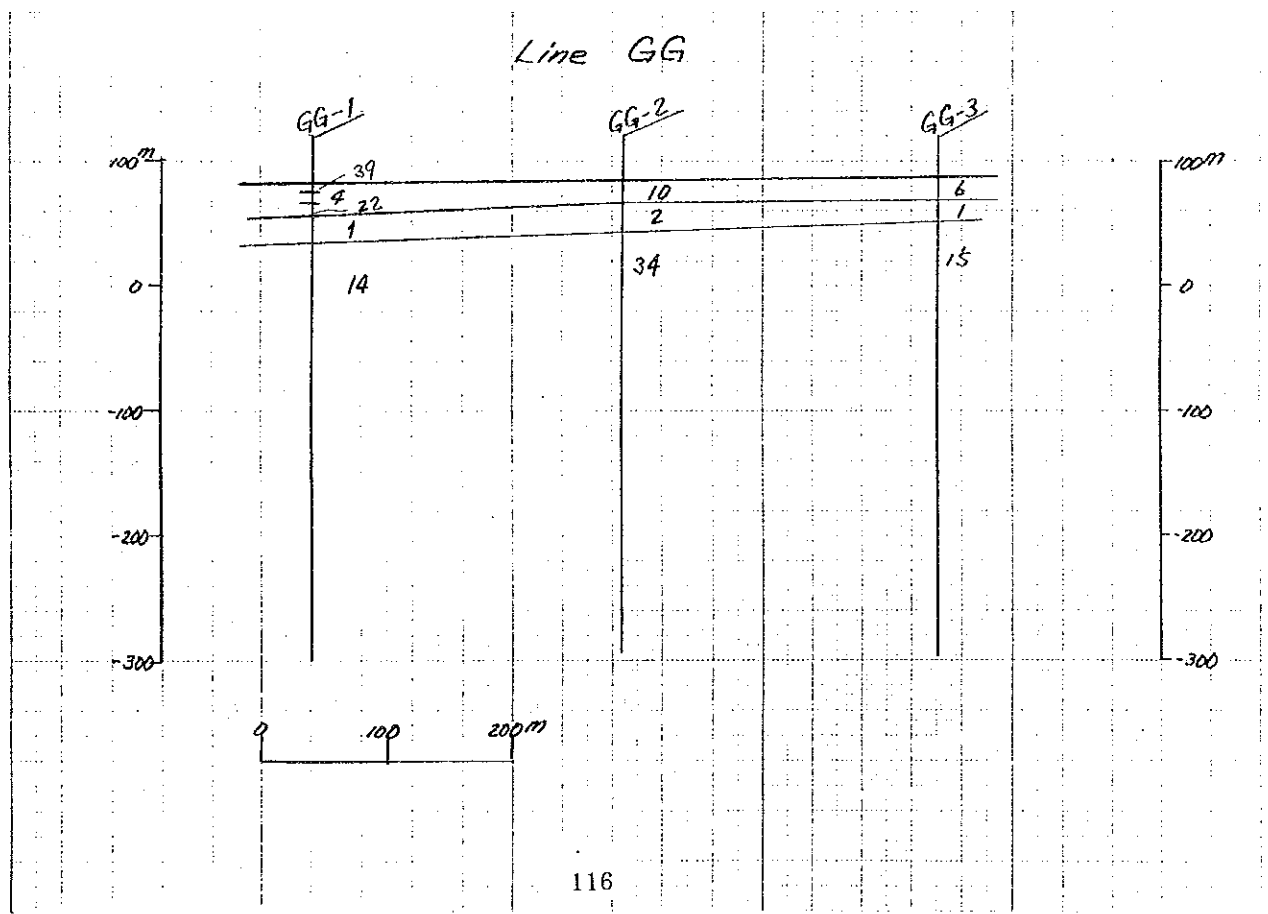
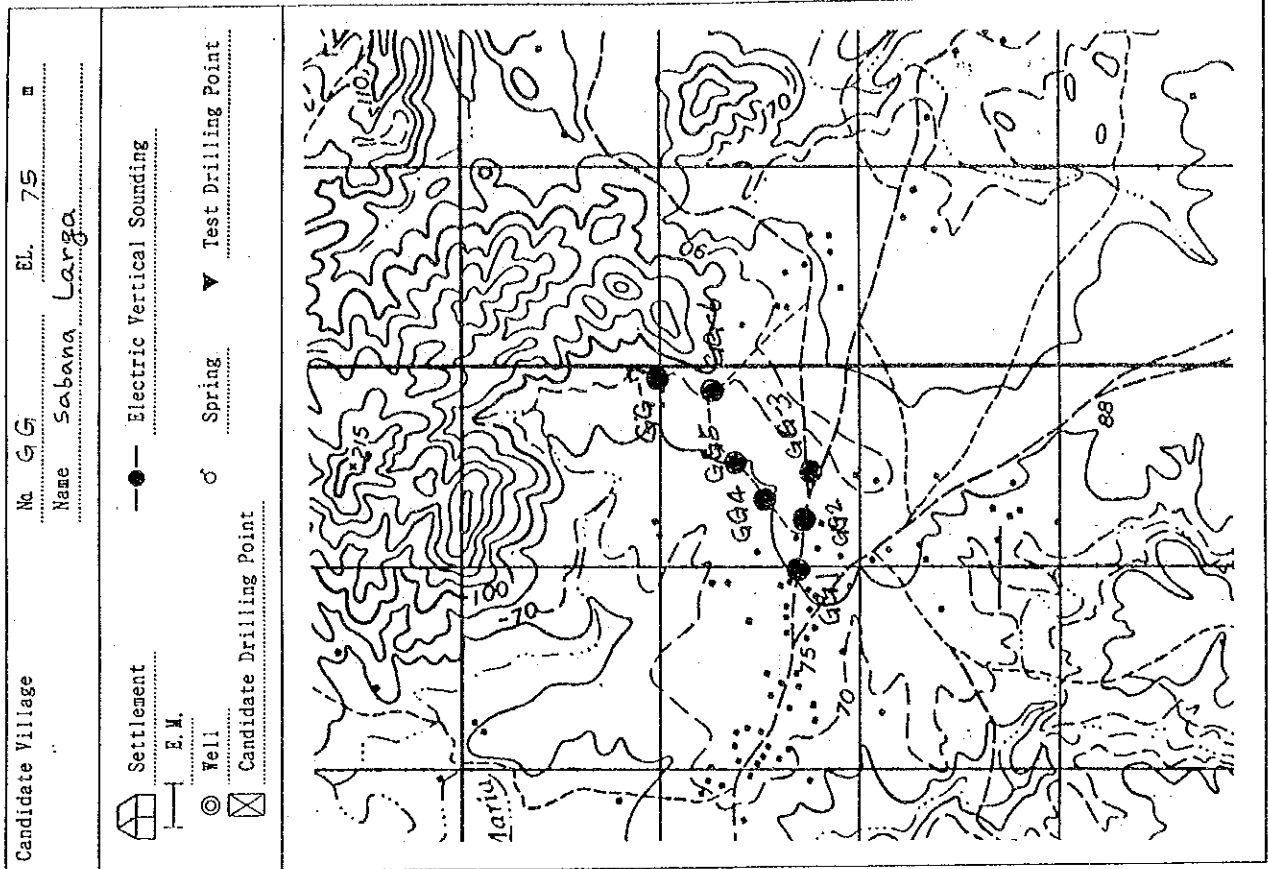

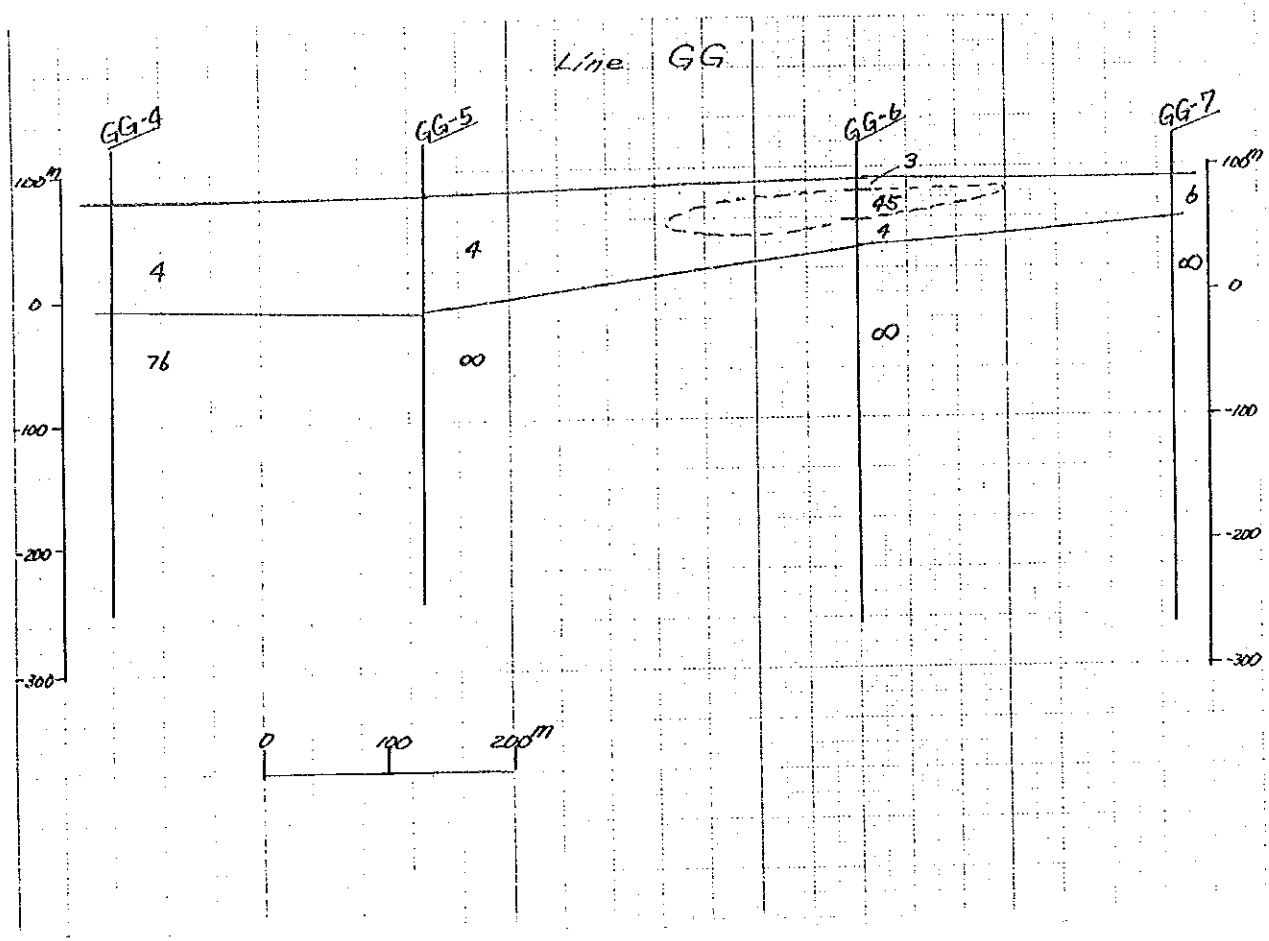

The Locations of Investigation & The Topographical Feature

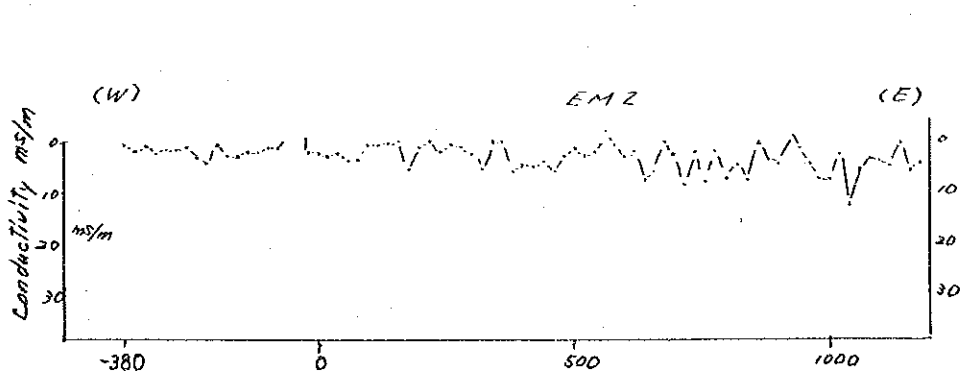
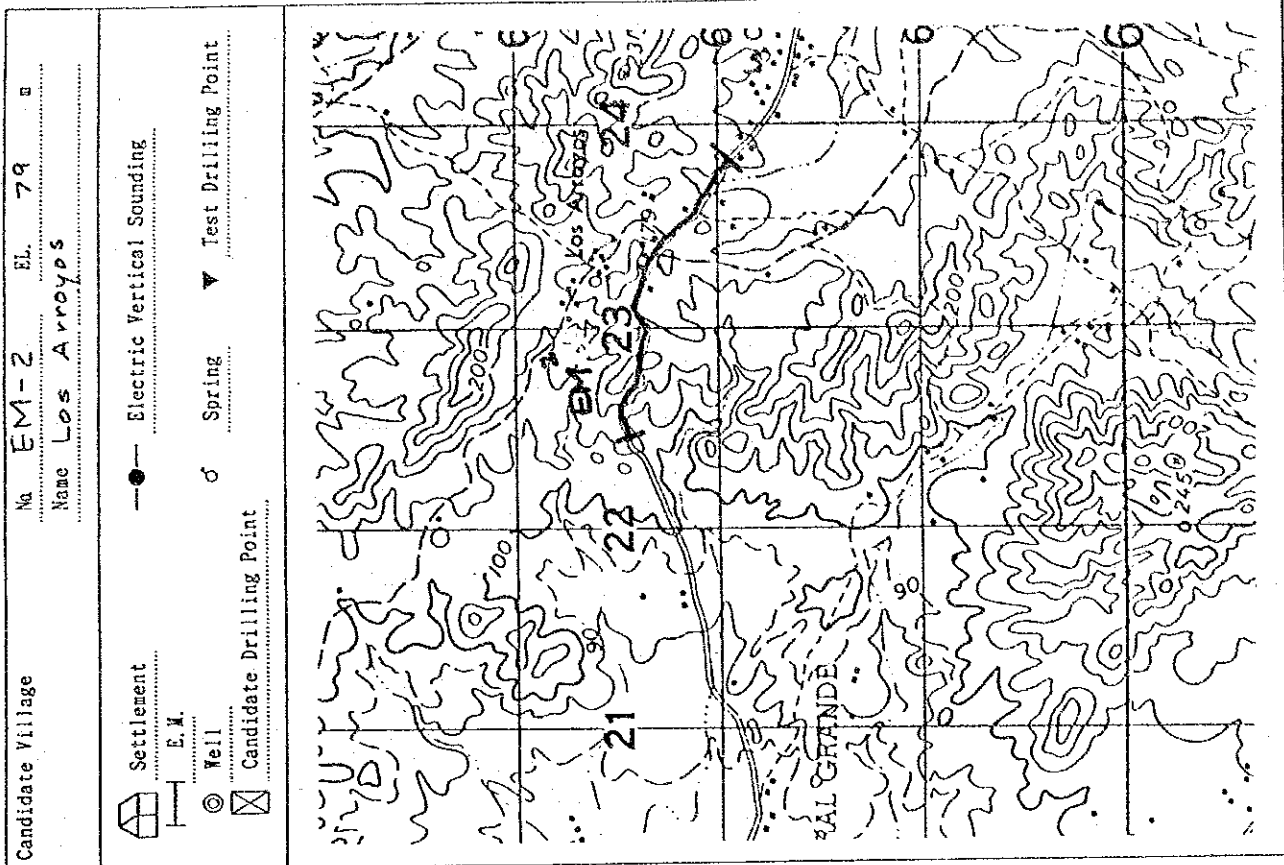

EM-2 Los Arroyos  
 Electrode Spacing 20 m  
 Station Interval 20 m

The Locations of Investigation & The Topographical Feature

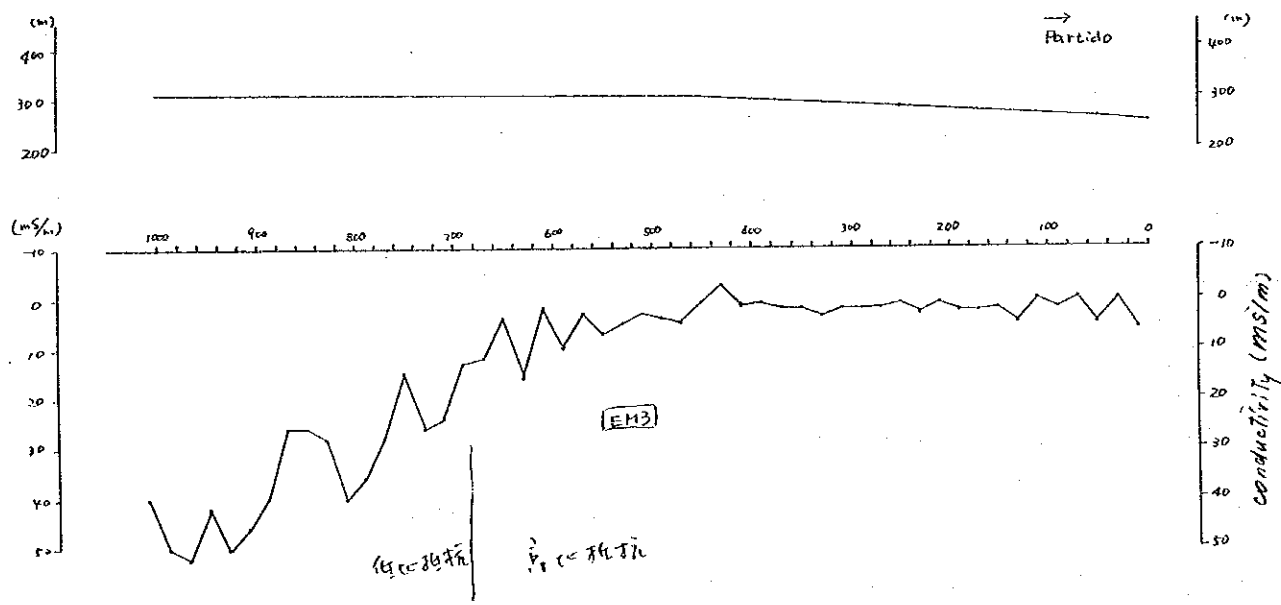
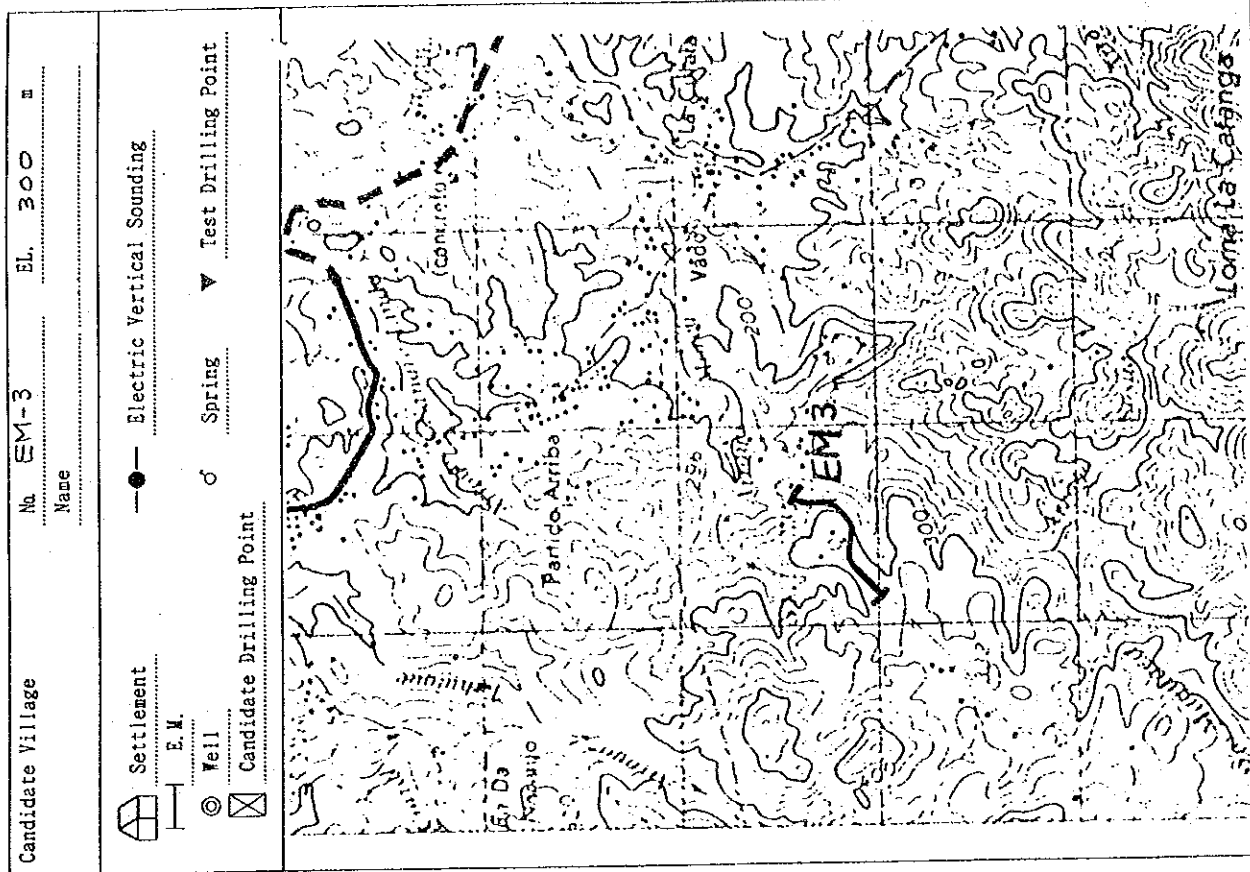

EM-3  
 Electrode Spacing 20 m  
 Station Interval 20 m

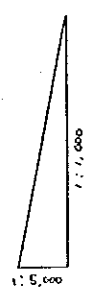

The Locations of Investigation & The Topographical Feature

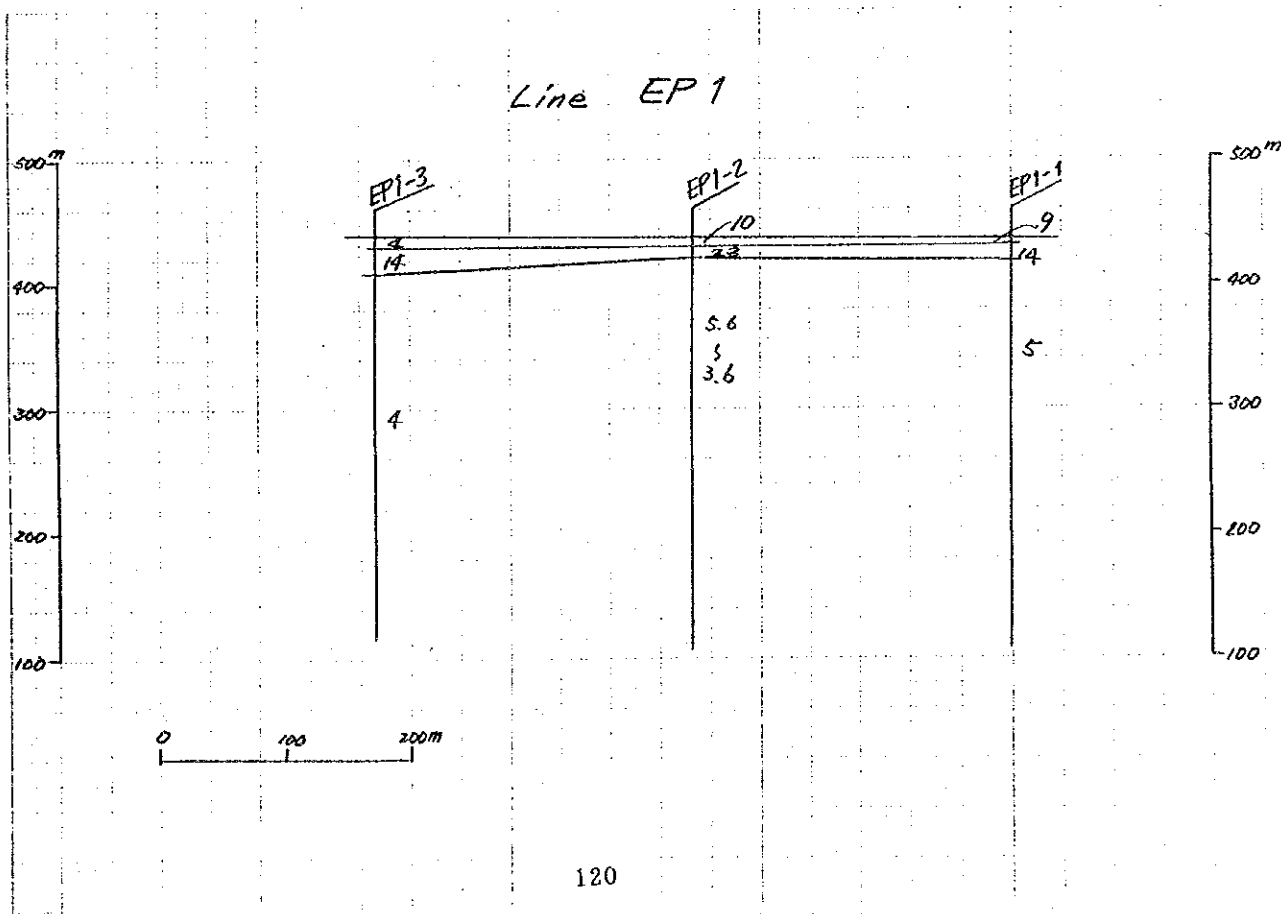
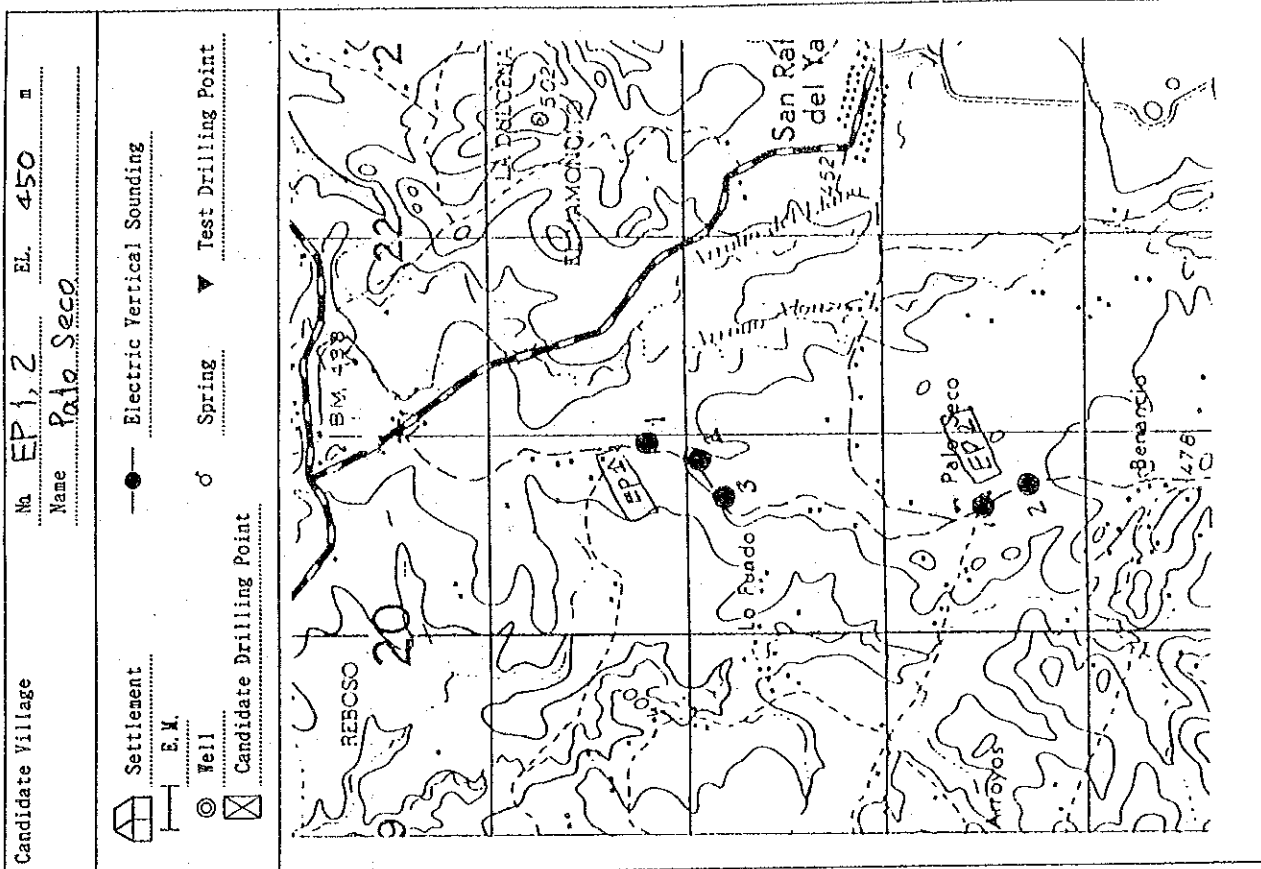



Line EP2

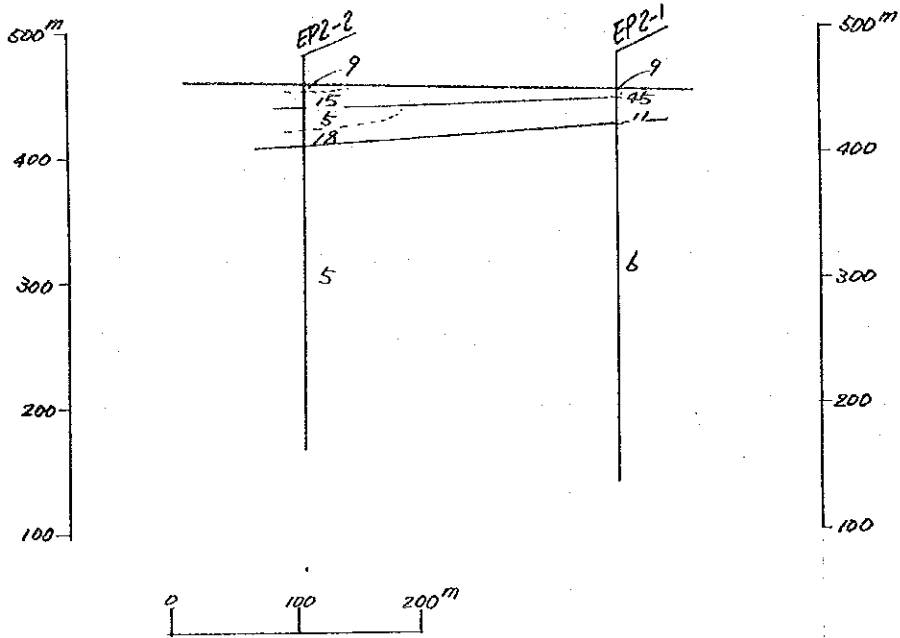

The Locations of Investigation & The Topographical Feature

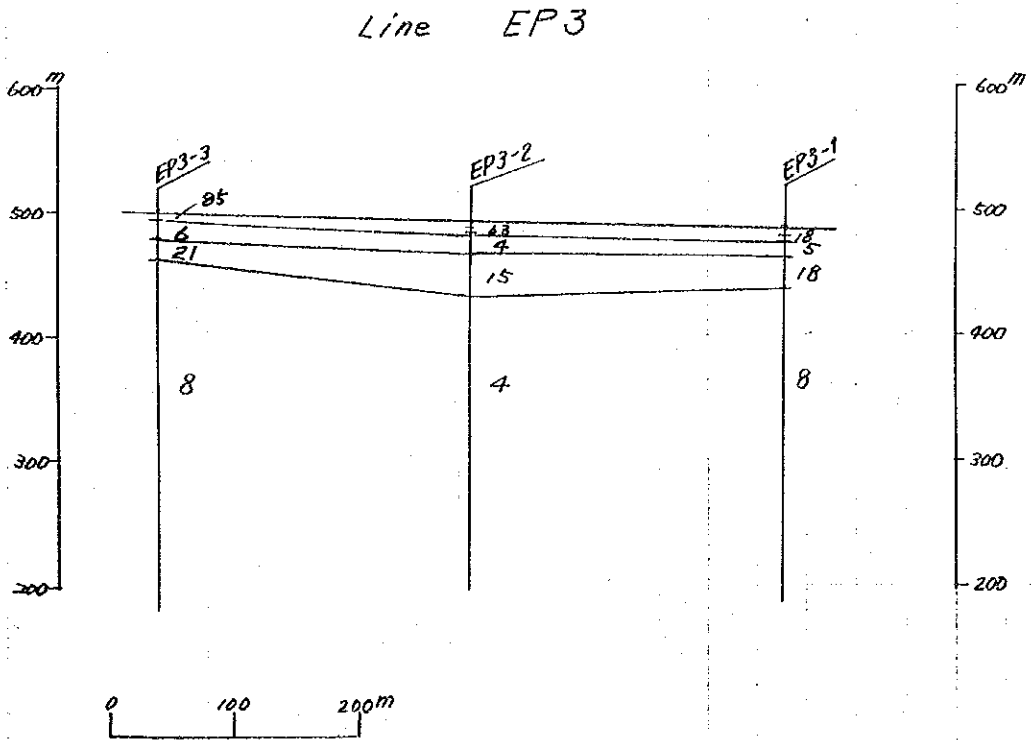
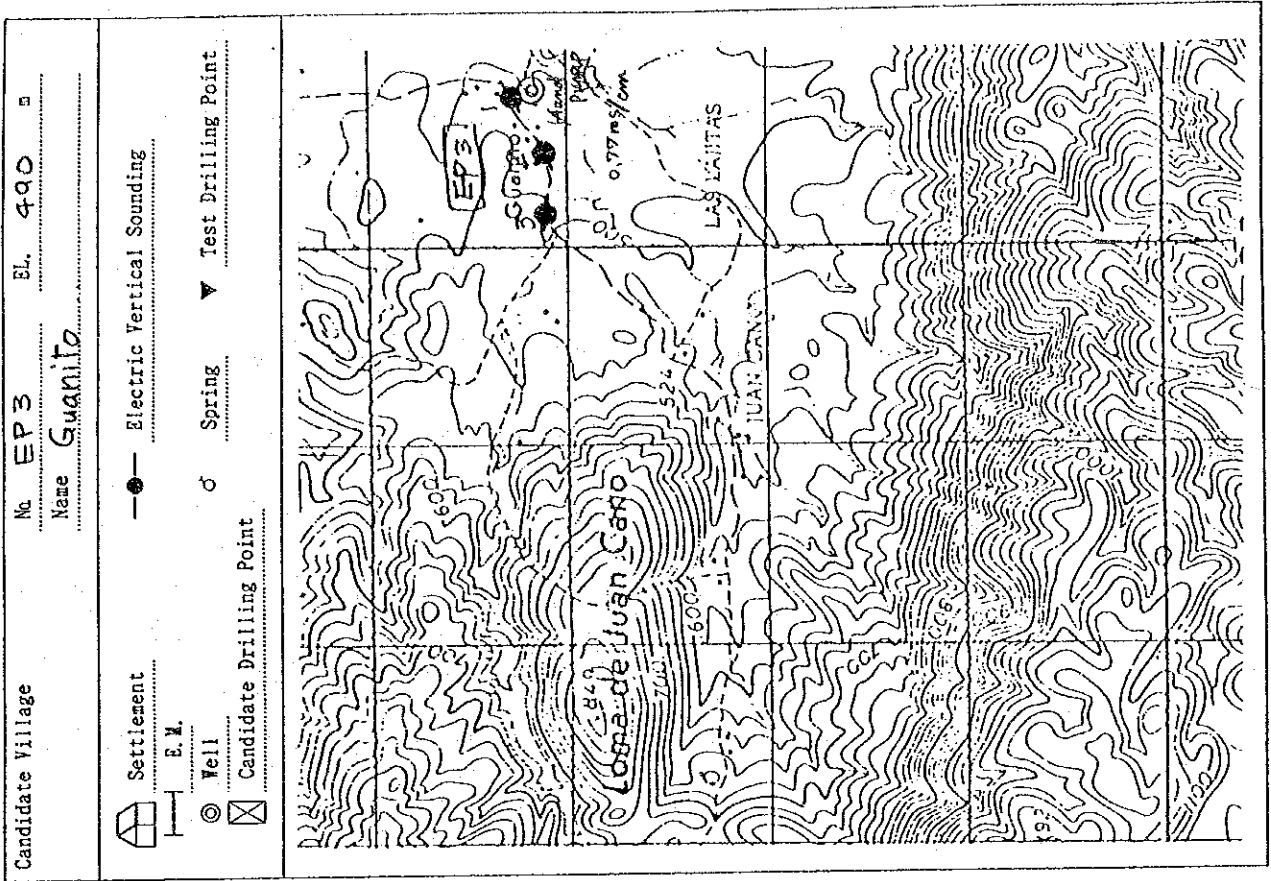

EP3

The Locations of Investigation & The Topographical Feature

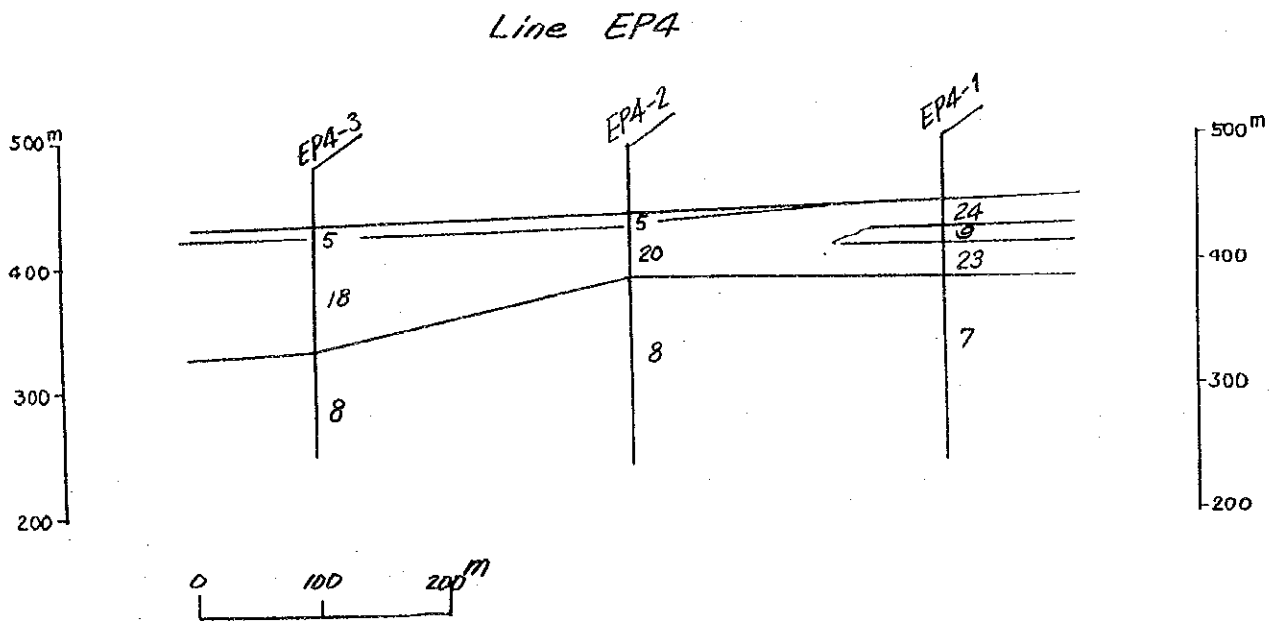
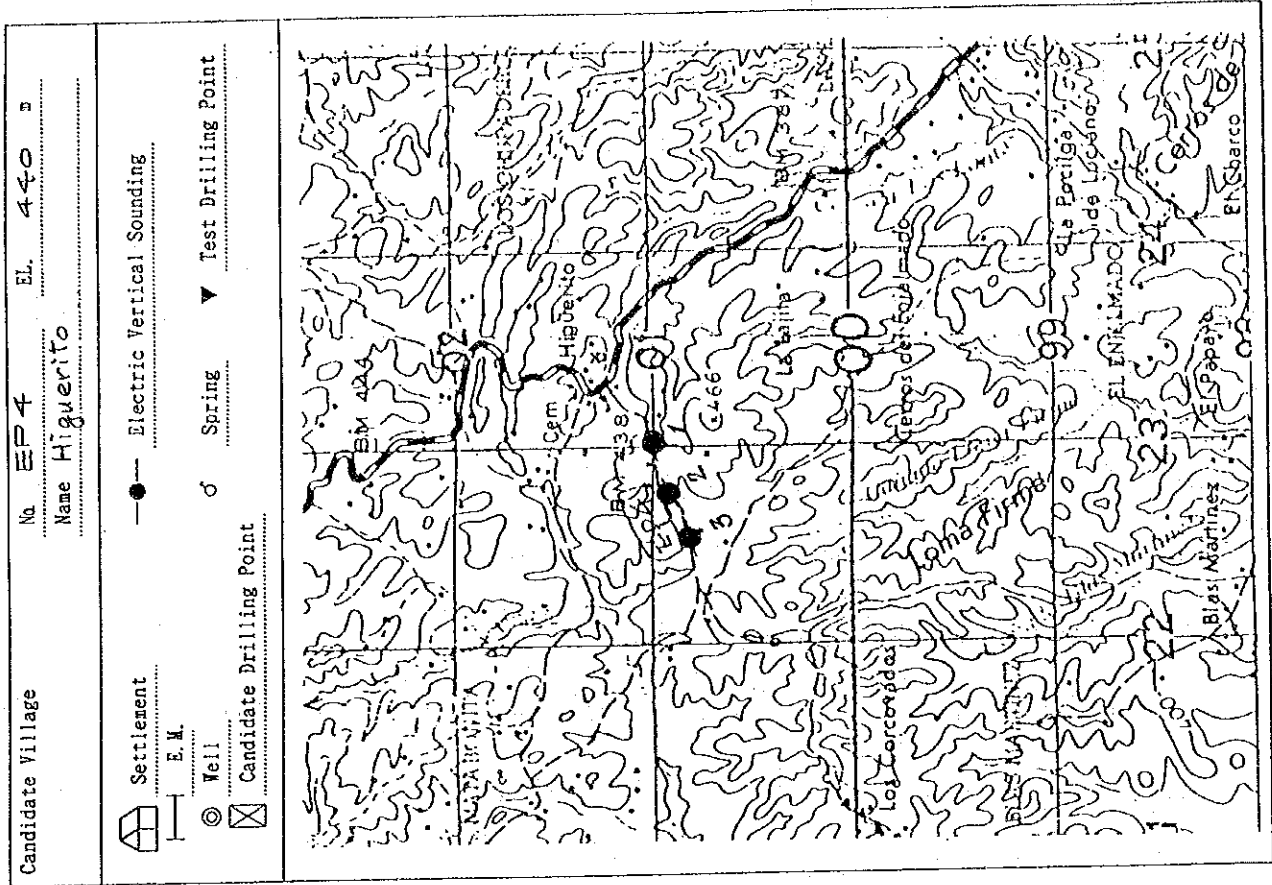

204

The Locations of Investigation & The Topographical Feature

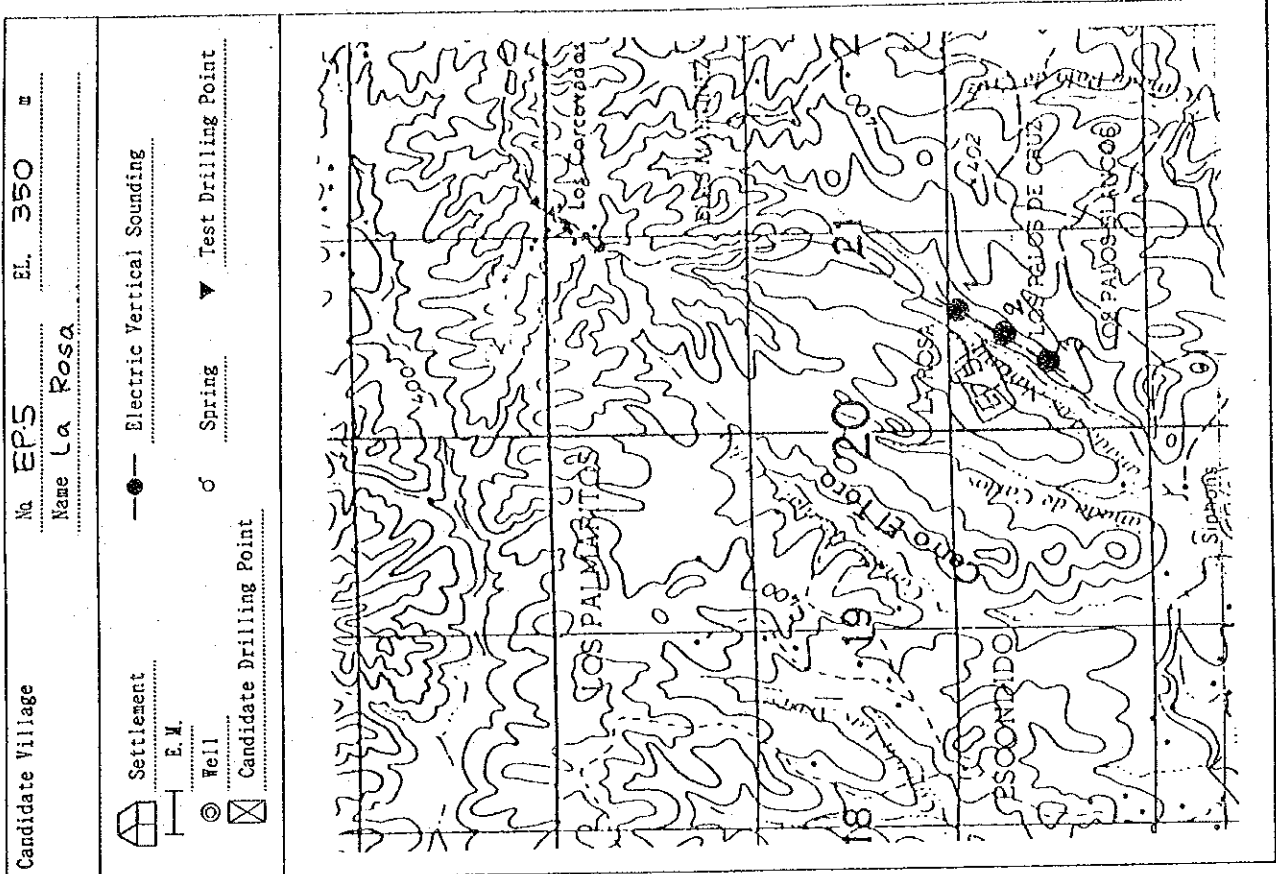

Line EP5

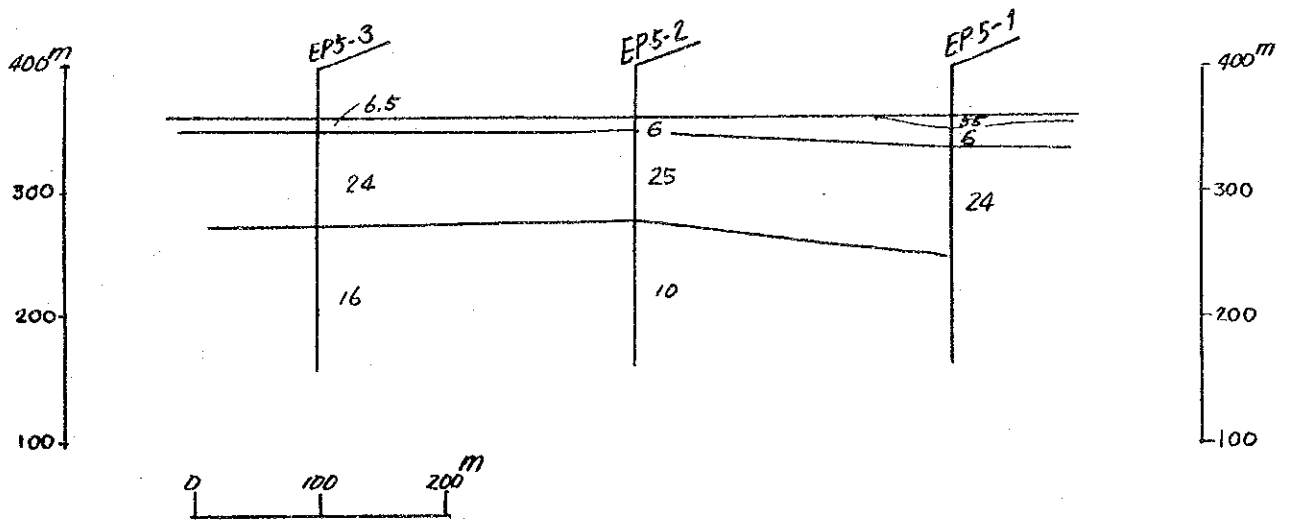

The Locations of Investigation & The Topographical Feature

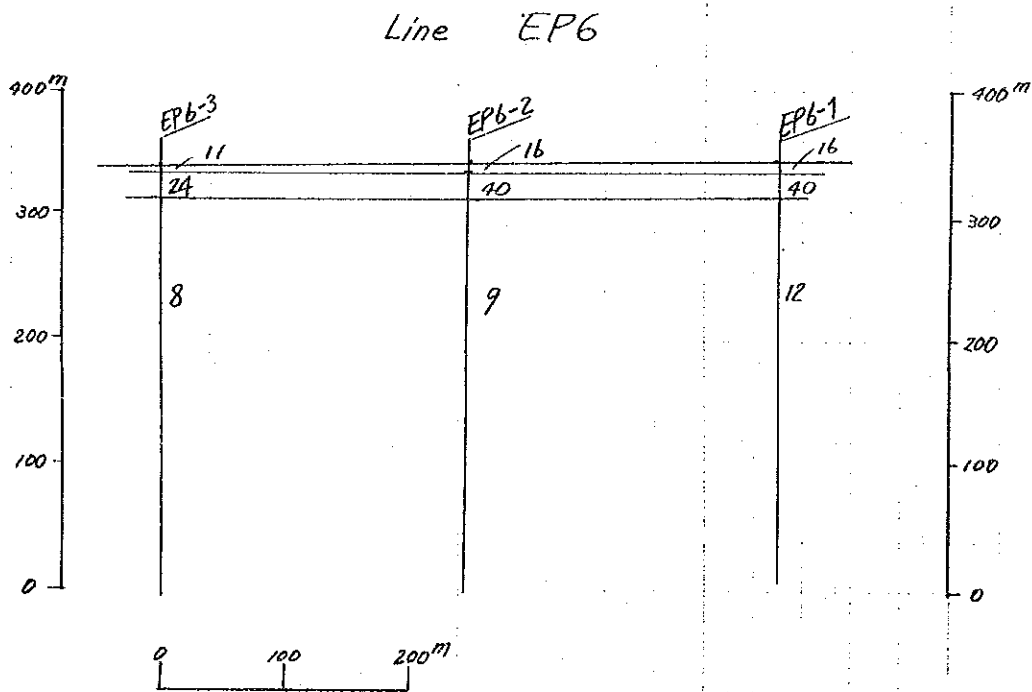
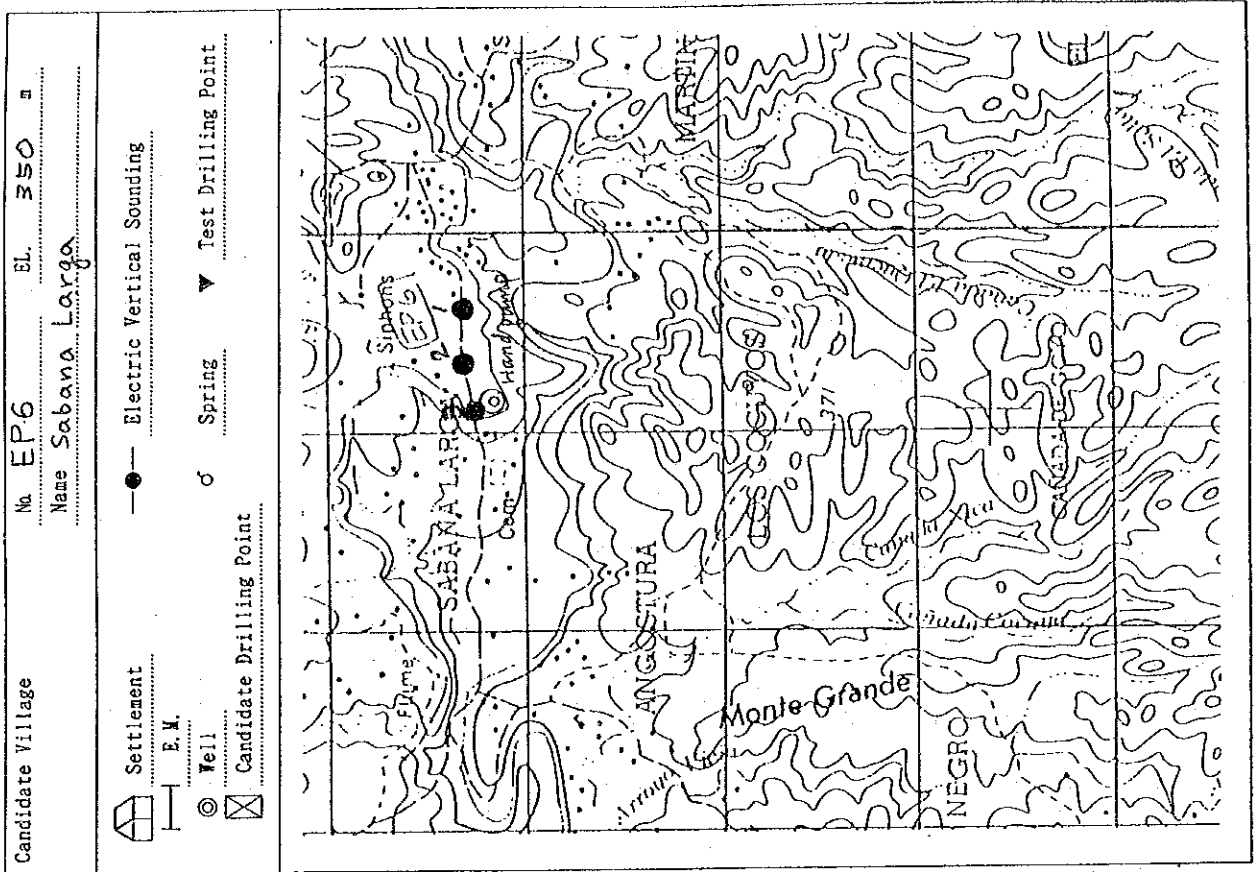

The Locations of Investigation & The Topographical Feature

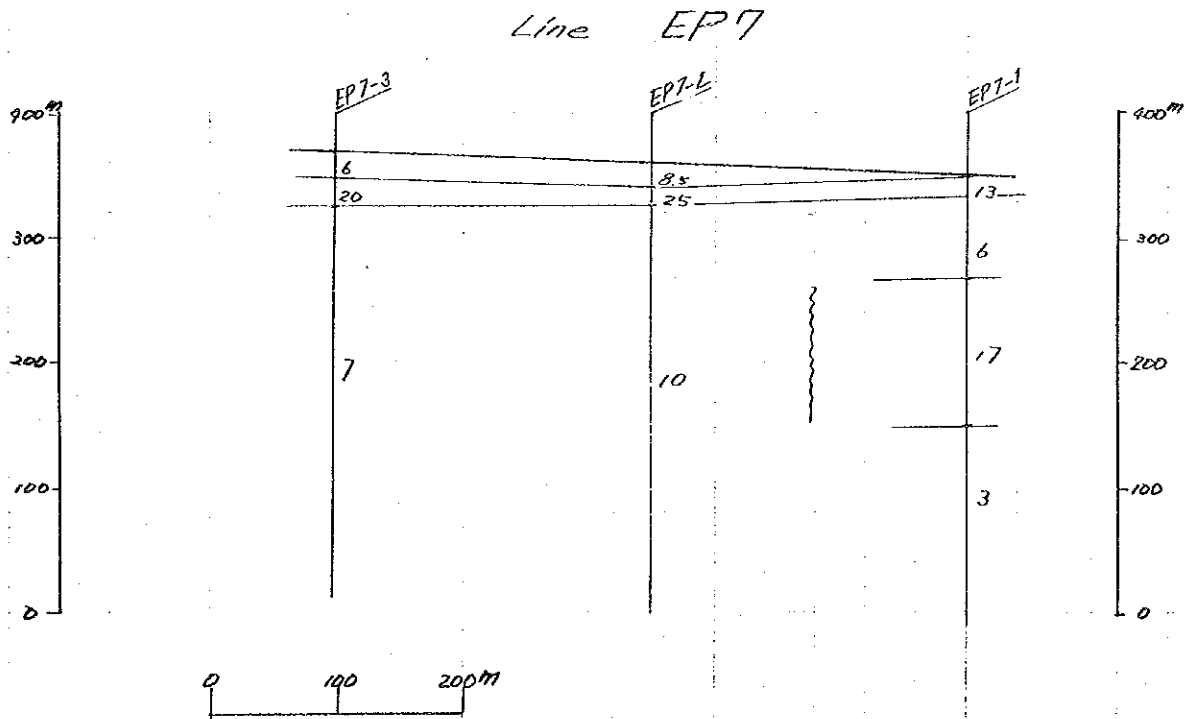
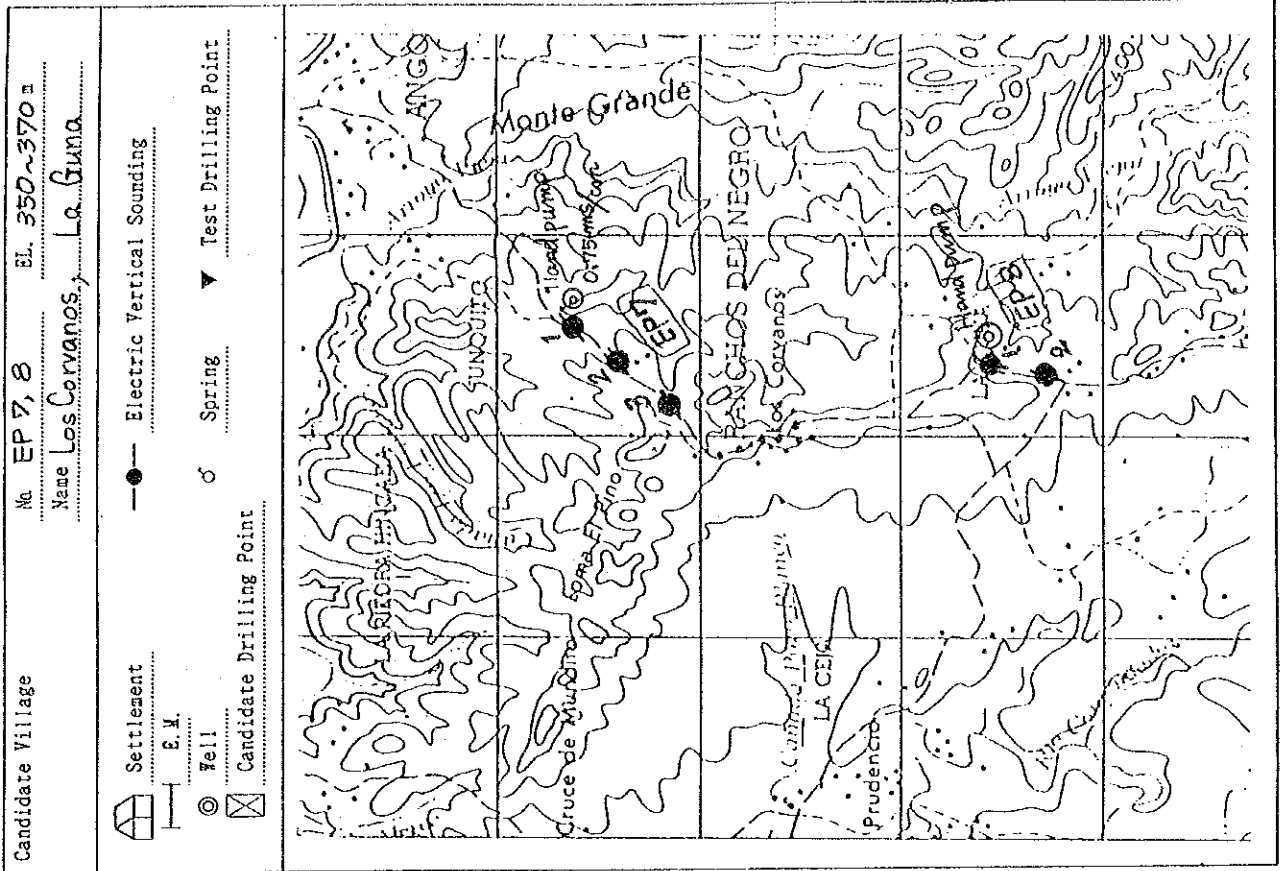

Line EP8

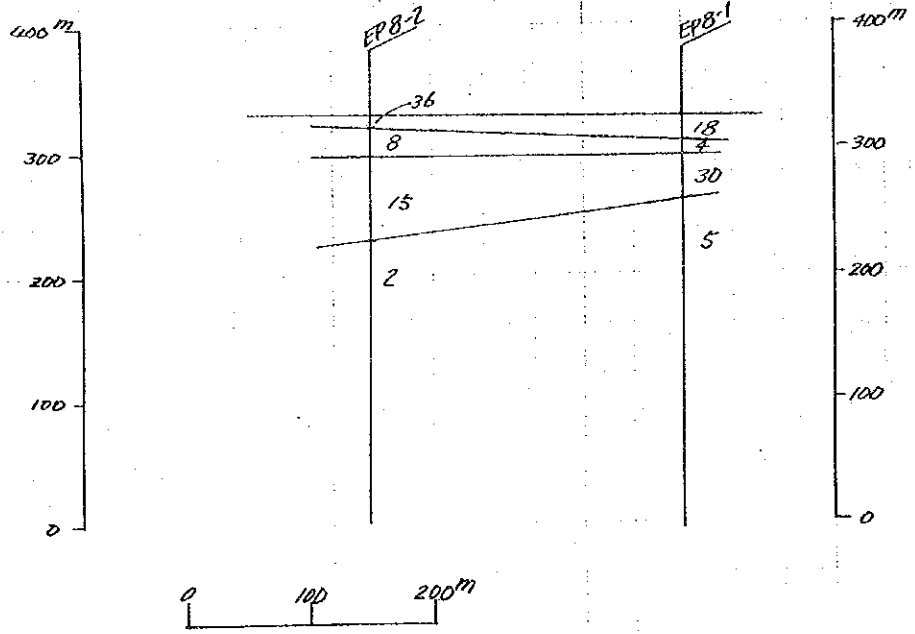

The Locations of Investigation & The Topographical Feature

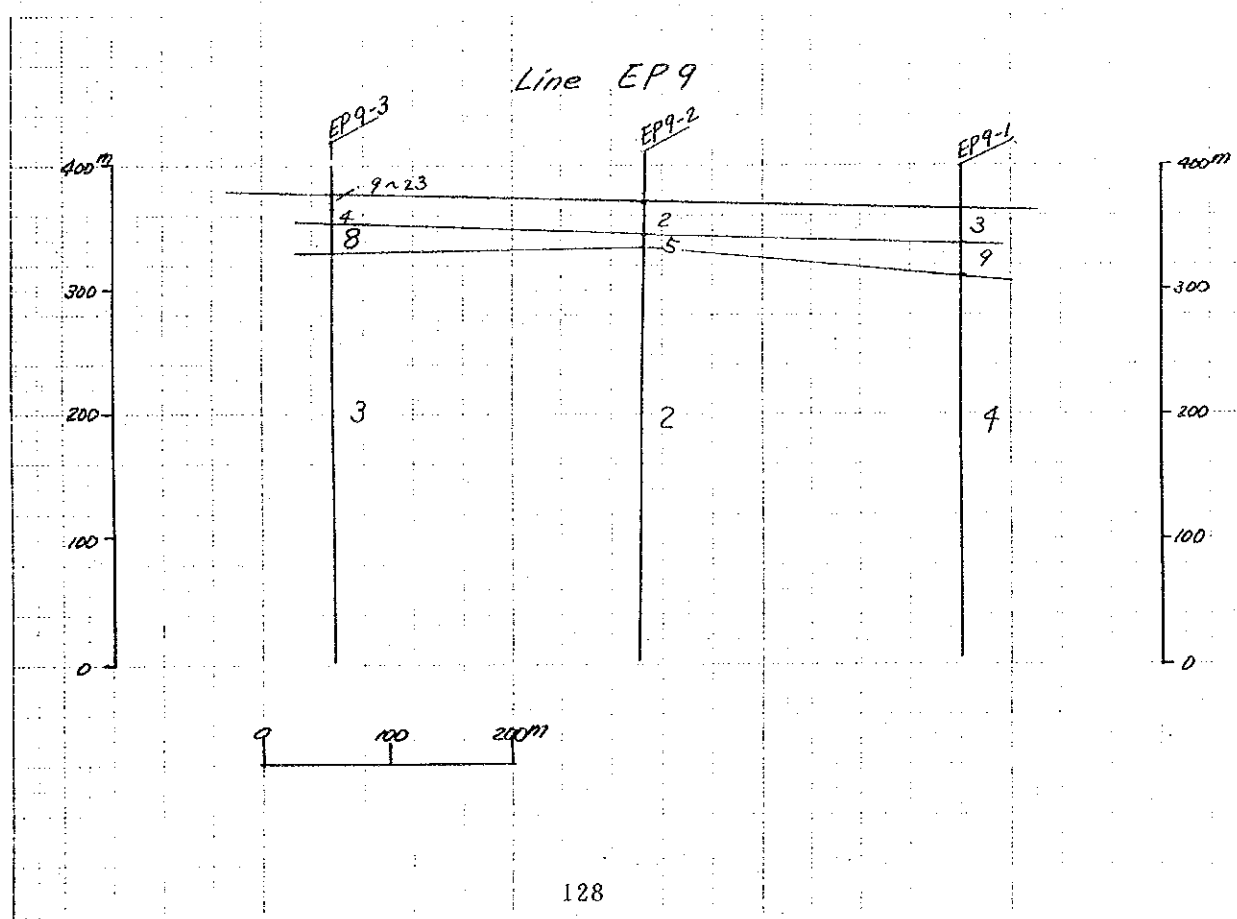
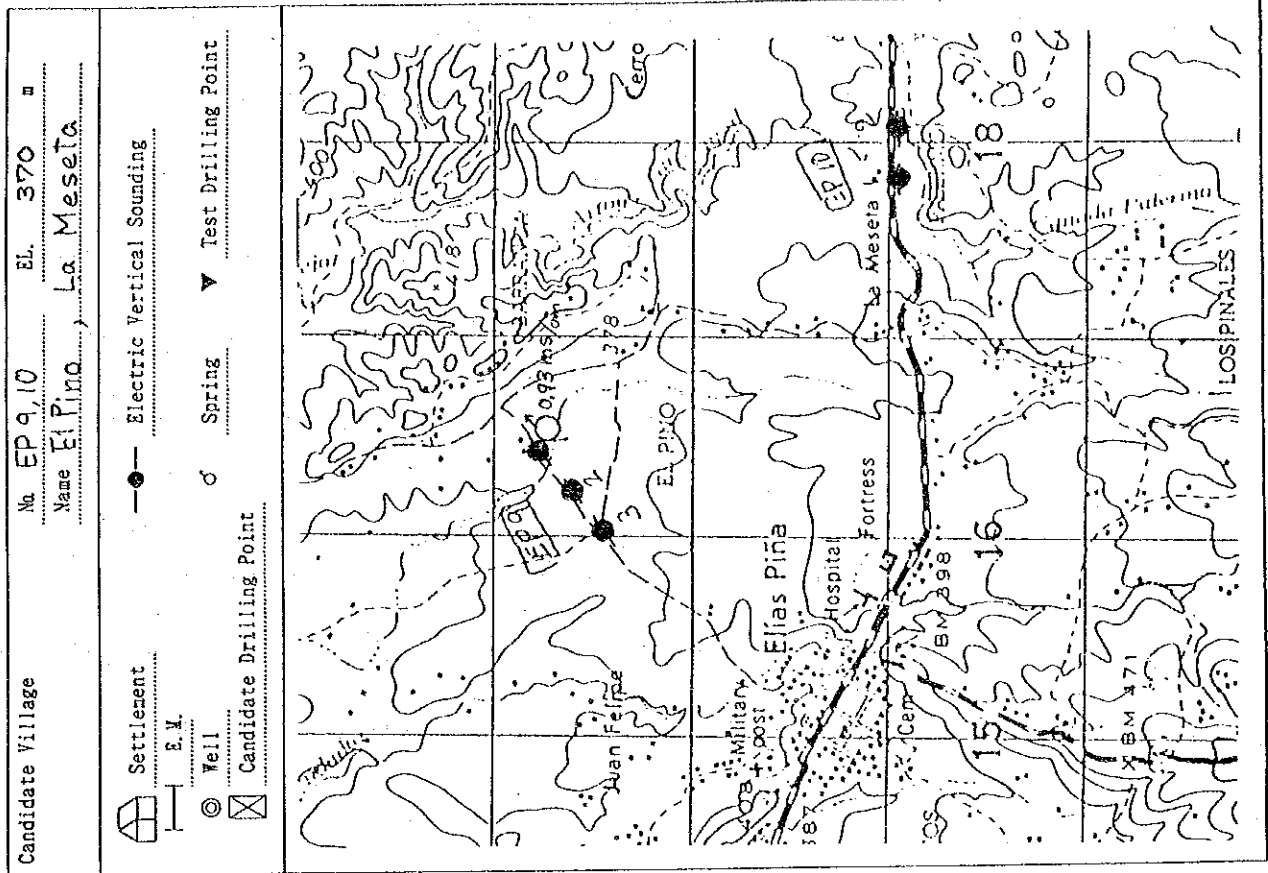



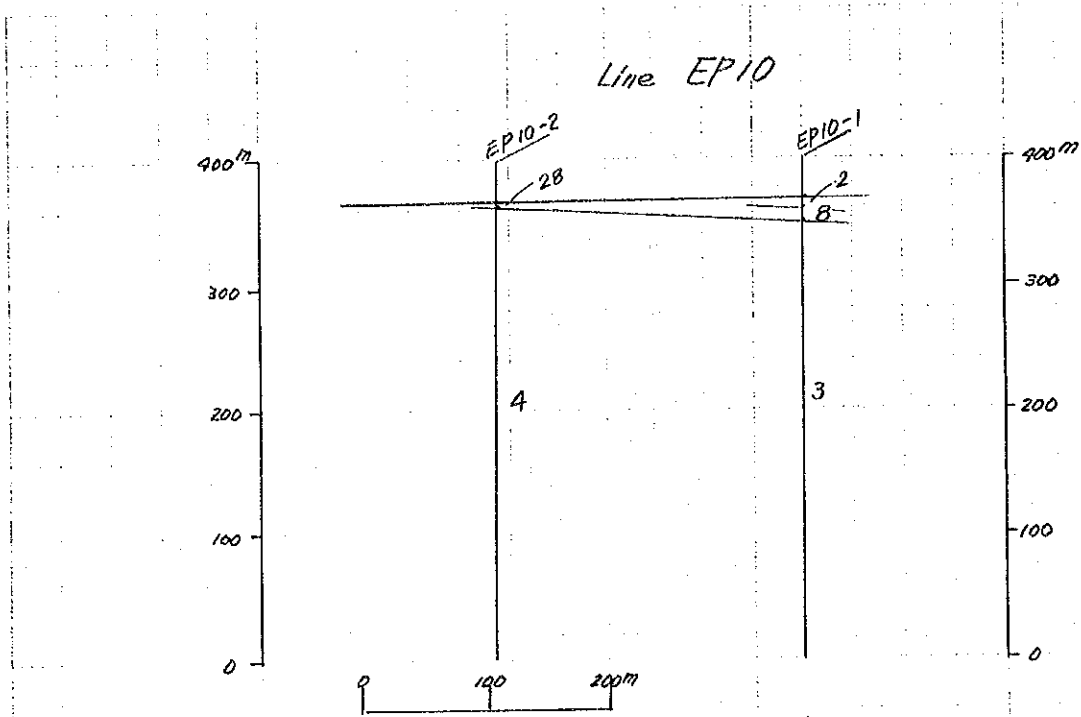

420

The Locations of Investigation & The Topographical Feature

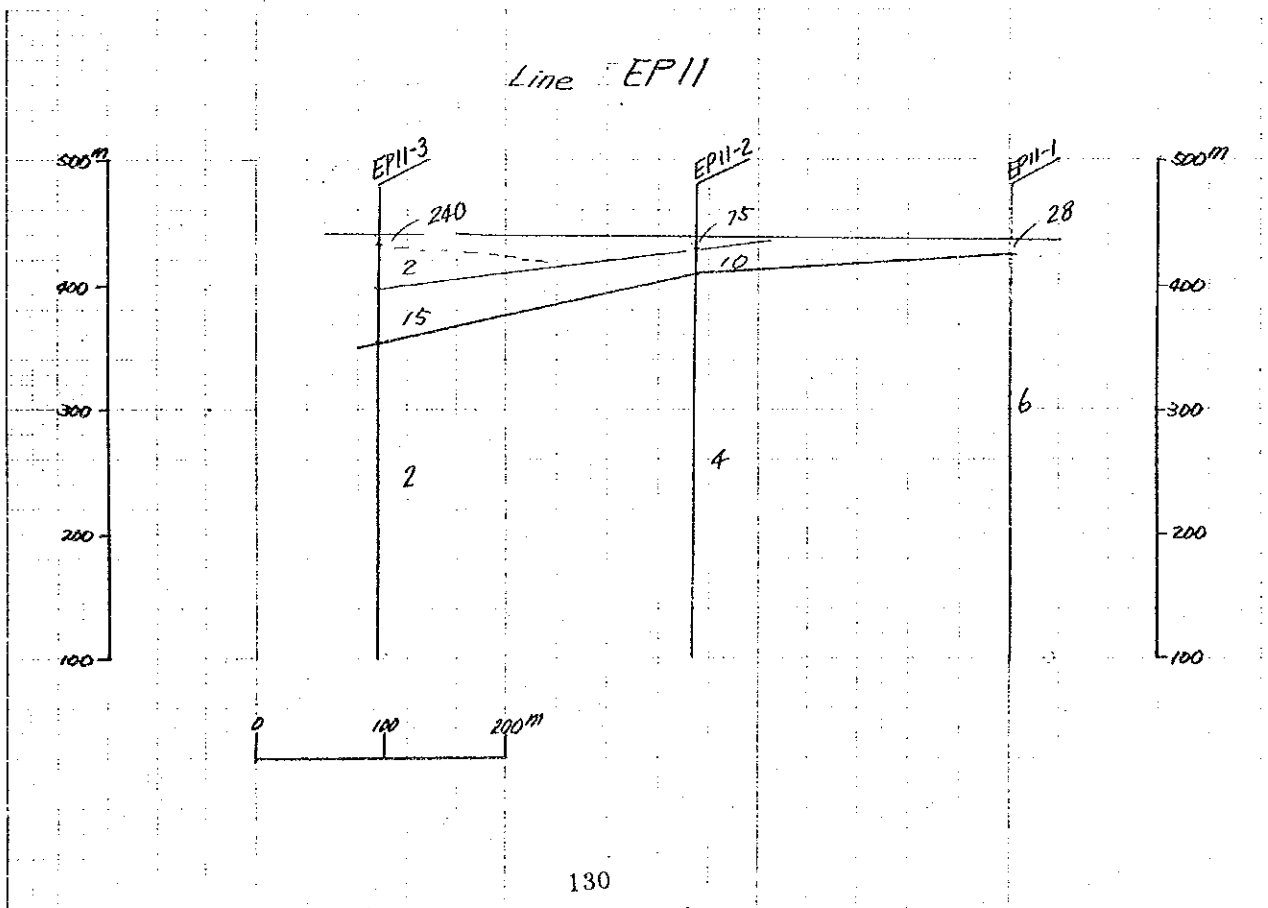
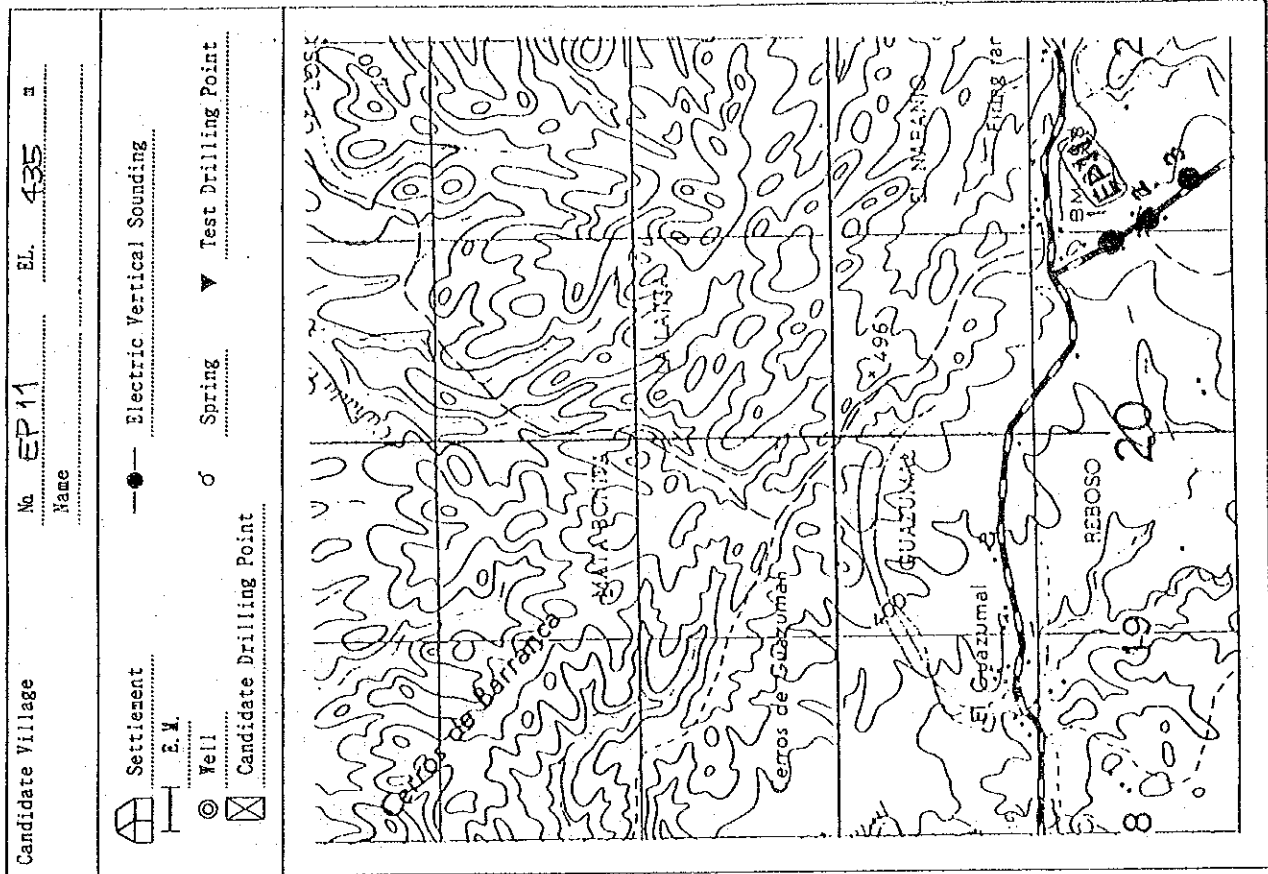

The Locations of Investigation & The Topographical Feature

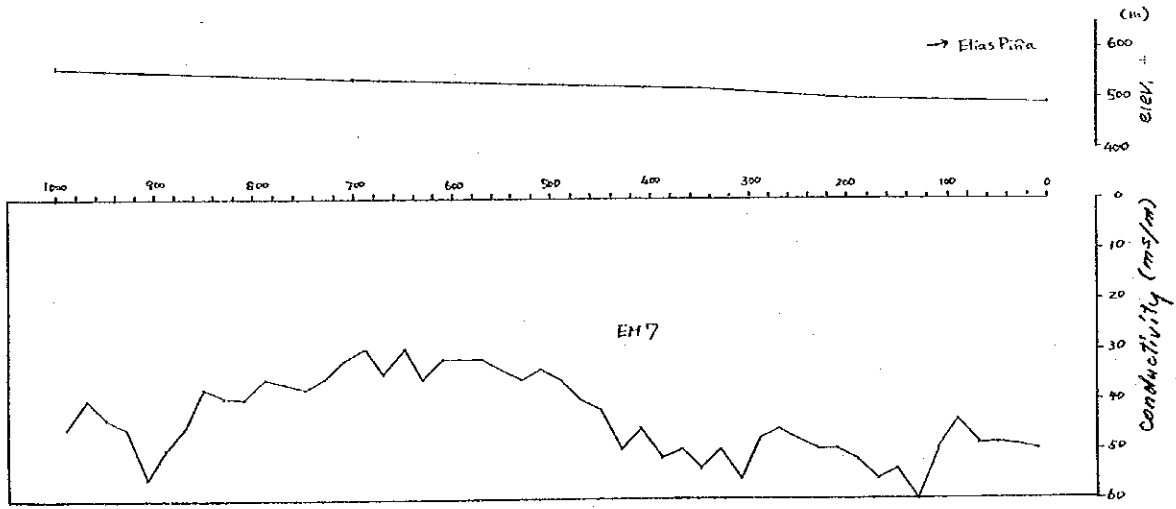
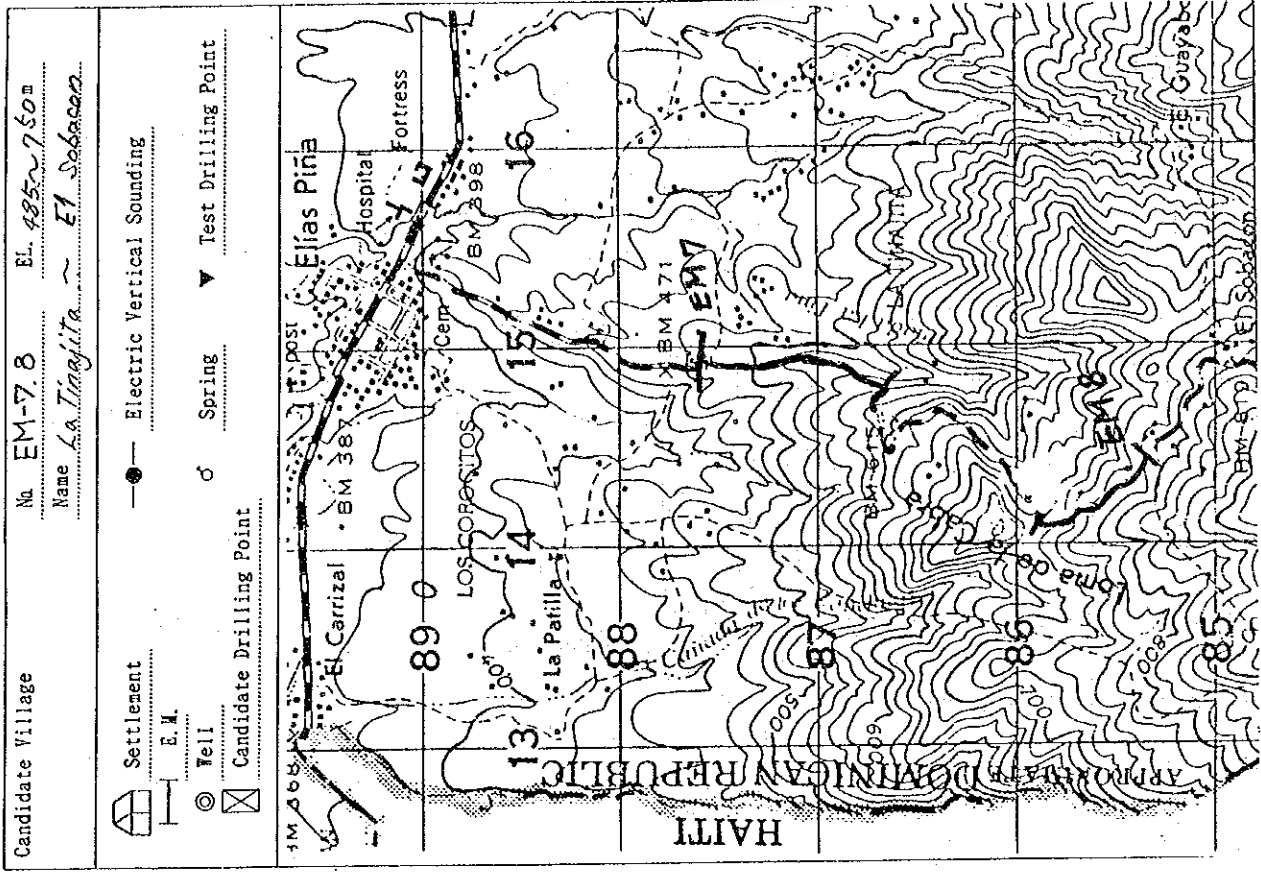

EM-7  
 Electrode Spacing 20m  
 Station Interval 20m

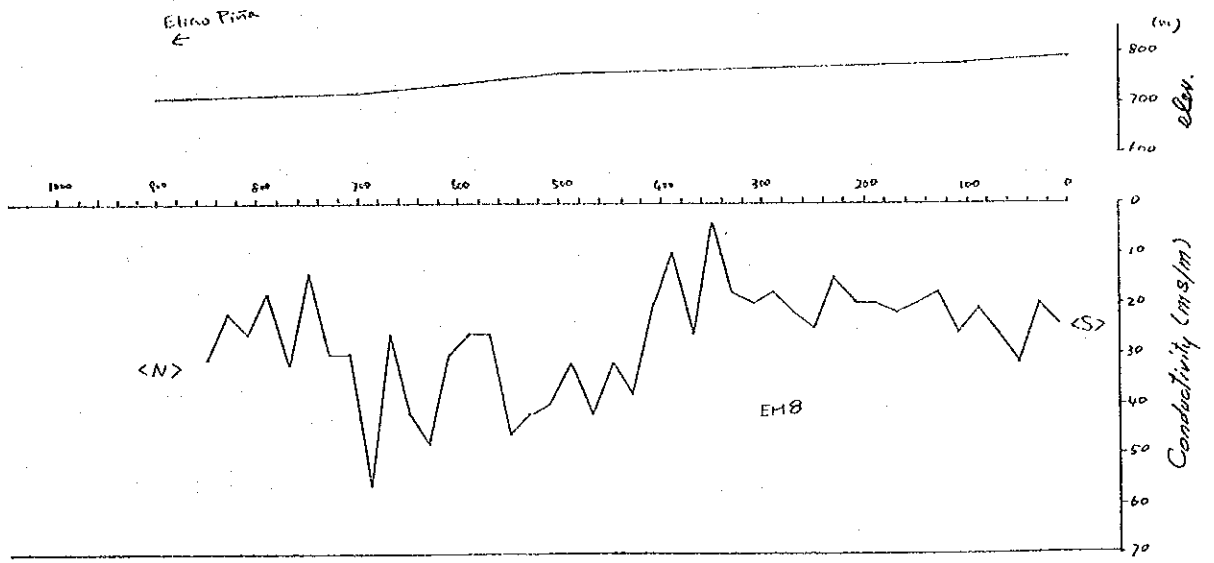

EM-8  
 Electrode Spacing 20m  
 Station Interval 20m

433

The Locations of Investigation & The Topographical Feature

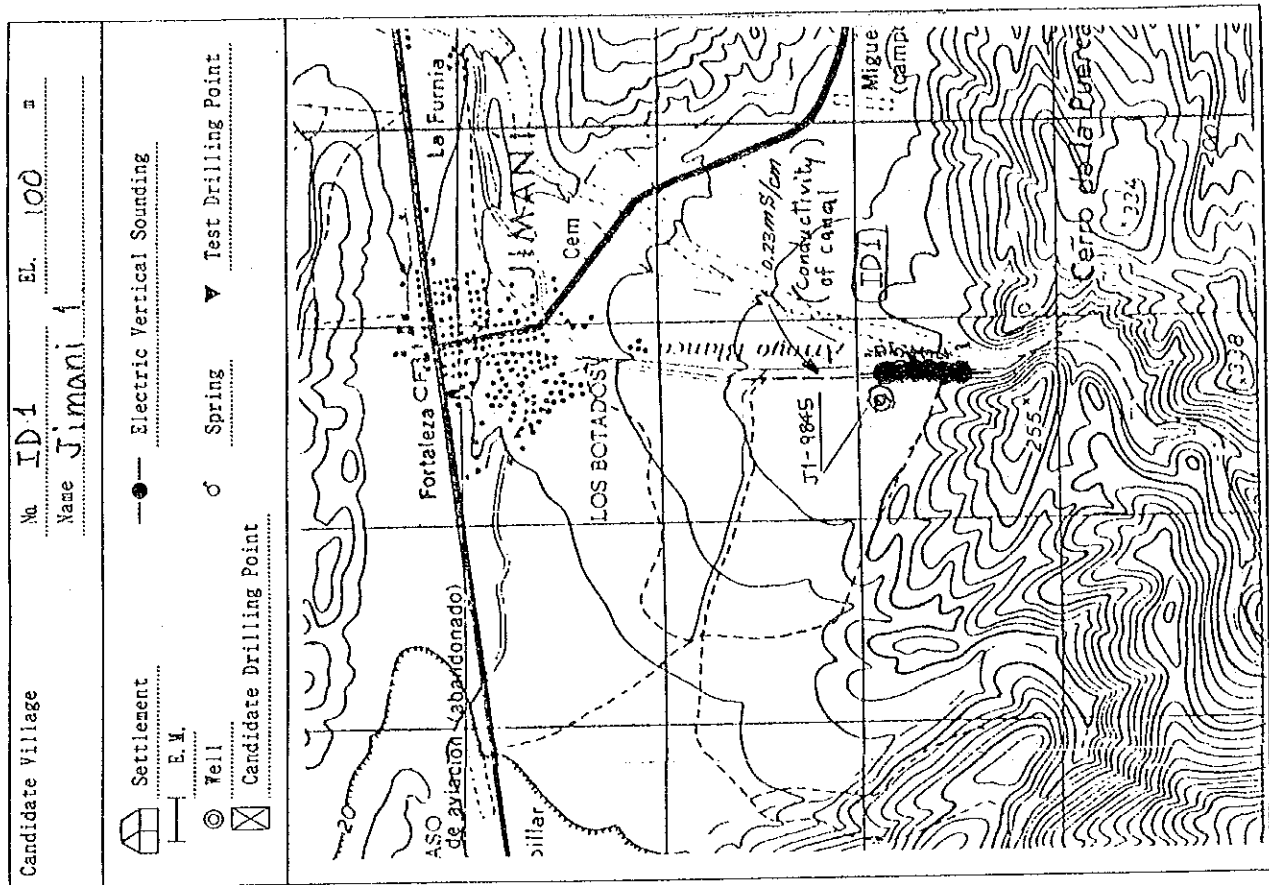

Line ID 1

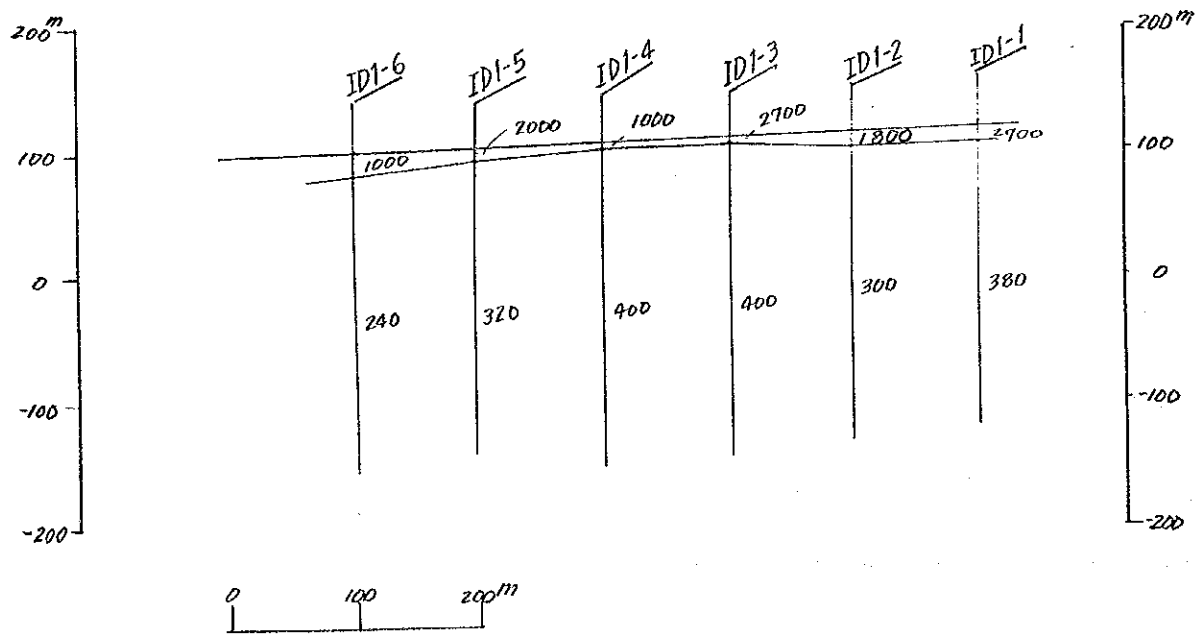

424

The Locations of Investigation & The Topographical Feature

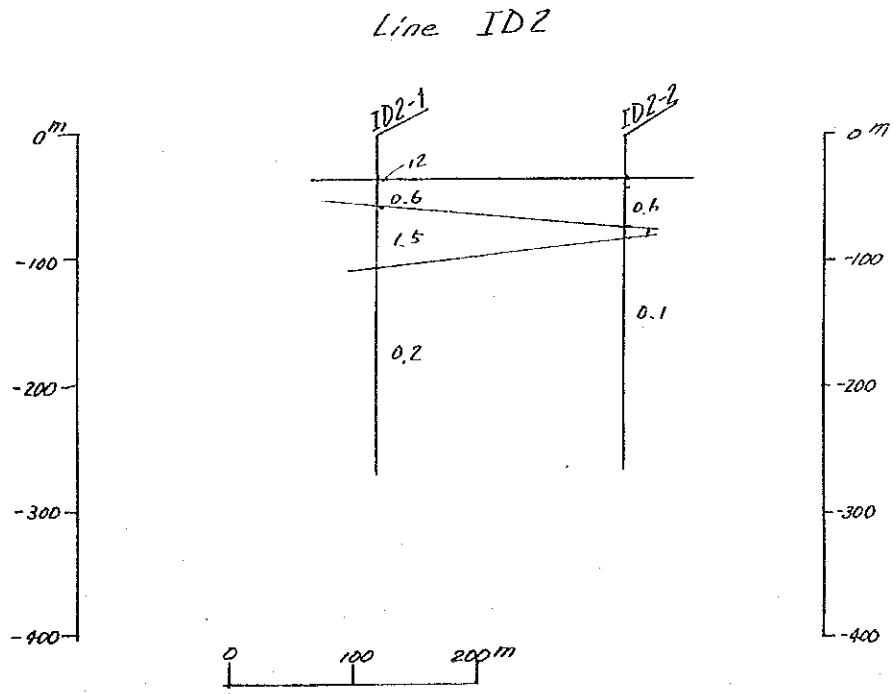
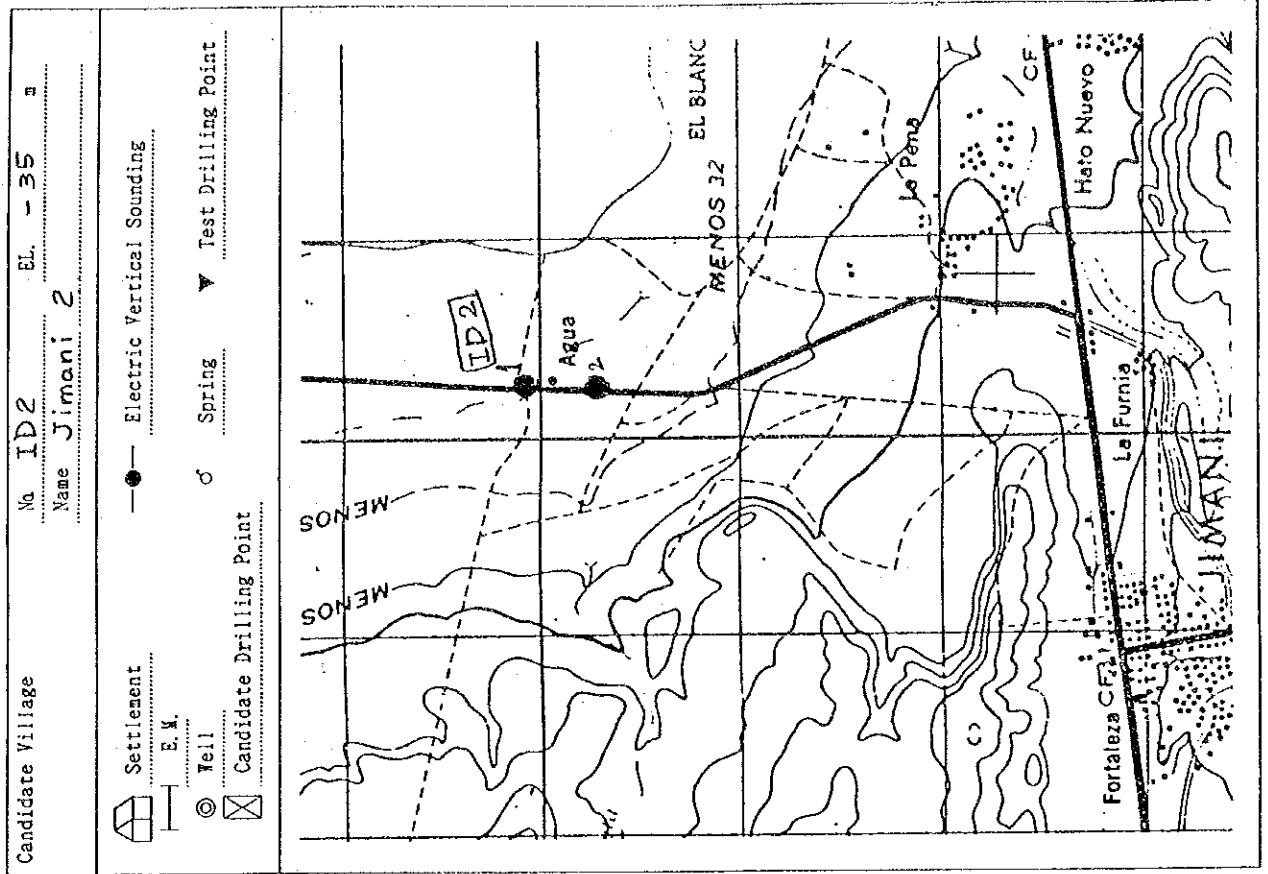

The Locations of Investigation & The Topographical Feature

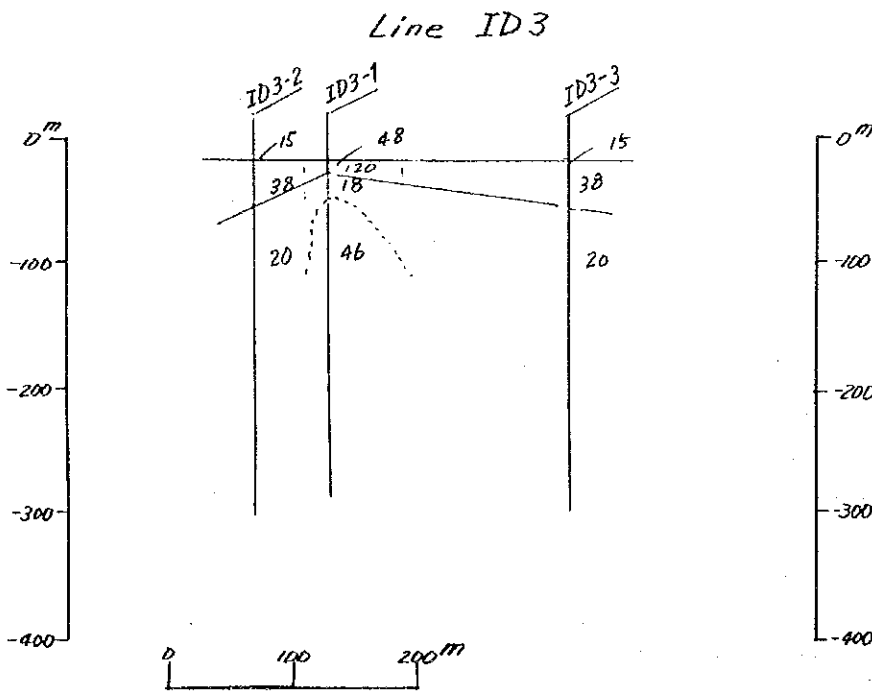
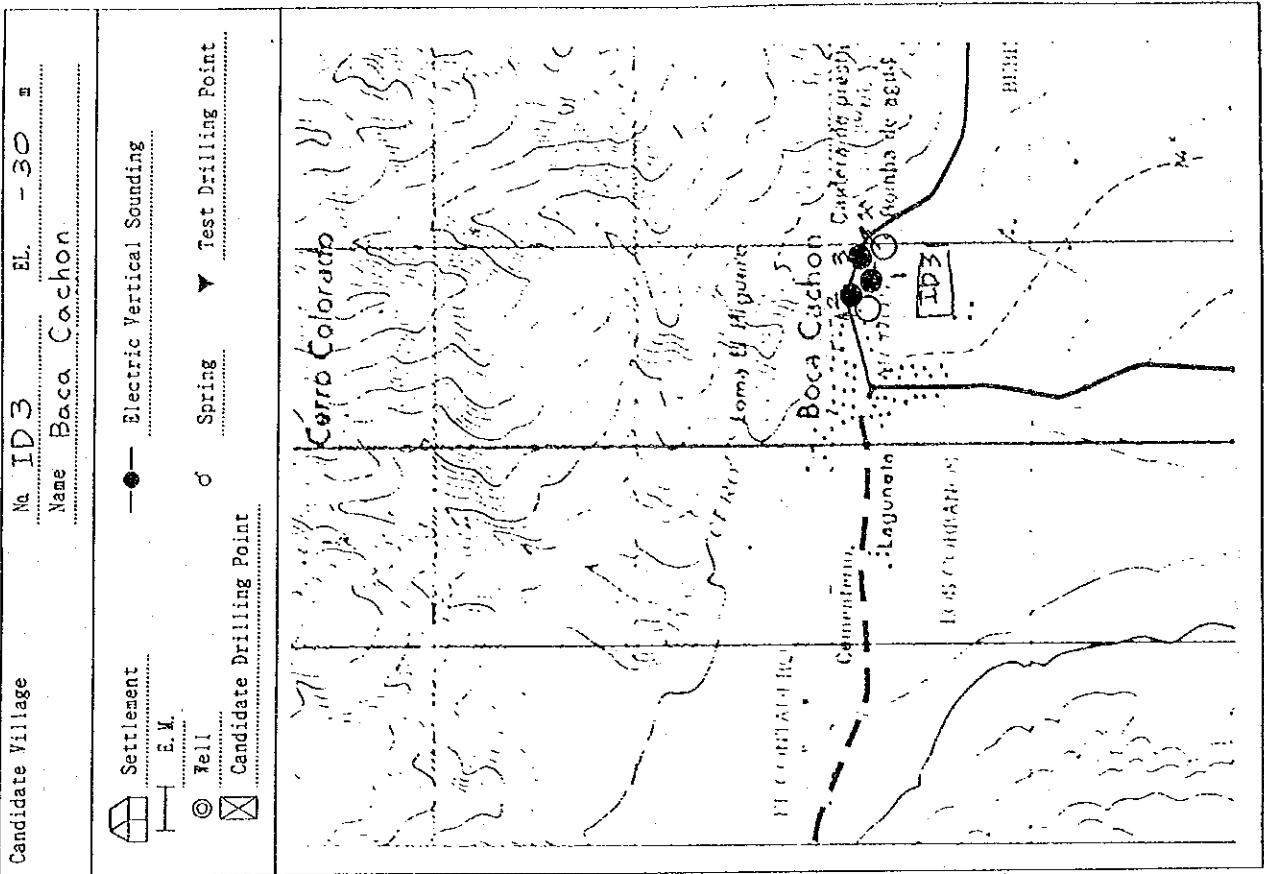

626





Line ID4

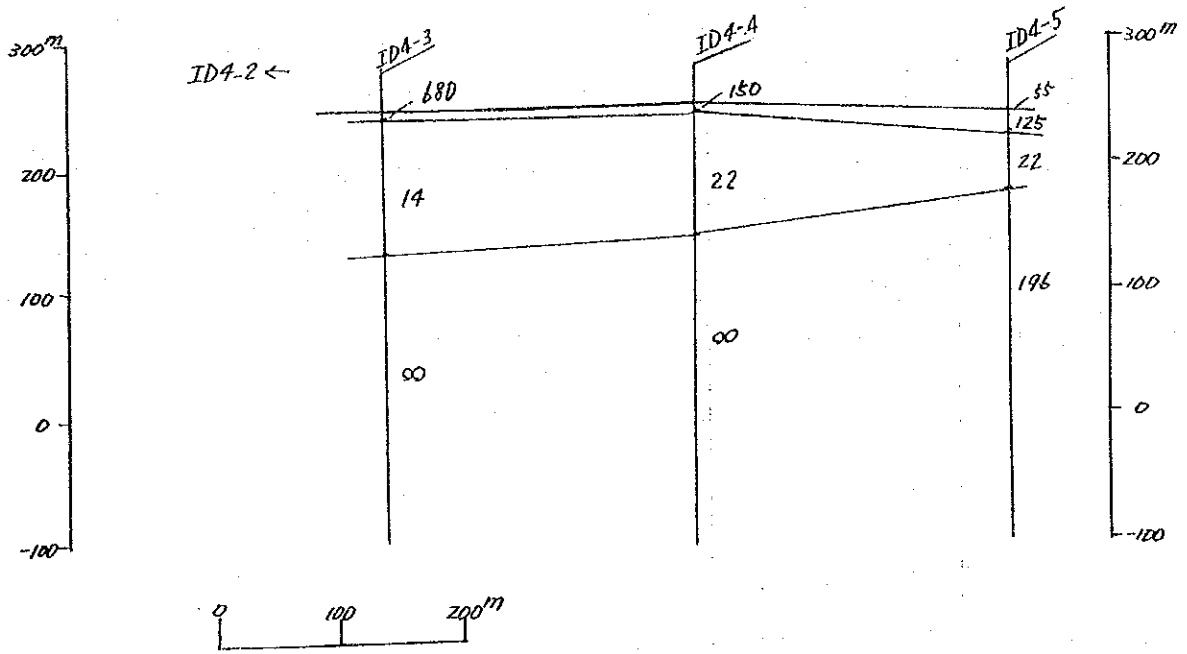

The Locations of Investigation & The Topographical Feature

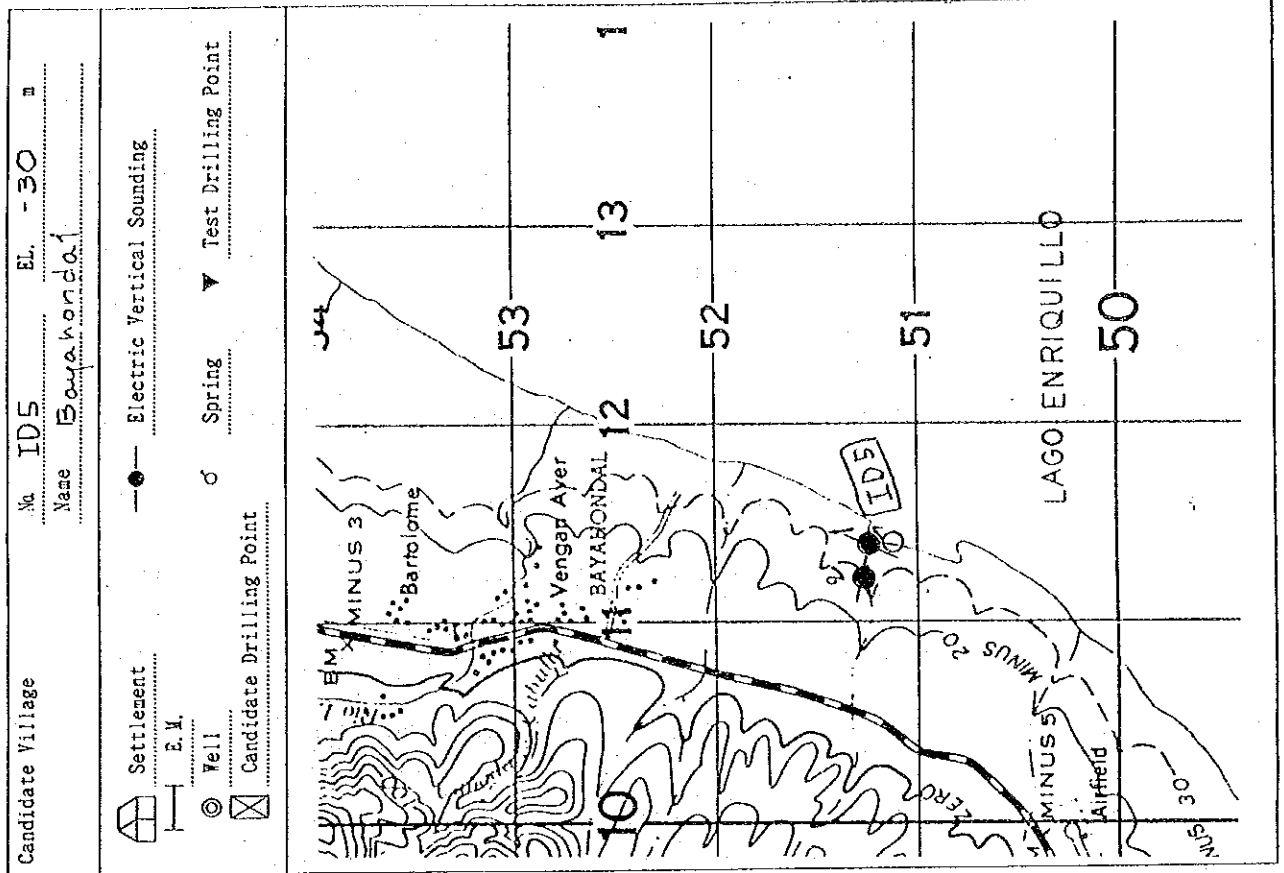

Line ID5

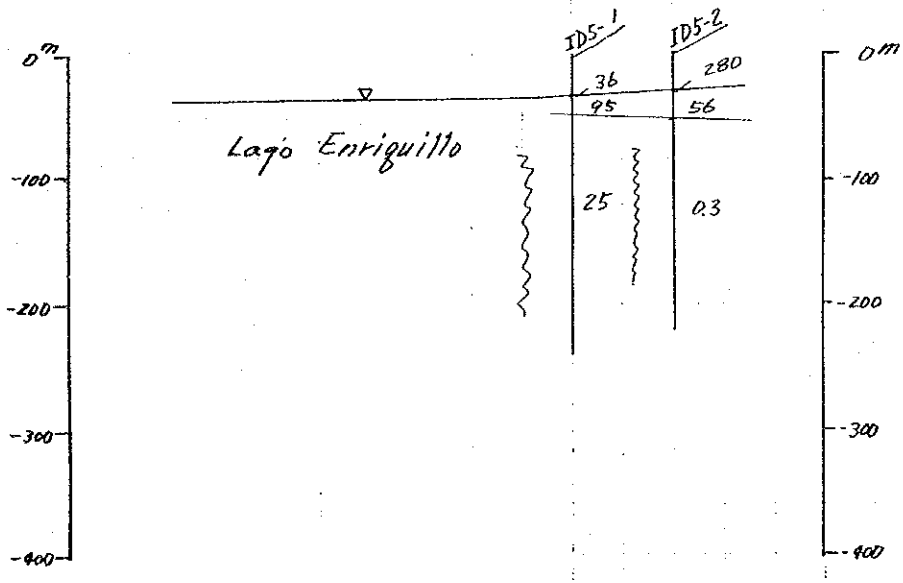



The Locations of Investigation & The Topographical Feature

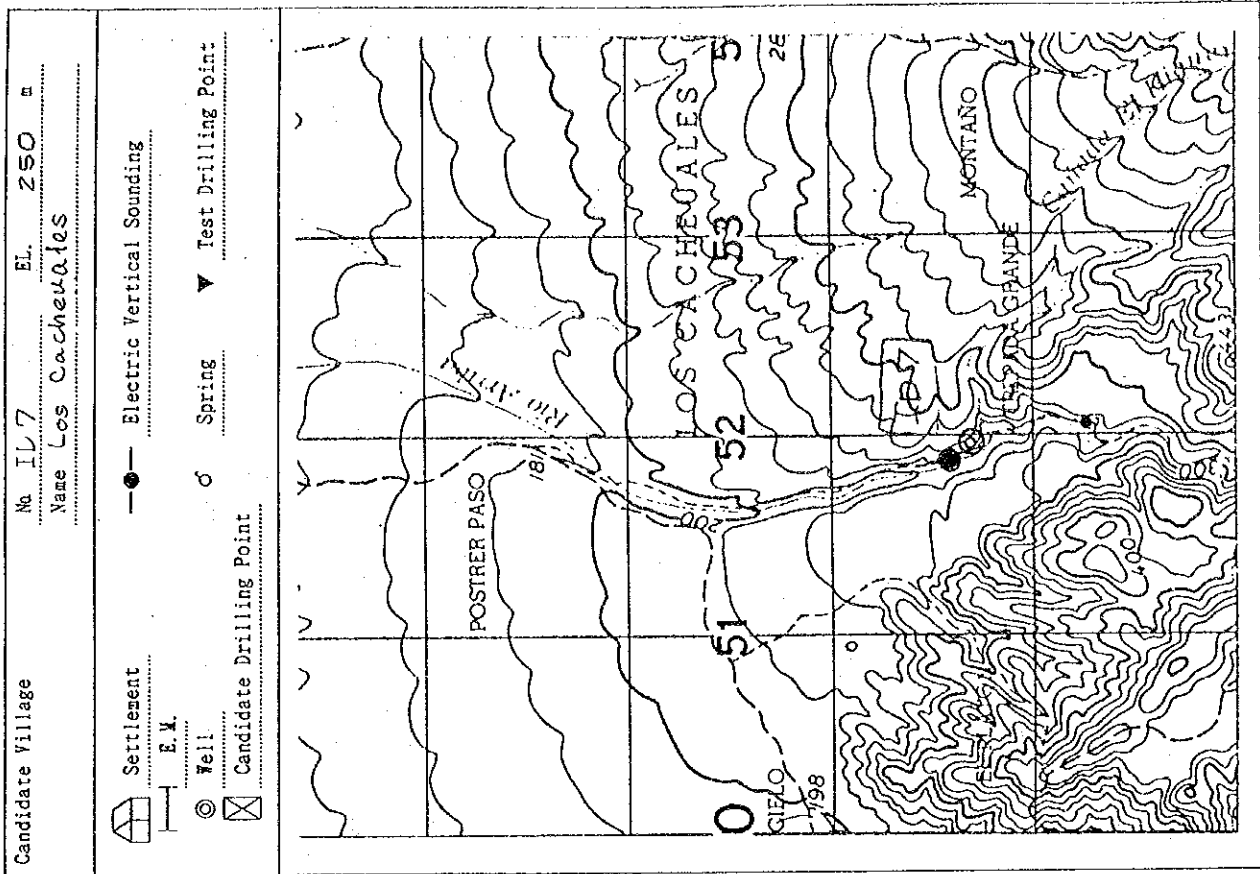

Line ID7

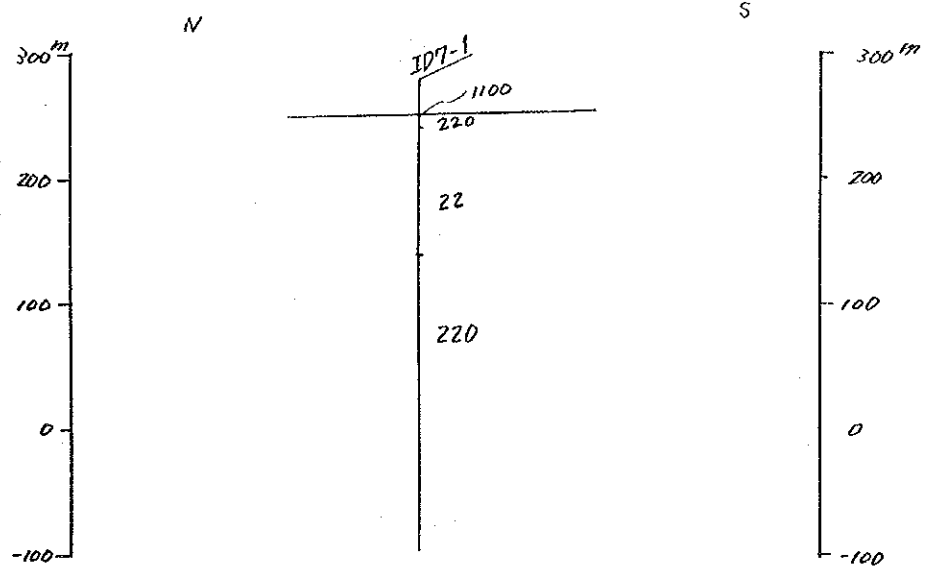

The Locations of Investigation & The Topographical Feature

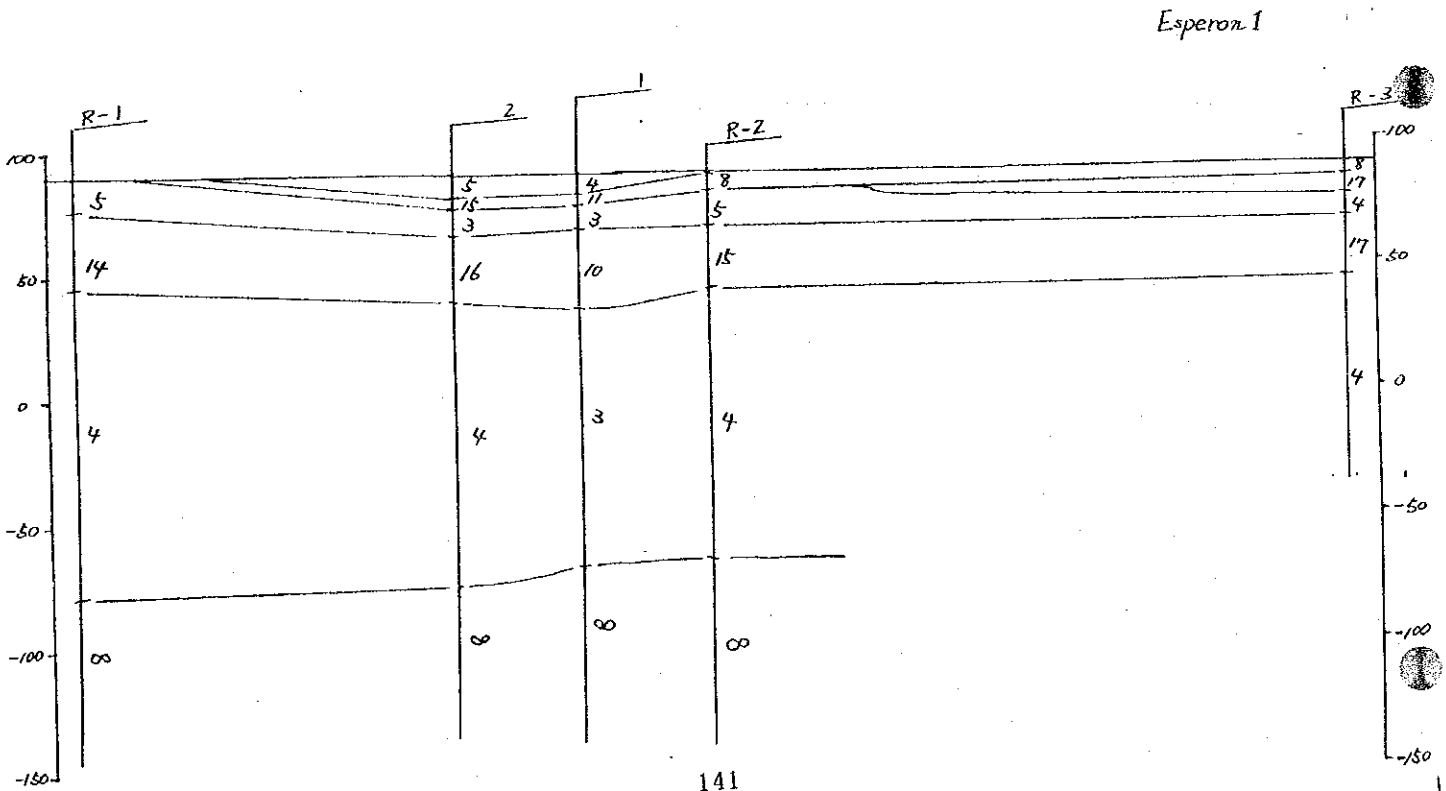
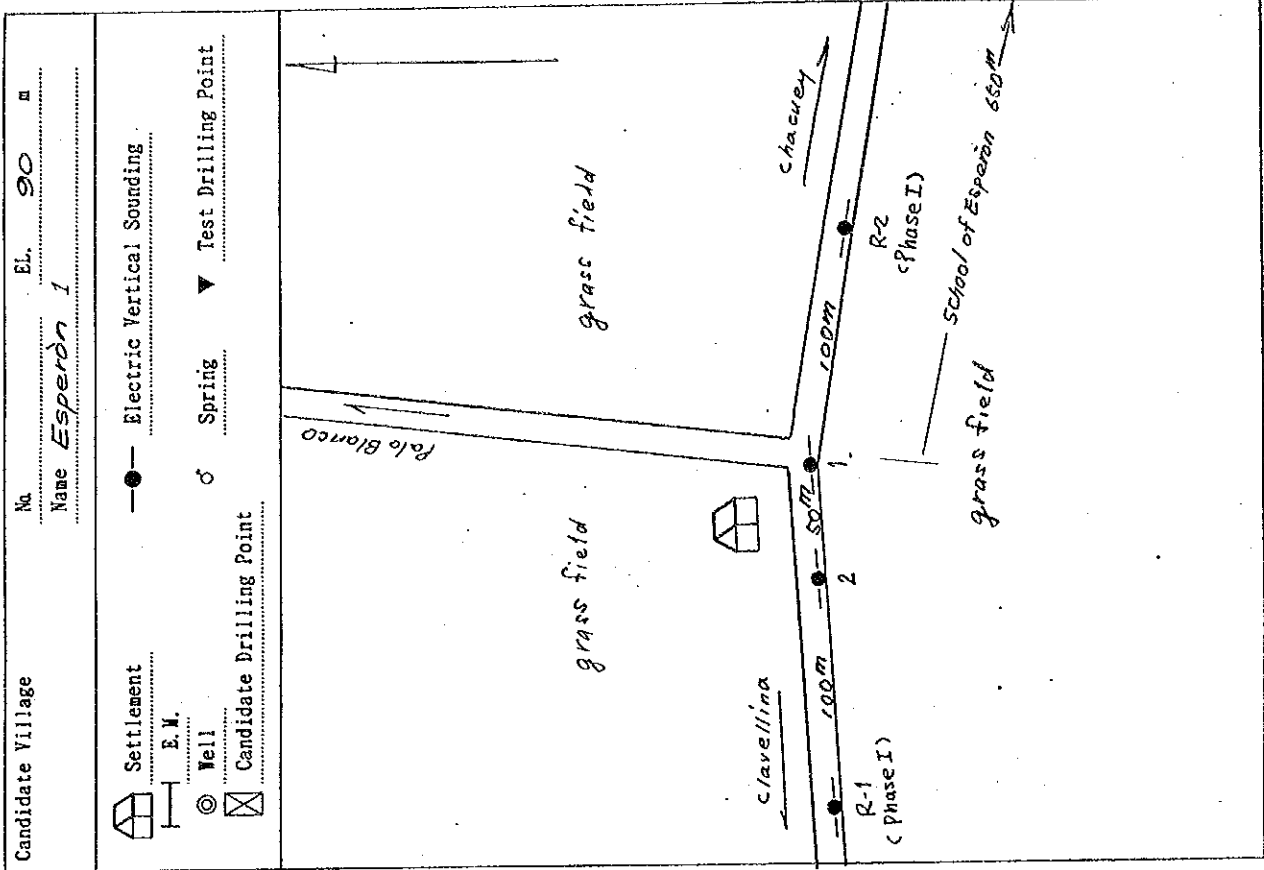

472

The Locations of Investigation & The Topographical Feature

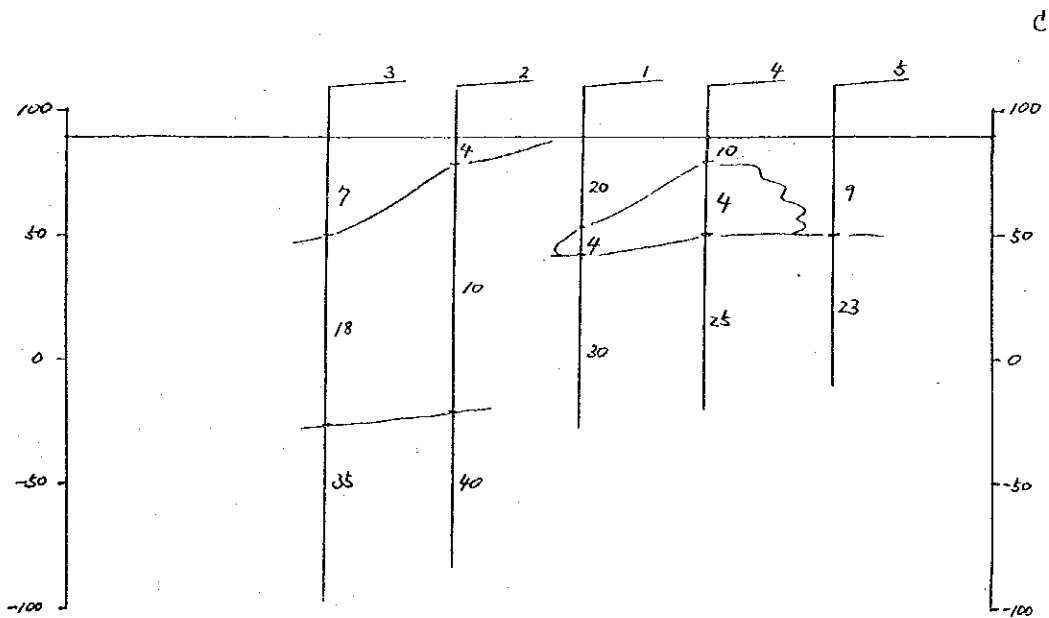
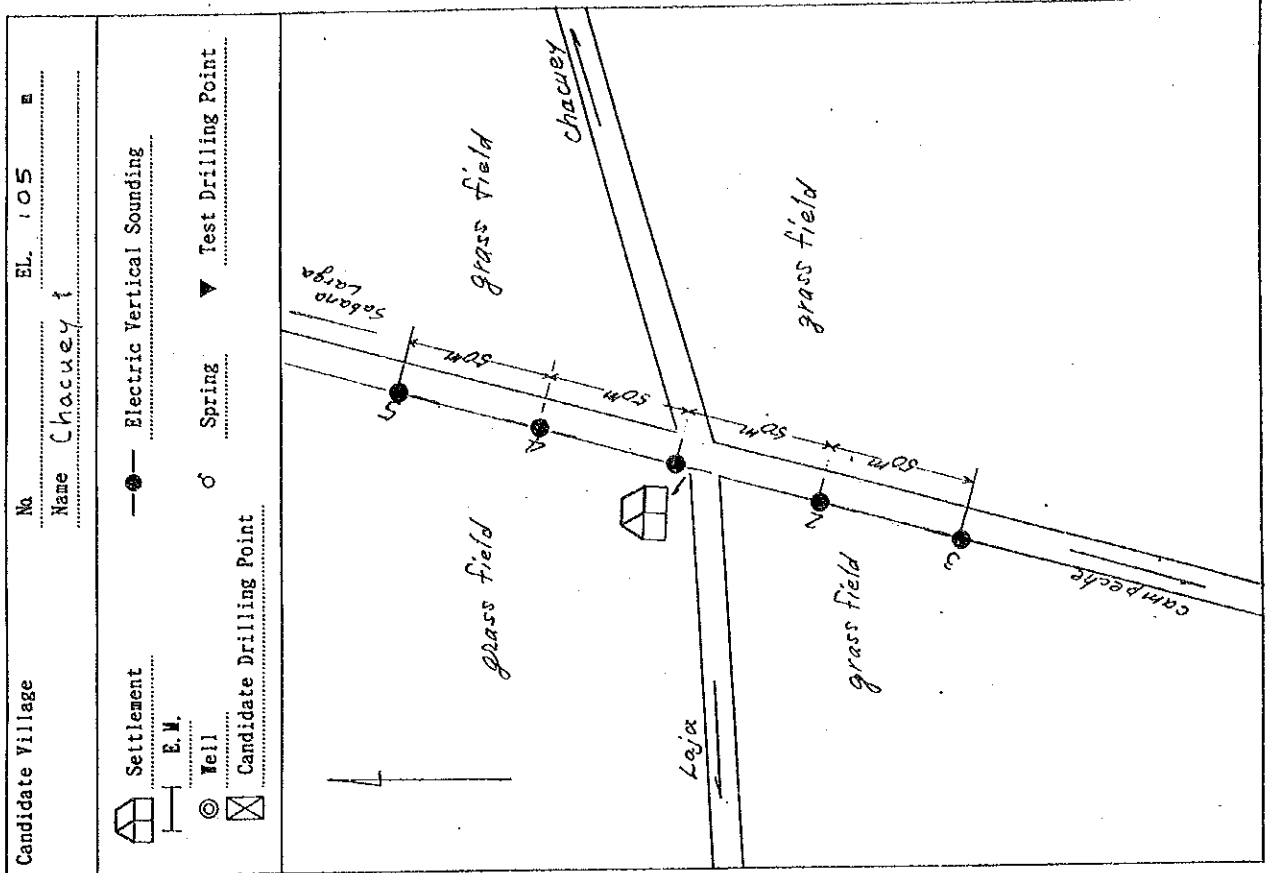

257

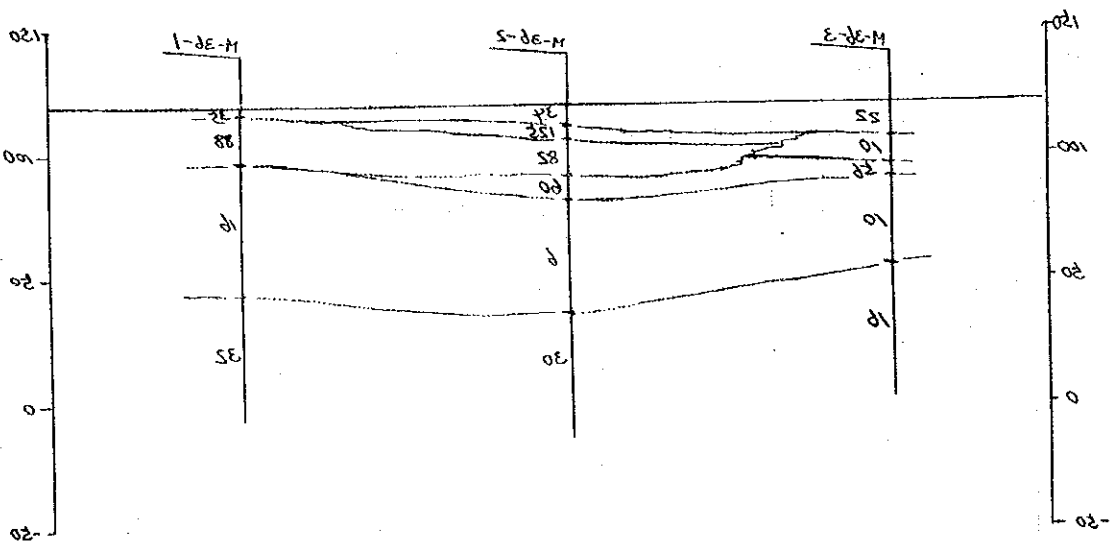

The Locations of Investigation & The Topographical Feature

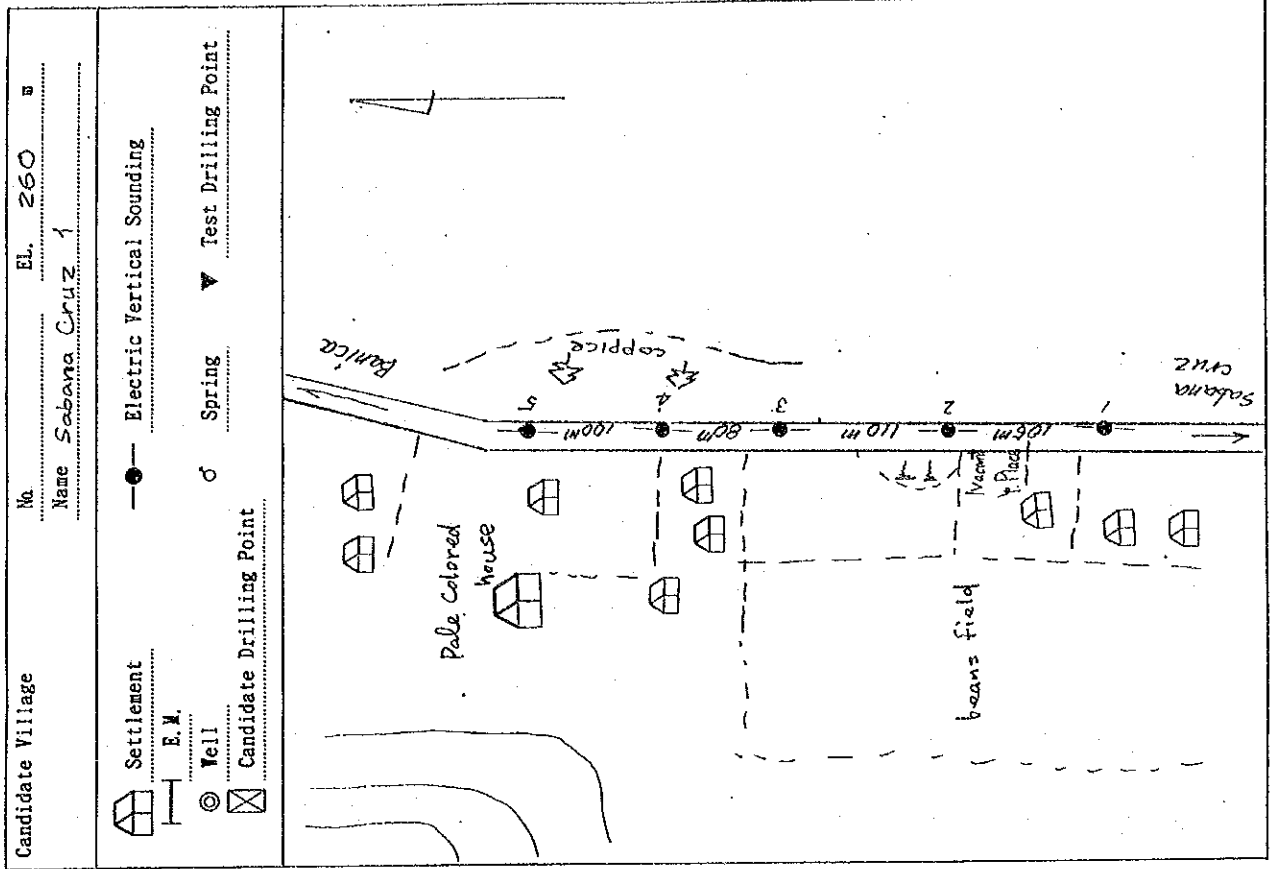

Sabana Cruz 1

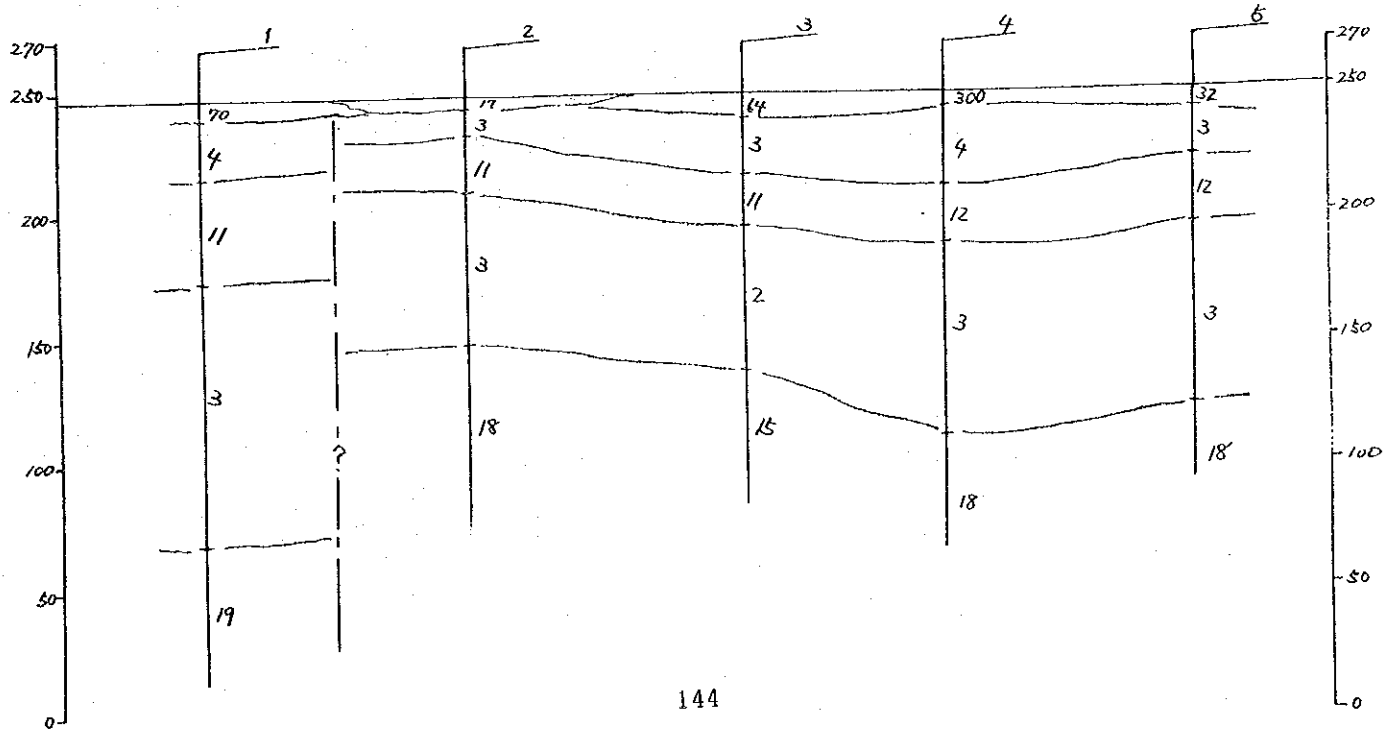



The Locations of Investigation & The Topographical Feature

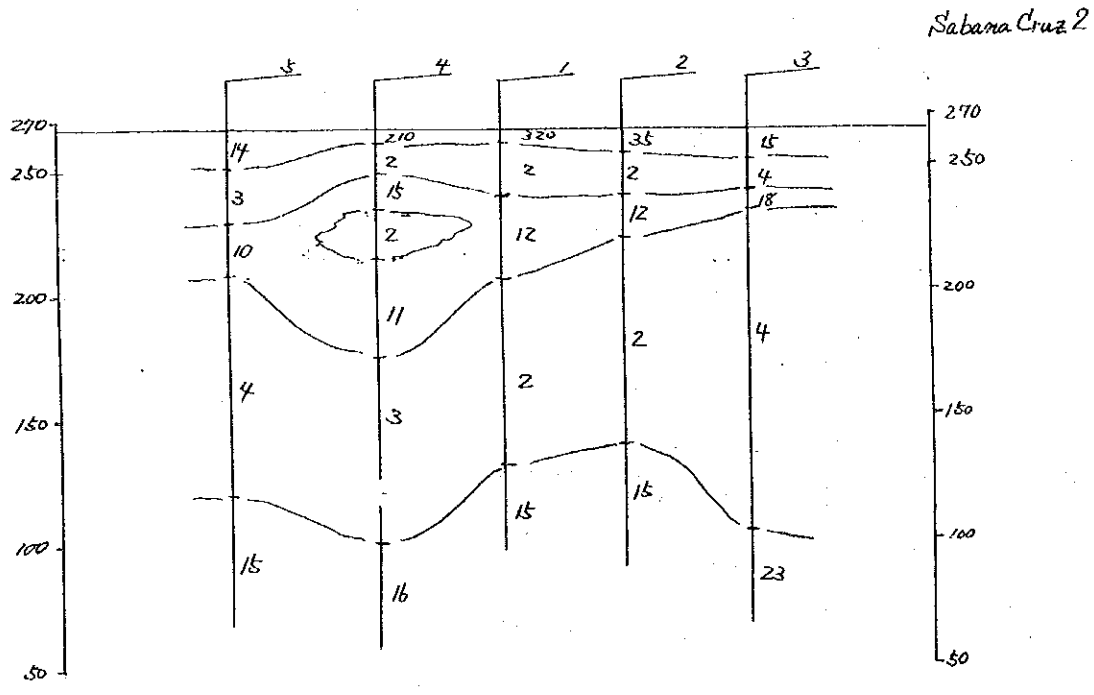
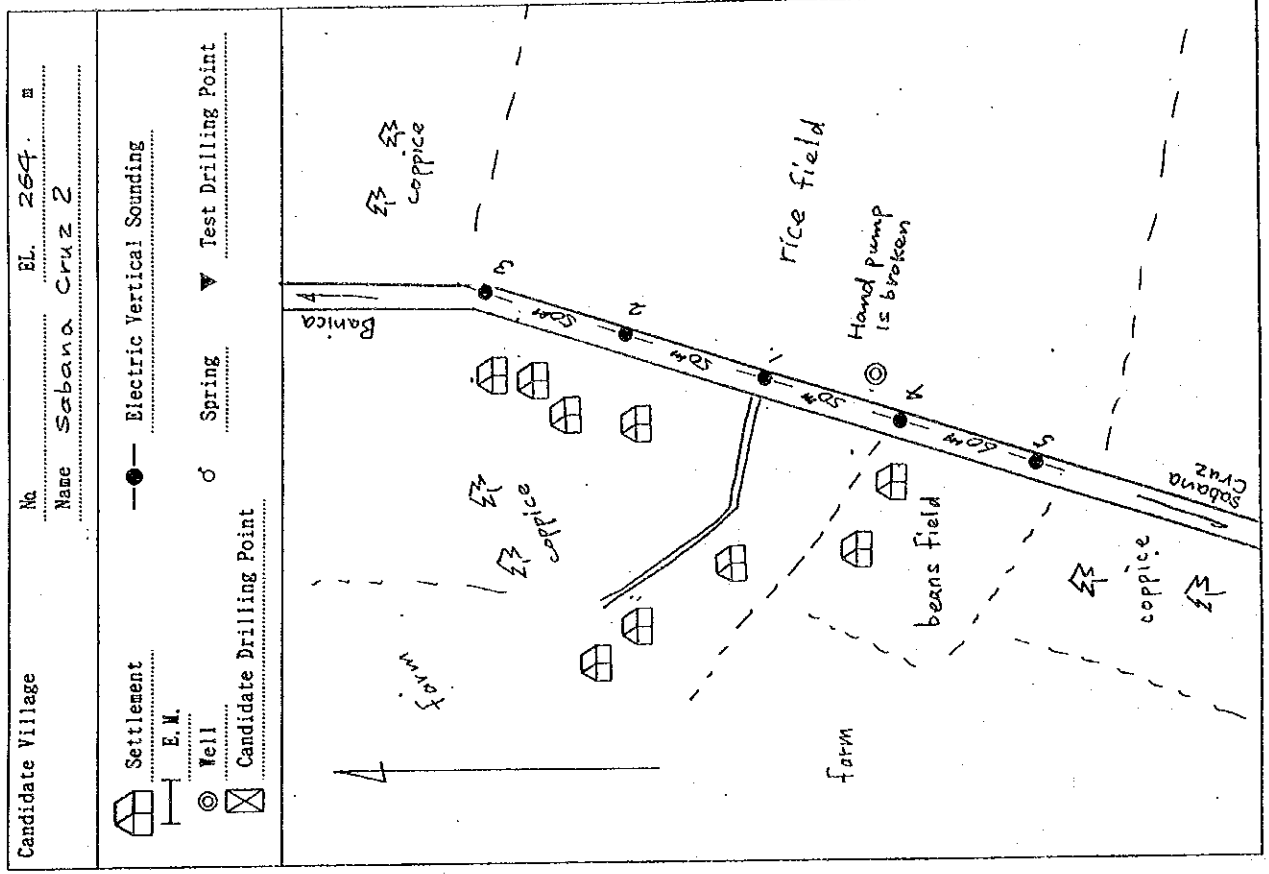

The Locations of Investigation & The Topographical Feature

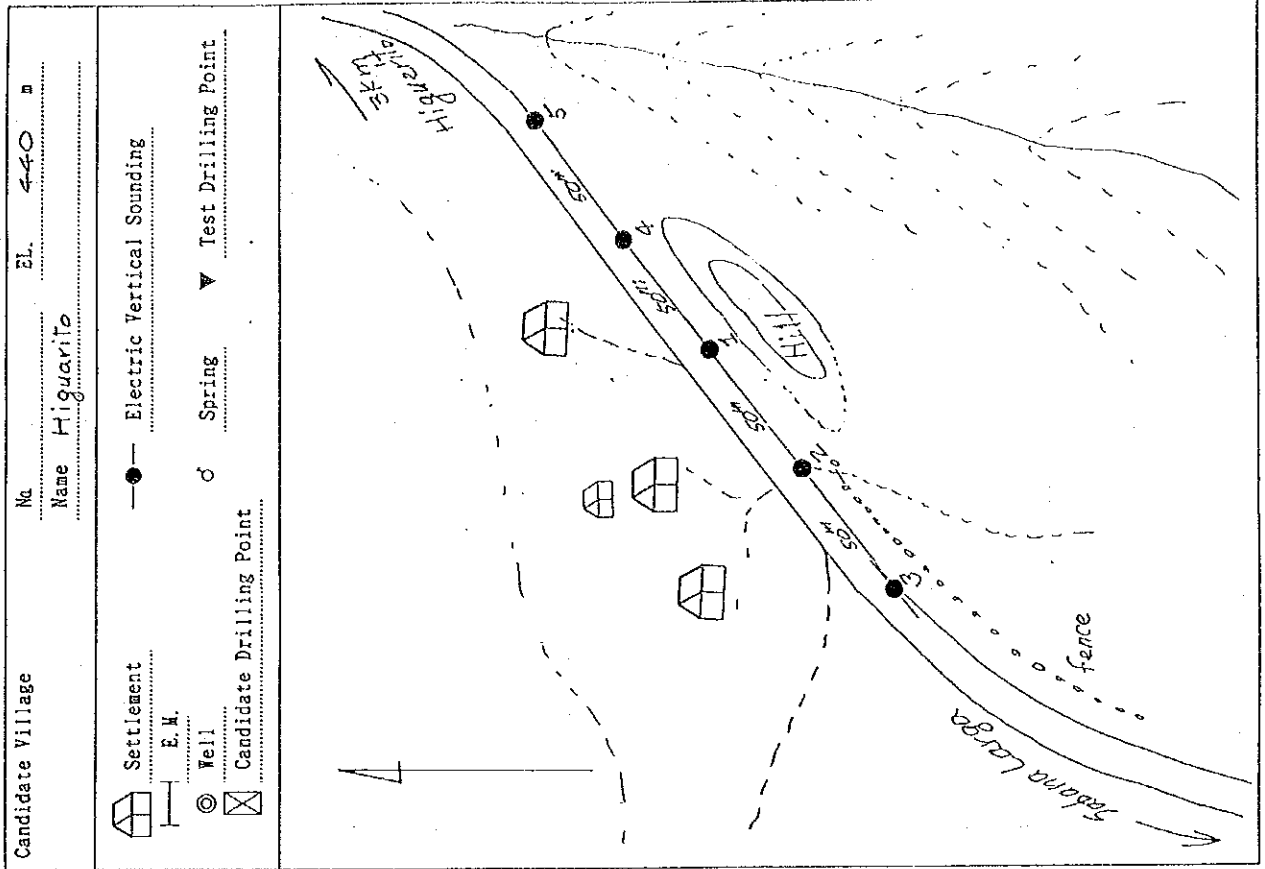

27 25

04

Higuarito

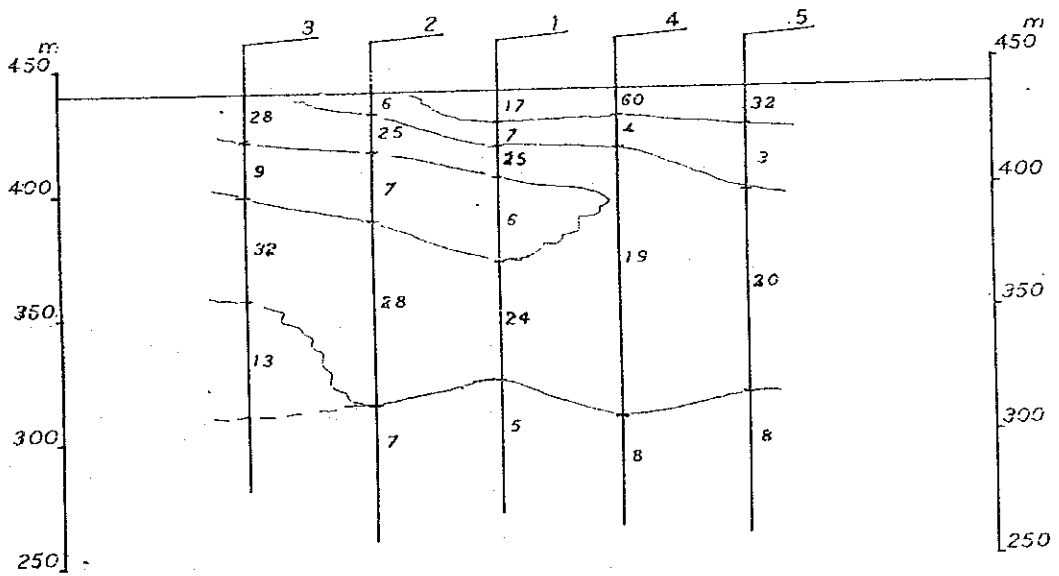

127

The Locations of Investigation & The Topographical Feature

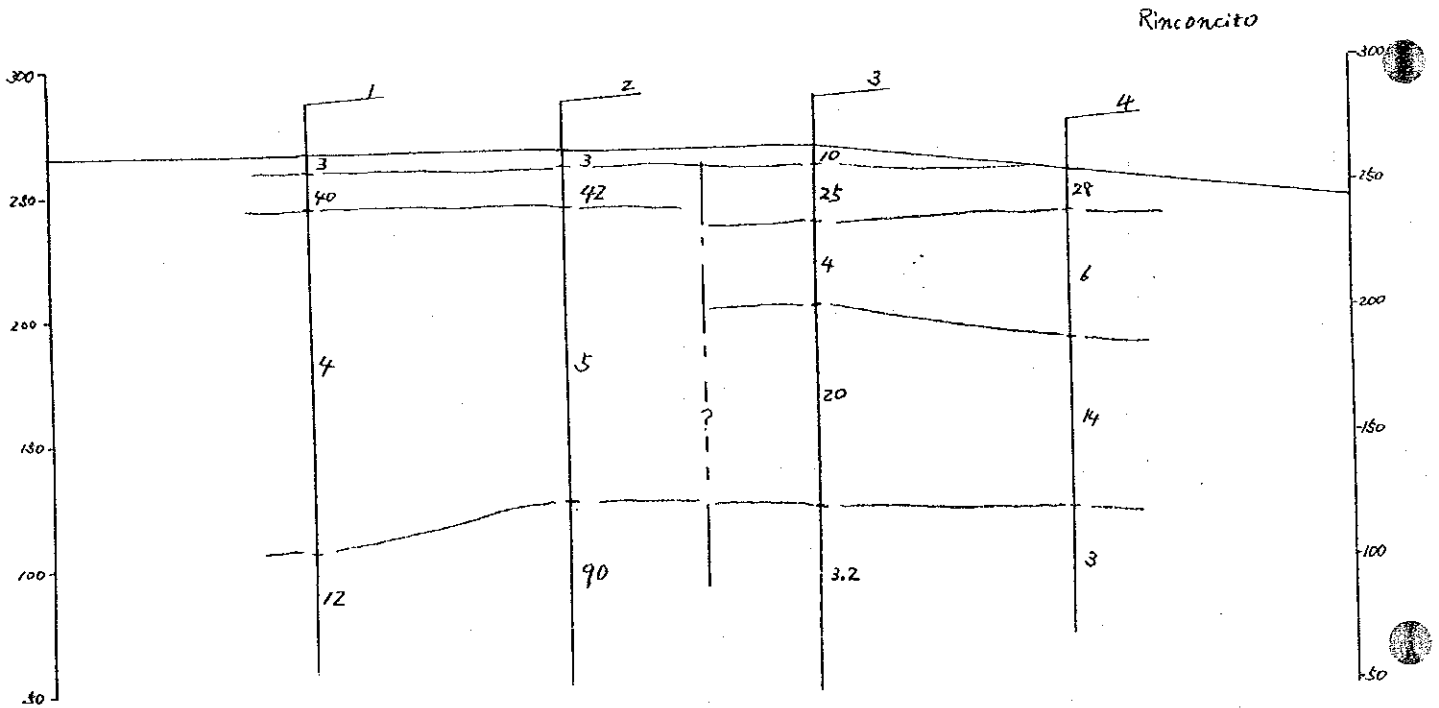
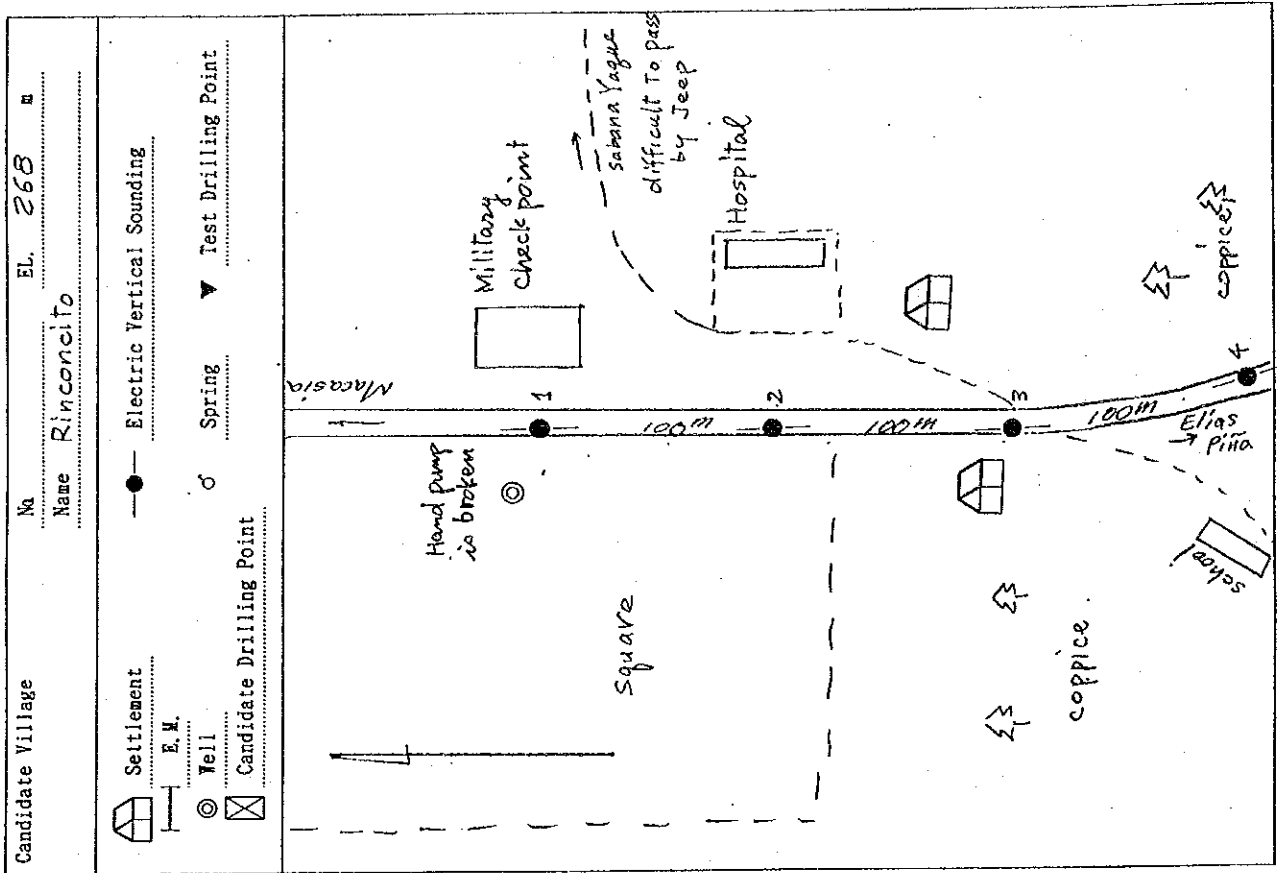

638

The Locations of Investigation & The Topographical Feature

