

図 H. Pangha 堰
No. 6 (H. Pangha Weir, Plan)

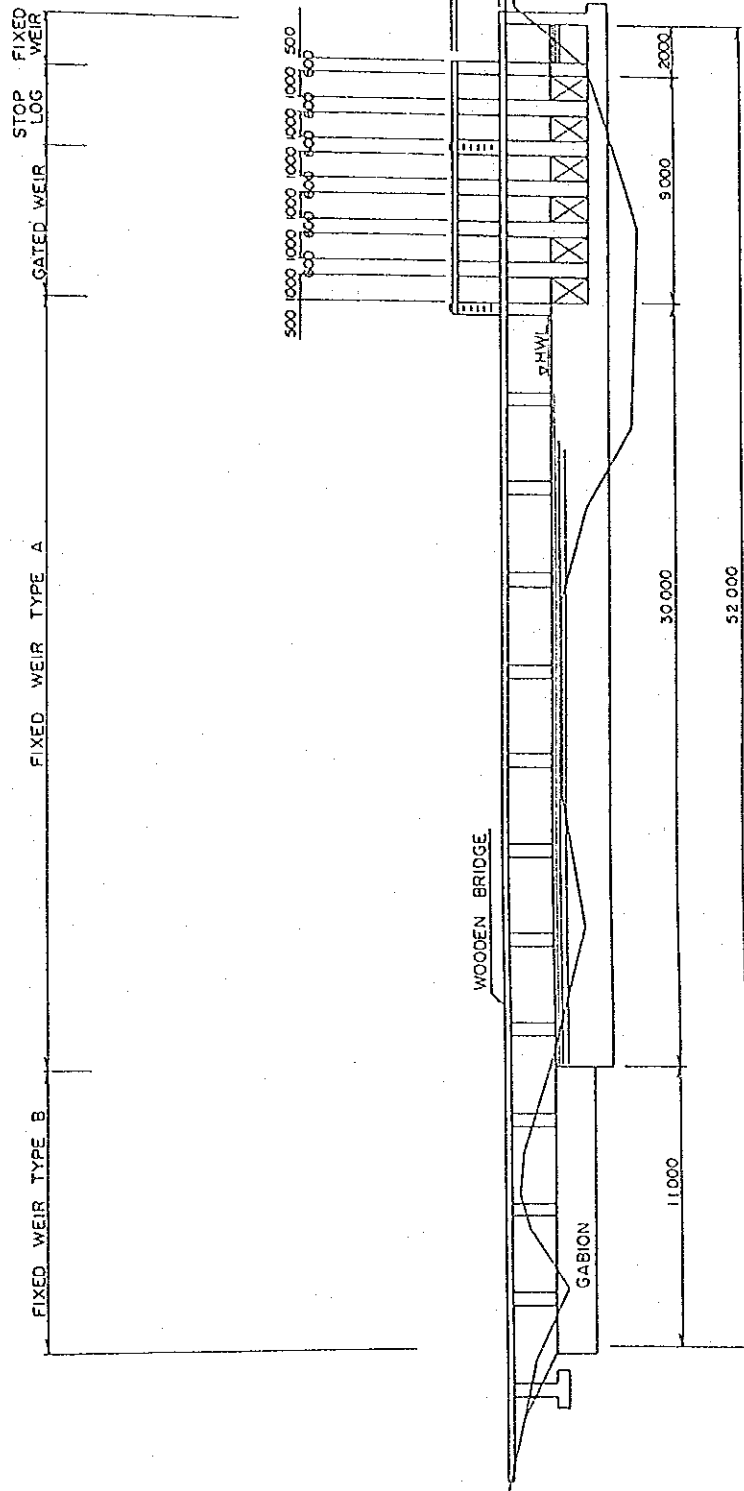

PROFILE

TITLE OF DRAWING
 NAMPHOU IRRIGATION
 No.6 DIVERSION WEIR 2/3

图 H. Pangha 堰
 No. 6 (H. Pangha Weir, Profile)



圖 展示圖一般圖

UNLINED CANAL FARM ROAD

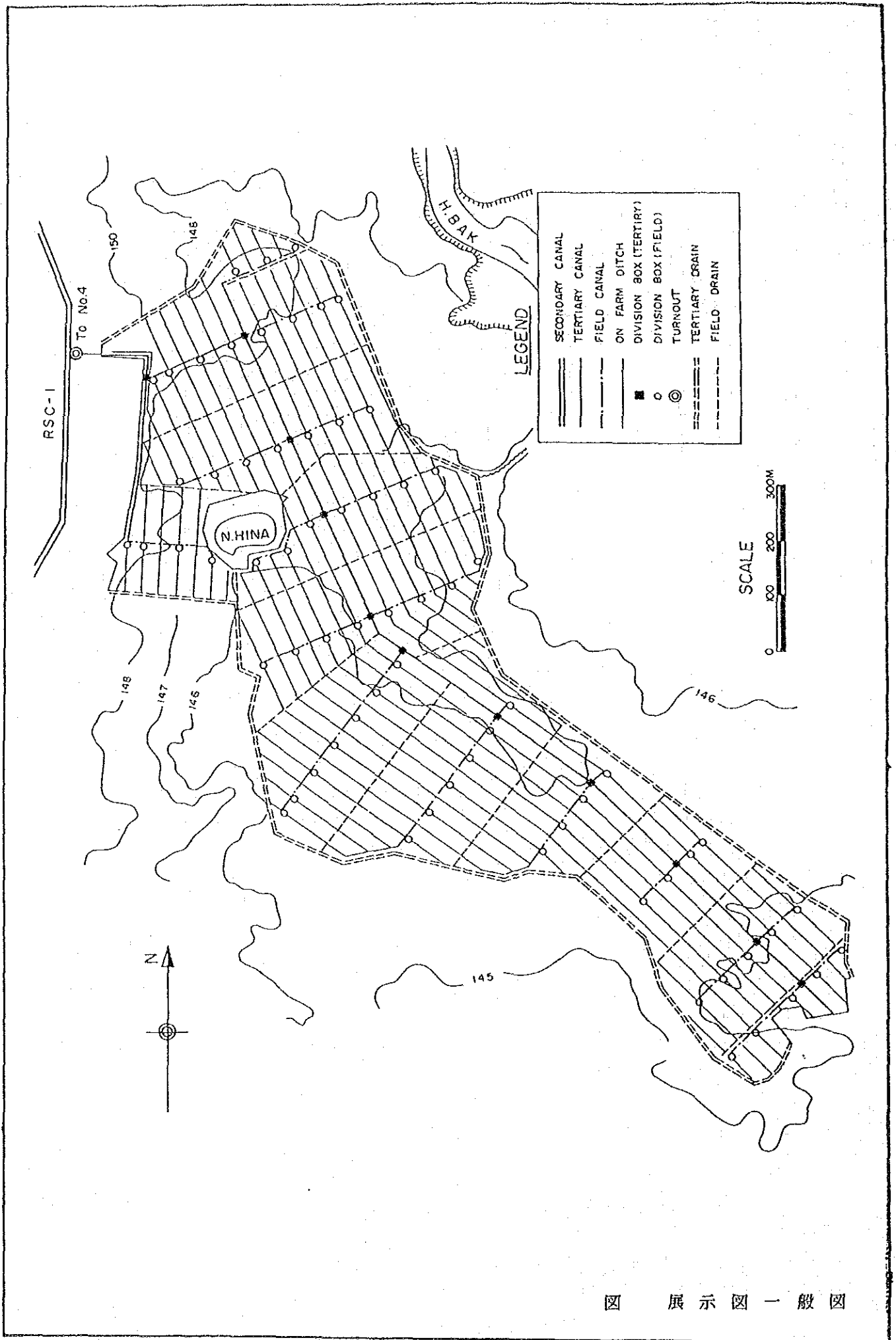
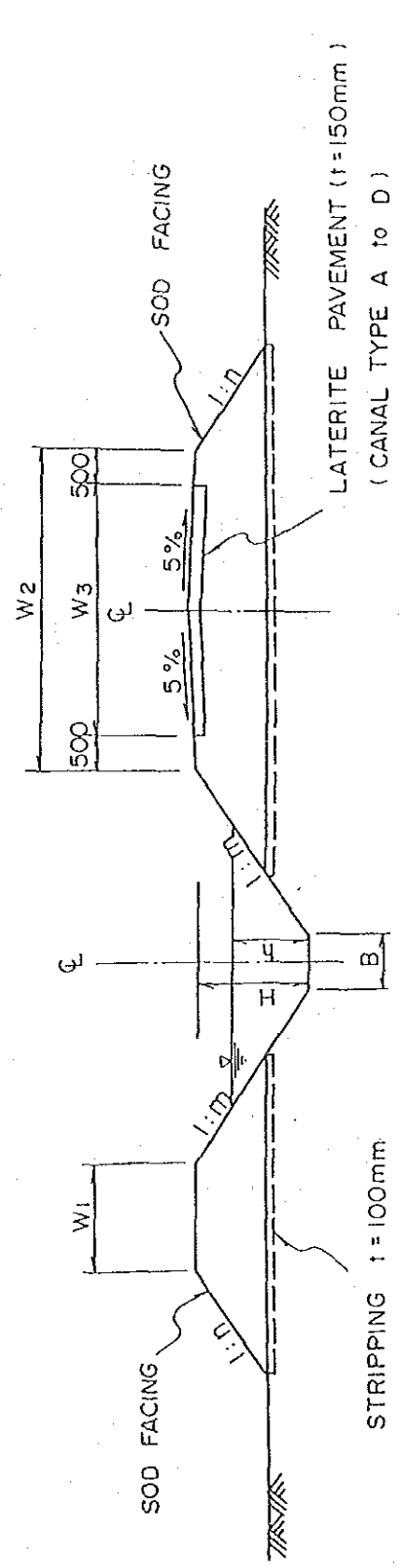

DIMENSION

UNIT : mm

CANAL TYPE	B	H	h max	W1	W2	W3	m	n
A	800	1600	1300	1500	4500	3500	1.5	1.5~2.0
B	600	1300	1000	1500	4500	3500	1.5	1.5~2.0
C	500	1100	800	1500	4500	3500	1.5	1.5~2.0
D	400	900	600	1000	4500	3500	1.5	1.5~2.0
E	400	800	600	400	3000	—	1.0	1.5
F	300	600	400	400	3000	—	1.0	1.5
G	300	500	300	300	3000	—	1.0	1.5
H	200	350	300	300	800	—	1.0	1.5
I	200	300	250	300	600	—	1.0	1.5
J	100	200	180	200	300	—	1.0	1.5



圖 用水路標準断面圖



DIMENSIONS

UNIT : mm

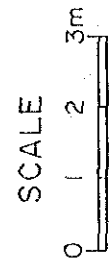
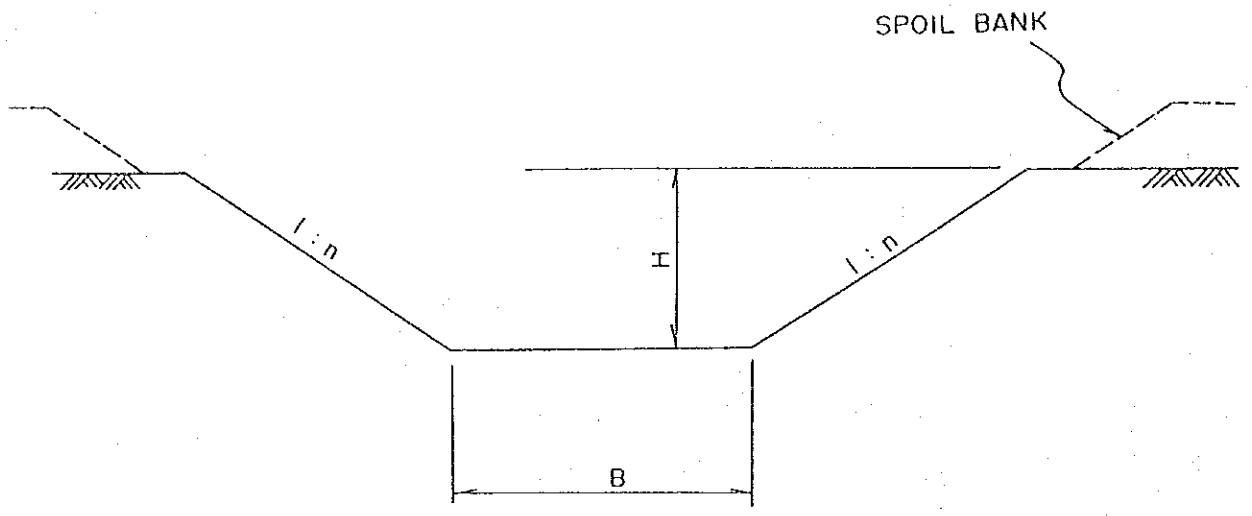
TYPE	B	H	n
A	2,000	1,200	1.5
B	1,000	800	1.5
C	700	600	1.0
D	200	150	1.0

圖 排水路標準断面圖



圖 道路改修計畫圖



TITLE OF DRAWING
 AGRICULTURAL
 SUPPORTING CENTER
 DRAWING NO. C - 1

CENTER PLAN S = 1:1000

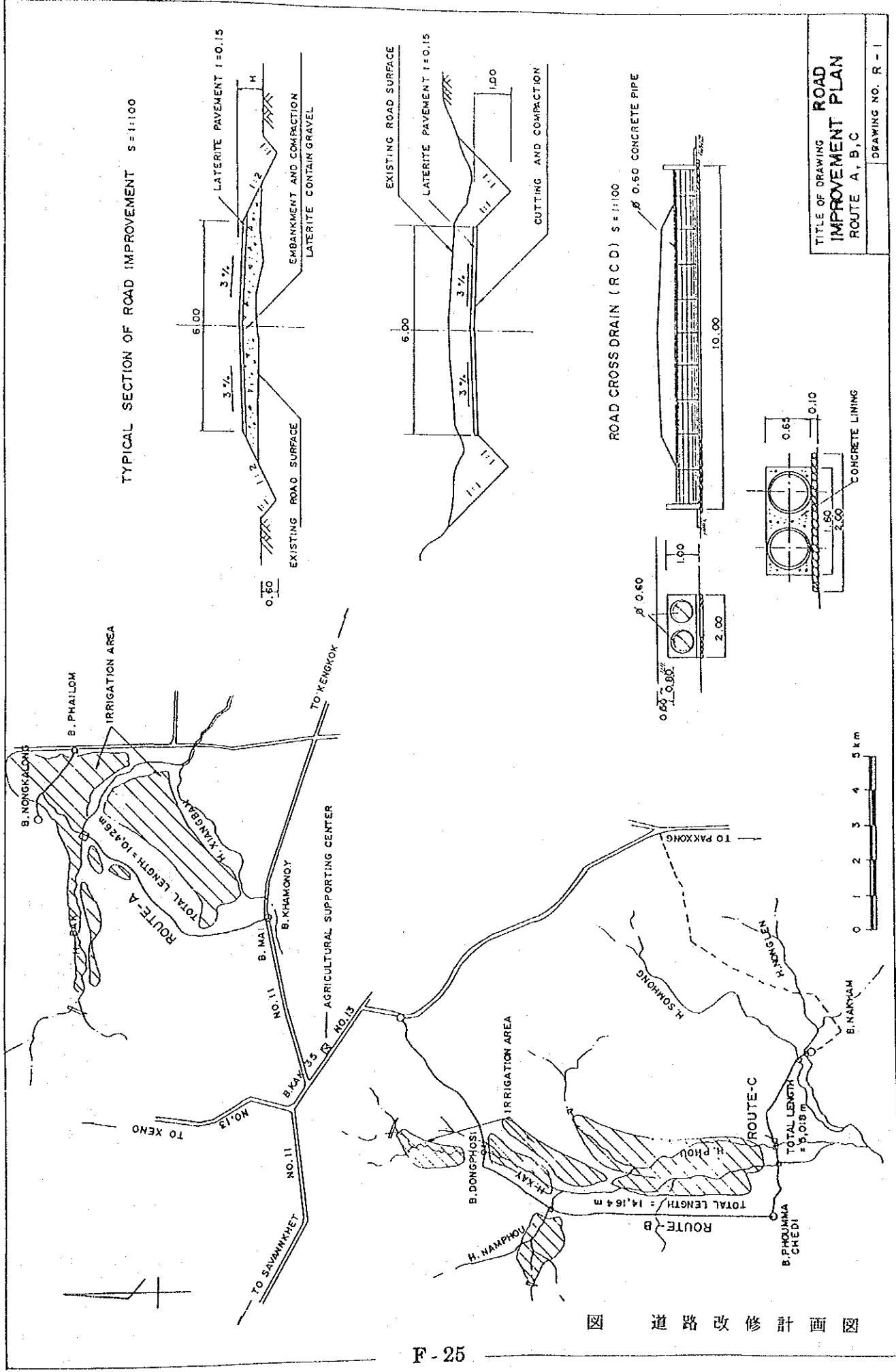
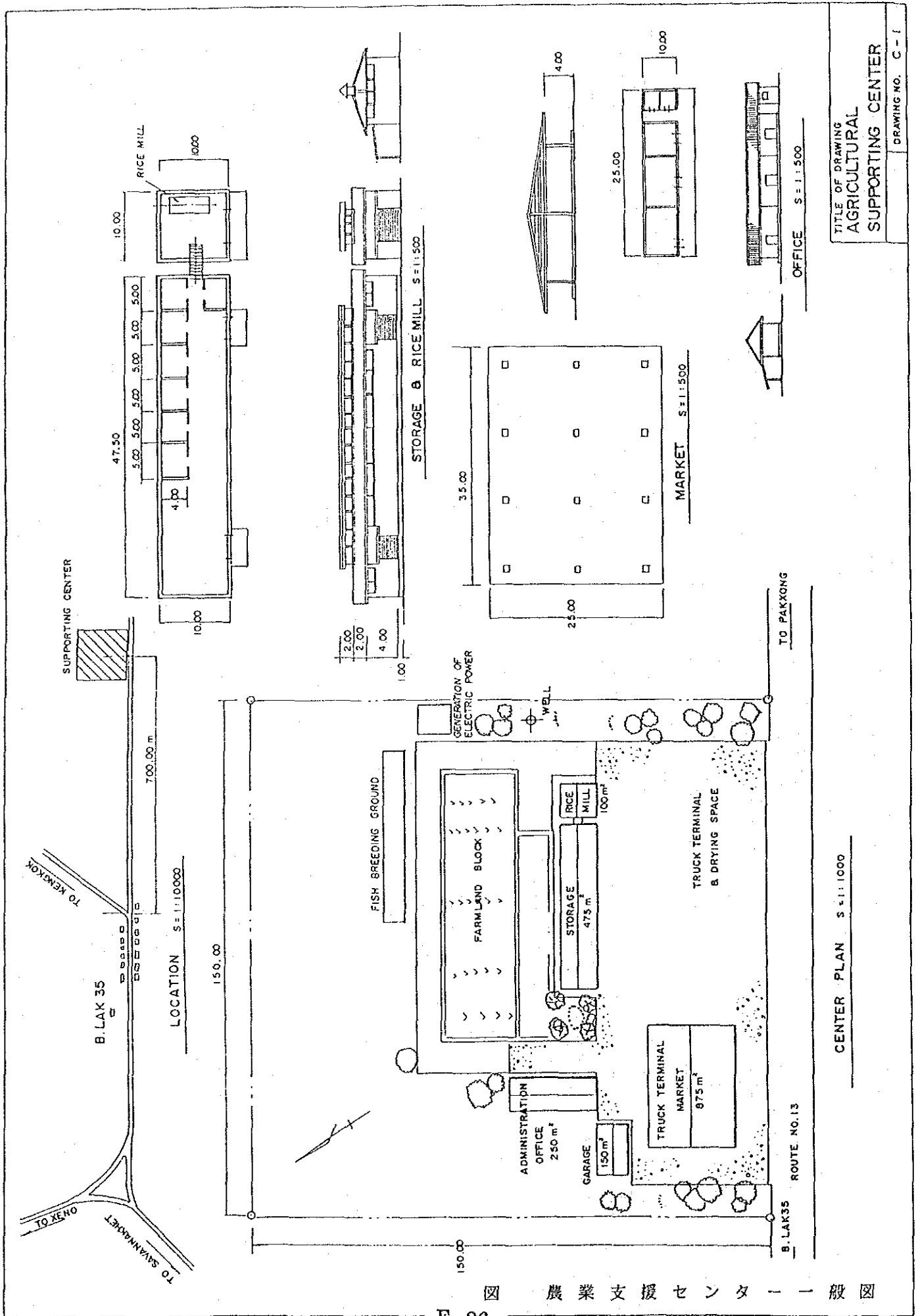
F-26 図 農業支援センター一般図

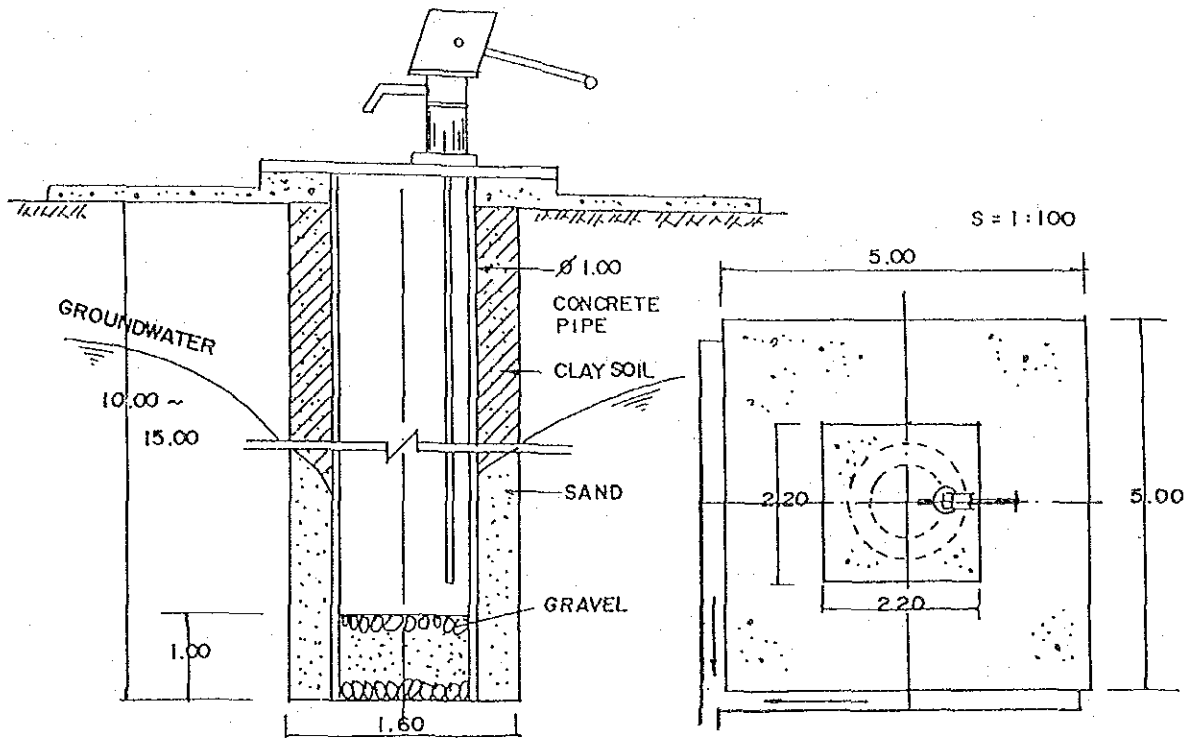

FISH BREEDING FARM S = 1:200



図 給水計画図

DRAWING NO. C-2

Works	1st Year			2nd Year			3rd Year			4th Year		
	J	J	D	J	J	D	J	J	D	J	J	D
(I) Pre-construction Work												
1. Detailed Design and Preparation of Tender Document			_____									
2. Prequalification and Tendering												
(1) Prequalification	*											
(2) Construction Work Tendering				*								
(3) Equipment Tendering					*							
3. Building of Project Office					_____							
Construction Works												
(II) Irrigation and drainage facilities												
1. Mobilization, Preparatory Works						_____						
2. N.H. Bak												
(1) N.H. Bak Reservoir												
- Dam												
- Intake/Spillway						_____						
(2) Main Canals												
(3) Secondary Canals												
(4) Tertiary Canals												
(5) Field Canals												_____
(6) Secondary Drains												_____
(7) Tertiary Drains												_____
(8) Field Drains												_____
(9) Demonstration Farm												_____
3. Namphou												
(1) No. 1 (H.Xay Reservoir)												
- Dam												
- Intake/Spillway						_____						
(2) No. 2 (Banhang Weir)												
(3) No. 3 (Phou Noy Reservoir)												
(4) No. 4 (Phou Reservoir)												
(5) No. 5 (Xay Weir)												
(6) No. 6 (Pangha Weir)												
(7) Main canals												
(8) Secondary Canals												
(9) Tertiary Canals												
(10) Field Canals												_____
(11) Tertiary Drains												_____
(12) Field Drains												_____
(III) Rural Infrastructures												
(1) Rehabilitation of village road												_____
(2) Rural water supply												_____
(V) Supporting Center												
1. B.Lak 35 center office												_____
2. Demonstration farm office												_____

付 属 資 料

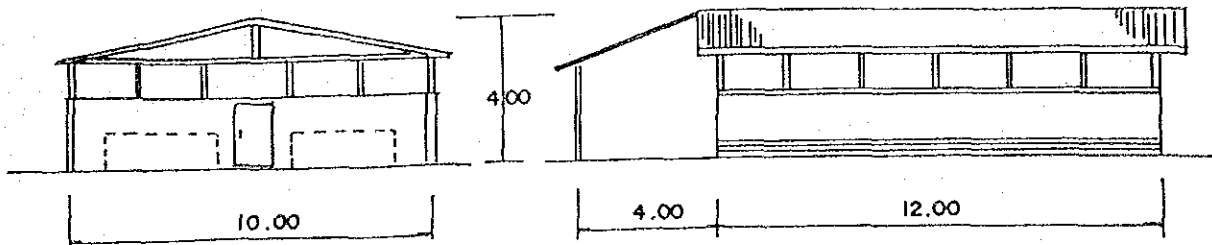
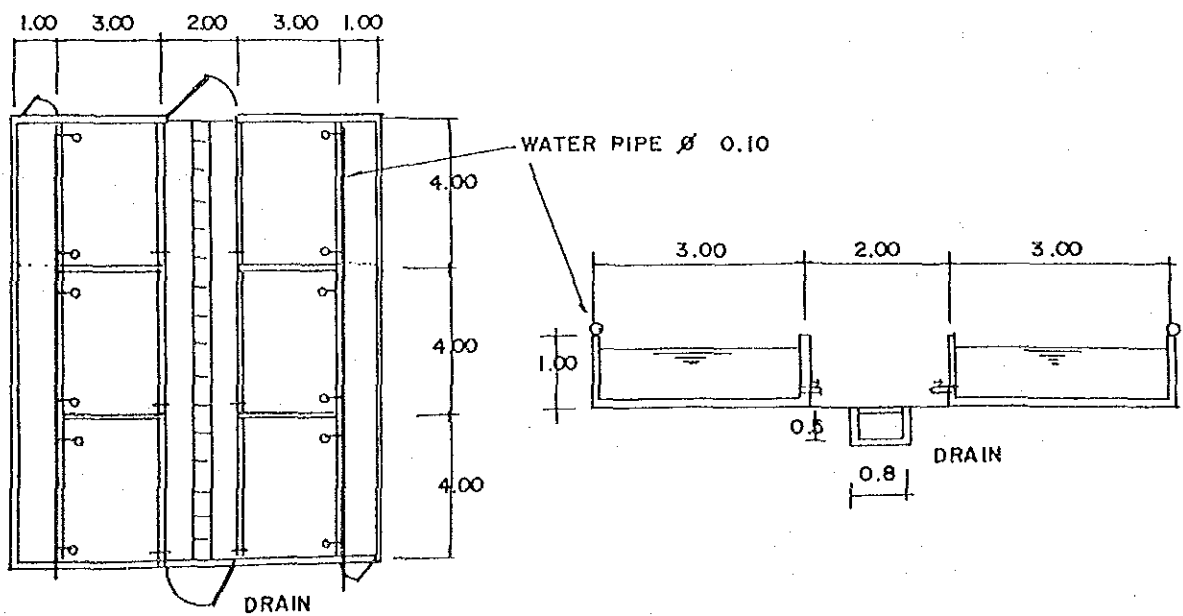
SCOPE OF WORK
FOR
THE MASTER PLAN STUDY
ON THE INTEGRATED AGRICULTURAL RURAL DEVELOPMENT PROJECT
IN SAVANNAKHET PROVINCE
IN
THE LAO PEOPLE'S DEMOCRATIC REPUBLIC
AGREED UPON BETWEEN
MINISTRY OF AGRICULTURE AND FORESTRY
OF THE LAO PEOPLE'S DEMOCRATIC REPUBLIC
AND
THE JAPAN INTERNATIONAL COOPERATION AGENCY

August 15, 1990
Vientiane, Laos

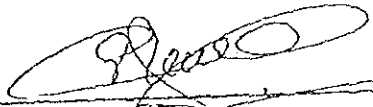
Mr. Hou Chansina
Director of Economy, Planning
and International Cooperation
Department,
Ministry of Agriculture and
Forestry

Mr. Mitsuo Goto
Team Leader,
Preliminary Survey Team,
Japan International
Cooperation Agency

I. Introduction

In response to the request of the Government of the Lao People's Democratic Republic (hereinafter referred to as "the Government") the Government of Japan has decided to conduct the Master Plan Study on the Integrated Agricultural Rural Development Project in Savannakhet (hereinafter referred to as "the Study"), in accordance with the relevant laws and regulations in force in Japan.

Accordingly, the Japan International Cooperation Agency (hereinafter referred to as "JICA"), the official agency responsible for the implementation of the technical cooperation programs of the Government of Japan, will undertake the Study, in close cooperation with the authorities concerned of the Government.

The present document sets forth the Scope of Work for the Study

II. Objective of the Study

The objective of the Study is to formulate a master plan of the Integrated Agricultural Rural Development Project in the Savannakhet Province, in which comprehensive water resources development programs are to be reviewed and developed with possible agricultural rural development projects to be identified and evaluated. The following points will be taken into consideration:

- (1) Effective use of the water resources
- (2) Increase of agricultural production
- (3) Creation of employment opportunities, and
- (4) Increase in per capital income by expanding agricultural land and improving farming systems.

III. Study Area

The study area covers a part of the Savannakhet province, which consists of Khantabuli, Champhone, Songkhone, Outhoumphone, Xaybouli, Atsaphangthong districts and the right bank of the Xe Bangkhiang which is located to the west of the village, Ban Douangmala in the Sone Bouli district.

後藤

IV. Scope of the Study

1. The Study consists of two phases.

1.1 In the first phase, the Master Plan of the Integrated Agricultural Rural Development Project is formulated, which comprises a study on the agricultural development plan consisting of such items as irrigation, drainage and social infrastructure, and possible agricultural rural development projects to be identified and grouped by priority. The top priority project area will be taken up for mapping in this phase.

1.2 In the second phase, a feasibility study on the top priority project area which is selected in the first phase is conducted.

2. Study items

2.1 Phase 1

2.1.1 Data collection and field survey

To collect and review available data and information relevant to the Study and to carry out a field survey on the following items:

(1) Natural conditions

- a. Topography
- b. Geography
- c. Meteorology
- d. Hydrology
- e. Water resources (including irrigation water requirement estimation)
- f. Geology
- g. Soil (including salinity)

(2) Social conditions

- a. Demographic characteristics (population)
- b. Social organization
- c. Socio-economy
- d. Employment
- e. Income level and distribution
- f. Education

 後藤

- g. Others
- (3) Agriculture
 - a. Farming
 - b. Land use/tenure (including farm size distribution)
 - c. Cropping patterns
 - d. Agricultural organization (support services and extension service)
- (4) Agro-economy
 - a. Farm economy
 - b. Farmers' organization
 - c. Farm inputs and productivity
 - d. Credit
 - e. Farm machinery
 - f. Marketing system
- (5) Agricultural infrastructure
 - a. Irrigation-drainage systems and diversion schemes
 - b. Operation and maintenance of the existing irrigation systems
 - c. Flood control systems
 - d. Others
- (6) Social infrastructure
 - a. Rural roads
 - b. Electricity
 - c. Water supply
 - d. Others

2.1.2 To conduct a study based on the results of the above-mentioned survey.

2.1.3. To identify projects and put them in priority order, selecting the top priority project.

2.1.4. To formulate the Integrated Agricultural Rural Development Project.

2.1.5. To estimate appropriate project costs and benefits

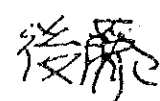
2.1.6. To evaluate the project.

2.1.7. Recommendation

2.1.8. To map the top priority project area.

2.2 Phase 2

A feasibility study on the top priority project area is conducted by the following measures.

2.2.1. To collect and review available data and information relevant to the top priority project area and carry out a field survey.

2.2.2. To determine the elements of the development plan for the top priority project, based on the analysis of the above-mentioned review and field survey.

2.2.3. To formulate the development plan for the top priority project.

2.2.4. To formulate a preliminary design of the major structures of the top priority project.

2.2.5. To prepare the implementation schedule.

2.2.6. To estimate the project costs and benefits

2.2.7. To evaluate the project.

2.2.8. Recommendation

V Study Schedule

The Study will be executed in accordance with the attached tentative



後藤

work schedule.

VI Reports

JICA shall prepare the following reports in English, and submit them to the Government.

1. Inception Report:

Twenty (20) copies at the commencement of the first phase field work.

2. Progress Report (I):

Twenty (20) copies at the end of the first phase field work.

3. Interim Report:

Twenty (20) copies at the commencement of the second phase field work

4. Progress Report (II):

Twenty (20) copies at the end of the second phase field work.

5. Draft Final Report:

Twenty (20) copies within one (1) month after the end of the second phase home office work.

The Government is requested to give comments on the draft final report within one (1) month after receiving them.

6. Final Report:

Fifty (50) copies within two (2) months after receiving the comments on the Draft Final Report.

VII. Undertaking of the Government of Lao People's Democratic Republic

1. To facilitate a smooth conduct of the Study, the Government shall take following necessary measures:

(1) To secure the safety of the Japanese study team (hereinafter

 後藤

referred to as "the Team").

- (2) To permit the members of the Team to enter, leave and ~~stay~~ return in Laos for the duration of their assignment there; ~~and~~ and exempt them from alien registration requirements and consular fees.
- (3) To exempt the members of the Team from taxes, duties and any other charges on equipments, machinery and other materials brought into Laos for the conduct of the Study.
- (4) To exempt the members of the Team from income tax and other charges of any kind imposed on or in connection with any emoluments or allowances paid to the members of the Team for their services in connection with the implementation of the Study.
- (5) To provide necessary facilities to the Team for remittance as well as utilization of the funds introduced into Laos from Japan in connection with the implementation of the Study.
- (6) To secure permission for entry into private properties or restricted areas for the conduct of the Study.
- (7) To secure permission for the Team to take all data and documents (including photographs and maps) related to the Study out of Laos to Japan.
- (8) To provide medical services as needed. Its expenses will be chargeable on members of the Team.

2. The Government shall bear claims, if any arises against the members of the Team resulting from, occurring in the course of or otherwise connected with the discharge of their duties in the implementation of the Study, except when such claims arise from gross negligence or willful misconduct on the part of the members of the Team.

3. Ministry of Agriculture and Forestry (hereinafter referred to as "MAF") shall act as the counterpart agencies to the Team and also as the coordinating body in relation with other governmental and

102 後解

non-governmental organizations concerned for the smooth implementation of the Study.

4. MAF shall, at their own expense, provide the Team with the followings in cooperation with other organizations concerned:

(1) Available data and information (including photographs and maps) related to the Study.

(2) Counterpart personnel

(3) Suitable office spaces with necessary equipments in the study area.

(4) Credentials for the members of the Study Team.

VIII. Undertaking of JICA

For the implementation of the Study, JICA shall take the following measures:

1. To dispatch, at its own expense, the Team to Laos.

2. To pursue technology transfer to counterpart personnel in the course of the Study .

IX. Consultation

The counterpart agency mentioned above and JICA shall consult with each other in respect of any matter that may arise from or in connection with the Study.

AD 後藤

TENTATIVE SCHEDULE

Item/ Month	1	2	3	4	5	6	7	8	9	10	11	12	13	14	15	16	17	18	19	20	21	22	
WORK IN LAOS		▬▬▬▬▬▬									▬▬▬▬▬▬									▬	○		
WORK IN JAPAN	▭								▭						▭								
REPORTS	△ Inc. R				△ P. R. I					△ Int. R					△ P. R. II		△ D. F. R.					△ F. R.	
MAPPING					▬▬▬▬▬▬					△ MAP													
PHASE	← PHASE I →										← PHASE II →												

(Remarks) Inc. R. : Inception Report P. R. I. II : Progress Report
 Int. R. : Interim Report D. F. R. : Draft Final Report
 F. R. : Final Report
 ○ Comments on D. F. R. by Laos side

▬▬▬▬▬▬ : Field Work
 ▭ : Home Office Work

10 後藤

MINUTES OF MEETING
FOR

THE SCOPE OF WORK FOR THE MASTER PLAN STUDY
ON THE INTEGRATED AGRICULTURAL RURAL DEVELOPMENT PROJECT
IN SAVANNAKHET PROVINCE
IN
THE LAO PEOPLE'S DEMOCRATIC REPUBLIC

August 15, 1990

Vientiane, Laos

Mr. Kou Chansina
Director of Economy, Planning
and International Cooperation
Department,
Ministry of Agriculture and
Forestry

Mr. Mitsuhiro Teto
Team Leader,
Preliminary Survey Team,
Japan International
Cooperation Agency

MINUTES OF MEETING

The Japanese Preliminary Survey Team (hereinafter referred to as "The Team") sent by the Japan International Cooperation Agency headed by Mr Mitsuhiko Goto visited the Lao People's Democratic Republic from August 9 to August 16, 1990, for the purpose of reaching agreement on the scope of work for the Master Plan Study on the Integrated Agricultural Rural Development Project in Savannakhet province of the Lao People's Democratic Republic (hereinafter referred to as "the study").

The Team had a series of discussions with the representatives of the Ministry of Agriculture and Forestry (hereinafter referred to as "MAF") before and after visiting the study area.

MAF and the Team agreed on the scope of work.

The following are the items expressed during the course of discussions:

1. MAF requested that the catchment area on the right bank of the Xe Bangfai which is located to the west of the route 13, should be included in the study area.

The Team expressed that it would take the request back to Japan for further consideration.

2. MAF requested that a flow meter and a percolation instrument may be provided by JICA for the data supplementation of the study.
3. MAF requested that a counterpart training in Japan may be provided by JICA.

後藤光弘



LIST OF PARTICIPANTS.

I. Ministry of Agriculture and Forestry

1. Mr. Kou Chansina Director of Economy, Planning and International Cooperation Dept.
2. Mr. Langsy Sayvisith Director of Irrigation Dept.
3. Mr. Alom Thavonsouk Deputy Director of Planning Dept.
4. Mr. Oudon Saysongkham Planning Dept.

II. Savannakhet Province

1. Mr. Soukaseum Phodisane Vice-governor, Savannakhet province

III. Embassy of Japan

- Mr. Hirofumi Taniguchi, Second Secretary

IV. JICA Preliminary Survey Team.

1. Mr. Mitsuhiro Goto Leader of the Team
2. Mr. Bunji Seta Rural Development
3. Mr. Shinji Lawabe Irrigation & Drainage
4. Mr. Hiroshi Fujikura Agriculture
5. Mr. Naoyuki Kobayashi Planner

後藤光弘

KW

Annex-3 Minutes of Meeting for Inception Report

MINUTES OF DISCUSSION
ON
INCEPTION REPORT
FOR
THE MASTER PLAN STUDY
ON
THE INTEGRATED AGRICULTURAL RURAL DEVELOPMENT PROJECT
IN SAVANNAKHET PROVINCE
IN
THE LAO PEOPLE'S DEMOCRATIC REPUBLIC
AGREED UPON BETWEEN
MINISTRY OF AGRICULTURE AND FORESTRY
OF THE LAO PEOPLE'S DEMOCRATIC REPUBLIC
AND
THE JAPAN INTERNATIONAL COOPERATION AGENCY

November 29, 1990
Vientiane, Laos



Mr. Kou Chansina
Director of Economy, Planning
and International Cooperation
Department,
Ministry of Agriculture and
Forestry

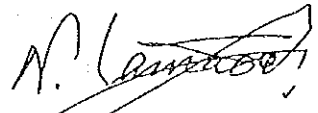

Mr. Narumi Yamada
Leader of
Master Plan Study Team,
JICA

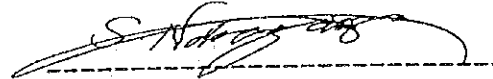

Dr. Sholchiro Nakagawa
Leader of
Advisory Mission, JICA

In response to the request of the Government of the Lao People's Democratic Republic (hereinafter referred as " the Government "), the Government of Japan dispatched the Master Plan Study Team for the Integrated Agricultural Rural Development Project in Savannakhet Province (hereinafter referred to as " the JICA Study Team ") and the Advisory Mission to the Study Team through the Japan International Cooperation Agency (JICA).

At the commencement of the Master Plan Study, Dr. Sholchiro Nakagawa of the Advisory Mission and the Team headed by Mr. Narumi Yamada submitted the Inception Report for the Study, on which views were exchanged between the Lao officials concerned headed by Mr. Kou Chansina, Director of Economy, Planning and International Cooperation Department, Ministry of Agriculture and Forestry and the Japanese side.

1. The JICA Study Team explained the contents of the Inception Report and assignment schedule on 28th November, 1990 and it was accepted by the Government.
2. The Government has agreed to assign the following counterpart personnel for the JICA Study Team :
 - Chief Counterpart
 - Hydrology / Hydraulic Engineer
 - Irrigation Engineer
 - Economist
 - Agro-pedologist
3. The Government has agreed to provide necessary office space for the JICA Study Team in Savannakhet and in Vientiane.
4. The Government has requested to the Japanese side the consideration of JICA for counterparts training in Japan during the Master Plan Study.

The list of attendants is attached in Annex 1.

S-N

N.Y.

10

LIST OF ATTENDANTS

I. Ministry of Agriculture and Forestry

- | | |
|---------------------------------|--|
| 1. Mr. Kou Chansina | Director of Economy, Planning and
International Cooperation Dept. |
| 2. Mr. Langsy Sayvisith | Director of Irrigation Dept. |
| 3. Mr. Alom Thavonsouk | Deputy Director of Planning Dept. |
| 4. Mr. Vankham Thammachak | Director of Institute of
Irrigation and Micro-Hydropowers |
| 5. Mr. Bounheme
Sinaradsvong | Irrigation Engineer, MAF |

II. Embassy of Japan

Mr. Shinji Nagashima	First Secretary
----------------------	-----------------

III. Mission

- | | |
|---------------------------|----------------------------------|
| 1. Dr. Shoichiro Nakagawa | Leader of Advisory Mission, JICA |
| 2. Mr. Mitsuhiro Ota | Advisory Mission, JICA |
| 3. Mr. Narumi Yamada | Leader of the JICA Study Team |
| 4. Mr. Kensuke Sakato | JICA Study Team |
| 5. Mr. Kazuyuki Shimazaki | JICA Study Team |

S.N.
N.Y.



MINUTES OF DISCUSSION
ON
PROGRESS REPORT
FOR
THE MASTER PLAN STUDY
ON
THE INTEGRATED AGRICULTURAL RURAL DEVELOPMENT PROJECT
IN SAVANNAKHET PROVINCE
IN
THE LAO PEOPLE'S DEMOCRATIC REPUBLIC
AGREED UPON BETWEEN
MINISTRY OF AGRICULTURE AND FORESTRY
OF THE LAO PEOPLE'S DEMOCRATIC REPUBLIC
AND
THE JAPAN INTERNATIONAL COOPERATION AGENCY

March, 20, 1991
Vientiane, Laos

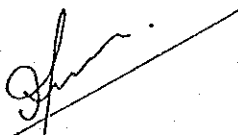

Mr. Alon THAVONESOUK
Deputy Director of Economy,
Planning and International
Cooperation Department,
Ministry of Agriculture and
Forestry

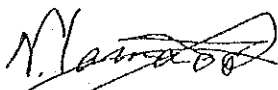

Mr. Narumi YMADA
Leader of
Master Plan Study Team,
JICA

In response to the request of the Government of the Lao People's Democratic Republic (hereinafter referred as " the Government "), the Government of Japan dispatched the Master Plan Study Team for the Integrated Agricultural Rural Development Project in Savannakhet Province (hereinafter referred to as " the JICA Study Team ") through the Japan International Cooperation Agency (JICA).

At the completion of the field work I of the Master Plan Study, the Team headed by Mr. Narumi Yamada submitted twenty (20) copies of the Progress Report for the Study, on which views were exchanged between the Lao officials concerned headed by Mr. Alom THAVONESOUK, Deputy Director of Economy, Planning and International Cooperation Department, Ministry of Agriculture and Forestry with the presence of Vice Minister, Mr. Sitaheng RASAPHON and Mr. Hirofumi TANIGUCHI, Second Secretary of Japanese Embassy.

1. The JICA Study Team explained the contents of the Progress Report and further study schedule on 20 March, 1991 and it was accepted by the Government.
2. The Government has agreed with the contents of the Progress Report and further study schedule

The list of attendants is attached in Annex 1.

N.Y.

LIST OF ATTENDANTS

I. Ministry of Agriculture and Forestry

1. Mr. Sitaheng RASAPHON Vice Minister, Ministry of Agriculture and Forestry
2. Mr. Langsy SAYVISITH Director, Department of Irrigation and Small Scall Hydropower, MAF
3. Mr. Alom THAVONESOUK Deputy Director, Department of Planning, Economic, Finance and International Cooperation, MAF
4. Mr. Phongsavang
PHOUMMAVONG Director, Department of Cooprrative and Integrated Rural Development, MAF
5. Mr. Bounoum
DOVANGPHACHANH Deputy Director, Department of Agriculture and Agricultural Extention, MAF
6. Mr. Soullivanthong
KINGKEO Assistant. to Director, Department of Livestock and Vererinary, MAF
7. Mr. Sounthone KETPHANH Assistant to Director, Department of Forestry and Environment, MAF

9

N.Y.

8. Mr. Syamphone

PHOMMALYUONG.

Assistant to Director, Department
of Economic, Planning, Finance
and International Cooperation, MAF

9. Mr. Donangxay

SINNAKONE

Director, Irrigation Project,
Xe Bangfal

10. Mr. Vanhkham

THAMMACHAK

Director, Institute of Irrigation
and Micro-Hydropower

II. Embassy of Japan

Mr. Hirofumi TANIGUCHI

Second Secretary

III. Mission

1. Mr. Narumi YAMADA

Leader of the JICA Study Team

2. Mr. Kazuyuki SHIMAZAKI

JICA Study Team, Irrigation

3. Mr. EIJI TAKEMORI

JICA Study Team,

Agroinfrastructure

IV. Observer

Mr. Yasuo ISHIGURO

JICA Mapping Study Team

91

N.Y.

MINUTES OF MEETING
ON
THE INTERIM REPORT
FOR
THE MASTER PLAN STUDY
ON
THE INTEGRATED AGRICULTURAL RURAL DEVELOPMENT PROJECT
IN SAVANNAKHET PROVINCE
AGREED UPON BETWEEN
MINISTRY OF AGRICULTURE AND FORESTRY
OF THE LAO PEOPLE'S DEMOCRATIC REPUBLIC
AND
THE JAPAN INTERNATIONAL COOPERATION AGENCY

August 28, 1991

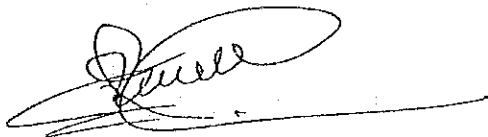

Mr. Kou CHANSINA

Director of Economy,
Planning and International
Cooperation Department,
Ministry of Agriculture and Forestry

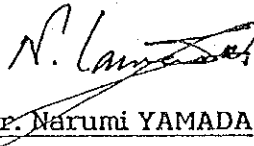

Mr. Narumi YAMADA

Leader of Master Plan
Study Team, JICA

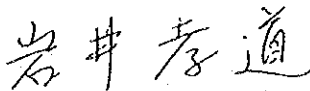

Mr. Takamichi IWAI

Leader of
Advisory Mission, JICA

In accordance with the Scope of Work for the Master Plan Study on the Integrated Agricultural Rural Development Project in Savannakhet Province (hereinafter referred to as " the Study") signed by the Government of the Lao People's Democratic Republic (hereinafter referred to as " the Government") and the Government of Japan, the Japanese Study Team headed by Mr. Narumi YAMADA conducted the Phase I Study starting in November 1990. As a result of the field work I carried out in Lao as well as its review and analysis in Japan, the Interim Report on the Study has been prepared for the consideration and analysis by the Government.

The Study Team submitted and explained the Interim Report, under an attendance of the JICA Advisory Mission headed by Mr. Takamichi IWAI, to the Government on August 23, 1991 at the presence of the Lao officials concerned headed by Mr. Alom THAVONESOUK, Deputy Director of Economy, Planning and International Cooperation Department, Ministry of Agriculture and Forestry and an exchange of opinions on the Report was made between the Lao side and the Study Team on the same day.

As a consequence of the said explanation and an exchange of opinions, it has been agreed upon between the Lao side and the Japanese Study Team as follows:

- 1, The Government received from the Study Team twenty (20) copies of the Interim Report.
- 2, The Government has agreed with the contents of the Interim Report and further study schedule.

The list of attendants is attached in Annex 1.

LIST OF ATTENDANTS

Annex 1.

1. Ministry of Agriculture and Forestry

- 1) Mr. Alom THAVONESOUK Deputy Director, Department of Economy, Planning and International Cooperation, Ministry of Agriculture and Forestry (MAF)
- 2) Mr. Inpasith THATHONGSAKD Deputy Director, Department of Irrigation and Microhydropwer, MAF
- 3) Mr. Oudone SISONKHAH Assistant, Department of Economy, Planning and International Cooperation, MAF
- 4) Mrs. Keobang A KEOLA Assistant, Department of Irrigation and Microhydropower, MAF
- 5) Mr. Lamchouan PHOUNSAVATH Technical Advisor, Cabinet Office

2. Embassy of Japan

Mr. Shinji NAGASHIMA First Secretary

3. JICA Advisory Mission

- 1) Mr. Takamich IWAI Leader of JICA Advisory Mission
- 2) Mr. Shizuo HIROSHIGE JICA Advisory Mission

4. JICA Study Team

- 1) Mr. Narumi YAMADA Leader of JICA Study Team
- 2) Mr. Kensuke SAKATO JICA Study Team
- 3) Mr. Kazuyuki SHIMAZAKI JICA Study Team
- 4) Mr. Eiji TAKEMORI JICA Study Team

MINUTES OF MEETING
ON
PROGRESS REPORT I
FOR
THE MASTER PLAN STUDY
ON
THE INTEGRATED AGRICULTURAL RURAL DEVELOPMENT PROJECT
IN SAVANNAKHET PROVINCE
IN
THE LAO PEOPLE'S DEMOCRATIC REPUBLIC
AGREED UPON BETWEEN
MINISTRY OF AGRICULTURE AND FORESTRY
OF THE LAO PEOPLE'S DEMOCRATIC REPUBLIC
AND
THE JAPAN INTERNATIONAL COOPERATION AGENCY

November, 13, 1991

Vientiane, Laos



Mr. Alom THAVONESOUK
Deputy Director of Economy,
Planning and International
Cooperation Department,
Ministry of Agriculture and
Forestry



Mr. Narumi YAMADA
Leader of
Master Plan Study Team,
JICA

In response to the request of the Government of the Lao People's Democratic Republic (hereinafter referred as " the Government "), the Government of Japan dispatched the Master Plan Study Team for the Integrated Agricultural Rural Development Project in Savannakhet Province (hereinafter referred as " the JICA Study Team ") through the Japan International Cooperation Agency (JICA)

At the completion of the Field Work I of the Master Plan Study (Feasibility Study for the Nhyod H.Bak and Namphou Agricultural Development Project), the Team headed by Mr. Narumi YAMADA submitted twenty (20) copies of the Progress Report I for the Study, on which views were exchanged between the Lao officials concerned headed by Mr. Alom THAVONESOUK, Deputy Director of Economy, Planning and International Cooperation Department, Ministry of Agriculture and Forestry.

1. The JICA Study Team submitted Progress Report I on November 11, 1991, and explained the contents on November 13, 1991 and it was accepted by the Government.
2. The Government has agreed with the contents of the Progress Report I and further study schedule.
3. The Government has hoped early execution of the Project.

The list of attendants is attached in Annex 1.

7

N.Y.

LIST OF ATTENDANTS

1. Ministry of Agriculture and Forestry (MAF)

- 1) Mr. Alom THAVONESOUK Deputy Director of Department of Economy, Planning and International Cooperation, MAF
- 2) Mr. Phouthong SENESOULINTHA Cabinet Office, MAF
- 3) Mr. Kou SENGDARA Director of Hydro-Meteorology Department, MAF
- 4) Mr. Inpasith THATHONG SAKD Irrigation and Small Hydropower Department, MAF
- 5) Mr. Oukham PIATHEP Forest and Environment Department, MAF
- 6) Mr. Khamtanh VATTANATHAM Department of Livestock and Veterinary
- 7) Mr. Latsanivong AMARATHITHADA Agriculture and Extension Department

1. JICA Study Team

- 1) Mr. Narumi YAMADA Leader of JICA Study Team
- 2) Mr. Kensuke SAKATO JICA Study Team
- 3) Mr. Kazuyuki SHIMAZAKI JICA Study Team
- 4) Mr. Ikuro INAMORI JICA Study Team

9

N.Y.

Annex-7 Minutes of Meeting for Draft Final Report.

MINUTES OF DISCUSSION
ON
DRAFT FINAL REPORT
FOR
THE MASTER PLAN STUDY
ON
THE INTEGRATED AGRICULTURAL RURAL DEVELOPMENT PROJECT
IN SAVANNAKHET PROVINCE
IN
THE LAO PEOPLE'S DEMOCRATIC REPUBLIC
AGREED UPON BETWEEN
MINISTRY OF AGRICULTURE AND FORESTRY
OF THE LAO PEOPLE'S DEMOCRATIC REPUBLIC
AND
THE JAPAN INTERNATIONAL COOPERATION AGENCY

June 3, 1992
Vientiane, Laos

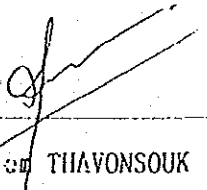

Mr. Kien THAVONSOUK
Deputy Director of Cabinet,
Ministry of Agriculture and
Forestry

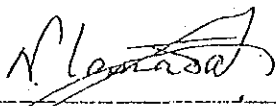

Mr. Narumi YAMADA
Leader of
Master plan Study Team,
JICA

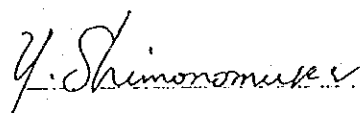

Mr. Yasubiro SHIMONOMURA
Leader of
Advisory Mission, JICA

In accordance with the Scope of Work for the Master Plan on the Integrated Agricultural Rural Development Project in Savannakhet Province (hereinafter referred to as 'the Study') signed by the Government of the Lao People's Democratic Republic (hereinafter referred to as the Government) and the Japan, the Japanese Study Team headed by Mr. Narumi YAMADA conducted the Study starting in November 1990. As a result of the study in the Phase1 and Phase2, the Draft Final Report has been prepared for the consideration and analysis by the Government.

The Study Team submitted and explained the Draft Final Report, under an attendance of the JICA Advisory Mission headed by Mr. Yasuhiro SHIMONOMURA, to the Government on June 1, 1992 at the presence of the Lao officials concerned headed by Mr. Alom THAVONSOUK, Deputy Director of Cabinet, Ministry of Agriculture and Forestry, and an exchange of opinions on the Report was made between the Lao side and the Study Team on the same day.

As a consequence of the said explanation and an exchange of opinions, it has been agreed upon between the Lao side and the Japanese Study Team as follows:

1. The Government received from the Study Team twenty (20) copies of the Draft Final Report.
2. The Government has agreed with the contents of the Draft Final Report.
3. The Government will send comments on the Report within one (1) month from the reception of the Report.

The list of attendants is attached in Annex 1.

Ny. JS

Annex 1

LIST OF ATTENDANTS

1. Ministry of Agriculture and Forestry

- 1) Mr. Alom THAYONSOUK Deputy Director of Cabinet,
Ministry of Agriculture and Forestry (MAF)
- 2) Mr. Soukaseum BODHISANE Vice Governor,
Director of Agricultural and Forestry Services,
Savannakhet Province
- 3) Mr. Latsaolsang AMARATHITHANA
Deputy Director of Agricultural and Extension
Department, MAF
- 4) Mr. Somchithi THONGPANHUEUANGSY
Irrigation Department, MAF

2. Embassy of Japan

- 1) Mr. Kiyoshi OMAMEUDA Second Secretary, Embassy of Japan

3. JICA Advisory Mission

- 1) Mr. Yasuhiro SHIMONOMURA Leader of JICA Advisory Mission
- 2) Mr. Shizuo HIROSHIGE JICA Advisory Mission

4. JICA Study Team

- 1) Mr. Narumi YAMADA Leader of JICA Study Team
- 2) Mr. Kensuke SAKATO JICA Study Team
- 3) Mr. Shigekazu FUJISATA JICA Study Team

2. Y. YS

JICA