

PUBLIC STAND PIPE (KIOSK) FOR SYSTEM-1 & SYSTEM-2

Plan of Public Stand Pipe

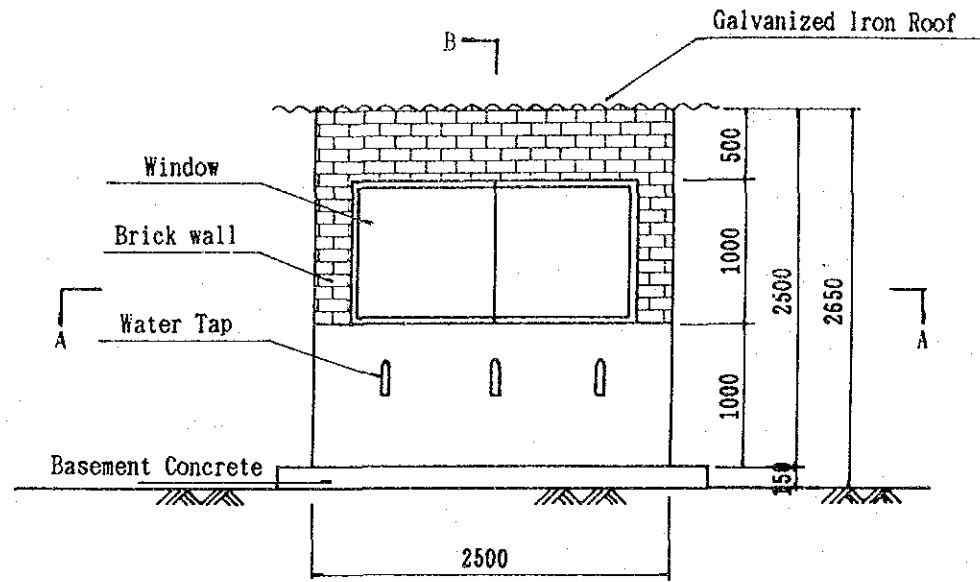

Front View

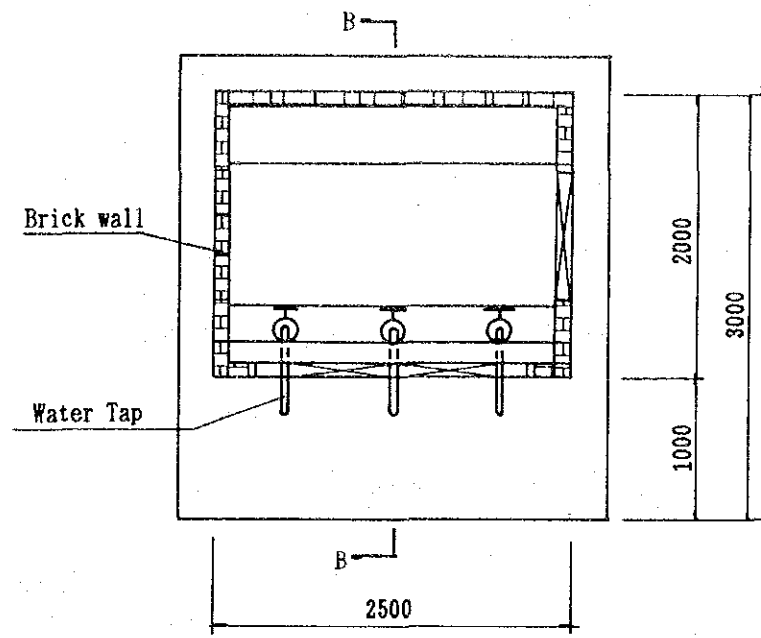

Section A-A

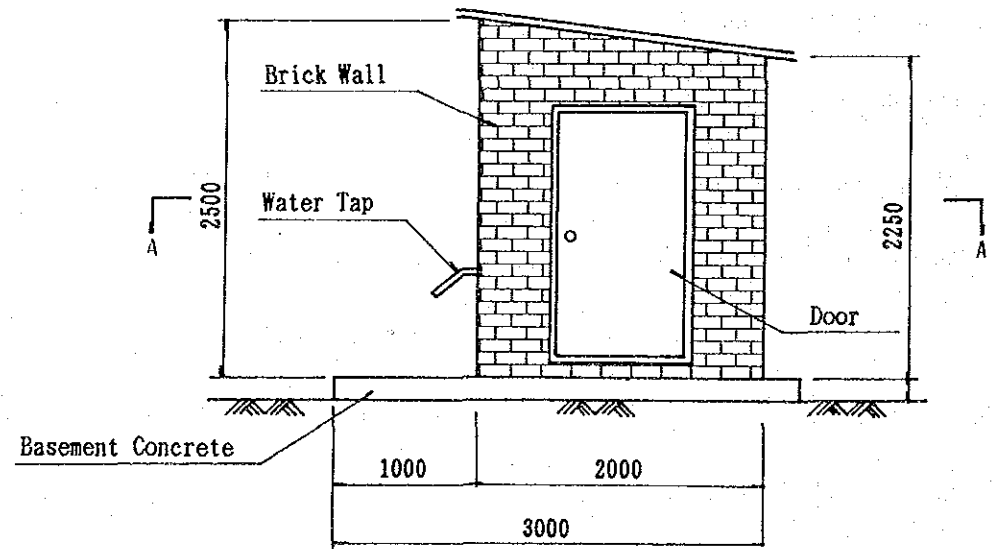

Side View

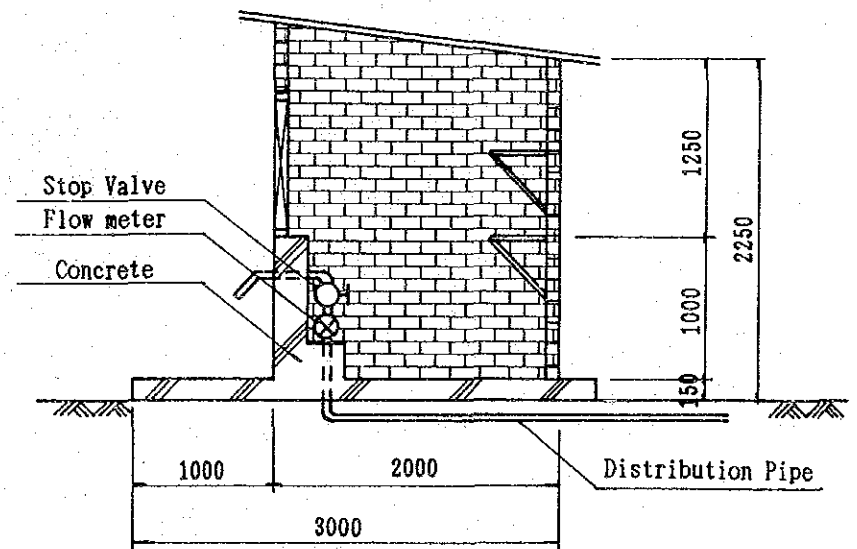

Section B-B

REPUBLIC OF RWANDA			
MINISTRY OF PUBLIC WORKS, ENERGY AND WATER			
BASIC PLAN OF RURAL WATER SUPPLY PROJECT IN THE EASTERN REGION (PHASE III)			
PUBLIC STAND PIPE (KIOSK) FOR SYSTEM-1 & SYSTEM-2			
DESIGNED BY			
DATE	SCALE	OWG. NO.	6-4
JAPAN INTERNATIONAL COOPERATION AGENCY (JICA)			

GENERAL LAYOUT OF BASIC PLAN

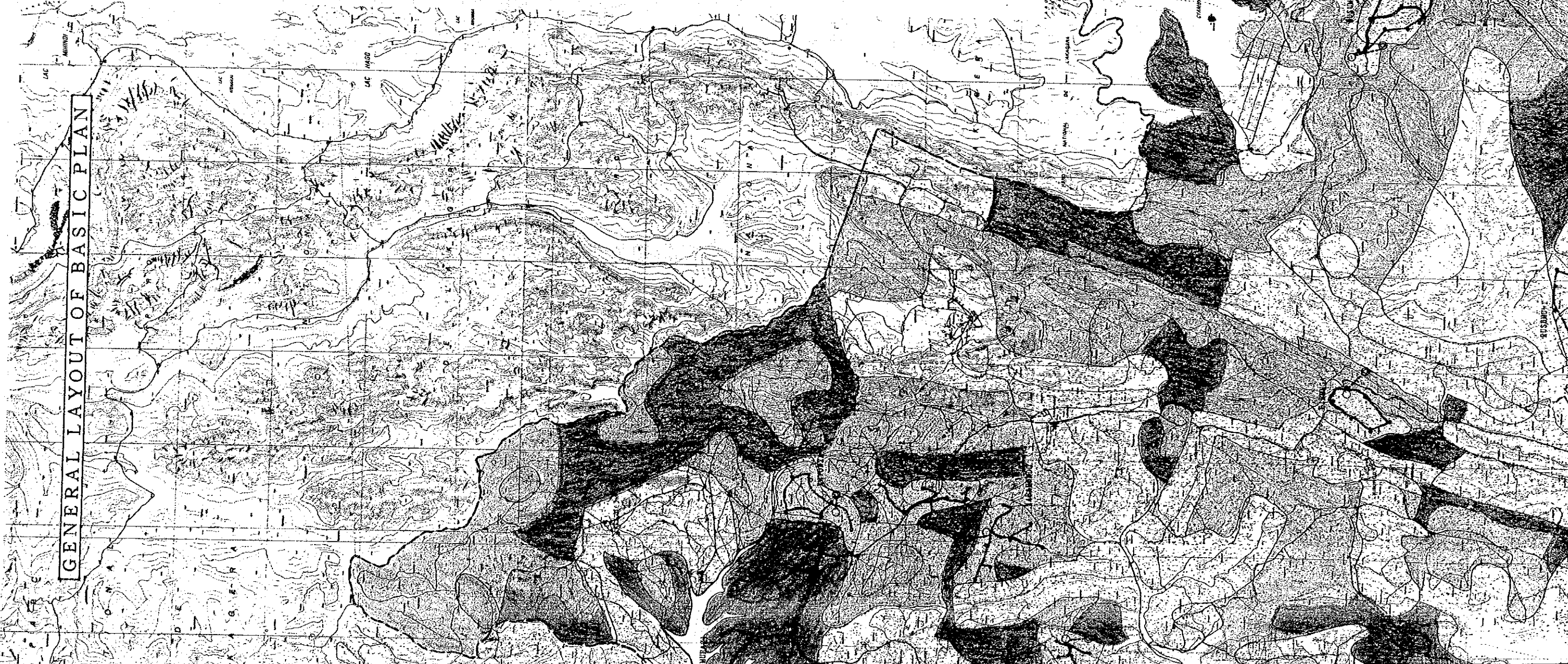
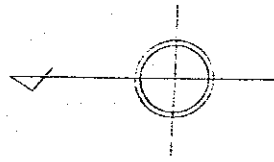

LEGEND	
[Pattern]	SYSTEM-1 (POSSIBLE PROJECT)
[Pattern]	SYSTEM-2
[Pattern]	SYSTEM-2 (POSSIBLE PROJECT)
[Pattern]	SYSTEM-3
[Pattern]	SYSTEM-3 (POSSIBLE PROJECT)
[Pattern]	SYSTEM-4
[Pattern]	THE OTHER PROJECT AREA
[Pattern]	THE BOUNDARY OF THE BENEFICIAL AREA
[Symbol]	STAND PIPE
[Symbol]	PIPE LINE
[Symbol]	TRANSMISSION PIPE
[Symbol]	PUMP STATION
[Symbol]	RESERVOIR TANK
[Symbol]	WATER PURIFICATION STATION

T A N Z A N I A

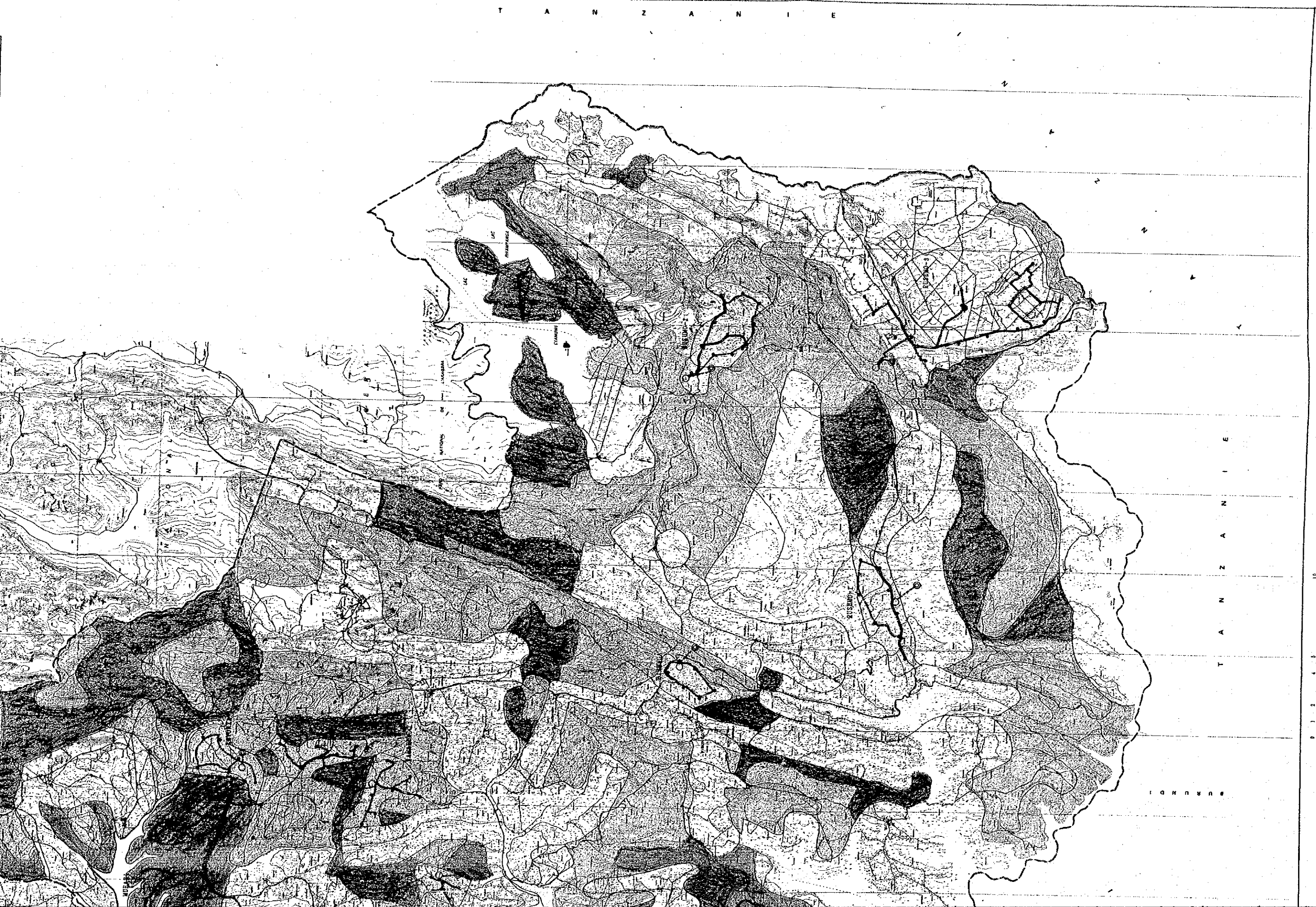

0 10 20 km

T A N Z A N I A

1 0 0 0 0 0 0 0 0 0

GENERAL LAYOUT OF BASIC PLAN



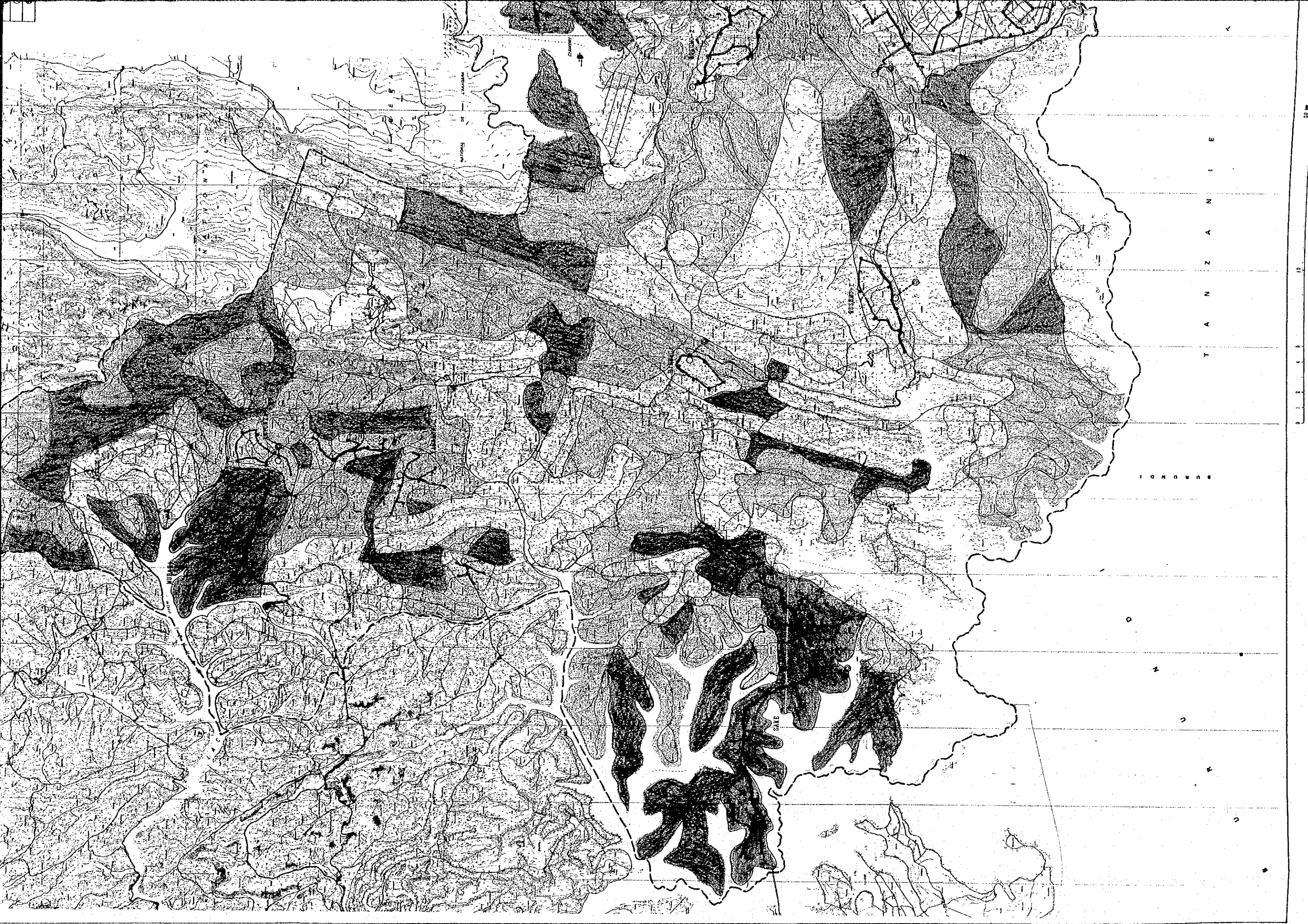

T
A
N
Z
A
N
I
E

IGNORRE

