

LEGEND	FIG :
	AC 2
SOURCE	: JICA STUDY TEAM
SCALE	: AS SHOWN
DATE OF DRAWING	: 1990. 12. 31
The Study on River Environment Improvement for The Tributaries of Han River System in Seoul Municipality and Its Vicinity	

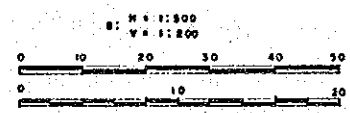

LEGEND	FIG. :
	AC 3
	SOURCE : JICA STUDY TEAM
	SCALE : AS SHOWN
	DATE OF DRAWING : 1990. 12. 31
The Study on River Environment Improvement for The Tributaries of Han River System in Seoul Municipality and Its Vicinity	

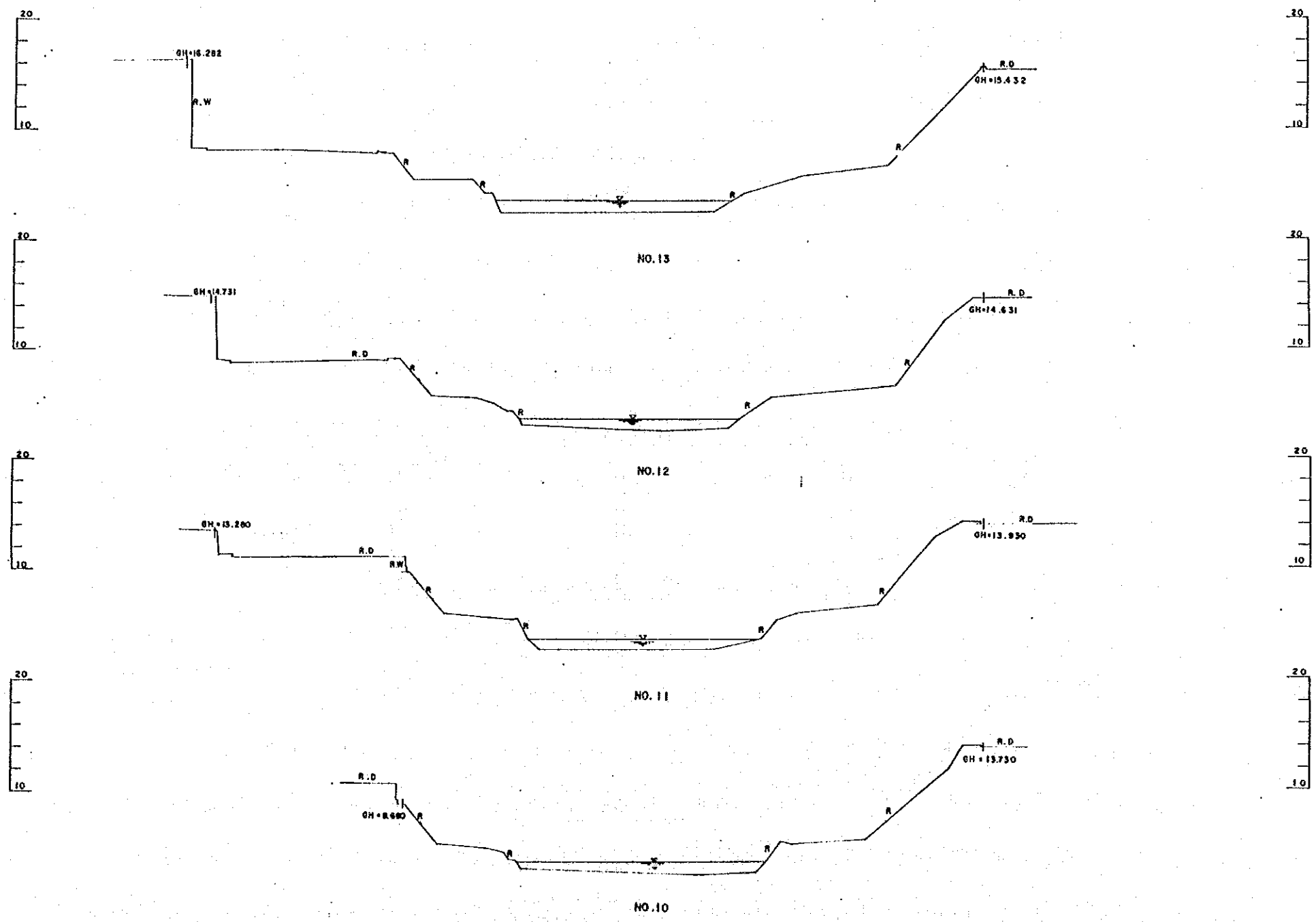
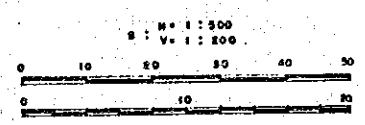
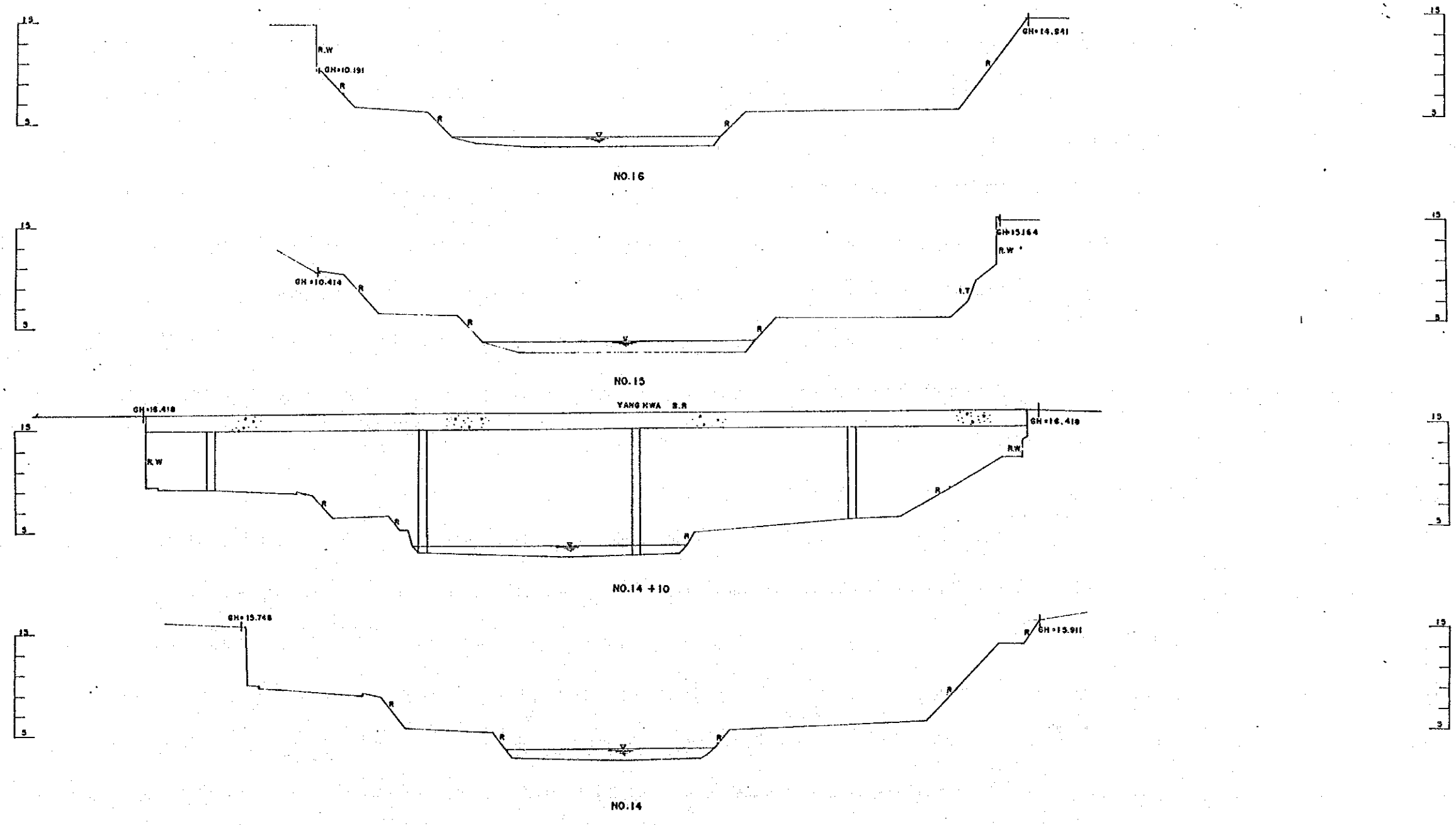

LEGEND	FIG :
	AC 4
	SOURCE : JICA STUDY TEAM
	SCALE : AS SHOWN
	DATE OF DRAWING : 1990. 12. 31
The Study on River Environment Improvement for The Tributaries of Han River System in Seoul Municipality and Its Vicinity	

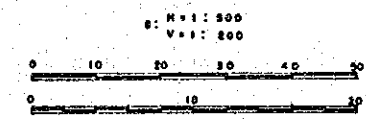
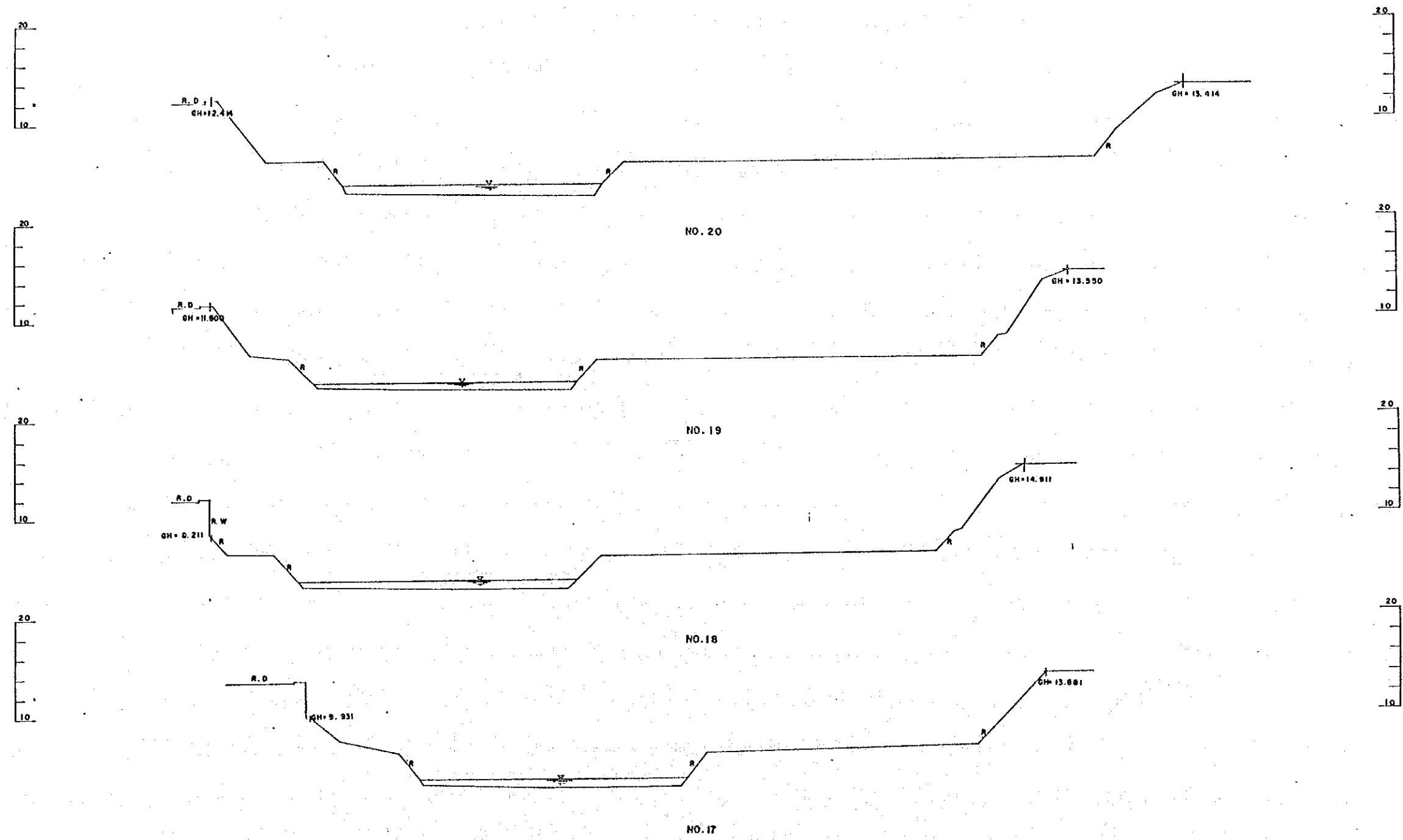

LEGEND	FIG
	AC 5
	SOURCE : JICA STUDY TEAM
	SCALE : AS SHOWN
	DATE OF DRAWING : 1990. 12. 31
The Study on River Environment Improvement for The Tributaries of Han River System in Seoul Municipality and Its Vicinity	

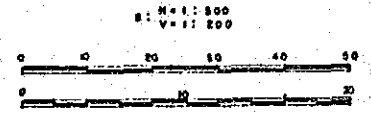
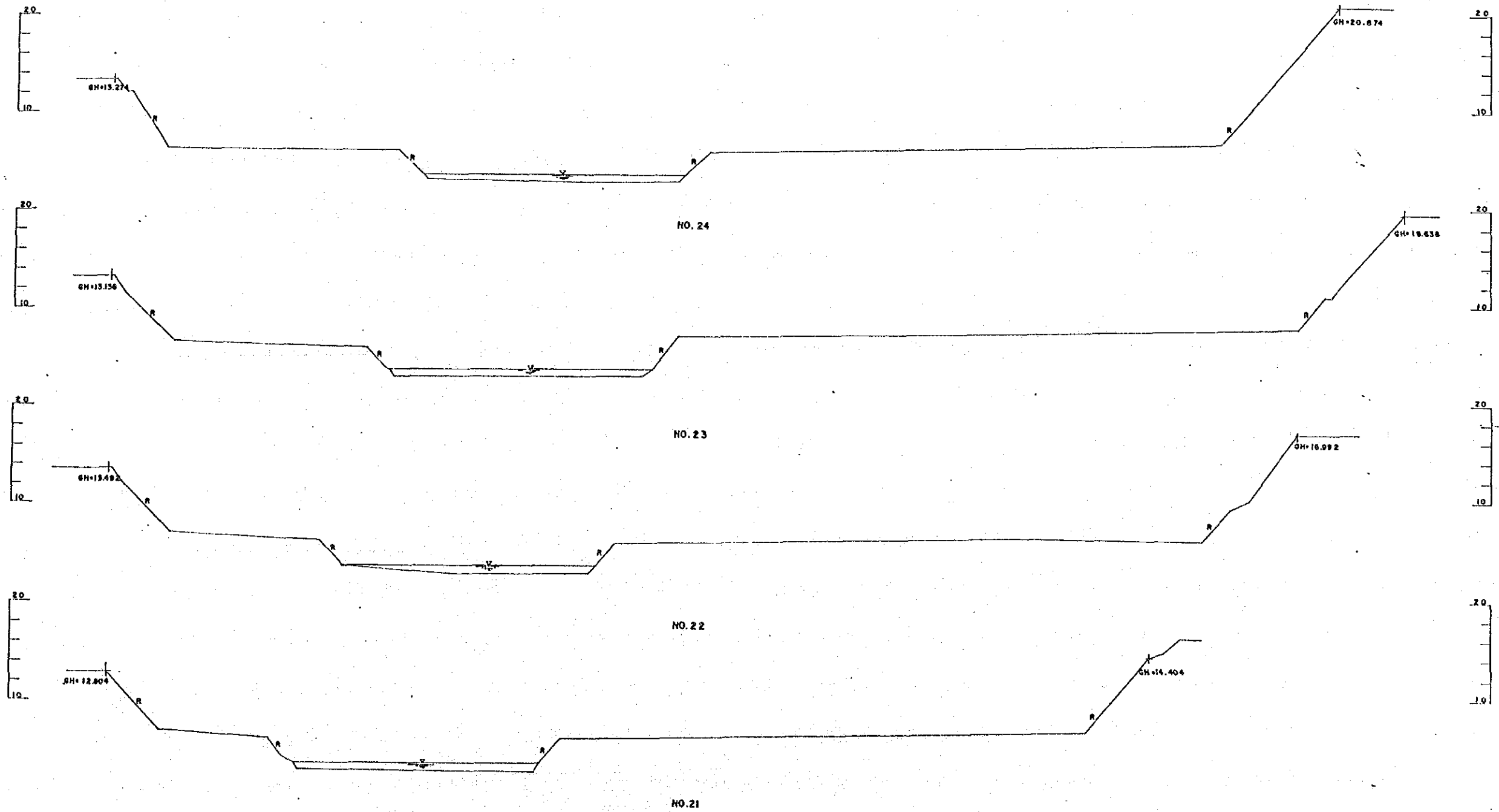

LEG/NO	FIG
	AC 6
SOURCE	JICA STUDY TEAM
SCALE	A3 BROWN
DATE OF DRAWING	1990.12.31

The Study on River Environment Improvement for The Tributaries of Han River System in Seoul Municipality and Its Vicinity

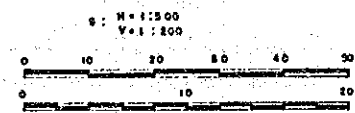
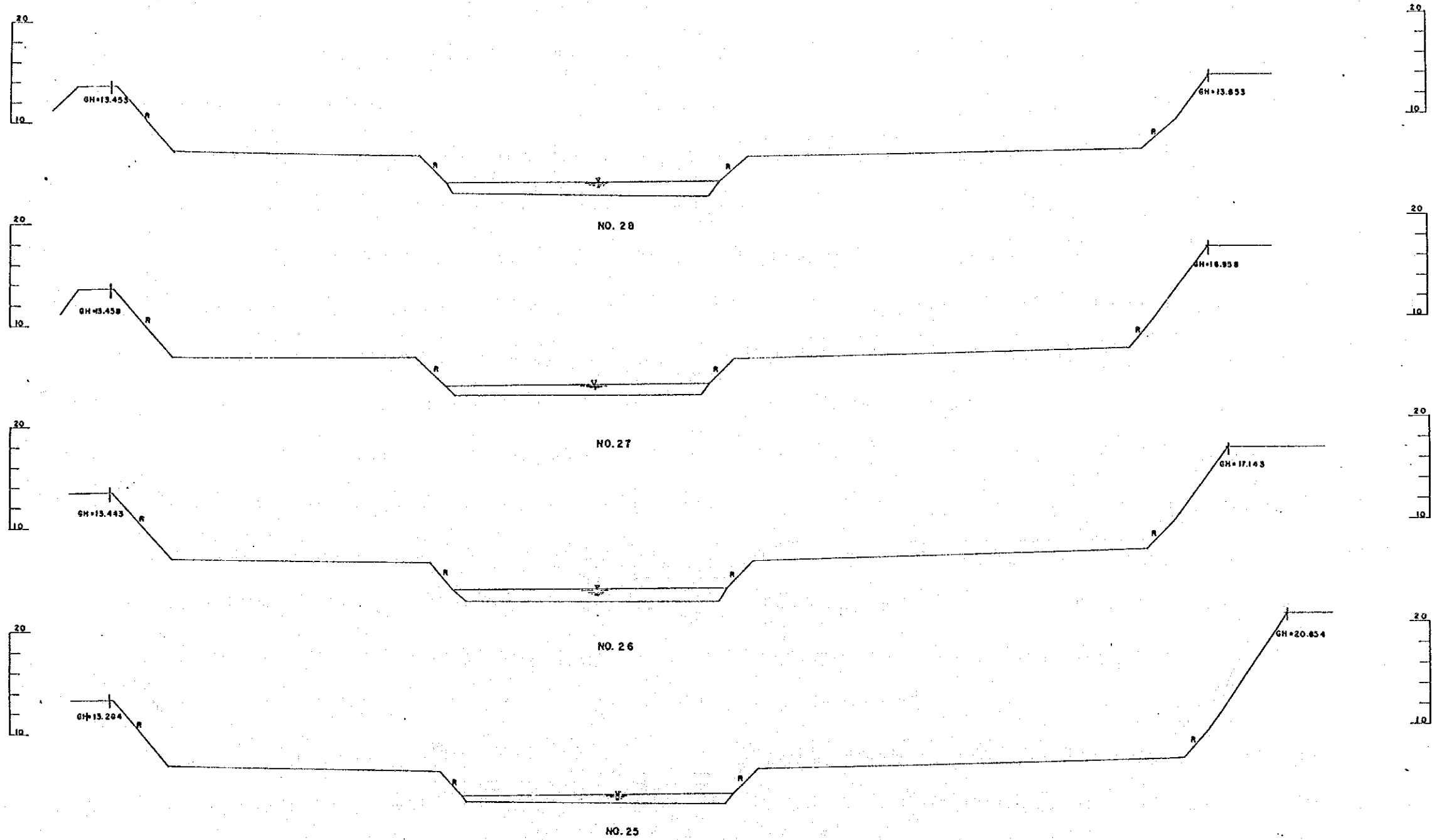

LEGEND	FIG
	AC 7
SOURCE	JICA STUDY TEAM
SCALE	AS SHOWN
DATE OF DRAWING	1990. 12. 31
The Study on River Environment Improvement for The Tributaries of Han River System in Seoul Municipality and Its Vicinity	

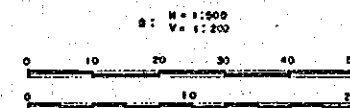
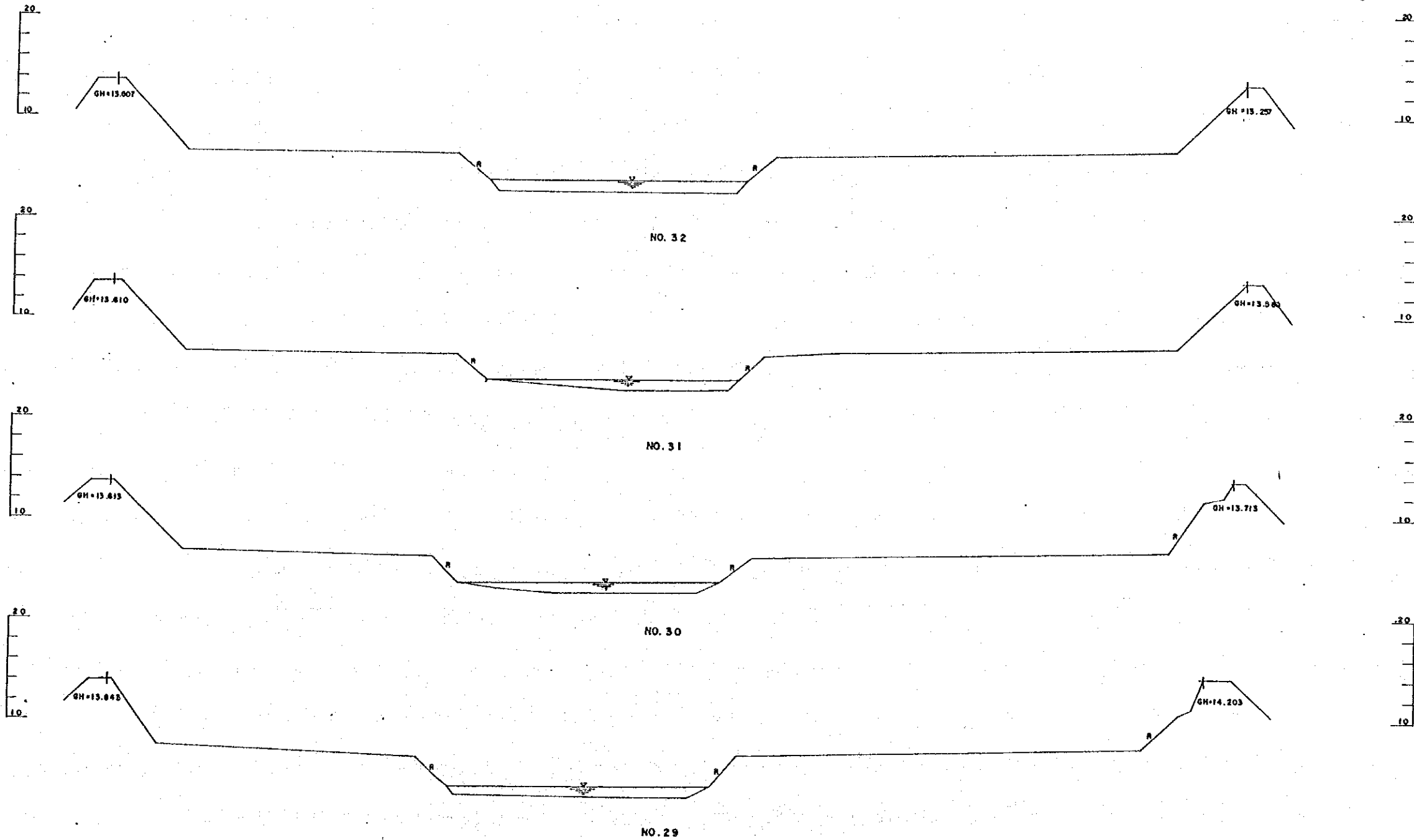

LEGEND	FIG
	AC 8
	SOURCE : JICA STUDY TEAM
	SCALE : AS SHOWN
	DATE OF DRAWING : 1990.12.31
The Study on River Environment Improvement for The Tributaries of Han River System in Seoul Municipality and Its Vicinity	

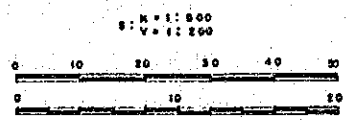
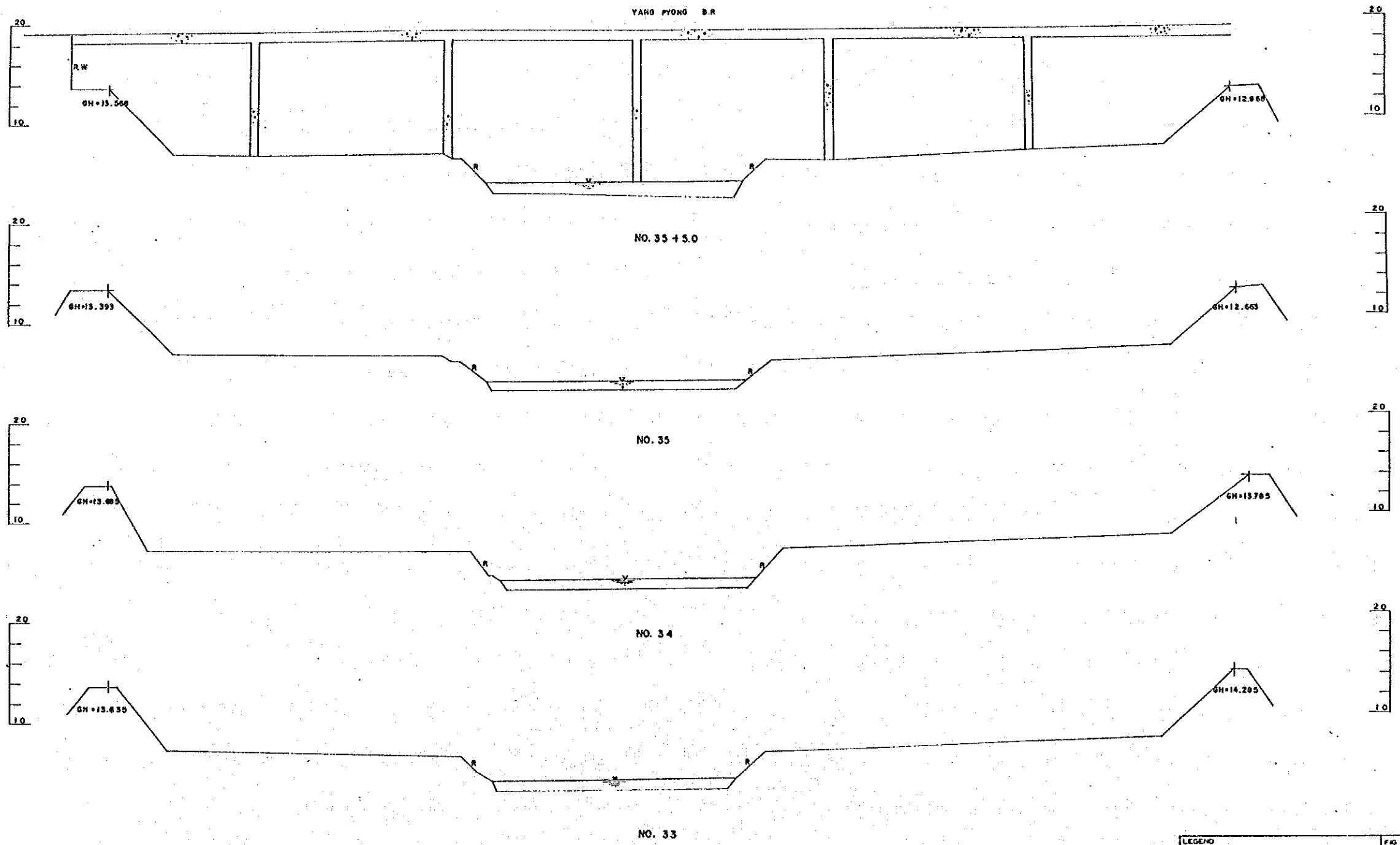

LEGEND	FIG :
	AC 9
SOURCE :	JICA STUDY TEAM
SCALE :	AS SHOWN
DATE OF DRAWING :	1990. 12. 31
The Study on River Environment Improvement for The Tributaries of Han River System in Seoul Municipality and Its Vicinity	

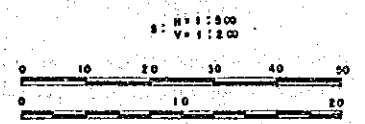
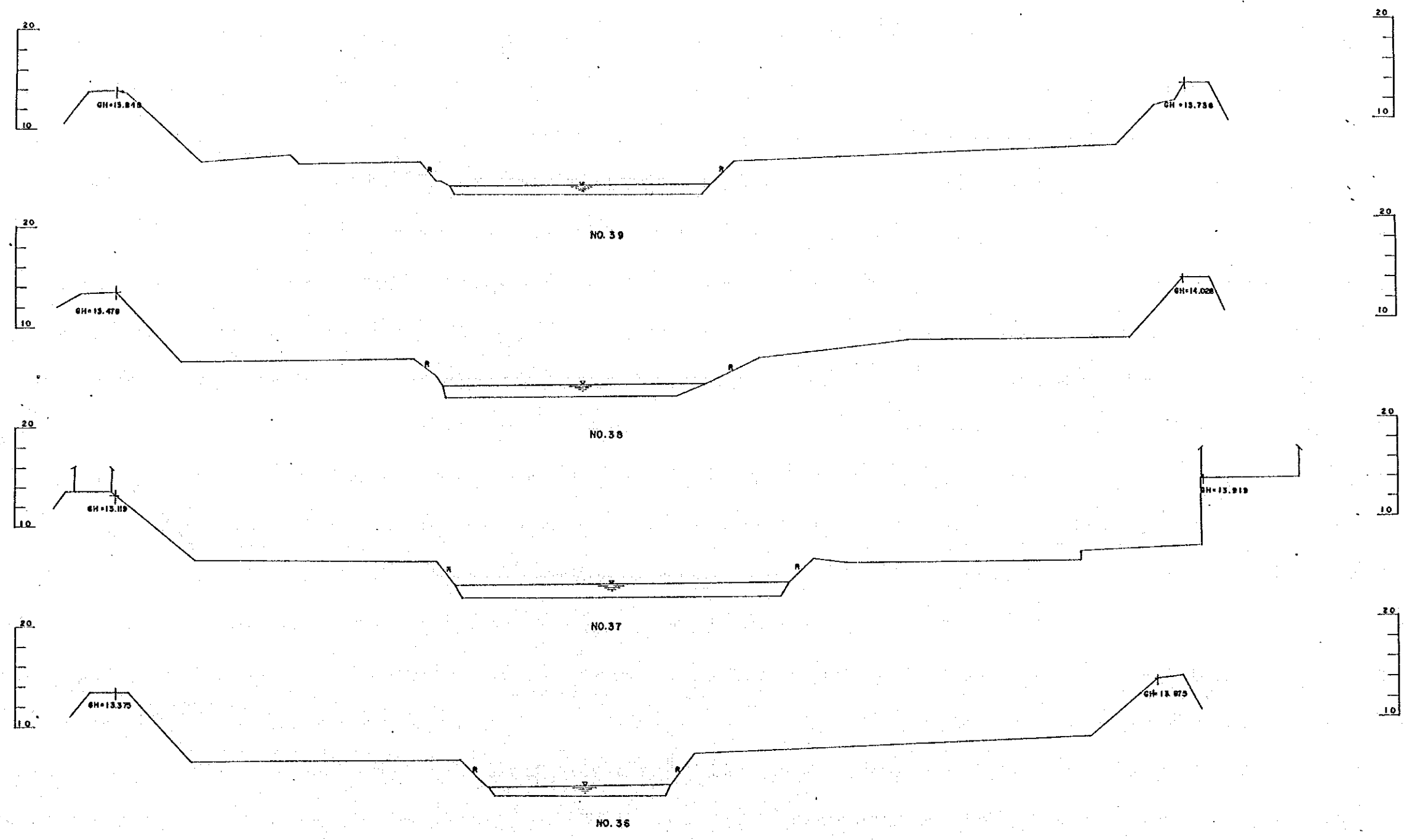

LEGEND	FIG
	AC 10
	SOURCE : JICA STUDY TEAM
	SCALE : AS SHOWN
	DATE OF DRAWING : 1990. 12. 31
The Study on River Environment Improvement for The Tributaries of Han River System in Seoul Municipality and Its Vicinity	

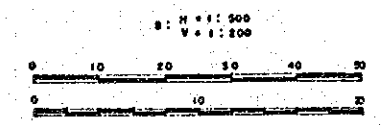
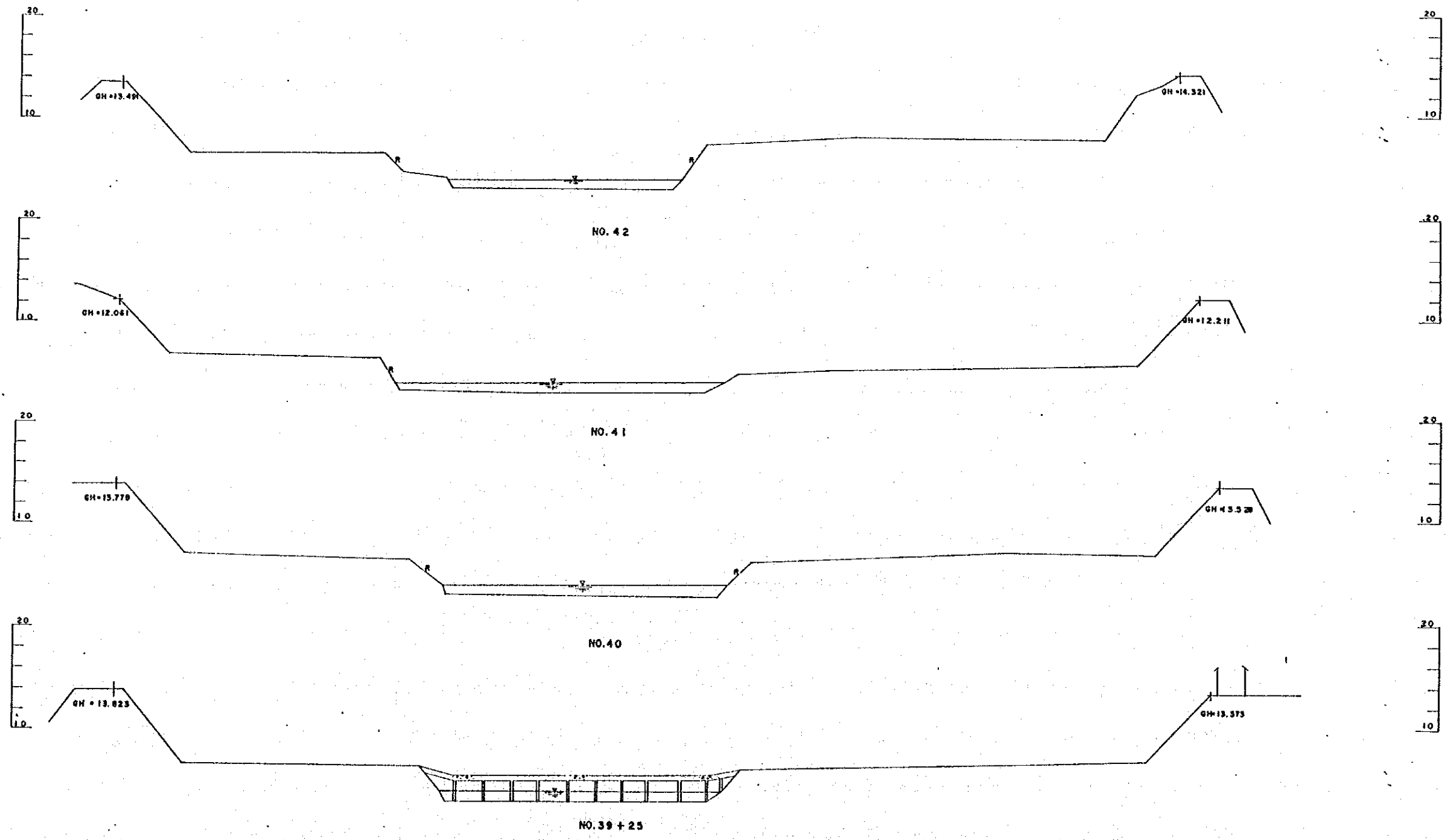

LEGEND	FIG.
	AC II
	SOURCE : JICA STUDY TEAM
	SCALE : AS SHOWN
	DATE OF DRAWING : 1990. 12. 31

The Study on River Environment Improvement for The Tributaries of Han River System in Seoul Municipality and Its Vicinity

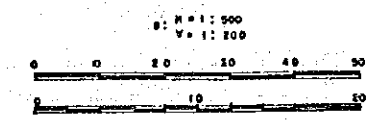
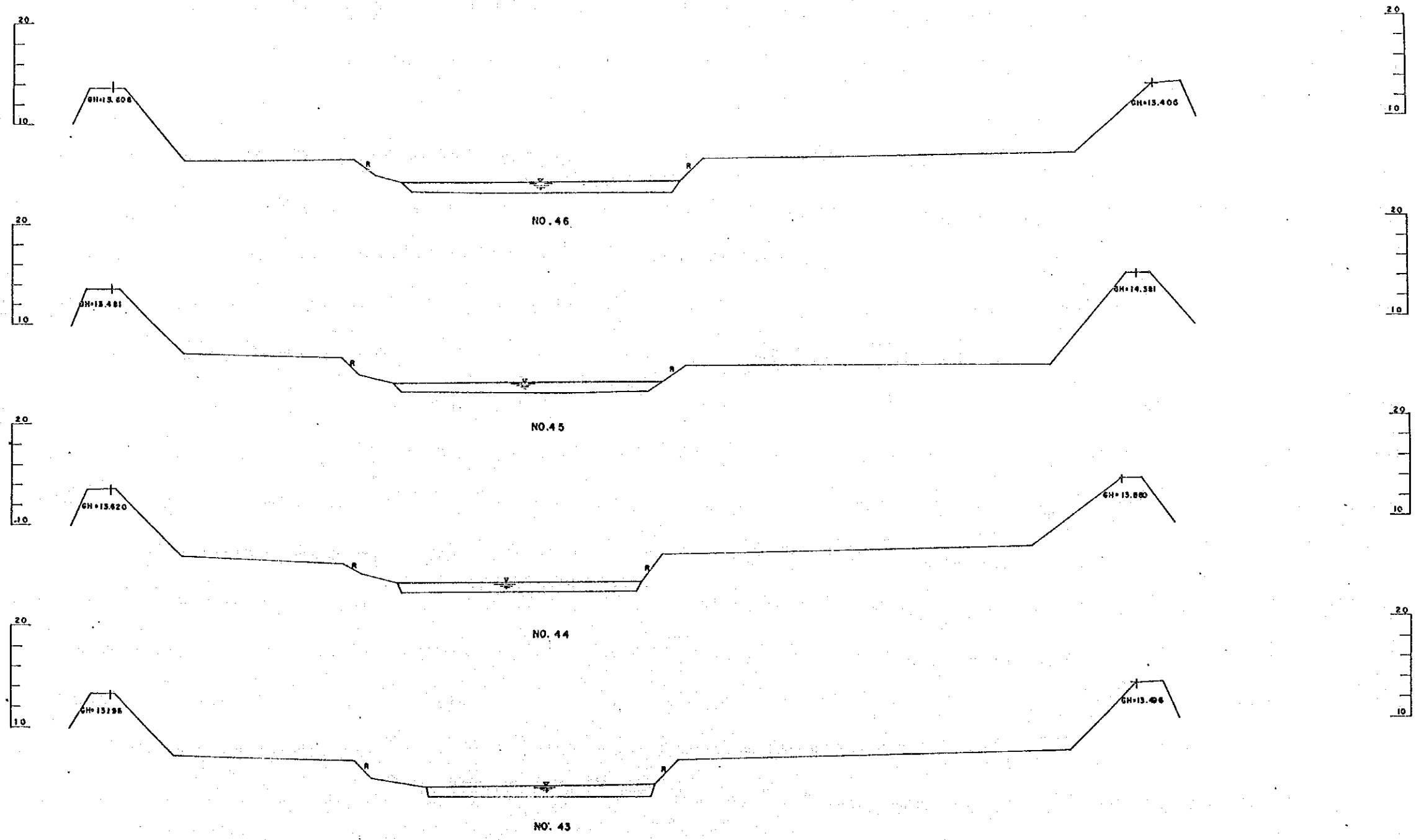

LEGEND	FIG
	AC 12
	SOURCE : JICA STUDY TEAM
	SCALE : AS SHOWN
	DATE OF DRAWING : 1990.12.9
The Study on River Environment Improvement for The Tributaries of Han River System in Seoul Municipality and Its Vicinity	

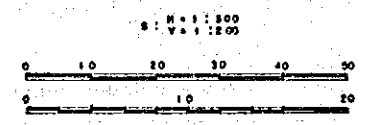
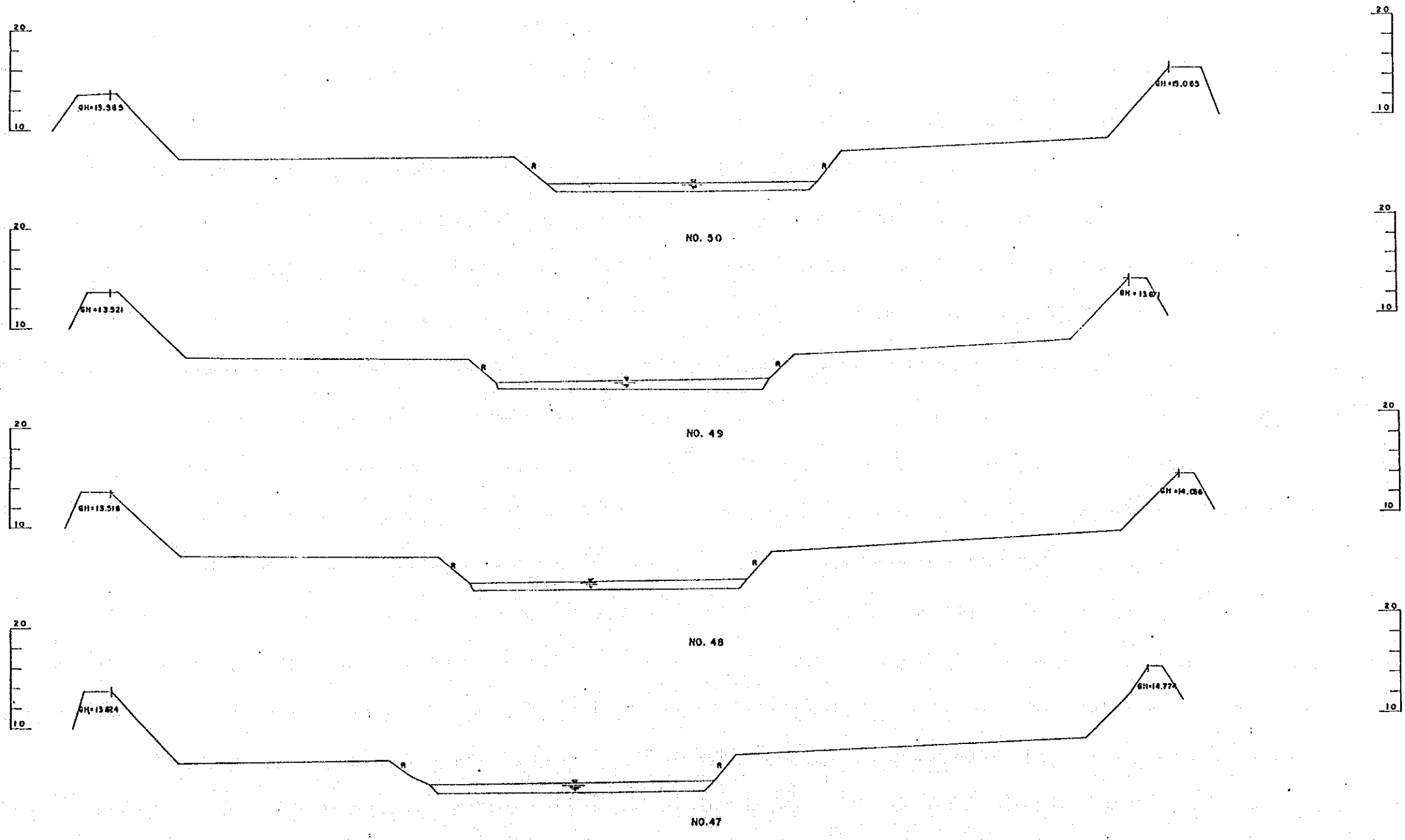

LEGEND	FIG :
	AC 13
	SOURCE : JICA STUDY TEAM
	SCALE : AS SHOWN
	DATE OF DRAWING : 1990. 12. 31
The Study on River Environment Improvement for The Tributaries of Han River System in Seoul Municipality and Its Vicinity	

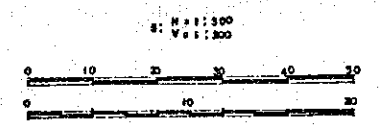
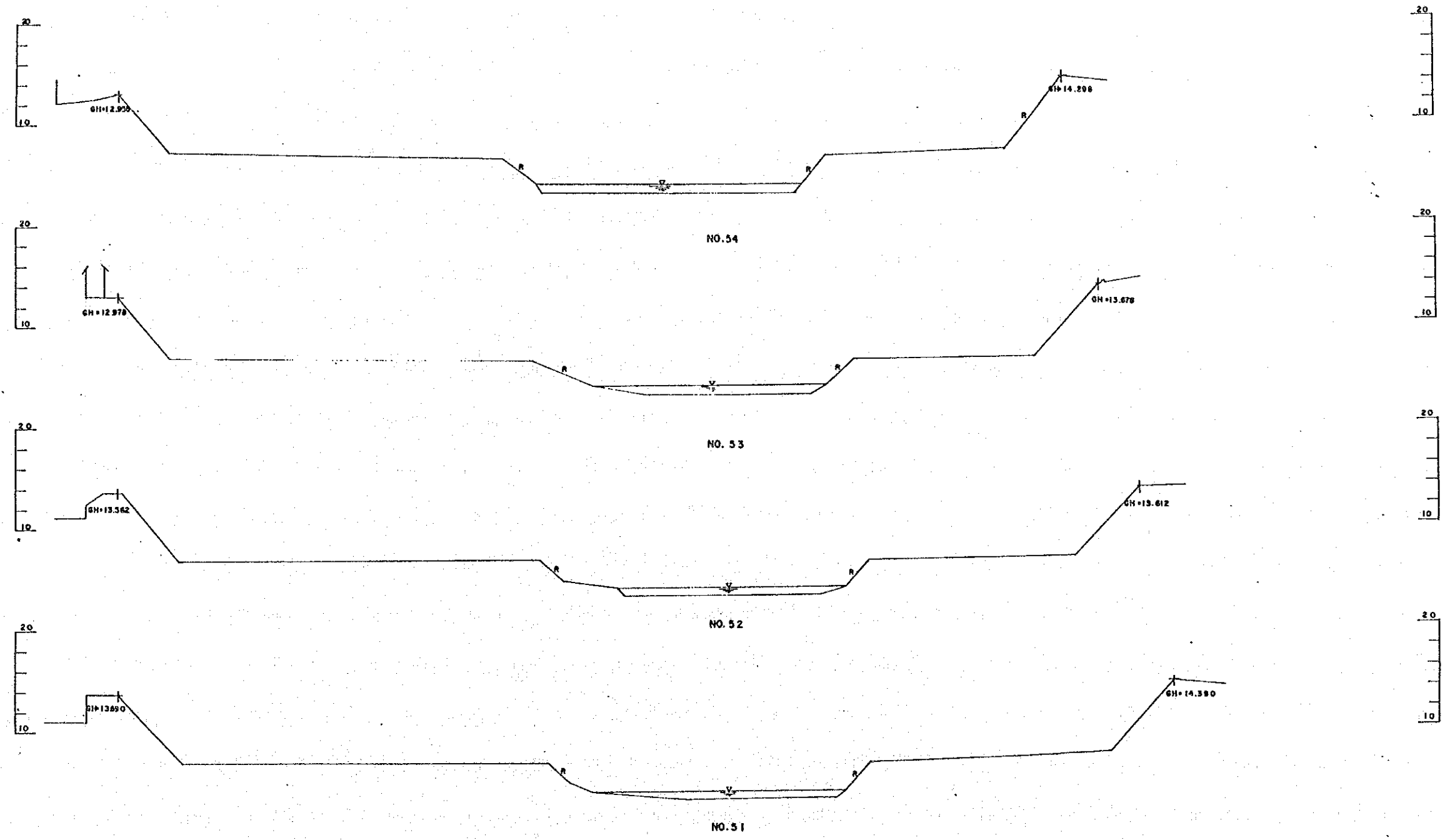

LEGEND	FIG :
	AC 14
	SOURCE : JICA STUDY TEAM
	SCALE : AS SHOWN
	DATE OF DRAWING : 1990.12.31
The Study on River Environment Improvement for The Tributaries of Han River System in Seoul Municipality and Its Vicinity	

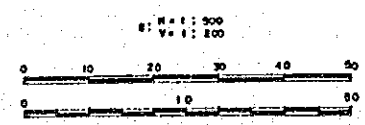
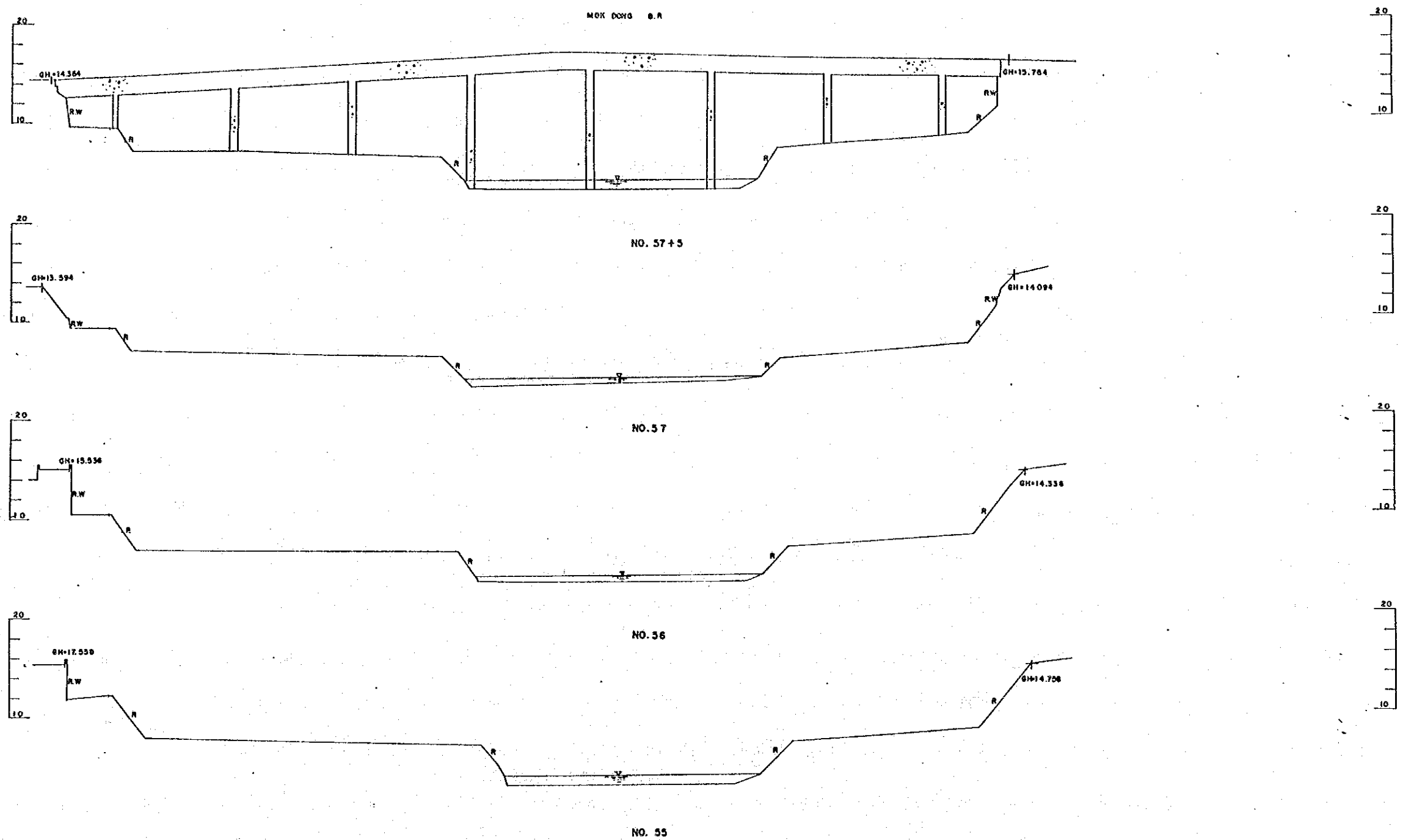

LEGEND	FIG :
	AC 15
	SOURCE : JICA STUDY TEAM
	SCALE : AS SHOWN
	DATE OF DRAWING : 1990. 12. 31
The Study on River Environment Improvement for The Tributaries of Han River System in Seoul Municipality and Its Vicinity	

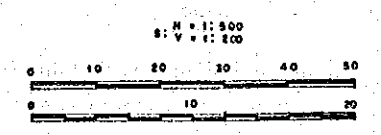
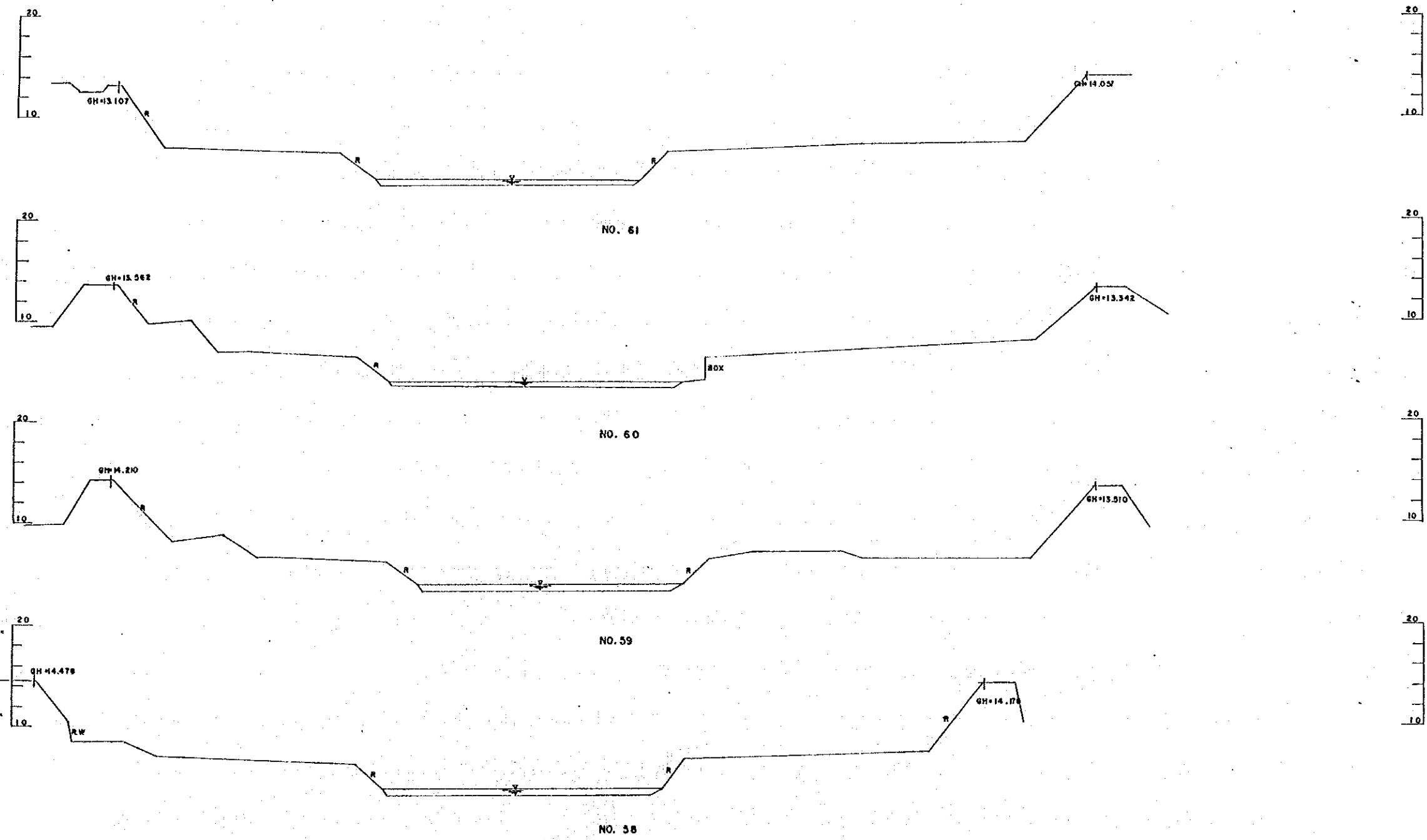

LEGEND	FIG
	AC 16
	SOURCE : JICA STUDY TEAM
	SCALE : AS SHOWN
	DATE OF DRAWING : 1990.12.31
The Study on River Environment Improvement for The Tributaries of Han River System in Seoul Municipality and Its Vicinity	

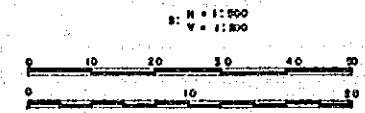
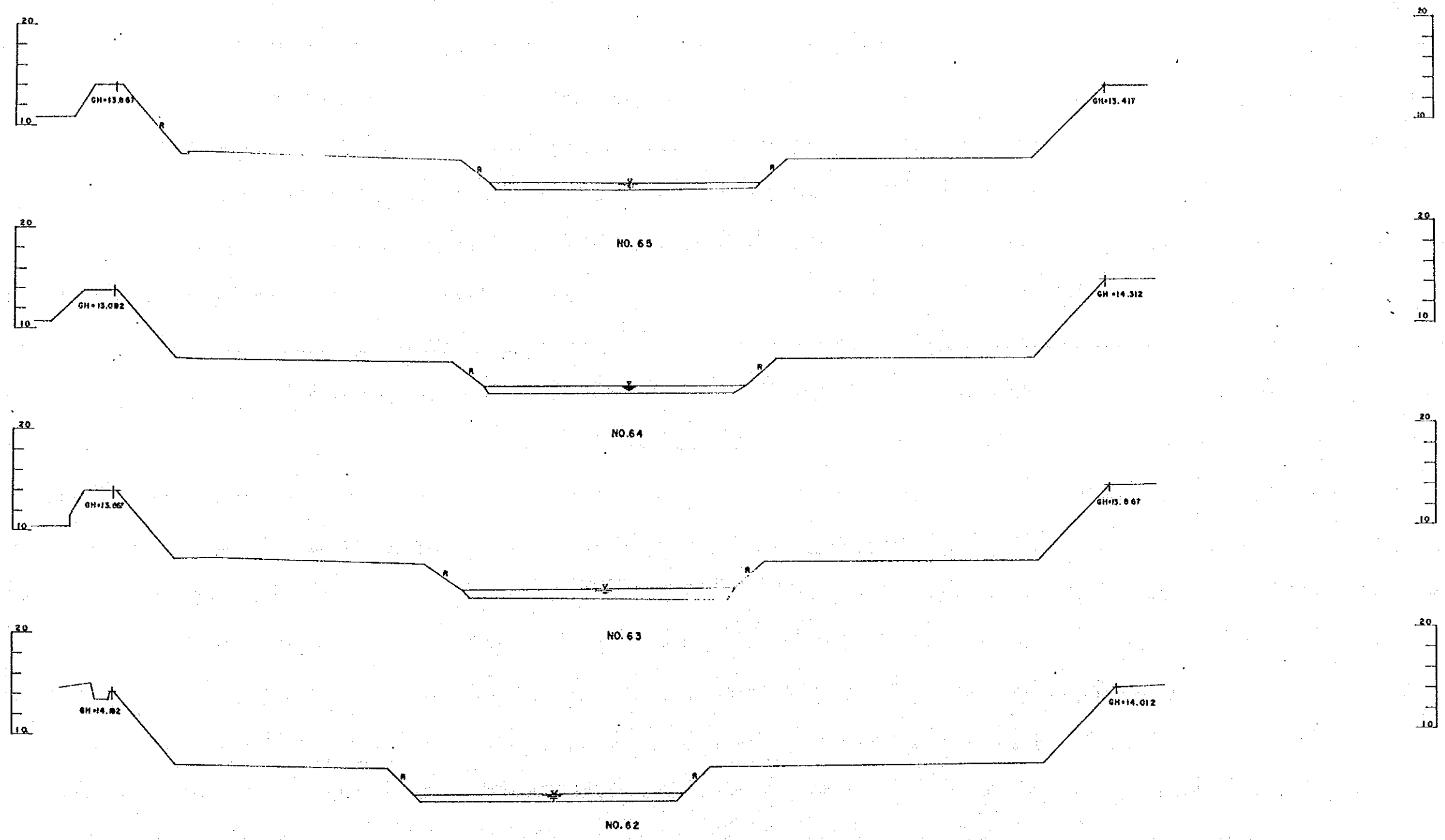

LEGEND	FIG :
	AC 17
	SOURCE : JICA STUDY TEAM
	SCALE : AS SHOWN
	DATE OF DRAWING : 1990.12.31
The Study on River Environment Improvement for The Tributaries of Han River System in Seoul Municipality and Its Vicinity	

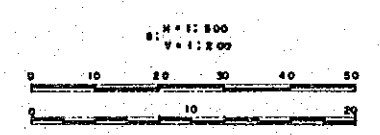
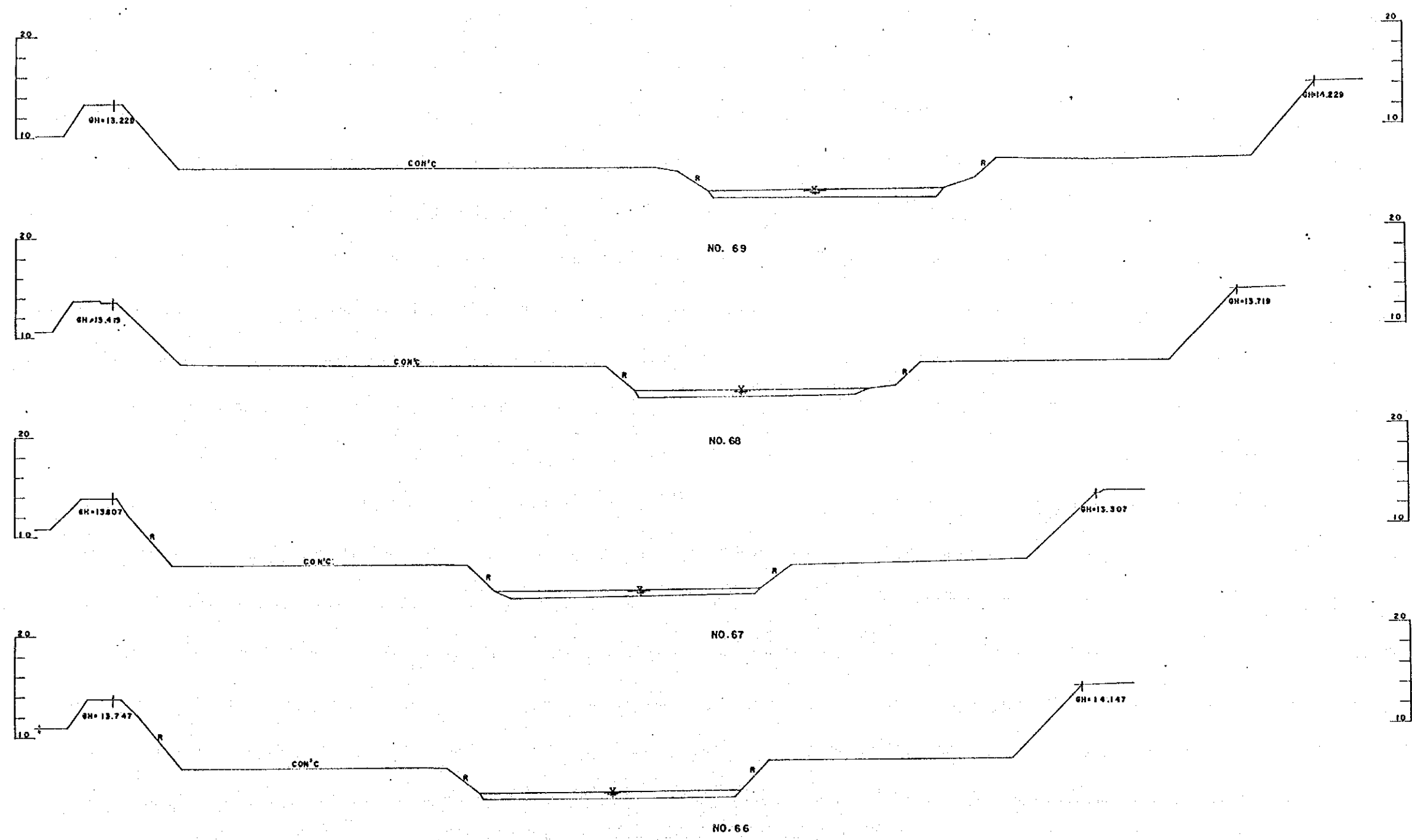

LEGEND	FIG :
	AC IS
	SOURCE : JICA STUDY TEAM
	SCALE : AS SHOWN
	DATE OF DRAWING : 1990.12.31
The Study on River Environment Improvement for The Tributaries of Han River System in Seoul Municipality and Its Vicinity	

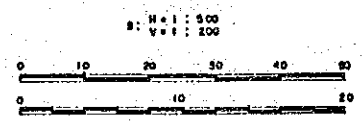
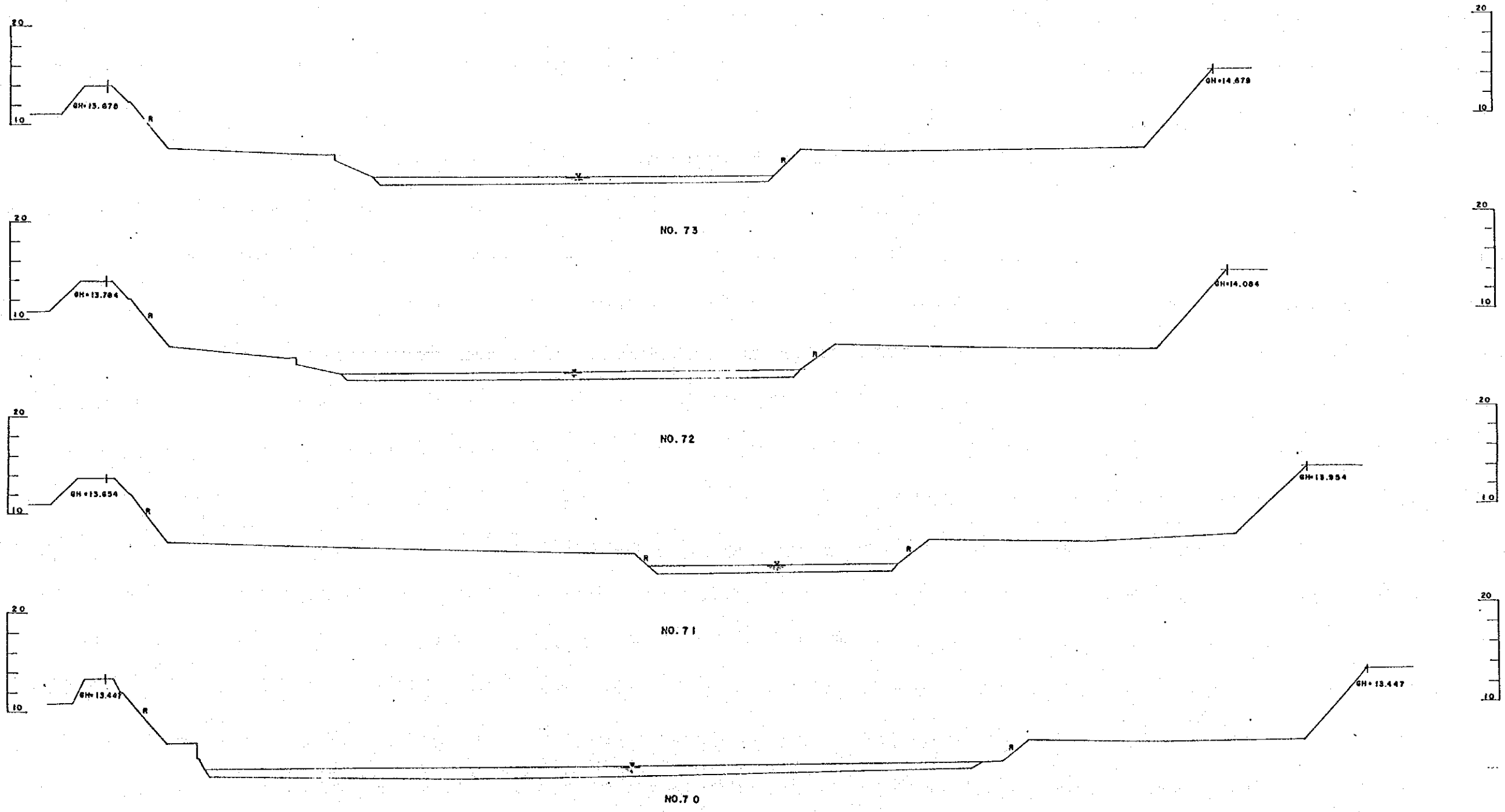

LEGEND	FIG
	AC 19
	SOURCE : JICA STUDY TEAM
	SCALE : A 6 SHOWN
	DATE OF DRAWING : 1990. 12. 21
The Study on River Environment Improvement for The Tributaries of Han River System in Seoul Municipality and Its Vicinity	

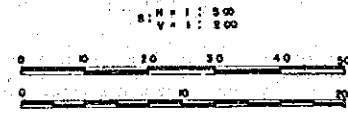
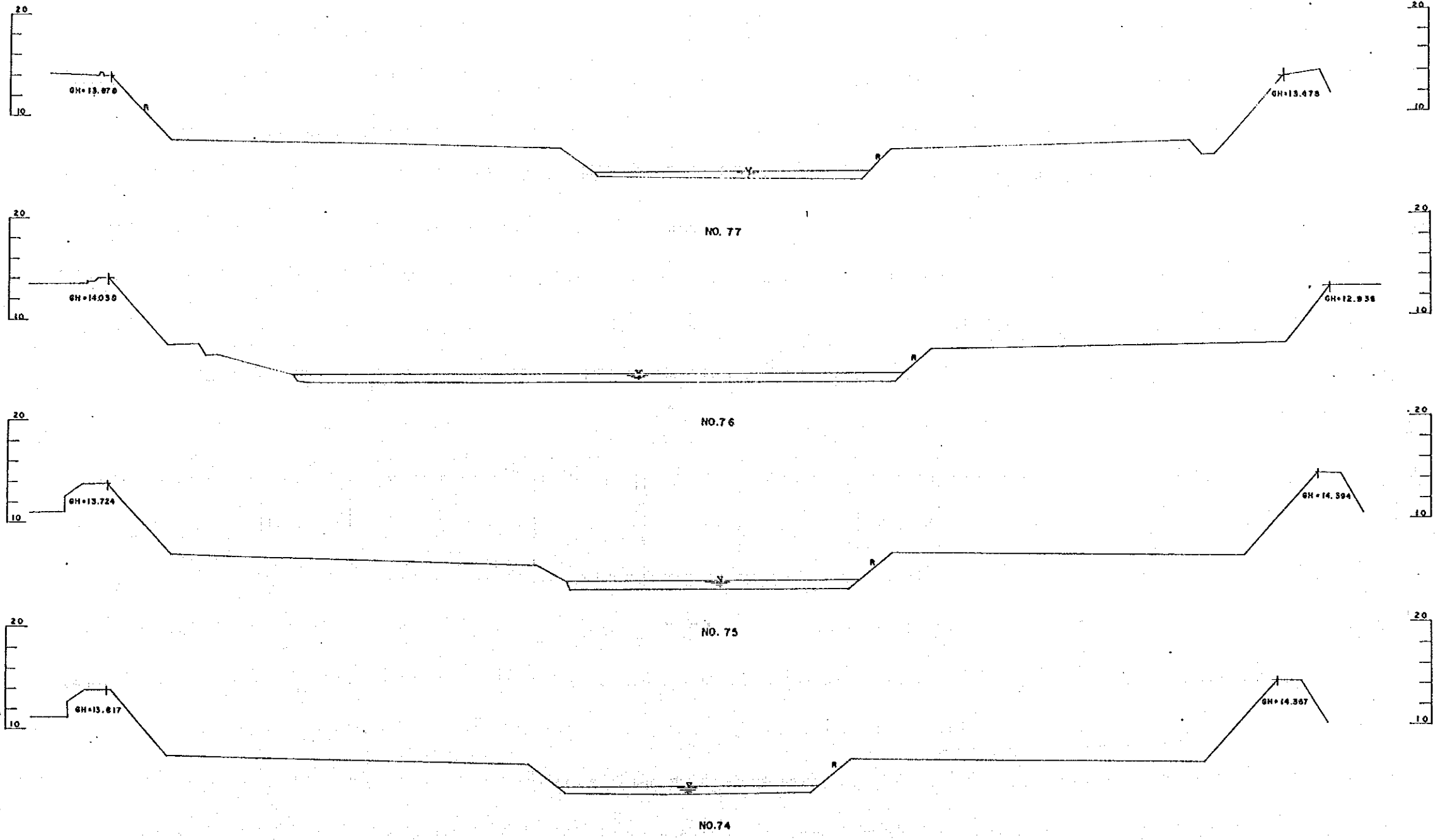

LEGEND	FIG :
	AC 20
	SOURCE : JICA STUDY TEAM
	SCALE : AS SHOWN
	DATE OF DRAWING : 1990. 12. 31
The Study on River Environment Improvement for The Tributaries of Han River System in Seoul Municipality and Its Vicinity	

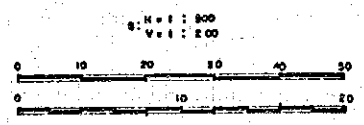
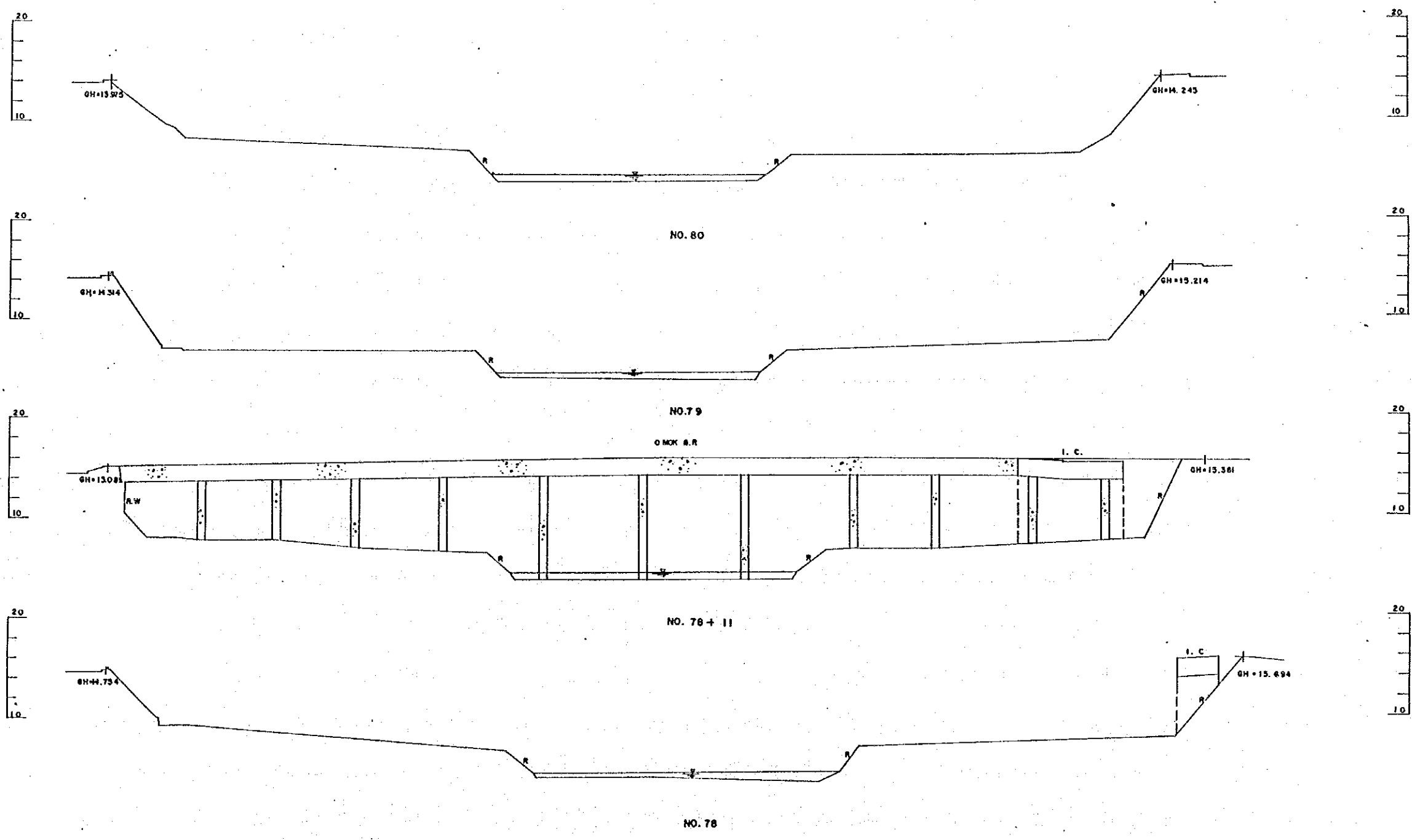

LEGEND	FIG :
	AC 21
SOURCE :	JICA STUDY TEAM
SCALE :	AS SHOWN
DATE OF DRAWING :	1990. 12. 31
The Study on River Environment Improvement for The Tributaries of Han River System in Seoul Municipality and Its Vicinity	

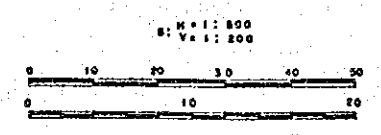
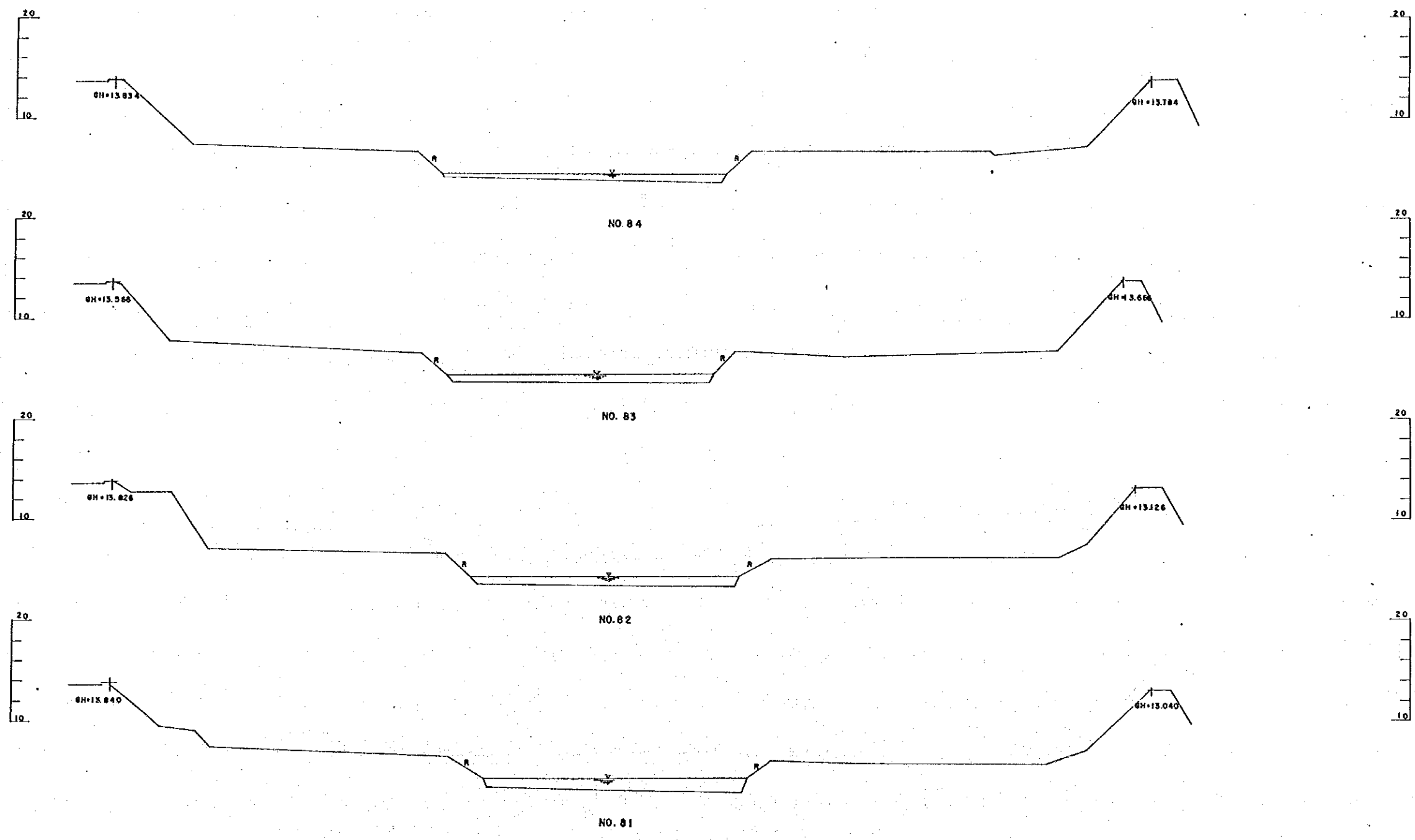

LEGEND	FIG :
	AC 22
	SOURCE : JICA STUDY TEAM
	SCALE : AS SHOWN
	DATE OF DRAWING : 1990. 12. 31
The Study on River Environment Improvement for The Tributaries of Han River System in Seoul Municipality and Its Vicinity	

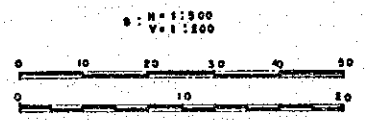
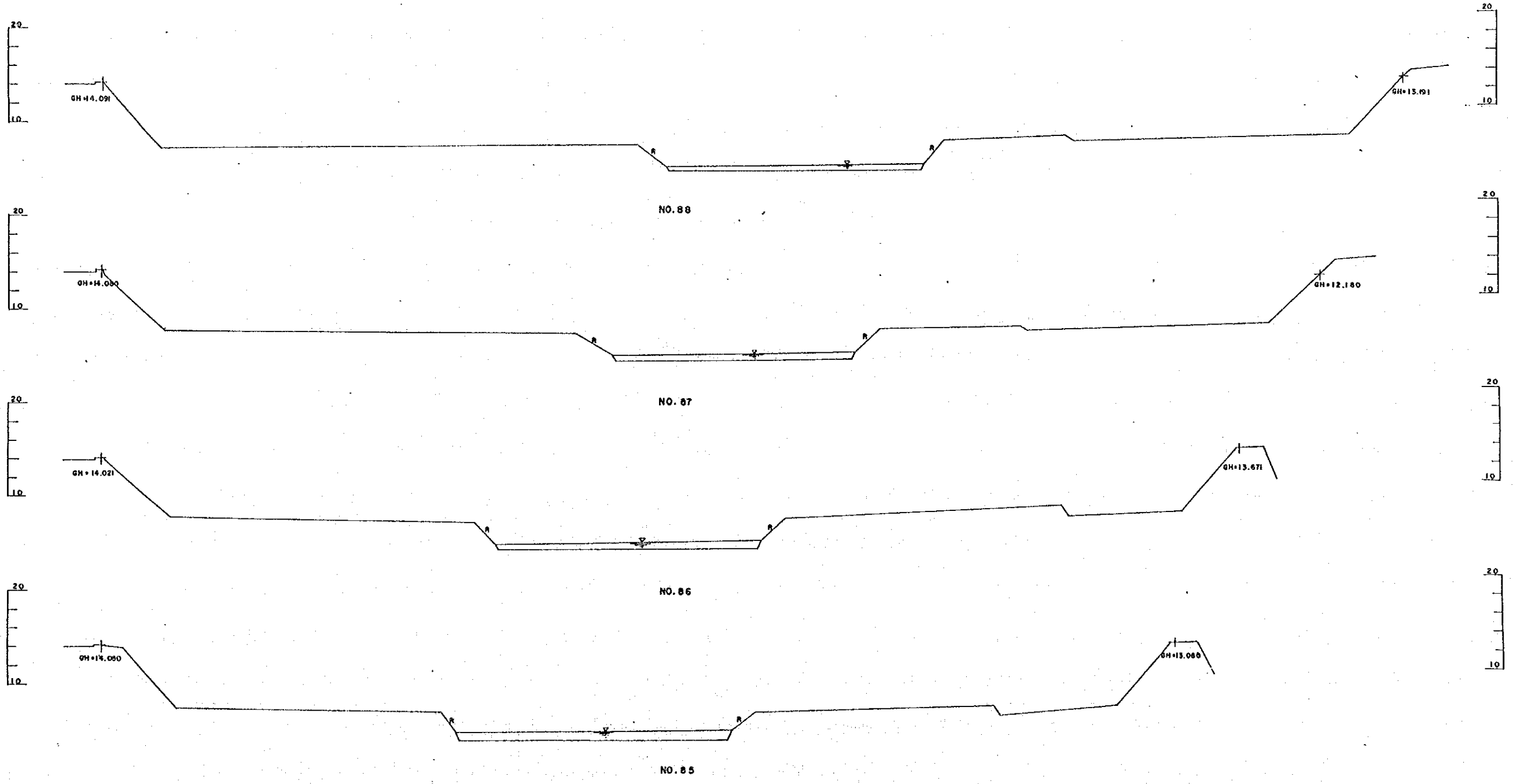

LEGEND	FIG
	AC 23
	SOURCE : JICA STUDY TEAM
	SCALE : AS SHOWN
	DATE OF DRAWING : 1990. 12. 31
The Study on River Environment Improvement for The Tributaries of Han River System in Seoul Municipality and Its Vicinity	

84
 24

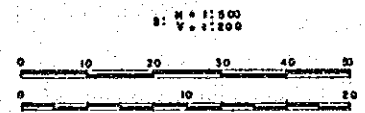
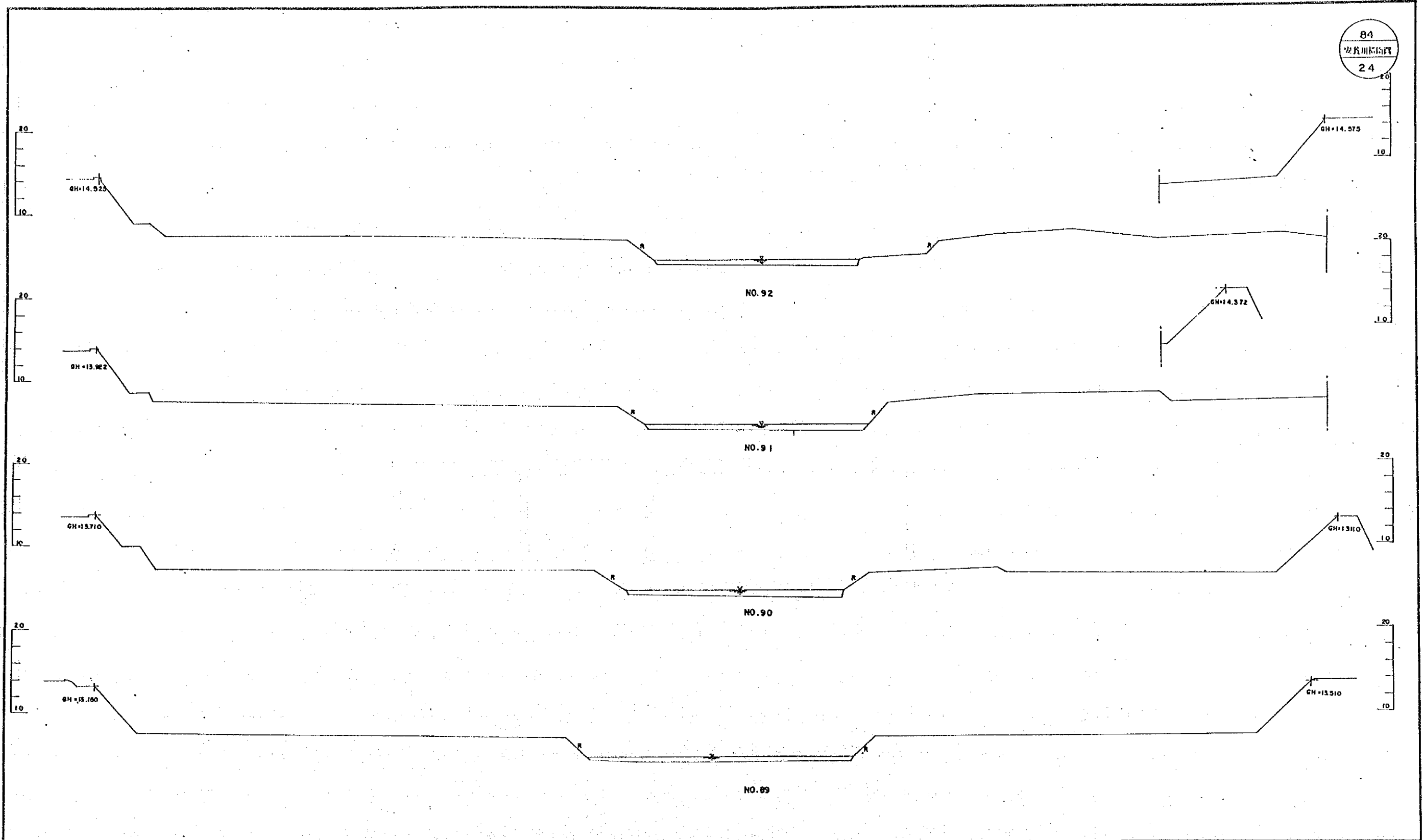

LEGEND	FIG :
	AC 24
	SOURCE : JICA STUDY TEAM
	SCALE : AS SHOWN
	DATE OF DRAWING : 1990.12.31
The Study on River Environment Improvement for The Tributaries of Han River System in Seoul Municipality and Its Vicinity	

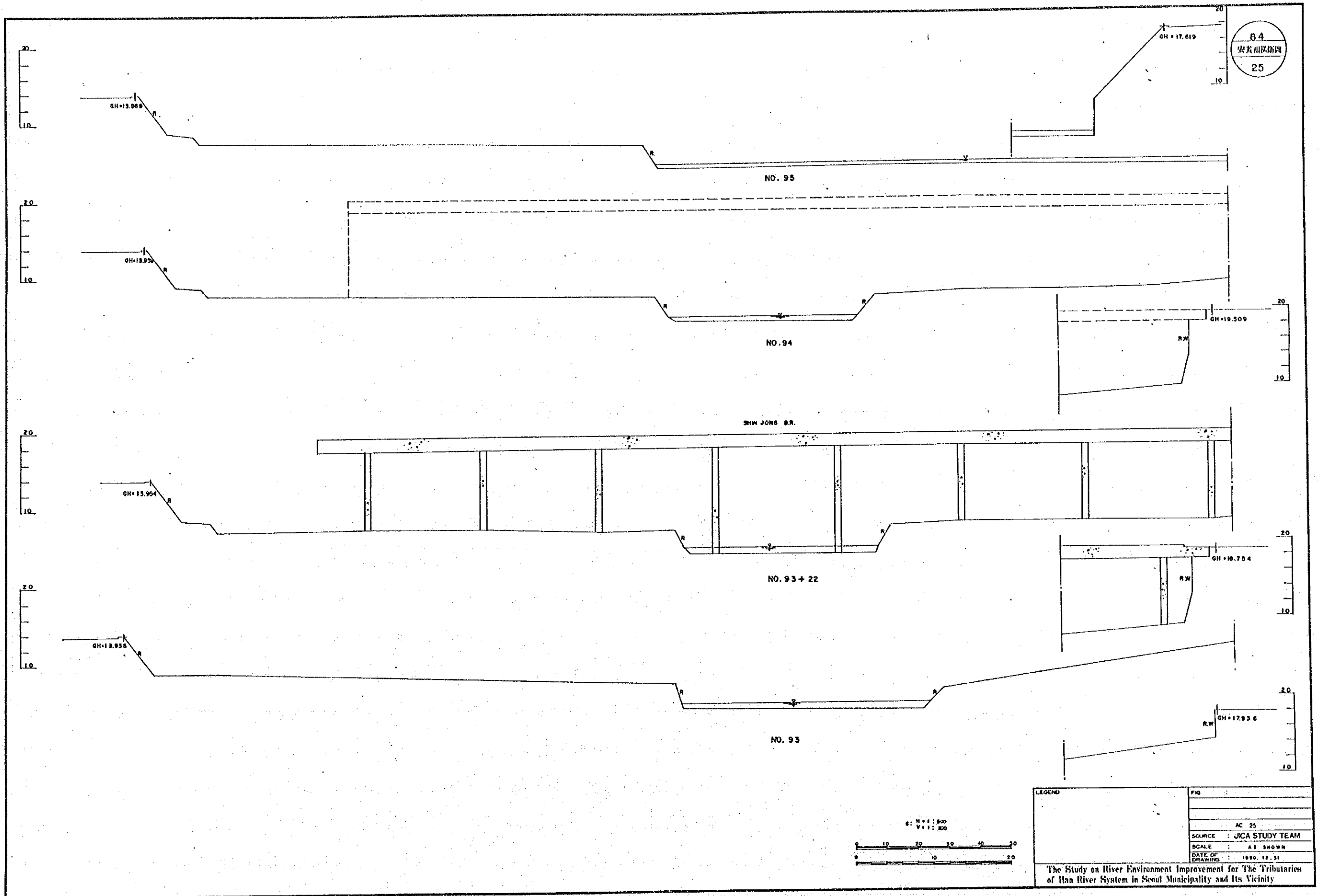

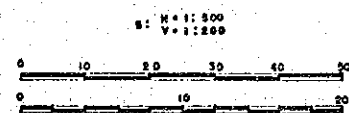
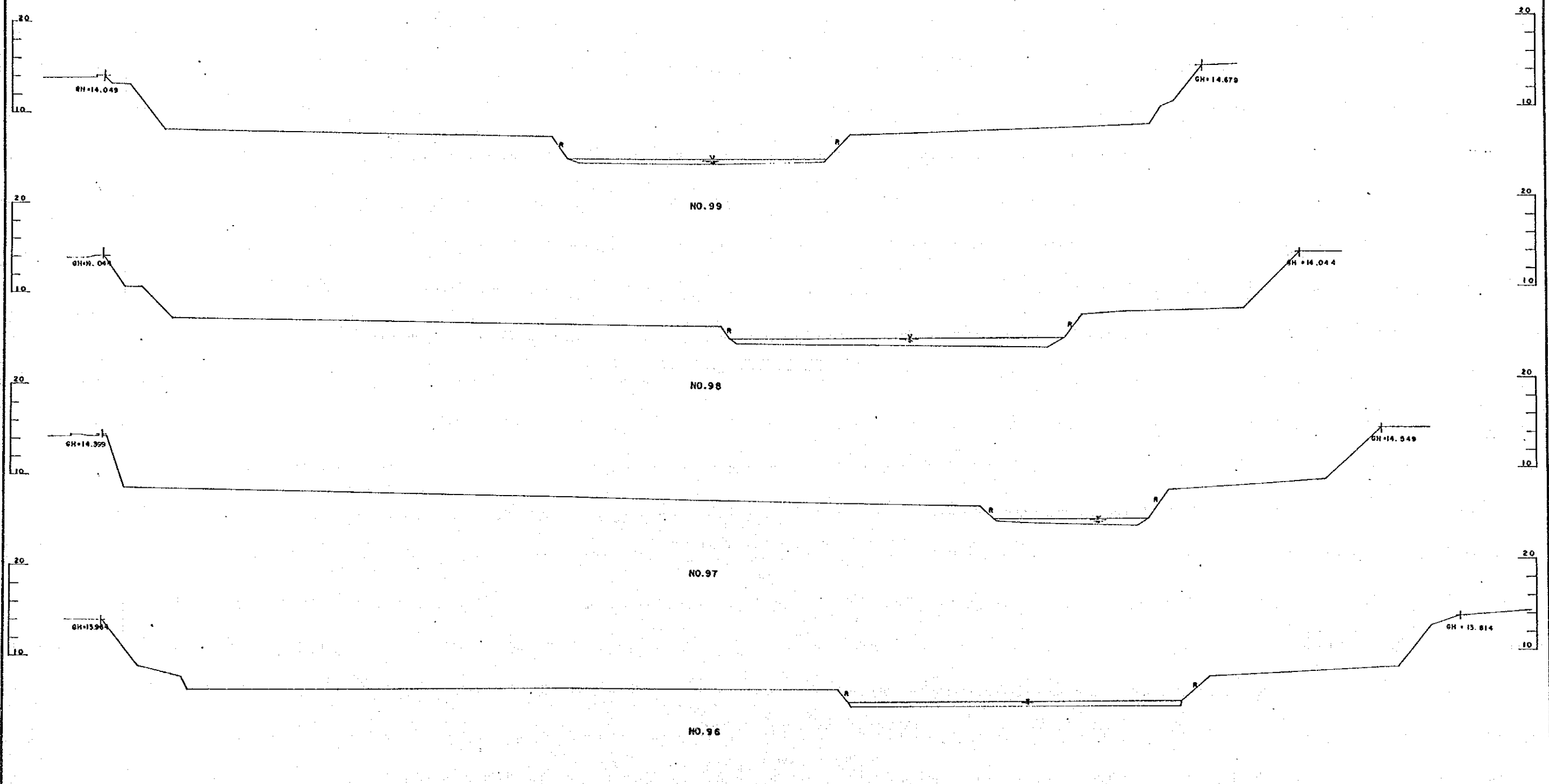

LEGEND	FIG :
	AC 26
	SOURCE : JICA STUDY TEAM
	SCALE : A 3 3/4 X W 4
	DATE OF DRAWING : 1990.12.21
The Study on River Environment Improvement for The Tributaries of Han River System in Seoul Municipality and Its Vicinity	

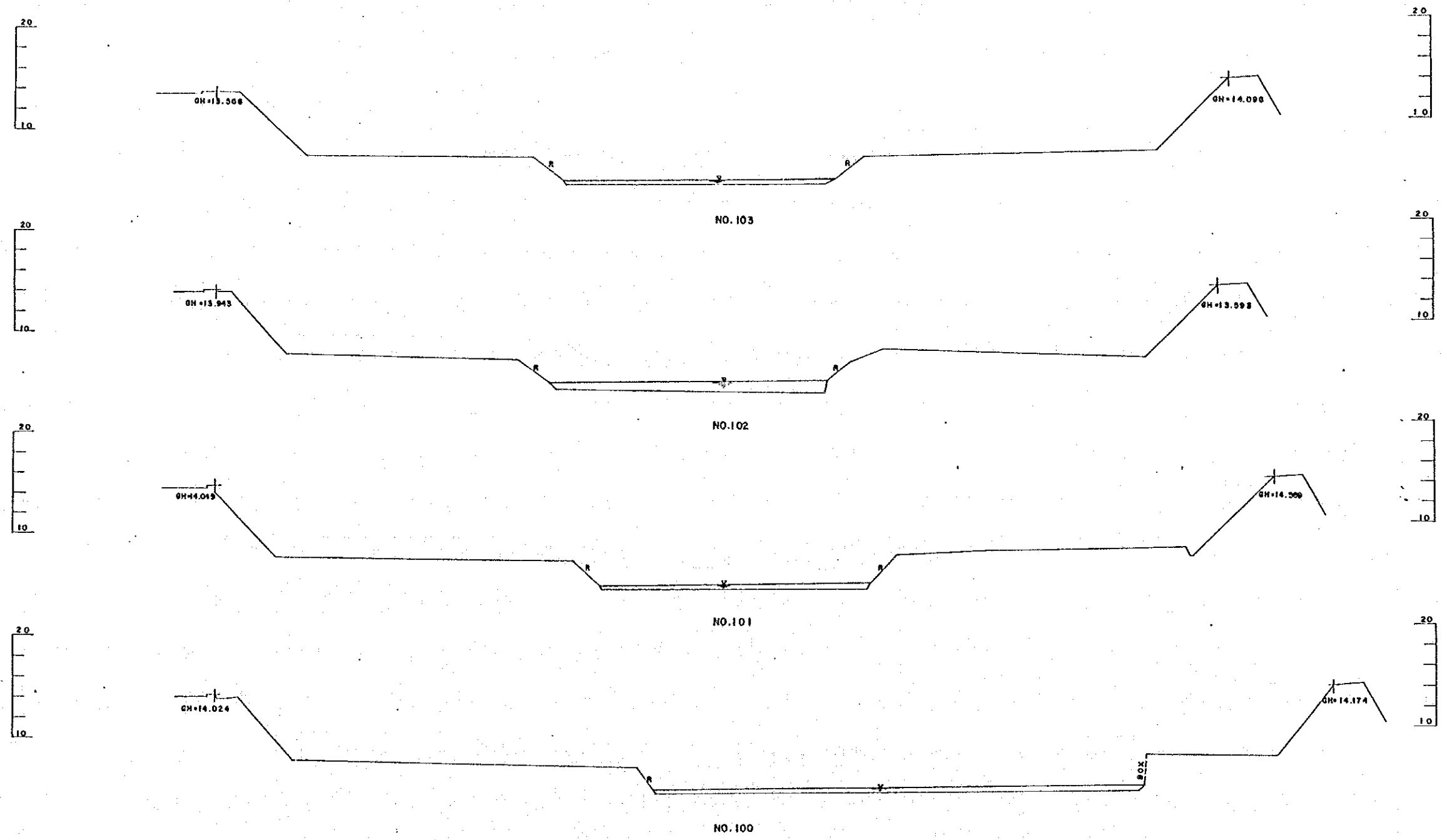

LEGEND	FIG
	AC 27
SOURCE	JICA STUDY TEAM
SCALE	A3 SHOW
DATE OF DRAWING	1990.12.31
The Study on River Environment Improvement for The Tributaries of Han River System in Seoul Municipality and Its Vicinity	

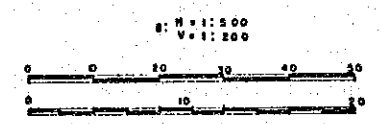
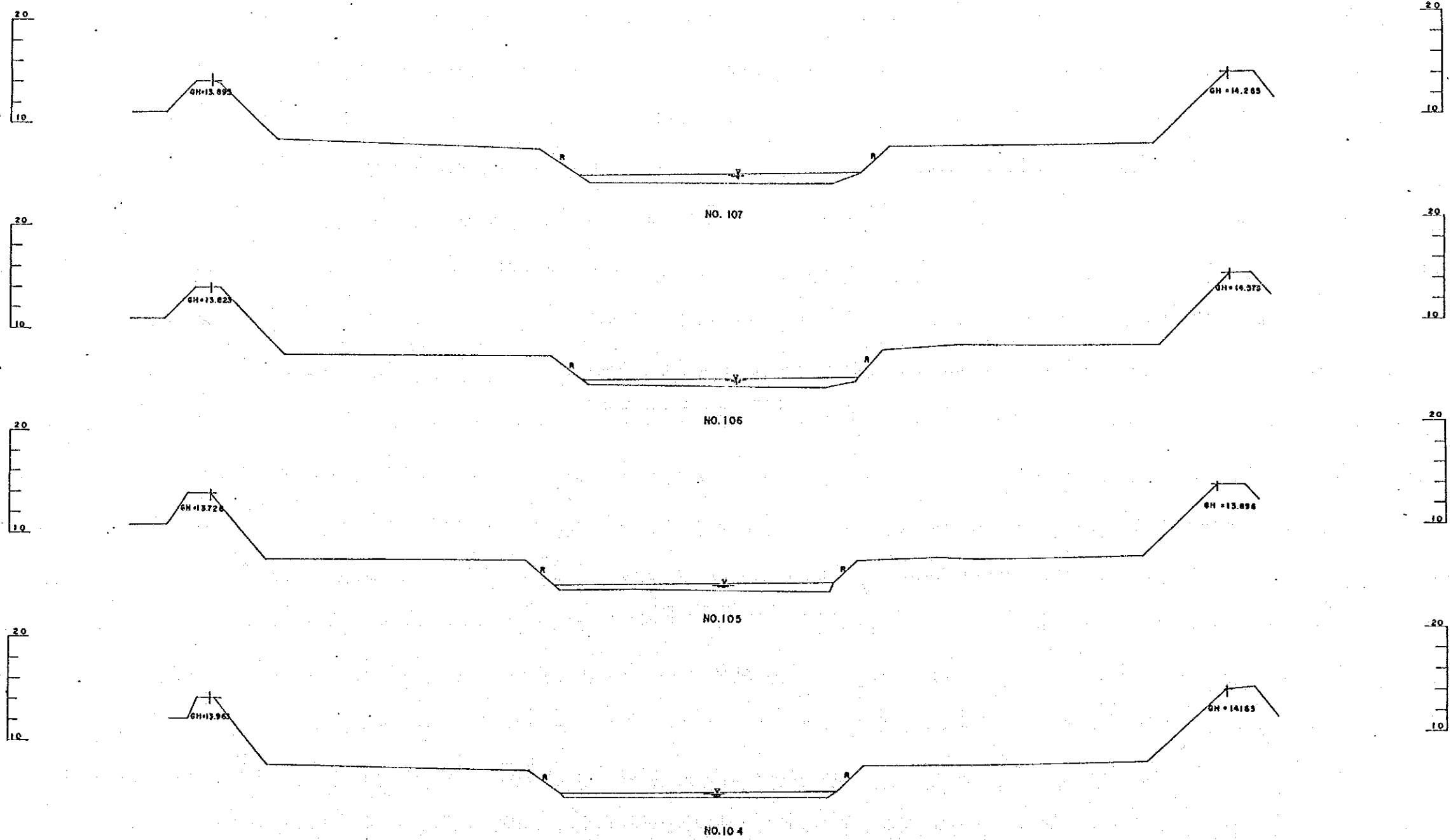

LEGEND	PKI
	AC 28
SOURCE	JICA STUDY TEAM
SCALE	AS SHOWN
DATE OF DRAWING	1990. 12. 31

The Study on River Environment Improvement for The Tributaries of Han River System in Seoul Municipality and Its Vicinity

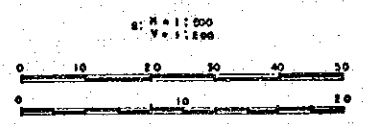
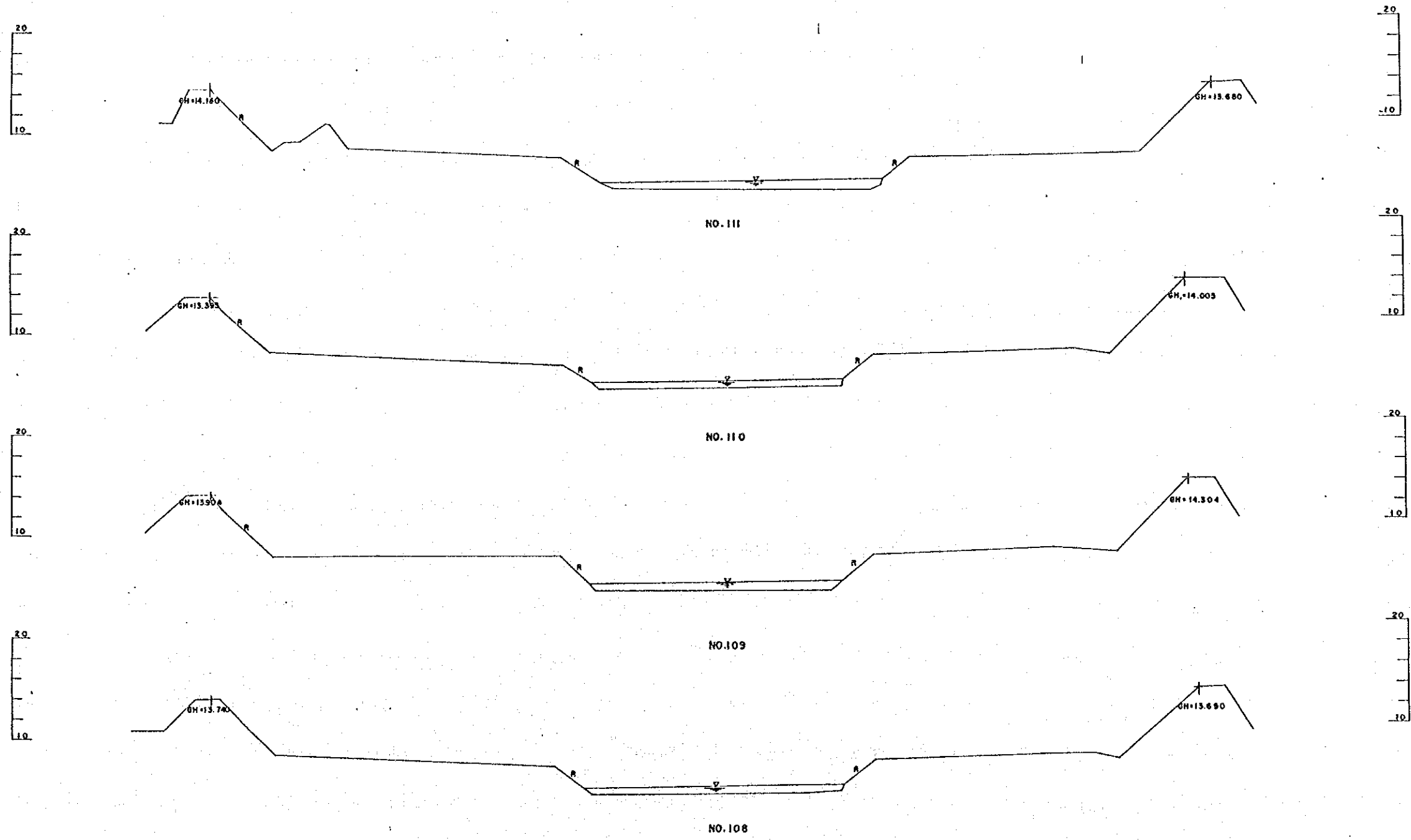

LEGEND	FIG. :
	AC 29
	SOURCE : JICA STUDY TEAM
	SCALE : AS SHOWN
	DATE OF DRAWING : 1990. 12. 31
The Study on River Environment Improvement for The Tributaries of Han River System in Seoul Municipality and Its Vicinity	

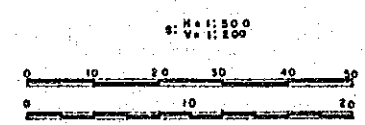
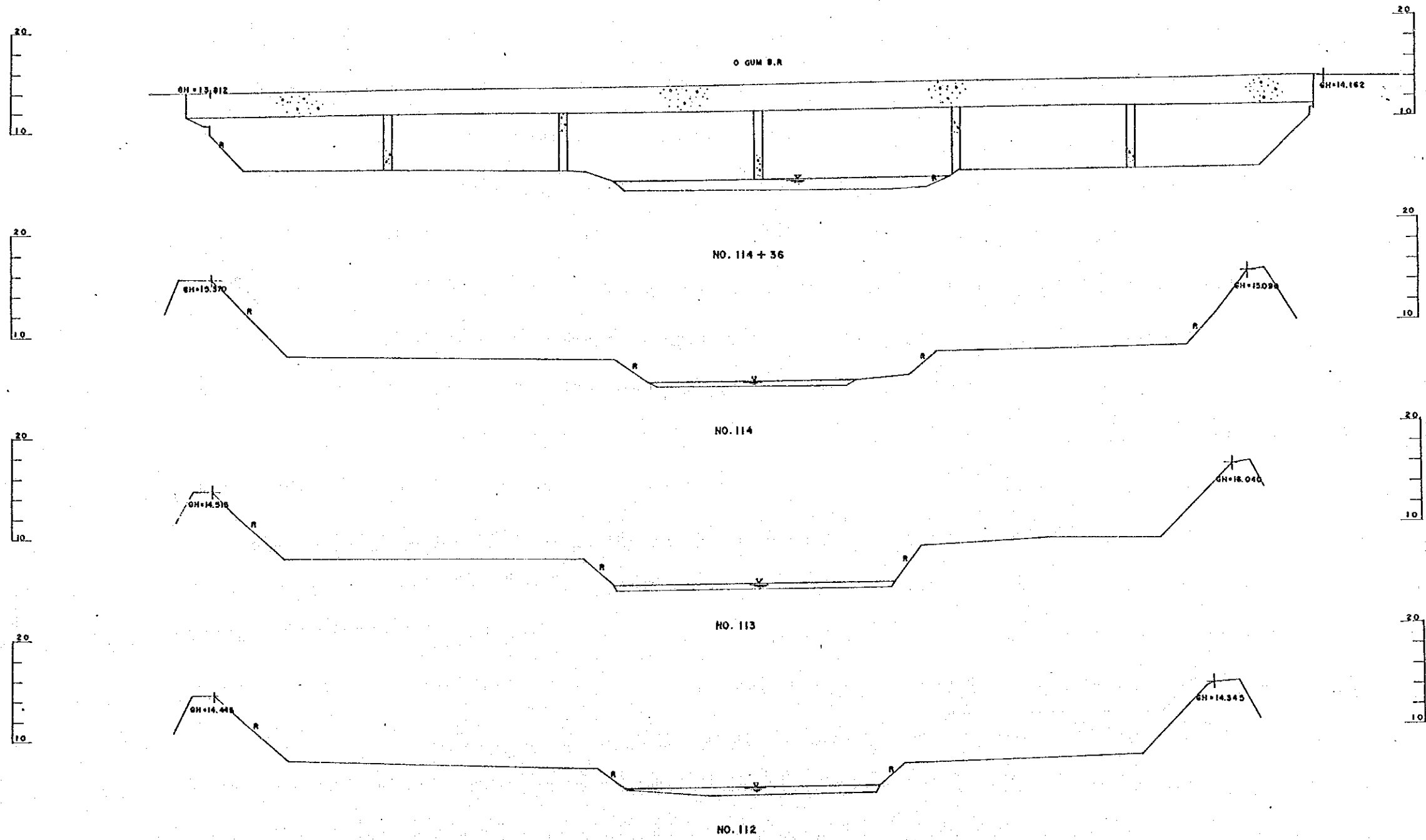

LEGEND	FIG
	AC 30
	SOURCE : JICA STUDY TEAM
	SCALE : AS SHOWN
	DATE OF DRAWING : 1990.12.31
The Study on River Environment Improvement for the Tributaries of Han River System in Seoul Municipality and Its Vicinity	

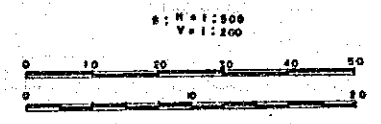
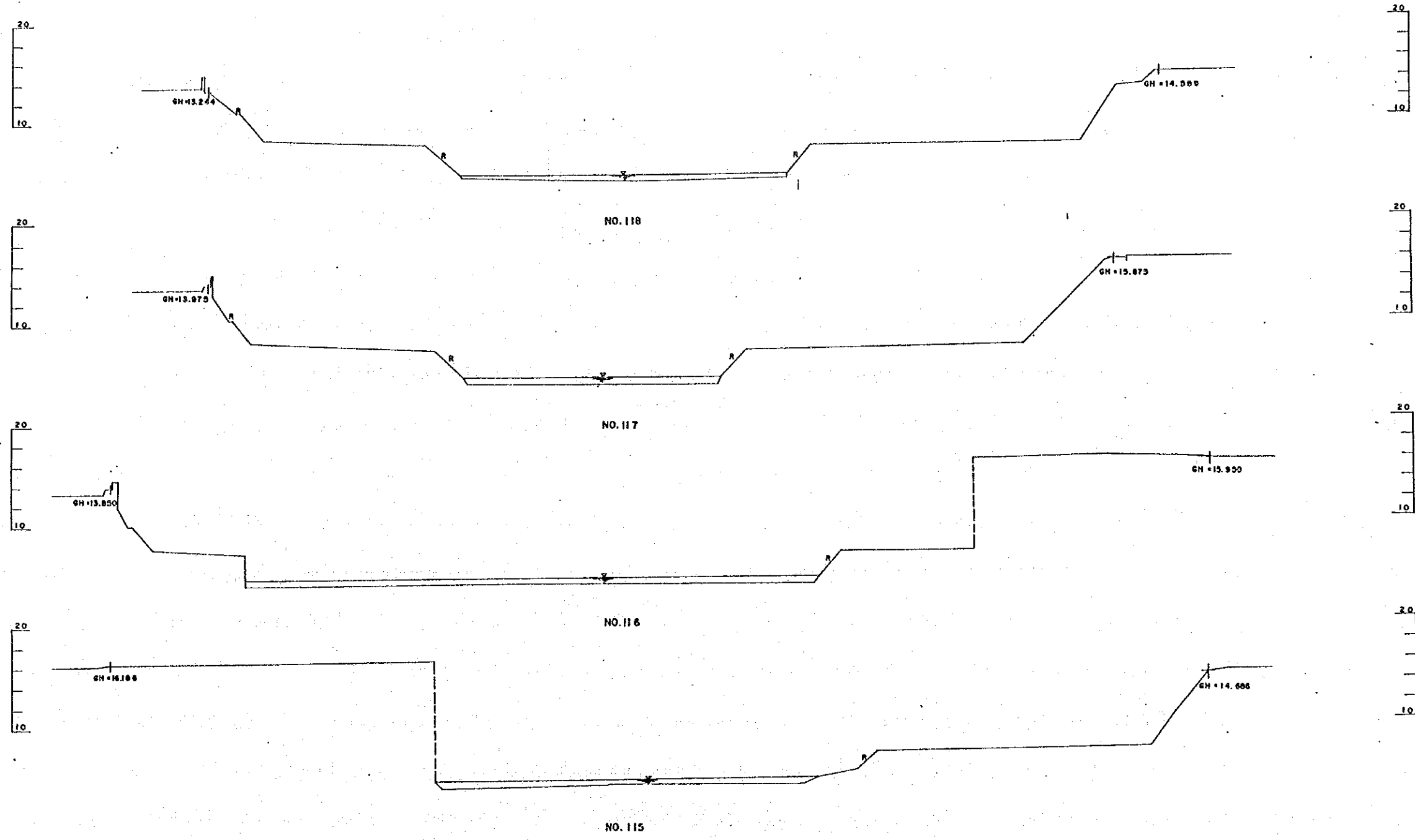

LEGEND	FIG :
	AC 31
SOURCE :	JICA STUDY TEAM
SCALE :	A 3 SHOWN
DATE OF DRAWING :	1990. 12. 31

The Study on River Environment Improvement for The Tributaries of Han River System in Seoul Municipality and Its Vicinity

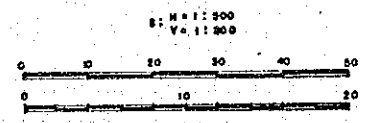
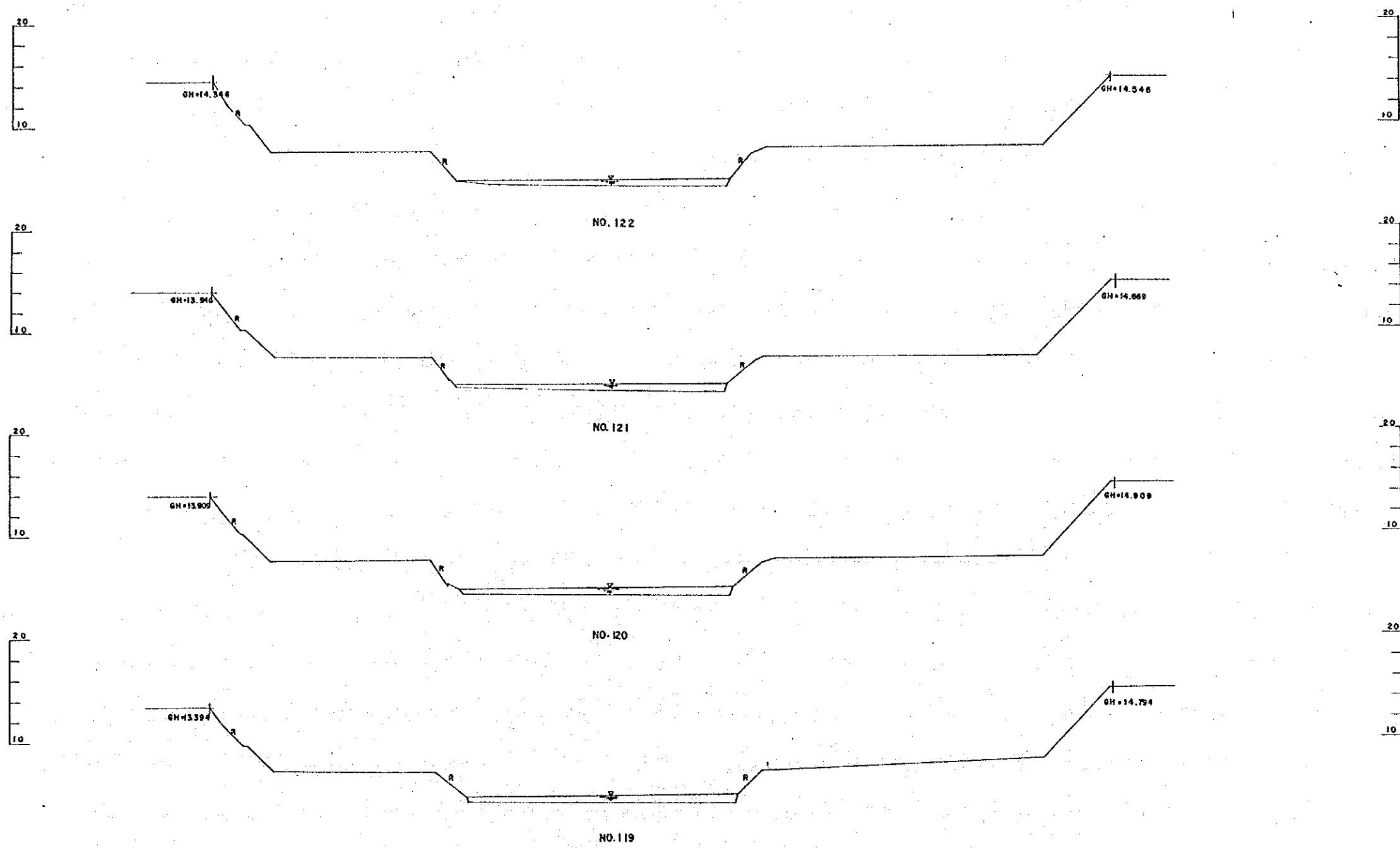

LEGEND	FIG
	AC 32
	SOURCE : JICA STUDY TEAM
	SCALE : A 8 SHOWN
	DATE OF DRAWING : 1990. 12. 31
The Study on River Environment Improvement for The Tributaries of Han River System in Seoul Municipality and Its Vicinity	

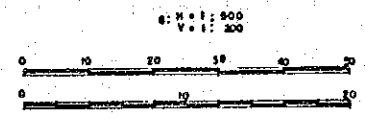
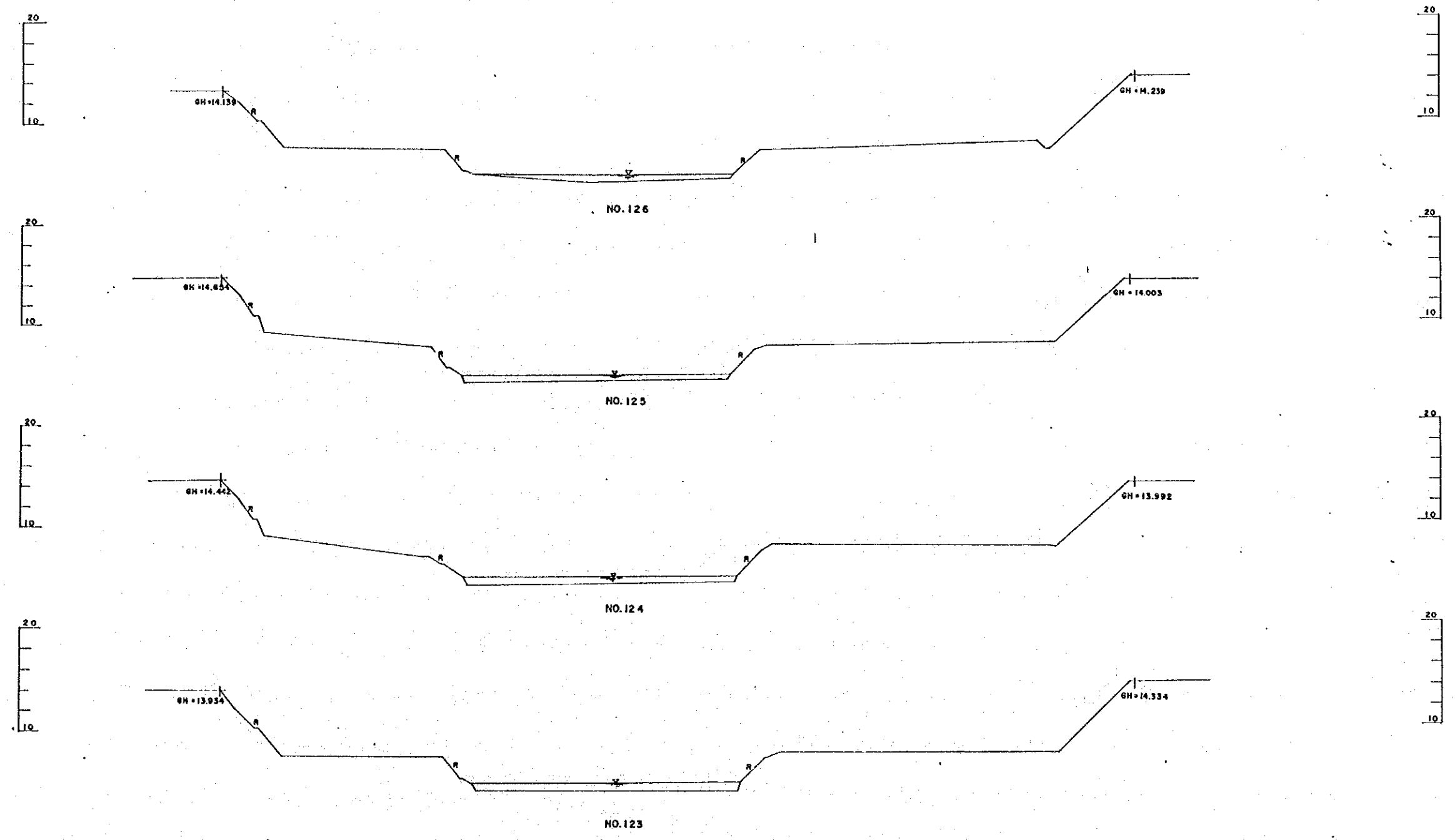

LEGEND	FIG
	AC 33
	SOURCE : JICA STUDY TEAM
	SCALE : AS SHOWN
	DATE OF DRAWING : 1999.12.31
The Study on River Environment Improvement for The Tributaries of Han River System in Seoul Municipality and Its Vicinity	

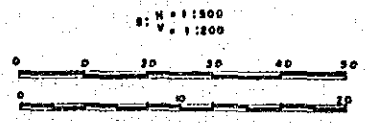
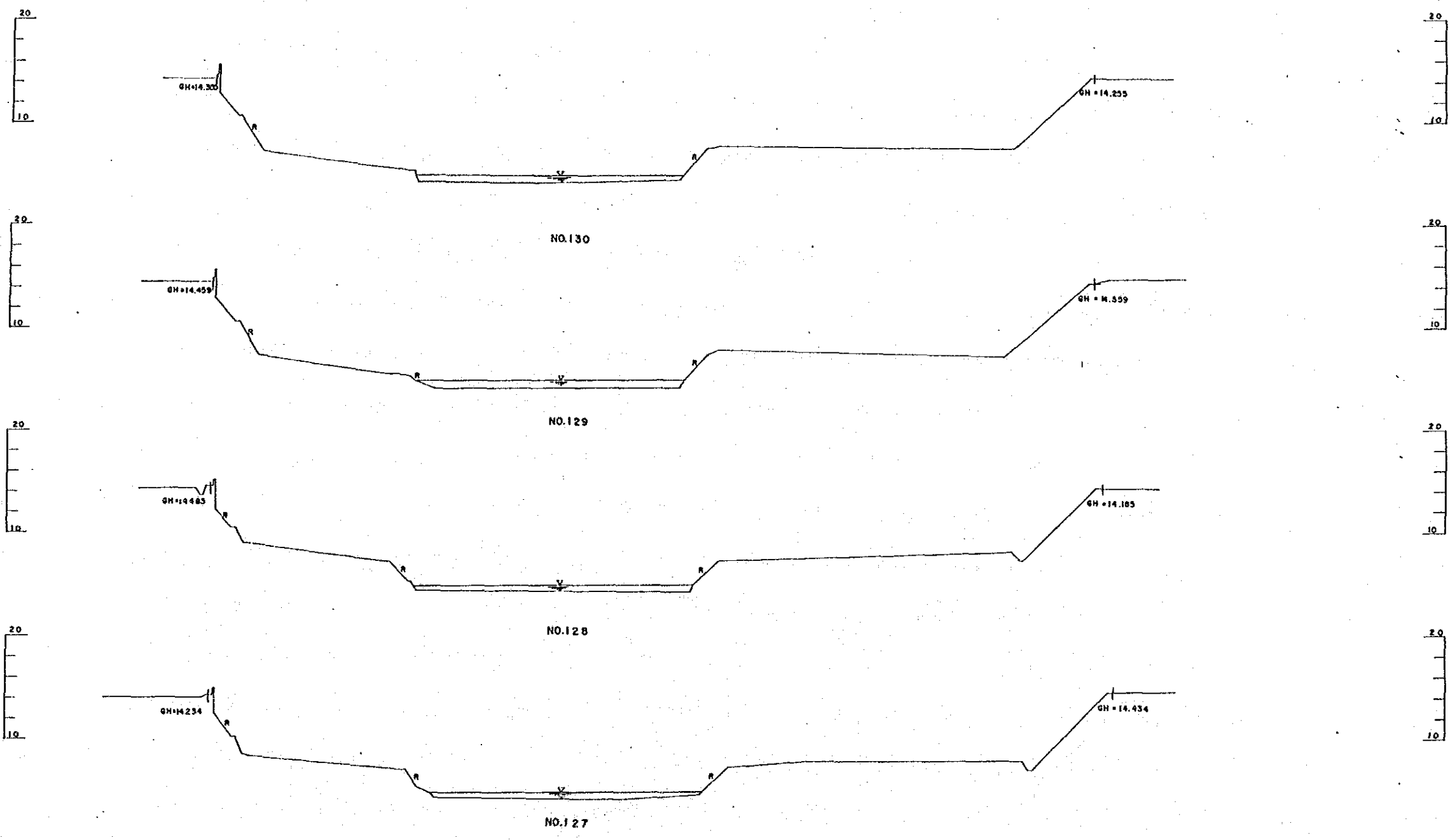

LEGEND	FIG :
	AC 34
SOURCE	: JICA STUDY TEAM
SCALE	: AS SHOWN
DATE OF DRAWING	: 1990.12.31
The Study on River Environment Improvement for The Tributaries of Han River System in Seoul Municipality and Its Vicinity	

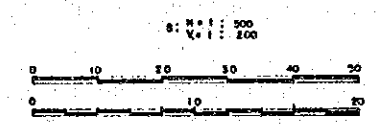
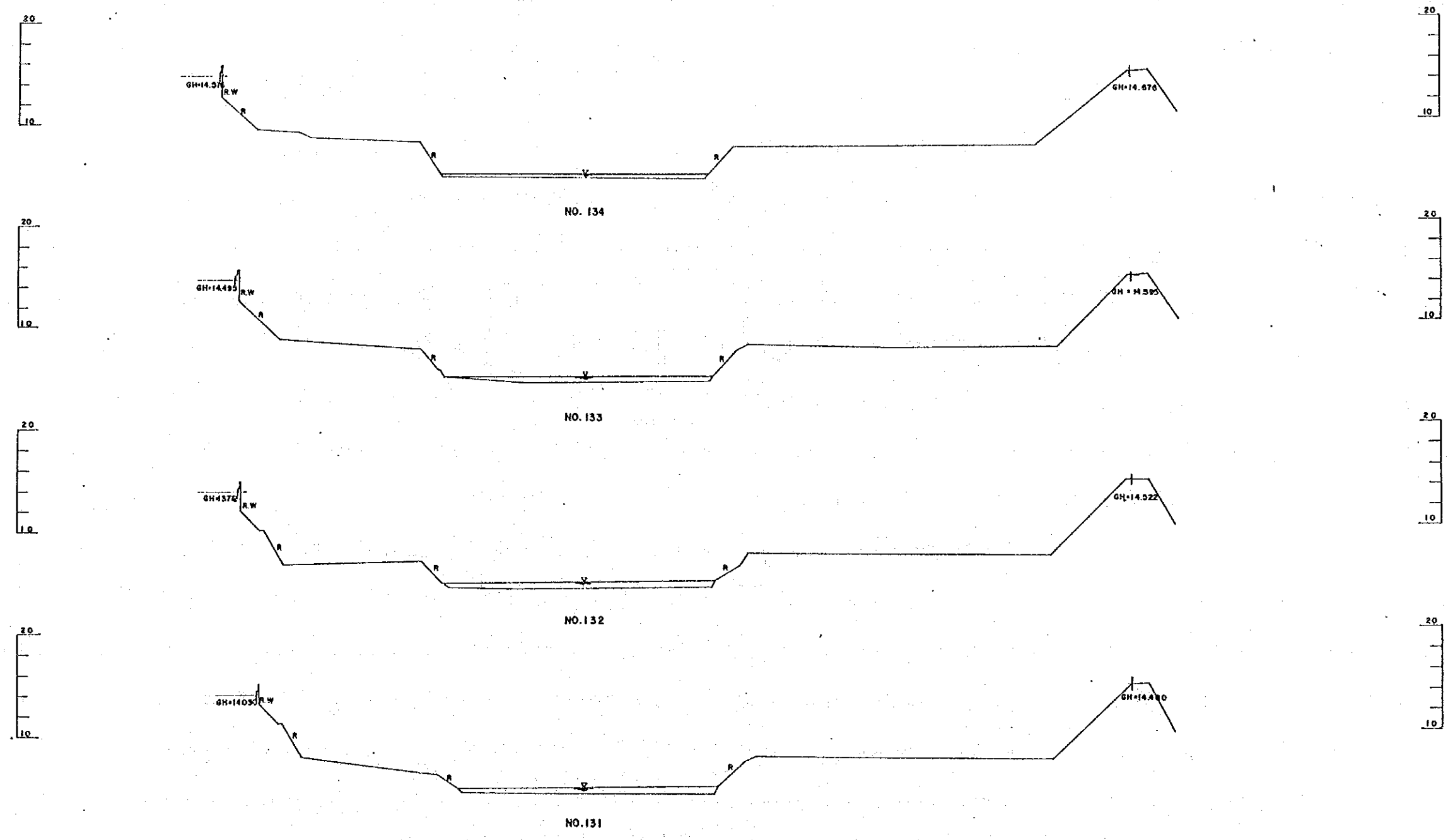

LEGEND	FIG :
	AC 35
	SOURCE : JICA STUDY TEAM
	SCALE : AS SHOWN
	DATE OF DRAWING : 1990. 12. 31
The Study on River Environment Improvement for The Tributaries of Han River System in Seoul Municipality and Its Vicinity	

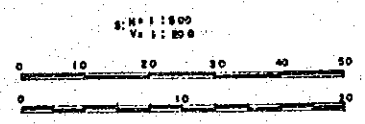
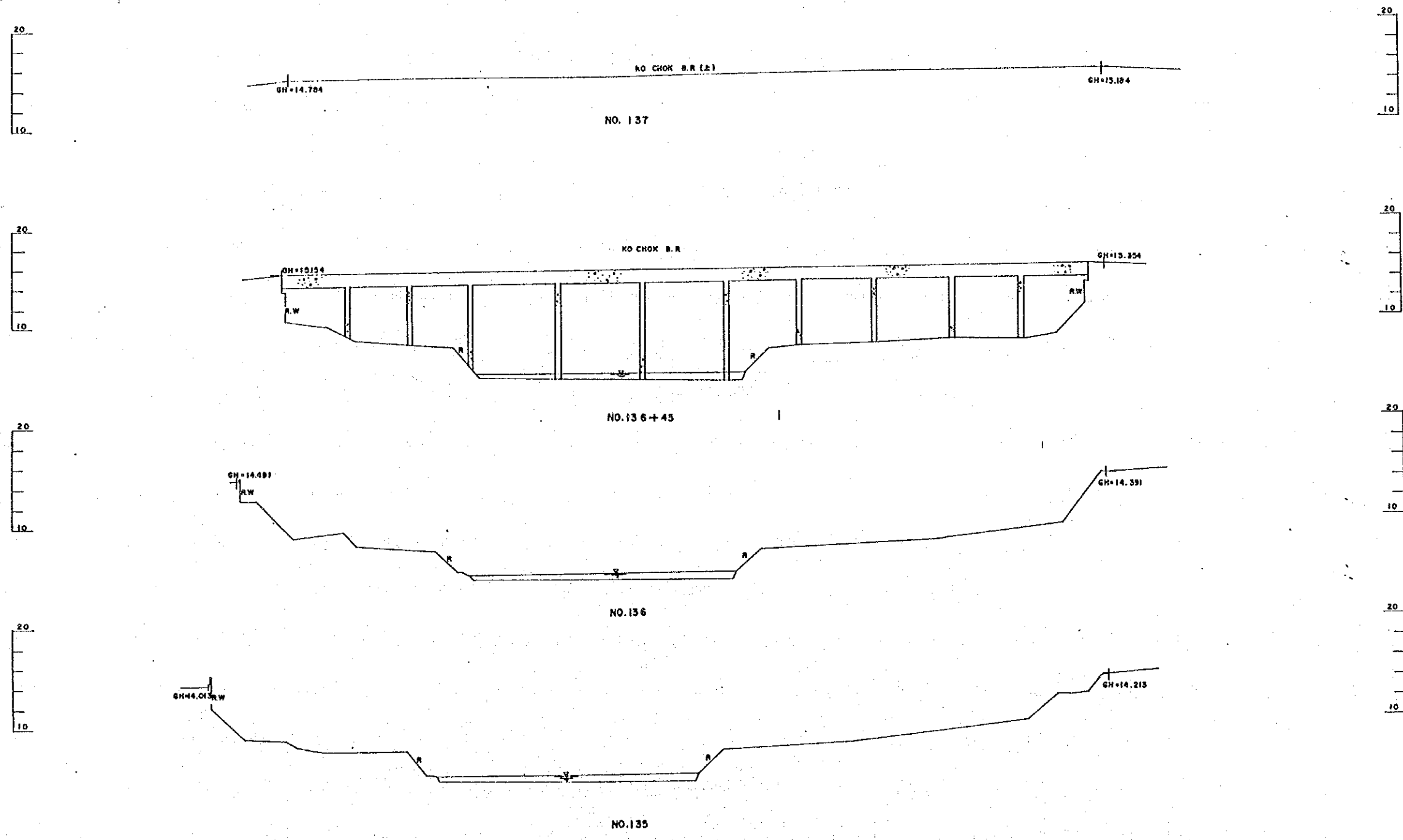

LEGEND	FIG
	AC 36
	SOURCE : JICA STUDY TEAM
	SCALE : A B SHOWN
	DATE OF DRAWING : 1990. 12. 31
The Study on River Environment Improvement for The Tributaries of Han River System in Seoul Municipality and Its Vicinity	

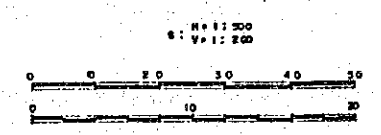
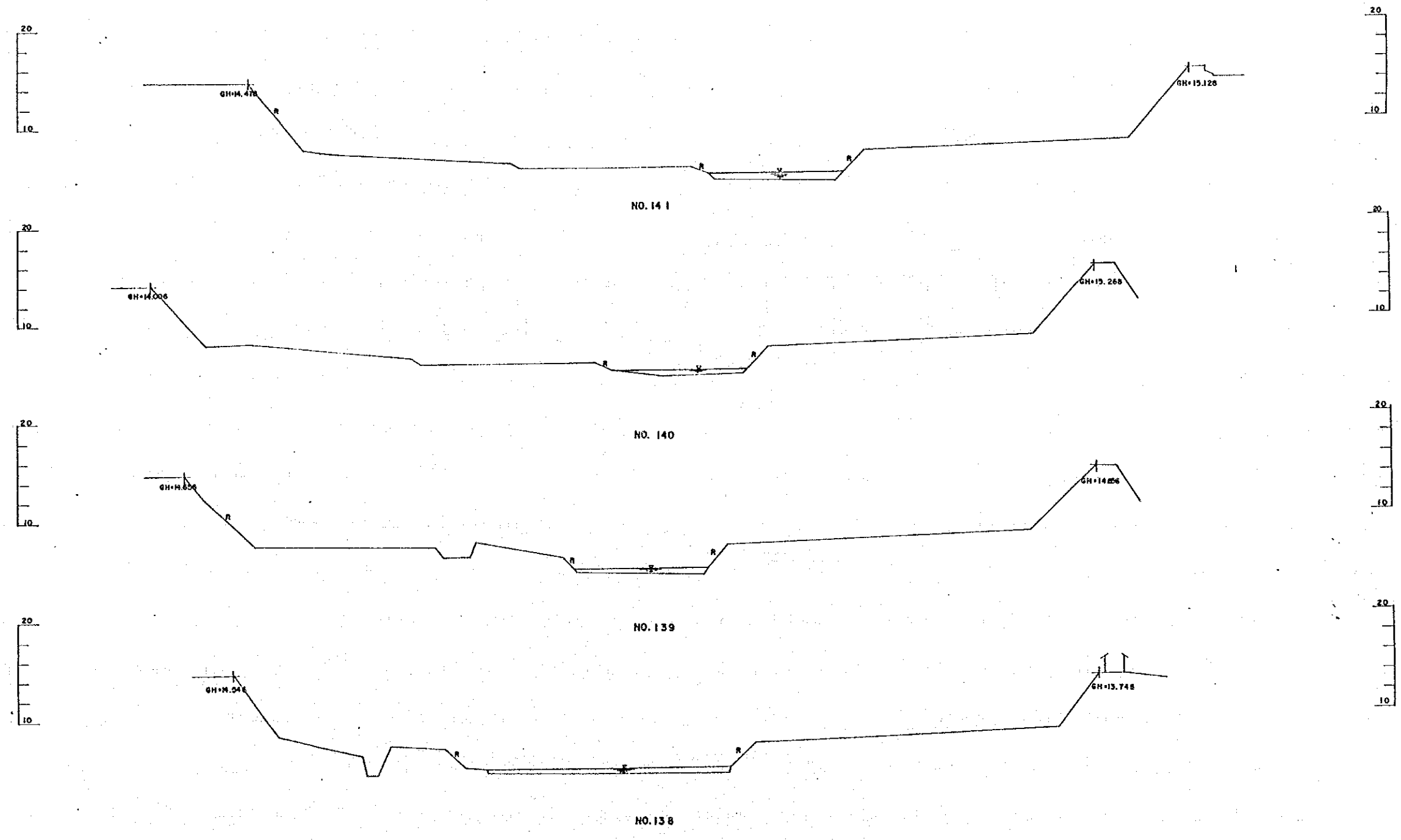

LEGEND	FIG
	AC 37
	SOURCE : JICA STUDY TEAM
	SCALE : AS SHOWN
	DATE OF DRAWING : 1990.12.31
The Study on River Environment Improvement for The Tributaries of Han River System in Seoul Municipality and Its Vicinity	

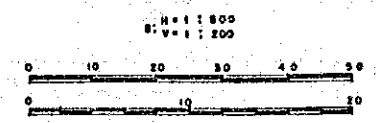
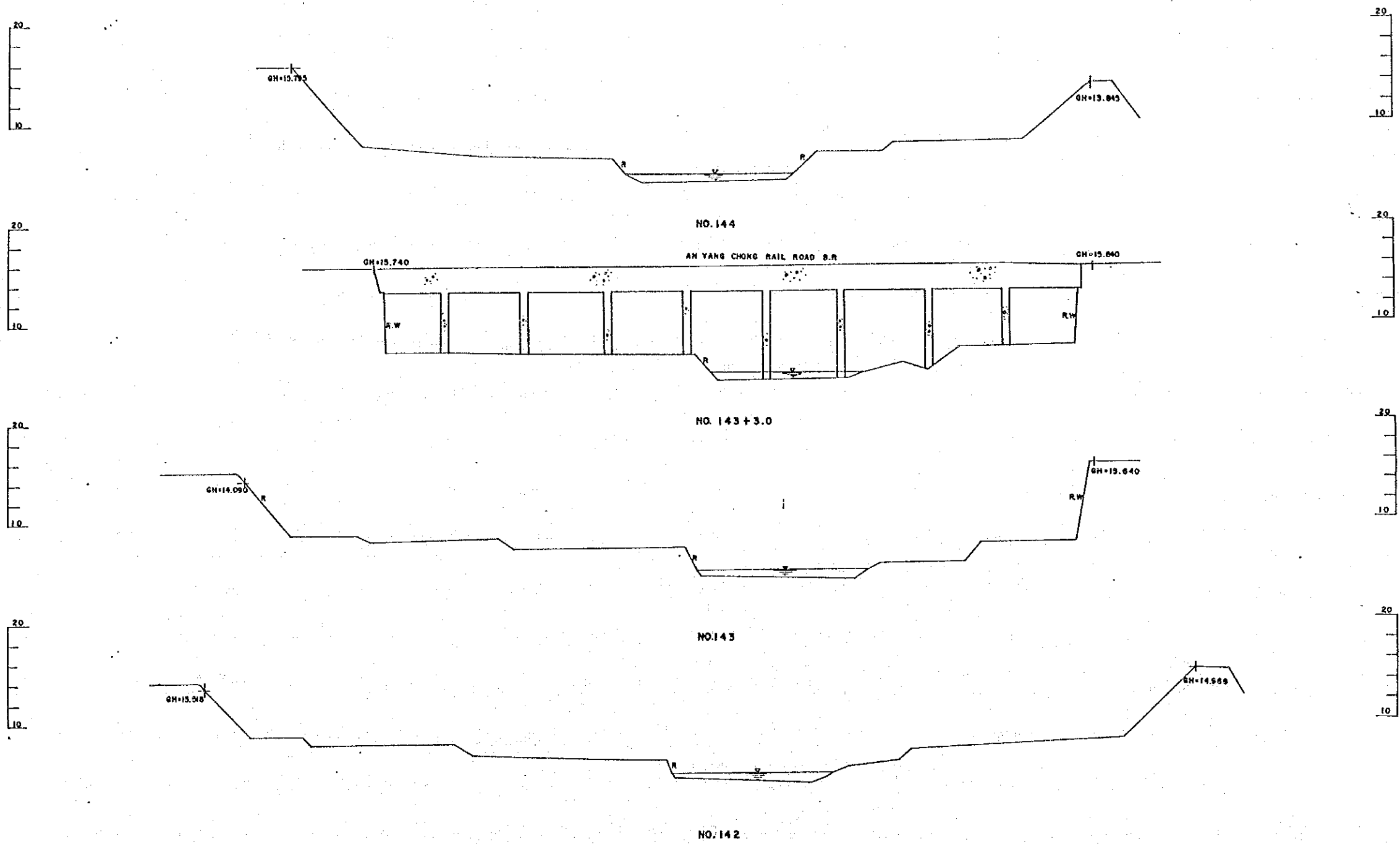

LEGEND	FIG
	AC 30
	SOURCE : JICA STUDY TEAM
	SCALE : A 2 SHOW
	DATE OF DRAWING : 1990. 12. 31
The Study on River Environment Improvement for The Tributaries of Han River System in Seoul Municipality and Its Vicinity	

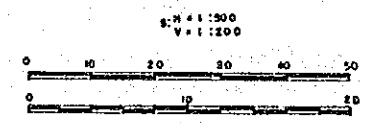
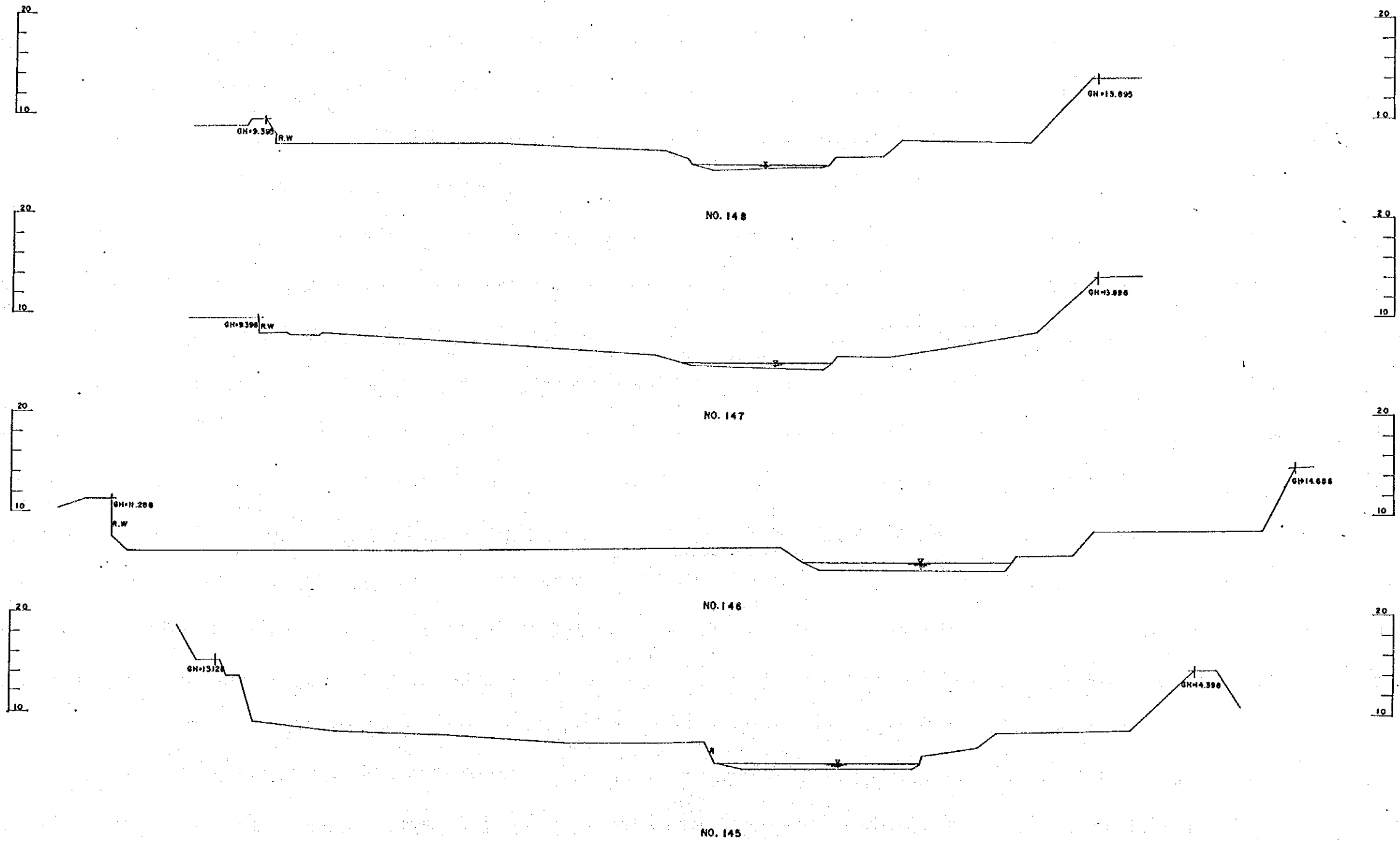

LEGEND	FIG :
	AC 39
	SOURCE : JICA STUDY TEAM
	SCALE : AS SHOWN
	DATE OF DRAWING : 1990. 12. 31
The Study on River Environment Improvement for The Tributaries of Han River System in Scout Municipality and Its Vicinity	

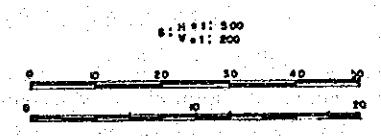
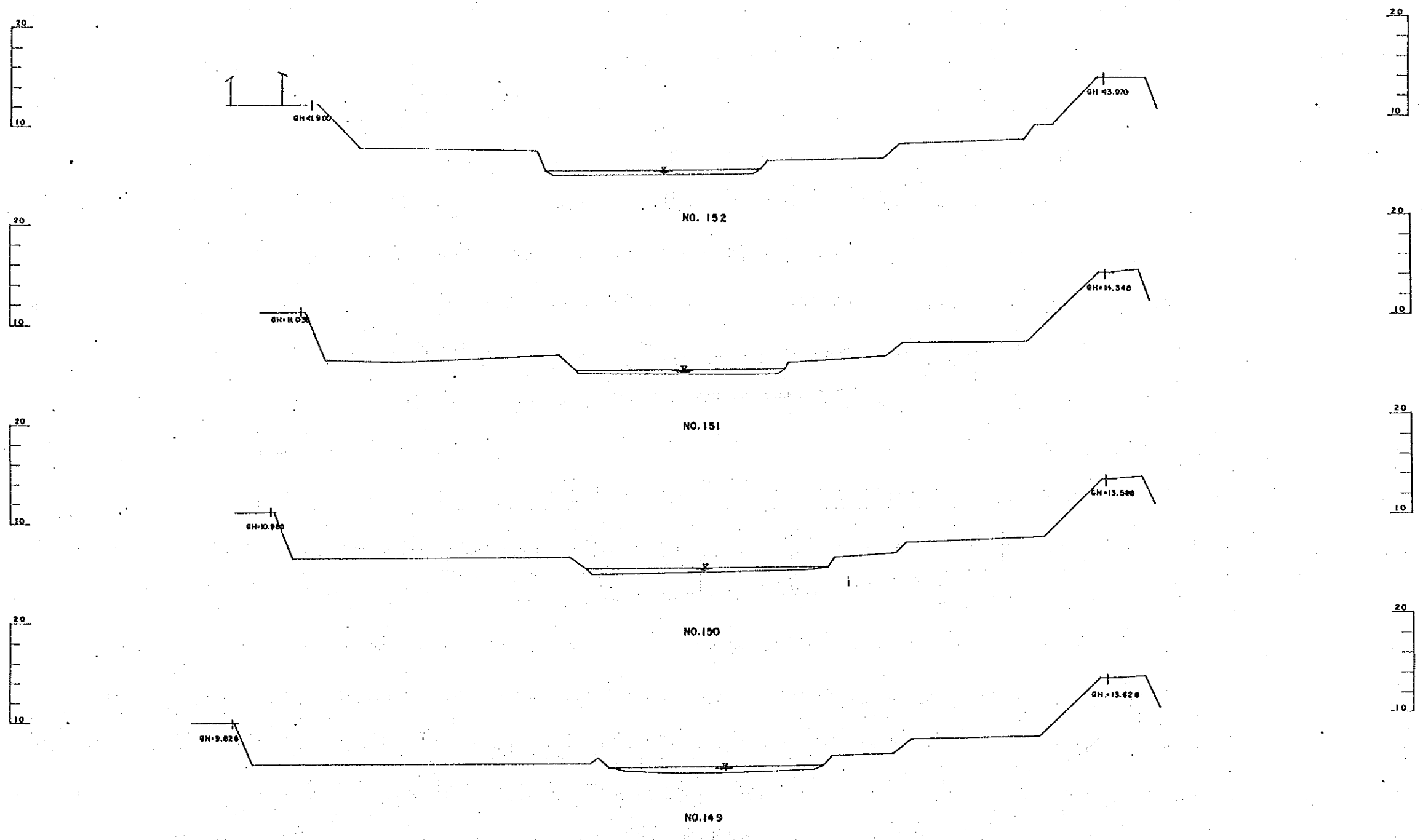

LEGEND	FIG :
	AC 40
	SOURCE : JICA STUDY TEAM
	SCALE : AS SHOWN
	DATE OF DRAWING : 1990.12.31
The Study on River Environment Improvement for The Tributaries of Han River System in Seoul Municipality and Its Vicinity	

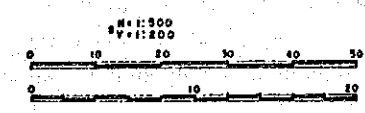
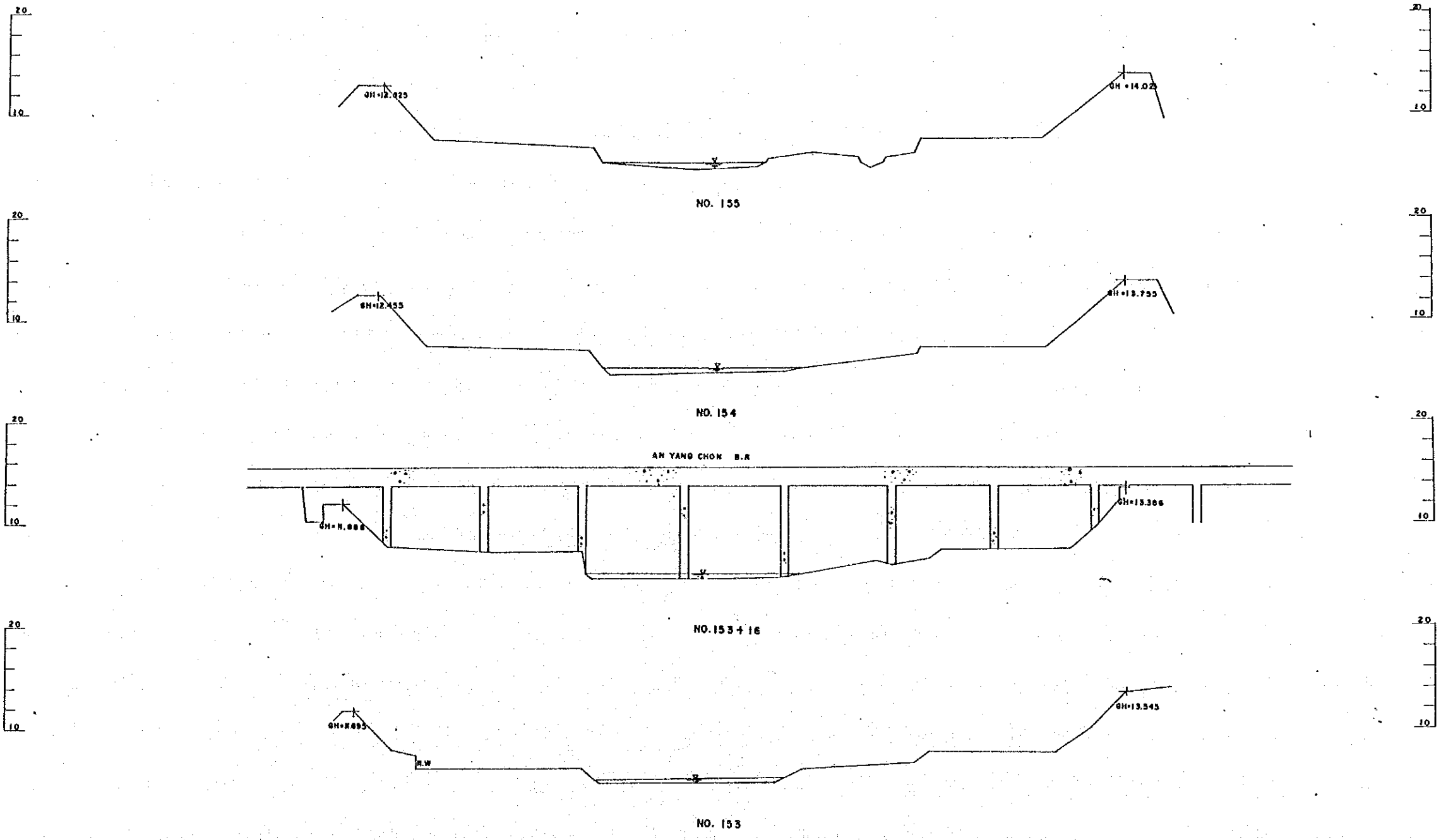

LEGEND	FIG :
	AC 41
	SOURCE : JICA STUDY TEAM
	SCALE : AS SHOWN
	DATE OF DRAWING : 1990. 12. 31
The Study on River Environment Improvement for The Tributaries of Han River System in Seoul Municipality and Its Vicinity	

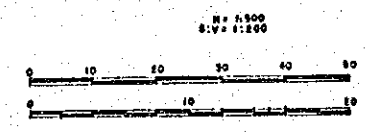
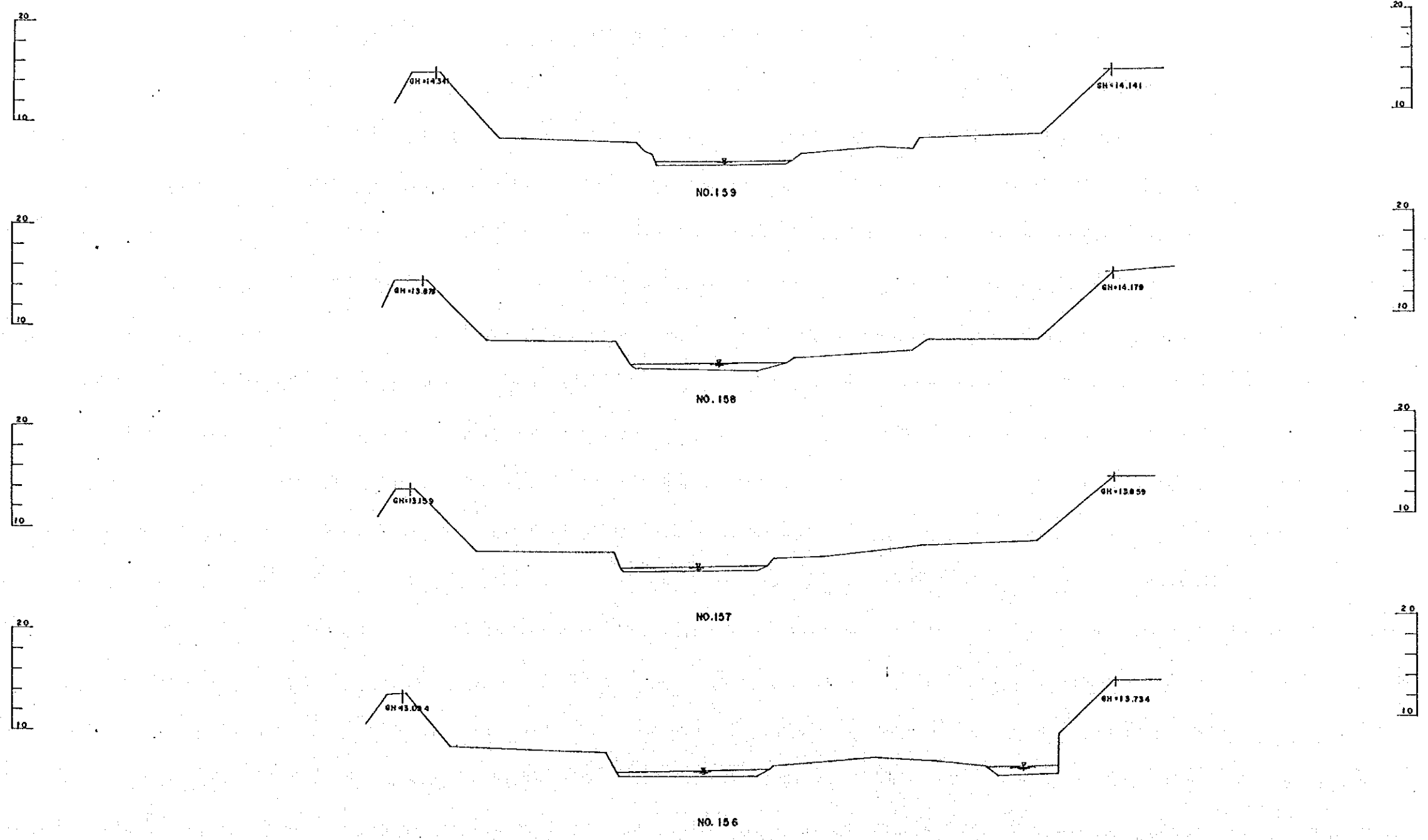

LEGEND	FIG
	AC 42
	SOURCE : JICA STUDY TEAM
	SCALE : AS SHOWN
	DATE OF DRAWING : 1990. 12. 31
The Study on River Environment Improvement for The Tributaries of Han River System in Seoul Municipality and Its Vicinity	

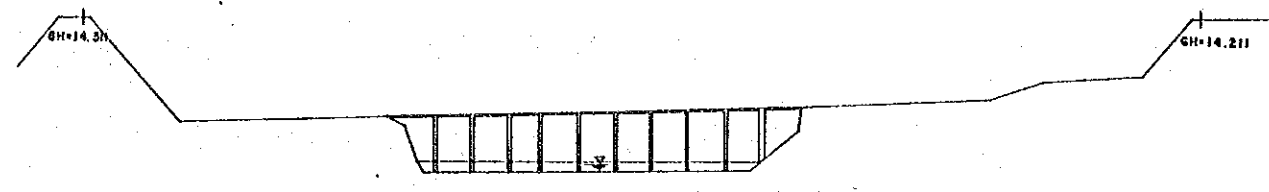

NO. 162 + 6.5

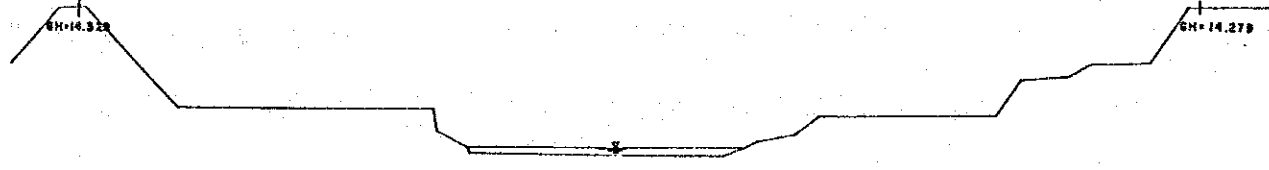

NO. 162

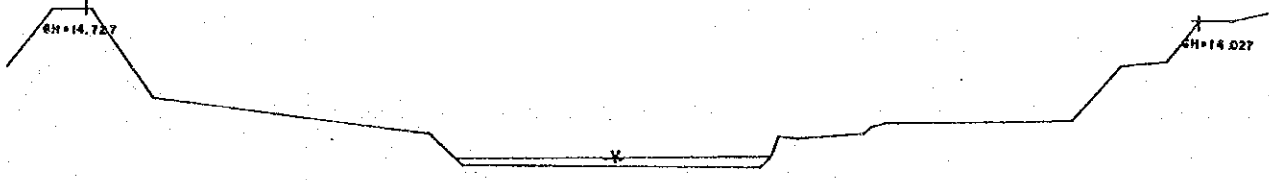

NO. 161

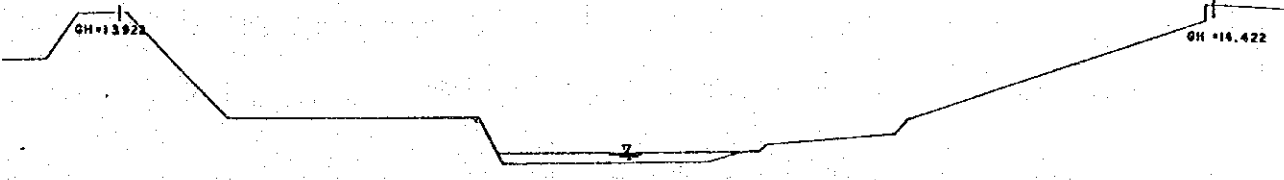

NO. 160



LEGEND	FIG :
	AC 43
	SOURCE : JICA STUDY TEAM
	SCALE : AS SHOWN
	DATE OF DRAWING : 1990.12.31
The Study on River Environment Improvement for The Tributaries of Han River System in Seoul Municipality and Its Vicinity	

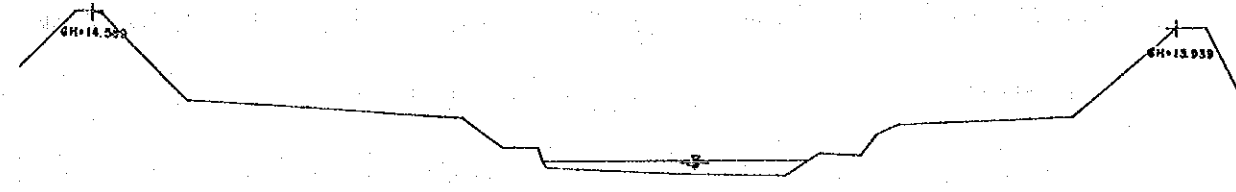
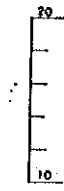

NO. 166

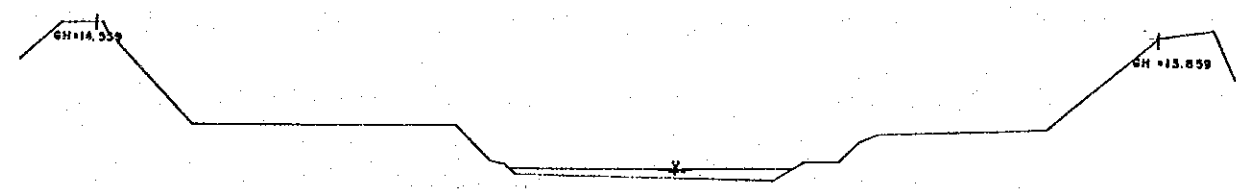

NO. 165

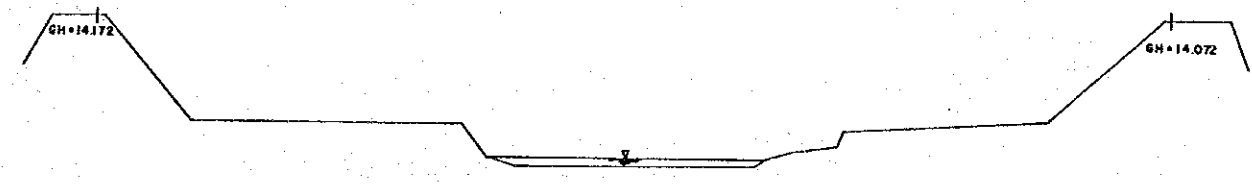

NO. 164

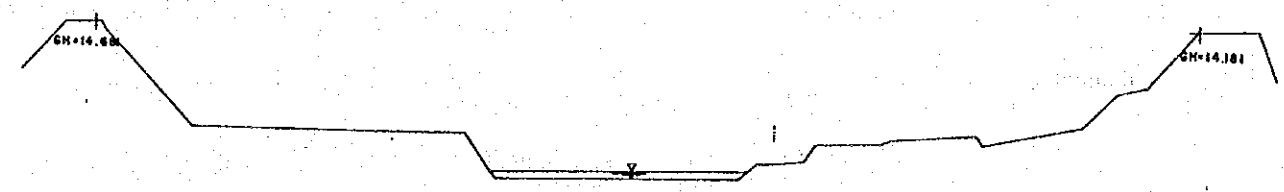

NO. 163

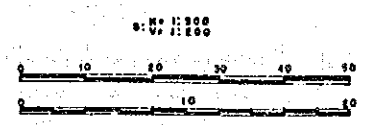

LEGEND	FIG
	AC 44
	SOURCE : JICA STUDY TEAM
	SCALE : AS SHOWN
	DATE OF DRAWING : 1990. 12. 31
The Study on River Environment Improvement for The Tributaries of Han River System in Seoul Municipality and Its Vicinity	

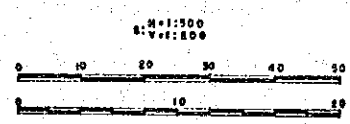
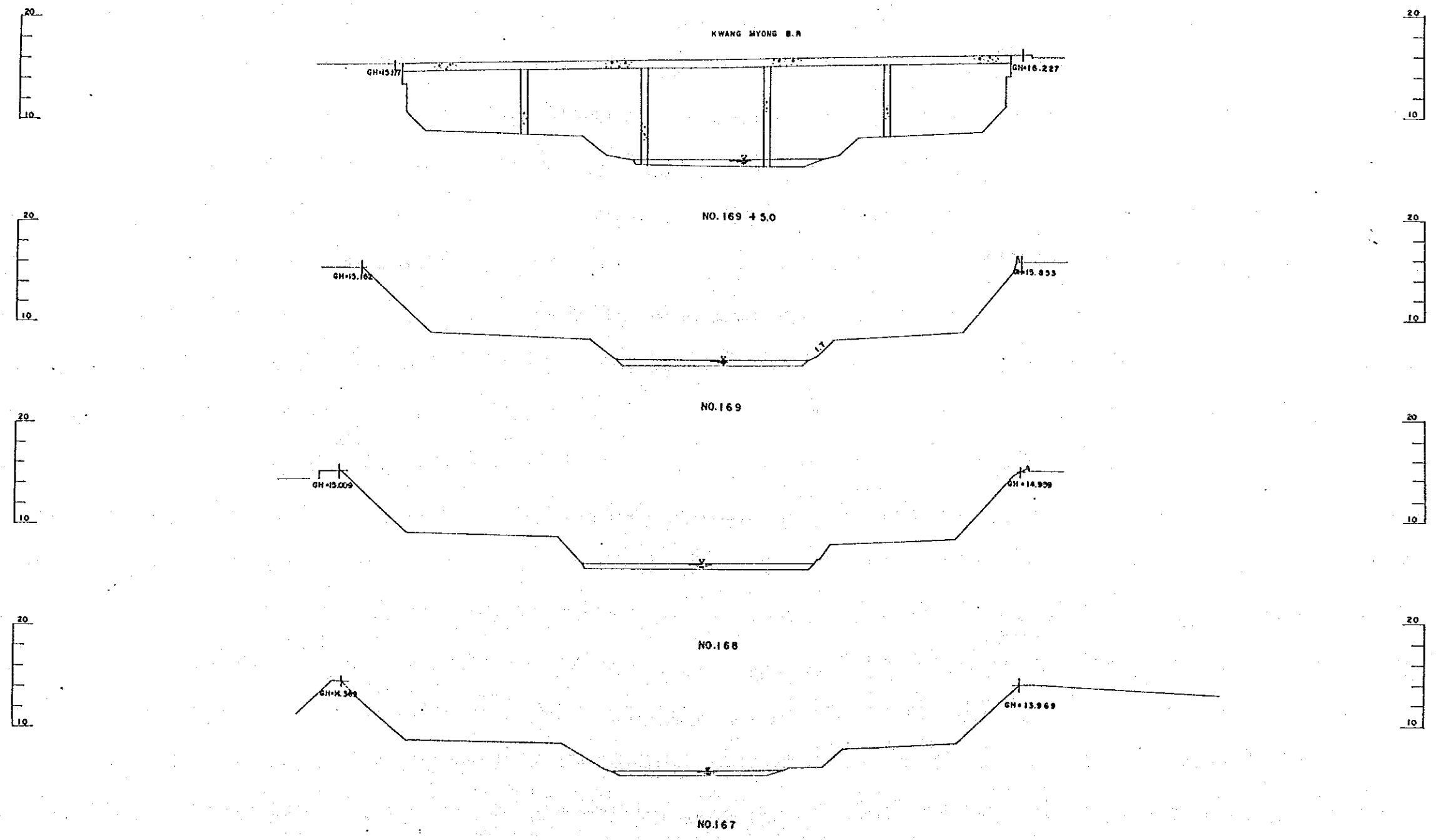

LEGEND	FIG :
	AC 45
	SOURCE : JICA STUDY TEAM
	SCALE : A.E. SHOWN
	DATE OF DRAWING : 1990.12.31
The Study on River Environment Improvement for The Tributaries of Han River System in Seoul Municipality and Its Vicinity	

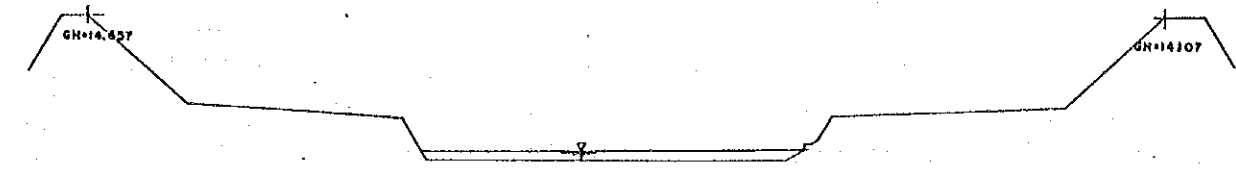

NO. 173

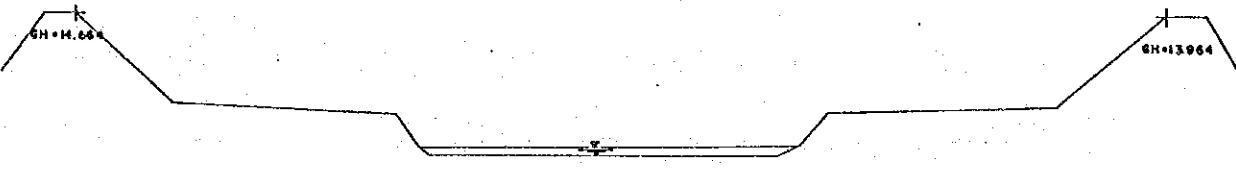

NO. 172

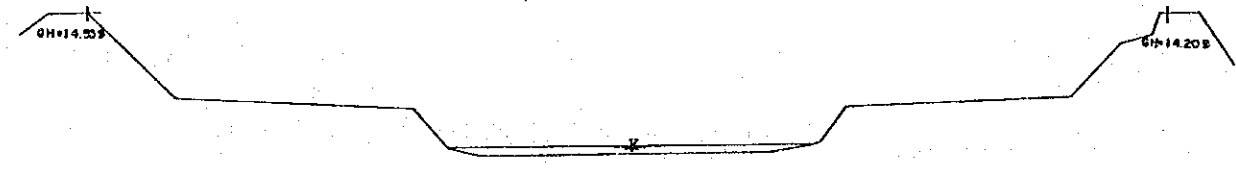
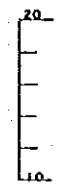

NO. 171



NO. 170

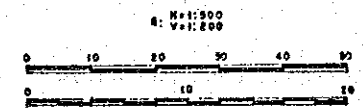

LEGEND	FIG. :
	AC 46
	SOURCE : JICA STUDY TEAM
	SCALE : AS SHOWN
DATE OF DRAWING : 1990. 12. 31	

The Study on River Environment Improvement for The Tributaries of Han River System in Seoul Municipality and Its Vicinity

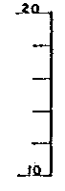
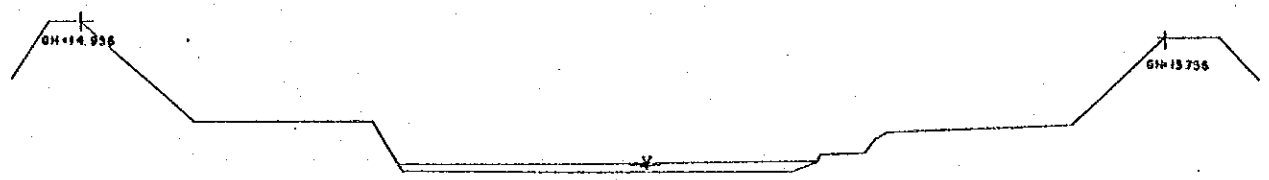

NO. 177

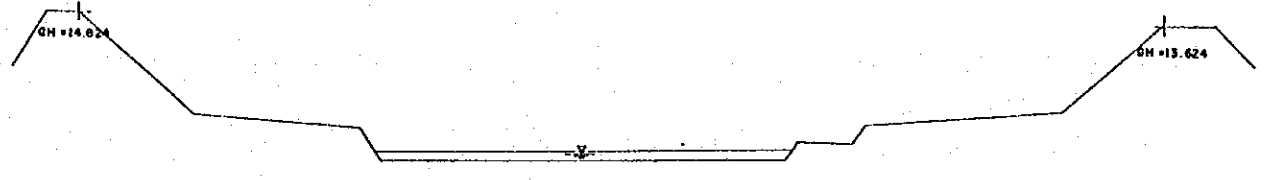

NO. 176

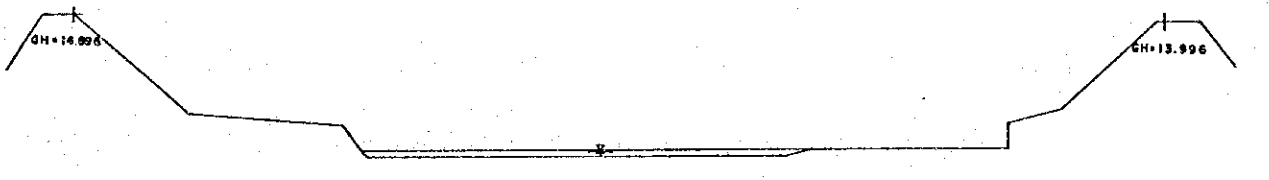

NO. 175

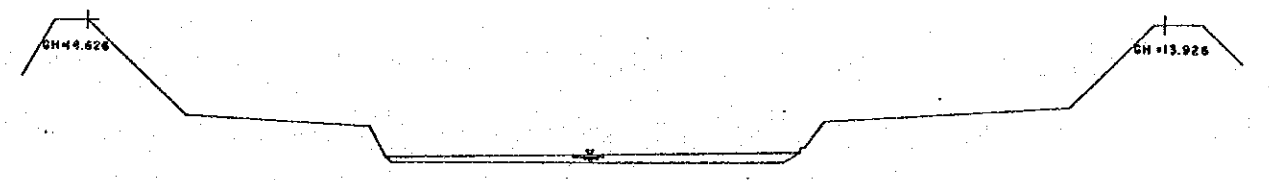

NO. 174

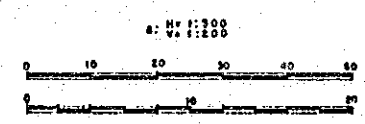

LEGEND	FIG
	AC 47
	SOURCE : JICA STUDY TEAM
	SCALE : AS SHOWN
DATE OF DRAWING : 1990. 12. 9	
The Study on River Environment Improvement for The Tributaries of Han River System in Seoul Municipality and Its Vicinity	

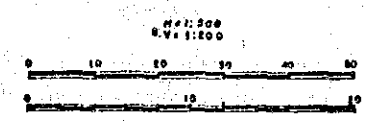
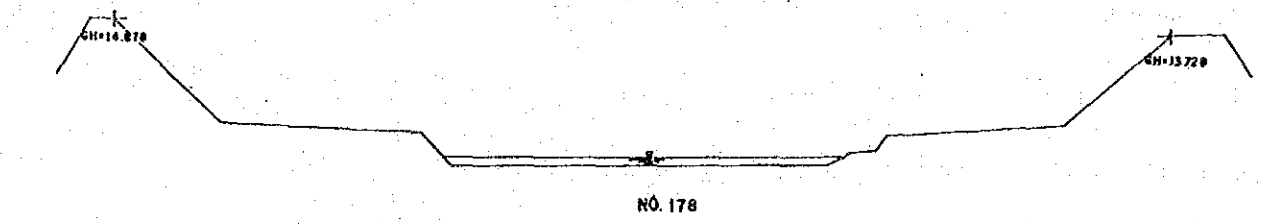
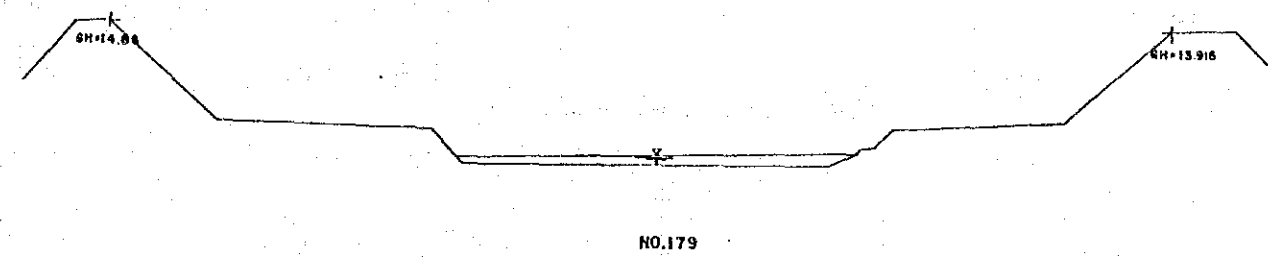
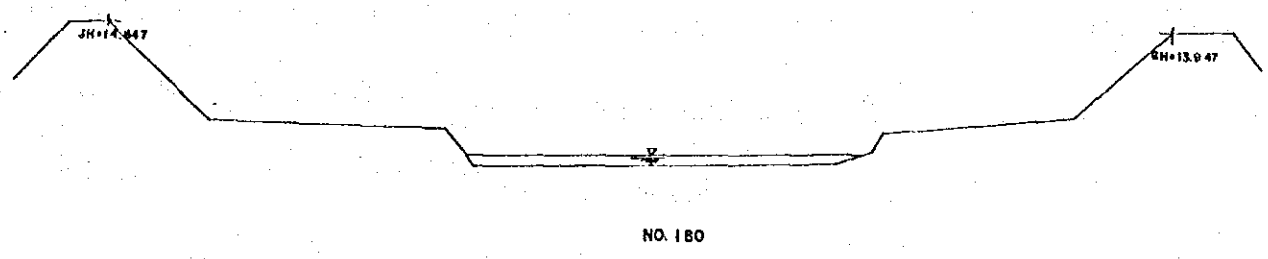
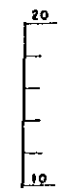
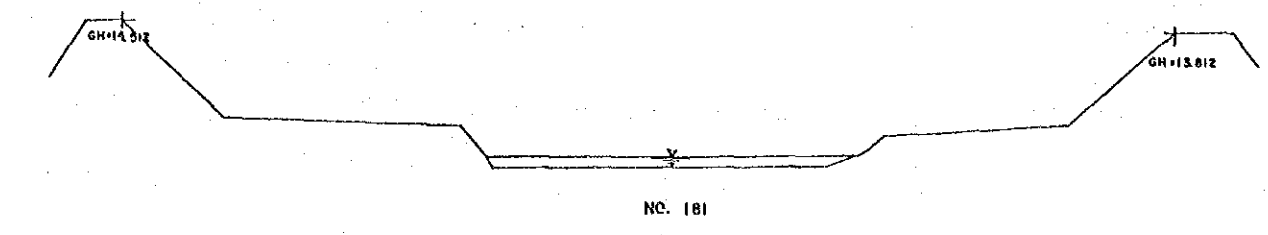

LEGEND	FIG :
	AC 48
	SOURCE : JICA STUDY TEAM
	SCALE : AS SHOWN
	DATE OF DRAWING : 1990. 12. 31
The Study on River Environment Improvement for The Tributaries of Han River System in Seoul Municipality and Its Vicinity	

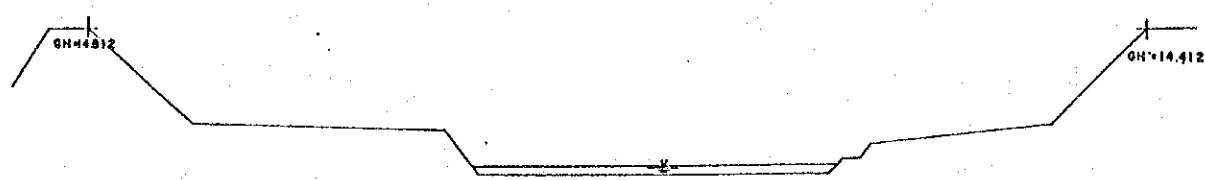
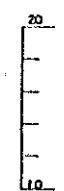

NO. 185

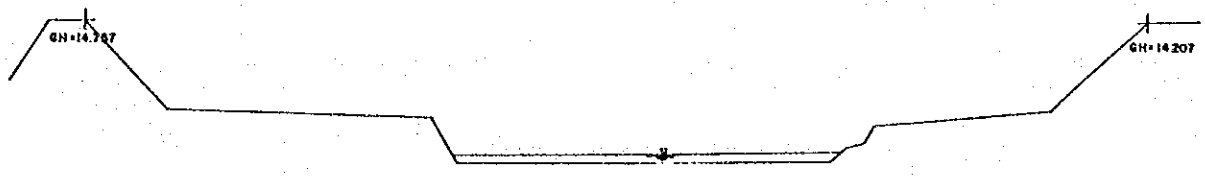
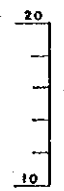

NO. 184

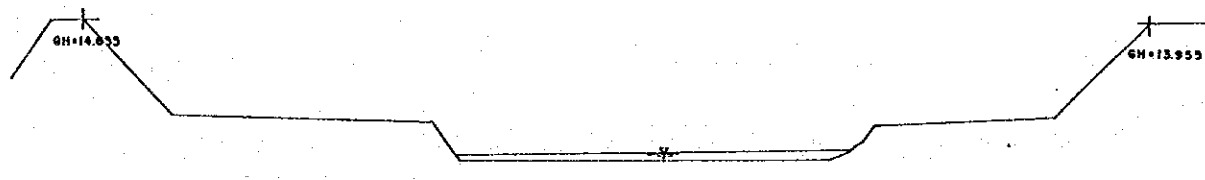
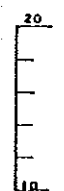
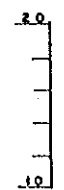

NO. 183

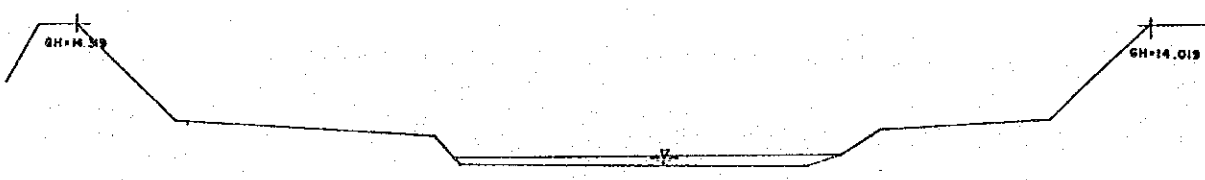
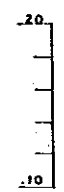

NO. 182

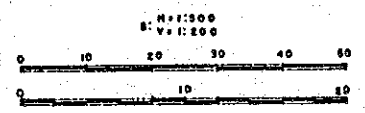

LEGEND	FIG
	AC 49
	SOURCE : JICA STUDY TEAM
	SCALE : A.S. SHOWN
	DATE OF DRAWING : 1990. 12. 31

The Study on River Environment Improvement for The Tributaries of Han River System in Seoul Municipality and Its Vicinity

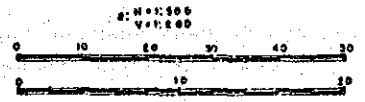
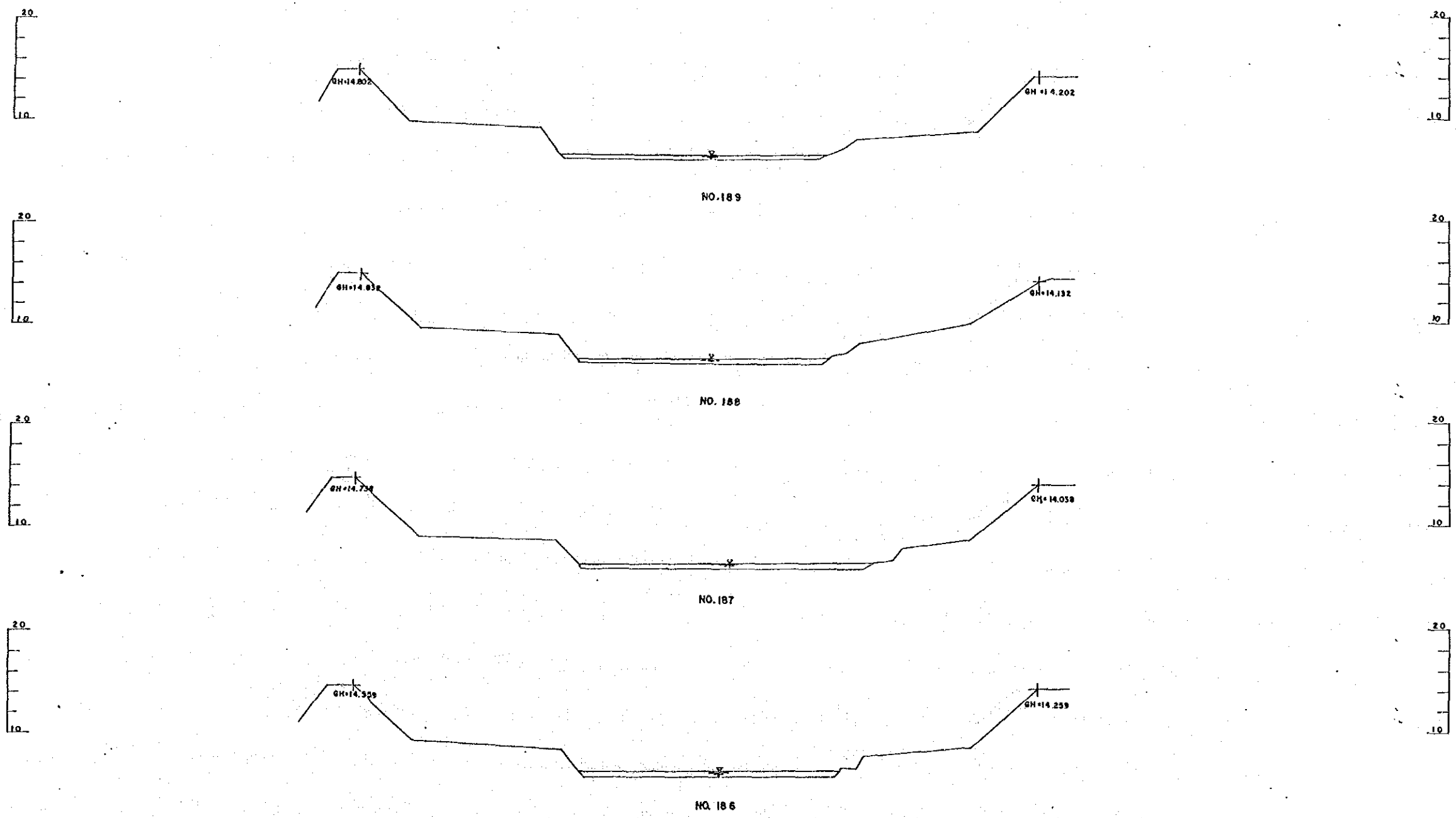

LEGEND	FIG :
	AC 50
	SOURCE : JICA STUDY TEAM
	SCALE : AS SHOWN
	DATE OF DRAWING : 1990. 12. 31
The Study on River Environment Improvement for The Tributaries of Han River System in Seoul Municipality and Its Vicinity	

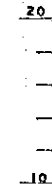
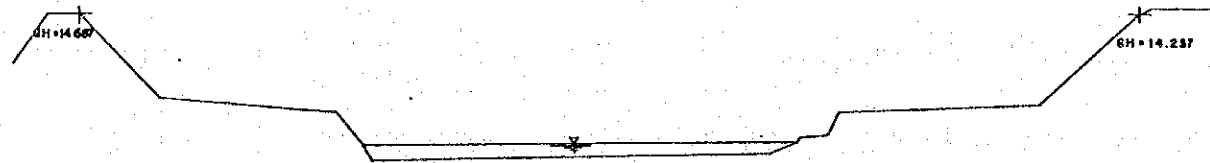
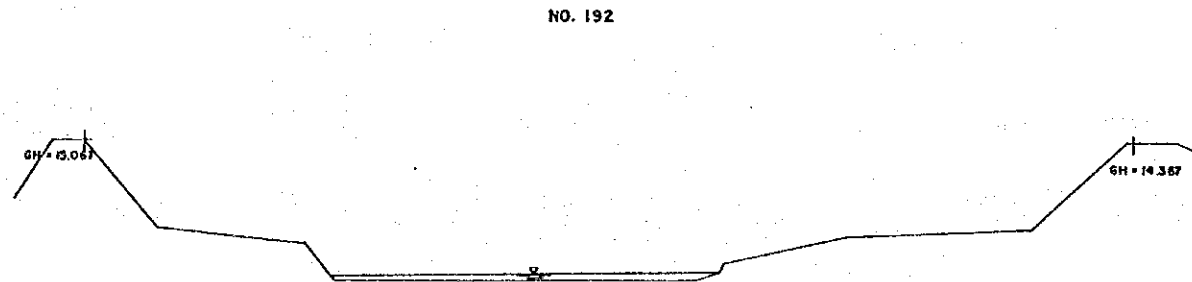
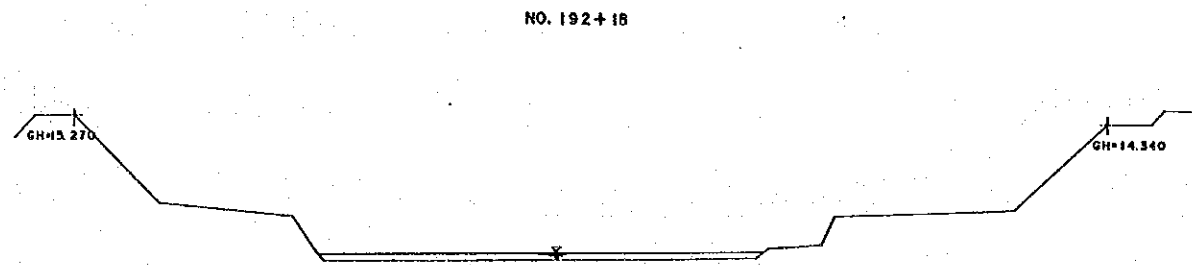
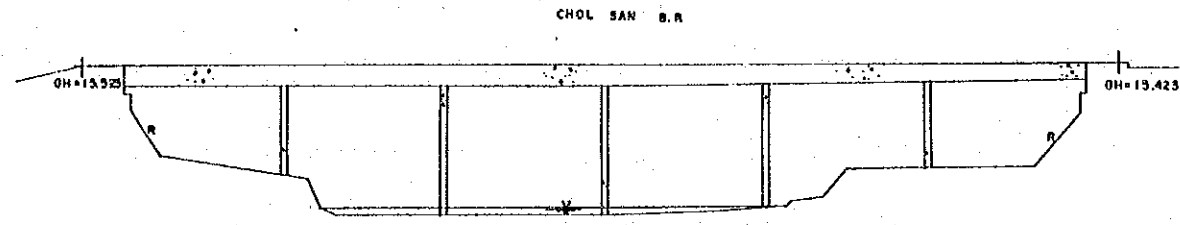

LEGEND	PK :
	AC 51
	SOURCE : JCA STUDY TEAM
	SCALE : AS SHOWN
	DATE OF DRAWING : 1990.12.31
The Study on River Environment Improvement for The Tributaries of Han River System in Seoul Municipality and Its Vicinity	

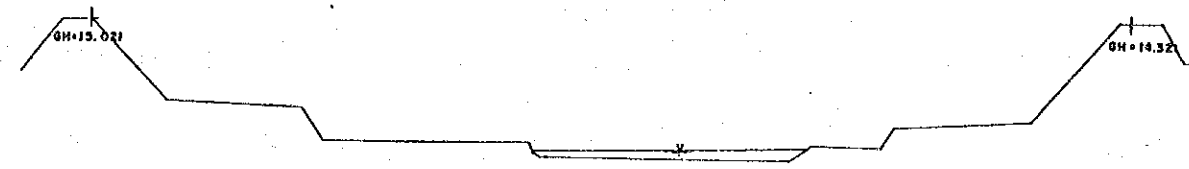

NO. 196

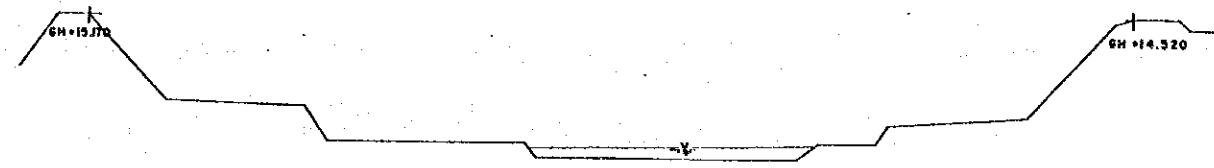
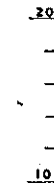

NO. 195

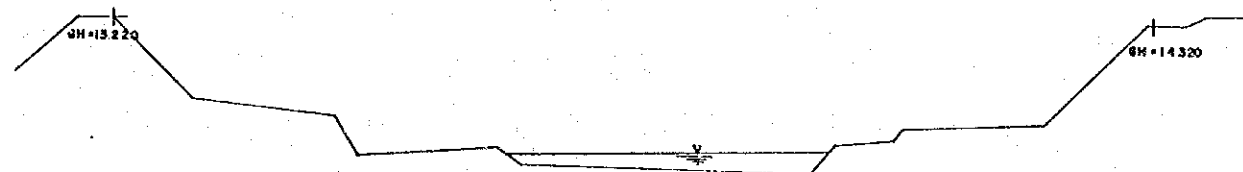
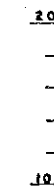

NO. 194

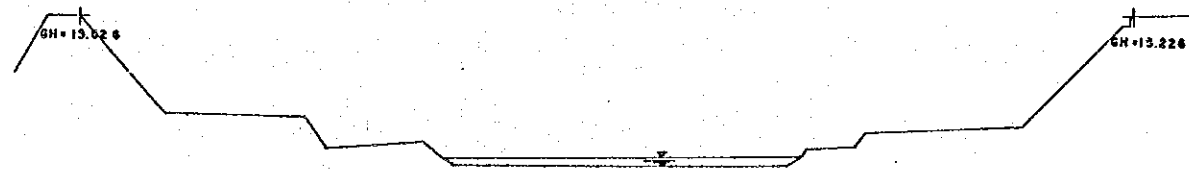
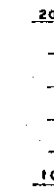

NO. 193

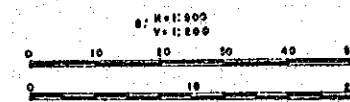
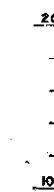

LEGEND	FIG. :
	AC 52
SOURCE :	JICA STUDY TEAM
SCALE :	AS SHOWN
DATE OF DRAWING :	1990.12.24
The Study on River Environment Improvement for The Tributaries of Han River System in Seoul Municipality and Its Vicinity	

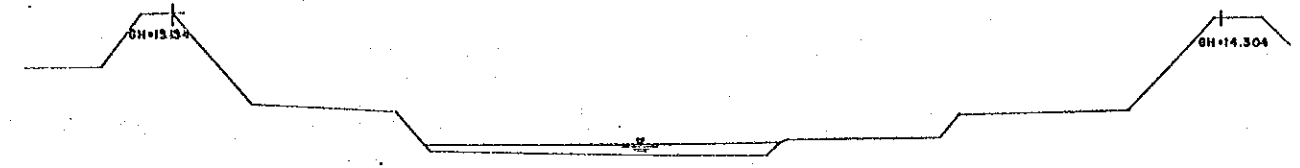

NO. 201

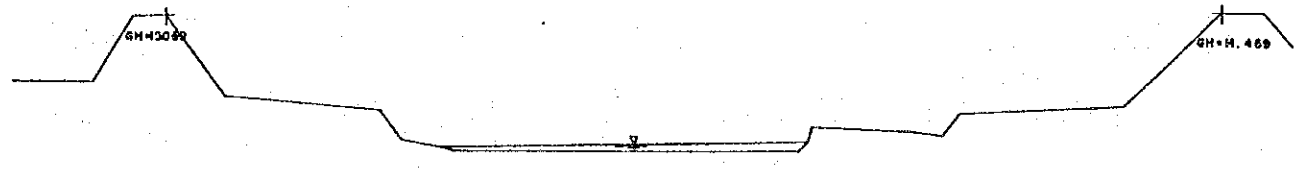

NO. 200

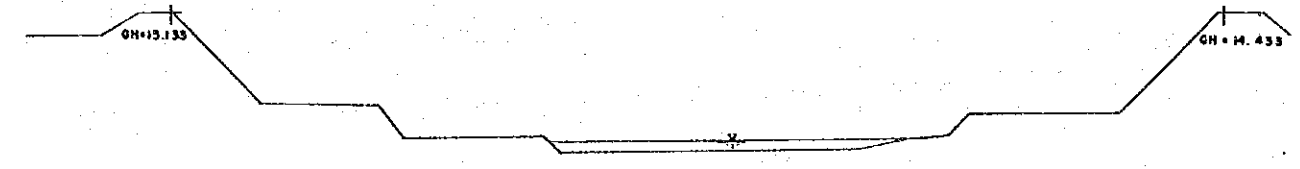

NO. 199

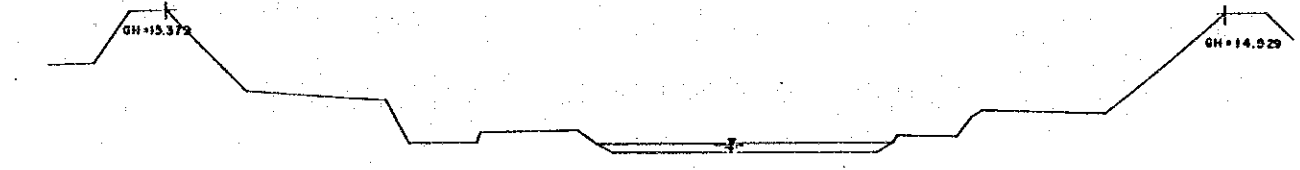

NO. 198

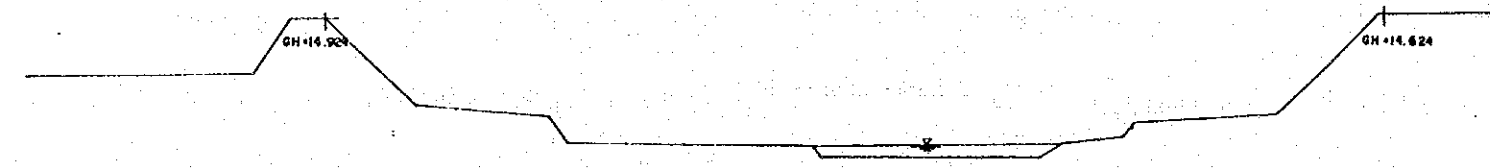
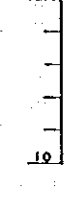

NO. 197

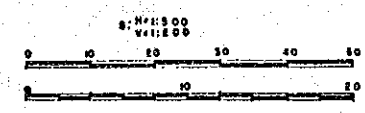

LEGEND	FIG :
	AC 53
	SOURCE : JICA STUDY TEAM
	SCALE : AS SHOWN
	DATE OF DRAWING : 1990. 12. 31

The Study on River Environment Improvement for The Tributaries of Han River System in Seoul Municipality and Its Vicinity

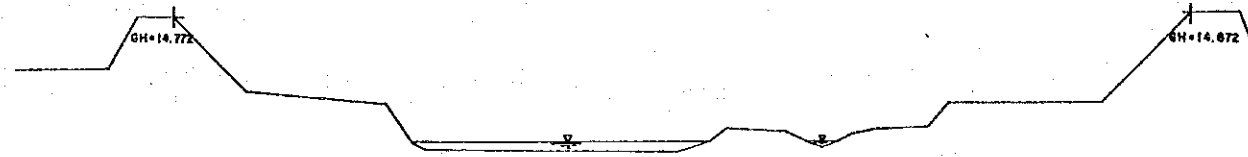
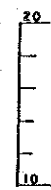

NO. 205

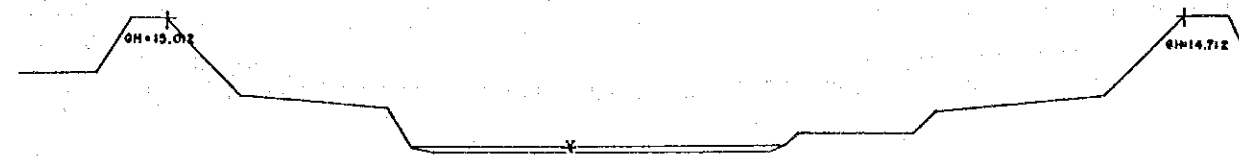
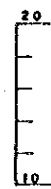
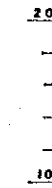

NO. 204

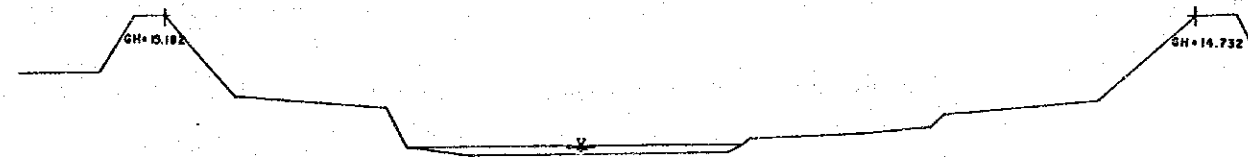
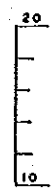
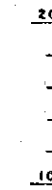

NO. 203

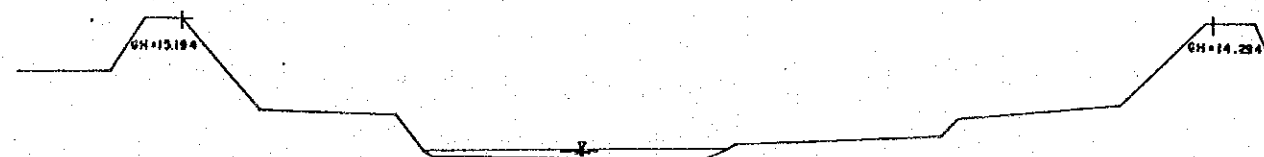

NO. 202



LEGEND	FIG.
	AC 54
	SOURCE : JICA STUDY TEAM
	SCALE : AS SHOWN
DATE OF DRAWING : 1990. 12. 31	
The Study on River Environment Improvement for The Tributaries of Han River System in Seoul Municipality and Its Vicinity	

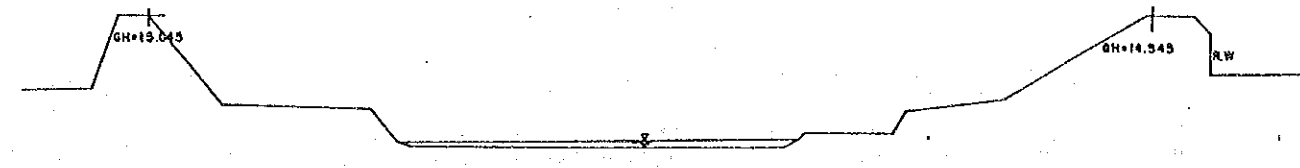

NO. 209

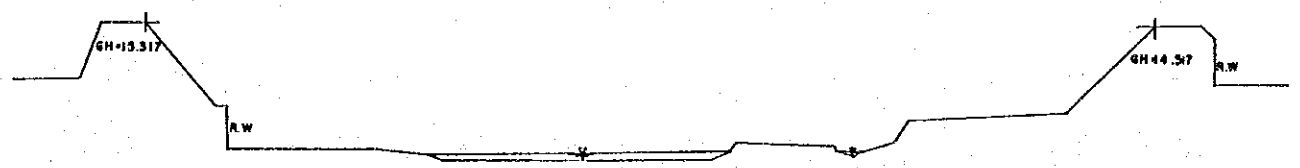
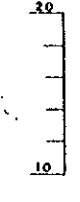

NO. 208

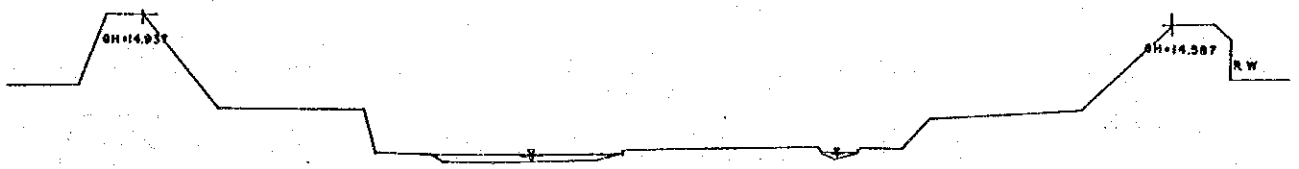

NO. 207

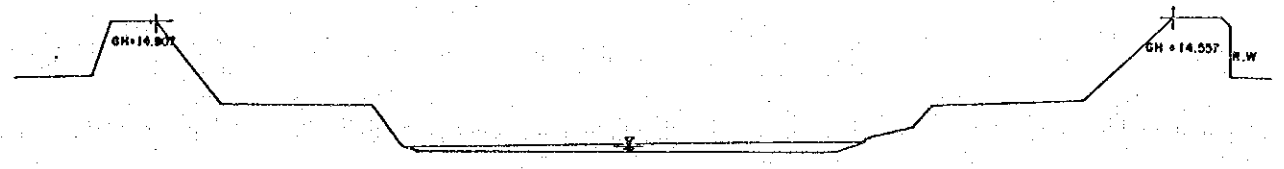

NO. 206

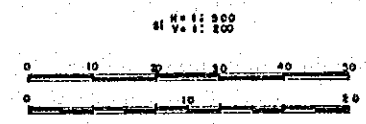

LEGEND	FIG :
	AC 55
	SOURCE : JICA STUDY TEAM
	SCALE : AS SHOWN
	DATE OF DRAWING : 1990. 12. 31
The Study on River Environment Improvement for The Tributaries of Han River System in Seoul Municipality and Its Vicinity	

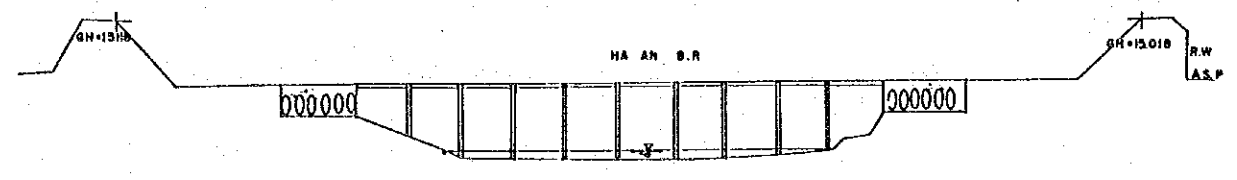

NO. 212+14

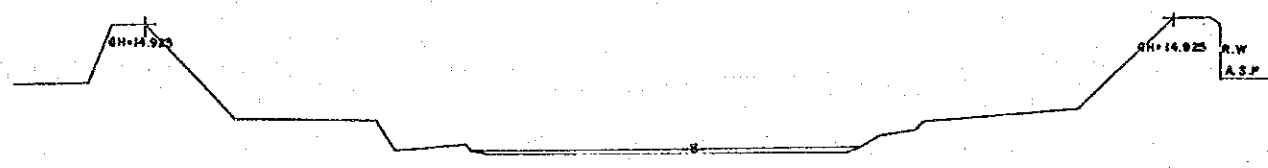

NO. 212

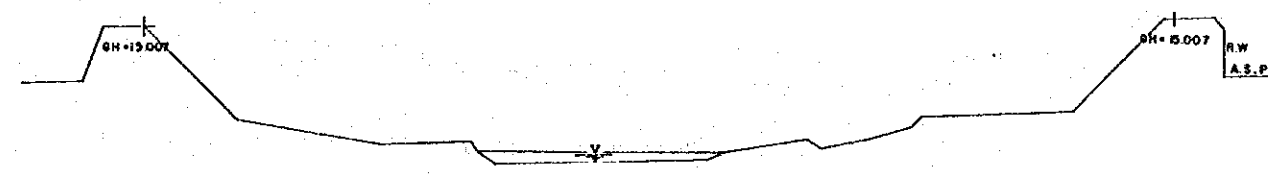
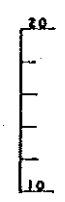

NO. 211

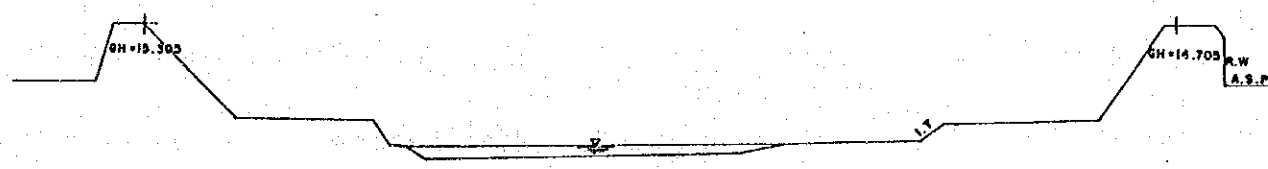
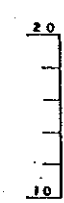

NO. 210

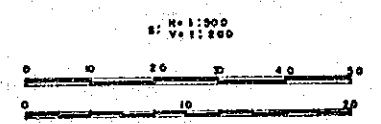

LEGEND	FIG :
	AC 56
	SOURCE : JICA STUDY TEAM
	SCALE : AS SHOWN
	DATE OF DRAWING : 1990. 12. 31
The Study on River Environment Improvement for The Tributaries of Han River System in Seoul Municipality and Its Vicinity	

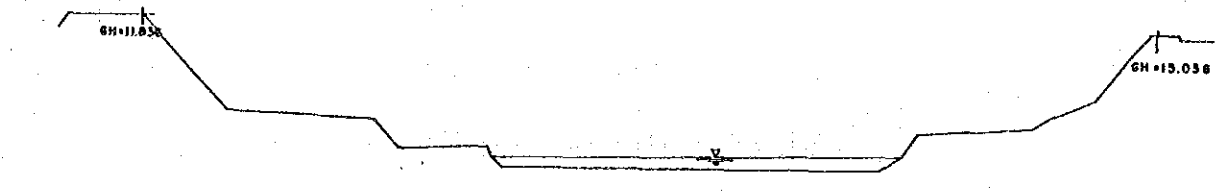

NO. 216

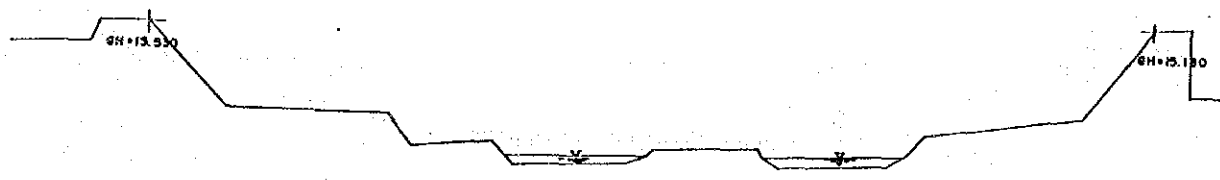

NO. 215

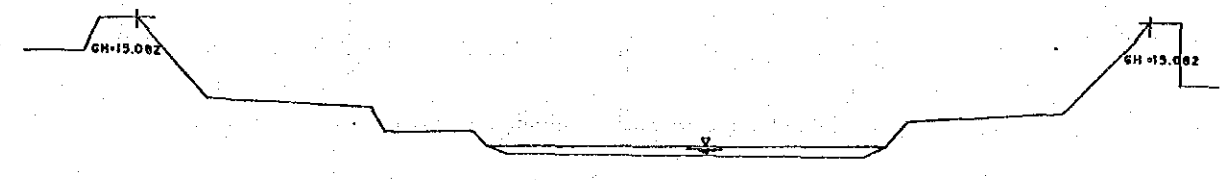

NO. 214

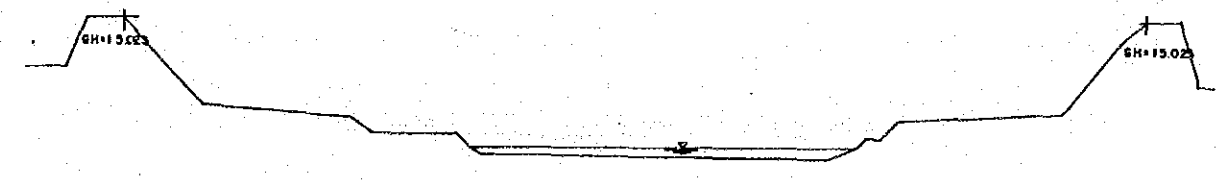

NO. 213

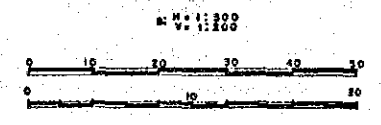

LEGEND	FIG. :
	AC 57
	SOURCE : JICA STUDY TEAM
	SCALE : AS SHOWN
	DATE OF DRAWING : 1990. 12. 31
The Study on River Environment Improvement for The Tributaries of Han River System in Seoul Municipality and Its Vicinity	

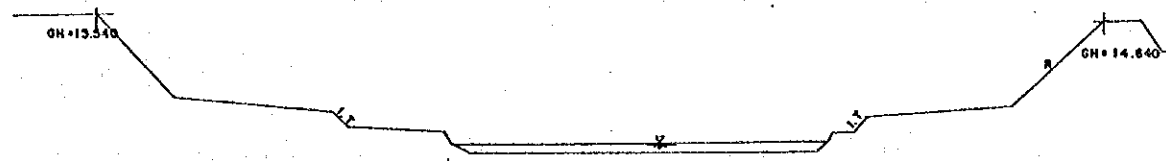
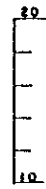

NO. 220

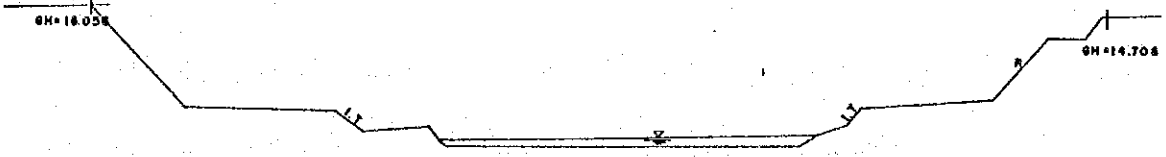

NO. 219

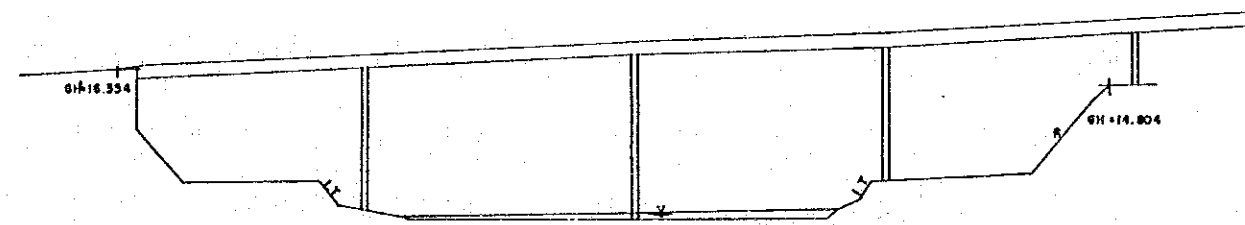
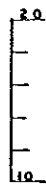
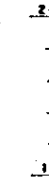

NO. 218

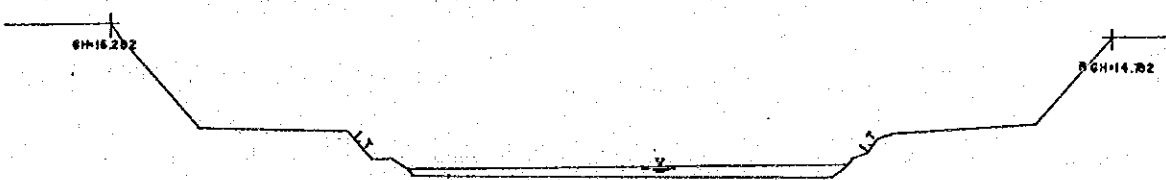
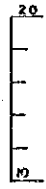

NO. 217

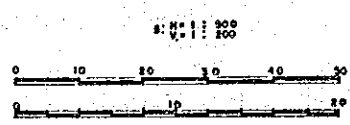
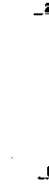

LEGEND	FIG
	AC 58
	SOURCE : JICA STUDY TEAM
	SCALE : AS SHOWN
	DATE OF DRAWING : 1990. 12. 31
The Study on River Environment Improvement for The Tributaries of Han River System in Seoul Municipality and Its Vicinity	

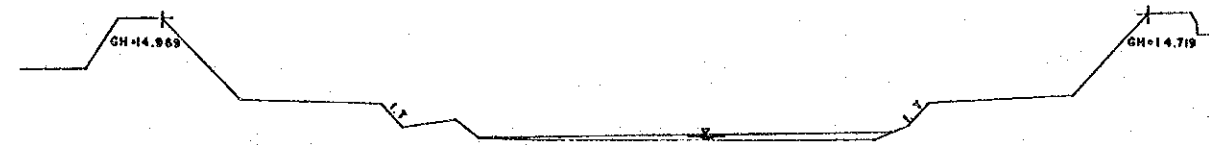

NO. 224

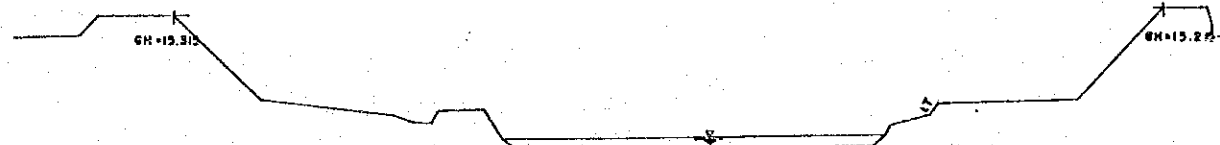

NO. 223

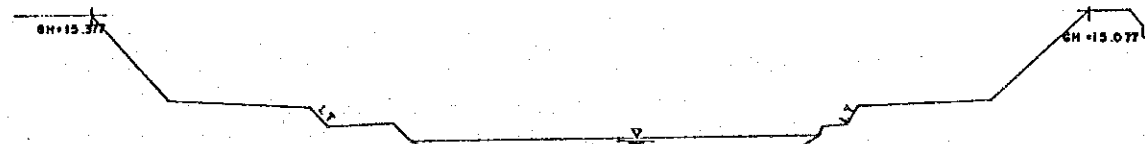
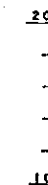

NO. 222

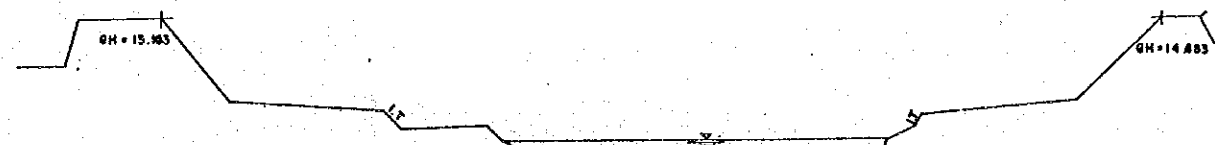
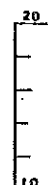

NO. 221

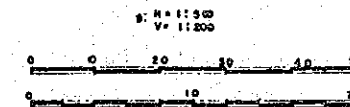

LEGEND	FIG
	AC 59
	SOURCE : JICA STUDY TEAM
	SCALE : AS SHOWN
	DATE OF DRAWING : 1990. 12. 31
The Study on River Environment Improvement for The Tributaries of Han River System in Seoul Municipality and Its Vicinity	

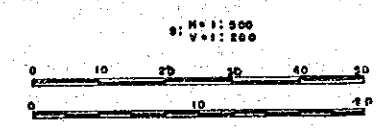
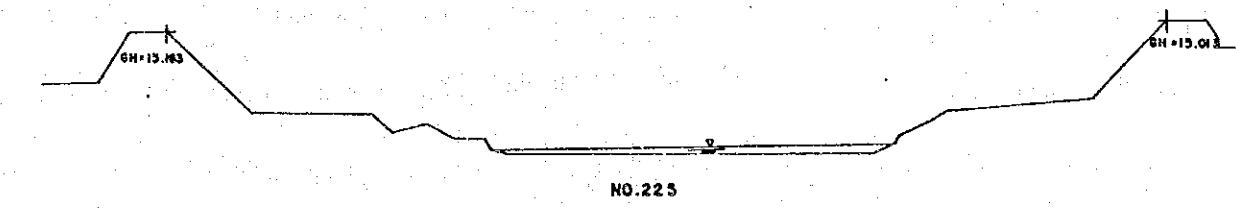
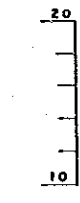
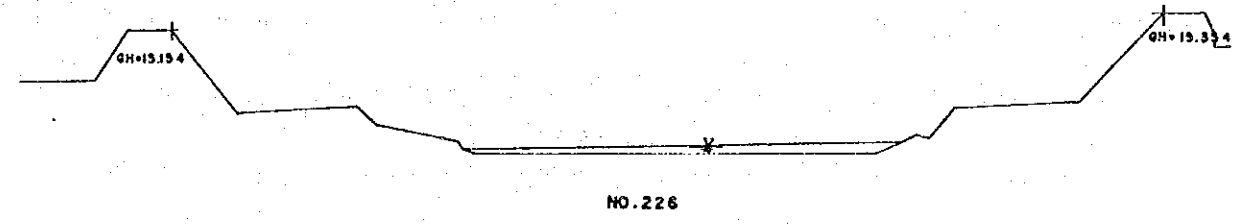
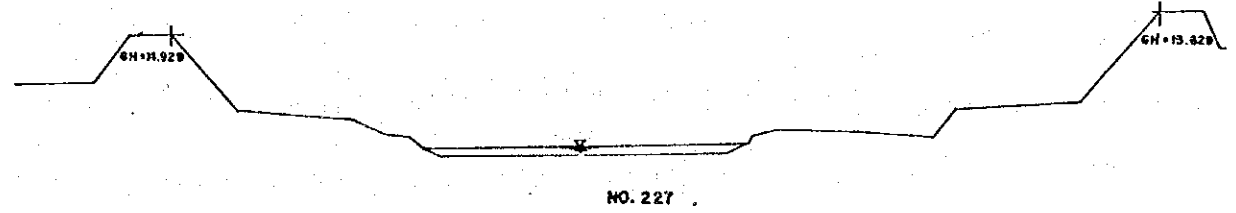
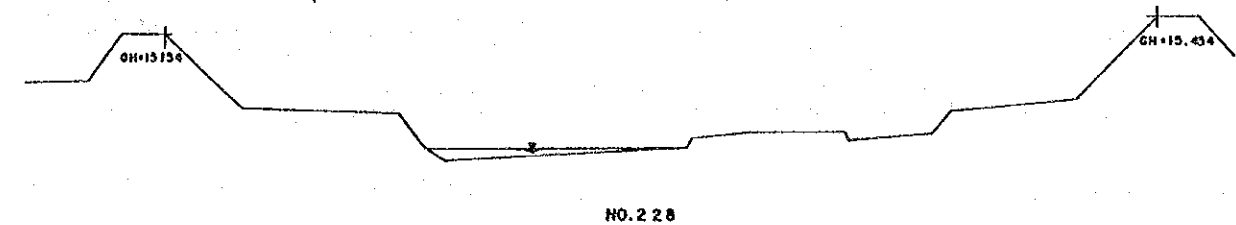

LEGEND	FIG :
	AC 60
	SOURCE : JICA STUDY TEAM
	SCALE : A 8 8 H 0 W R
	DATE OF DRAWING : 1990. 12. 31
The Study on River Environment Improvement for The Tributaries of Han River System in Seoul Municipality and Its Vicinity	

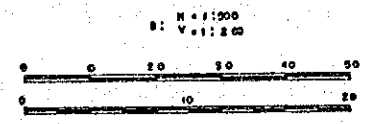
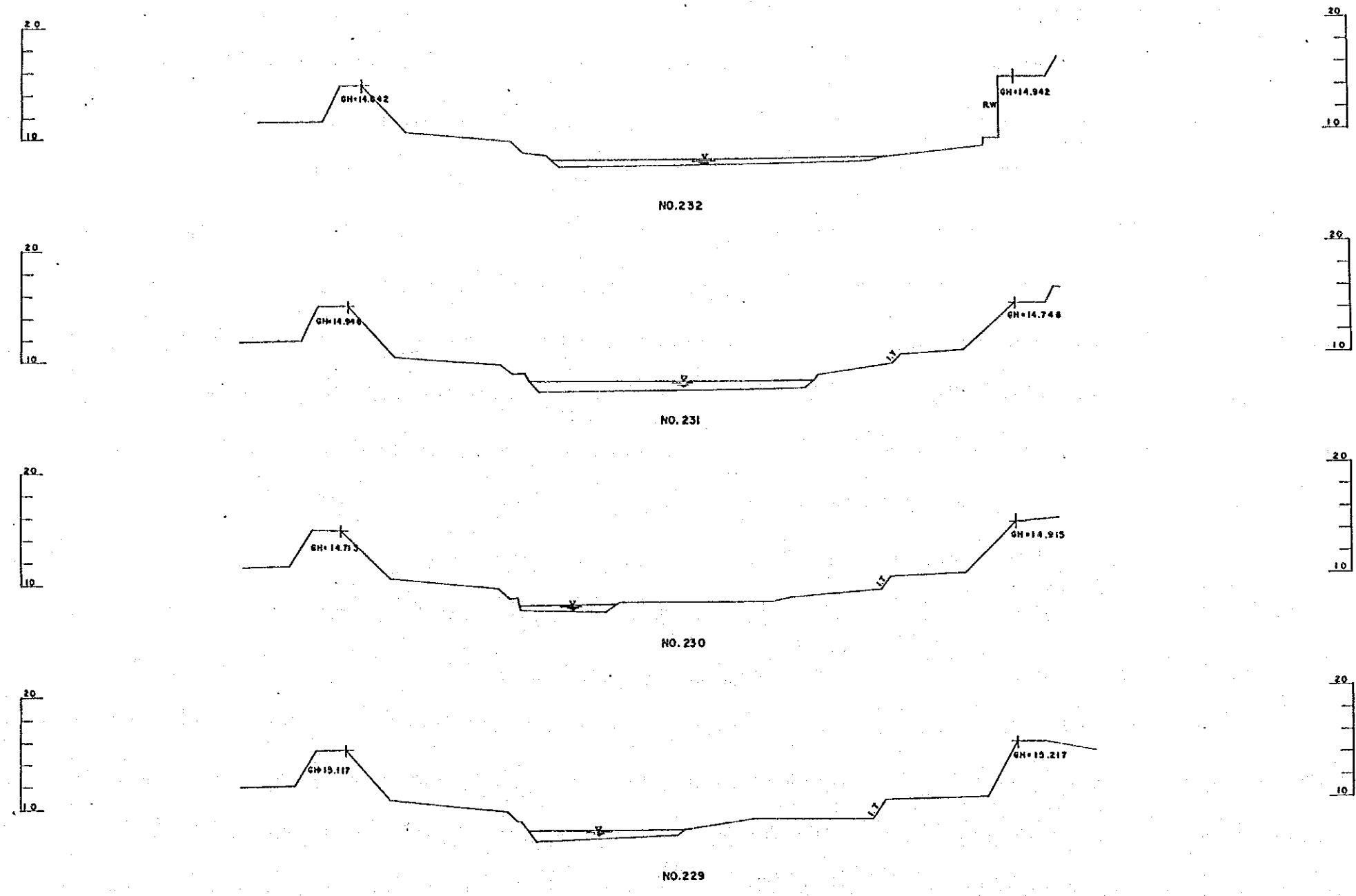

LEGEND	FIG :
	AC 61
SOURCE :	JCA STUDY TEAM
SCALE :	AS SHOWN
DATE OF DRAWING :	1980. 12. 31
The Study on River Environment Improvement for The Tributaries of Han River System in Seoul Municipality and Its Vicinity	

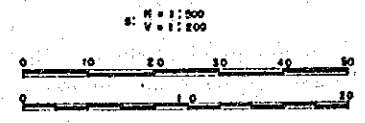
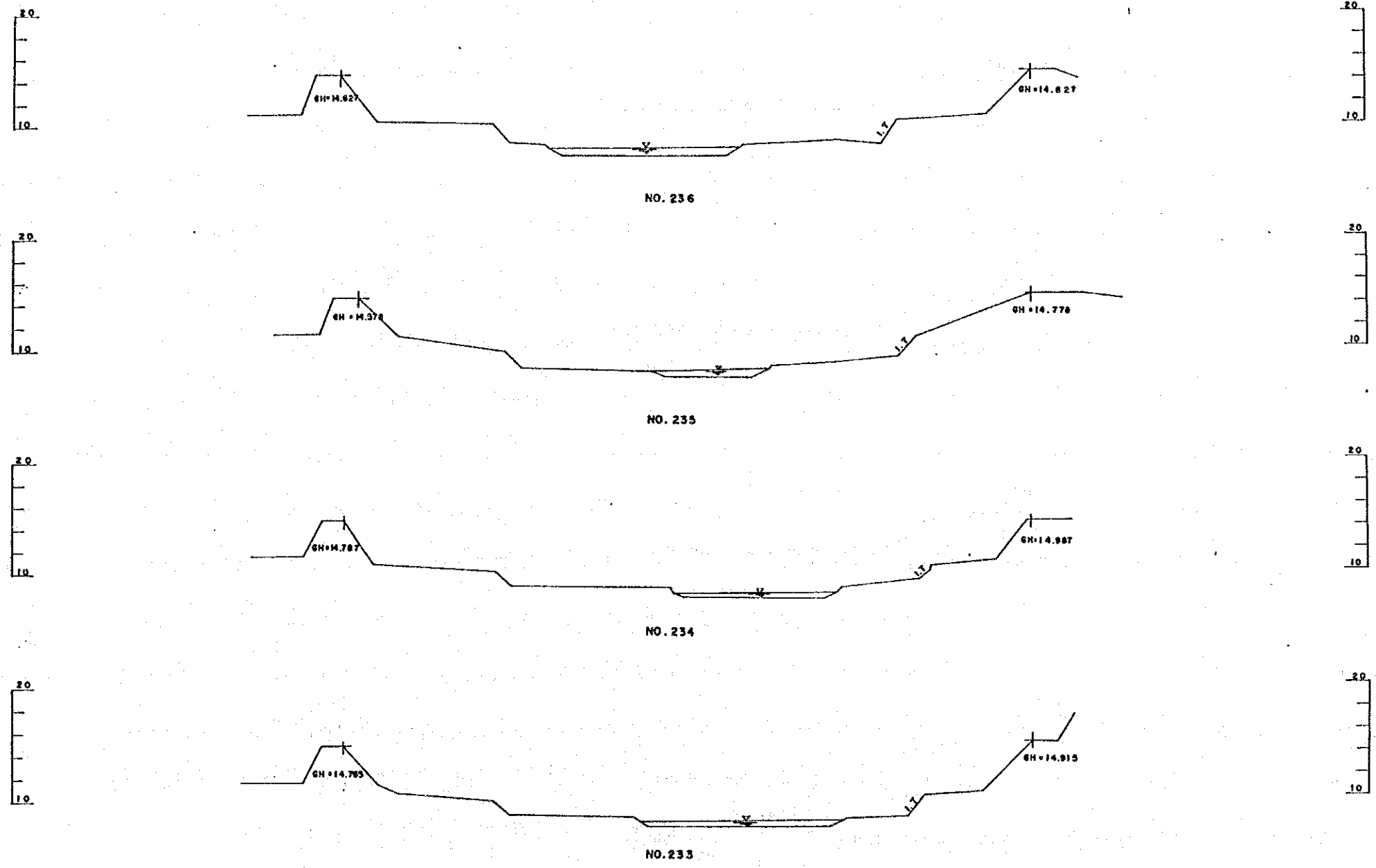

LEGEND	FIG
	AC 62
	SOURCE : JICA STUDY TEAM
	SCALE : AS SHOWN
	DATE OF DRAWING : 1990.12.31
The Study on River Environment Improvement for The Tributaries of Han River System in Seoul Municipality and Its Vicinity	

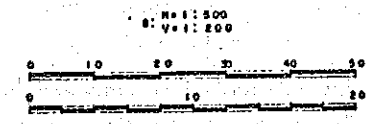
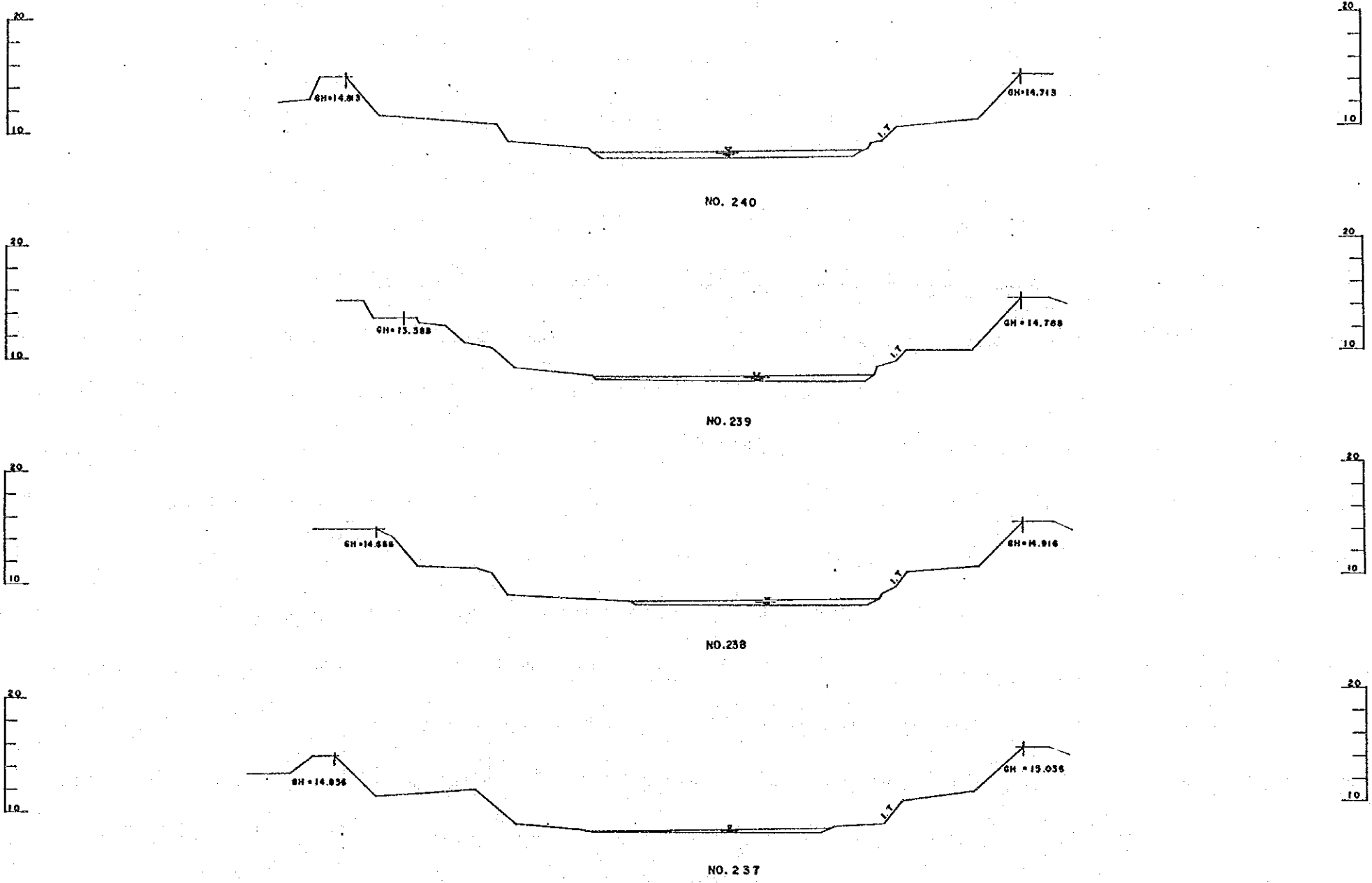

LEGEND	FIG :
	AC 63
	SOURCE : JICA STUDY TEAM
	SCALE : AS SHOWN
	DATE OF DRAWING : 1990.12.31
The Study on River Environment Improvement for The Tributaries of Han River System in Seoul Municipality and Its Vicinity	

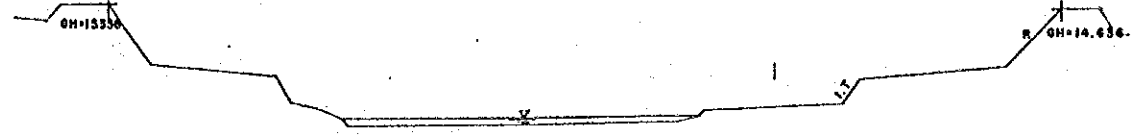

NO. 243

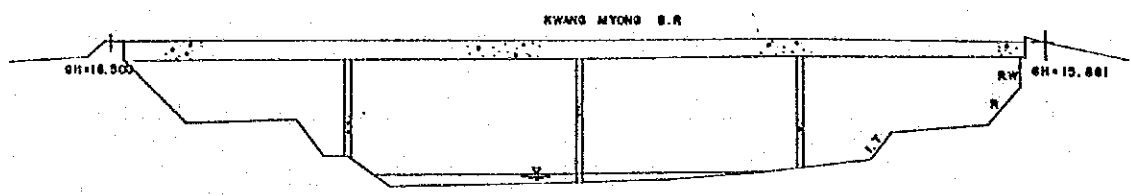

NO. 242+20

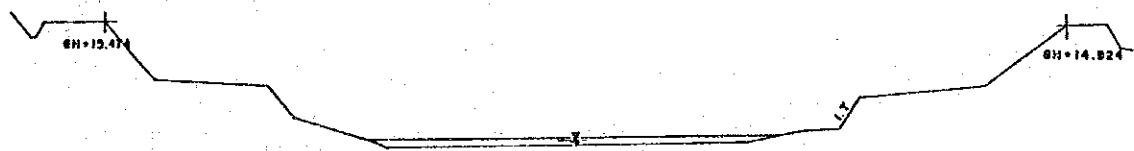
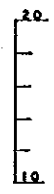

NO. 242

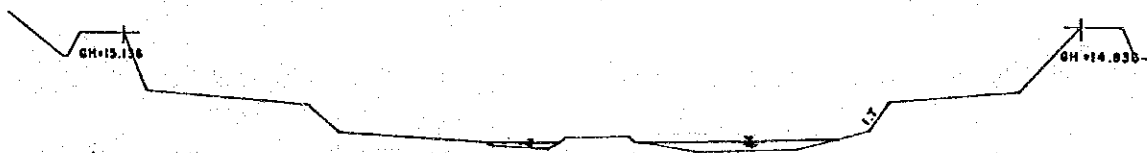
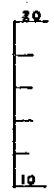

NO. 241

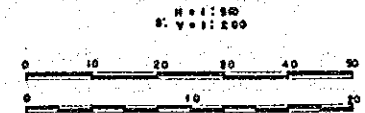

LEGEND	FIG :
	AC 64
	SOURCE : JICA STUDY TEAM
	SCALE : AS SHOWN
	DATE OF DRAWING : 1990.12.31
The Study on River Environment Improvement for The Tributaries of Han River System in Seoul Municipality and Its Vicinity	

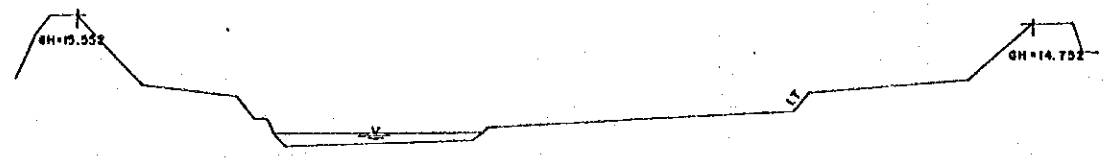

NO. 247

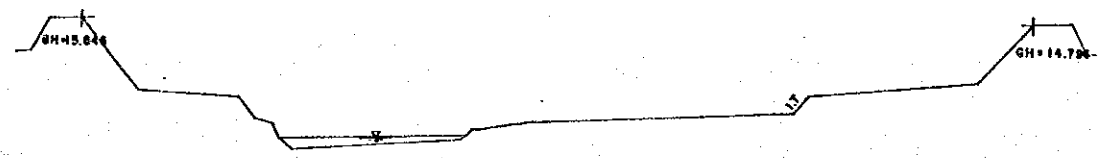

NO. 246

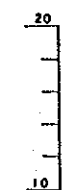

NO. 245

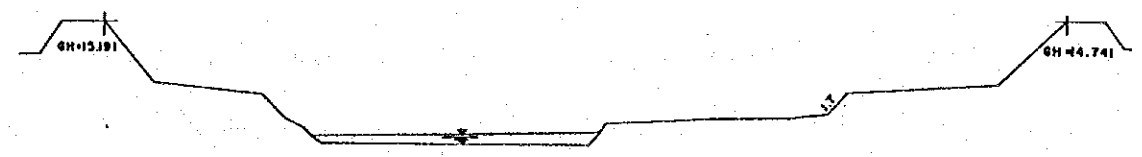

NO. 244

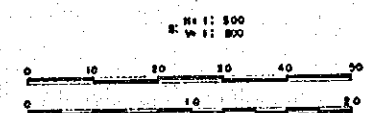
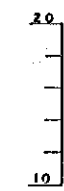

LEGEND	FIG
	AC 65
	SOURCE : JICA STUDY TEAM
	SCALE : AS SHOWN
	DATE OF DRAWING : 1990. 12. 31
The Study on River Environment Improvement for The Tributaries of Han River System in Seoul Municipality and Its Vicinity	

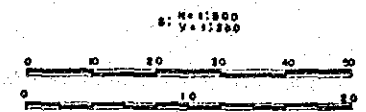
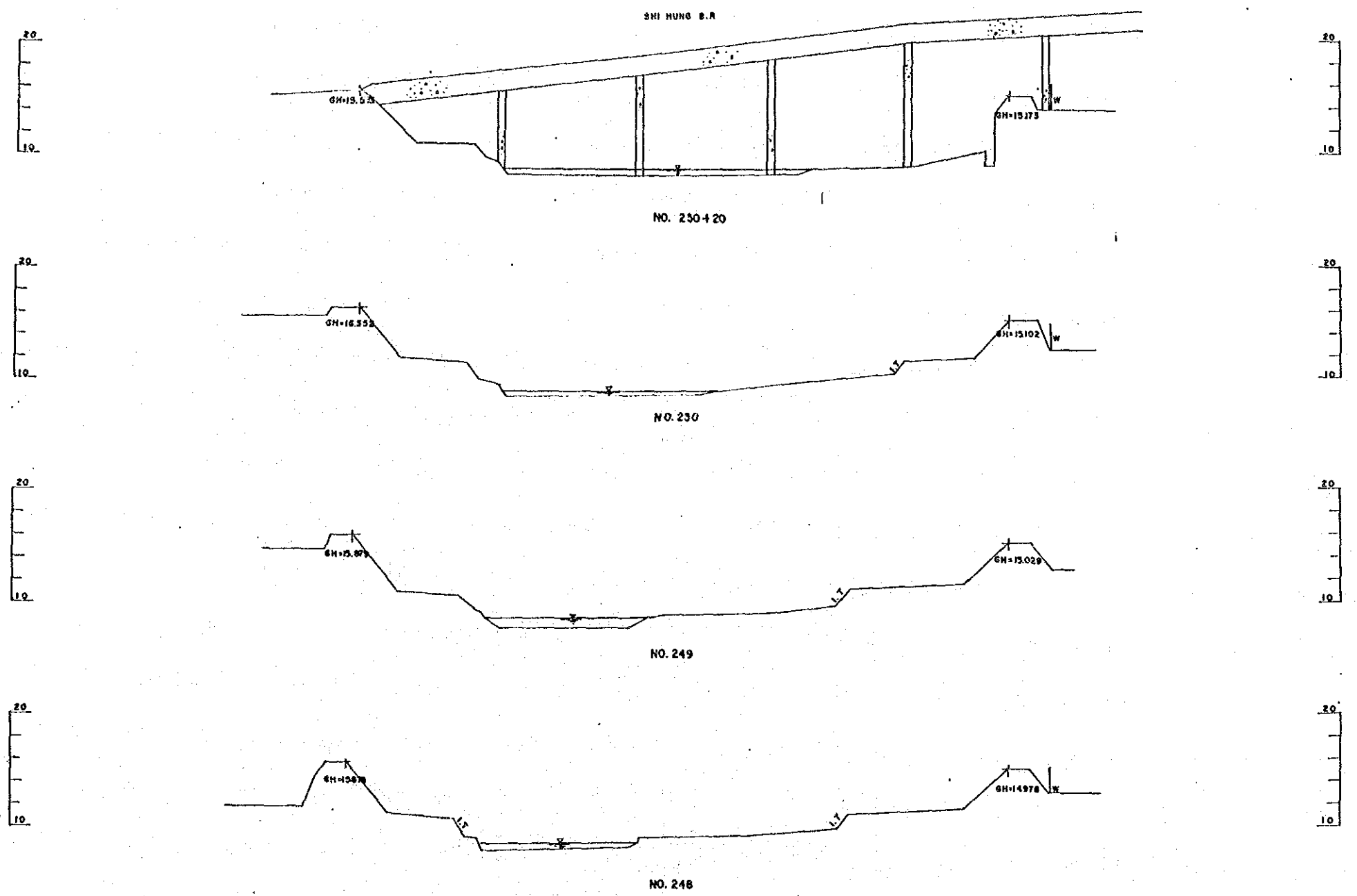

LEGEND	FIG.
	AC 66
	SOURCE : JICA STUDY TEAM
	SCALE : AS SHOWN
	DATE OF DRAWING : 1990. 12. 31
The Study on River Environment Improvement for The Tributaries of Han River System in Seoul Municipality and Its Vicinity	

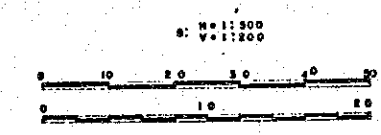
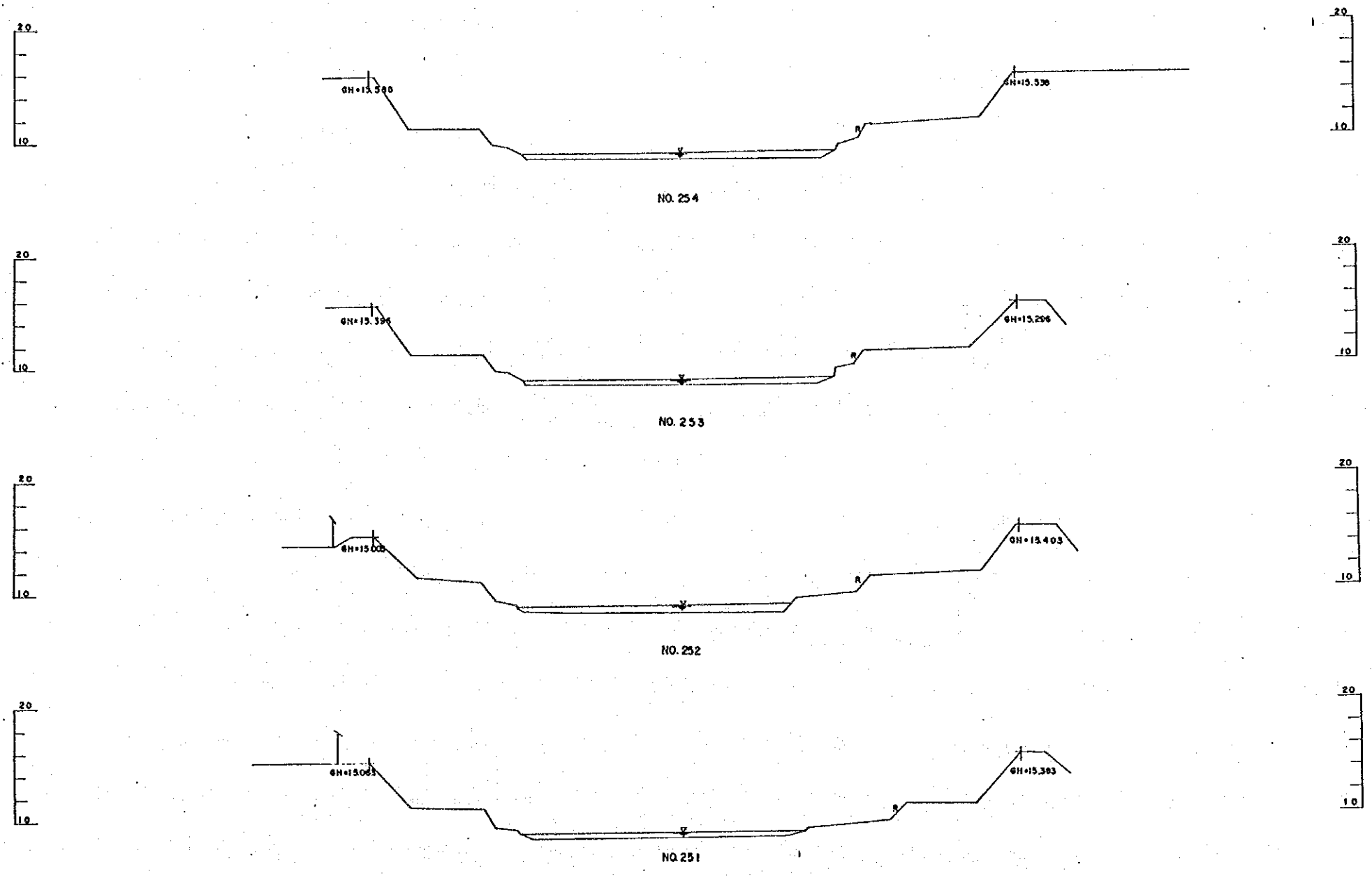

LEGEND	FIG
	AC 67
	SOURCE : JICA STUDY TEAM
	SCALE : AS SHOWN
	DATE OF DRAWING : 1990. 12. 31
The Study on River Environment Improvement for The Tributaries of Han River System in Seoul Municipality and Its Vicinity	

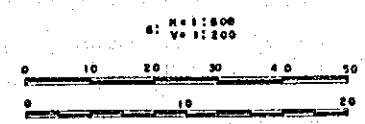
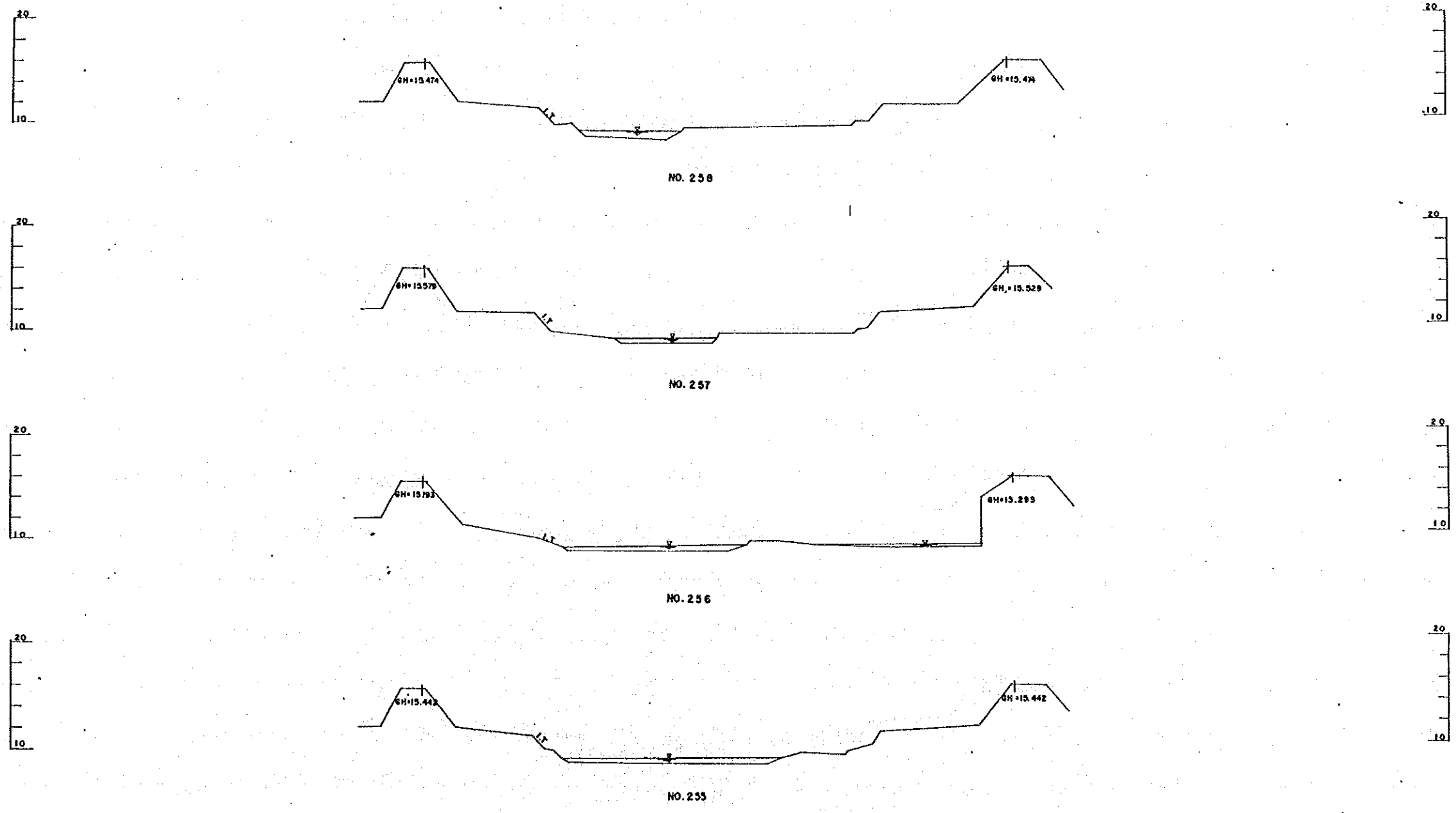

LEGEND	FIG :
	AC 68
	SOURCE : JICA STUDY TEAM
	SCALE : AS SHOWN
	DATE OF DRAWING : 1990. 12. 31
The Study on River Environment Improvement for The Tributaries of Han River System in Seoul Municipality and Its Vicinity	

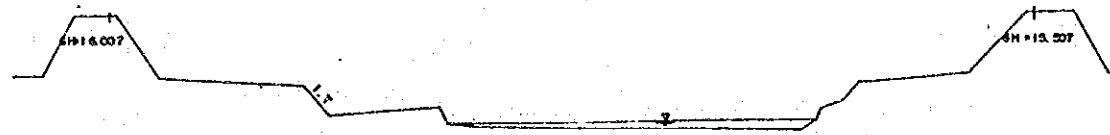

NO.262

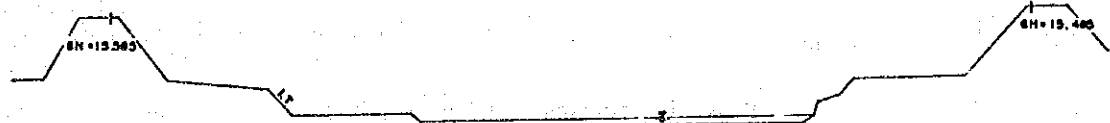

NO.261

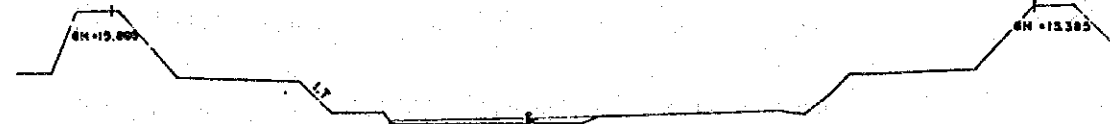

NO.260



NO.259

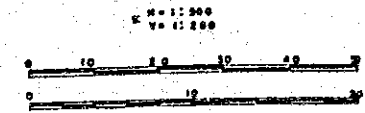

LEGEND	FIG
	AC 69
	SOURCE : JICA STUDY TEAM
	SCALE : AS SHOWN
	DATE OF DRAWING : 1988.12.31
The Study on River Environment Improvement for The Tributaries of Han River System in Seoul Municipality and Its Vicinity	

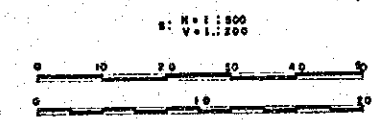
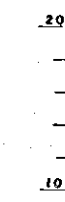
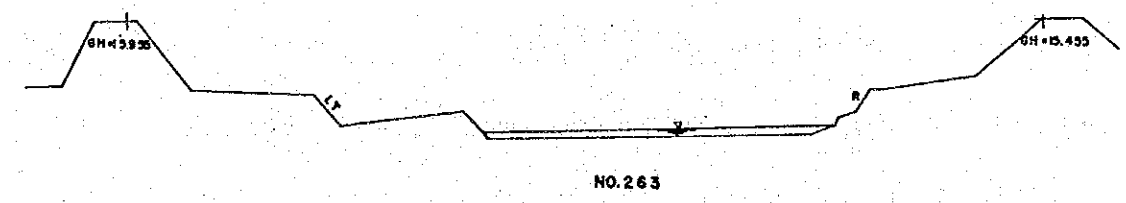
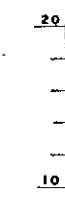
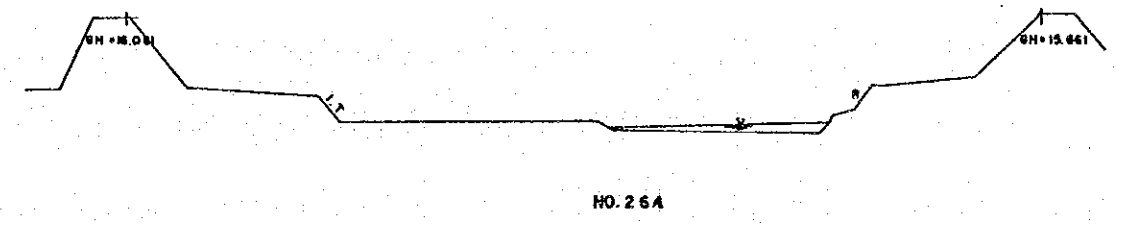
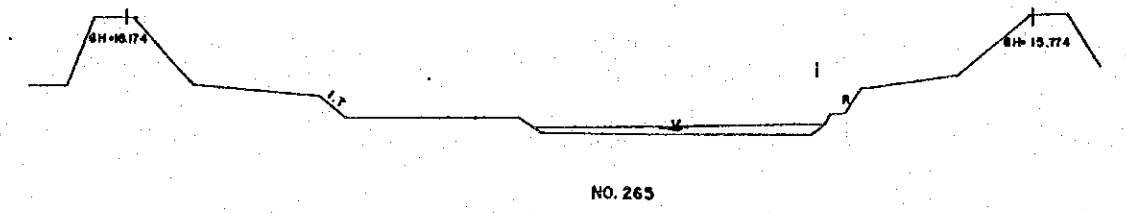
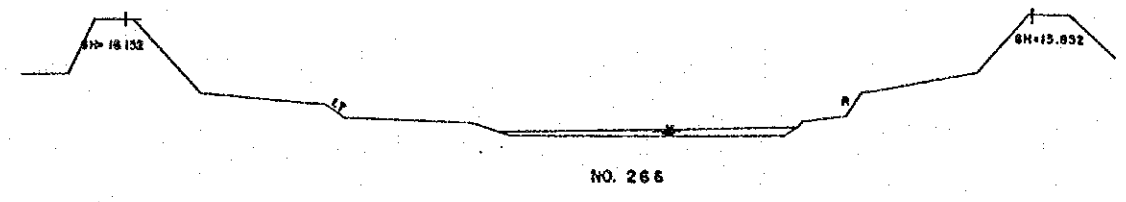

LEGEND	FIG
	AC 70
	SOURCE : JICA STUDY TEAM
	SCALE : AS SHOWN
	DATE OF DRAWING : 1990.12.31
The Study on River Environment Improvement for The Tributaries of Han River System in Seoul Municipality and Its Vicinity	



NO. 270

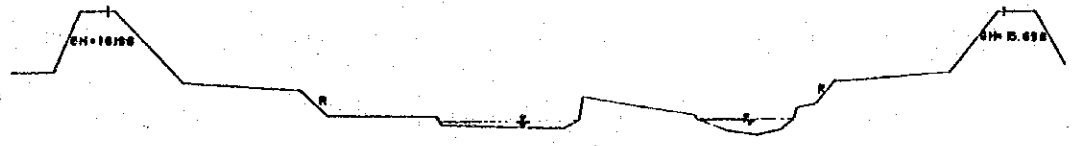
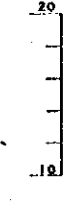

NO. 269

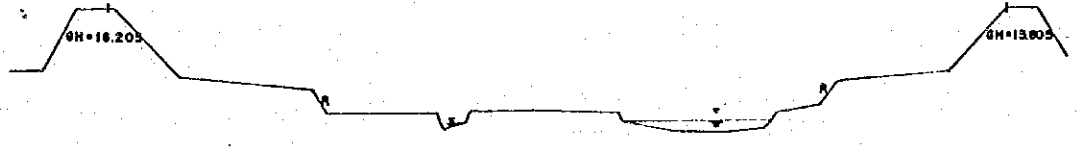
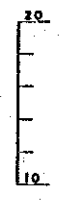

NO. 268

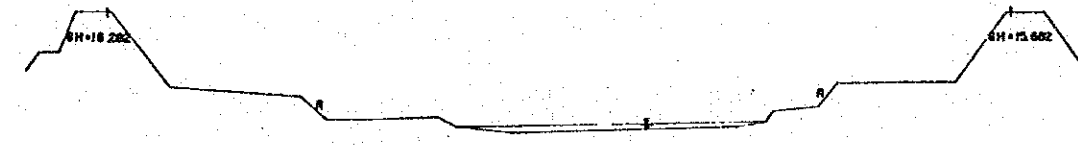
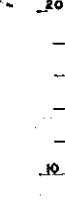

NO. 267

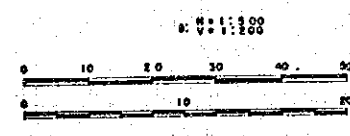
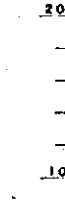

LEGEND	FIG
	AC 71
	SOURCE : JICA STUDY TEAM
	SCALE : AS SHOWN
	DATE OF DRAWING : 1990.12.31
The Study on River Environment Improvement for The Tributaries of Han River System in Seoul Municipality and Its Vicinity	

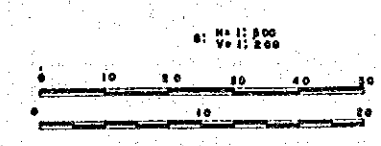
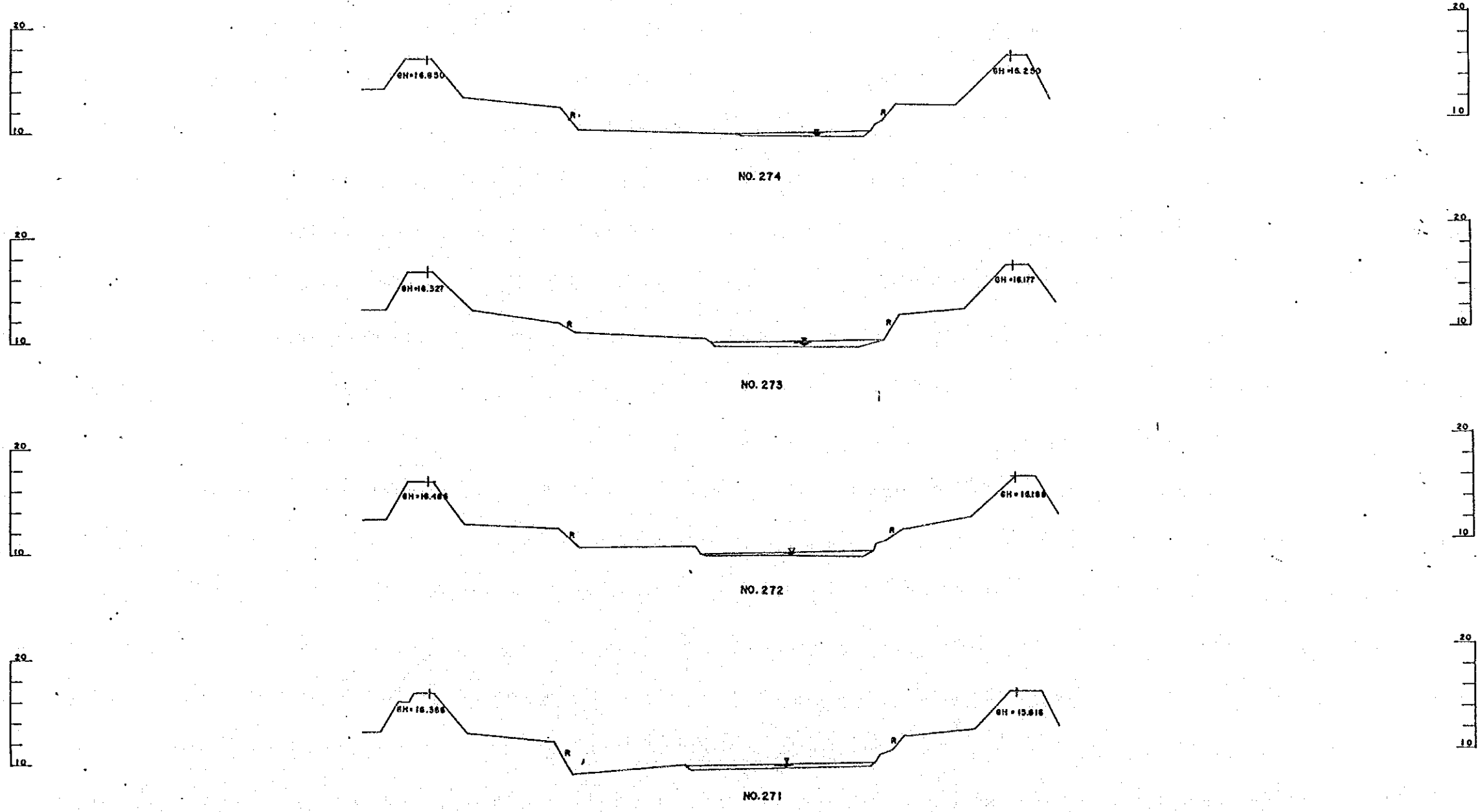

LEGEND	FIG
	AC 72
	SOURCE : JICA STUDY TEAM
	SCALE : AS SHOWN
	DATE OF DRAWING : 1990. 12. 31
The Study on River Environment Improvement for The Tributaries of Han River System in Seoul Municipality and Its Vicinity	

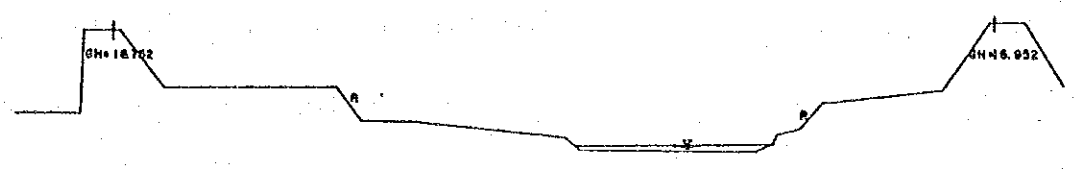

NO. 278

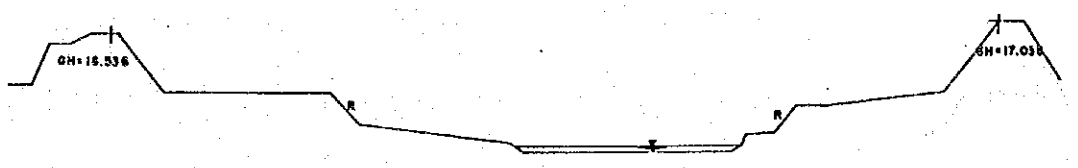

NO. 277

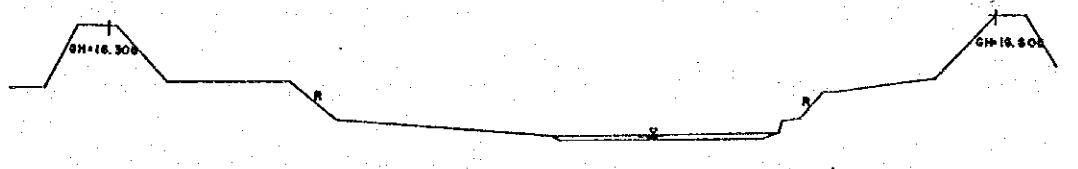

NO. 276

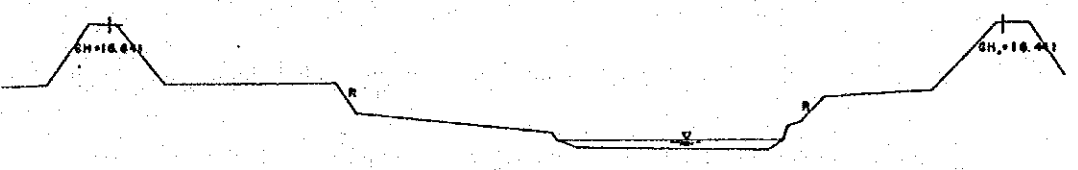
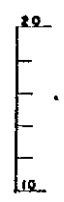

NO. 275

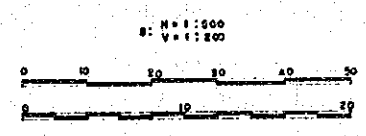

LEGEND	FIG :
	AC 73
	SOURCE : JICA STUDY TEAM
	SCALE : AS SHOWN
	DATE OF DRAWING : 1990. 12. 31
The Study on River Environment Improvement for The Tributaries of Han River System in Seoul Municipality and Its Vicinity	

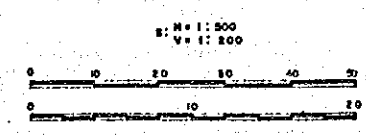
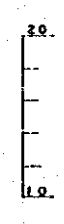
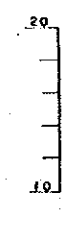
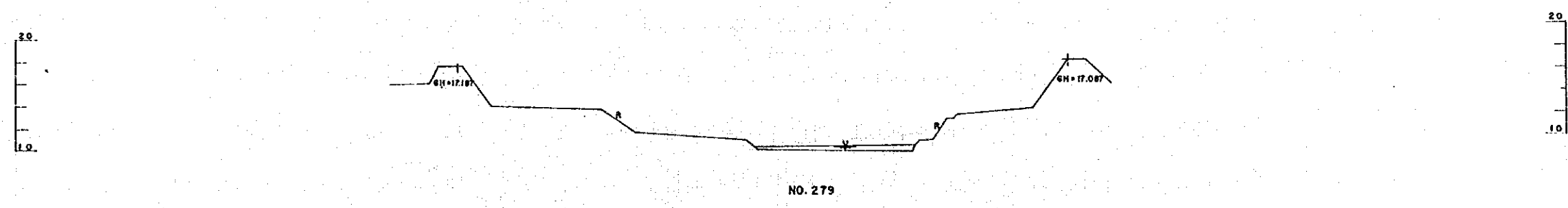
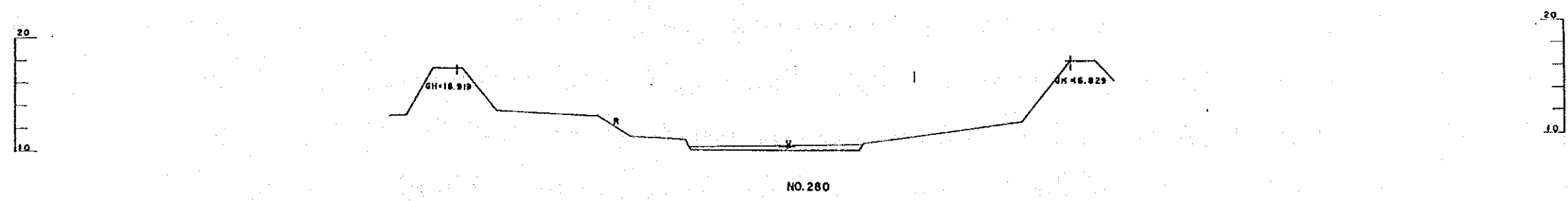
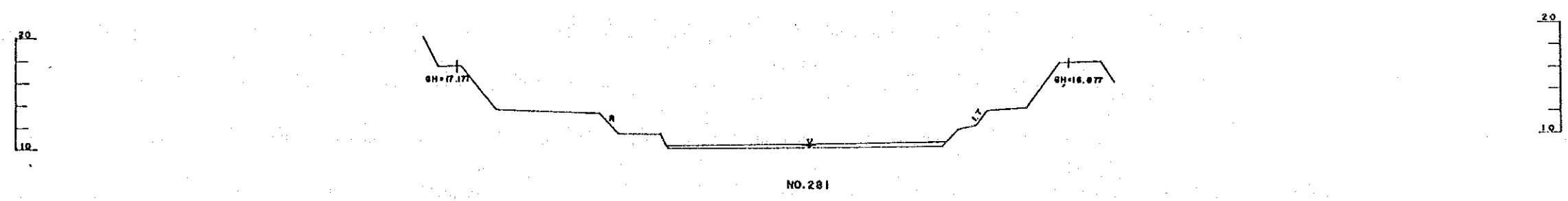
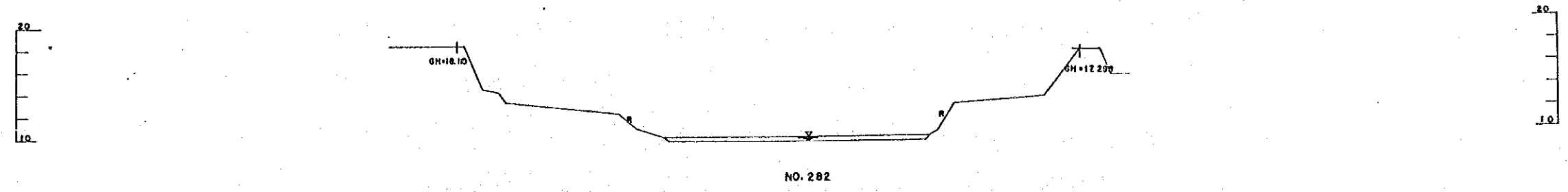

LEGEND	
	NO.
	AC 74
	JICA STUDY TEAM
	AS SHOWN
	DATE 1990.12.11
The Study on River Environment Improvement for The Tributaries of Han River System in Seoul Municipality and Its Vicinity	

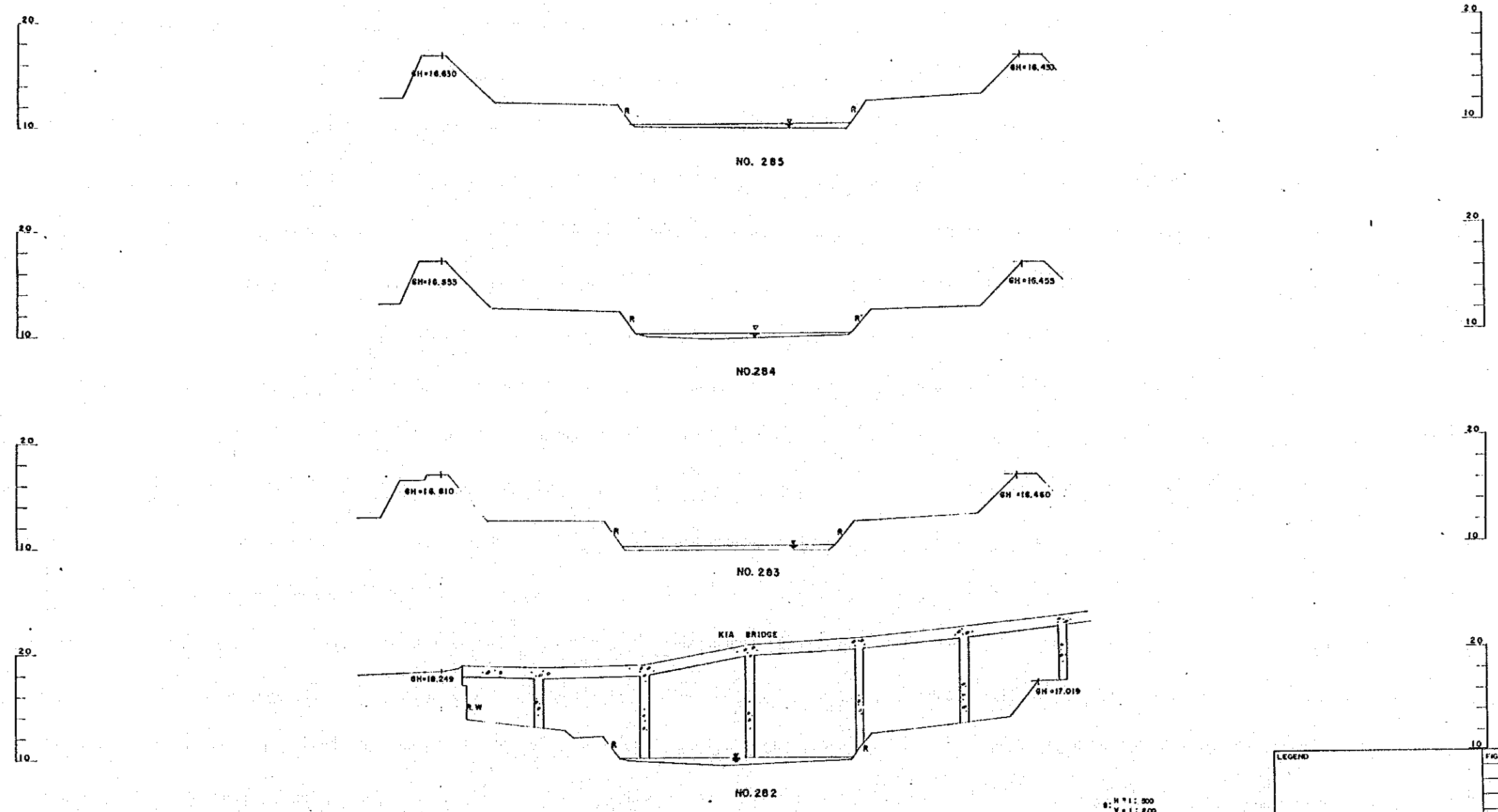

NO. 285

NO. 284

NO. 283

NO. 282

KIA BRIDGE

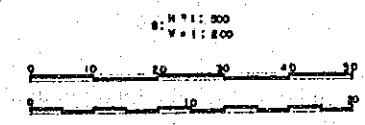

LEGEND	FIG
	AC 75
	SOURCE : JICA STUDY TEAM
	SCALE : AS SHOWN
	DATE OF DRAWING : 1990. 12. 31
The Study on River Environment Improvement for The Tributaries of Han River System in Seoul Municipality and Its Vicinity	

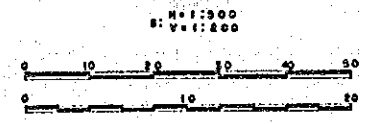
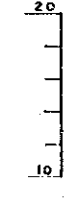
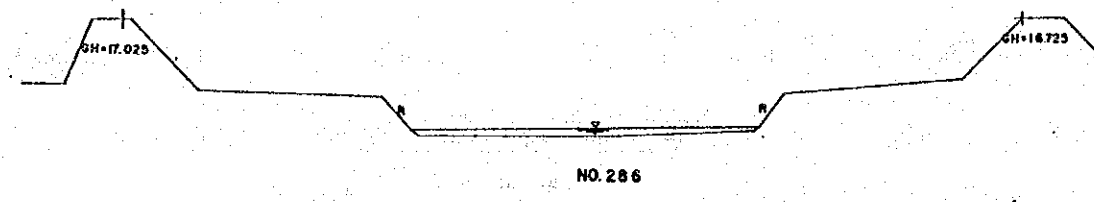
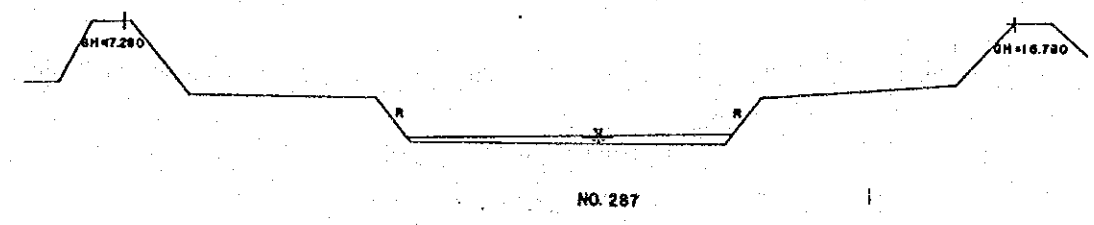
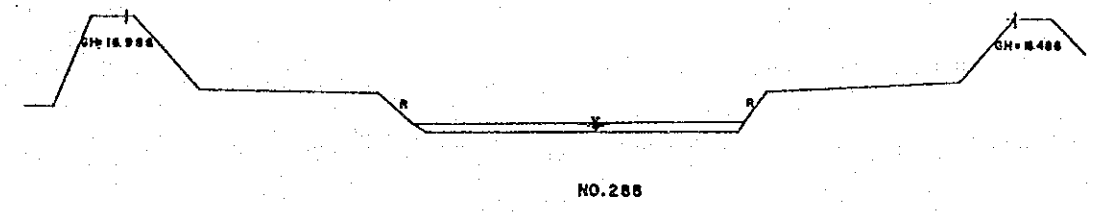
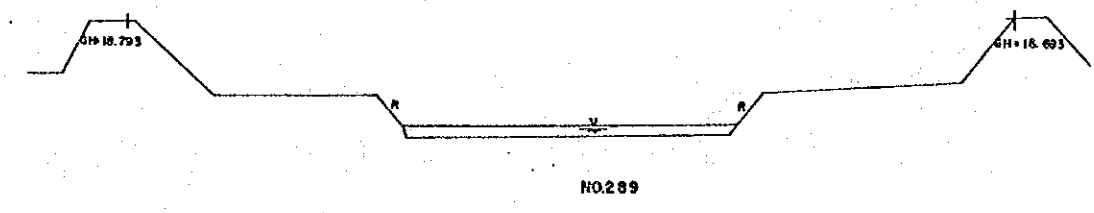

LEGEND	FIG
	AC 76
	SOURCE : JICA STUDY TEAM
	SCALE : AS SHOWN
	DATE OF DRAWING : 1990. 12. 31
The Study on River Environment Improvement for The Tributaries of Han River System in Seoul Municipality and Its Vicinity	

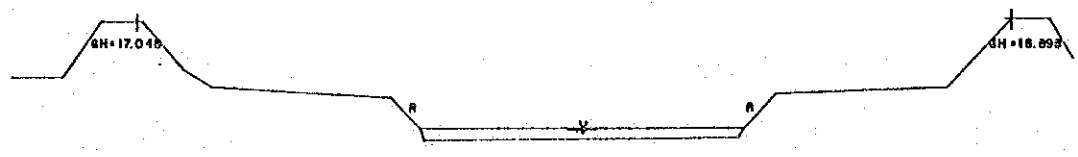

NO. 293

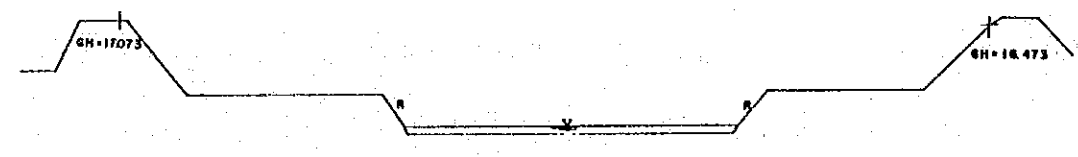
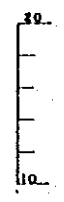

NO. 292

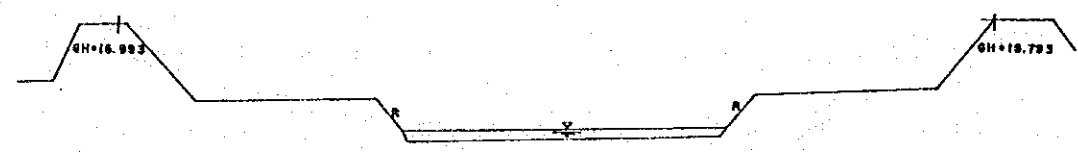

NO. 291

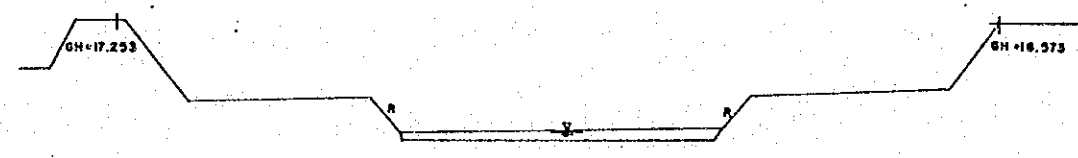

NO. 290

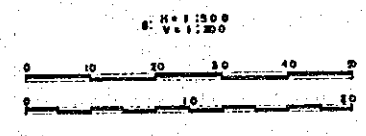

LEGEND	FIG
	AC 77
	SOURCE : JICA STUDY TEAM
	SCALE : AS SHOWN
	DATE OF DRAWING : 1990. 12. 31
The Study on River Environment Improvement for The Tributaries of Han River System in Seoul Municipality and Its Vicinity	

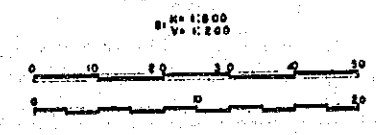
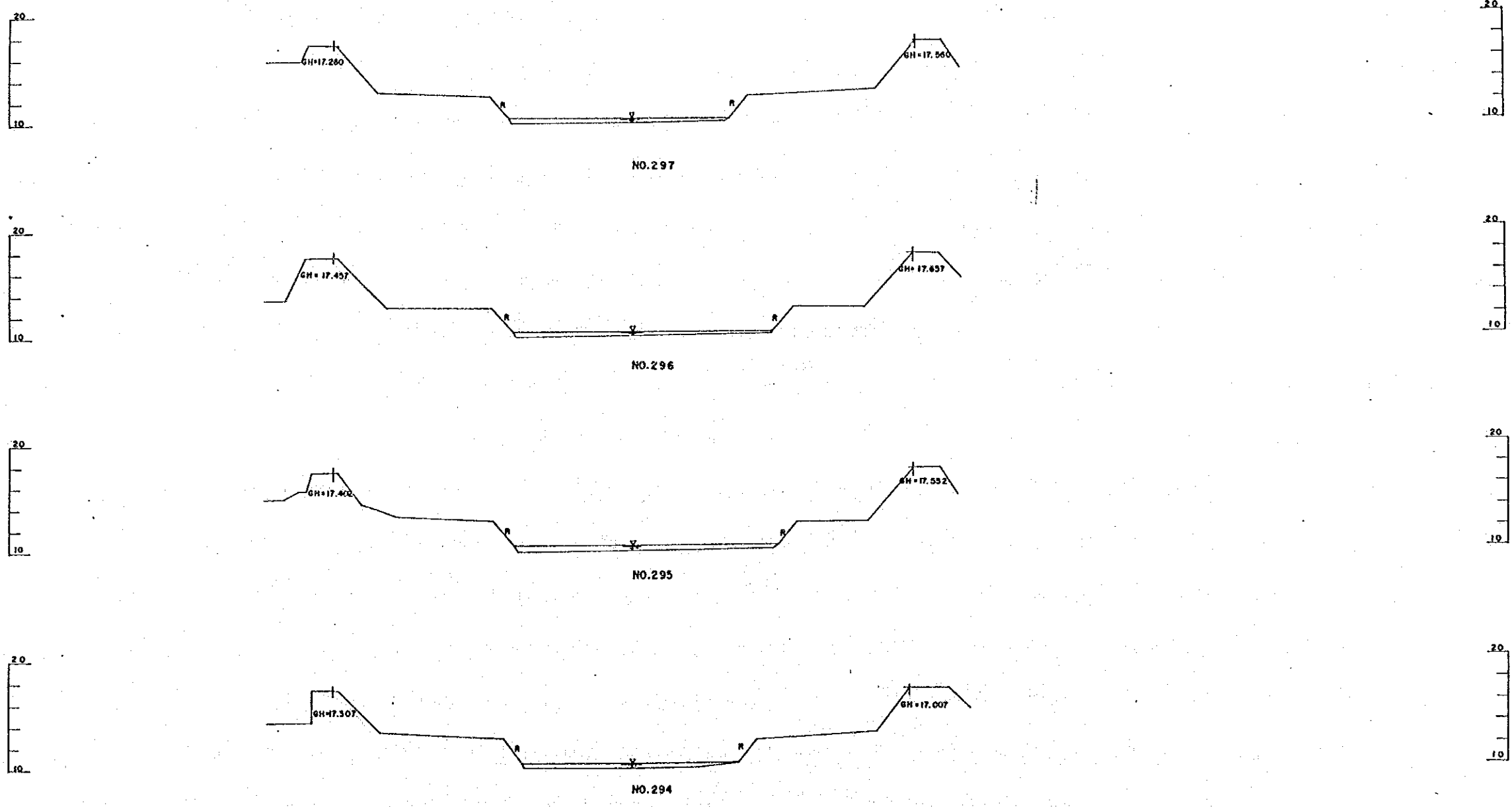

LEGEND	FIG :
	AC 78
	SOURCE : JICA STUDY TEAM
	SCALE : AS SHOWN
	DATE OF DRAWING : 1990. 12. 31
The Study on River Environment Improvement for The Tributaries of Han River System in Seoul Municipality and Its Vicinity	

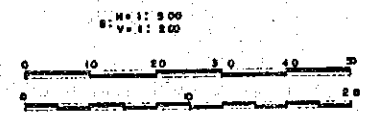
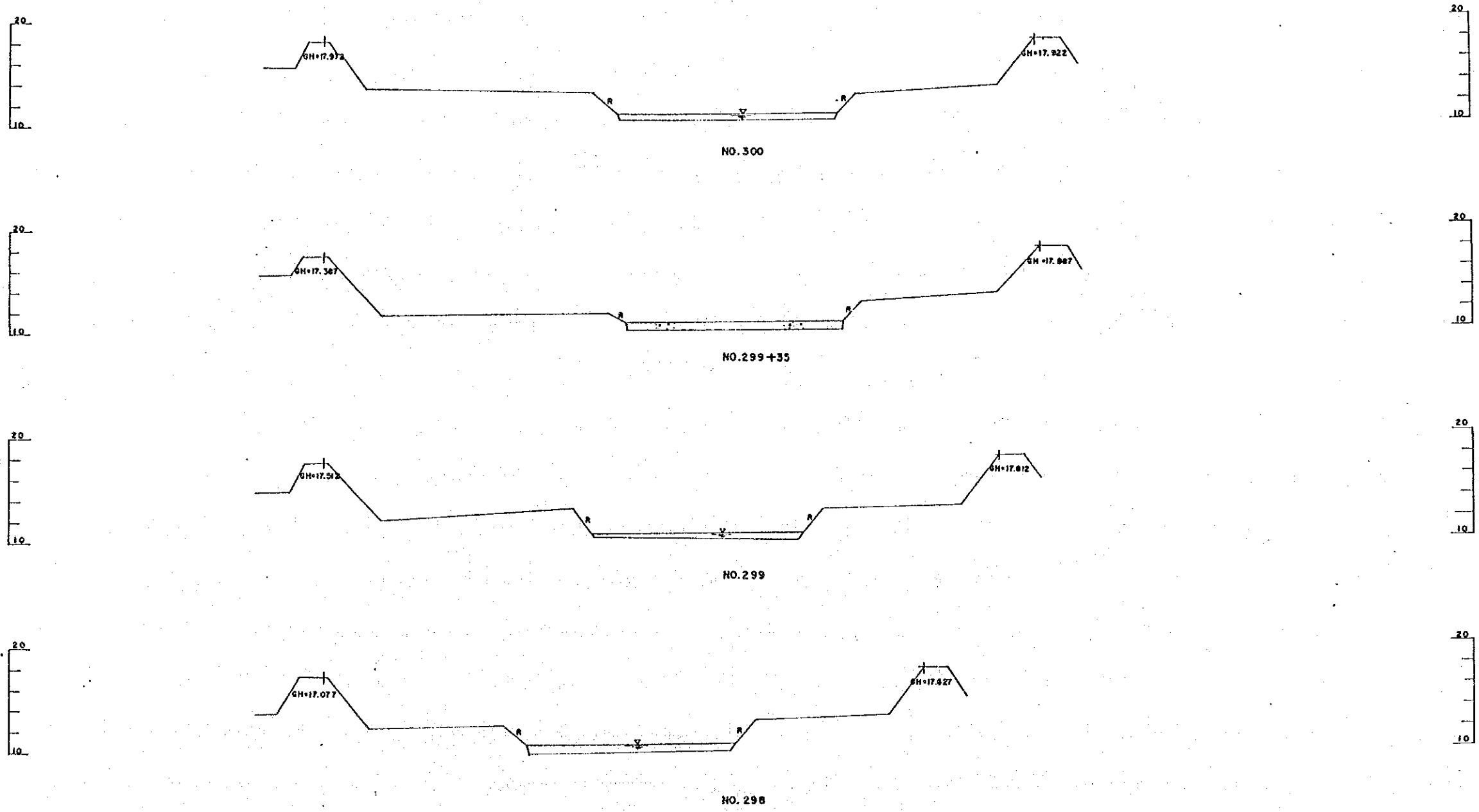

LEO/NO	FIG
	AC 79
SOURCE	JICA STUDY TEAM
SCALE	AS SHOWN
DATE OF DRAWING	1990. 12. 31
The Study on River Environment Improvement for The Tributaries of Han River System in Seoul Municipality and Its Vicinity	

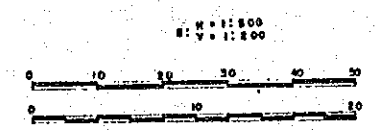
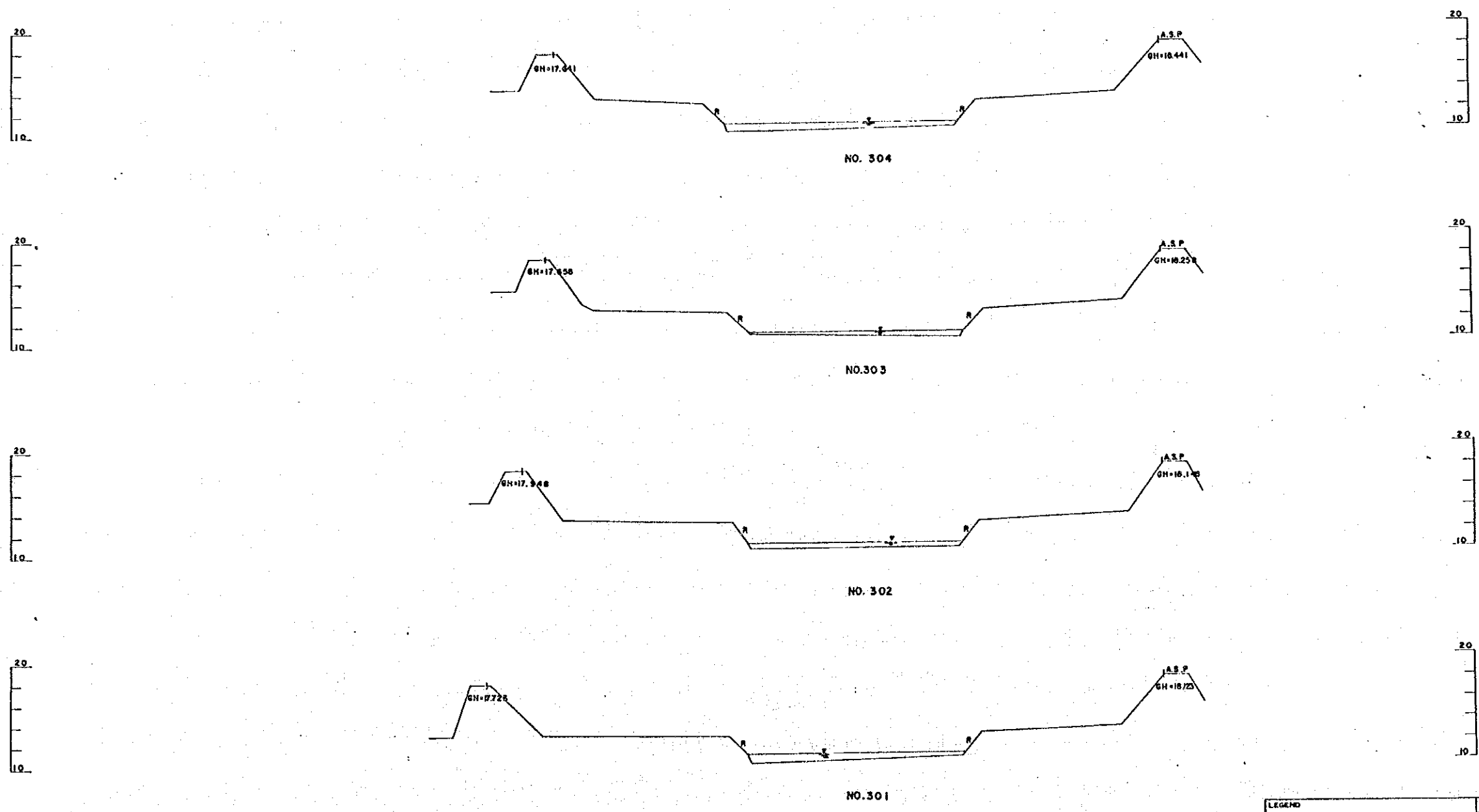

LEGEND	FIG :
	AC 80
	SOURCE : JICA STUDY TEAM
	SCALE : AS SHOWN
DATE OF DRAWING : 1990. 1. 21	
The Study on River Environment Improvement for The Tributaries of Han River System in Seoul Municipality and Its Vicinity	

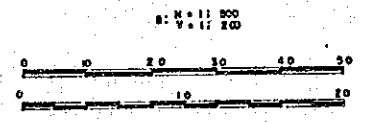
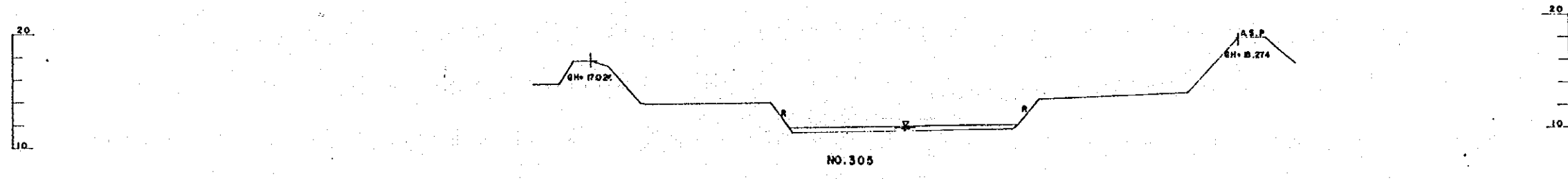
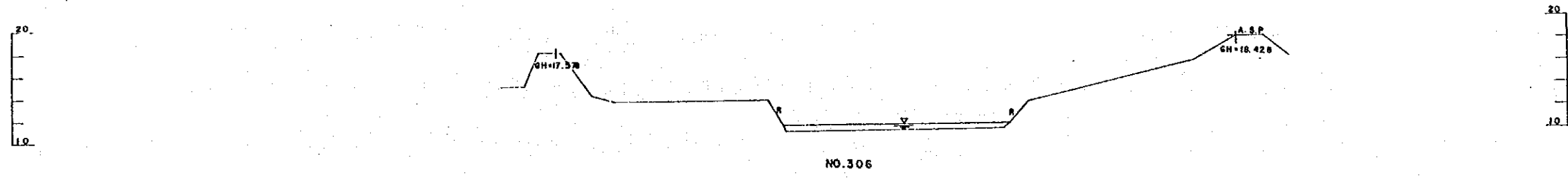
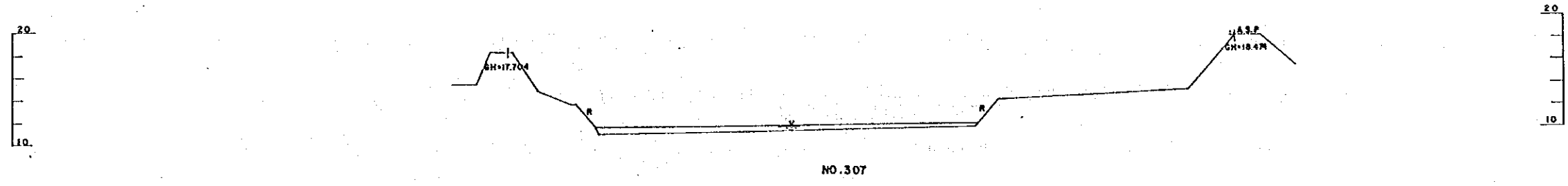
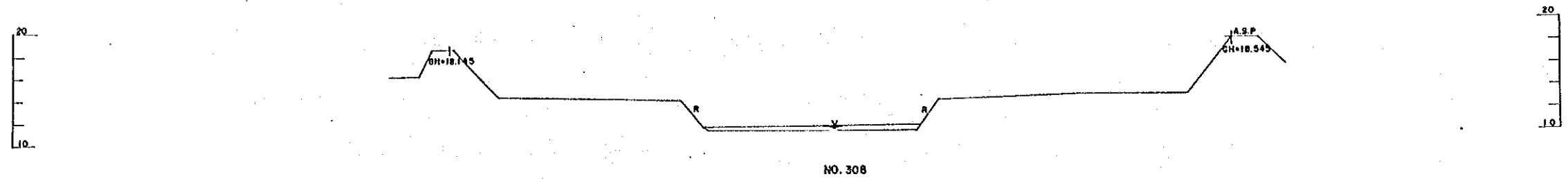

LEGEND	FIG :
	AC 81
	SOURCE : JICA STUDY TEAM
	SCALE : AS SHOWN
	DATE OF ESTIMATION : 1990. 12. 31
The Study on River Environment Improvement for The Tributaries of Han River System in Seoul Municipality and Its Vicinity	

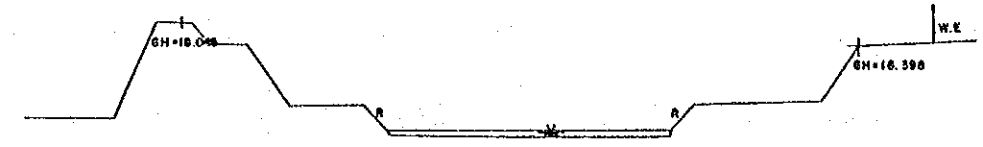

NO. 311

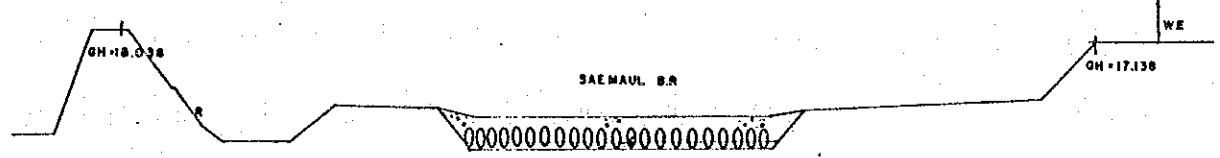

NO. 310 + 26

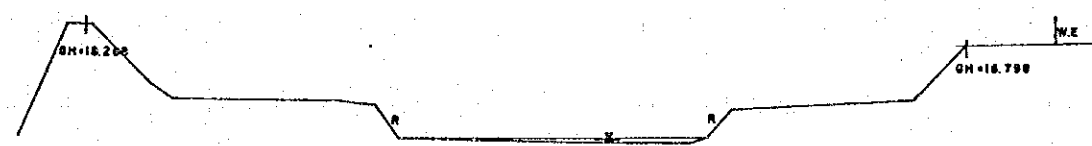

NO. 310

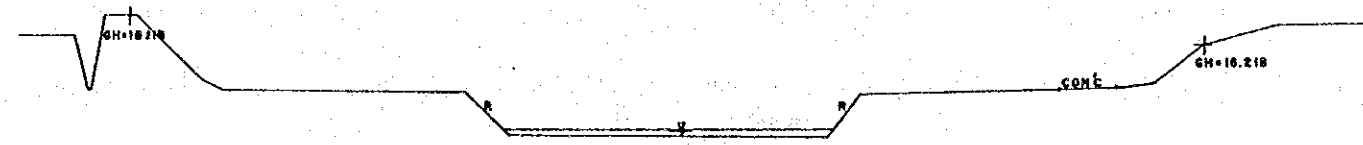

NO. 309

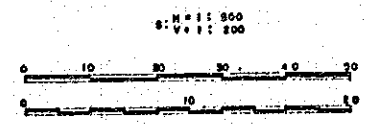

LEGEND	FIG
	AC 82
SOURCE	JICA STUDY TEAM
SCALE	AS SHOWN
DATE OF DRAWING	1990. 12. 31

The Study on River Environment Improvement for the Tributaries of Han River System in Seoul Municipality and Its Vicinity

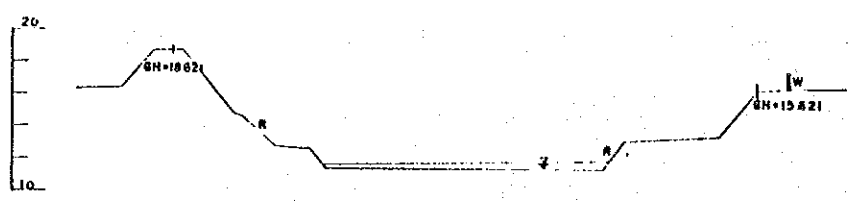

NO. 315

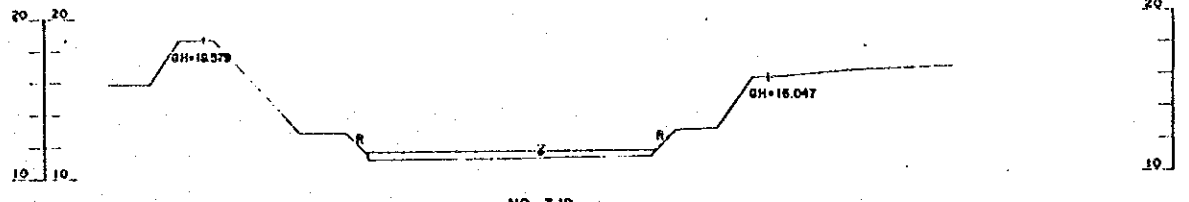

NO. 319

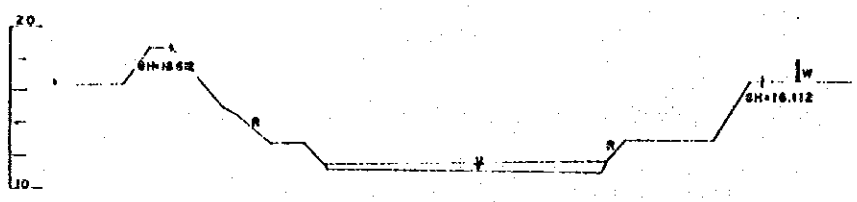

NO. 314

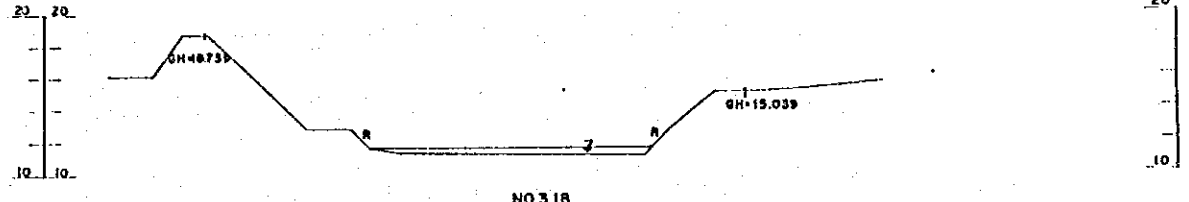

NO. 318

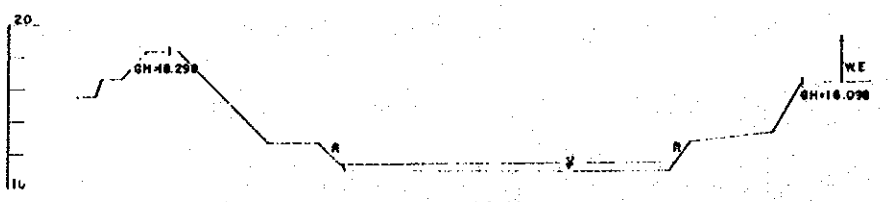

NO. 313

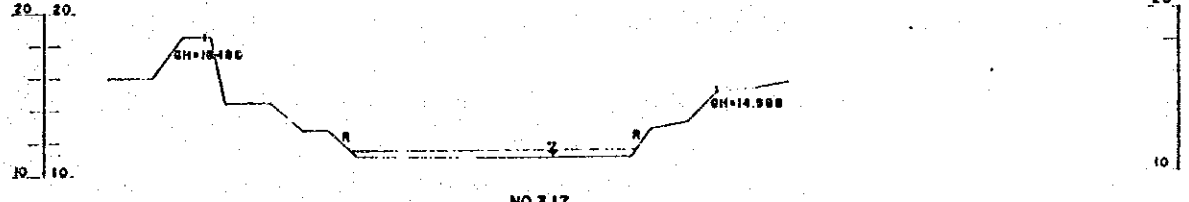

NO. 317

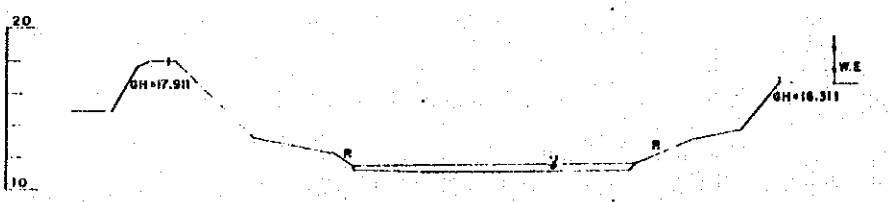

NO. 312

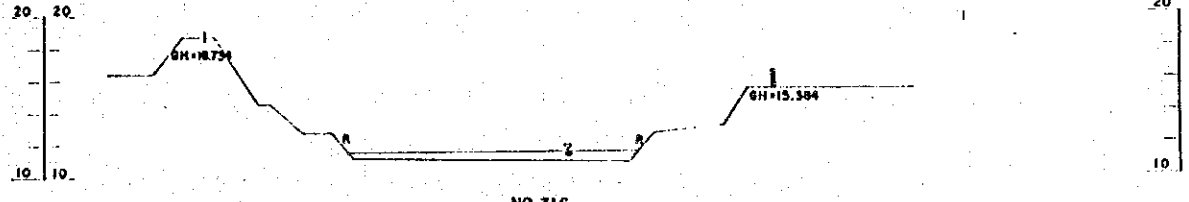

NO. 316

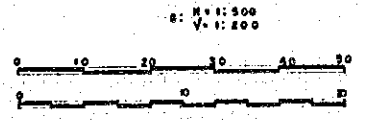

LEGEND	FIG :
	AC 83
	SOURCE : JICA STUDY TEAM
	SCALE : AS SHOWN
	DATE OF DRAWING : 1990. 12. 31

The Study on River Environment Improvement for The Tributaries of Han River System in Seoul Municipality and Its Vicinity

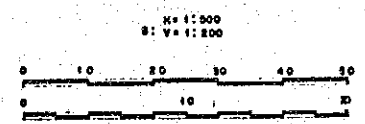
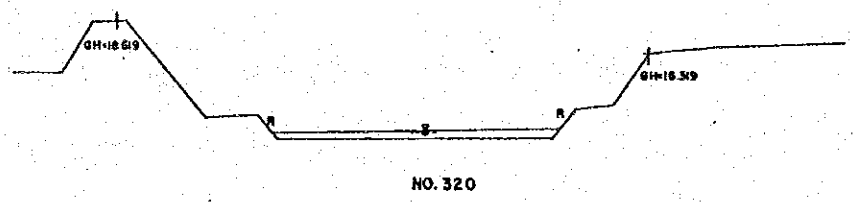

LEGEND	FIG
	AC 84
	SOURCE : JICA STUDY TEAM
	SCALE : AS SHOWN
	DATE OF DRAWING : 1990.12.31
The Study on River Environment Improvement for The Tributaries of Han River System in Seoul Municipality and Its Vicinity	

YANGJAE CHONG

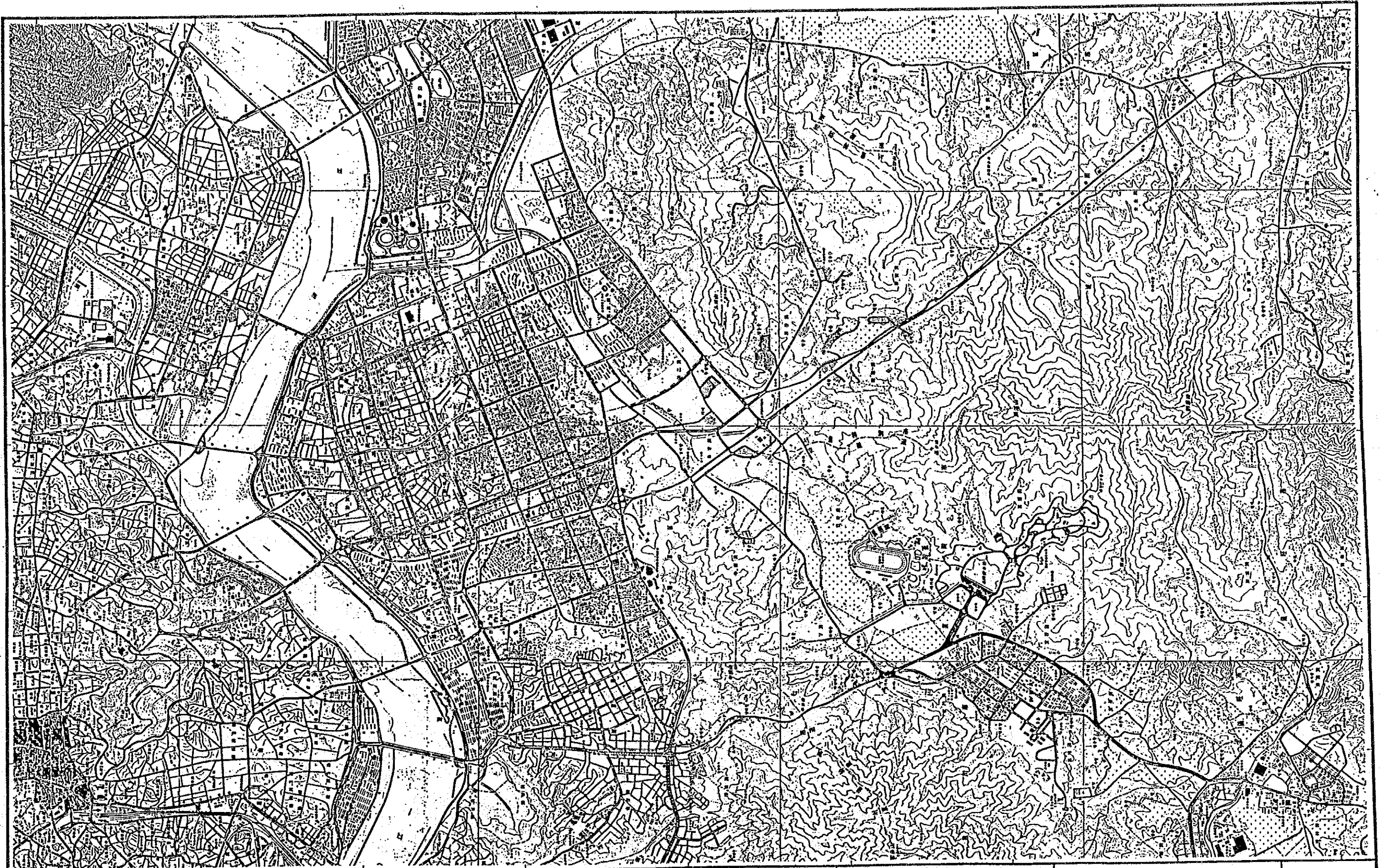

특기사항 	시행청 : 승인 _____ 서울특별시	설계자  한국종합기술개발공사 KOREA ENGINEERING CONSULTANTS CORP	사업명 漢江水系中小河川 環境整備計劃調査	도면내용 일반도 1:25,000	도면번호 V8-1 일자 1980. 12. 31
--------------	--------------------------------	--	-----------------------------	-------------------------	---------------------------------