

付録2

図面集

図面リスト

- A2.1 位置図
- A2.2 導水管平面図
- A2.3 導水管縦断図
- A2.4 取水施設図
- A2.5 既設パイ浄水場一般平面図
- A2.6 パイ浄水場拡張一般平面図
- A2.7 浄水処理系統図及び水位高低図
- A2.8 着水井
- A2.9 急速混和池
- A2.10 フロック形成・薬品沈澱池(1)
- A2.11 フロック形成・薬品沈澱池(2)
- A2.12 フロック形成・薬品沈澱池(3)
- A2.13 急速濾過池(1)
- A2.14 急速濾過池(2)
- A2.15 急速濾過池(3)
- A2.16 洗浄排水池及び沈澱排水池
- A2.17 薬注棟
- A2.18 管理棟
- A2.19 塩素注入棟
- A2.20 工作棟
- A2.21 計装フローシート
- A2.22 単線結線図

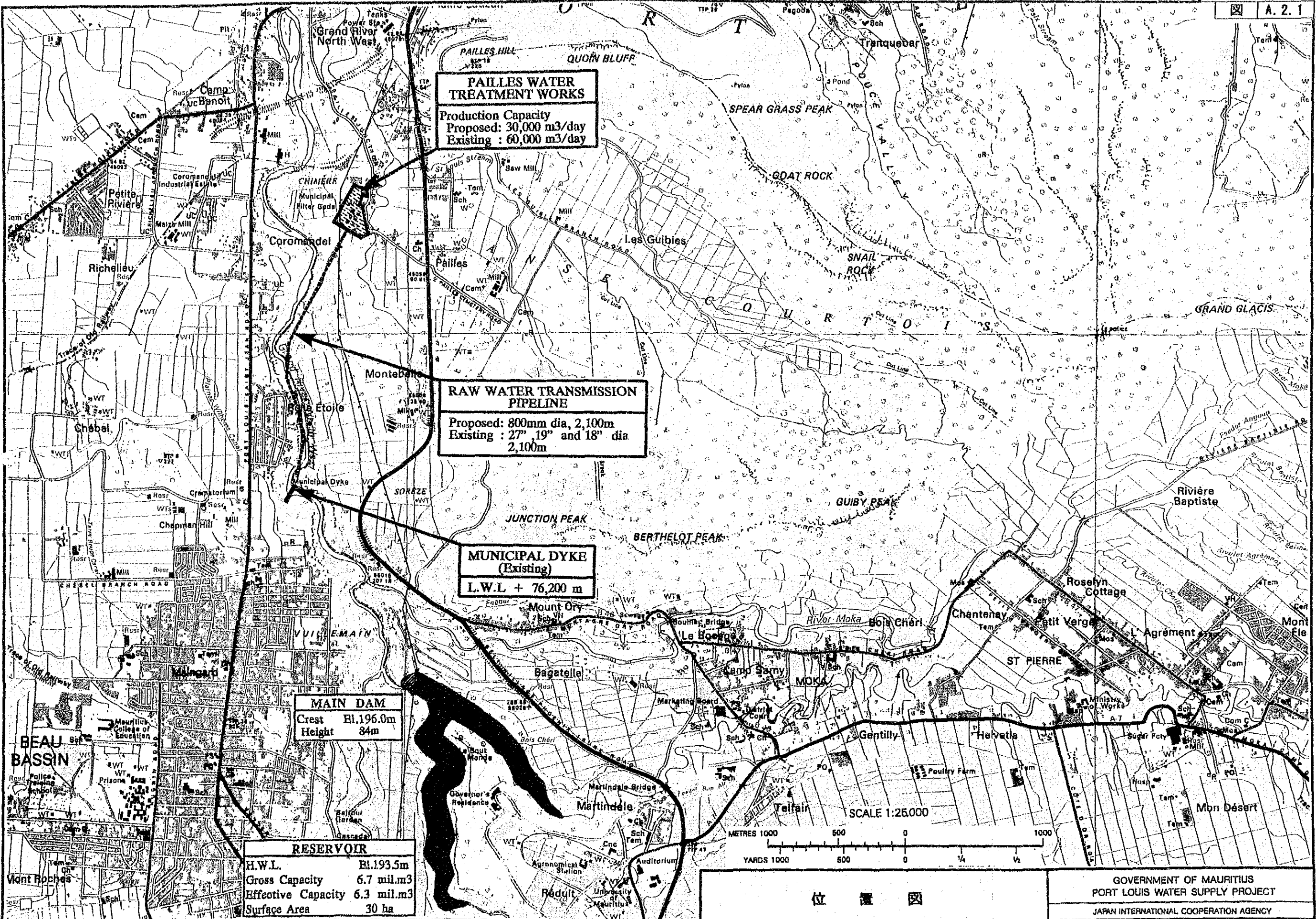

GOVERNMENT OF MAURITIUS
 PORT LOUIS WATER SUPPLY PROJECT
 JAPAN INTERNATIONAL COOPERATION AGENCY

GENERAL PLAN

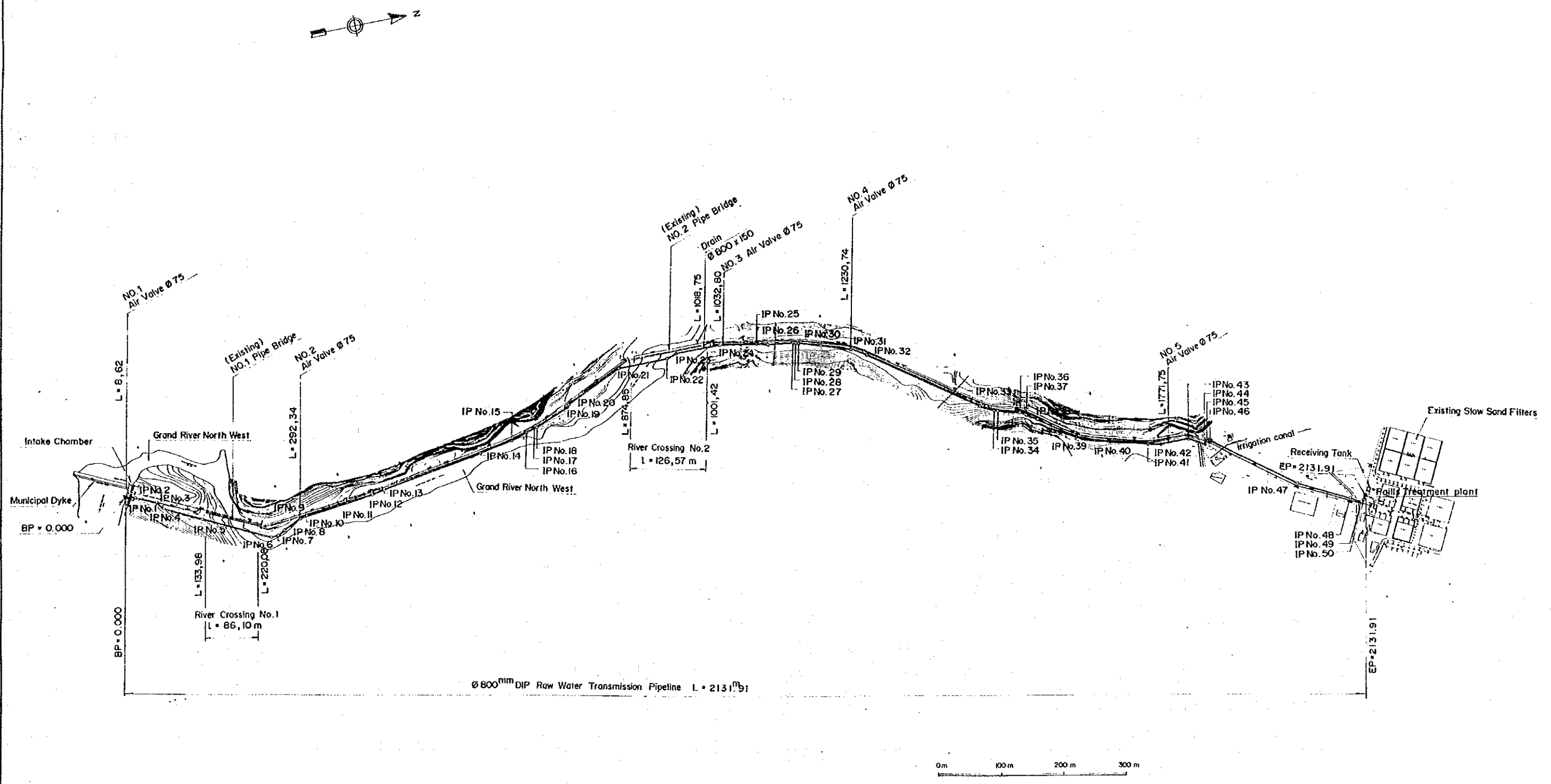
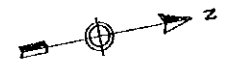

導水管平面図

GOVERNMENT OF MAURITIUS
PORT LOUIS WATER SUPPLY PROJECT
JAPAN INTERNATIONAL COOPERATION AGENCY

GENERAL PROFILE

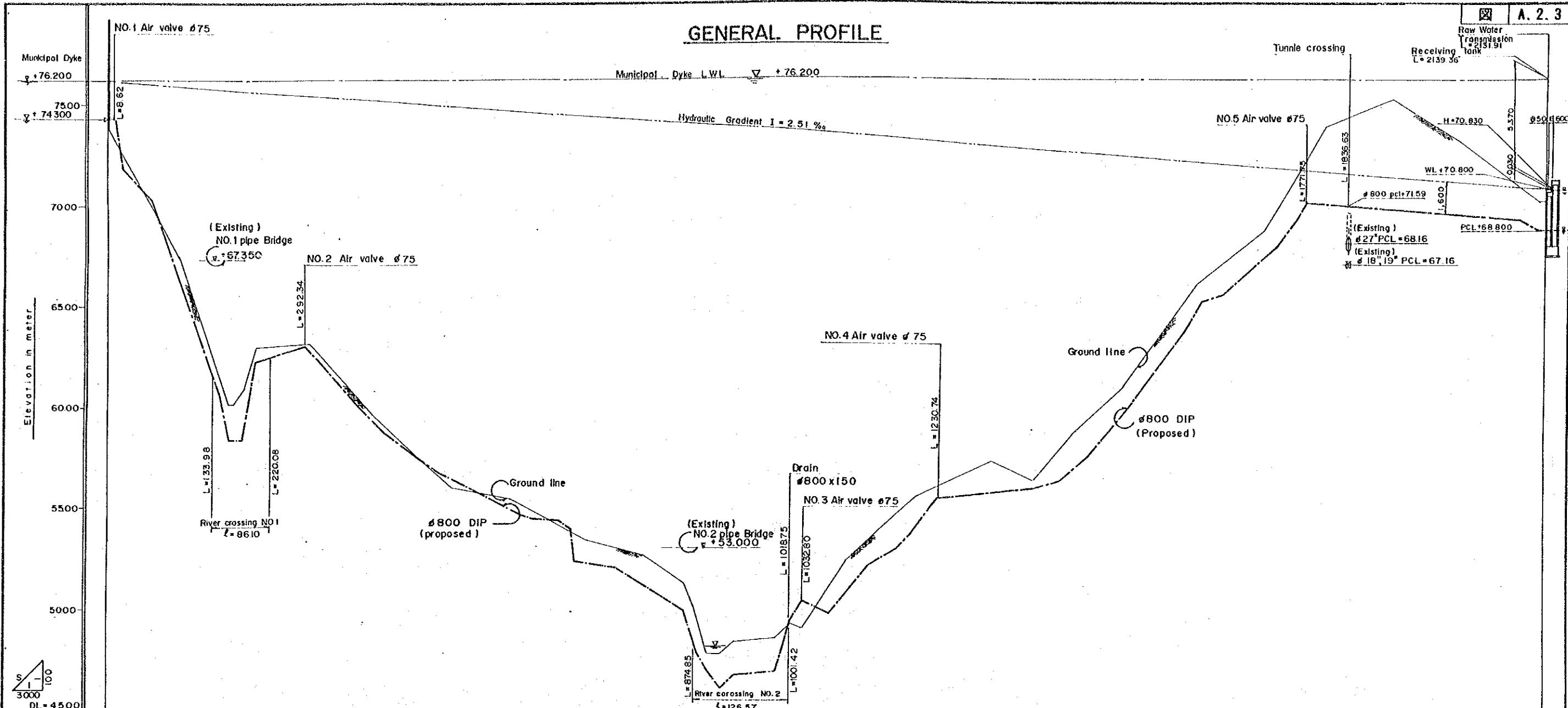

PIPELINE	PIPE-CENTRE LINE ELEVATION	PIPE DISTANCE	HORIZONTAL BEND	GROUND HEIGHT	ACCUMULATED DISTANCE
	74.30	0.00	IPNO.1	79.47	0
	74.30	20.70	IPNO.2	67.51	102.40
	62.30	62.30	IPNO.3	61.15	180.68
	62.30	115.92	IPNO.4	61.67	200.66
	60.66	160.66	IPNO.5	63.15	300.00
	60.66	175.66	IPNO.6	59.73	393.80
	60.66	195.66	IPNO.7	59.98	513.84
	62.23	220.66	IPNO.8	55.45	600.00
	63.00	292.64	IPNO.9	52.66	796.38
	63.52	313.52	IPNO.10	47.81	900.00
	63.52	372.35	IPNO.11	48.60	1001.42
	63.52	413.81	IPNO.12	52.36	1098.96
	63.52	493.84	IPNO.13	55.54	1200.00
	63.52	542.20	IPNO.14	57.32	1309.74
	63.52	613.19	IPNO.15	56.67	1409.10
	63.52	639.80	IPNO.16	58.75	1429.10
	63.52	646.93	IPNO.17	61.00	1500.00
	63.52	673.86	IPNO.18	66.15	1606.33
	63.52	690.71	IPNO.19	68.75	1709.55
	63.52	694.81	IPNO.20	73.86	1800.00
	63.52	697.42	IPNO.21	75.22	1900.85
	63.52	756.01	IPNO.22	73.17	2000.27
	63.52	856.52	IPNO.23	70.42	2180.60
	63.52	872.33	IPNO.24	68.60	2200.66
	63.52	893.85	IPNO.25		
	63.52	913.85	IPNO.26		
	63.52	933.85	IPNO.27		
	63.52	994.30	IPNO.28		
	63.52	1014.30	IPNO.29		
	63.52	1032.80	IPNO.30		
	63.52	107.75	IPNO.31		
	63.52	1130.81	IPNO.32		
	63.52	1170.86	IPNO.33		
	63.52	1190.94	IPNO.34		
	63.52	1222.62	IPNO.35		
	63.52	1369.09	IPNO.36		
	63.52	1409.10	IPNO.37		
	63.52	1449.10	IPNO.38		
	63.52	1500.00	IPNO.39		
	63.52	1594.49	IPNO.40		
	63.52	1617.75	IPNO.41		
	63.52	1649.43	IPNO.42		
	63.52	1729.40	IPNO.43		
	63.52	1758.43	IPNO.44		
	63.52	1771.75	IPNO.45		
	63.52	2089.96	IPNO.46		
	63.52	2120.66	IPNO.47		
	63.52	2120.66	IPNO.48		

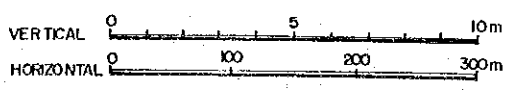

導水管縦断面図

GOVERNMENT OF MAURITIUS
PORT LOUIS WATER SUPPLY PROJECT
JAPAN INTERNATIONAL COOPERATION AGENCY

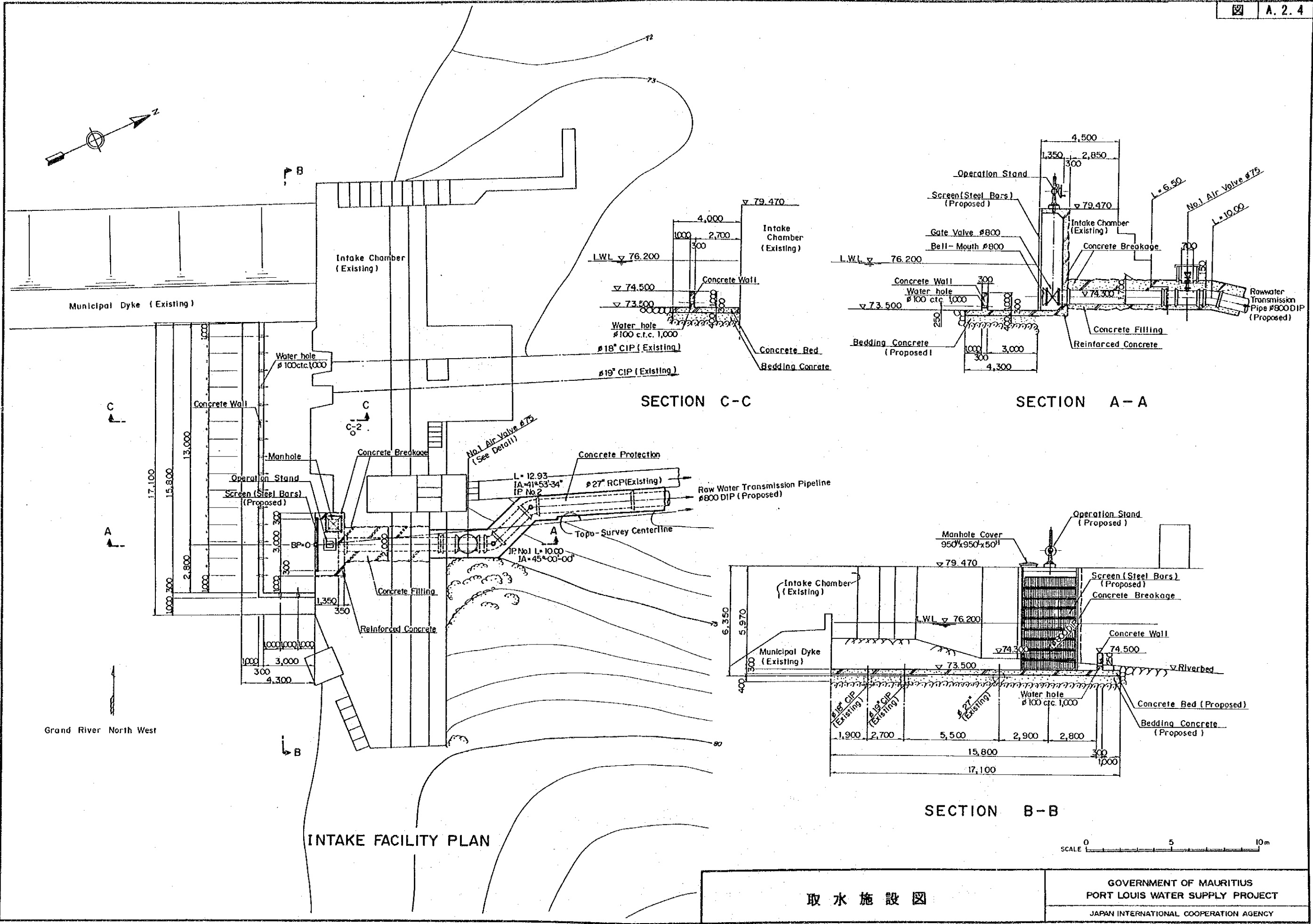

取水施設図

GOVERNMENT OF MAURITIUS
 PORT LOUIS WATER SUPPLY PROJECT
 JAPAN INTERNATIONAL COOPERATION AGENCY

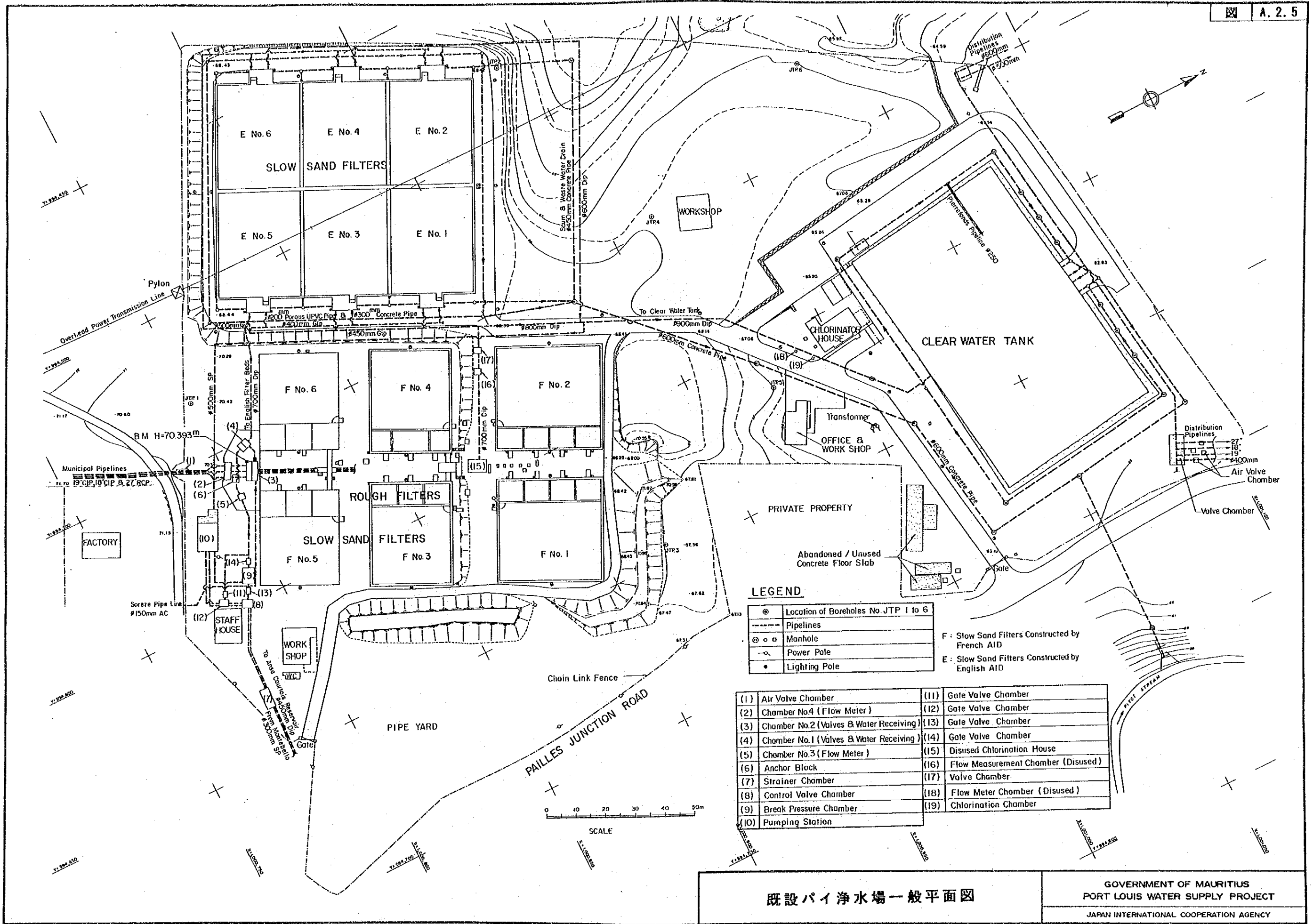

LEGEND

⊙	Location of Boreholes No. JTP 1 to 6
---	Pipelines
⊙ □	Manhole
⊕	Power Pole
•	Lighting Pole
F	Slow Sand Filters Constructed by French AID
E	Slow Sand Filters Constructed by English AID

(1) Air Valve Chamber	(11) Gate Valve Chamber
(2) Chamber No.4 (Flow Meter)	(12) Gate Valve Chamber
(3) Chamber No.2 (Valves & Water Receiving)	(13) Gate Valve Chamber
(4) Chamber No.1 (Valves & Water Receiving)	(14) Gate Valve Chamber
(5) Chamber No.3 (Flow Meter)	(15) Disused Chlorination House
(6) Anchor Block	(16) Flow Measurement Chamber (Disused)
(7) Strainer Chamber	(17) Valve Chamber
(8) Control Valve Chamber	(18) Flow Meter Chamber (Disused)
(9) Break Pressure Chamber	(19) Chlorination Chamber
(10) Pumping Station	

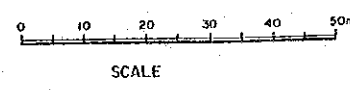

既設パイ浄水場一般平面図

GOVERNMENT OF MAURITIUS
 PORT LOUIS WATER SUPPLY PROJECT
 JAPAN INTERNATIONAL COOPERATION AGENCY

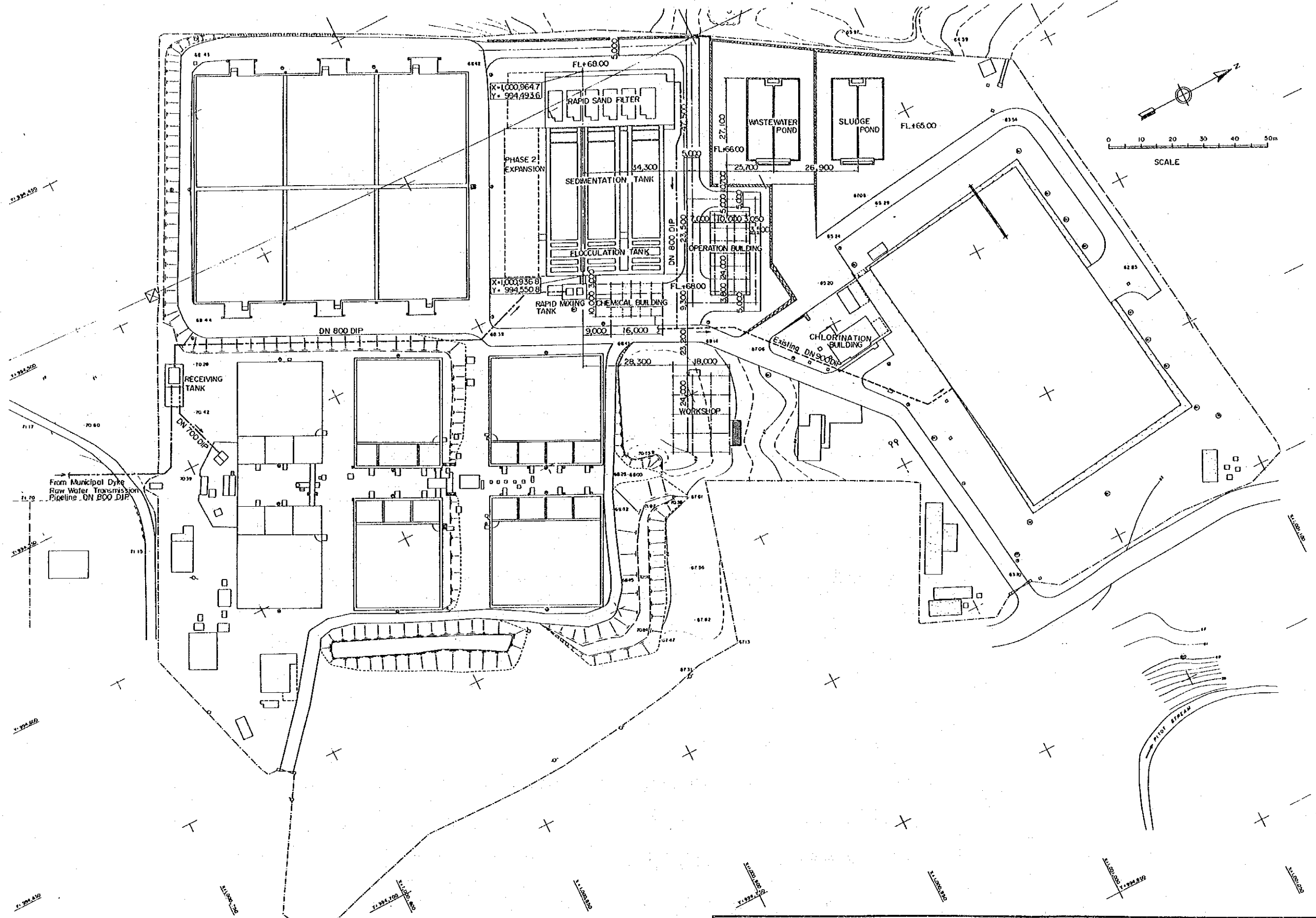

パイ浄水場拡張一般平面図

GOVERNMENT OF MAURITIUS
 PORT LOUIS WATER SUPPLY PROJECT
 JAPAN INTERNATIONAL COOPERATION AGENCY

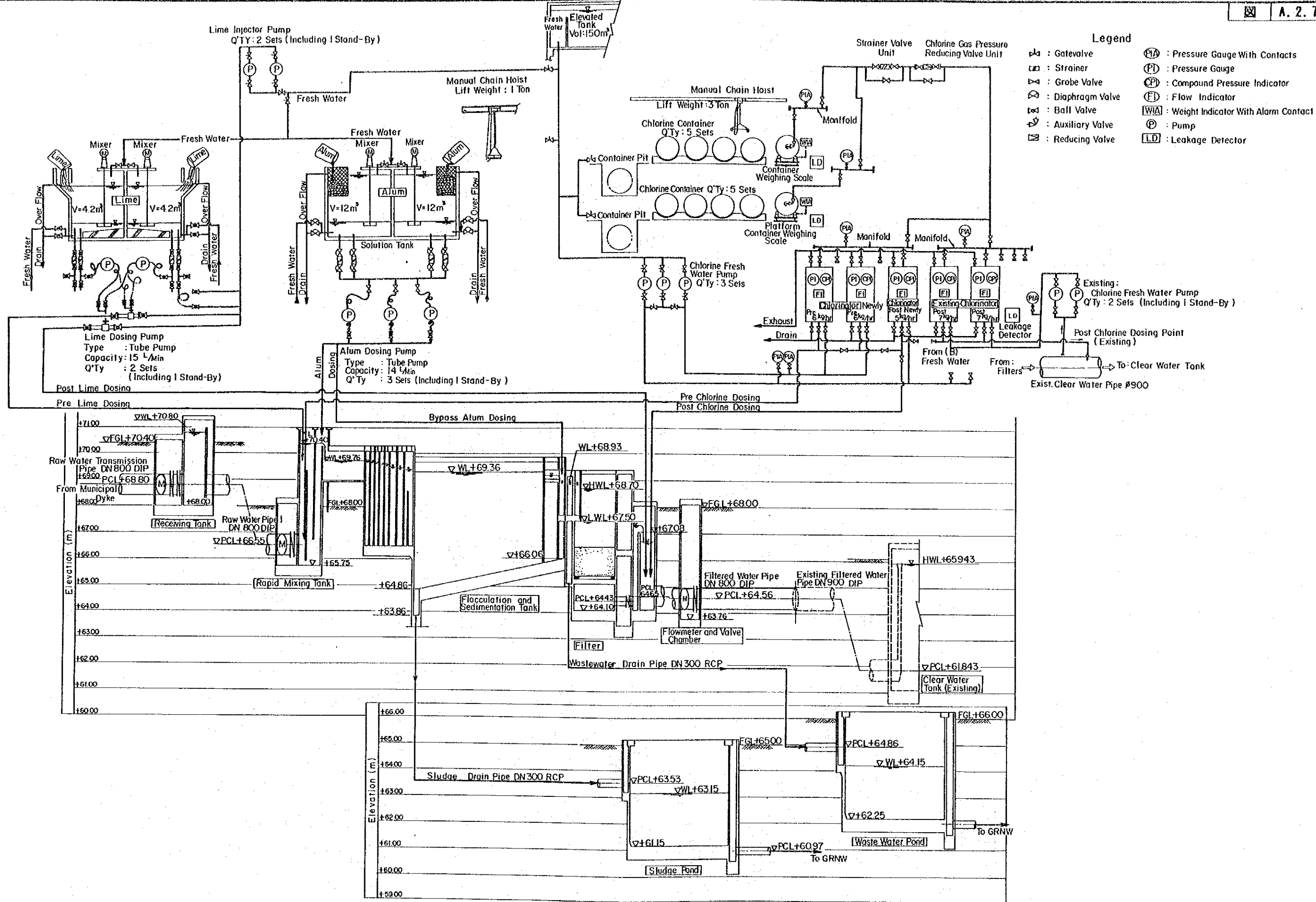

浄水処理系統図及び水位高低図

GOVERNMENT OF MAURITIUS
 PORT LOUIS WATER SUPPLY PROJECT
 JAPAN INTERNATIONAL COOPERATION AGENCY

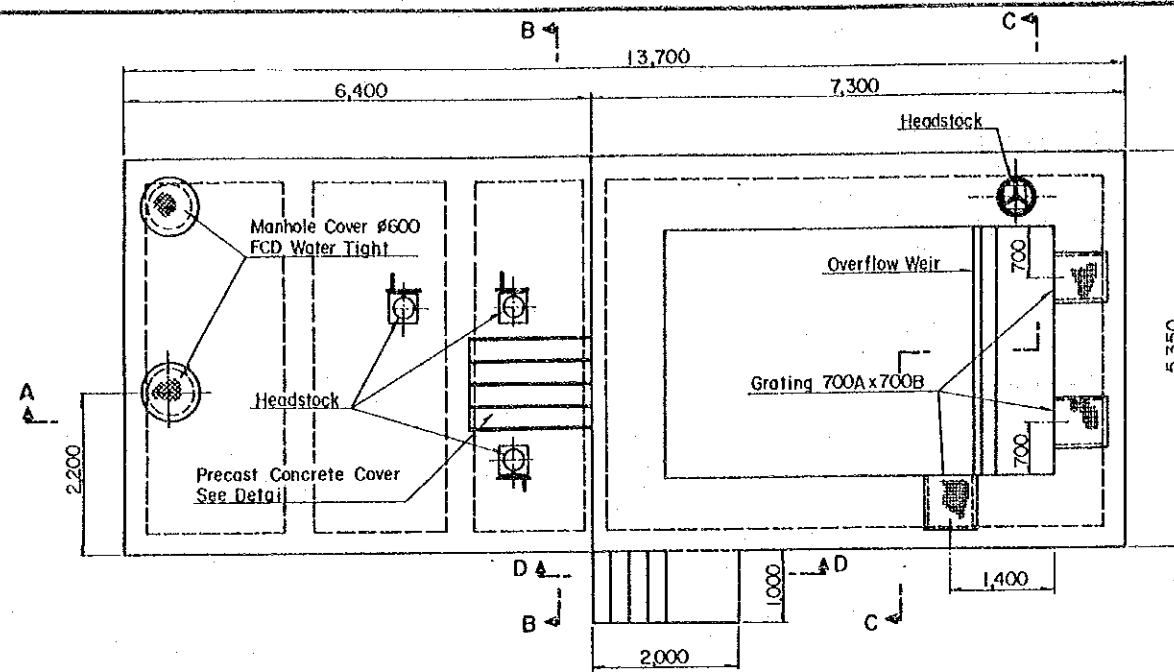

PLAN SCALE A

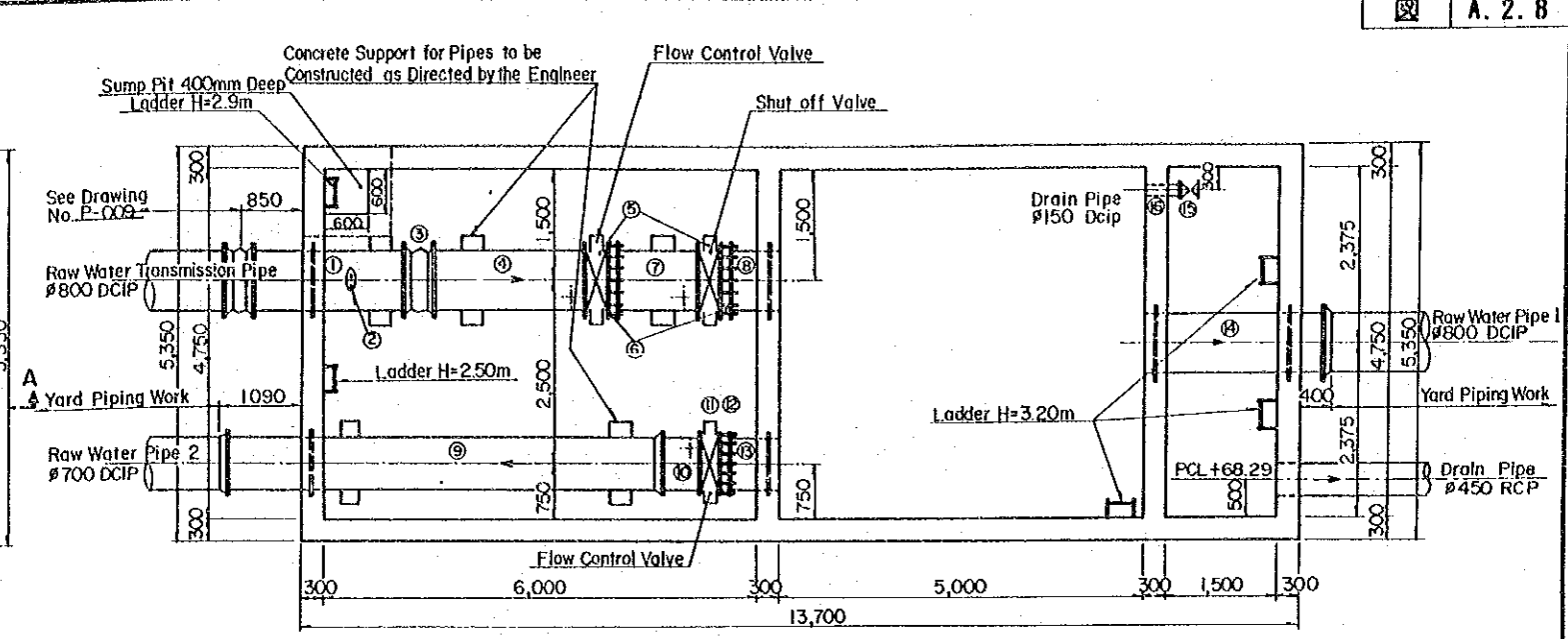

SECTIONAL PLAN SCALE A

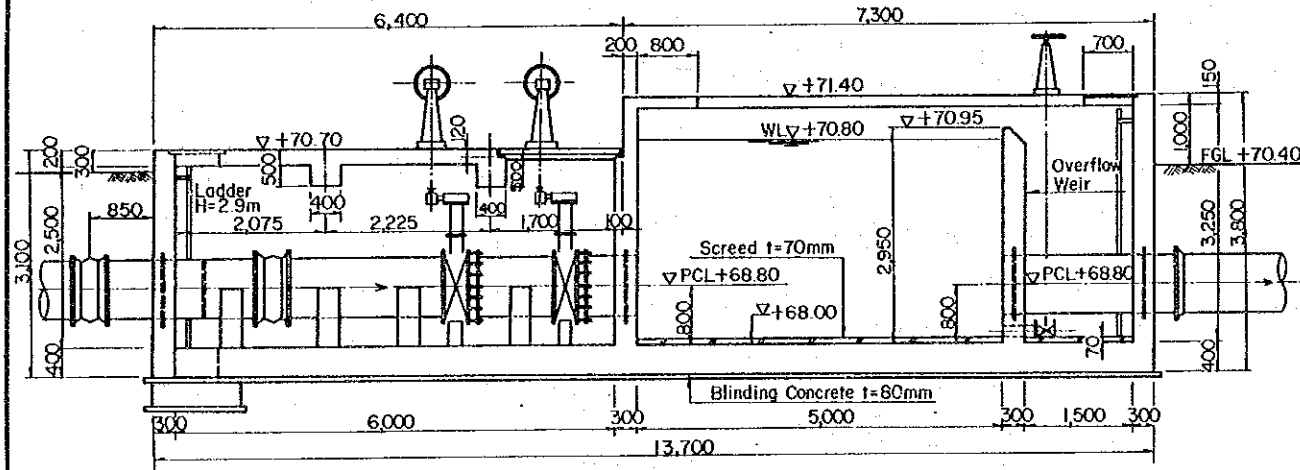

SECTION A-A SCALE A

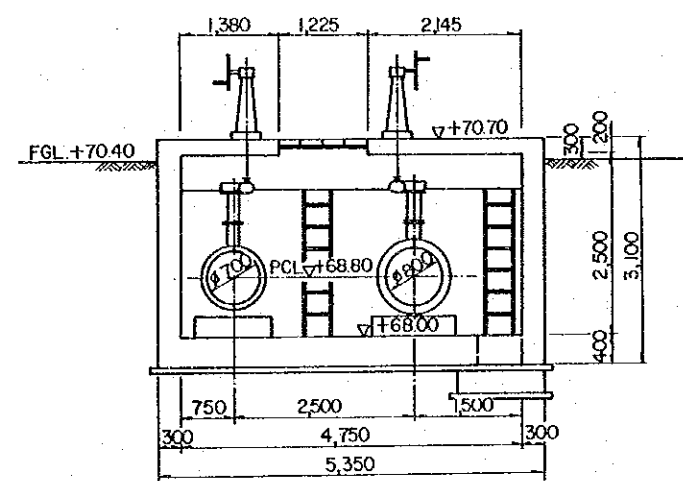

SECTION B-B SCALE A

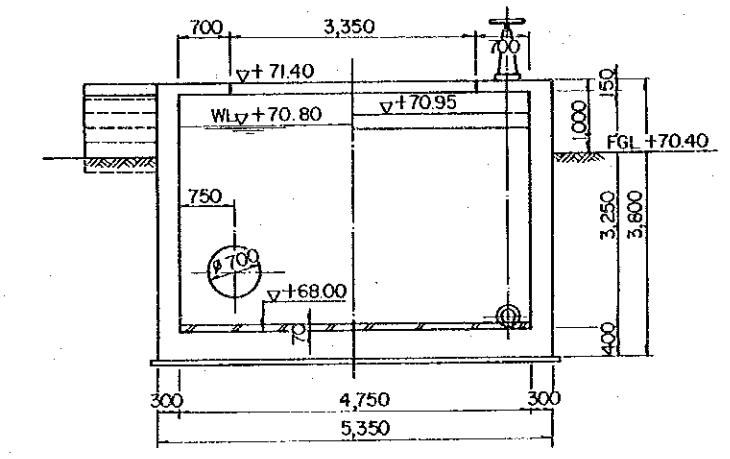

SECTION C-C SCALE A

FITTINGS SCHEDULE				
Item No.	Description	Nominal Diameter (mm)	Length (mm)	No. of Fittings
①	Double Spigot Piece With Puddle Flange Cast On 1,000mm From One End	800	2,500	1
②	Annubar Flow Meter			1
③	Collar	800		1
④	Flanged Spigot	800	2,310	1
⑤	Metal-Seated Tight-Closure Butterfly Valve	800	320	2
⑥	Flange Adapter to Suit 800mm DN Ductile Iron Pipe and PN10 Flange	800		2
⑦	Flanged Spigot	800	1,200	1
⑧	Double Spigot Piece With Puddle Flange Cast On 150mm From One End	800	800	1
⑨	Spigot & Socket Pipe	700	6,000	1
⑩	Flanged Spigot	700	600	1
⑪	Metal-Seated Tight-Closure Butterfly Valve	700	290	1
⑫	Flange Adapter to Suit 700mm DN Ductile Iron Pipe and PN10 Flange	700		1
⑬	Double Spigot Piece With Puddle Flange Cast On 150mm From One End	700	800	1
⑭	Double Spigot Piece With Puddle Flange Cast On 150mm From One End and 550mm From Other End	800	2,500	1
⑮	Double Flange Sluice Valve With Ext. Spindle, Headstock and Handwheel	150	270	1
⑯	Flanged Spigot	150	450	1

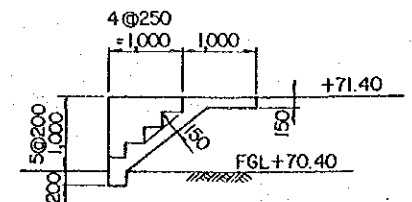

SECTION D-D SCALE A

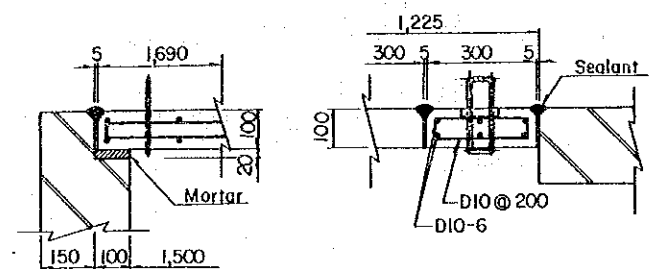

PRECAST CONCRETE COVER SCALE B

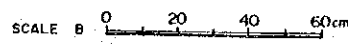

井 水 箱

GOVERNMENT OF MAURITIUS
PORT LOUIS WATER SUPPLY PROJECT
JAPAN INTERNATIONAL COOPERATION AGENCY

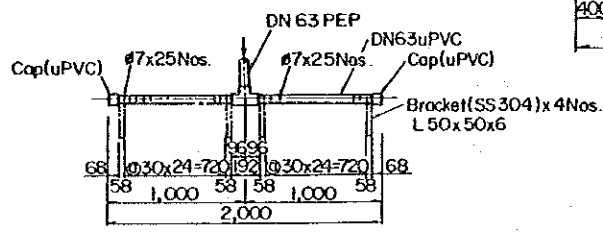
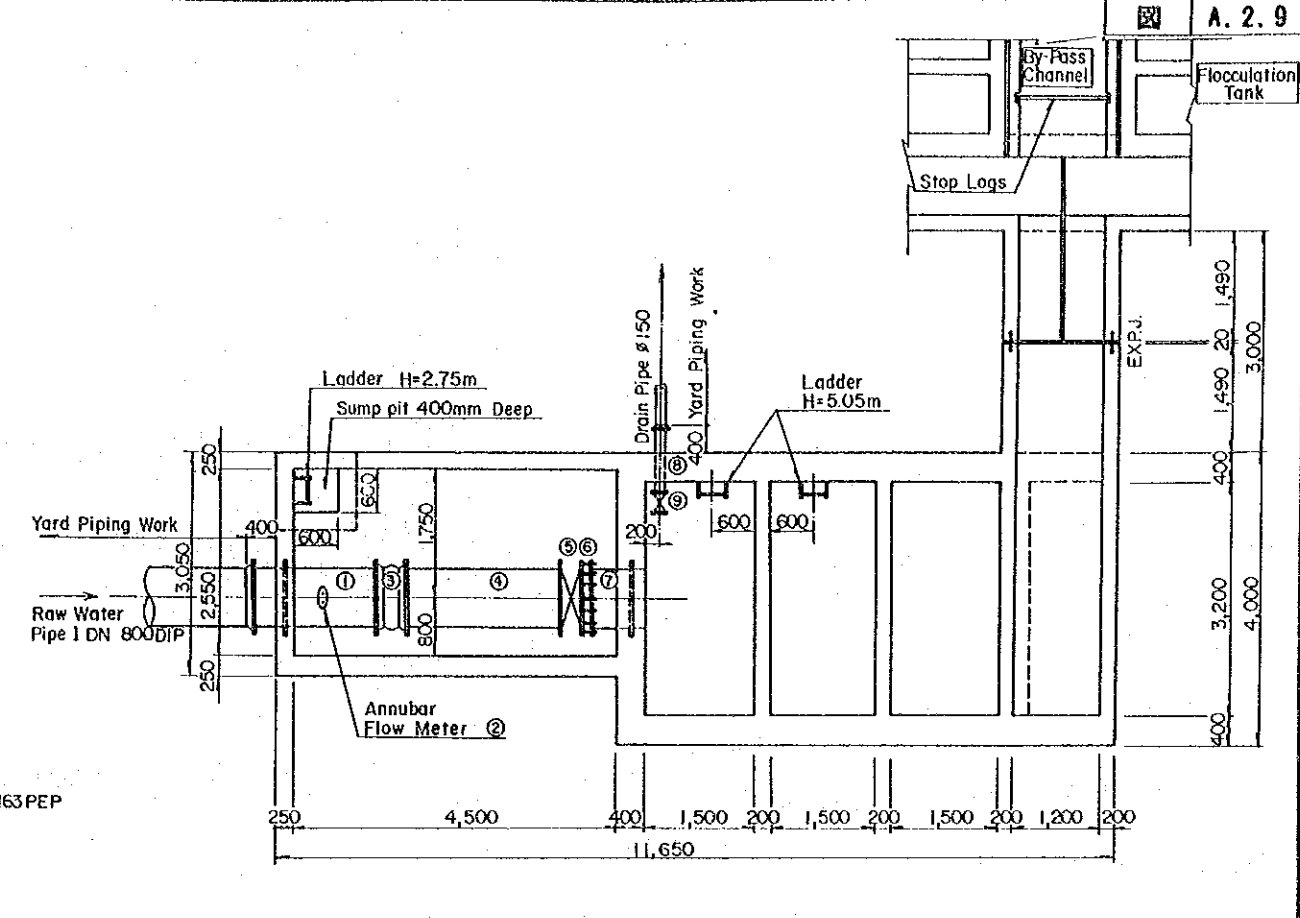
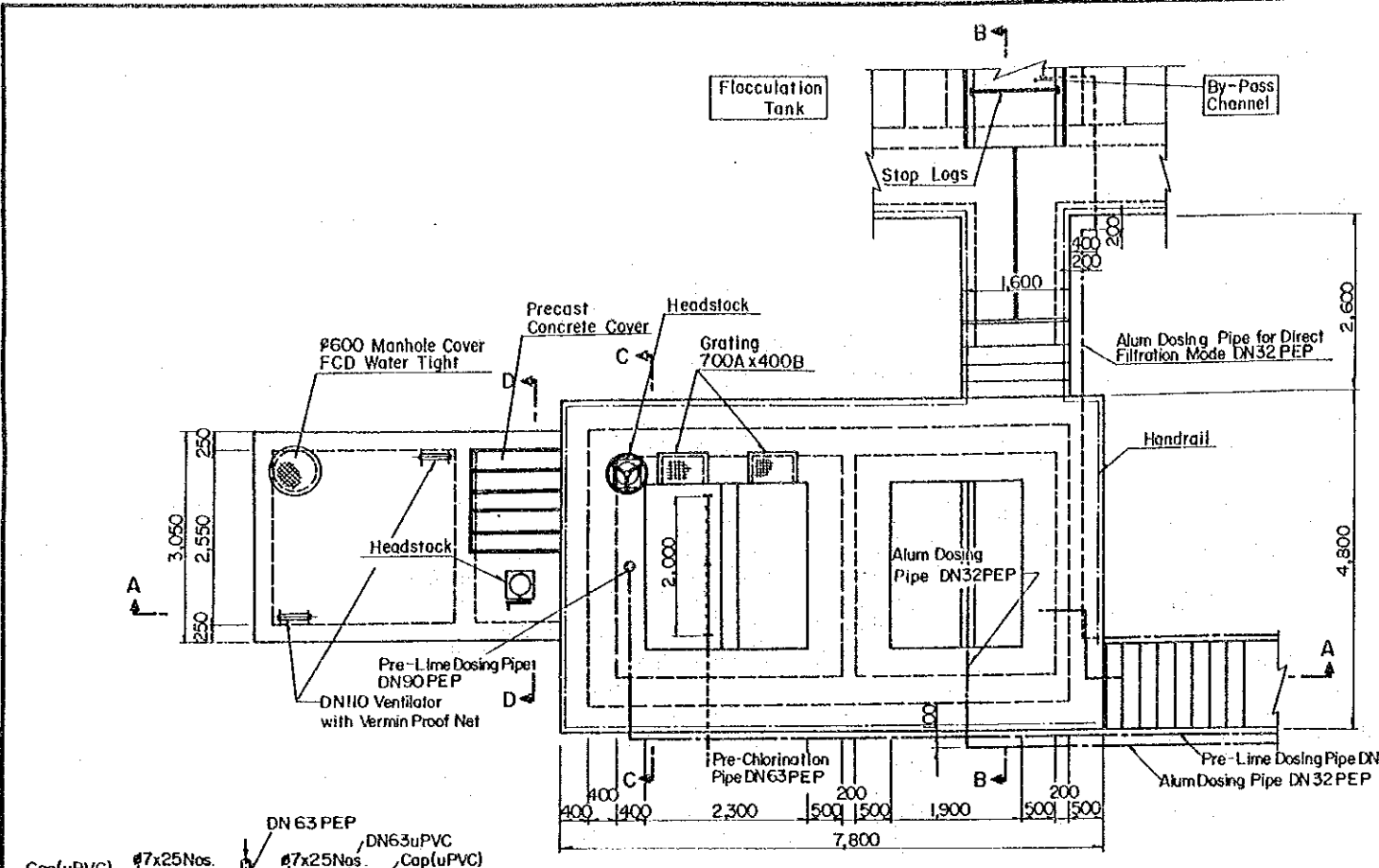

PLAN SCALE A

SECTIONAL PLAN SCALE A

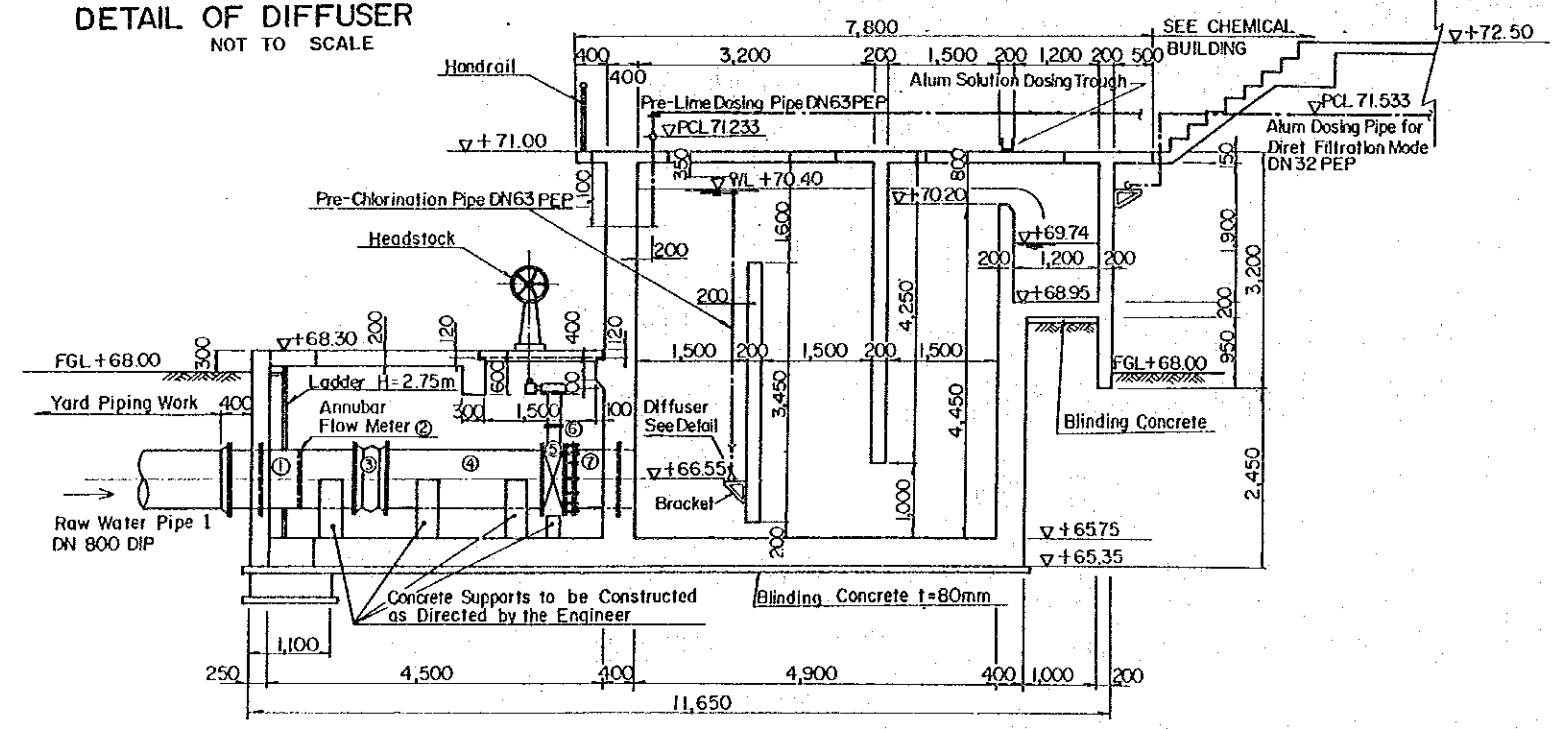

SECTION A-A SCALE A

FITTINGS SCHEDULE				
Item No.	Description	Nominal Diameter (mm)	Length (mm)	No. of Fittings
①	Double Spigot Piece With Puddle Flange Cast on 525mm From One End	800	2,000	1
②	Annubar Flow Meter			1
③	Collar	800		1
④	Flanged Spigot	800	2,330	1
⑤	Metal-Seated Tight-Closure Butterfly Valve	800	320	1
⑥	Flange Adapter to Suit 80mm DN Ductile Iron Pipe and PN 10 Flange	800		1
⑦	Double Spigot Piece With Puddle Flange Cast on 200mm From One End	800	900	1
⑧	Flanged Spigot	150	950	1
⑨	Double Flange Sluice Valve With Ext. Spindle, Headstock and Handwheel	150	270	1



急速混和井

GOVERNMENT OF MAURITIUS
PORT LOUIS WATER SUPPLY PROJECT
JAPAN INTERNATIONAL COOPERATION AGENCY

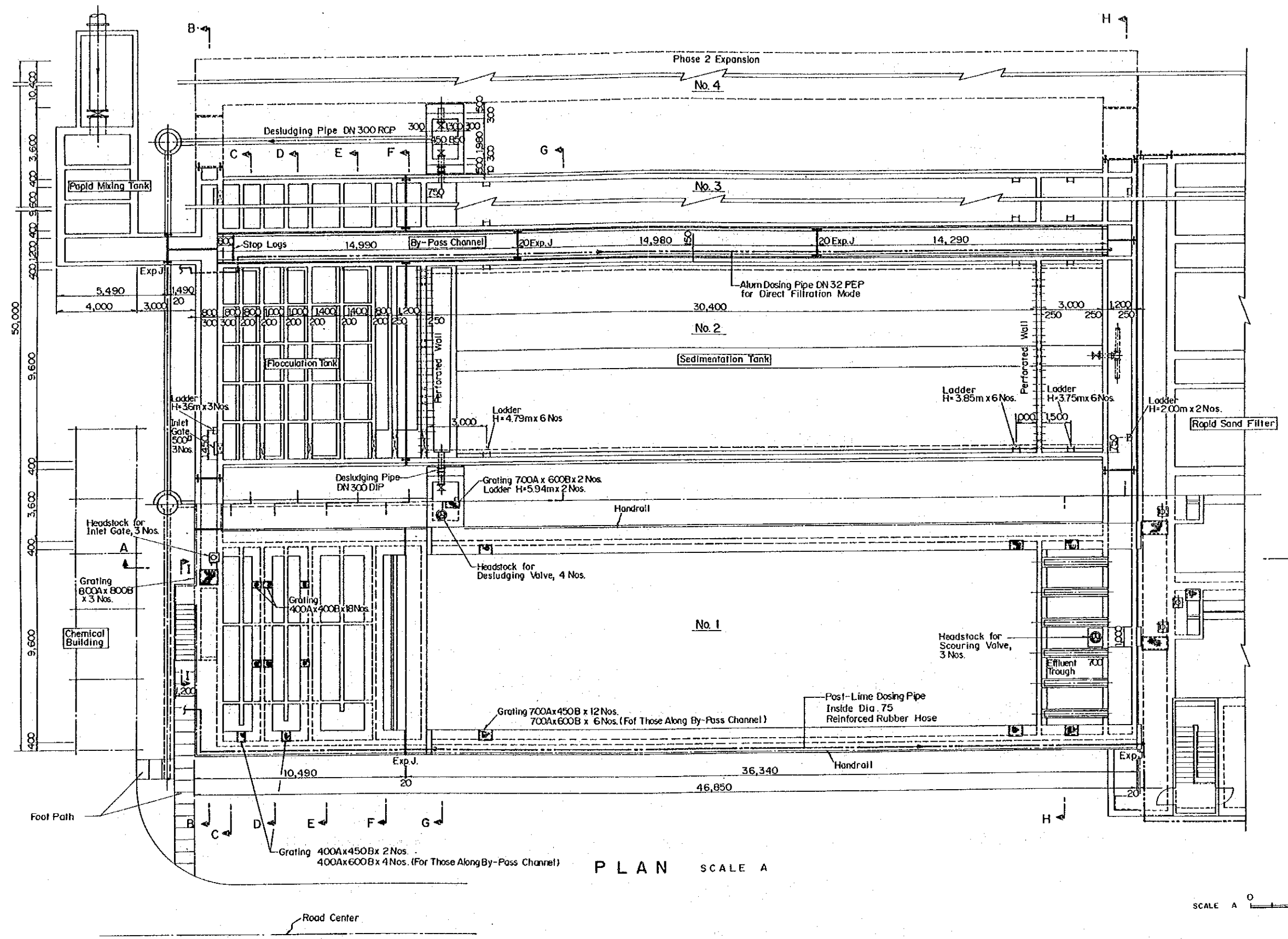

フロック形成・薬品沈でん池 (1)

GOVERNMENT OF MAURITIUS
PORT LOUIS WATER SUPPLY PROJECT
JAPAN INTERNATIONAL COOPERATION AGENCY

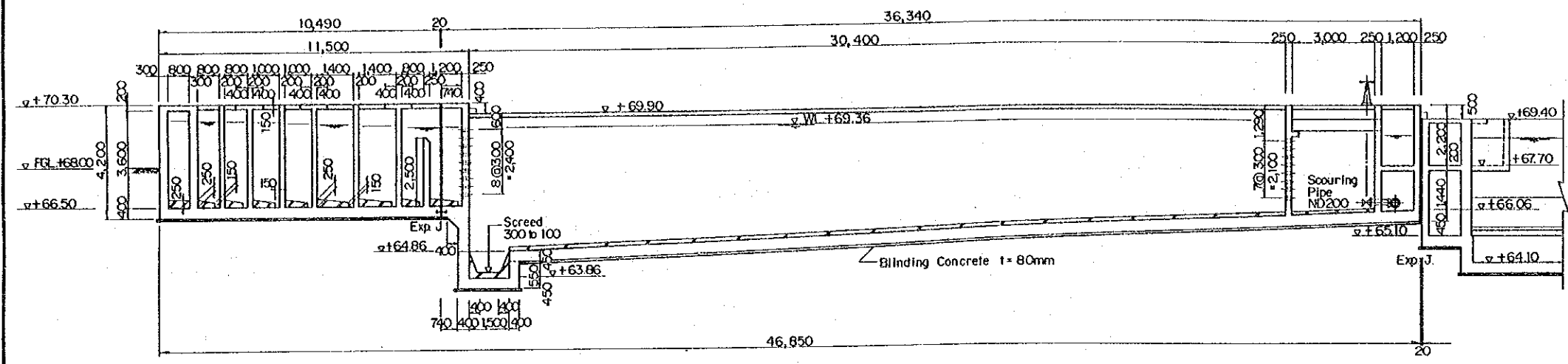

SECTION A-A SCALE A

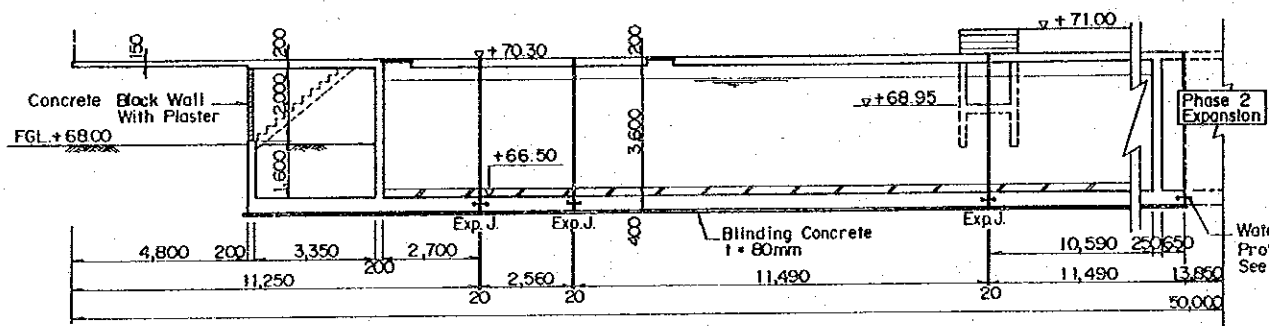

SECTION B-B SCALE A

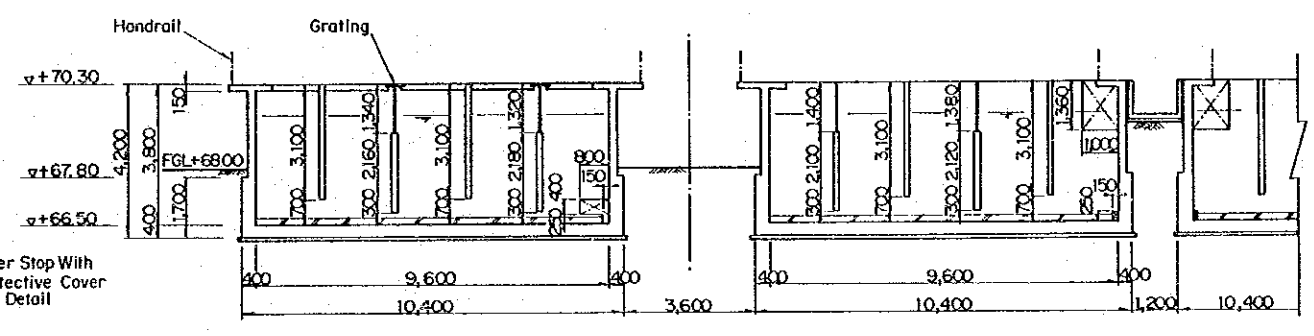

SECTION D-D SCALE A

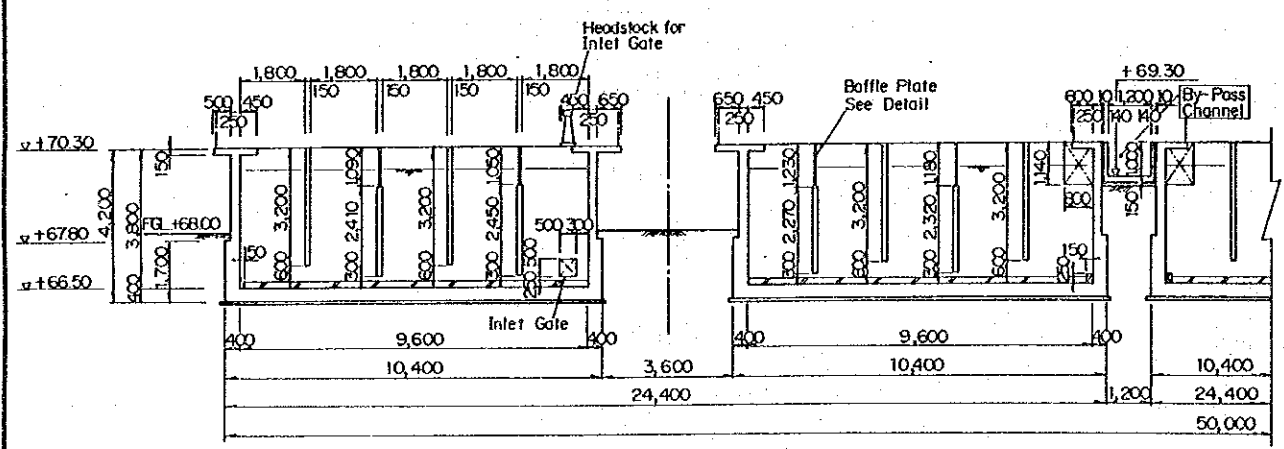

SECTION C-C SCALE A

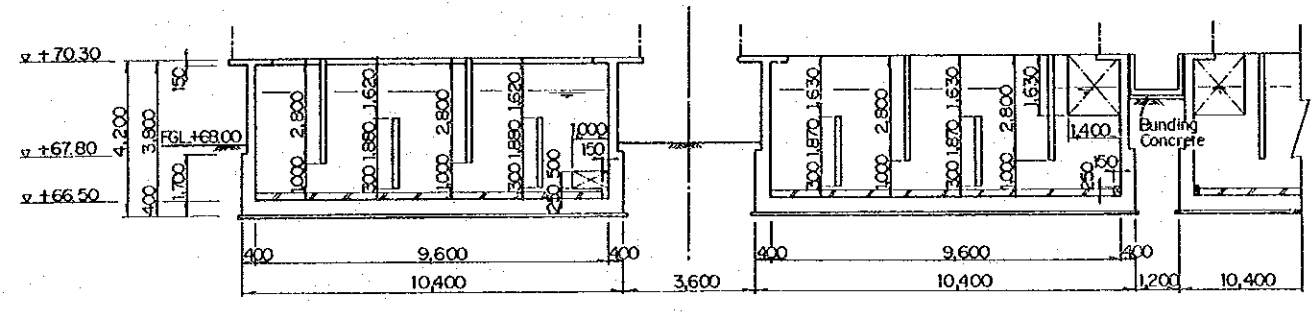

SECTION E-E SCALE A

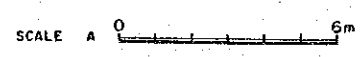

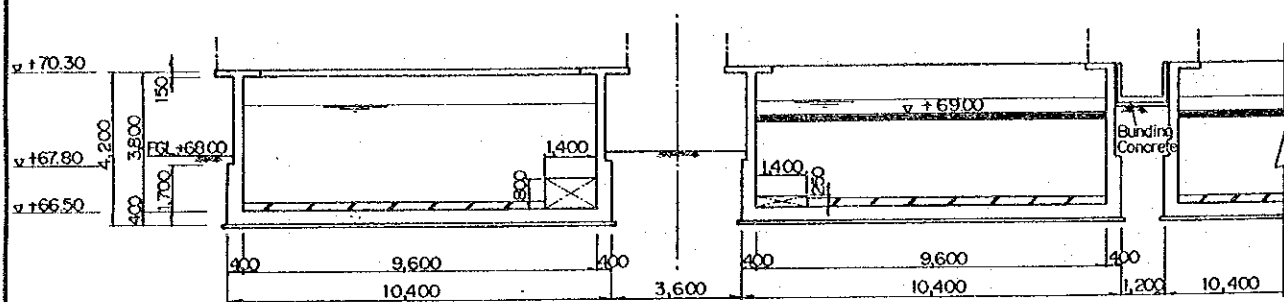

SECTION F-F SCALE A

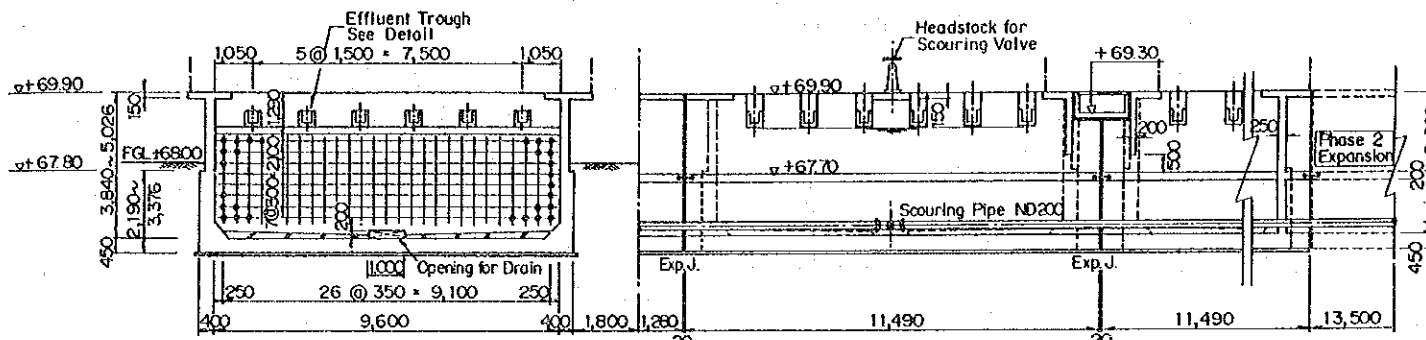

SECTION H-H SCALE A

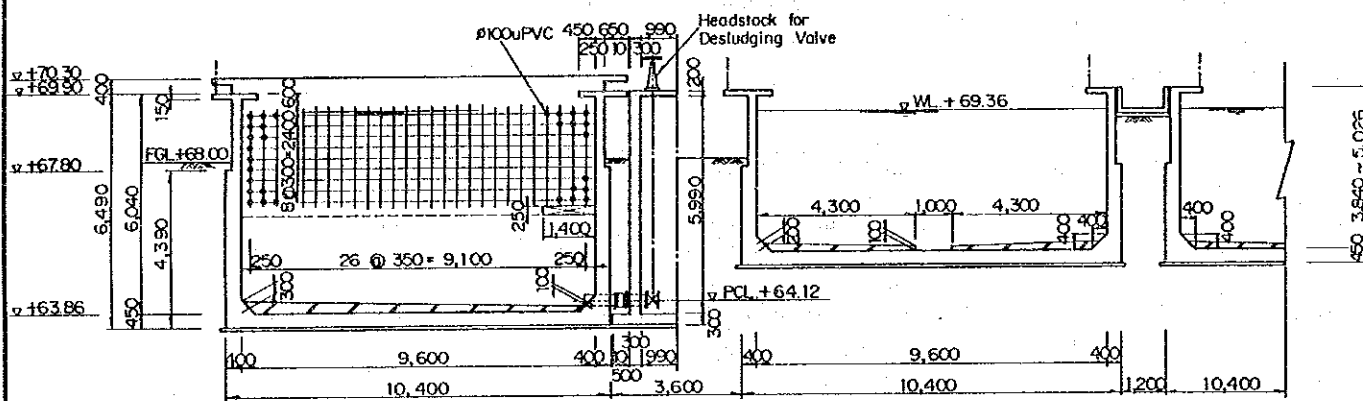

SECTION G-G SCALE A

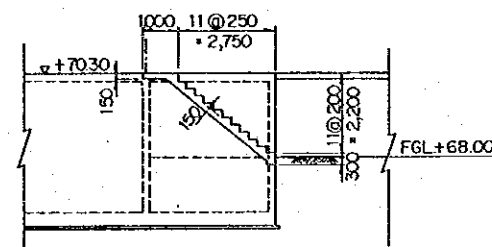

SECTION I-I SCALE A

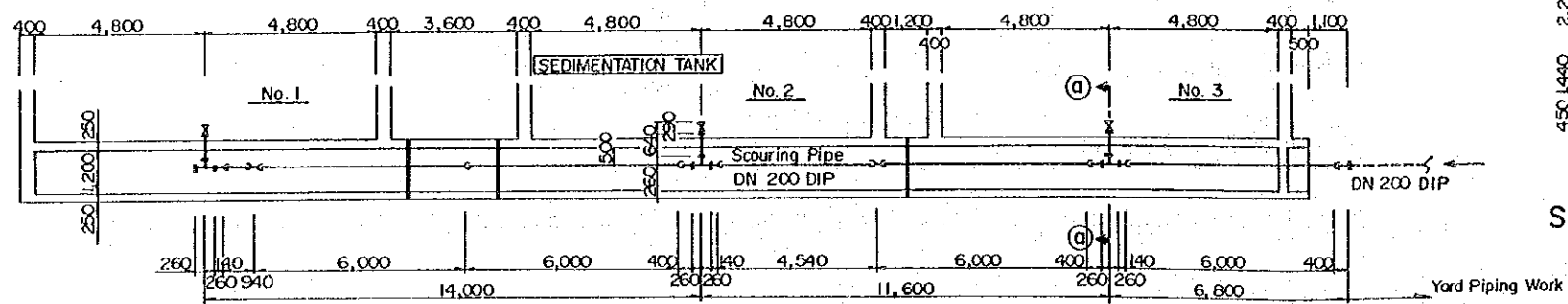

PLAN OF SEDIMENTATION TANK SCOURING PIPE SCALE A

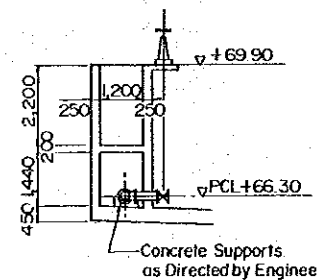

SECTION @-@ SCALE A

PIPES AND FITTINGS SCHEDULE FOR SCOURING PIPE							
Item No	Description	Nominal Diameter (mm)	Length (mm)	Q'TY (nos.)	Unit Weight (Kg)	Total Weight (kg)	Remarks
①	Spigot and Socket Pipe	200	6,000	4	194	776	Push-In Joint Type
②	Double Spigot Piece	200	4,540	1		139	
③	Double Spigot Piece	200	940	1		29	
④	Blank Flange	200	-	1		11	PN 10
⑤	All-Flanged Tee	200x200	520	3	50	150	Ditto
⑥	Double Flanged Piece	200	640	3	39	117	Ditto
⑦	Double Flanged Gate Valve	200	-	3			
⑧	Flanged Socket	200	140	3	21	63	PN10
⑨	Flanged Spigot	200	400	3	23	69	Ditto
⑩	Collar	200	-	2	23	46	MJ Type
Total	(Straight Pipes)					944	
Total	(Fittings)					456	

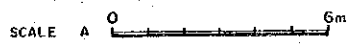

ブロック形成・薬品沈でん池 (3)

GOVERNMENT OF MAURITIUS
PORT LOUIS WATER SUPPLY PROJECT
JAPAN INTERNATIONAL COOPERATION AGENCY

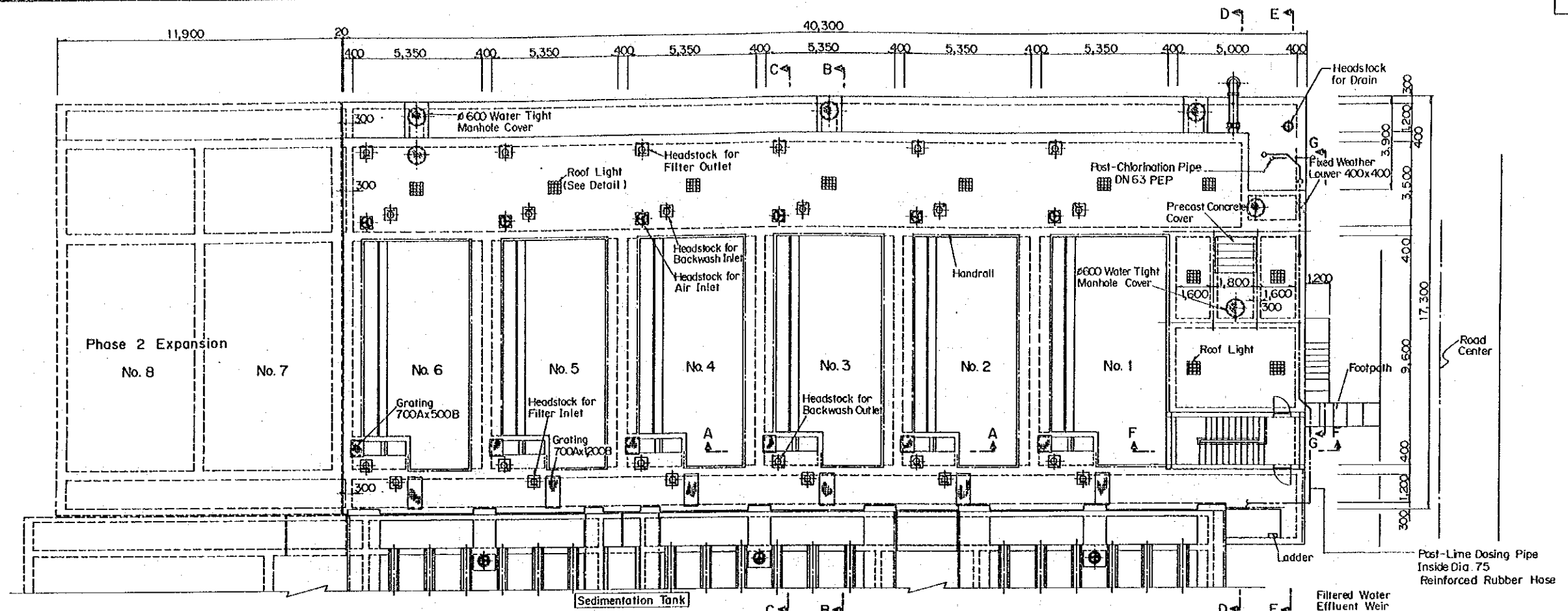

PLAN SCALE A

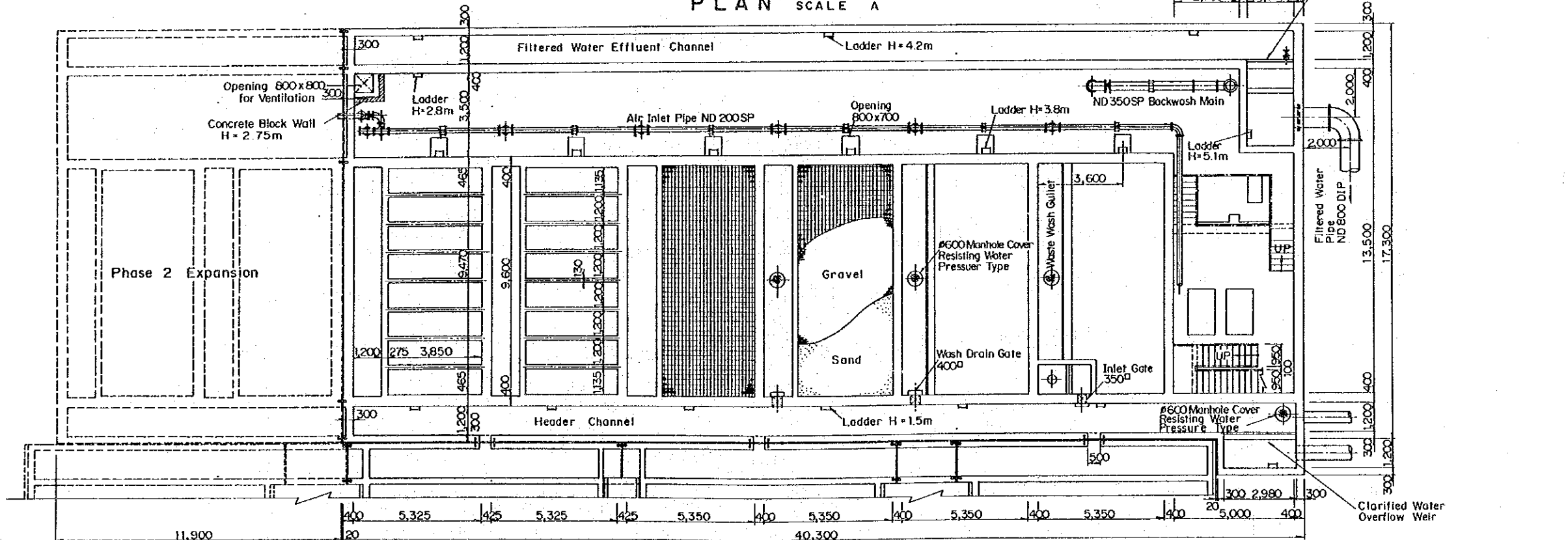

SECTIONAL PLAN SCALE A

SCALE A 0 6m

急速ろ過池 (1)

GOVERNMENT OF MAURITIUS
PORT LOUIS WATER SUPPLY PROJECT
JAPAN INTERNATIONAL COOPERATION AGENCY

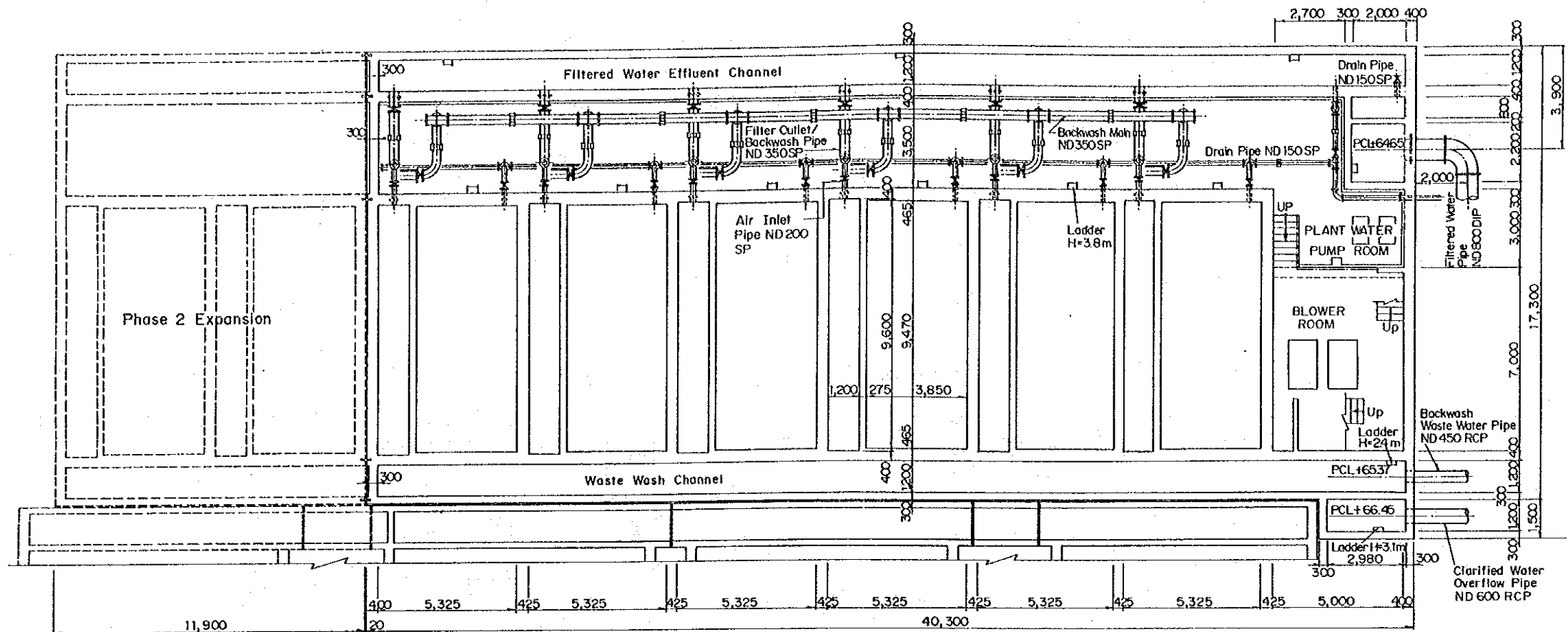

SECTIONAL PLAN No. 2 SCALE A

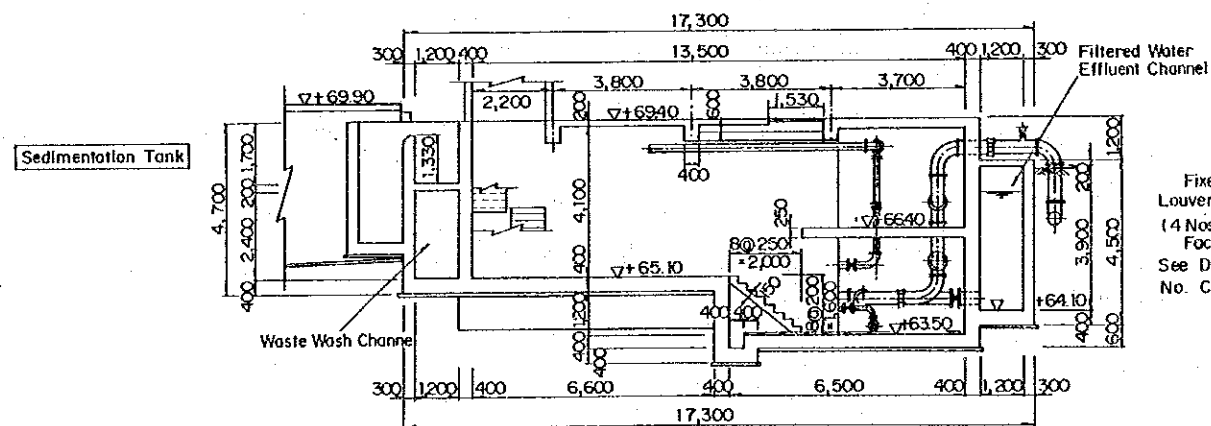

SECTION D-D SCALE A

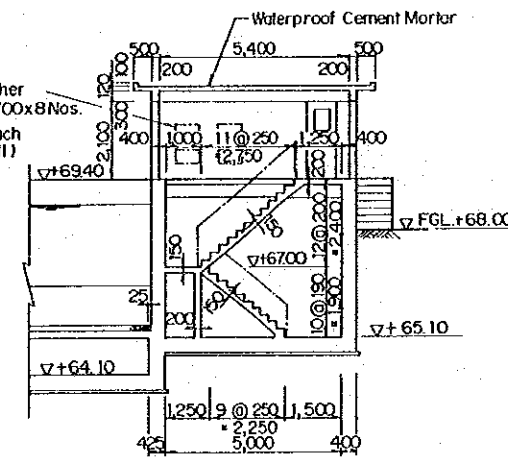

SECTION F-F SCALE A

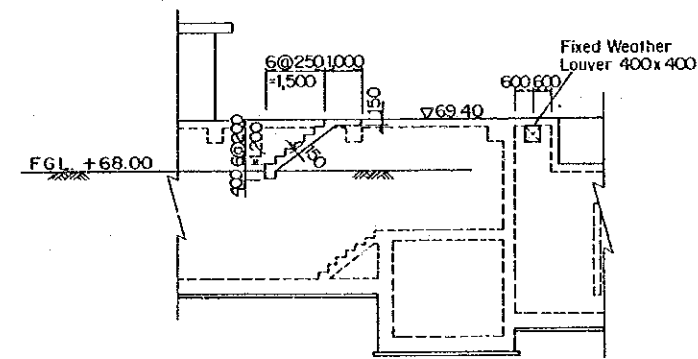

SECTION G-G SCALE A

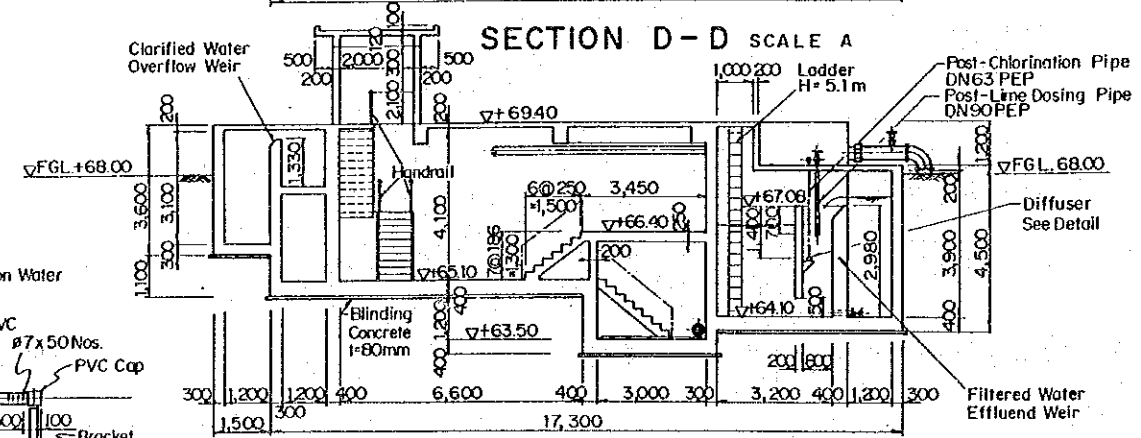

SECTION E-E SCALE A

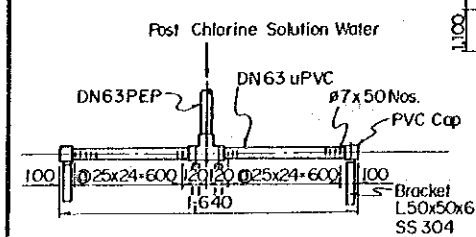

DIFFUSER DETAIL NOT TO SCALE



急速ろ過池 (2)

GOVERNMENT OF MAURITIUS
PORT LOUIS WATER SUPPLY PROJECT
JAPAN INTERNATIONAL COOPERATION AGENCY

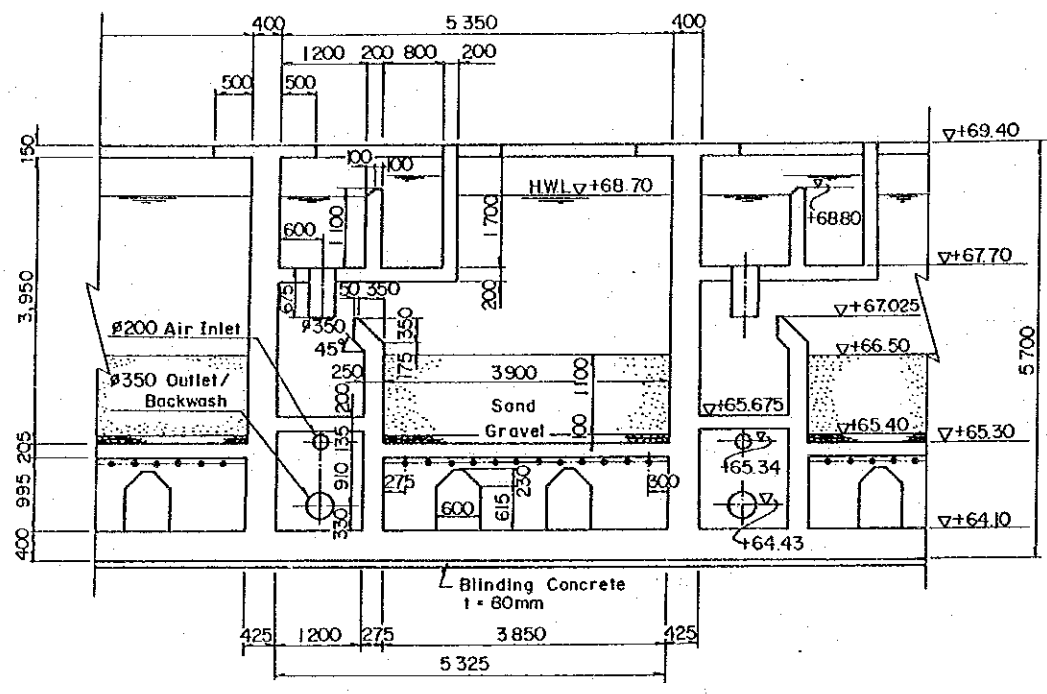

SECTION A-A
SCALE A

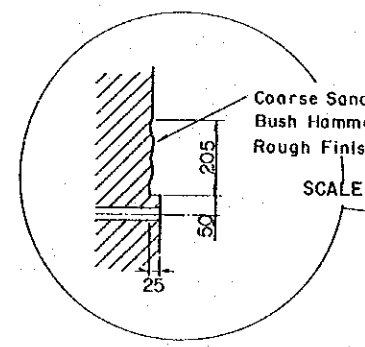
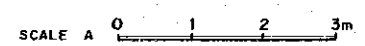

SCALE C

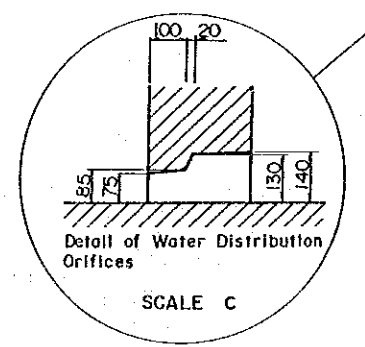

SCALE C

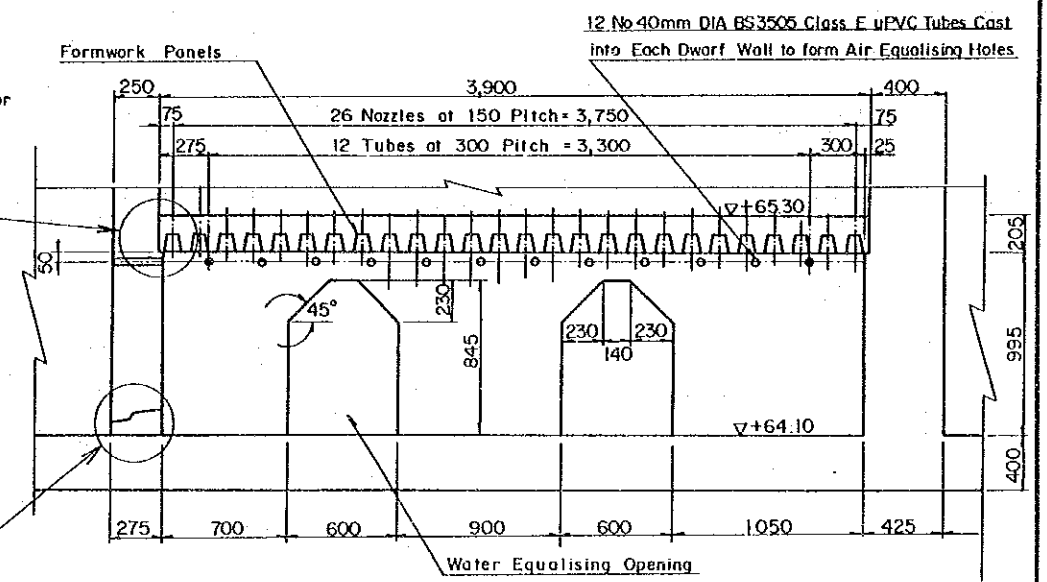

DETAIL OF UNDERDRAIN CROSS SECTION
SCALE B

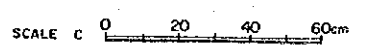
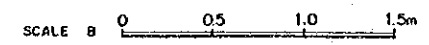

急速ろ過池 (3)

GOVERNMENT OF MAURITIUS
PORT LOUIS WATER SUPPLY PROJECT
JAPAN INTERNATIONAL COOPERATION AGENCY

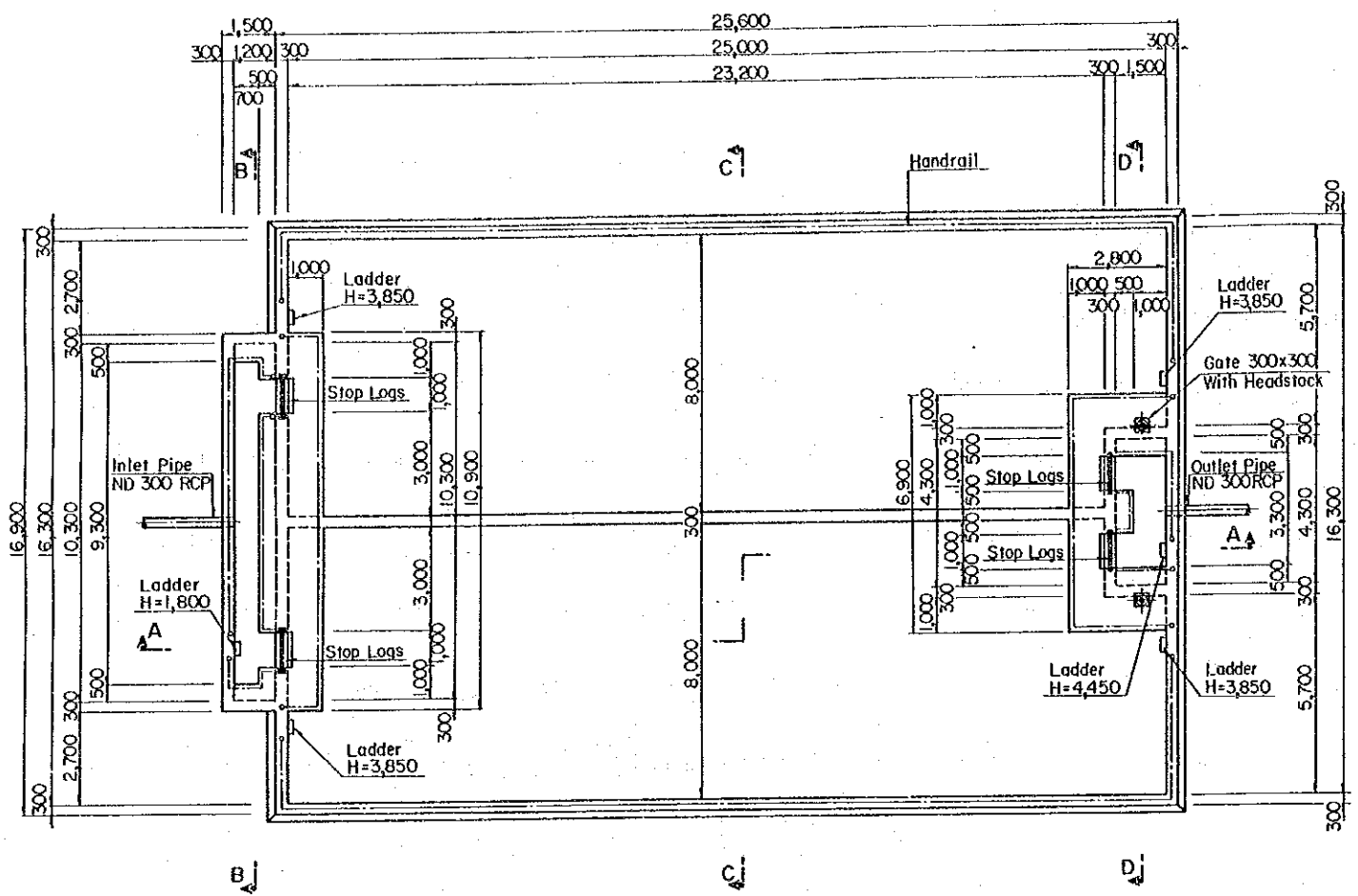

PLAN SCALE A

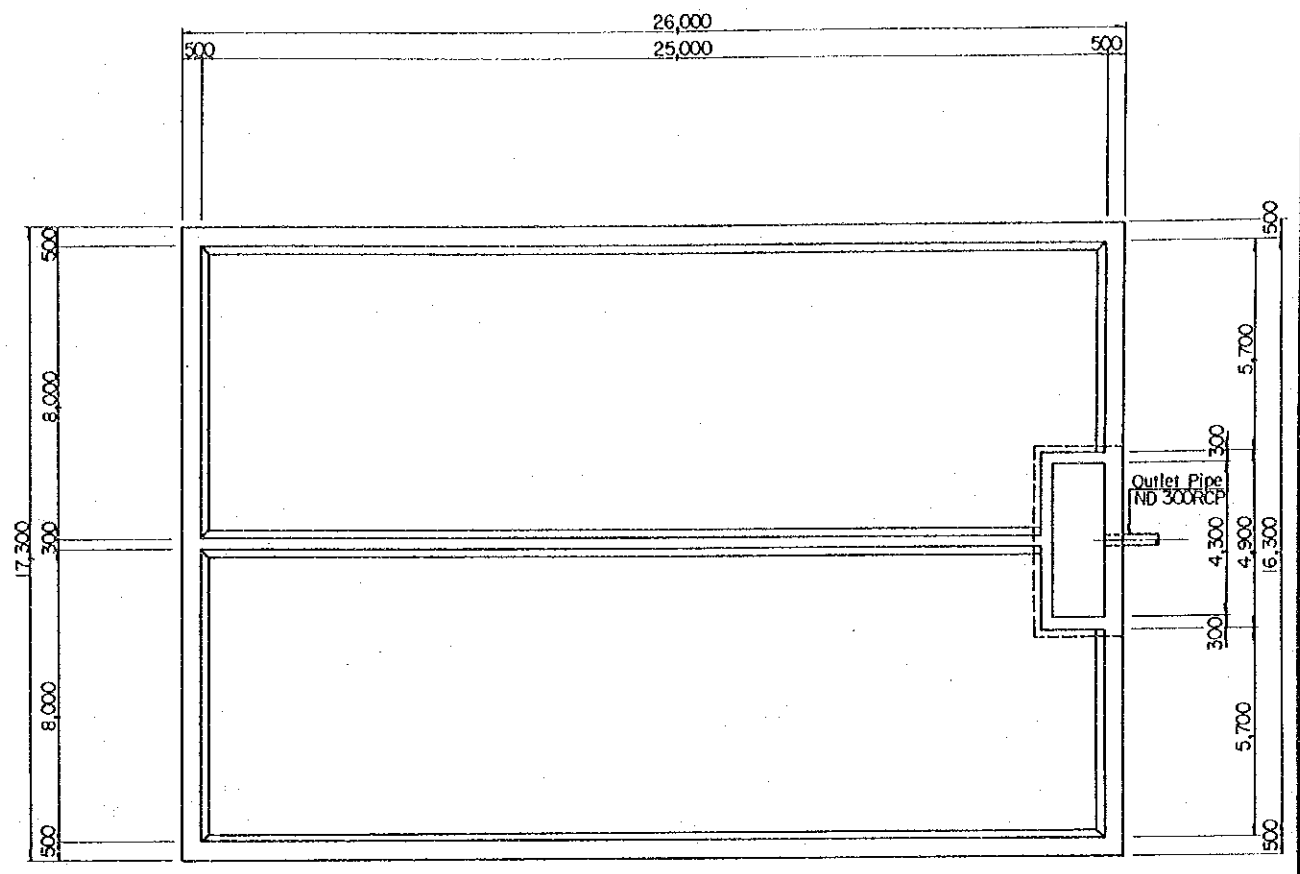

SECTIONAL PLAN SCALE A

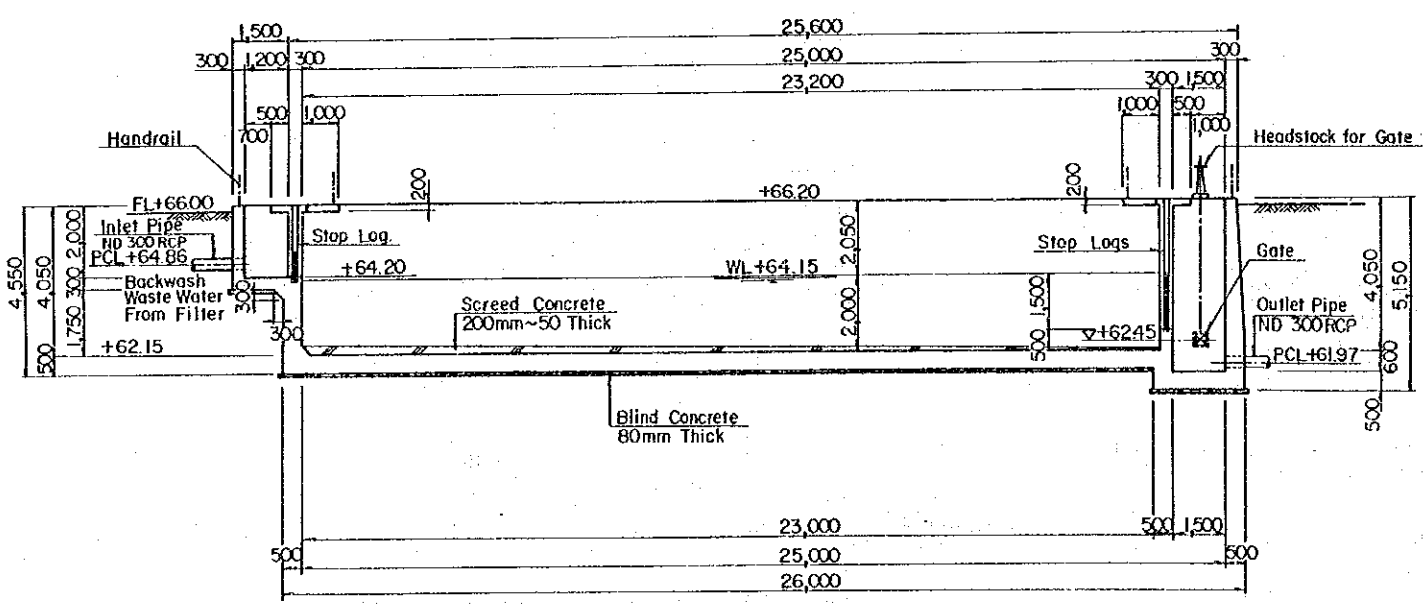

SECTION A-A SCALE A

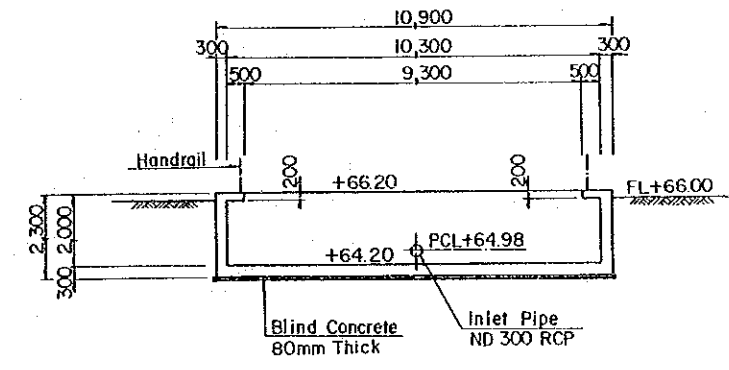

SECTION B-B SCALE A

ELEVATION

PLACE	WASTEWATER POND	SLUDGE POND
Formation Level	+66.000	+65.000
Inlet Pipe	+64.860	+63.530
Water Level	+64.150	+63.150
Bottom Slab	+62.150	+61.150
Outlet Pipe	+61.970	+60.970

Note:
 1) The Structure of Sludge Pond is Identical to That of Waste Water Pond.
 2) Elevations Shown on the Sections are for Waste Water Pond. For Those for Sludge Pond Refer to the Table.



洗淨排水池及び沈でん排泥池

GOVERNMENT OF MAURITIUS
 PORT LOUIS WATER SUPPLY PROJECT
 JAPAN INTERNATIONAL COOPERATION AGENCY

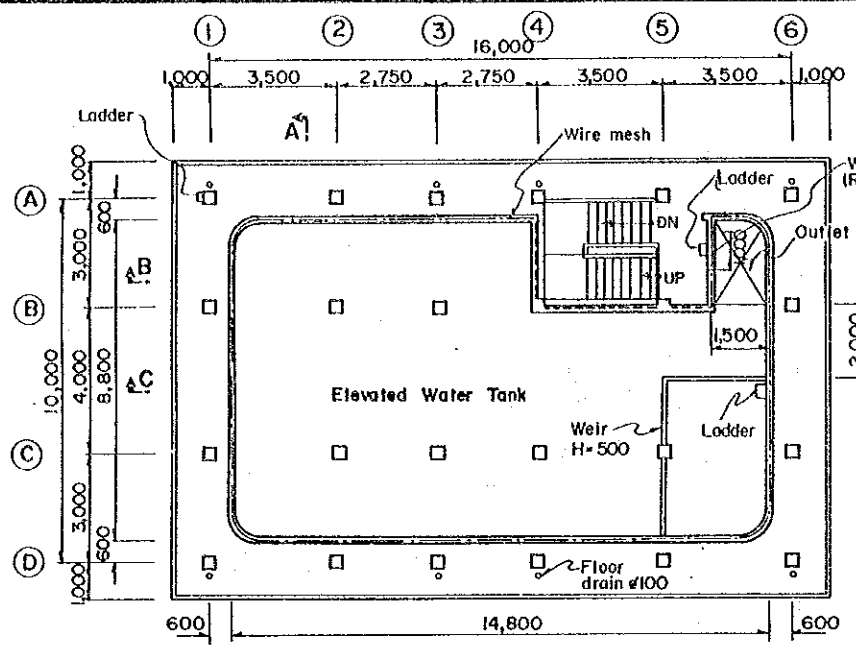

2nd FLOOR PLAN SCALE A

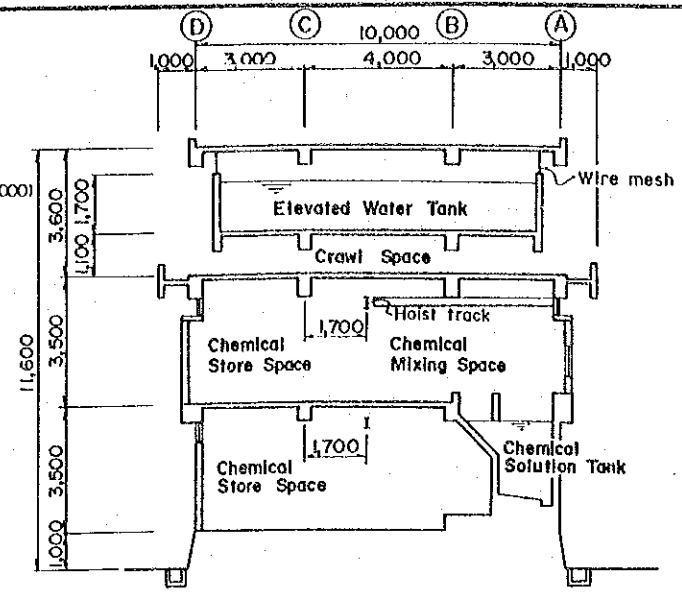

SECTION A-A SCALE A

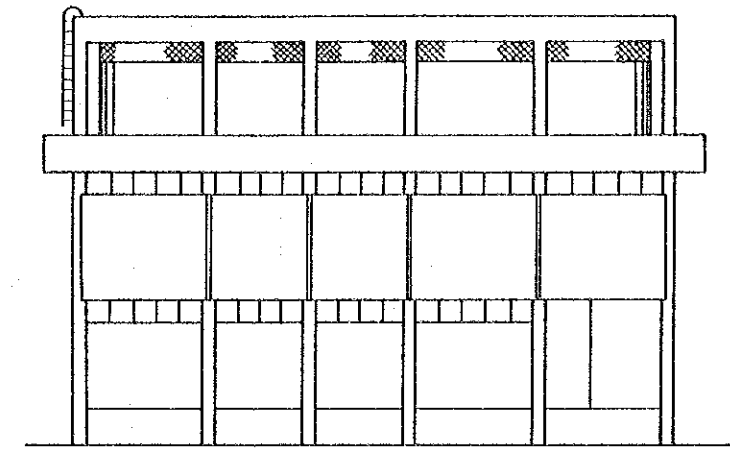

FRONT SIDE ELEVATION SCALE A

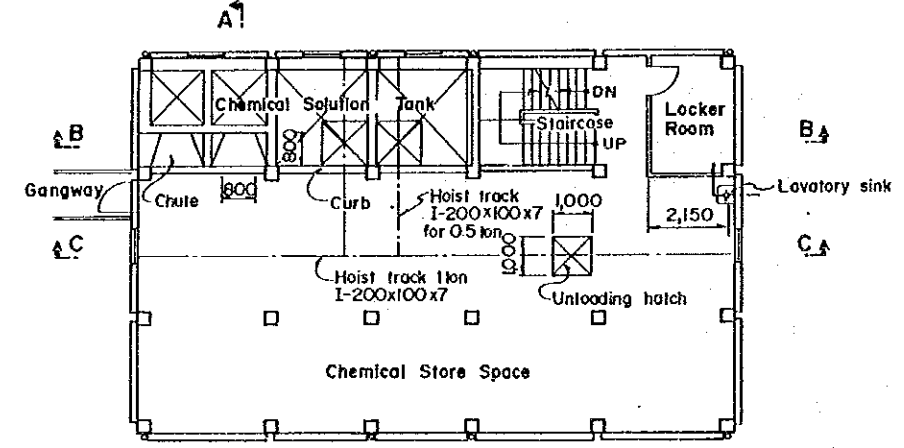

1st FLOOR PLAN SCALE A

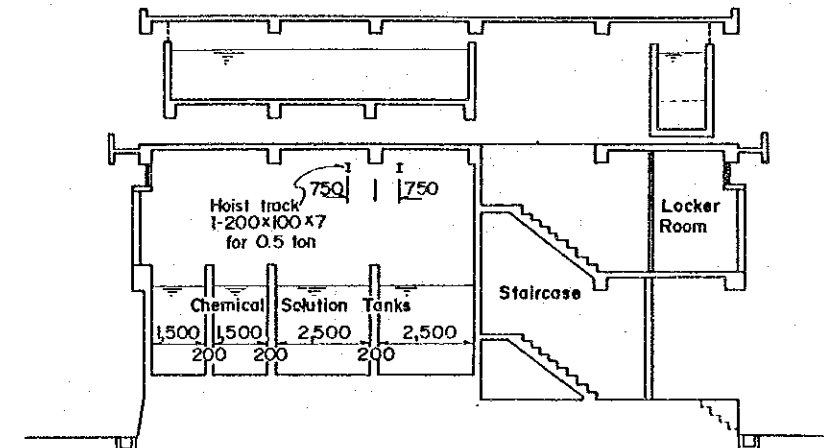

SECTION B-B

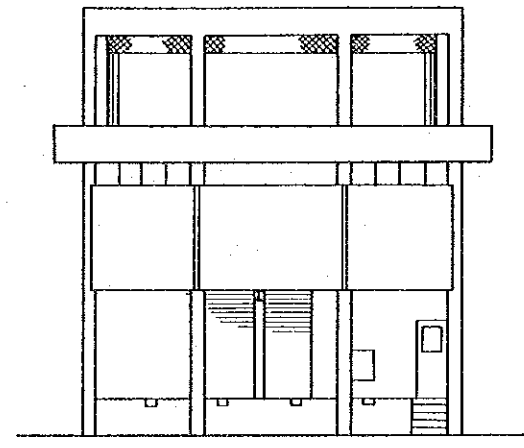

RIGHT SIDE ELEVATION

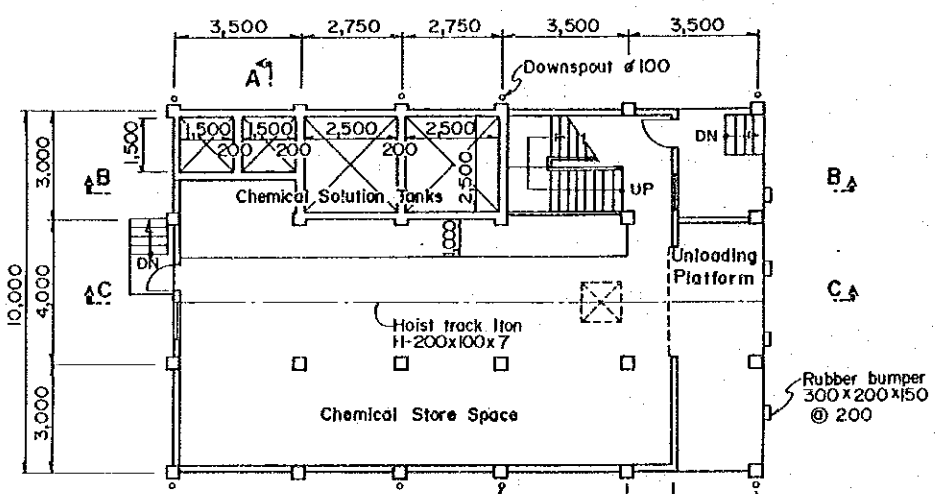

GROUND FLOOR PLAN

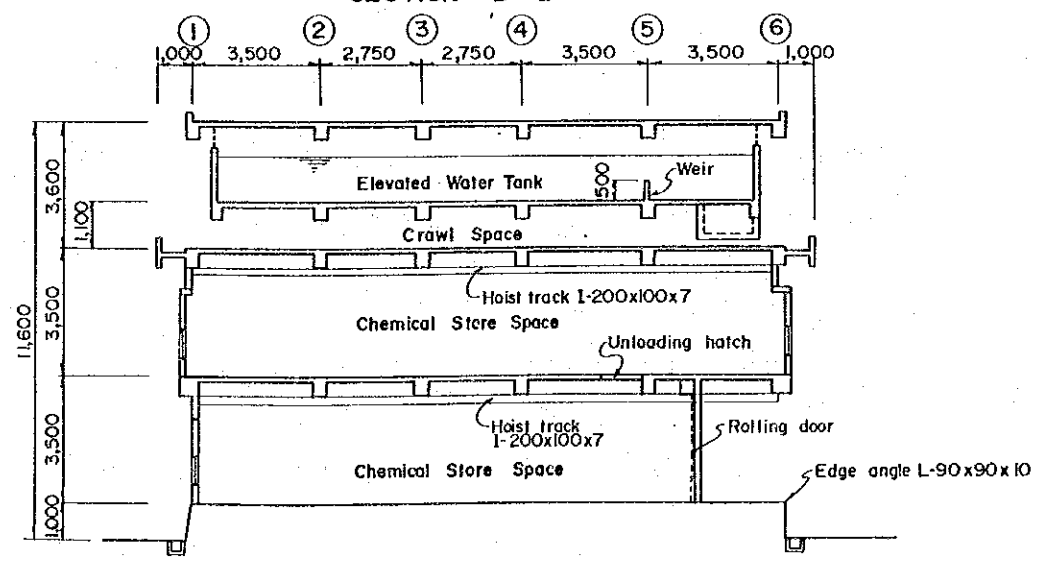

SECTION C-C SCALE A

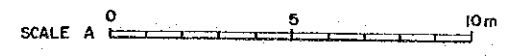

薬注棟

GOVERNMENT OF MAURITIUS
PORT LOUIS WATER SUPPLY PROJECT
JAPAN INTERNATIONAL COOPERATION AGENCY

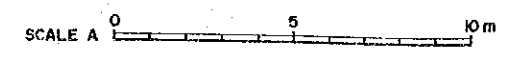
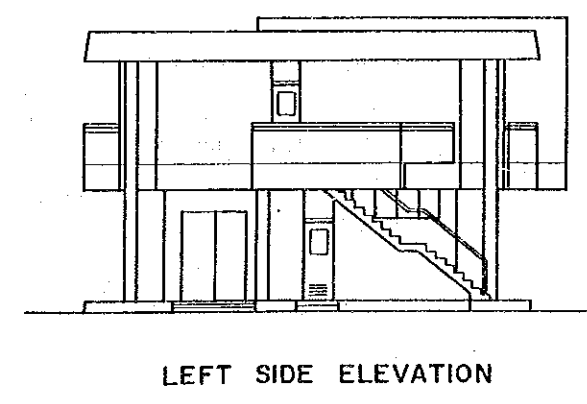
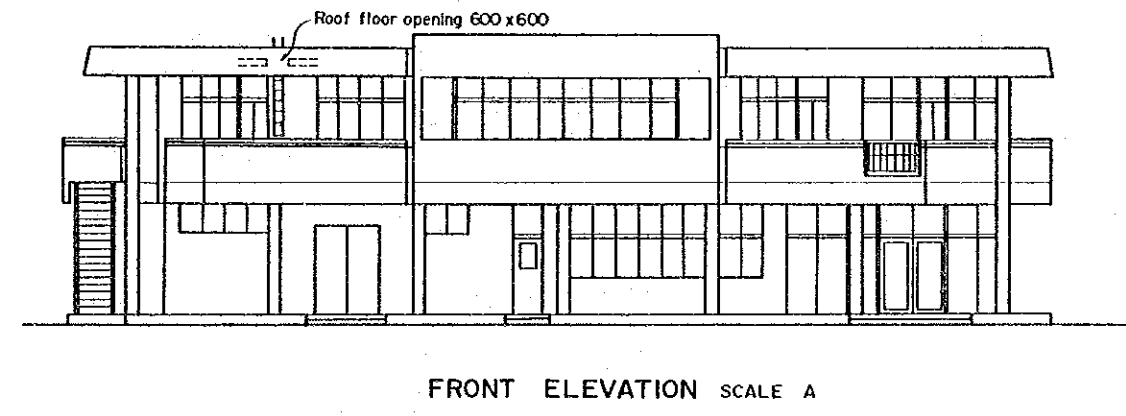
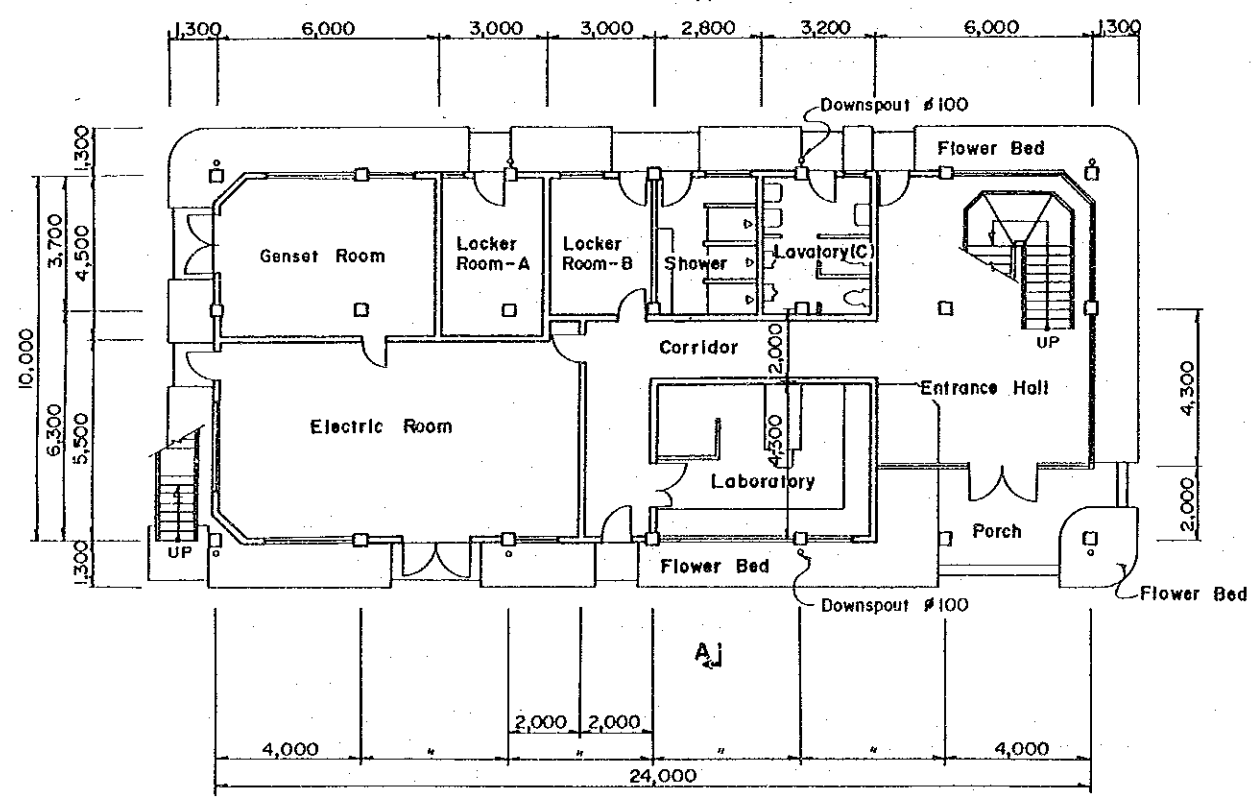
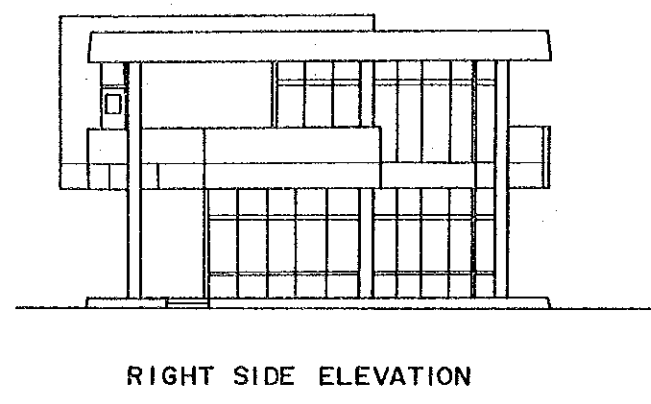
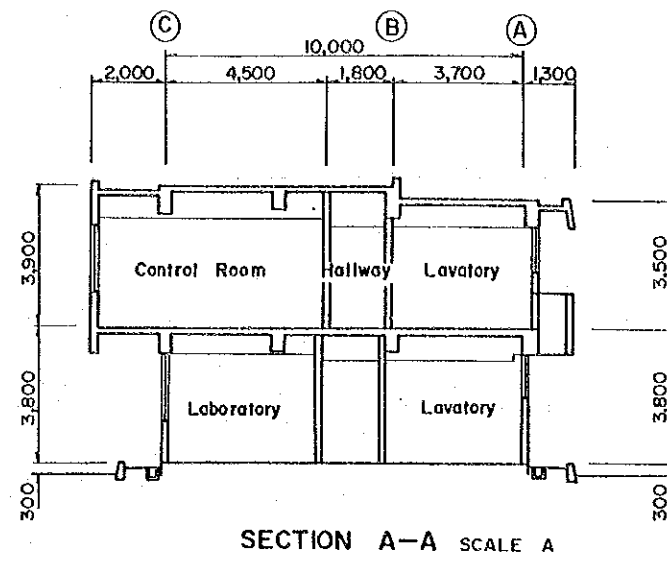
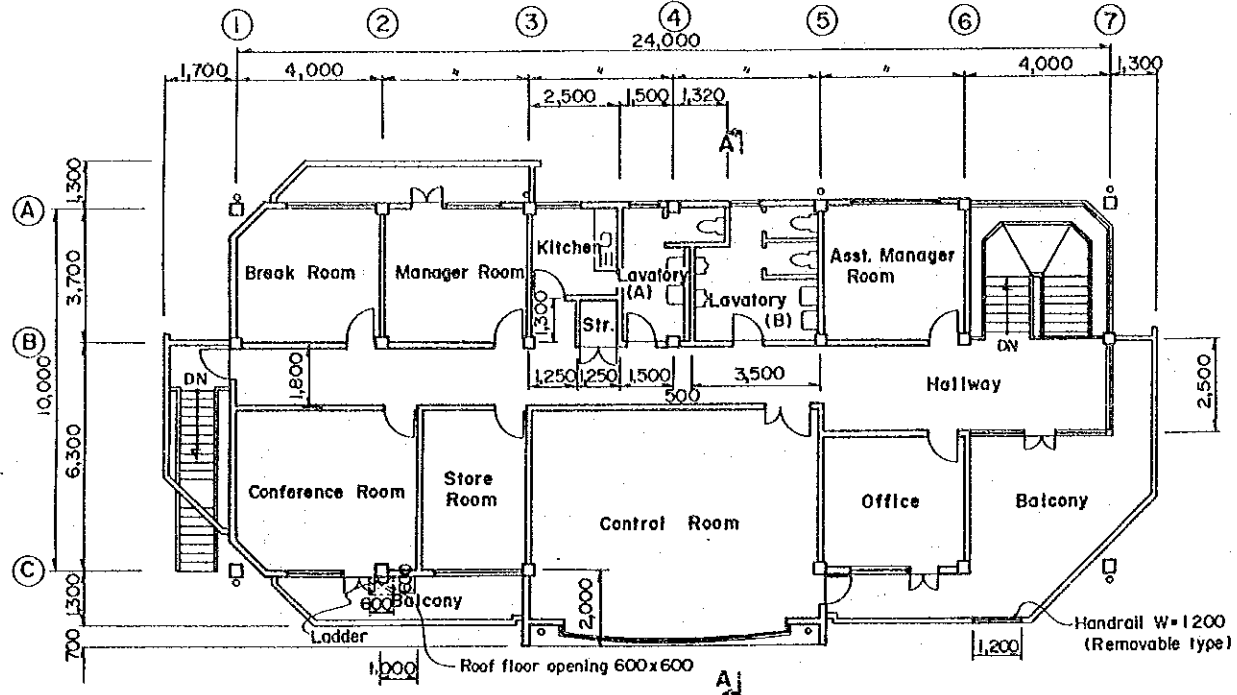

管理棟

GOVERNMENT OF MAURITIUS
PORT LOUIS WATER SUPPLY PROJECT
JAPAN INTERNATIONAL COOPERATION AGENCY

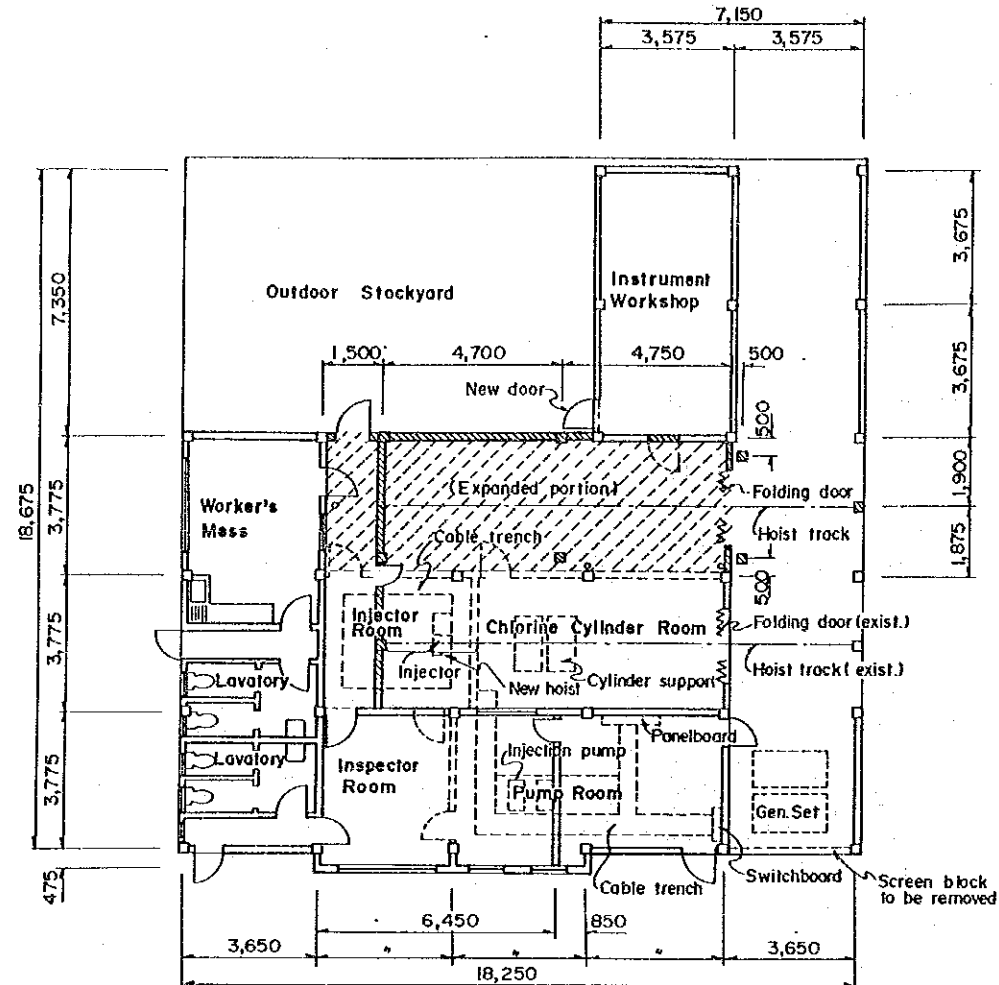

— Existing structure
 - - - Demolished structure
 // New structure
 Room names are existing ones

**GROUND FLOOR PLAN SCALE A
(EXISTING+MODIFIED)**

EXPANSION AND MODIFICATION

1. Building to be expanded on the portion indicated.
2. Existing walls to be demolished and new ones provided as indicated.
3. All equipment in injector room, chlorine cylinder room, and pump room to be removed including foundations, cables and associated fittings.
4. Cable trenches to be demolished and new ones constructed.
5. Function of rooms to be changed as indicated.
6. Existing door in instrument workshop to be closed and a new door provided at another place indicated.
7. Existing building structures and new ones to be separated by expansion joints.
8. Concrete to be over-laid flush with existing floor over existing concrete slab on expanded portion.
9. Electric power and controls to be provided newly from new panelboard and control panels.
10. Existing rain leaders at expanded portion to be conducted to outside drain ditch
11. Existing gensets to be removed and handed in to the employer.

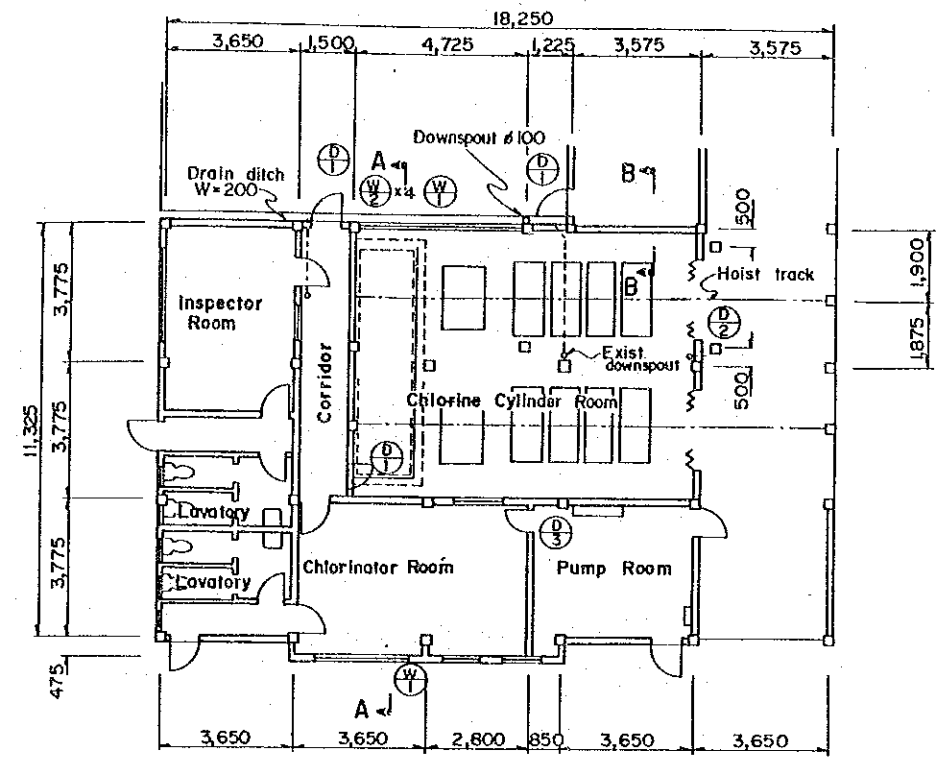
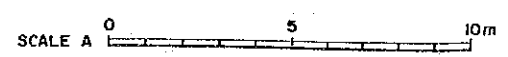

MODIFIED PLAN SCALE A

INTERIOR FINISHES

(Chlorine cylinder, injector, pump rooms, corridor)

FLOOR : Cement screed troweled
 BASE : Cement plaster, painted
 WALL : Cement plaster, painted
 CEILING : Exposed concrete, painted

EXTERIOR FINISHES

ROOF : Bituminous waterproofing
 PARAPET FASCIA : Cement plaster, painted
 WALL : Cement plaster, painted
 BASE : Cement plaster, painted

DOOR & WINDOW

	Steel flush door
	Cylinder lock, door check, lever handle
	Figured glass 4
	Oil point
	Steel folding door
	Door lock, guide tracks
	Oil point
	Jalousie window
	Handle
	Alumi louver
	Steel flush door
	Cylinder lock, lever handle, door check
	Figured glass 4
	Oil point

Note: Width of windows and height of doors shall be adjusted to structural and finish limitations.

塩素注入棟

GOVERNMENT OF MAURITIUS
 PORT LOUIS WATER SUPPLY PROJECT
 JAPAN INTERNATIONAL COOPERATION AGENCY

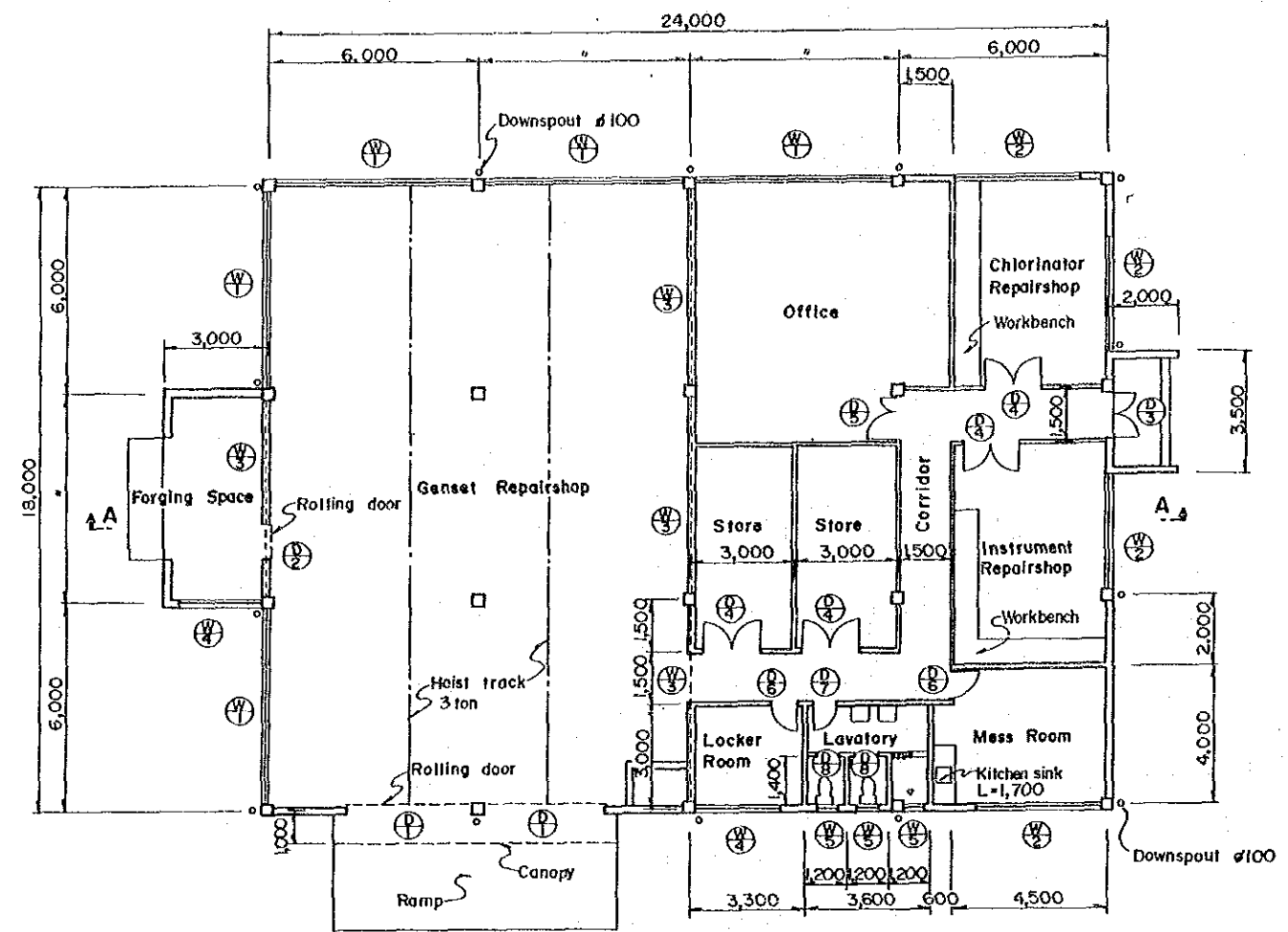

PLAN SCALE A

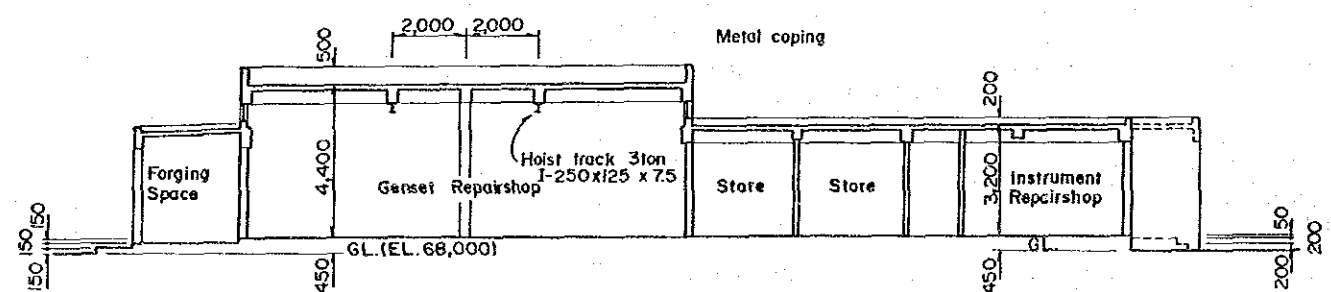

SECTION A - A SCALE A

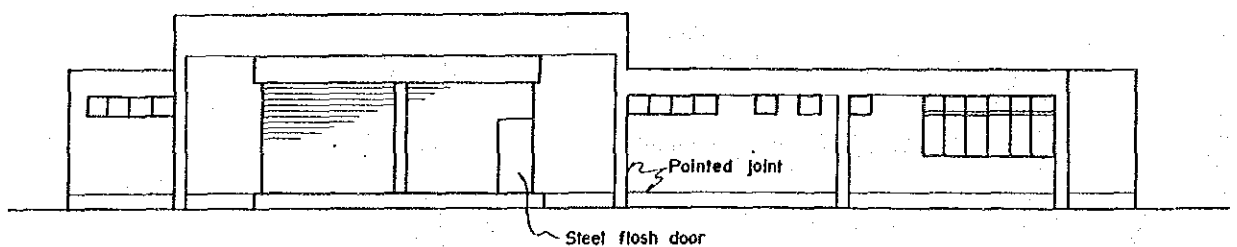

FRONT SIDE ELEVATION SCALE A

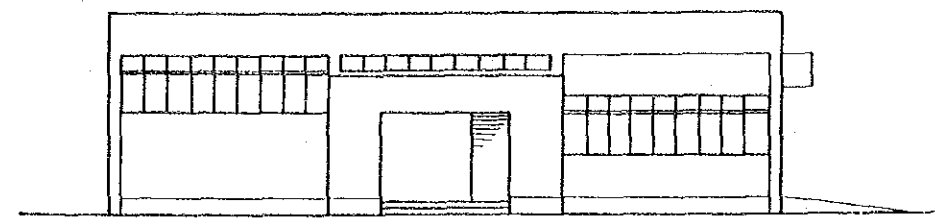

LEFT SIDE ELEVATION SCALE A

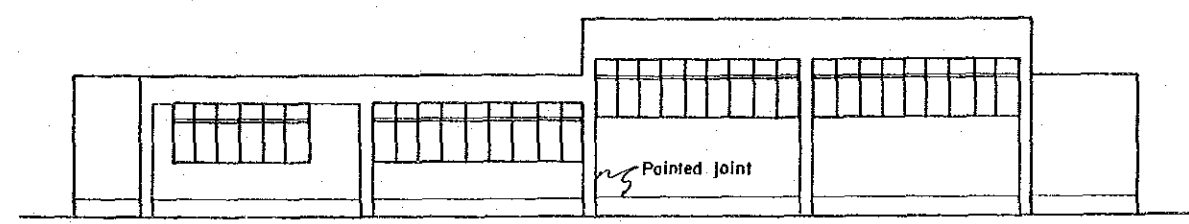

REAR SIDE ELEVATION SCALE A

INTERIOR FINISH SCHEDULE

ROOM	FLOOR	BASE	WALL	CEILING
Genset Repairshop	Cement screed, troweled	Cement plaster, painted	Cement plaster, painted	Exposed concrete, painted
Store	Do.	Do.	Do.	Do.
Chlorinator Repairshop	Do.	Do.	Do.	Do.
Instrument Repairshop	Do.	Do.	Do.	Do.
Office	Do.	Do.	Do.	Do.
Mess Room	Do.	Do.	Do.	Do.
Locker Room	Do.	Do.	Do.	Do.
Lavatory	Do.		Wall tile	Do.
Corridor	Do.	Cement plaster, painted	Cement plaster, painted	Do.

EXTERIOR FINISH SCHEDULE

PLACE	FINISH
Roof	Bituminous waterproofing
Wall	Cement plaster, painted
Base	Do.
Porch floor, ramp	Cement screed, troweled

工 作 棟

GOVERNMENT OF MAURITIUS
PORT LOUIS WATER SUPPLY PROJECT
JAPAN INTERNATIONAL COOPERATION AGENCY

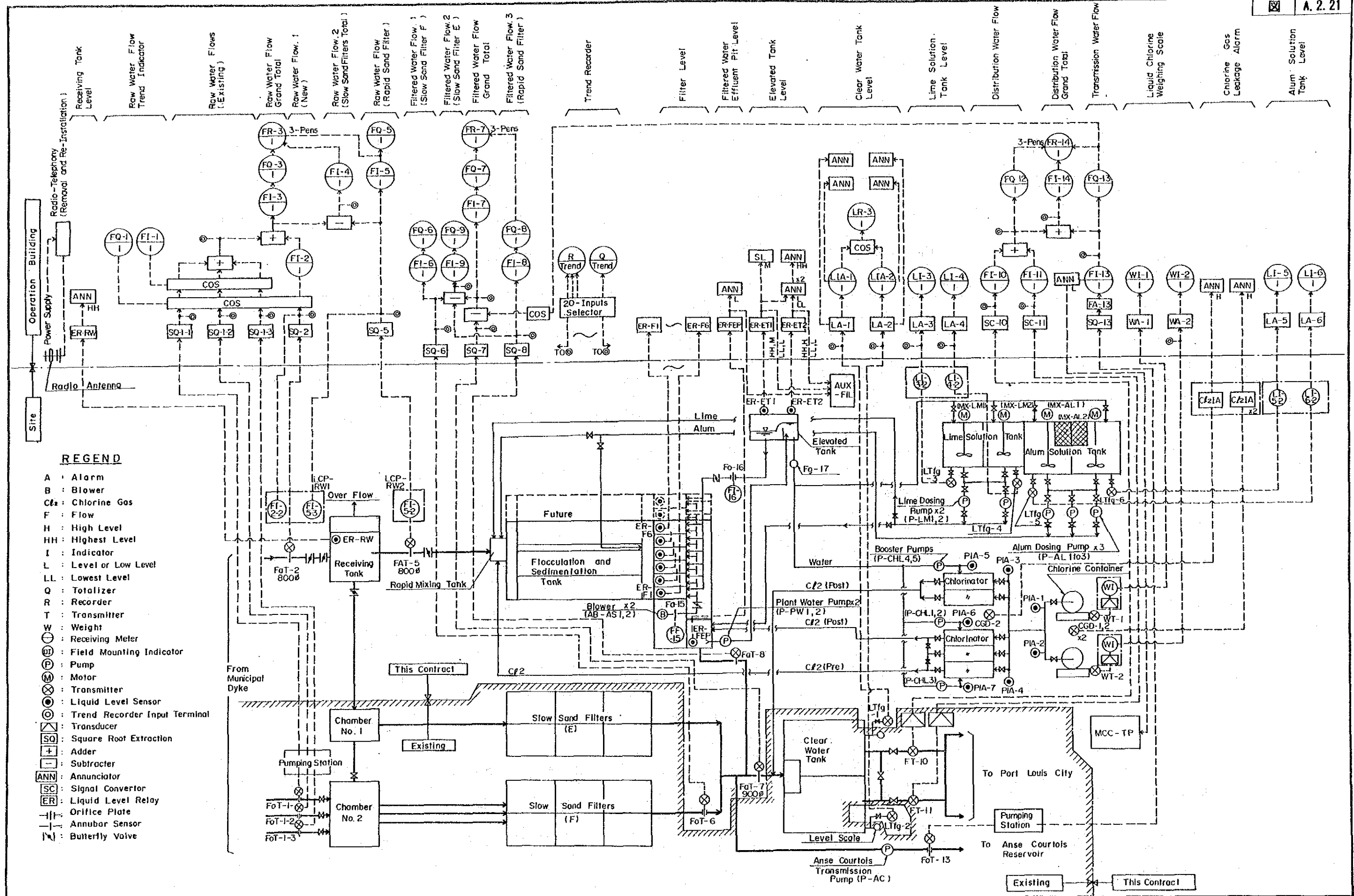

REGEND

- A : Alarm
- B : Blower
- C₂ : Chlorine Gas
- F : Flow
- H : High Level
- HH : Highest Level
- I : Indicator
- L : Level or Low Level
- LL : Lowest Level
- Q : Totalizer
- R : Recorder
- T : Transmitter
- W : Weight
- ⊖ : Receiving Meter
- ⊕ : Field Mounting Indicator
- ⊗ : Pump
- ⊙ : Motor
- ⊙ : Transmitter
- ⊙ : Liquid Level Sensor
- ⊙ : Trend Recorder Input Terminal
- ⊙ : Transducer
- ⊙ : Square Root Extraction
- ⊕ : Adder
- ⊖ : Subtractor
- ANN : Annunciator
- SC : Signal Converter
- ER : Liquid Level Relay
- ⊖ : Orifice Plate
- ⊖ : Annubar Sensor
- ⊖ : Butterfly Valve

NOT TO SCALE

計装フローシート

GOVERNMENT OF MAURITIUS
PORT LOUIS WATER SUPPLY PROJECT
JAPAN INTERNATIONAL COOPERATION AGENCY

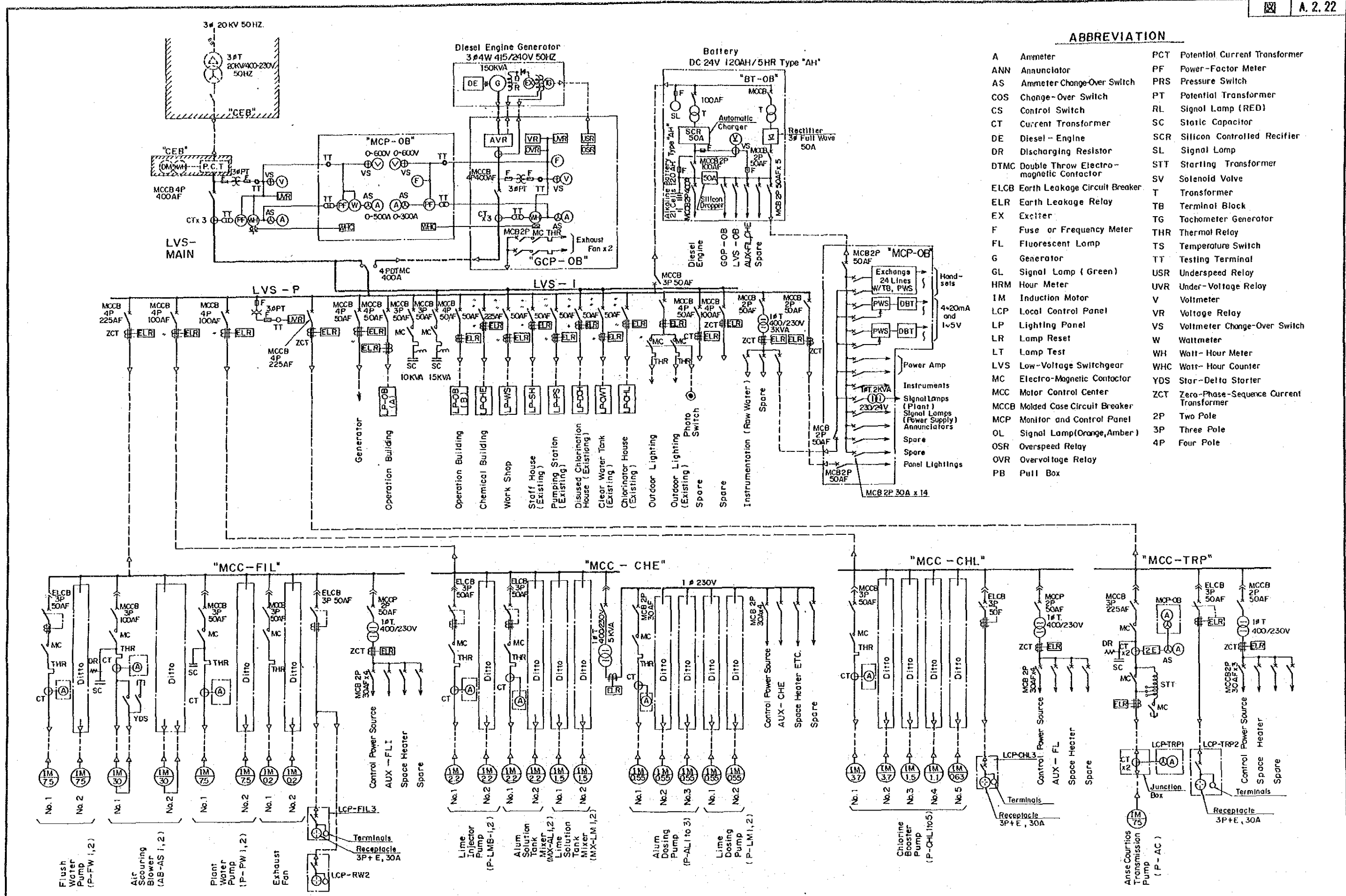

ABBREVIATION

A	Ammeter	PCT	Potential Current Transformer
ANN	Annunciator	PF	Power-Factor Meter
AS	Ammeter Change-Over Switch	PRS	Pressure Switch
COS	Change-Over Switch	PT	Potential Transformer
CS	Control Switch	RL	Signal Lamp (RED)
CT	Current Transformer	SC	Static Capacitor
DE	Diesel - Engine	SCR	Silicon Controlled Rectifier
DR	Discharging Resistor	SL	Signal Lamp
DTMC	Double Throw Electro-magnetic Contactor	STT	Starting Transformer
ELCB	Earth Leakage Circuit Breaker	SV	Solenoid Valve
ELR	Earth Leakage Relay	T	Transformer
EX	Exciter	TB	Terminal Block
F	Fuse or Frequency Meter	TG	Tachometer Generator
FL	Fluorescent Lamp	THR	Thermal Relay
G	Generator	TS	Temperature Switch
GL	Signal Lamp (Green)	TT	Testing Terminal
HRM	Hour Meter	USR	Underspeed Relay
IM	Induction Motor	UVR	Under-Voltage Relay
LCP	Local Control Panel	V	Voltmeter
LP	Lighting Panel	VR	Voltage Relay
LR	Lamp Reset	VS	Voltmeter Change-Over Switch
LT	Lamp Test	W	Wattmeter
LVS	Low-Voltage Switchgear	WH	Watt-Hour Meter
MC	Electro-Magnetic Contactor	WHC	Watt-Hour Counter
MCC	Motor Control Center	YDS	Star-Delta Starter
MCCB	Molded Case Circuit Breaker	ZCT	Zero-Phase-Sequence Current Transformer
MCP	Monitor and Control Panel	2P	Two Pole
OL	Signal Lamp (Orange, Amber)	3P	Three Pole
OSR	Overspeed Relay	4P	Four Pole
OVR	Overvoltage Relay		
PB	Pull Box		

NOT TO SCALE

單線結線圖

GOVERNMENT OF MAURITIUS
PORT LOUIS WATER SUPPLY PROJECT
JAPAN INTERNATIONAL COOPERATION AGENCY

付録3

水理計算

HYDRAULIC CALCULATION FOR PAILLES WATER TREATMENT WORKS EXPANSION

Treatment Capacity in Phase 2: 42,000 m³/day = 0.486 m³/sec
(Treatment Capacity in Phase 1: 31,500 m³/day = 0.365 m³/sec)

1. RECEIVING TANK TO RAPID MIXING TANK (RAW WATER PIPE 1 DN 800 mm)

Water Level at Receiving Tank + 70.800 m

Figures in parentheses are applied for Phase 1.

1.1 Friction Head Loss

(Phase 2)

$$h_1 = 10.666 \times q^{1.85} \times L / (C^{1.85} \times d^{4.87})$$

where, $q = 42,000 \text{ m}^3/\text{day} = 0.486 \text{ m}^3/\text{sec}$ (0.365 m³/sec)

$L = 141 \text{ m}$

$C = 130$

$d = 0.8 \text{ m}$

$$h_1 = 10.666 \times 0.486^{1.85} \times L / (130^{1.85} \times 0.8^{4.87}) \\ = \underline{0.144 \text{ m}}$$

(Phase 1)

$$h_1 = 10.666 \times 0.365^{1.85} \times L / (130^{1.85} \times 0.8^{4.87}) \\ = \underline{0.085 \text{ m}}$$

1.2 Head Loss of Valves and Fittings

(Phase 2)

$$h_2 = \sum f \times v^2 / 2g$$

where, Total head loss coefficient, $\sum f$

$$\sum f = f_1 + f_2 + f_3 + f_4 + f_5$$

$$= 5.2 \text{ (12.7)}$$

f1: Inlet, 0.5

f2: 90° bend x 2, $0.22 \times 2 = 0.44$

f3: 45° bend x 2, $0.08 \times 2 = 0.16$

f4: Butterfly valve, 3.1 (10.6)

f5: Outlet, 1.0

$$v = q / A = 0.486 / (\pi 0.8^2 / 4) \\ = 0.967 \text{ m/sec}$$

$$h_2 = 5.2 \times 0.967^2 / 2g \\ = \underline{0.248 \text{ m}}$$

(Phase 1)

$$v = 0.365 / (\pi 0.8^2 / 4) \\ = 0.726 \text{ m/sec}$$

$$h_2 = 12.7 \times 0.726^2 / 2g \\ = \underline{0.342 \text{ m}}$$

1.3 Head Loss of Flowmeter

(Phase 2)

$$h_3 = \underline{0.014 \text{ m}}$$

(Phase 1)

$$h_3 = \underline{0.014 \text{ m}}$$

Water Level at Rapid Mixing Tank

(Phase 2)

$$+ 70.800 - (h_1 + h_2 + h_3) = \\ + 70.800 - (0.144 + 0.248 + 0.014) = \quad \quad \quad \underline{+ 70.394 \text{ m}}$$

(Phase 1)

$$+ 70.800 - (h_1 + h_2 + h_3) = \\ + 70.800 - (0.085 + 0.342 + 0.014) = \quad \quad \quad \underline{+ 70.359 \text{ m}}$$

2. RAPID MIXING, FLOCCULATION AND SEDIMENTATION TANK

2.1 Rapid Mixing Tank

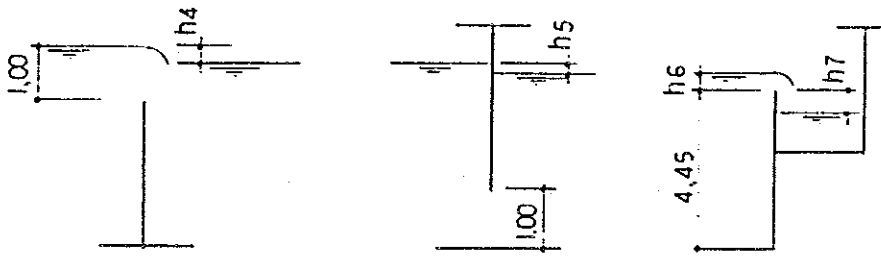
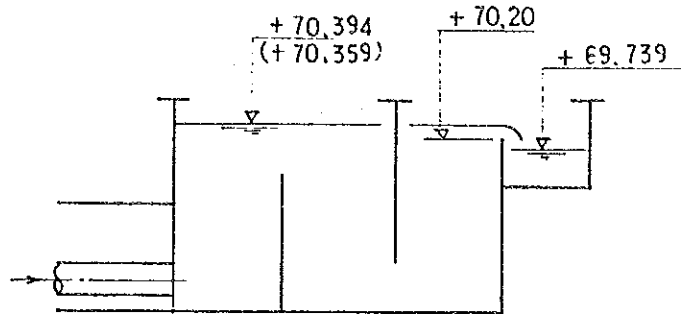

(Phase 2)

$$h_4 = f_4 \times v^2 / 2g$$

$$= 2.45 \times 0.152^2 / 2g = \underline{0.003 \text{ m}}$$

$$v = 0.486 / (3.2 \times 1.0) = 0.152 \text{ m/sec}, f_4 = 2.45$$

(Phase 1)

$$h_4 = 2.45 \times 0.119^2 / 2g = \underline{0.002 \text{ m}}$$

$$v = 0.365 / (3.2 \times 0.96) = 0.119 \text{ m/sec}, f_4 = 2.45$$

(Phase 2)

$$\begin{aligned} h_5 &= f_5 \times v^2 / 2g \\ &= 2.80 \times 0.152^2 / 2g = \underline{0.003 \text{ m}} \end{aligned}$$

$$v = 0.152 \text{ m/sec}, f_5 = 2.80$$

(Phase 1)

$$h_5 = 2.80 \times 0.114^2 / 2g = \underline{0.002 \text{ m}}$$

$$v = 0.365 / (3.2 \times 1.0) = 0.114 \text{ m/sec}, f_5 = 2.80$$

(Phase 2)

$$\begin{aligned} h_6 &= (q / cb)^{2/3} \\ &= (0.486 / 1.859 \times 3.2)^{2/3} = \underline{0.188 \text{ m}} \end{aligned}$$

where,

$$q = 0.486 \text{ m}^3/\text{sec}$$

$$c = 1.785 + (0.00295 / h + 0.237 \times h / w) (1 + e) = 1.859$$

$$w = 4.45 \text{ m}, e = 1.898, b = 3.2 \text{ m}$$

(Phase 1)

$$h_6 = (0.365 / 1.864 \times 3.2)^{2/3} = \underline{0.155 \text{ m}}$$

where,

$$q = 0.365 \text{ m}^3/\text{sec}$$

$$c = 1.864$$

$$w = 4.45 \text{ m}, e = 1.898, b = 3.2 \text{ m}$$

(Phase 2)

$$h_7 = \underline{0.461 \text{ m}}$$

(Phase 1)

$$h_7 = \underline{0.461 \text{ m}}$$

2.2 Inlet Gate of Flocculation Tank

Flow rate per tank: $10,500 \text{ m}^3/\text{day} = 0.122 \text{ m}^3/\text{sec}$

$$h_8 = v^2 / (c^2 2g) = 0.488^2 / (0.6^2 \times 2g) \\ = \underline{0.034 \text{ m}}$$

$$v = 0.122 / (0.5 \times 0.5) = 0.488 \text{ m/sec}$$

2.3 Flocculation Tank

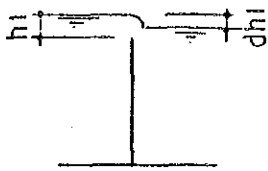

Overflow baffle

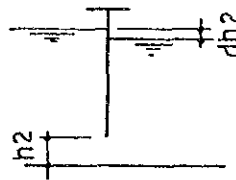

Submerged baffle

1st & 2nd compartments

Width of channel, $b = 0.80 \text{ m}$

Overflow baffle

$$\begin{aligned} \text{Number of baffles, } n &= 5 \\ dh_1 &= f_1 \times v_1^2 / 2g \times n \\ &= 2.45 \times 0.436^2 / 19.6 \times 5 \\ &= 0.119 \text{ m} \\ v_1 &= Q / (b \times h_1) \\ &= 0.122 / (0.8 \times 0.35) \\ &= 0.436 \text{ m/s} \end{aligned}$$

Submerged baffle

$$\begin{aligned} \text{Number of baffles, } n &= 5 \\ dh_2 &= f_2 \times v_2^2 / 2g \times n \\ &= 2.80 \times 0.381^2 / 19.6 \times 5 \\ &= 0.104 \text{ m} \\ v_2 &= Q / (b \times h_2) \\ &= 0.122 / (0.8 \times 0.4) \\ &= 0.381 \text{ m/s} \end{aligned}$$

$$\begin{aligned} G &= (Gh / ut)^{1/2} = 80 \text{ sec}^{-1} \\ \text{where, } g &= 980 \text{ cm/sec}^2 \\ h &= dh_1 + dh_2 = 22.3 \text{ cm} \\ u &= 0.898 \times 10^{-2} \text{ cm}^2/\text{sec} \\ t &= 377 \text{ sec} \end{aligned}$$

3rd & 4th compartments

Width of channel, $b = 1.00$ m

Overflow baffle

$$\begin{aligned} \text{Number of baffles, } n &= 5 \\ dh1 &= f1 \times v1^2 / 2g \times n \\ &= 2.45 \times 0.305^2 / 19.6 \times 5 \\ &= 0.058 \text{ m} \\ v1 &= Q / (b \times h1) \\ &= 0.122 / (1.0 \times 0.40) \\ &= 0.305 \text{ m/s} \end{aligned}$$

Submerged baffle

$$\begin{aligned} \text{Number of baffles, } n &= 5 \\ dh2 &= f2 \times v2^2 / 2g \times n \\ &= 2.80 \times 0.244^2 / 19.6 \times 5 \\ &= 0.043 \text{ m} \\ v2 &= Q / (b \times h2) \\ &= 0.122 / (1.0 \times 0.5) \\ &= 0.244 \text{ m/s} \end{aligned}$$

$$G = (Gh / ut)^{1/2} = 52 \text{ sec}^{-1}$$

$$\text{where, } g = 980 \text{ cm/sec}^2$$

$$h = dh1 + dh2 = 10.1 \text{ cm}$$

$$u = 0.898 \times 10^{-2} \text{ cm}^2/\text{sec}$$

$$t = 404 \text{ sec}$$

5th & 6th compartments

Width of channel, $b = 1.40$ m

Overflow baffle

$$\begin{aligned} \text{Number of baffles, } n &= 5 \\ dh1 &= f1 \times v1^2 / 2g \times n \\ &= 2.45 \times 0.124^2 / 19.6 \times 5 \\ &= 0.0096 \text{ m} \\ v1 &= Q / (b \times h1) \\ &= 0.122 / (1.4 \times 0.7) \\ &= 0.124 \text{ m/s} \end{aligned}$$

Submerged baffle

$$\begin{aligned} \text{Number of baffles, } n &= 5 \\ dh2 &= f2 \times v2^2 / 2g \times n \\ &= 2.80 \times 0.109^2 / 19.6 \times 5 \\ &= 0.0084 \text{ m} \\ v2 &= Q / (b \times h2) \\ &= 0.122 / (1.4 \times 0.8) \\ &= 0.109 \text{ m/s} \end{aligned}$$

$$G = (Gh / ut)^{1/2} = 20 \text{ sec}^{-1}$$

$$\text{where, } g = 980 \text{ cm/sec}^2$$

$$h = dh1 + dh2 = 1.8 \text{ cm}$$

$$u = 0.898 \times 10^{-2} \text{ cm}^2/\text{sec}$$

$$t = 498 \text{ sec}$$

$$\begin{aligned} h9 &= 0.119 + 0.104 + 0.058 + 0.043 + 0.0096 + 0.0084 \\ &= \underline{0.342 \text{ m}} \end{aligned}$$

2.4 Submerged Weir

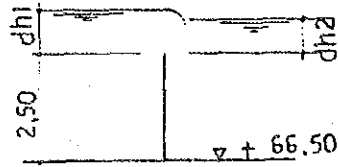

$$h_{10} = dh_1 - dh_2$$

$$dh_2 = (1 - (q / q_0)^{2.6})^{1/1.5} \times dh_1$$

$$q_0 = cbh^{3/2} = 3.885 \text{ m}^3/\text{sec}$$

$$\text{where, } c = 1.862, b = 9.60 \text{ m, } dh_1 = 0.3615 \text{ m}$$

$$dh_2 = (1 - (0.122 / 3.885)^{2.6})^{1/1.5} \times 0.3615 = 0.3615 \text{ m}$$

$$h_{10} = 0.3615 - 0.3615 = \underline{0.000 \text{ m}}$$

2.5 Perforated Wall

$$h_{11} = v^2 / (c^2 2g) = 0.064^2 / (0.6^2 \times 2g) \\ = \underline{0.001 \text{ m}}$$

$$v = 0.122 / (\pi/4 \times 0.10^2 \times 243) = 0.064 \text{ m/sec}$$

Water Level at Sedimentation Tank:

$$+ 70.394 - (h_4 + h_5 + h_6 + h_7 + h_8 + h_9 + h_{10} + h_{11}) = \\ + 70.394 - (0.003 + 0.003 + 0.188 + 0.461 + 0.034 + 0.342 + \\ 0.000 + 0.001) = \underline{+ 69.362 \text{ m}}$$

3. SEDIMENTATION TANK - FILTER

3.1 Perforated Wall

$$h_{12} = v^2 / (c^2 2g) = 0.072^2 / (0.6^2 \times 2g) \\ = \underline{0.001 \text{ m}}$$

$$v = 0.122 / (\pi/4 \times 0.10^2 \times 216) = 0.072 \text{ m/sec}$$

3.2 Effluent Trough

$$h_c = (\alpha q^2 / gb^2)^{1/3}$$

$$h_u = 3^{1/2} \times h_c$$

where, h_c : Critical depth

q : Flow rate per trough, $q = 0.122 / 6 = 0.0203 \text{ m}^3/\text{sec}$

α : Coefficient, 1.1

h_u : Water depth of upper end

h_o : Orifice head loss

$$h_c = (1.1 \times 0.0203^2 / g \times 0.25^2)^{1/3} = 0.090 \text{ m}$$

$$h_u = 3^{1/2} \times 0.09 = 0.156 \text{ m}$$

$$h_o = 1 / (0.6^2 \times 2g) \times \{(0.0203 / (\pi/4 \times 0.03^2 \times 19 \times 2))\}^2$$

$$= 0.081 \text{ m}$$

$$h_{13} = 0.156 + 0.044 + 0.081 = \underline{0.281 \text{ m}}$$

$$h_{14} = \underline{0.151 \text{ m}}$$

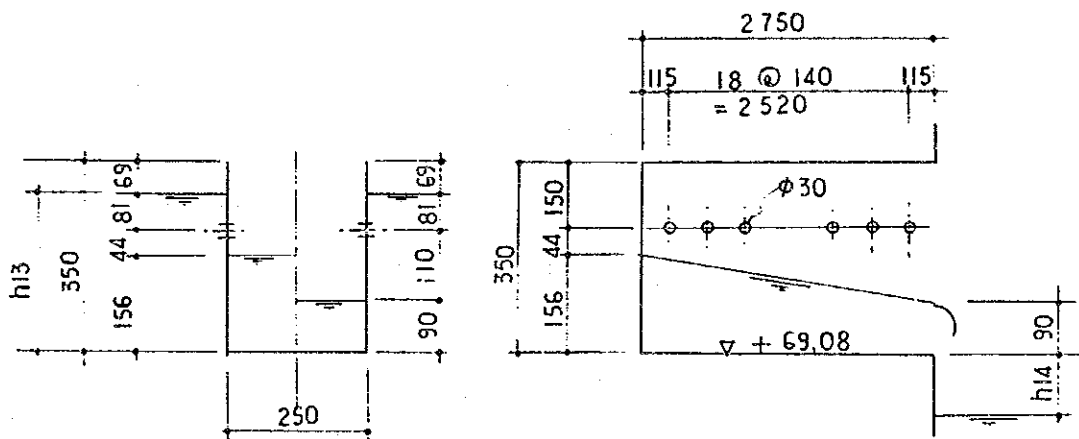

3.3 Inlet Opening

$$h_{15} = (1 + f_e) \times v^2 / 2g$$

$$= (1 + 0.5) \times 0.199^2 / 2g = \underline{0.003 \text{ m}}$$

$$v = 0.122 / (0.5 \times 1.226) = 0.199 \text{ m/sec}$$

3.4 Filter Inlet Gate

Flow rate per filter: 5,250 m³/day = 0.061 m³/sec

$$h_{16} = v^2 / (c^2 2g) = 0.498^2 / (0.6^2 \times 2g)$$

$$= \underline{0.035 \text{ m}}$$

$$v = 0.061 / (0.35 \times 0.35) = 0.498 \text{ m/sec}$$

3.5 Inlet Weir

$$h_{17} = (q / c_b)^{2/3}$$

$$= (0.061 / 1.84 \times 1.2)^{2/3} = \underline{0.091 \text{ m}}$$

$$h_{18} = \underline{0.068 \text{ m}}$$

3.6 Inlet Pipe

$$h_{19} = (124.5n^2 / d^{1/3} \times l / d + f_i + f_o) \times v^2 / 2g$$

$$= (124.5 \times 0.012^2 / 0.35^{1/3} \times 0.675 / 0.35 +$$

$$0.5 + 1.0) \times 0.634^2 / 2g$$

$$= \underline{0.032 \text{ m}}$$

$$v = 0.061 / (\pi/4 \times 0.35^2) = 0.634 \text{ m/sec}$$

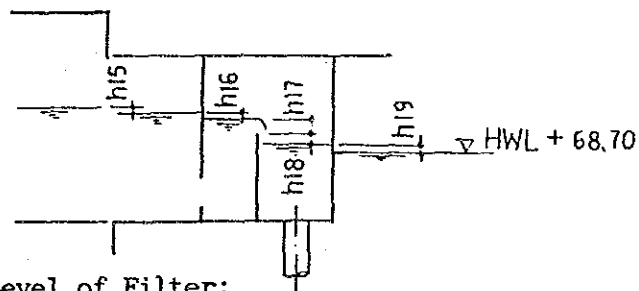

High Water Level of Filter:

$$+ 69.362 - (h_{12} + h_{13} + h_{14} + h_{15} + h_{16} + h_{17} + h_{18} + h_{19}) =$$

$$+ 69.362 - (0.001 + 0.281 + 0.151 + 0.003 + 0.035 + 0.091 +$$

$$0.068 + 0.032) = \underline{+ 68.700 \text{ m}}$$

4. FILTRATION

4.1 Filter Sand

$$h_s = 0.178 \times C_d/g \times v^2/e^4 \times \alpha/\beta \times 1/D \times L$$

where, $C_d = 24/Re + 2/Re^{1/2} + 0.34$, ($Re > 1$)

$$C_d = 24/Re, (Re < 1)$$

v : Filtration rate, 140 m/day = 1.62×10^{-3} m/sec

e : Porosity of sand layer, 0.45

$$\alpha/\beta: 5.5$$

D : Effective size of sand, 1.0×10^{-3} m

L : Thickness of sand layer, 1.10 m

$$Re = \rho f \times D \times v / \mu$$

$$= 997.1 \times 1.0 \times 10^{-3} \times (1.62 \times 10^{-3}) / 0.898 \times 10^{-3}$$

$$= 1.80 > 1$$

where, ρf : Specific gravity of water, 997.1 kg/m³

μ : Coefficient of viscosity, 0.898×10^{-3} kg/sec

$$C_d = 24/Re + 2/Re^{1/2} + 0.34 = 15.16$$

$$h_s = 0.178 \times 15.16 / 9.8 \times (1.62 \times 10^{-3})^2 / 0.45^4 \times 5.5 \times 1 / (1.0 \times 10^{-3}) \times 1.1 = 0.107 \text{ m}$$

4.2 Filter Gravel

$$Re = 997.1 \times 4.0 \times 10^{-3} \times (1.62 \times 10^{-3}) / 0.898 \times 10^{-3}$$
$$= 7.2 > 1$$

$$C_d = 24/Re + 2/Re^{1/2} + 0.34 = 4.4$$

$$h_g = 0.178 \times 4.4 / 9.8 \times (1.62 \times 10^{-3})^2 / 0.40^4 \times 5.5 \times 1 / (4.0 \times 10^{-3}) \times 0.1 = 0.001 \text{ m}$$

4.3 Underdrain

$$h_u = v^2 / (c^2 2g) = 0.078^2 / (0.6^2 \times 2g)$$
$$= \underline{0.001 \text{ m}}$$

$$v = 0.061 / (0.00063 \times 1,248) = 0.078 \text{ m/sec}$$

$$\text{Area of nozzle: } 0.00025 \text{ m} \times 0.035 \text{ m} \times 72 \text{ nos.} = 0.00063 \text{ m}^2$$

No. of nozzles: $48 \times 26 = 1,248$

Opening ratio: $0.00063 \times 1,248 / (9.600 \times 3.900) = 0.021 = 2.1 \%$

4.4 Distribution Orifice

$$h_o = 0.272^2 / (0.6^2 \times 2g) \\ = \underline{0.010 \text{ m}}$$

$$v = 0.061 / (0.014 \times 16) = 0.272 \text{ m/sec}$$

Area of orifice: $0.185 \times 0.075 = 0.014 \text{ m}^2$
No. of orifice : 16

4.5 Outlet Pipe (DN 350 mm)

$$h_p = (0.025 \times 4.300 / 0.35 + 0.5 + 0.5 + 1.0) \times 0.63^2 / 2g \\ = 0.047 \text{ m}$$

$$v = 0.061 / (\pi/4 \times 0.35^2) = 0.63 \text{ m/sec}$$

$$h_s + h_g + h_u + h_o + h_p = \\ 0.107 + 0.001 + 0.001 + 0.010 + 0.047 = 0.166 \text{ m}$$

Total head loss of filter h_{20} is employed at 1.2 m.

Clogging loss of filter is therefore about 1.03 m.

$$h_{20} = \underline{1.200 \text{ m}}$$

Low Water Level of Filter:

$$+68.700 - 1.200 = \underline{+67.500 \text{ m}}$$

4.6 Filtered Water Effluent Weir

$$h_{21} = (q / cb)^{2/3} \\ = (0.486 / 1.852 \times 2.0)^{2/3} = \underline{0.260 \text{ m}}$$

where,

$$q = 0.486 \text{ m}^3/\text{sec}$$

$$c = 1.785 + (0.00295 / h + 0.237 \times h / w)(1 + e) = 1.852$$

$$w = 2.98 \text{ m}, e = 1.089, b = 2.0 \text{ m}$$

$h_{22} = 0.368 \text{ m}$

Water Level at Effluent Weir:

$+ 67.500 - (\text{Filtration loss} + h_{21} + h_{22}) = + 66.712 \text{ m}$

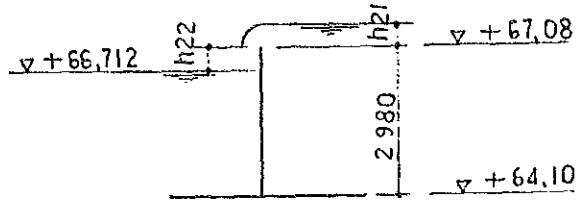

5. FILTERED WATER EFFLUENT WEIR - EXISTING CLEAR WATER TANK

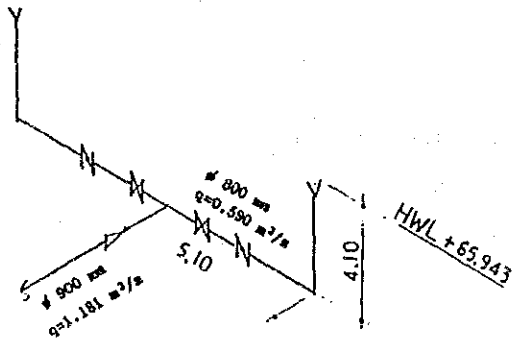
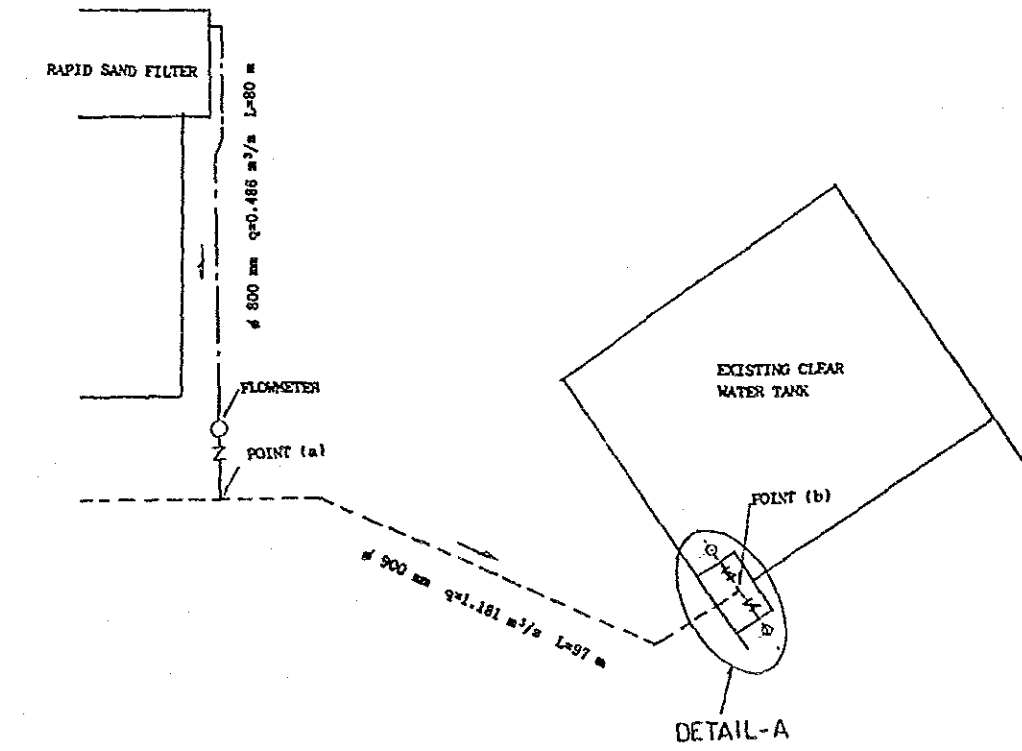

DETAIL - A

5.1 Effluent Weir - Point (a)

5.1.1 Friction Loss

$$h_{23} = 10.666 \times q^{1.85} \times L / (C^{1.85} \times d^{4.87})$$

$$\text{where, } q = 42,000 \text{ m}^3/\text{day} = 0.486 \text{ m}^3/\text{sec}$$

$$L = 80 \text{ m}$$

$$C = 130$$

$$d = 0.8 \text{ m}$$

$$h_{23} = 10.666 \times 0.486^{1.85} \times L / (130^{1.85} \times 0.8^{4.87}) \\ = \underline{0.082 \text{ m}}$$

5.1.2 Head Loss of Valves and Fittings

$$h_{24} = (f_1 + f_2 + f_3 + f_4) \times v^2 / 2g$$

$$f_1: \text{Inlet, } 0.5$$

$$f_2: 90^\circ \text{ bend } \times 1, 0.22$$

$$f_3: 22.5^\circ \text{ bend } \times 2, 0.03 \times 2 = 0.06$$

$$f_4: \text{Butterfly valve, } 0.3$$

$$v = q / A = 0.486 / (\pi \times 0.8^2 / 4) = 0.967 \text{ m/sec}$$

$$h_{24} = (0.5 + 0.22 + 0.06 + 0.3) \times 0.967^2 / 2g \\ = \underline{0.052 \text{ m}}$$

5.1.3 Head Loss of Flowmeter

$$h_{25} = \underline{0.014 \text{ m}}$$

5.1.4 Head Loss of Tee (Combining flow)

$$h_{26} = f \times v^2 / 2g$$

$$f = 0.26$$

$$v = q / A = 1.181 / (\pi \times 0.9^2 / 4)$$

$$= 1.856 \text{ m/sec}$$

$$q = 42,000 + 60,000 = 102,000 \text{ m}^3/\text{day} = 1.181 \text{ m}^3/\text{sec}$$

$$h_{26} = 0.26 \times 1.856^2 / 2g = \underline{0.046 \text{ m}}$$

5.2 Point (a) - Point (b)

5.2.1 Friction Loss

$$h_{27} = 10.666 \times q^{1.85} \times L / (C^{1.85} \times d^{4.87})$$

where, $q = 102,000 \text{ m}^3/\text{day} = 1.181 \text{ m}^3/\text{sec}$

$L = 97 \text{ m}$

$C = 130$

$d = 0.9 \text{ m}$

$$\begin{aligned} h_{27} &= 10.666 \times 1.181^{1.85} \times L / (130^{1.85} \times 0.9^{4.87}) \\ &= \underline{0.289 \text{ m}} \end{aligned}$$

5.2.2 Head Loss of Fittings

$$h_{28} = (f_1 + f_2 + f_3) \times v^2 / 2g$$

f_1 : 22.5° bend x 1, 0.03

f_2 : 11.25° bend x 1, 0.02

f_3 : 45° bend x 1, 0.09

$v = q / A = 1.181 / (\pi 0.9^2 / 4) = 1.856 \text{ m/sec}$

$$\begin{aligned} h_{28} &= (0.03 + 0.02 + 0.09) \times 1.856^2 / 2g \\ &= \underline{0.025 \text{ m}} \end{aligned}$$

5.3 Point (b) - Existing Clear Water Tank

5.3.1 Friction Loss

$$h_{29} = 10.666 \times q^{1.85} \times L / (C^{1.85} \times d^{4.87})$$

where, $q = 0.590 \text{ m}^3/\text{sec}$

$L = 9.2 \text{ m}$

$C = 130$

$d = 0.8 \text{ m}$

$$\begin{aligned} h_{29} &= 10.666 \times 0.590^{1.85} \times L / (130^{1.85} \times 0.8^{4.87}) \\ &= \underline{0.013 \text{ m}} \end{aligned}$$

5.3.2 Head Loss of Tee (Dividing flow)

$$h_{30} = h_b + h_{se}$$

$$h_b = 0.99 \times 1.174^2 / 2g = 0.070 \text{ m}$$

$$v = 0.590 / (\pi 0.8^2 / 4) = 1.174 \text{ m/sec}$$

$$h_{se} = (v_1 - v_2)^2 / 2g = (2.348 - 1.174)^2 / 2g$$

$$= 0.070 \text{ m}$$

$$v_1 = 1.181 / (\pi 0.8^2 / 4) = 2.350 \text{ m/sec}$$

$$v_2 = 0.590 / (\pi 0.8^2 / 4) = 1.174 \text{ m/sec}$$

$$h_{se} = (2.350 - 1.174)^2 / 2g = 0.071 \text{ m}$$

$$h_{30} = 0.070 + 0.071 = \underline{0.141 \text{ m}}$$

5.3.3 Head Loss of Valves and Fittings

$$h_{3i} = (f_1 + f_2 + f_3) \times v^2 / 2g$$

f1: Butterfly valve, 0.3

f2: 90° bend x 1, 0.22

f3: Outlet, 1.0

$$v = 0.590 / (\pi 0.8^2 / 4) = 1.174 \text{ m/sec}$$

$$h_{3i} = (0.3 + 0.22 + 1.0) \times 1.174^2 / 2g = \underline{0.107 \text{ m}}$$

High Water Level of Clear Water Tank:

$$+ 66.712 - \left(\sum_{n=23}^{51} h_n \right) = + 66.712 - 0.769 = \underline{+ 65.943 \text{ m}}$$

付録4

表	5.1	運転・維持管理費
表	5.2	財務諸表
表	5.3	収入内訳
図	5.1	建設機械配分計画
図	5.2	建設工程計画

表5.1 運転/維持管理費

Year	Treatment Capacity		Operation and Maintenance Costs (MRs. 1,000)				
	daily	Q(yearly)	Chemical	Power	Personnel	Maintenance	Total
	m3/d	m3/y x 1,000					
1							
2							
3							
4	12,310	4,493	891	214	2,059	155	3,319
5	12,170	4,442	881	212	2,059	155	3,307
6	12,020	4,387	870	209	2,059	155	3,293
7	11,880	4,336	860	207	2,059	155	3,281
8	11,740	4,285	850	204	2,059	155	3,268
9	12,540	4,577	908	218	2,059	155	3,340
10	13,350	4,873	966	233	2,059	155	3,413
11	14,150	5,165	1,024	247	2,059	155	3,485
12	14,960	5,460	1,083	261	2,059	155	3,558
13	15,770	5,756	1,141	275	2,059	155	3,630
14	16,520	6,030	1,196	288	2,059	155	3,698
15	17,260	6,300	1,249	301	2,059	155	3,764
16	18,010	6,574	1,304	314	2,059	155	3,832
17	18,750	6,844	1,357	327	2,059	155	3,898
18	19,500	7,118	1,412	340	2,059	155	3,966
19	19,710	7,194	1,427	344	2,059	155	3,985
20	19,920	7,271	1,442	347	2,059	155	4,003
21	20,130	7,347	1,457	351	2,059	155	4,022
22	20,340	7,424	1,472	355	2,059	155	4,041
23	20,550	7,501	1,488	358	2,059	155	4,060
24	20,760	7,577	1,503	362	2,059	155	4,079
25	20,970	7,654	1,518	366	2,059	155	4,098
26	21,190	7,734	1,534	369	2,059	155	4,117
27	21,390	7,807	1,548	373	2,059	155	4,135
28	21,600	7,884	1,564	377	2,059	155	4,155
29	21,810	7,961	1,579	380	2,059	155	4,173
30	22,020	8,037	1,594	384	2,059	155	4,192
31	22,230	8,114	1,609	388	2,059	155	4,211
32	22,440	8,191	1,624	391	2,059	155	4,229
33	22,650	8,267	1,640	395	2,059	155	4,249

Note: O/M costs are estimated by the following manner:

1) Chemical and power costs

$$C = Q + (31,500 \text{ m}^3/\text{d} \times 365 \text{ days}) \times A$$

where; Q: average yearly treatment capacity

A: annual costs for max. treatment capacity

2) Personnel and maintenance costs are not proportionated to changing of the treatment capacity.

表5.2 財務諸表

(Unit: MRs. x 1,000)

Year	Capital Investment	O&M Cost	Loan Payment		Total Outgo	Revenue	Balance	Accumulate Surplus
			Capital	Interest				
1	23,400				23,400		-23,400	-23,400
2	21,200			3,378	24,578		-24,578	-47,978
3	8,200			7,637	15,837		-15,837	-63,815
4		3,319		9,278	12,597	17,197	4,600	-59,215
5		3,307		9,278	12,585	17,260	4,675	-54,540
6		3,293		9,278	12,571	17,051	4,480	-50,060
7		3,281	3,043	9,278	15,602	17,091	1,489	-48,572
8		3,268	6,879	9,037	19,184	16,894	-2,290	-50,861
9		3,340	8,357	8,491	20,188	18,304	-1,884	-52,745
10		3,413	8,357	7,829	19,599	19,484	-115	-52,860
11		3,485	8,357	7,166	19,008	20,665	1,657	-51,203
12		3,558	8,357	6,503	18,418	21,845	3,427	-47,776
13		3,630	8,357	5,840	17,827	23,026	5,199	-42,577
14		3,698	8,357	5,178	17,233	24,421	7,188	-35,390
15		3,764	8,357	4,515	16,636	25,203	8,567	-26,823
16		3,832	8,357	3,852	16,041	26,291	10,250	-16,573
17		3,898	8,357	3,190	15,445	27,379	11,934	-4,639
18		3,966	8,357	2,527	14,850	28,468	13,618	8,979
19		3,985	8,357	1,864	14,206	28,774	14,568	23,548
20		4,003	8,357	1,201	13,561	29,081	15,520	39,068
21		4,022	5,314	539	9,875	29,388	19,513	58,580
22		4,041	1,479	117	5,637	29,694	24,057	82,637
23		4,060			4,060	30,429	26,369	109,007
24		4,079			4,079	30,740	26,661	135,668
25		4,098			4,098	31,051	26,953	162,621
26		4,117			4,117	31,362	27,245	189,867
27		4,135			4,135	32,119	27,984	217,851
28		4,155			4,155	32,435	28,280	246,131
29		4,173			4,173	32,750	28,577	274,708
30		4,192			4,192	33,065	28,873	303,582
31		4,211			4,211	33,844	29,633	333,215
32		4,229			4,229	34,164	29,935	363,150
33		4,249			4,249	34,484	30,235	393,385

Note: 1) Loan condition

- Total loan amount : MRs 111.3 million
- Repayment period : 20 years (6-year grace period)
- Interest : 7.93 %

表5.3 収入内訳

(Unit: MRs. 1,000)

Year	Production Capacity m3/d	Accounted-for-Water Ratio %	Accounted-for-Water 1,000 m3/Y	Water Tariff Rs.	Revenue Rs. x 1,000	Remarks
1						
2						
3						
4	11,720	67	2,866	6.0	17,197	
5	11,590	68	2,877	6.0	17,260	
6	11,450	68	2,842	6.0	17,051	
7	11,310	69	2,848	6.0	17,091	
8	11,180	69	2,816	6.0	16,894	
9	11,940	70	3,051	6.0	18,304	
10	12,710	70	3,247	6.0	19,484	
11	13,480	70	3,444	6.0	20,665	
12	14,250	70	3,641	6.0	21,845	
13	15,020	70	3,838	6.0	23,026	
14	15,930	70	4,070	6.0	24,421	
15	16,440	70	4,200	6.0	25,203	
16	17,150	70	4,382	6.0	26,291	
17	17,860	70	4,563	6.0	27,379	
18	18,570	70	4,745	6.0	28,468	
19	18,770	70	4,796	6.0	28,774	
20	18,970	70	4,847	6.0	29,081	
21	19,170	70	4,898	6.0	29,388	
22	19,370	70	4,949	6.0	29,694	
23	19,570	71	5,072	6.0	30,429	
24	19,770	71	5,123	6.0	30,740	
25	19,970	71	5,175	6.0	31,051	
26	20,170	71	5,227	6.0	31,362	
27	20,370	72	5,353	6.0	32,119	
28	20,570	72	5,406	6.0	32,435	
29	20,770	72	5,458	6.0	32,750	
30	20,970	72	5,511	6.0	33,065	
31	21,170	73	5,641	6.0	33,844	
32	21,370	73	5,694	6.0	34,164	
33	21,570	73	5,747	6.0	34,484	

Note: 1) Production capacity = treatment capacity x 1/1.05

2) Accounted-for-water ratio is assumed as follows:

65% in 1990, 70% in 2000

70% in 2010, 75% in 2030

図5.1 建設機械配分計画

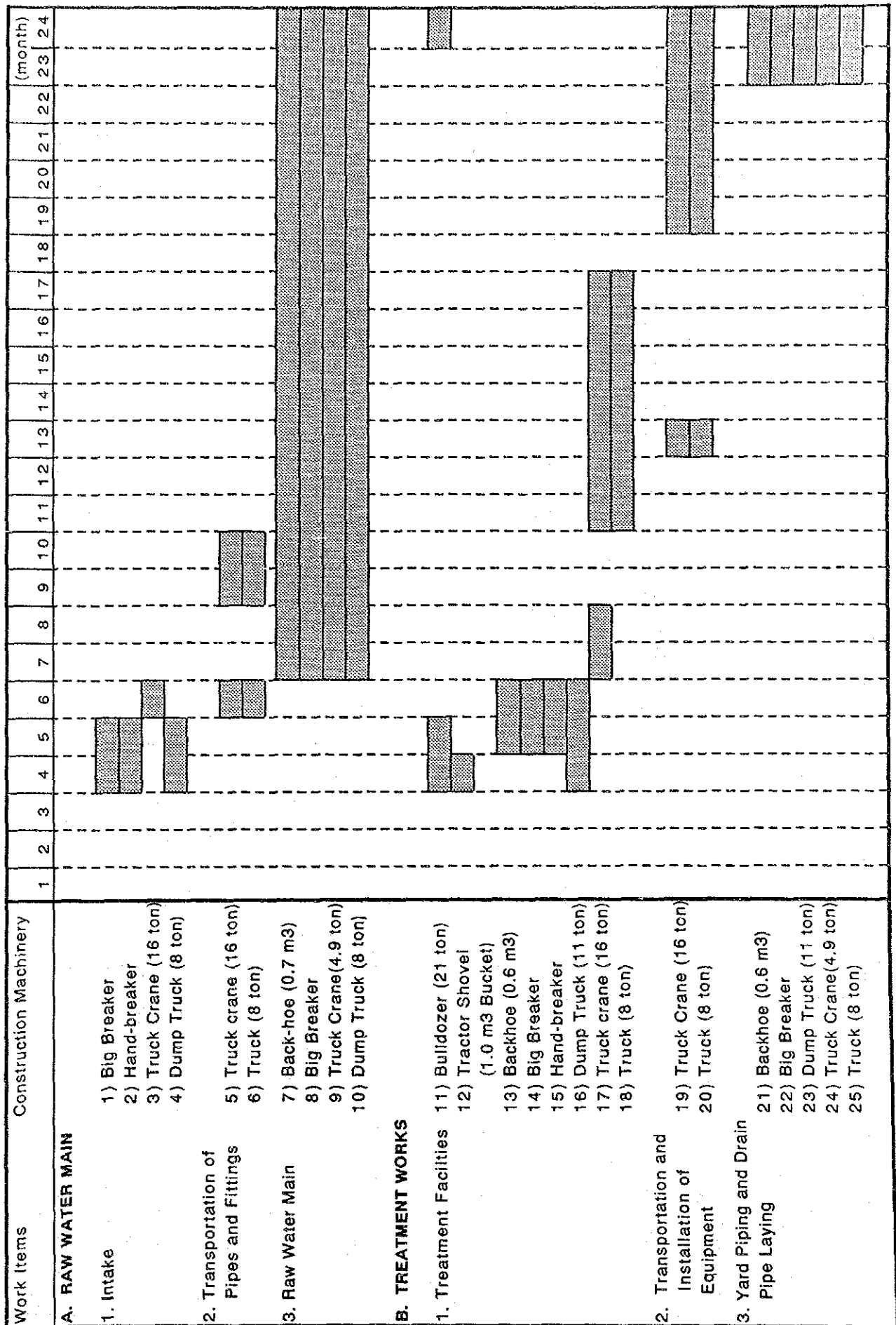

図5.2 建設工程計画

