

BANGKOK AREA TRAFFIC CONTROL SYSTEM PROJECT : STAGE I			
INTERSECTION EXISTING LAYOUT		Submitted By :	Approved By :
RAMA V-- PHITSANULOK		Jun Kadeia JICA Study Team Leader	<i>[Signature]</i> Boonwatt Tiplua BMA Study Team Leader
INTERSECTION NO 101			
Code	Survey	Date	Initial
Associated Plan No. :	JICA Japan International Cooperation Agency	BMA Bangkok Metropolitan Administration	Scale 1/250 Date SEPTEMBER '80 Drawing No. 5101 Total 72 / 143

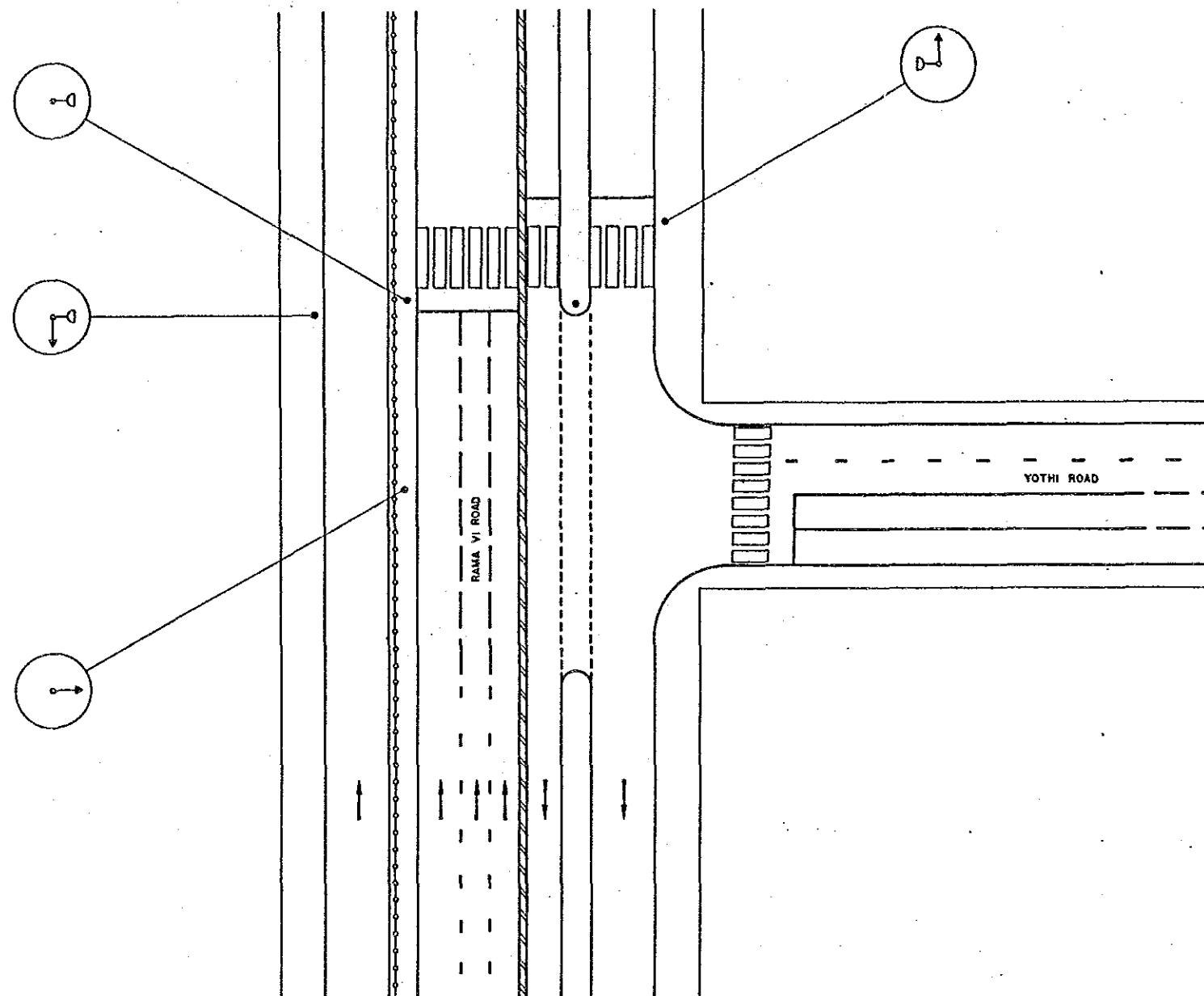

				BANGKOK AREA TRAFFIC CONTROL SYSTEM PROJECT : STAGE I			
				INTERSECTION EXISTING LAYOUT		Submitted By :	Approved By :
				RAMA VI - YOTHI		Jura Kedera JICA Study Team Leader	<i>Jura</i> Boonyawat Titus BMA Study Team Leader
				INTERSECTION NO 102			
Code	Survey	Date	Initial	JICA	BMA	Scale 1 / 250	Drawing NO 5102
Associated Plan No. :				JICA Japan International Cooperation Agency	BMA Bangkok Metropolitan Administration	Date SEPTEMBER '90	Total 73 / 143

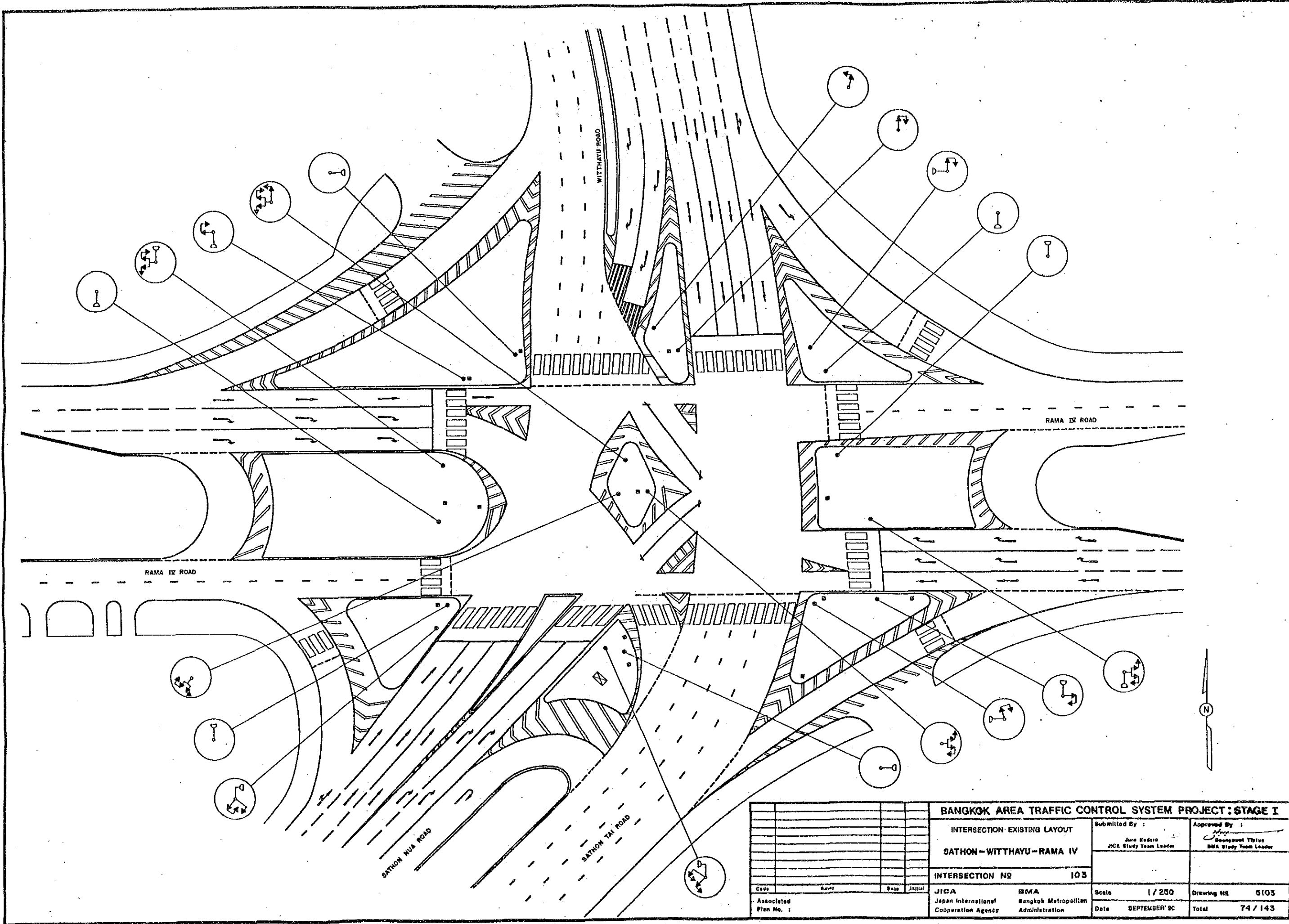

BANGKOK AREA TRAFFIC CONTROL SYSTEM PROJECT: STAGE I			
INTERSECTION EXISTING LAYOUT		Submitted By :	Approved By :
SATHON - WITTHAYU - RAMA IV		Sara Kodris JICA Study Team Leader	Boonpoom Thras BMA Study Team Leader
INTERSECTION NO 103			
Cada	Survey	Base	Initial
Associated Plan No. :		JICA Japan International Cooperation Agency	BMA Bangkok Metropolitan Administration
		Scale 1/250	Drawing No 5103
		Date SEPTEMBER '90	Total 74/143

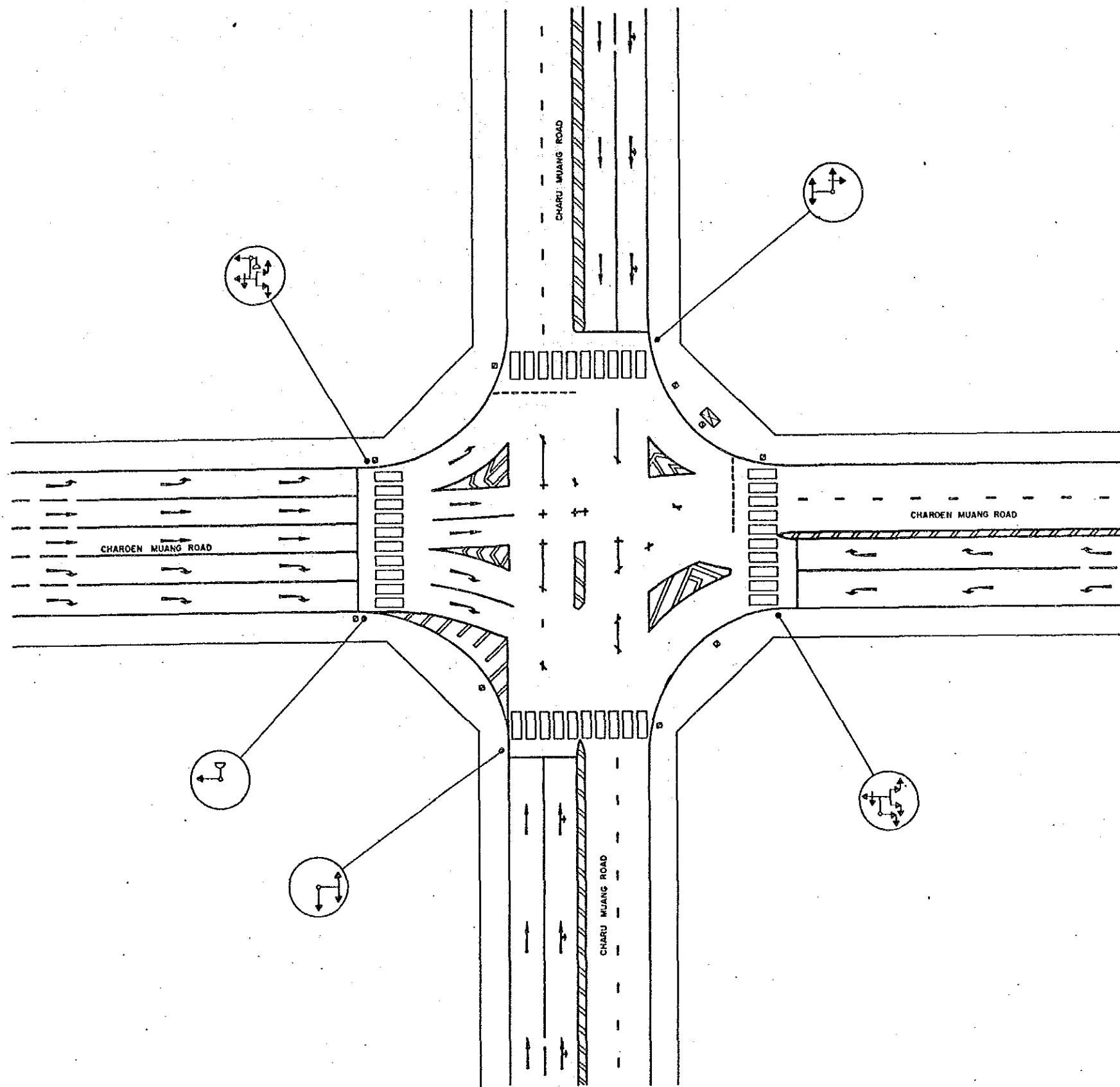

BANGKOK AREA TRAFFIC CONTROL SYSTEM PROJECT : STAGE I							
INTERSECTION EXISTING LAYOUT CHARU MUANG - CHAROEN MUANG				Submitted By :	Approved By :		
				Jiro Kodera JICA Study Team Leader	[Signature] Somchai Tiptas BMA Study Team Leader		
INTERSECTION NO 104							
Code	Rev	Date	Initial	JICA	BMA	Scale	Drawing No
Associated Plan No. :				Japan International Cooperation Agency	Bangkok Metropolitan Administration	1 / 250	5104
				Date	SEPTEMBER '90	Total	75 / 143

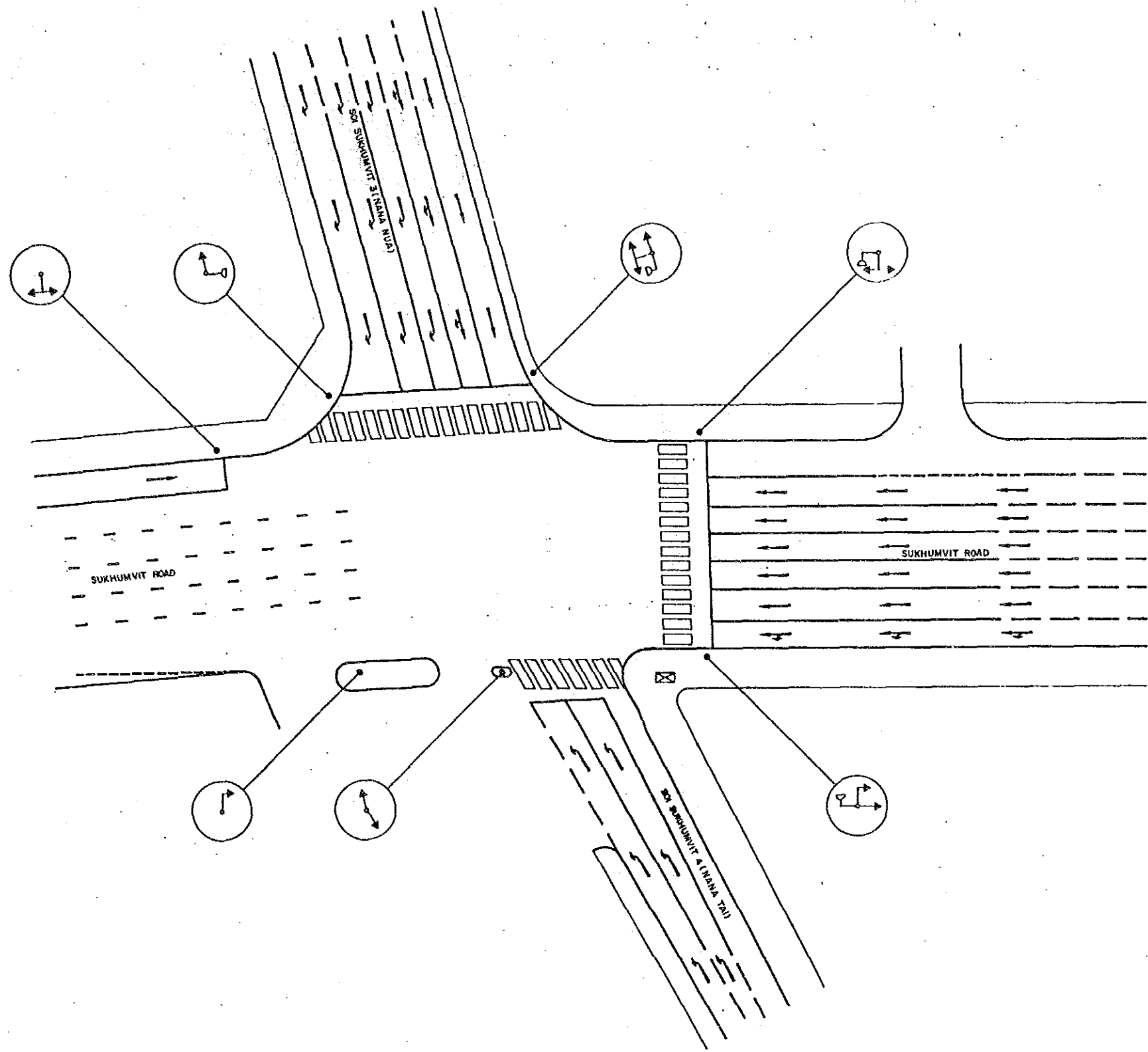

BANGKOK AREA TRAFFIC CONTROL SYSTEM PROJECT : STAGE I			
INTERSECTION EXISTING LAYOUT		Submitted By :	Approved By :
SUKHUMVIT-SOI SUKHUMVIT 4 (NANA TAI)		Jiro Kodera JICA Study Team Leader	Boonpradit Titlus BMA Study Team Leader
INTERSECTION NO		105	
Code	Survey	Date	Initial
Associated Plan No. :	JICA Japan International Cooperation Agency	BMA Bangkok Metropolitan Administration	Scale 1 / 250 Date SEPTEMBER '60 Drawing No 5105 Total 76 / 143

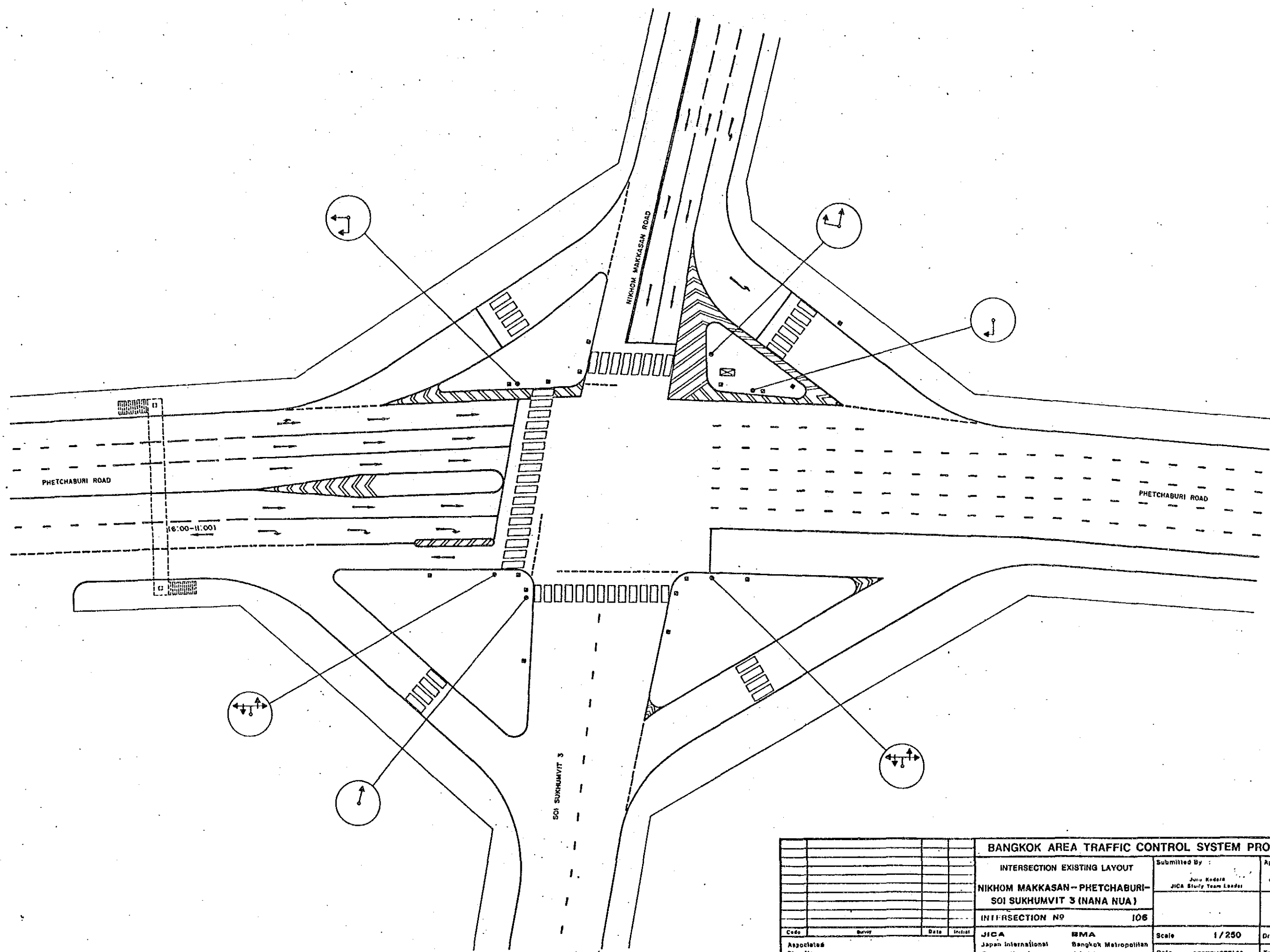

				BANGKOK AREA TRAFFIC CONTROL SYSTEM PROJECT : STAGE I			
				INTERSECTION EXISTING LAYOUT		Submitted By :	
				NIKHOM MAKKASAN - PHETCHABURI - SOI SUKHUMVIT 3 (NANA NUA)		Jiro Kodera JICA Study Team Leader	
				INTERSECTION NO 106		Approved By :	
						Satoru Teraoka BMA Study Team Leader	
Code	Survey	Date	Initial	JICA	BMA	Scale	Drawing No
Associated Plan No. 1				Japan International Cooperation Agency	Bangkok Metropolitan Administration	1/250	5106
						Date	Total
						SEPTEMBER '90	77 / 143

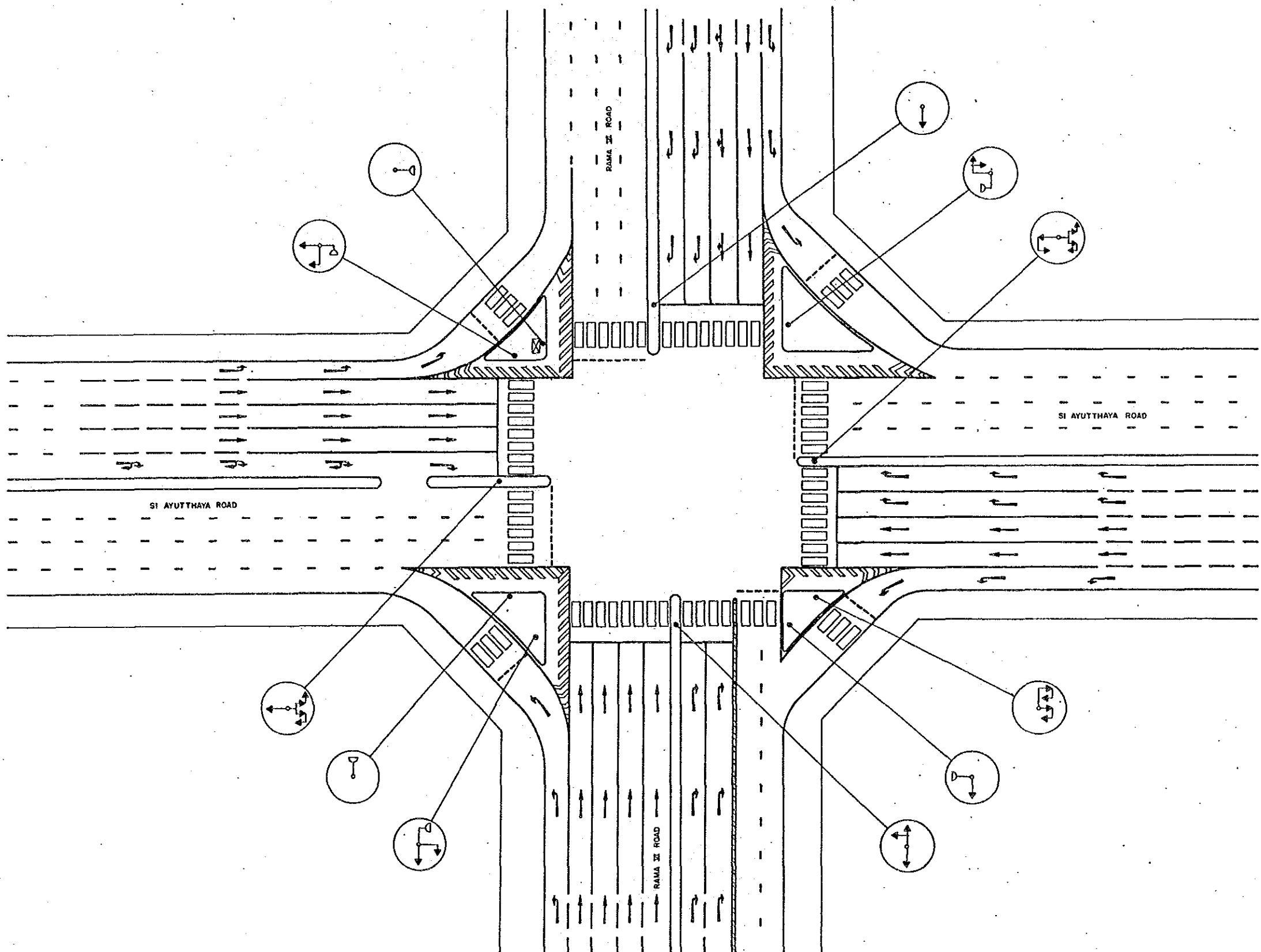

BANGKOK AREA TRAFFIC CONTROL SYSTEM PROJECT : STAGE I			
INTERSECTION EXISTING LAYOUT		Submitted By :	Approved By :
RAMA VI - SI AYUTTHAYA		Jiro Kodera JICA Study Team Leader	Keonjorn Titluw BMA Study Team Leader
INTERSECTION NO : 109			
Code	Reviz	Date	Initial
Associated Plan No. :		JICA Japan International Cooperation Agency	BMA Bangkok Metropolitan Administration
		Scale 1 / 250	Drawing NR 5109
		Date SEPTEMBER '90	Total 78 / 143

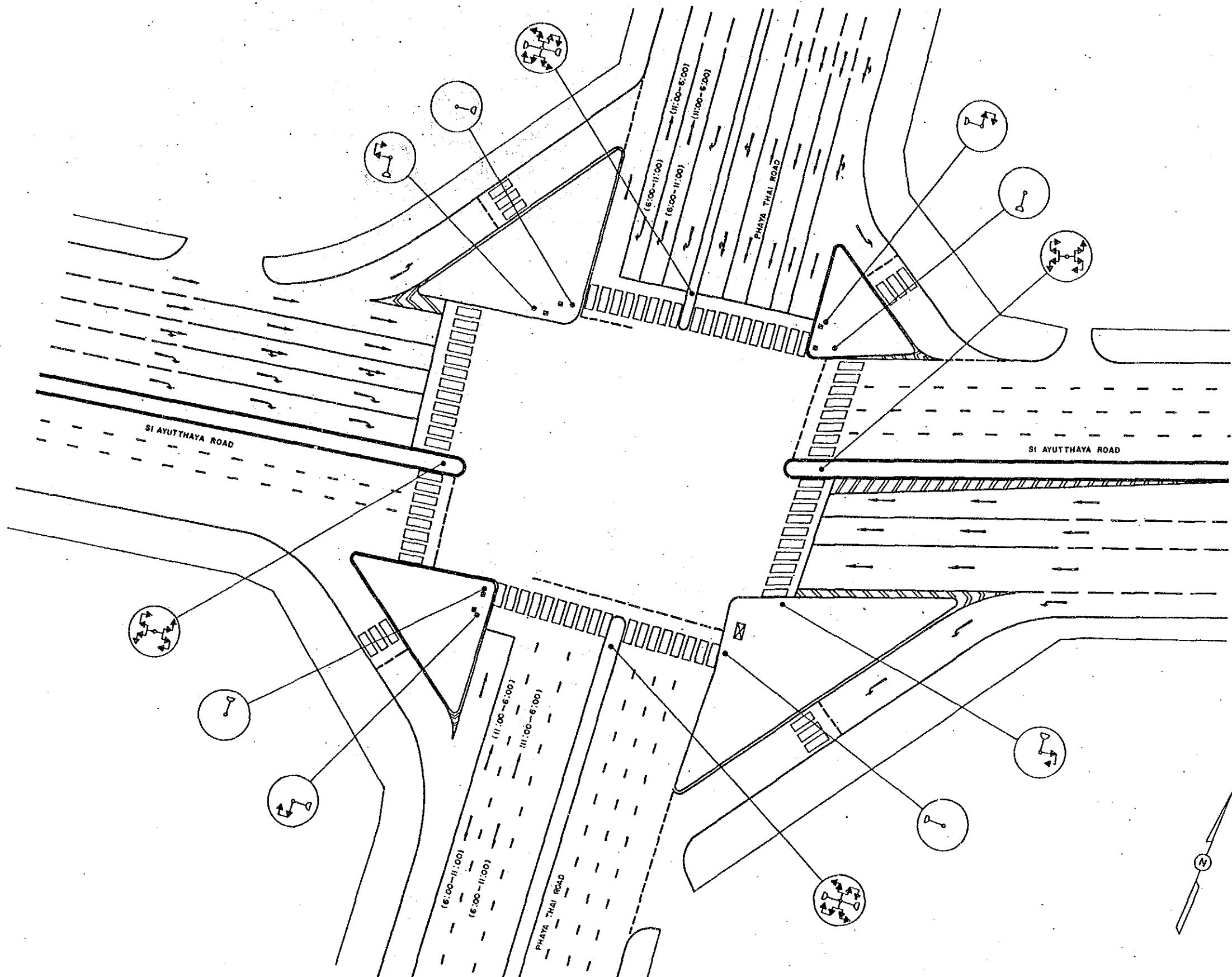

				BANGKOK AREA TRAFFIC CONTROL SYSTEM PROJECT : STAGE I			
				INTERSECTION EXISTING LAYOUT		Submitted By :	
				PHAYA THAI-SI AYUTTHAYA		Jaru Kedar JICA Study Team Leader	
				INTERSECTION NO 110		Approved By :	
						Wongyawat Tiptus BMA Study Team Leader	
Code	Survey	Date	Initial	JICA	BMA	Scale	1 / 250
Associated Plan No. 1				Japan International Cooperation Agency	Bangkok Metropolitan Administration	Date	SEPTEMBER '90
						Drawing NO. 5110	
						Total 79 / 143	

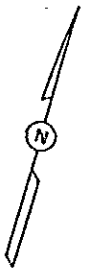
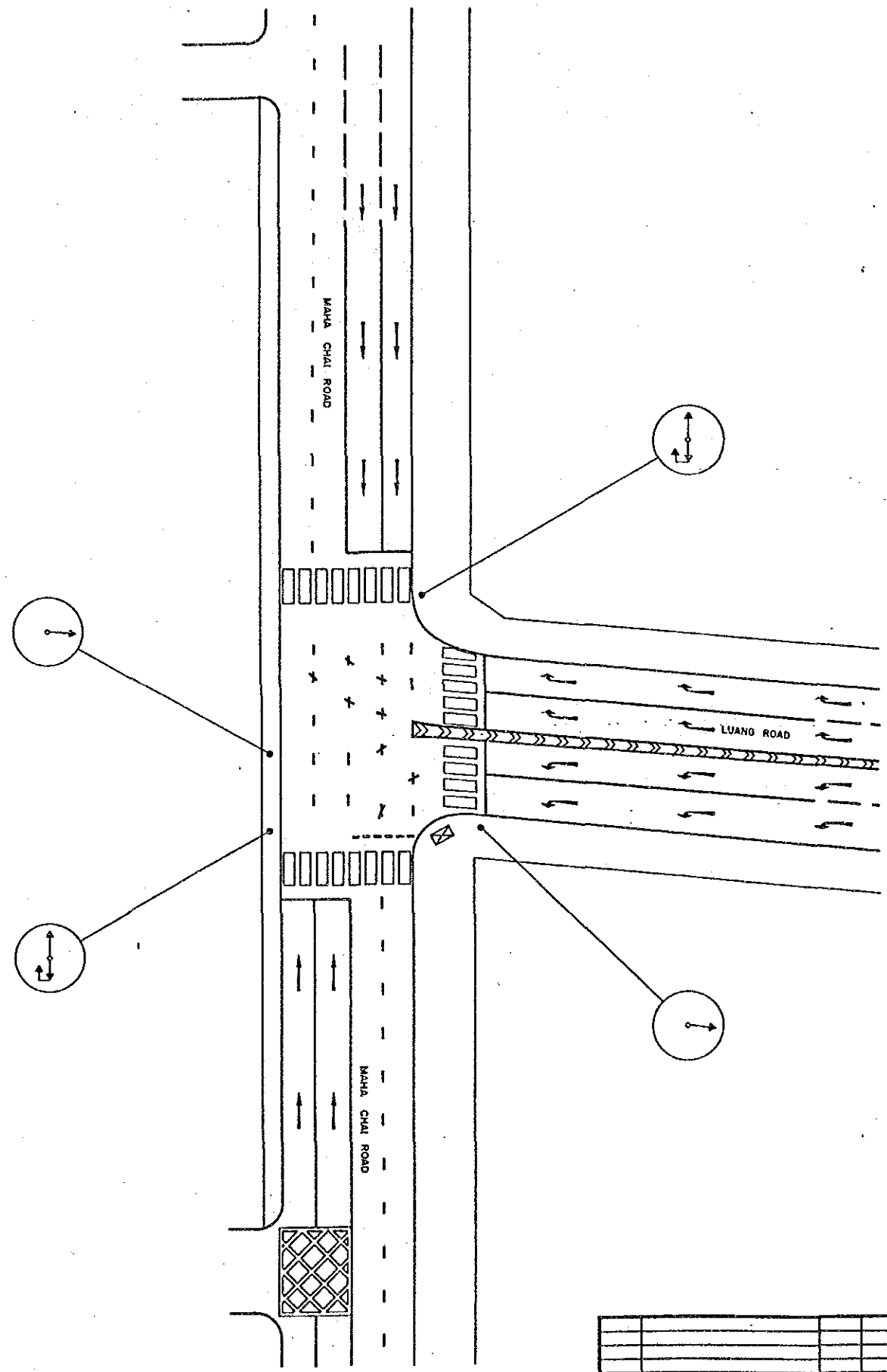

BANGKOK AREA TRAFFIC CONTROL SYSTEM PROJECT : STAGE I			
INTERSECTION EXISTING LAYOUT		Submitted By :	Approved By :
MAHACHAI - LUANG		Juro Kodera JICA Study Team Leader	Bhongsawat Vistua BMA Study Team Leader
INTERSECTION NO. 112			
Code	Survey	Date	Initial
Associated Plan No. :	JICA Japan International Cooperation Agency	BMA Bangkok Metropolitan Administration	Scale 1 / 250 Date SEPTEMBER '90 Drawing No. 5112 Total 80 / 143

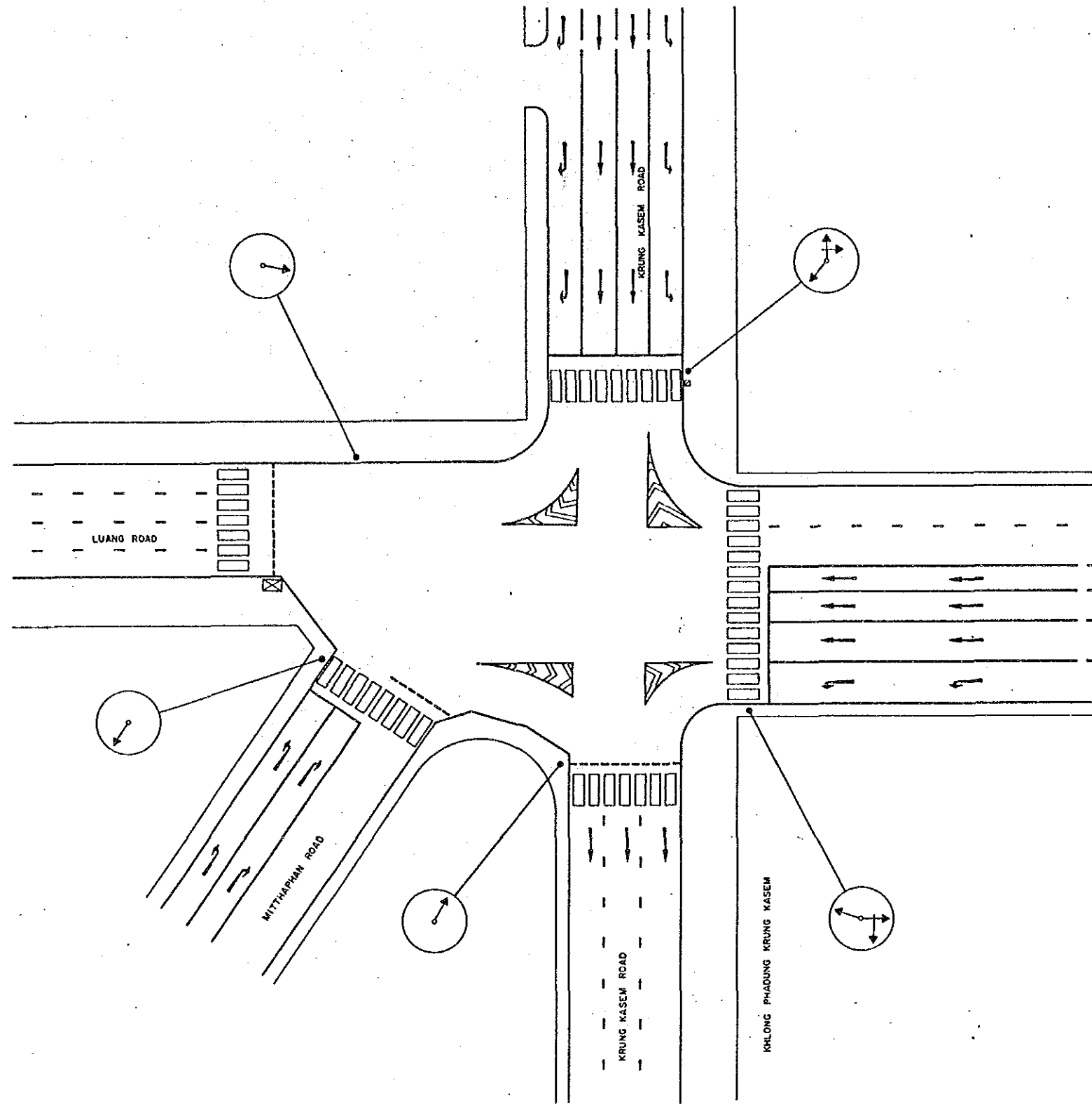

BANGKOK AREA TRAFFIC CONTROL SYSTEM PROJECT : STAGE I			
INTERSECTION EXISTING LAYOUT		Submitted By : Jiro Kodera JICA Study Team Leader	Approved By : <i>[Signature]</i> Boonjaval Titlus BMA Study Team Leader
KRUNG KASEM - MITTHAPHAN - LUANG			
INTERSECTION NO 114			
Code	Survey	Date	Initial
Associated Plan No. :	JICA Japan International Cooperation Agency	BMA Bangkok Metropolitan Administration	Scale 1 / 250 Date SEPTEMBER '90 Drawing No 5114 Total 81 / 143

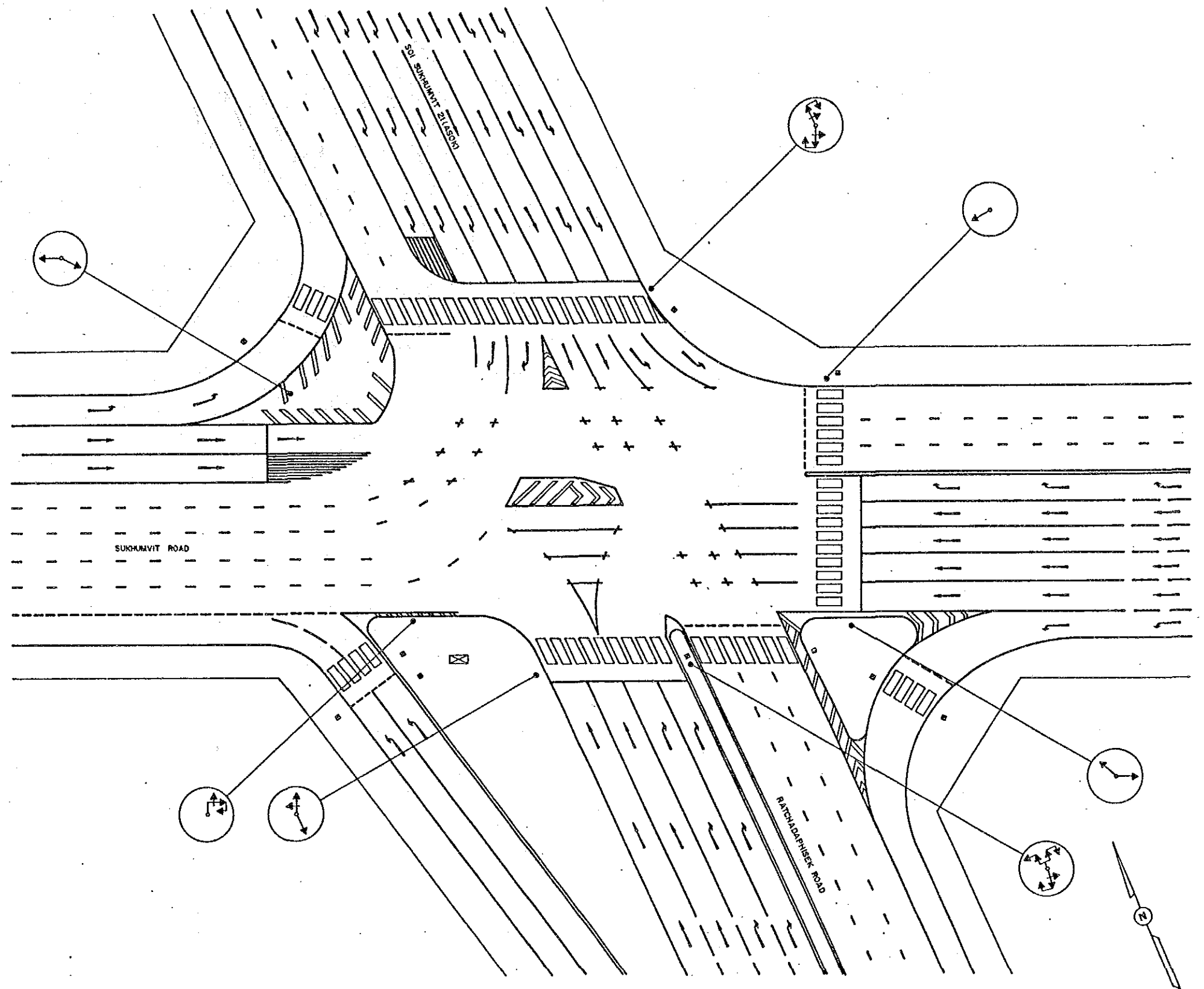

				BANGKOK AREA TRAFFIC CONTROL SYSTEM PROJECT: STAGE I			
				INTERSECTION EXISTING LAYOUT		Submitted By :	Approved By :
				SUKHUMVIT - SOI SUKHUMVIT 21 (ASOK) - RATCHADAPHISEK		Jiro Kodate JICA Study Team Leader	Boonyawat Tiptua BMA Study Team Leader
				INTERSECTION NO 115			
Code	Survey	Date	Initial	JICA	BMA	Scale	Drawing No
Associated Plan No. :				Japan International Cooperation Agency	Bangkok Metropolitan Administration	1 / 250	515
						Date	Total
						SEPTEMBER '90	82 / 143

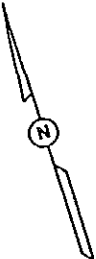
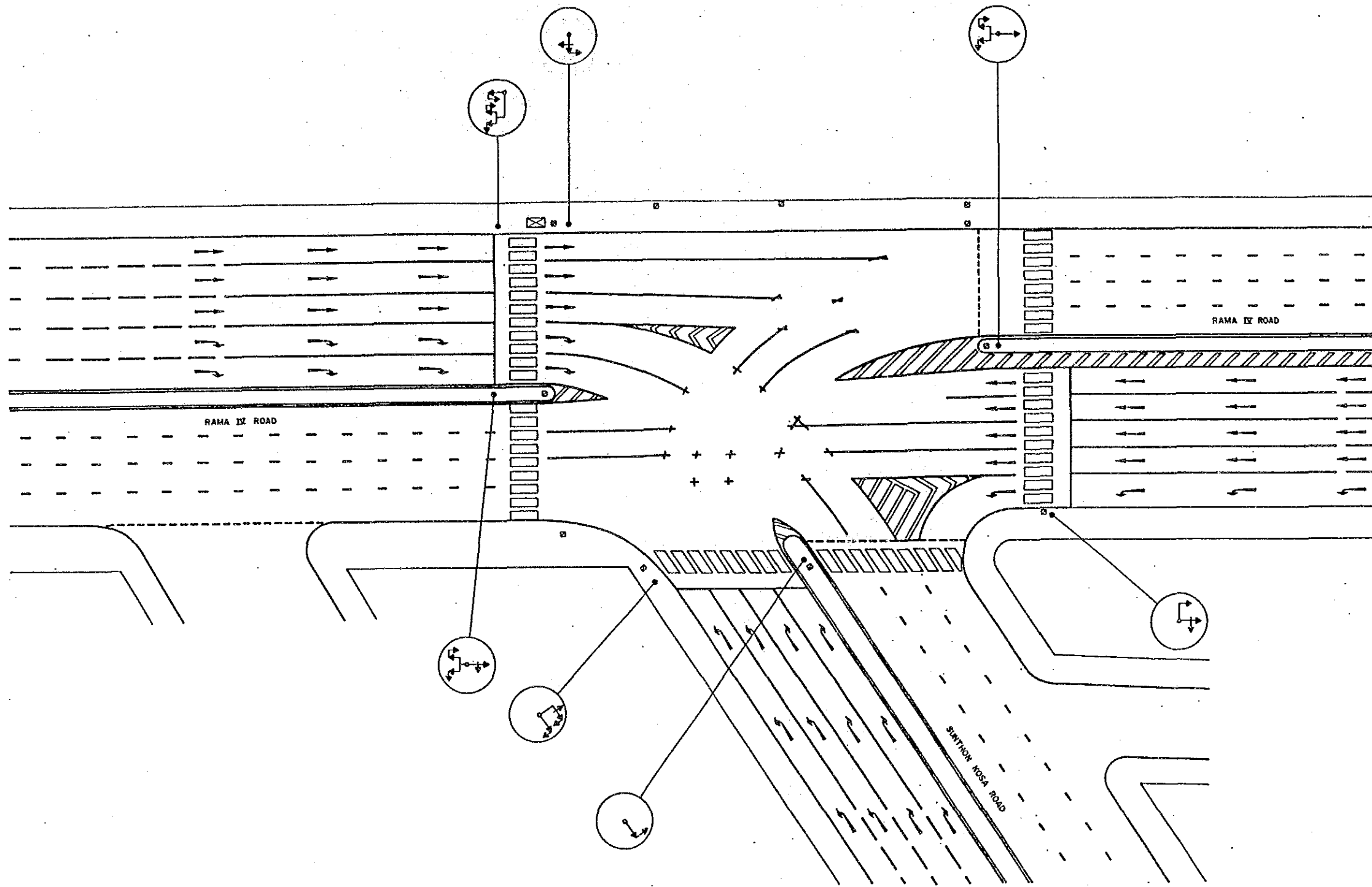

				BANGKOK AREA TRAFFIC CONTROL SYSTEM PROJECT : STAGE I			
				INTERSECTION EXISTING LAYOUT		Submitted By : <i>Jiro Kodera</i>	
				SUNTHON KOSA - RAMA IV		Approved By : <i>Boonyawat Tiptua</i>	
				INTERSECTION NO 118		JICA Study Team Leader	
						BMA Study Team Leader	
Code	Rev	Date	Initial	JICA	BMA	Scale	1 / 250
Associated Plan No. :				Japan International Cooperation Agency	Bangkok Metropolitan Administration	Date	SEPTEMBER '90
						Drawing NO	5118
						Total	83 / 143

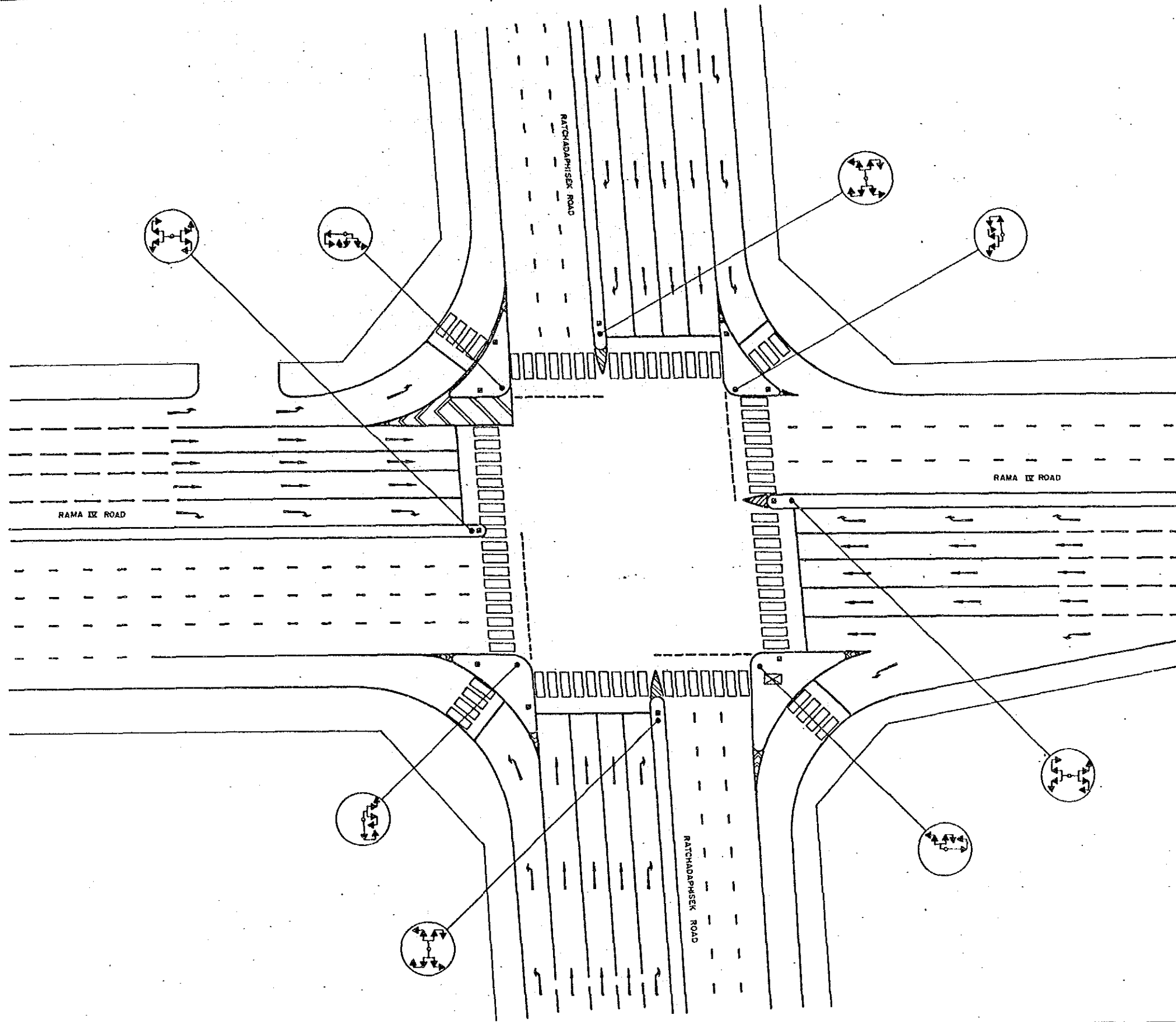

BANGKOK AREA TRAFFIC CONTROL SYSTEM PROJECT : STAGE I			
INTERSECTION EXISTING LAYOUT		Submitted By :	Approved By :
RATCHADAPHISEK-RAMA IV		Juro Kodera JICA Study Team Leader	<i>[Signature]</i> Somyarat Tiptua BMA Study Team Leader
INTERSECTION NO 123			
Code	Survey	Date	Initial
Associated Plan No. :	JICA Japan International Cooperation Agency	BMA Bangkok Metropolitan Administration	Scale 1 / 250 Date SEPTEMBER '90
			Drawing NR 6123 Total 84 / 143

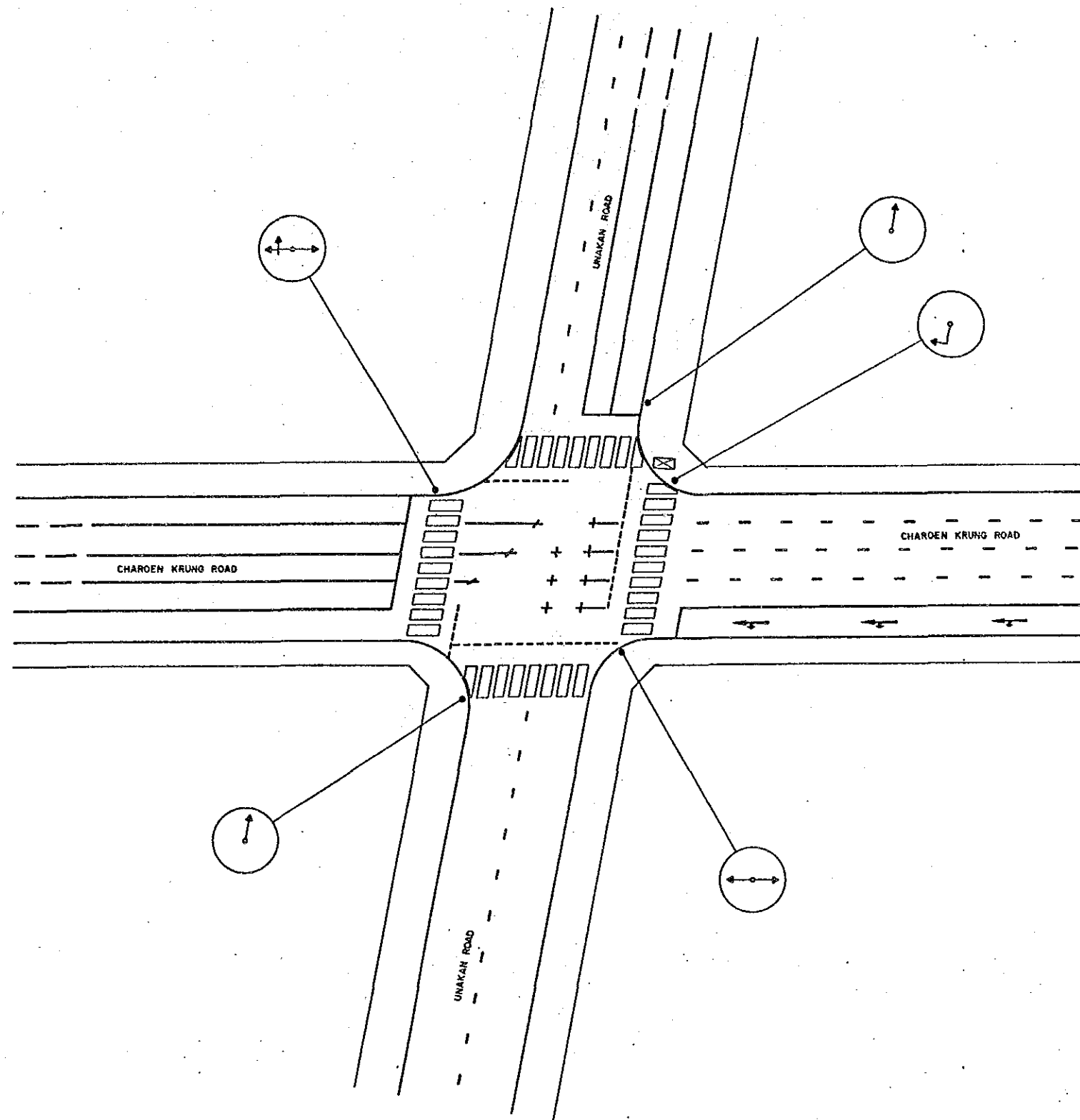

BANGKOK AREA TRAFFIC CONTROL SYSTEM PROJECT : STAGE I									
INTERSECTION EXISTING LAYOUT					Submitted By :		Approved By :		
					Juro Kodera JICA Study Team Leader		 Roanawat Thira BMA Study Team Leader		
UNAKAN - CHAROEN KRUNG									
INTERSECTION NO					130				
Code	Survey	Date	Initial	JICA	BMA	Scale	1 / 250	Drawing No	5130
Associated Plan No. :				Japan International	Bangkok Metropolitan	Date	SEPTEMBER '00	Total	85 / 143
				Cooperation Agency	Administration				

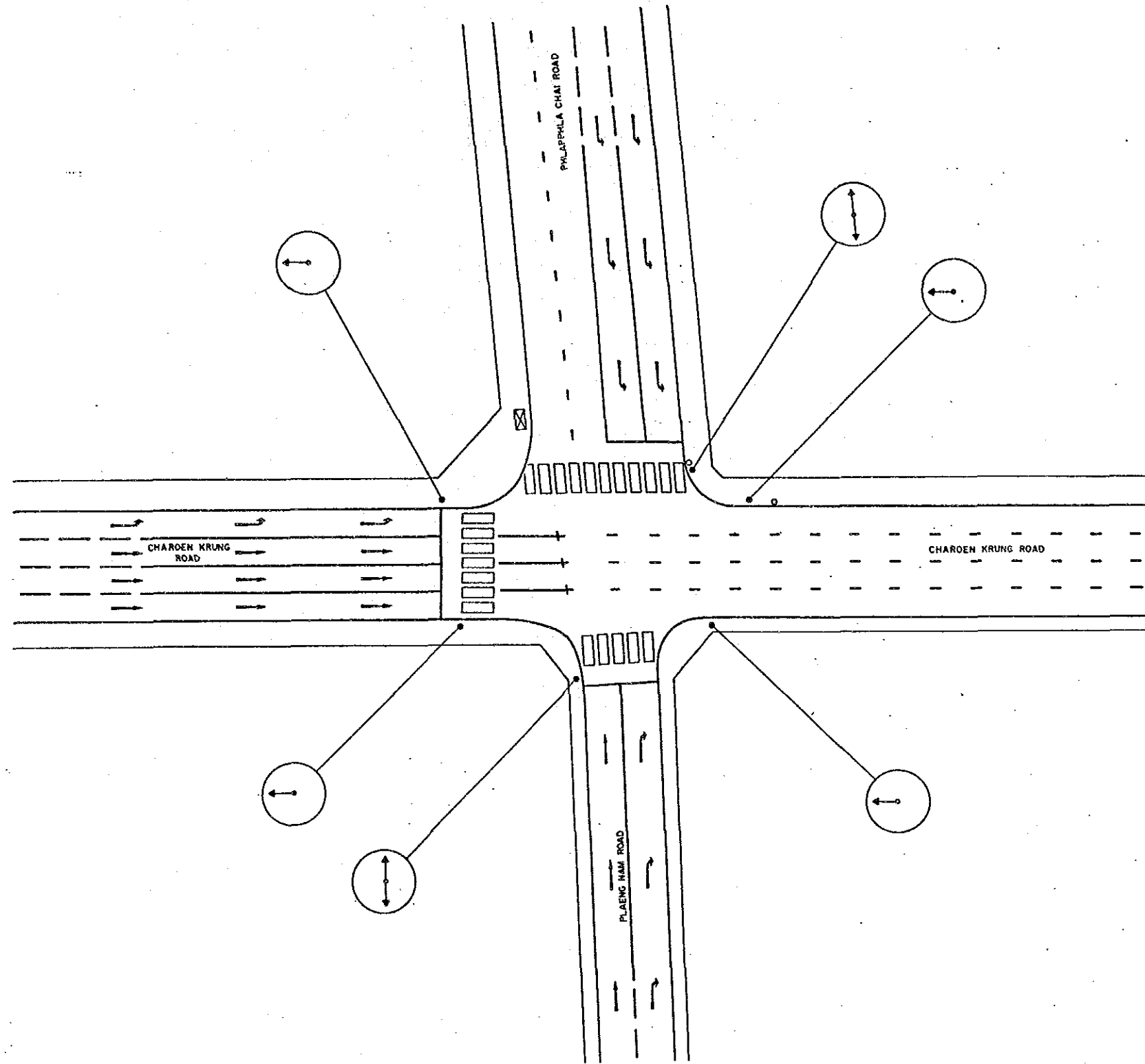

				BANGKOK AREA TRAFFIC CONTROL SYSTEM PROJECT : STAGE I			
				INTERSECTION EXISTING LAYOUT		Submitted By :	Approved By :
				PLAENG NAM - CHAROEN KRUNG		Jiro Kodera JICA Study Team Leader	Sukanyawat Tiptua BMA Study Team Leader
				INTERSECTION NO 131			
Code	Survey	Date	Initial	JICA	BMA	Scale	Drawing No
Associated Plan No. :				Japan International Cooperation Agency	Bangkok Metropolitan Administration	1 / 250	5131
						Date	Total
						SEPTEMBER '90.	86 / 143

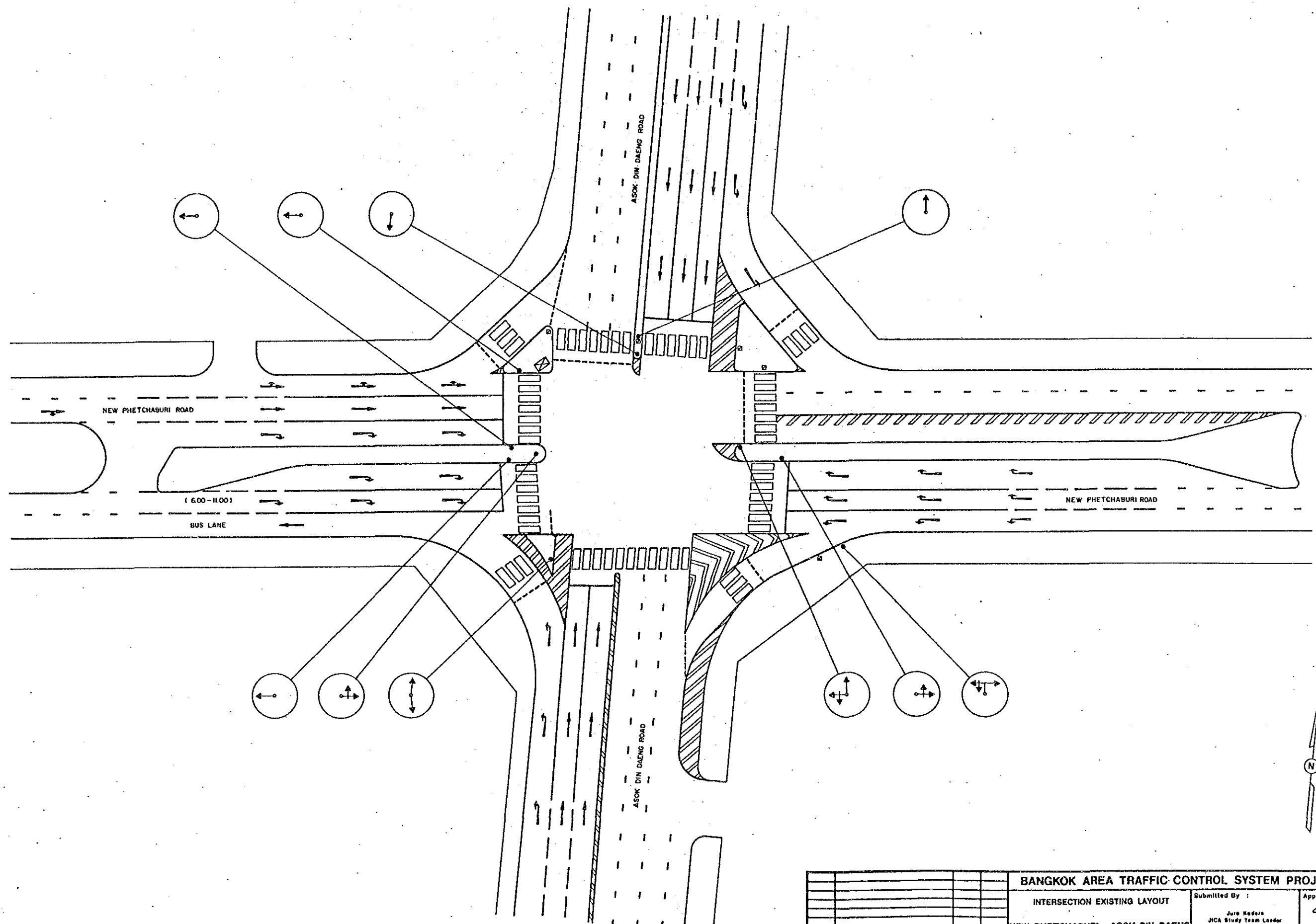

BANGKOK AREA TRAFFIC CONTROL SYSTEM PROJECT : STAGE I			
INTERSECTION EXISTING LAYOUT		Submitted By :	Approved By :
NEW PHETCHABURI - ASOK DIN DAENG		Jaro Kedara JICA Study Team Leader	<i>[Signature]</i> Sasayawit Tiptua BMA Study Team Leader
INTERSECTION NO 134			
Code	Survey	Date	Initial
Associated Plan No. :	JICA Japan International Cooperation Agency	BMA Bangkok Metropolitan Administration	Scale 1/250 Date SEPTEMBER '90
			Drawing NO 5134 Total 87 / 143

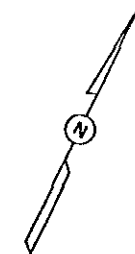
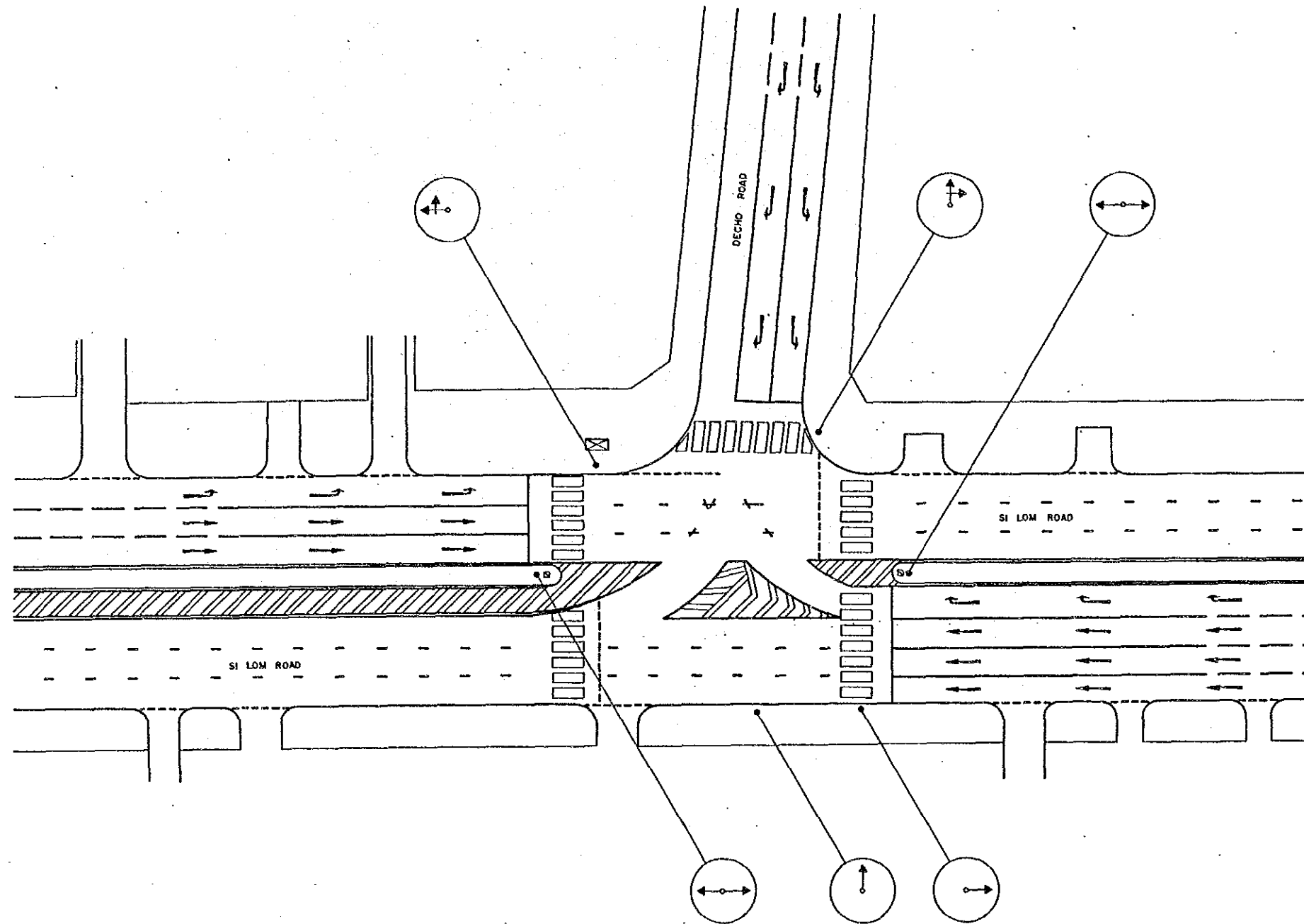

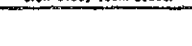
				BANGKOK AREA TRAFFIC CONTROL SYSTEM PROJECT : STAGE I			
				INTERSECTION EXISTING LAYOUT		Submitted By :	
				DECHO - SI LOM		 Auro Kudara JICA Study Team Leader	
				INTERSECTION NO 137		 Somsawat Titus BMA Study Team Leader	
Code	Survey	Date	Initial	JICA	BMA	Scale	Drawing No
Associated Plan No. :				Japan International Cooperation Agency	Bangkok Metropolitan Administration	1 / 250	5137
						Date	Total
						SEPTEMBER '90	88 / 143

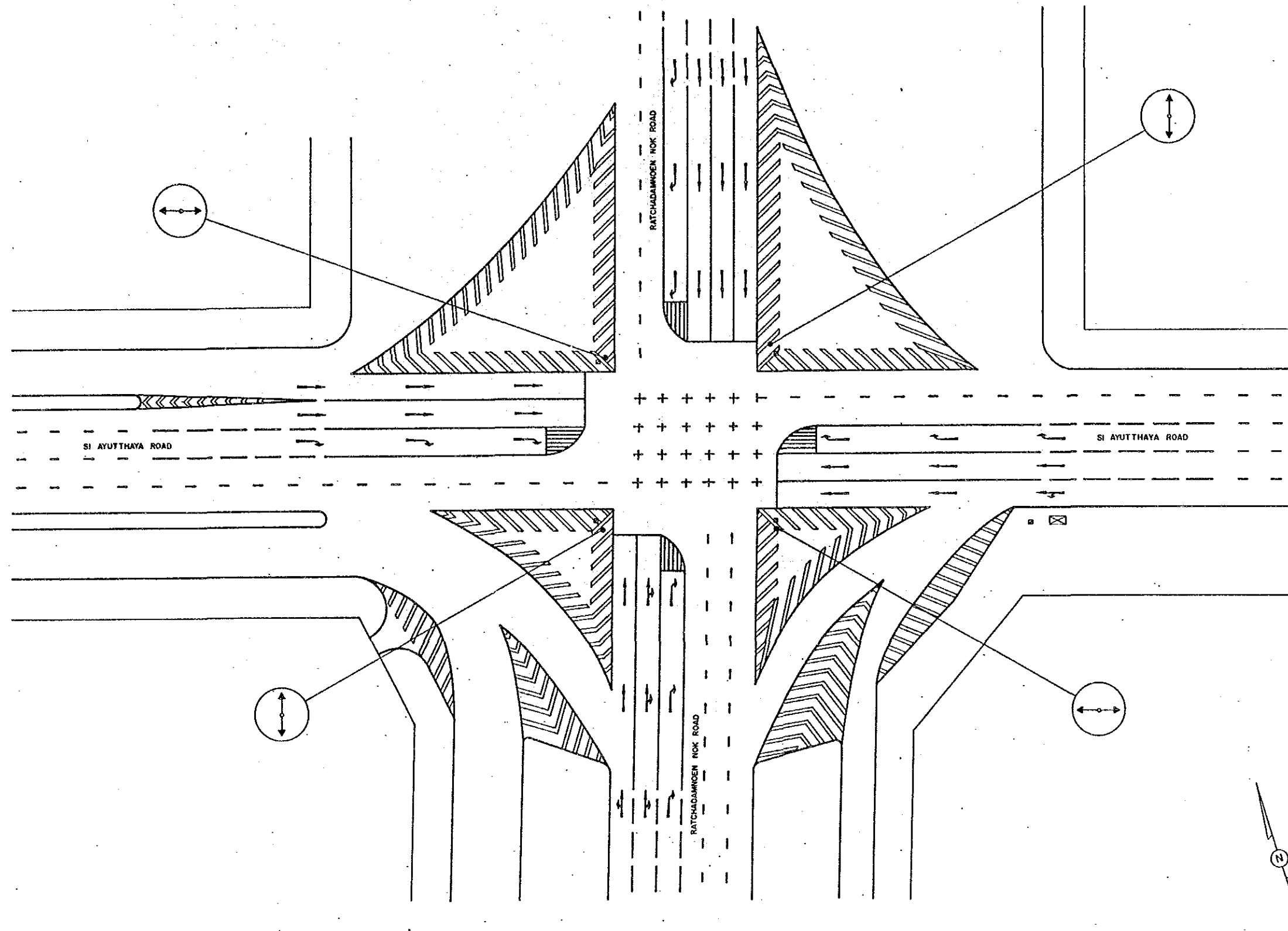

BANGKOK AREA TRAFFIC CONTROL SYSTEM PROJECT : STAGE I			
INTERSECTION EXISTING LAYOUT		Submitted By :	Approved By :
RATCHADAMNOEN NOK--SIAYUTTHAYA		Jura Kodera JICA Study Team Leader	<i>[Signature]</i> Boonyawat Yipua BMA Study Team Leader
INTERSECTION NO 139			
Code	Survey	Date	Initial
Associated Plan No. :	JICA Japan International Cooperation Agency	BMA Bangkok Metropolitan Administration	Scale 1 / 250 Date SEPTEMBER '90 Drawing No 5139 Total 89 / 143

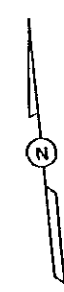
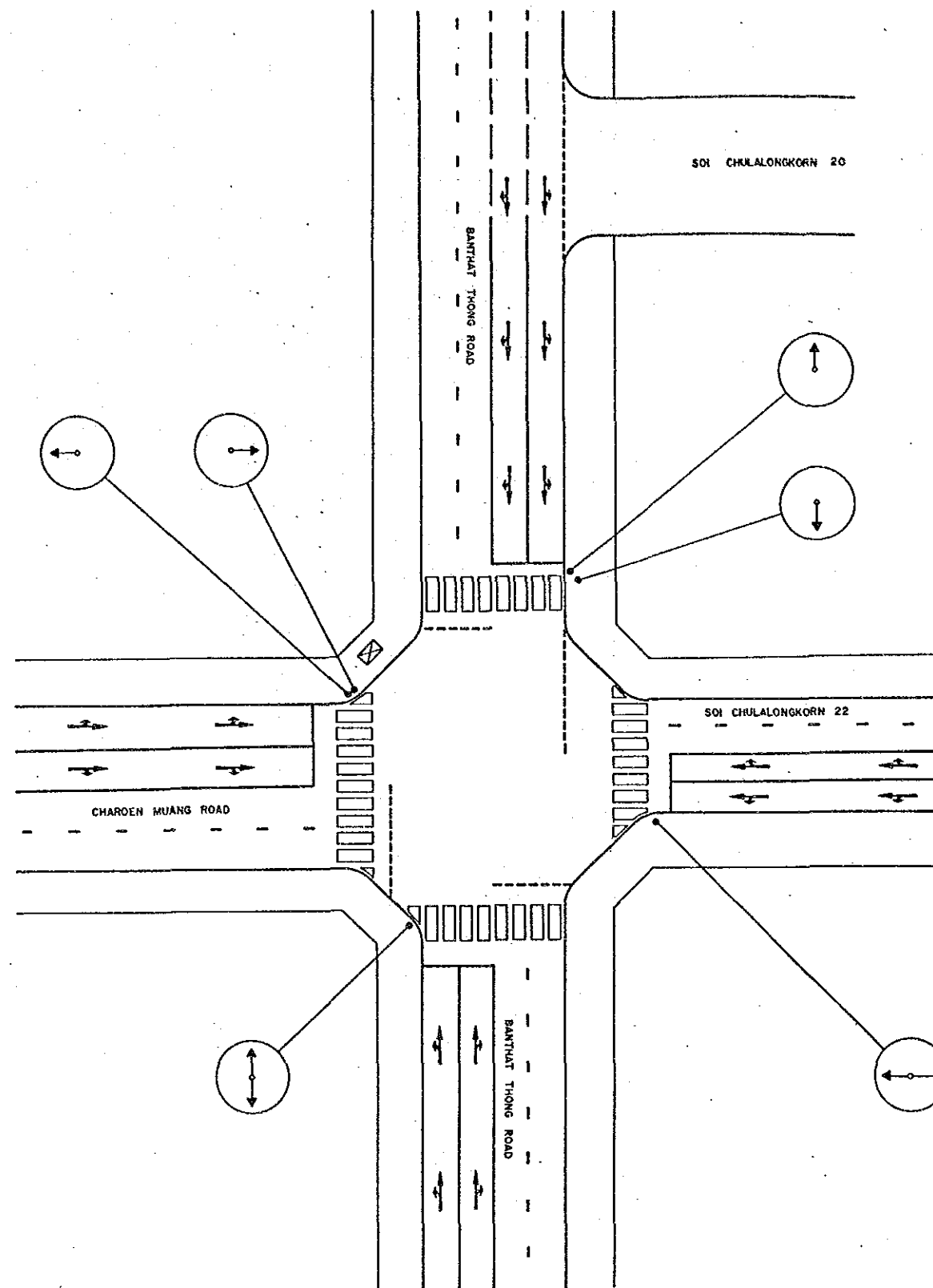

BANGKOK AREA TRAFFIC CONTROL SYSTEM PROJECT : STAGE I			
INTERSECTION EXISTING LAYOUT		Submitted By : Jiro Kodera JICA Study Team Leader	Approved By : <i>[Signature]</i> Suwanwat Tipua BMA Study Team Leader
BANTHAT THONG - CHAROEN MUANG			
INTERSECTION NO		140	
Code	Drawn	Date	Initial
Associated Plan No. :		JICA Japan International Cooperation Agency	BMA Bangkok Metropolitan Administration
		Scale	1 / 250
		Date	SEPTEMBER '90
		Drawing No.	5140
		Total	90 / 143

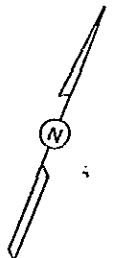
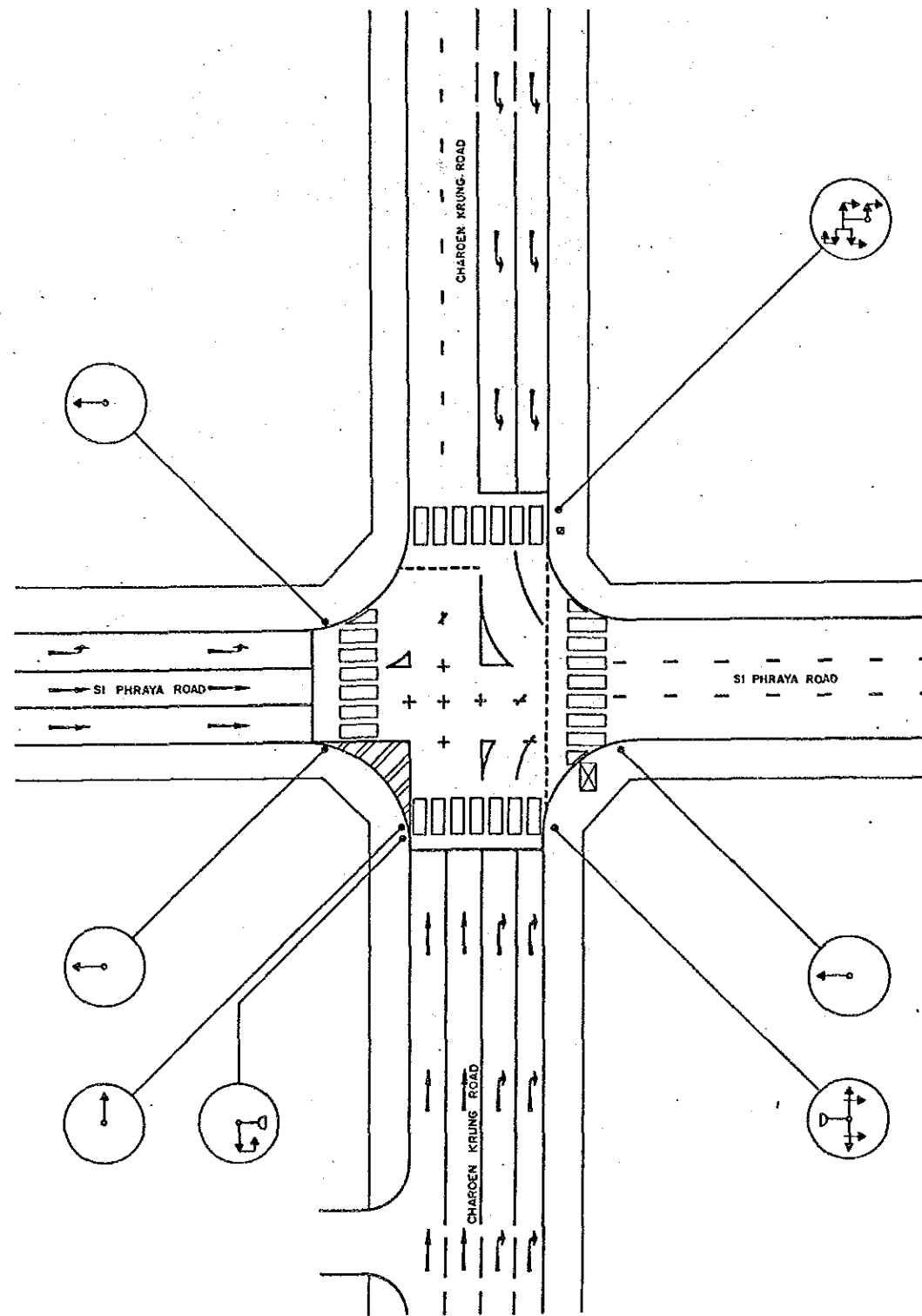

BANGKOK AREA TRAFFIC CONTROL SYSTEM PROJECT : STAGE I			
INTERSECTION EXISTING LAYOUT		Submitted By :	Approved By :
SI PHRAYA - CHAROEN KRUNG		Jiro Kodera JICA Study Team Leader	Boonwatt Tiplua BMA Study Team Leader
INTERSECTION N ^o		141	
Code	Survey	Date	Initial
Associated Plan No. :		JICA Japan International Cooperation Agency	BMA Bangkok Metropolitan Administration
		Scale	1 / 250
		Date	SEPTEMBER '90
		Drawing N ^o	5141
		Total	91 / 143

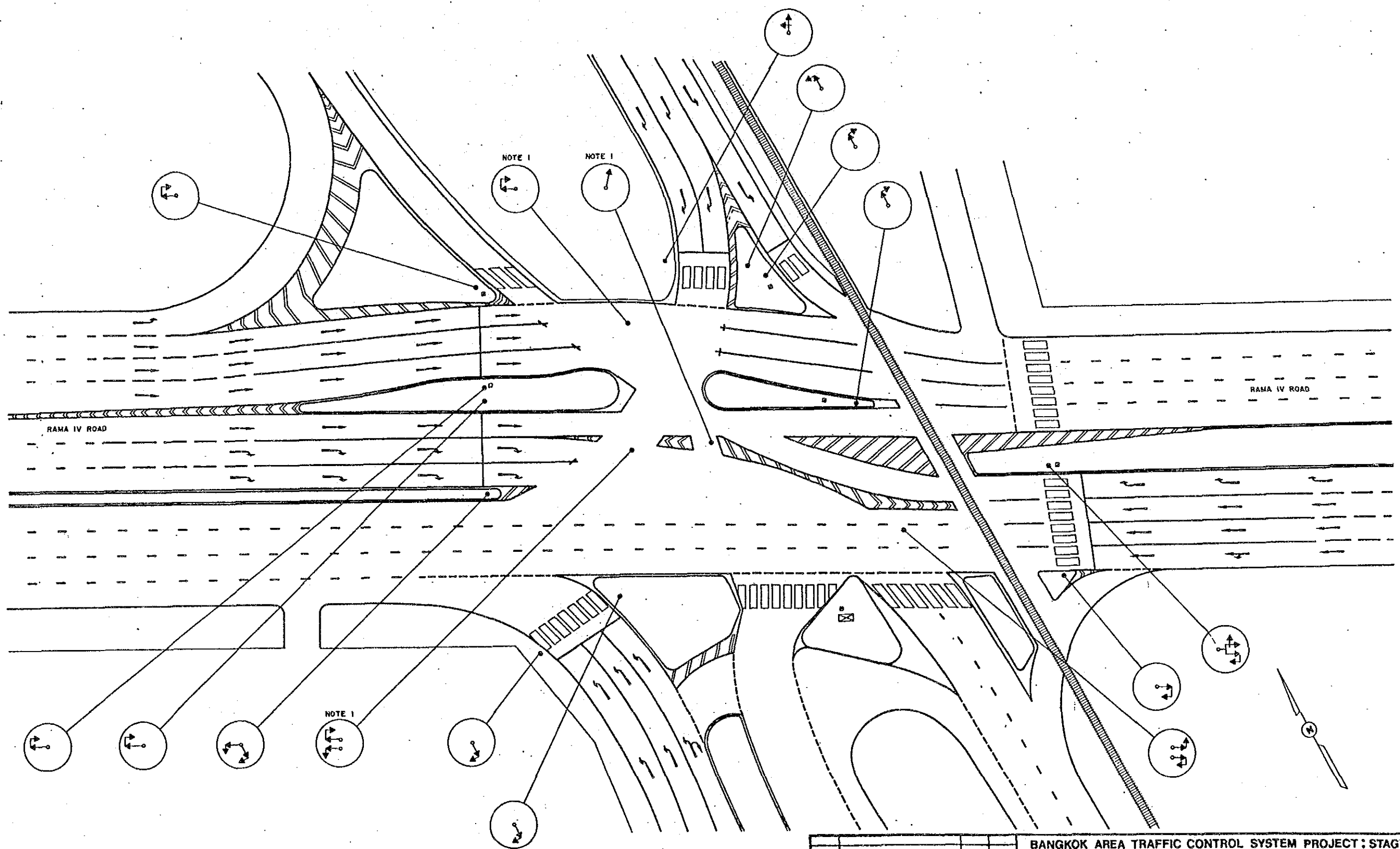

BANGKOK AREA TRAFFIC CONTROL SYSTEM PROJECT : STAGE I			
INTERSECTION EXISTING LAYOUT		Submitted By :	Approved By :
CHUA PHLOENG - RAMA IV - DIN DAENG PORT EXPRESSWAY		Juro Kodera JICA Study Team Leader	Responsible Tipton BMA Study Team Leader
INTERSECTION NO 142			
Code	Survey	Date	Initial
Assesloped Plan No. 1	JICA Japan International Cooperation Agency	BMA Bangkok Metropolitan Administration	Scale 1 / 250 Date SEPTEMBER '90 Drawing No. 5142 Total 92 / 143

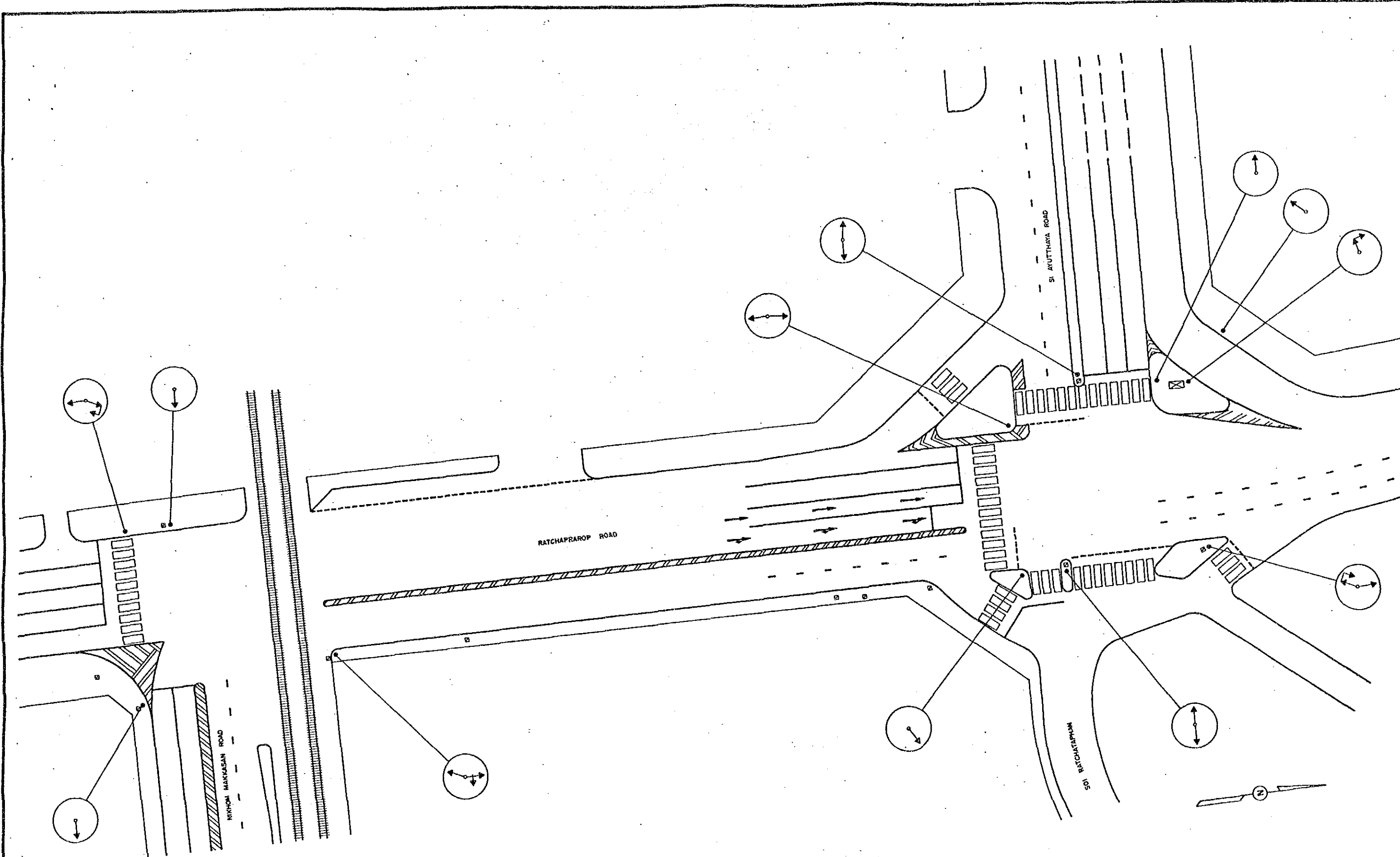

				BANGKOK AREA TRAFFIC CONTROL SYSTEM PROJECT : STAGE I			
				INTERSECTION EXISTING LAYOUT		Submitted By :	
				RATCHAPRAROP - SI AYUTTHAYA		Jiro Kodera JICA Study Team Leader	
				INTERSECTION NO 143		Approved By :	
				JICA		Boonyarat Titus BMA Study Team Leader	
Code		Survey		Date		Scale 1 / 250	
Associated Plan No. :		JICA Japan International Cooperation Agency		BMA Bangkok Metropolitan Administration		Drawing No 5143	
						Date SEPTEMBER '90	
						Total 93 / 143	

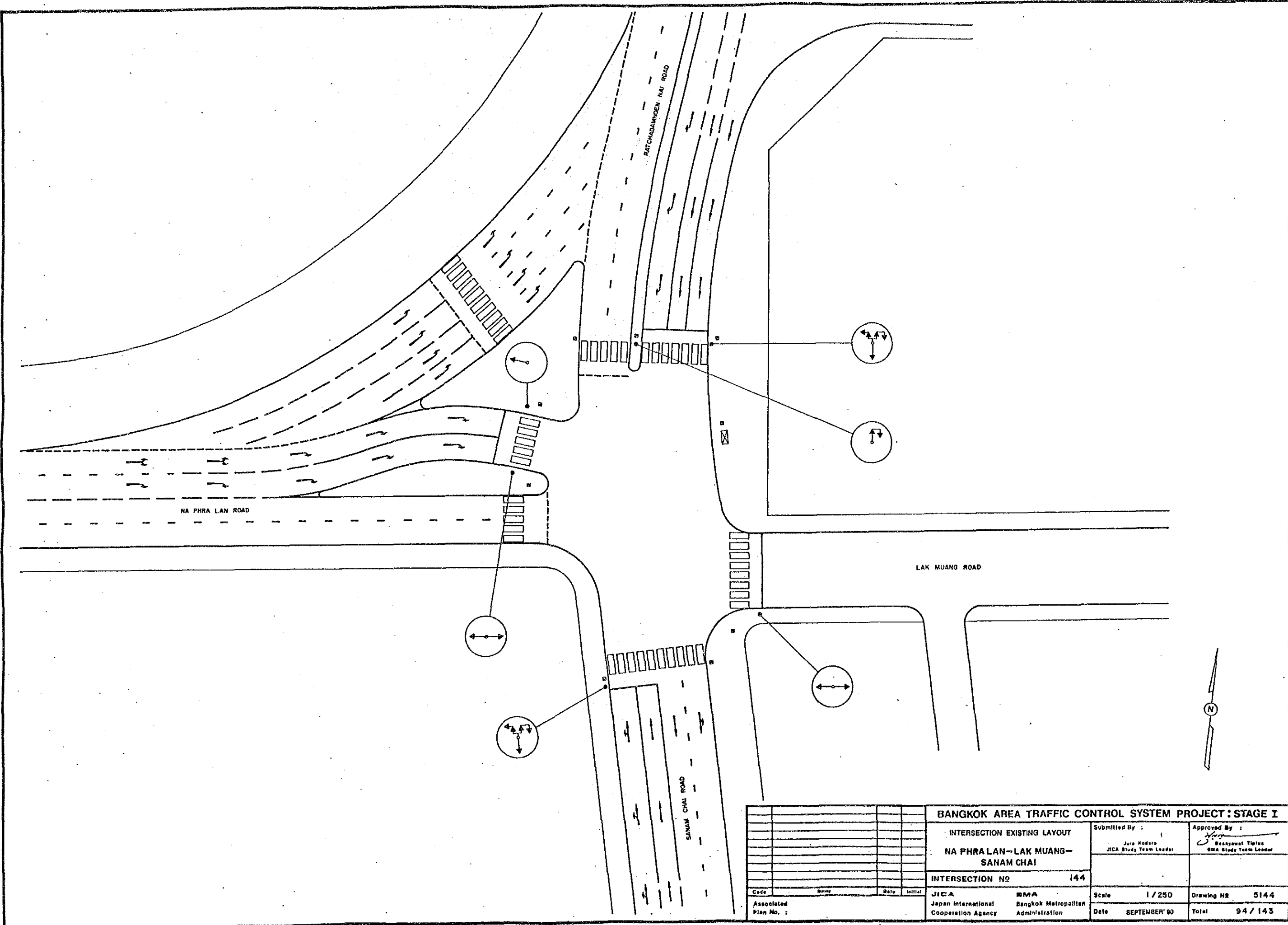

BANGKOK AREA TRAFFIC CONTROL SYSTEM PROJECT : STAGE I			
INTERSECTION EXISTING LAYOUT		Submitted By :	Approved By :
NA PHRA LAN-LAK MUANG-SANAM CHAI		Jiro Kodera JICA Study Team Leader	<i>[Signature]</i> Sasayama Tetsuo BMA Study Team Leader
INTERSECTION NO 144			
Code	Survey	Date	Initial
Associated Plan No. :	JICA Japan International Cooperation Agency	BMA Bangkok Metropolitan Administration	Scale 1/250 Date SEPTEMBER '90
			Drawing No 5144 Total 94 / 143

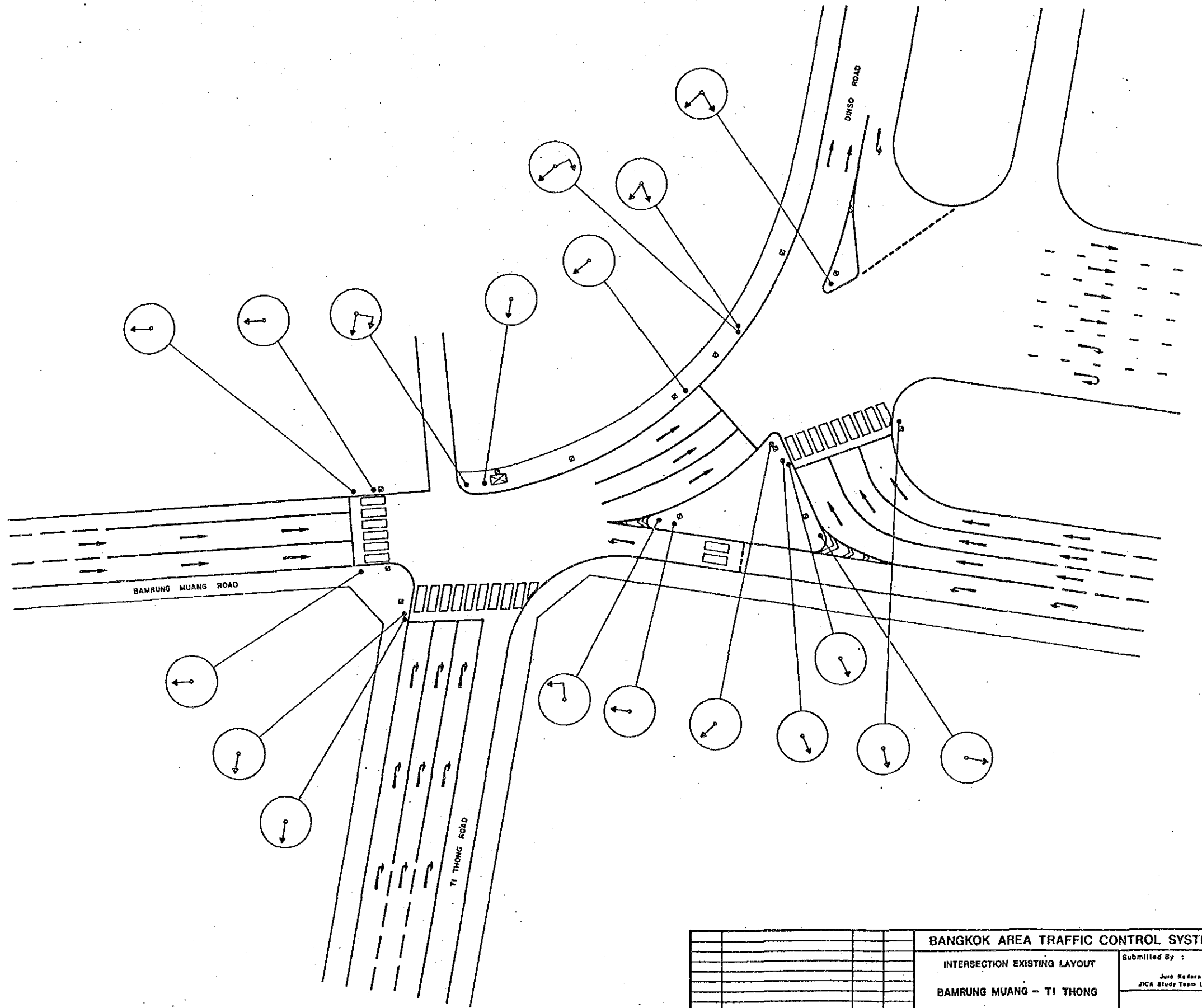

BANGKOK AREA TRAFFIC CONTROL SYSTEM PROJECT : STAGE I			
INTERSECTION EXISTING LAYOUT		Submitted By :	Approved By :
BAMRUNG MUANG - TI THONG		Juro Kodera JICA Study Team Leader	<i>Juro</i> Boonswat Tiplua BMA Study Team Leader
INTERSECTION NO 147			
Code	Survey	Date	Initial
Associated Plan No. :		JICA Japan International Cooperation Agency	BMA Bangkok Metropolitan Administration
		Scale	1 / 250
		Date	SEPTEMBER '90
		Drawing NR	5147
		Total	95 / 143

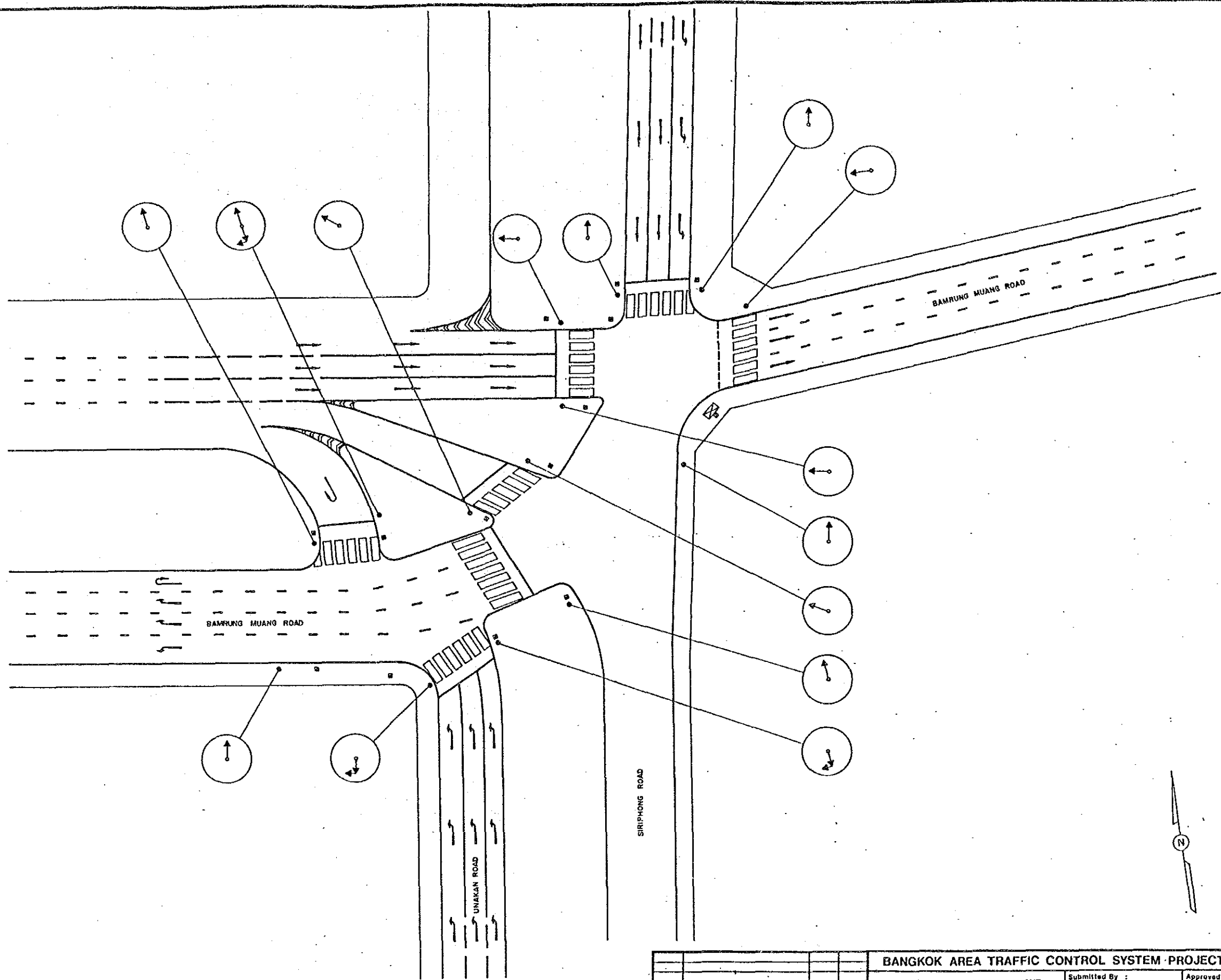

BANGKOK AREA TRAFFIC CONTROL SYSTEM PROJECT : STAGE I									
INTERSECTION EXISTING LAYOUT BAMRUNG MUANG - UNAKAN					Submitted By :		Approved By :		
					Juro Nudata JICA Study Team Leader		 Jirongwat Tiplua BMA Study Team Leader		
INTERSECTION N ^o 148					Scale 1 / 250		Drawing N ^o 5148		
Code _____ Survey _____ Date _____ Initial _____ Associated Plan No. : _____					JICA Japan International Cooperation Agency		BMA Bangkok Metropolitan Administration		Date SEPTEMBER '90 Total 96 / 143

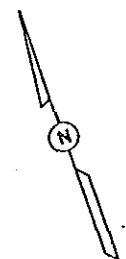
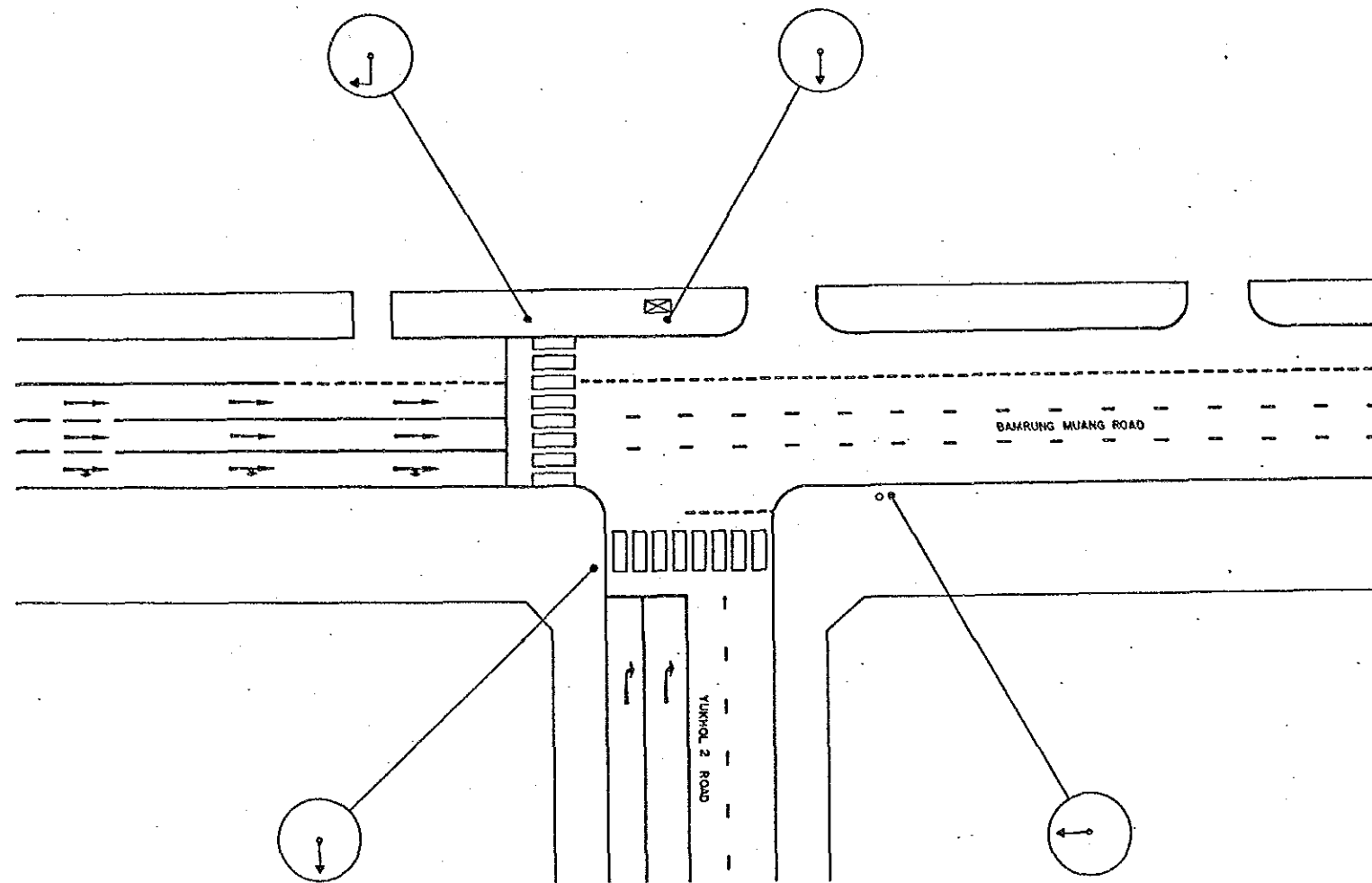

BANGKOK AREA TRAFFIC CONTROL SYSTEM PROJECT : STAGE I			
		INTERSECTION EXISTING LAYOUT	Submitted By : Jun Kadera JICA Study Team Leader
		YUKHOL 2 - BAMRUNG MUANG	Approved By : <i>[Signature]</i> Boonsawat Tiplas BMA Study Team Leader
		INTERSECTION NO 160	
Cada	Draw	Date	Initial
Associated Plan No. :	JICA Japan International Cooperation Agency	BMA Bangkok Metropolitan Administration	Scale 1 / 250 Date SEPTEMBER '90
		Drawing No 5160	Total 97 / 143

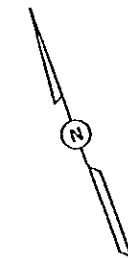
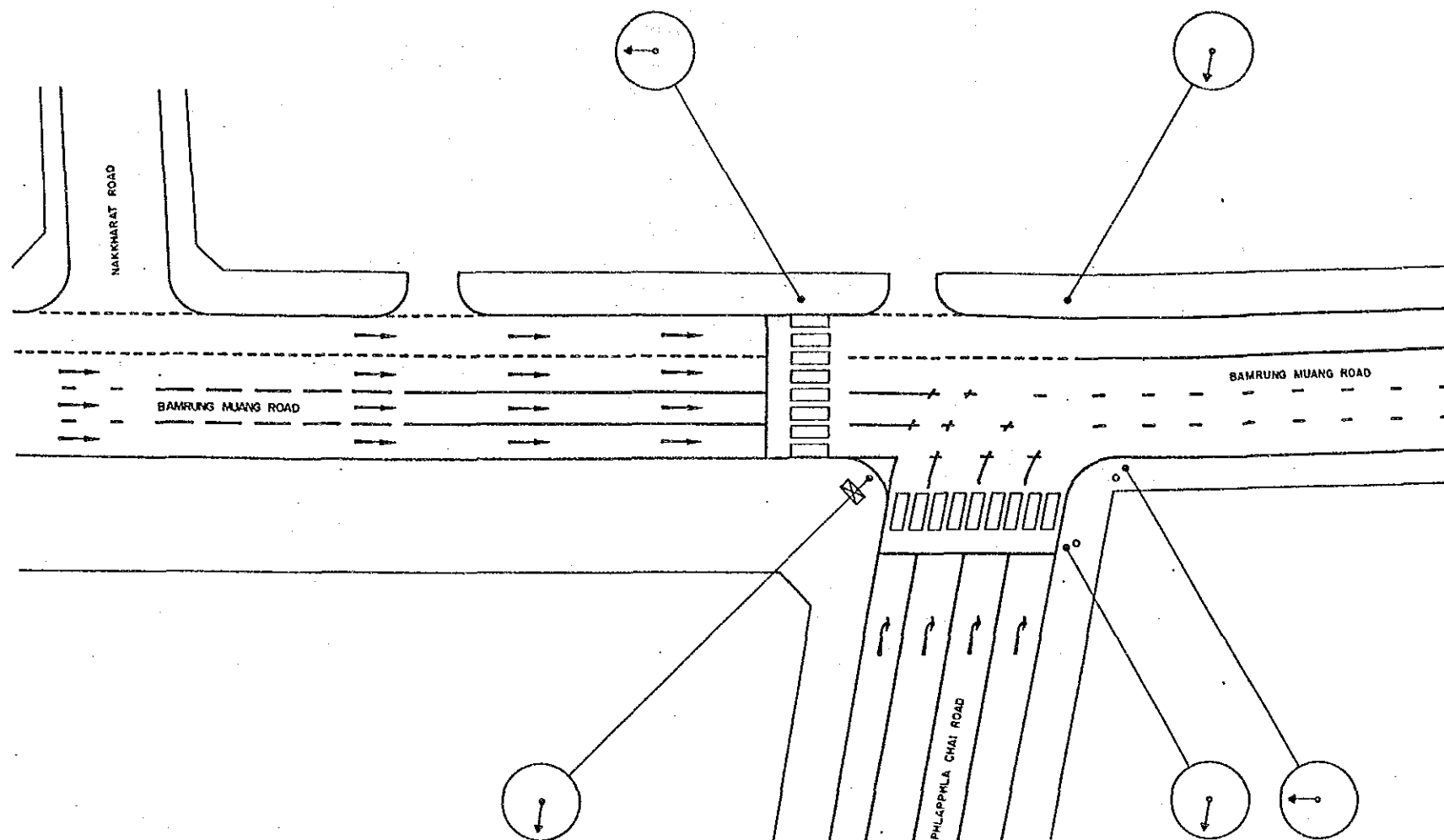

BANGKOK AREA TRAFFIC CONTROL SYSTEM PROJECT : STAGE I			
INTERSECTION EXISTING LAYOUT		Submitted By :	Approved By :
PHLAPPLA CHAI - BAMRUNG MUANG		Jun Rodon JICA Study Team Leader	<i>[Signature]</i> Boonyarat Titlus BMA Study Team Leader
INTERSECTION NO 161			
Code	Survey	Date	Initial
Associated Plan No. :	JICA Japan International Cooperation Agency	BMA Bangkok Metropolitan Administration	Scale 1/250 Date SEPTEMBER '90 Drawing NR 5161 Total 98 / 143

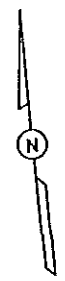
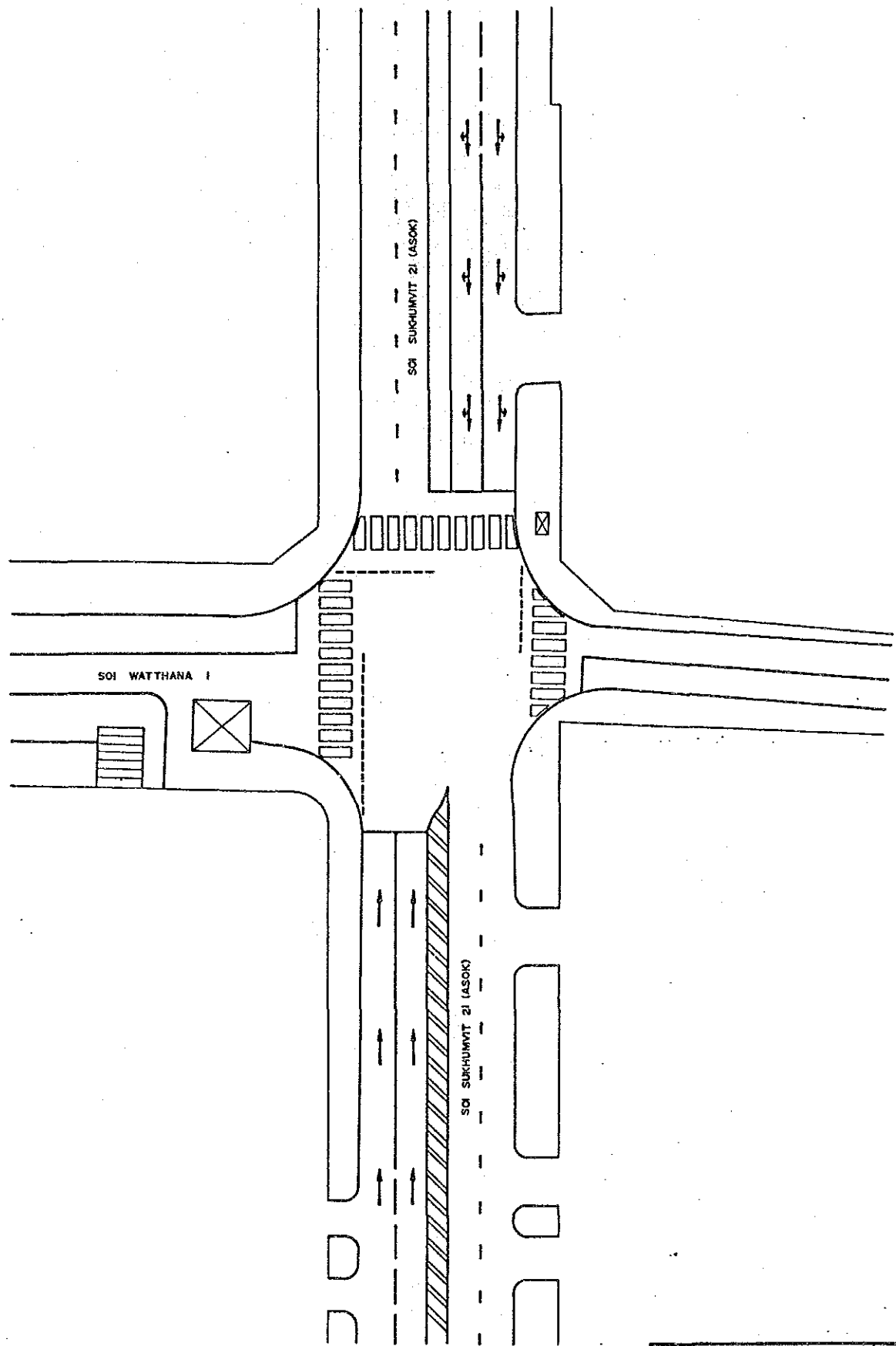

				BANGKOK AREA TRAFFIC CONTROL SYSTEM PROJECT: STAGE I			
				INTERSECTION EXISTING LAYOUT		Submitted By :	Approved By :
				SOI SUKHUMVIT 21 (ASOK) - SOI WATTHANA 1		Jiro Kodera JICA Study Team Leader	<i>[Signature]</i> Boonyarat Tiptua BMA Study Team Leader
				INTERSECTION NO	162		
Code	Survey	Date	Initial	JICA	BMA	Scale	Drawing No
Associated Plan No. :				Japan International Cooperation Agency	Bangkok Metropolitan Administration	1 / 250	5162
						Date	Total
						SEPTEMBER '90	99 / 143

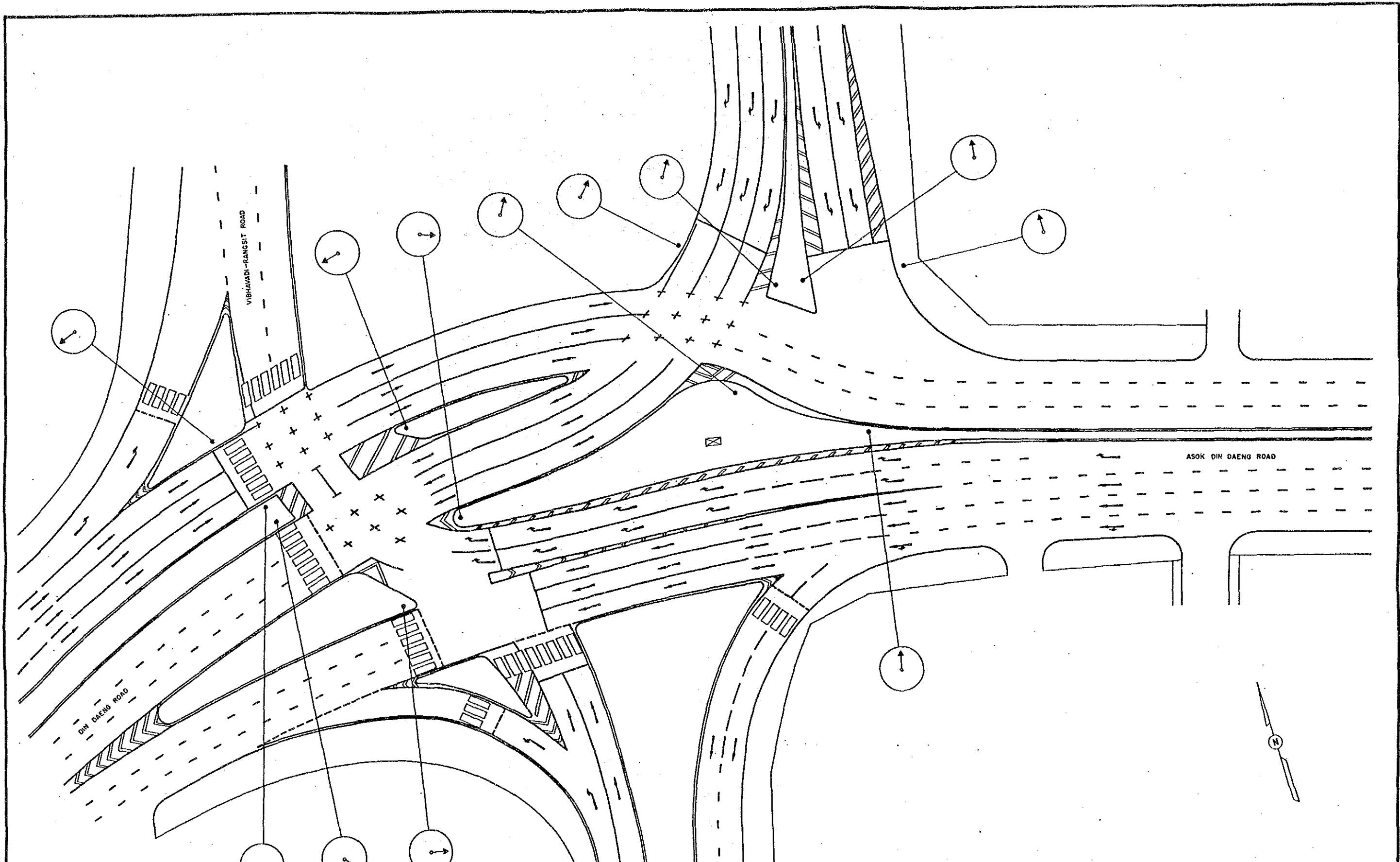

				BANGKOK AREA TRAFFIC CONTROL SYSTEM PROJECT : STAGE I			
				INTERSECTION EXISTING LAYOUT		Submitted By :	
				VIBHAVADI RANGSIT - DIN DAENG		Jura Kodera JICA Study Team Leader	
				INTERSECTION N2 163		Approved By :	
						Somyawat Tiplua SMA Study Team Leader	
Code	Survey	Date	Initial	JICA	SMA	Scale	1 / 250
Associated Plan No. :				Japan International Cooperation Agency	Bangkok Metropolitan Administration	Drawing No	5163
						Date	SEPTEMBER '90
						Total	100 / 143

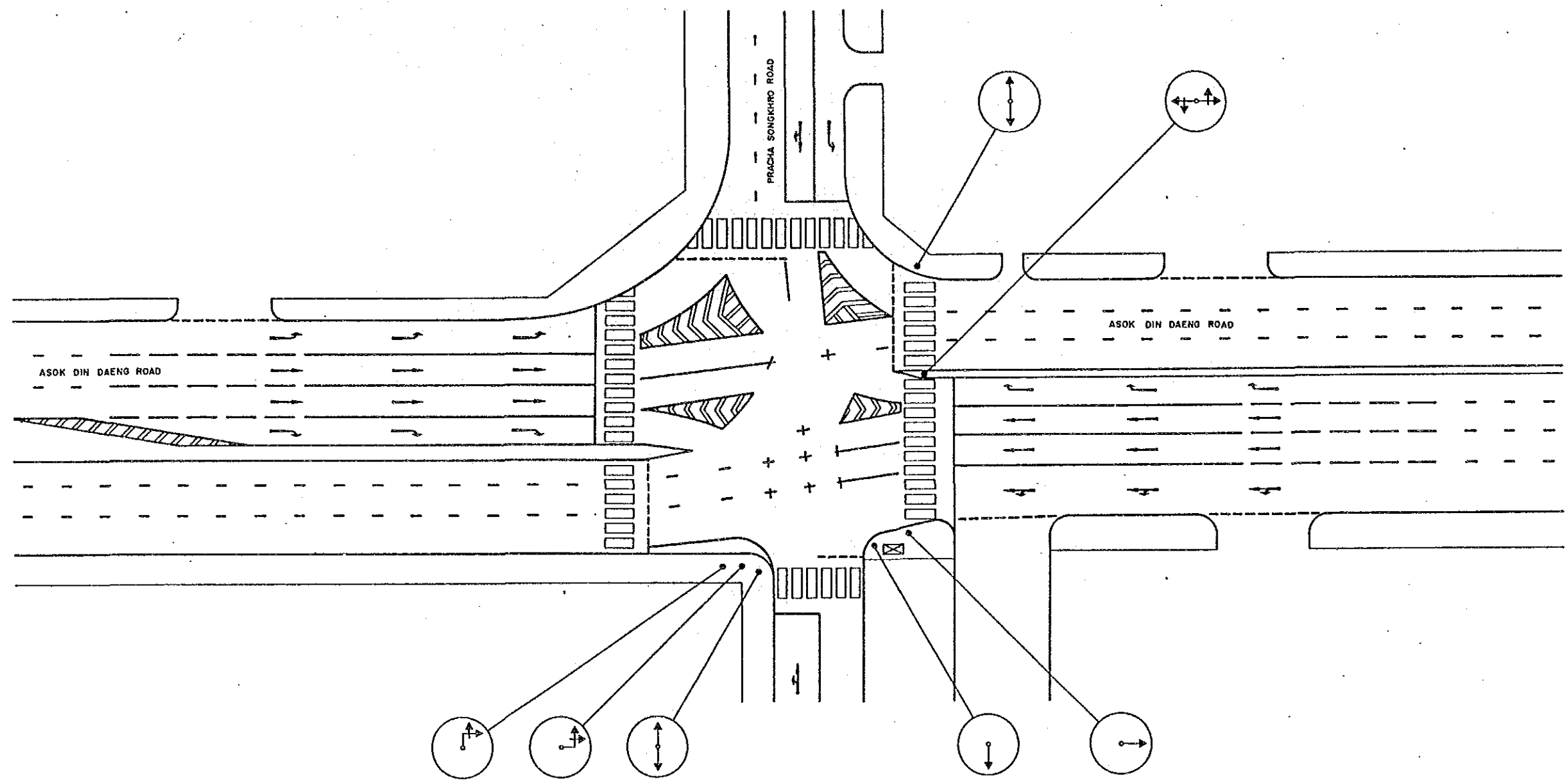

BANGKOK AREA TRAFFIC CONTROL SYSTEM PROJECT : STAGE I										
INTERSECTION EXISTING LAYOUT PRACHA SONGKHRO — ASOK DIN DAENG					Submitted By :		Approved By :			
					Jiro Kidera JICA Study Team Leader		Somsawat Titlus SMA Study Team Leader			
INTERSECTION N ^o 164										
Code	Survey	Date	Initial	JICA	SMA	Scale	1 / 250		Drawing No	5164
Associated Plan No. :				Japan International Cooperation Agency	Bangkok Metropolitan Administration	Date	SEPTEMBER '90		Total	101 / 143

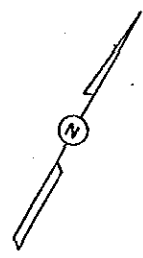
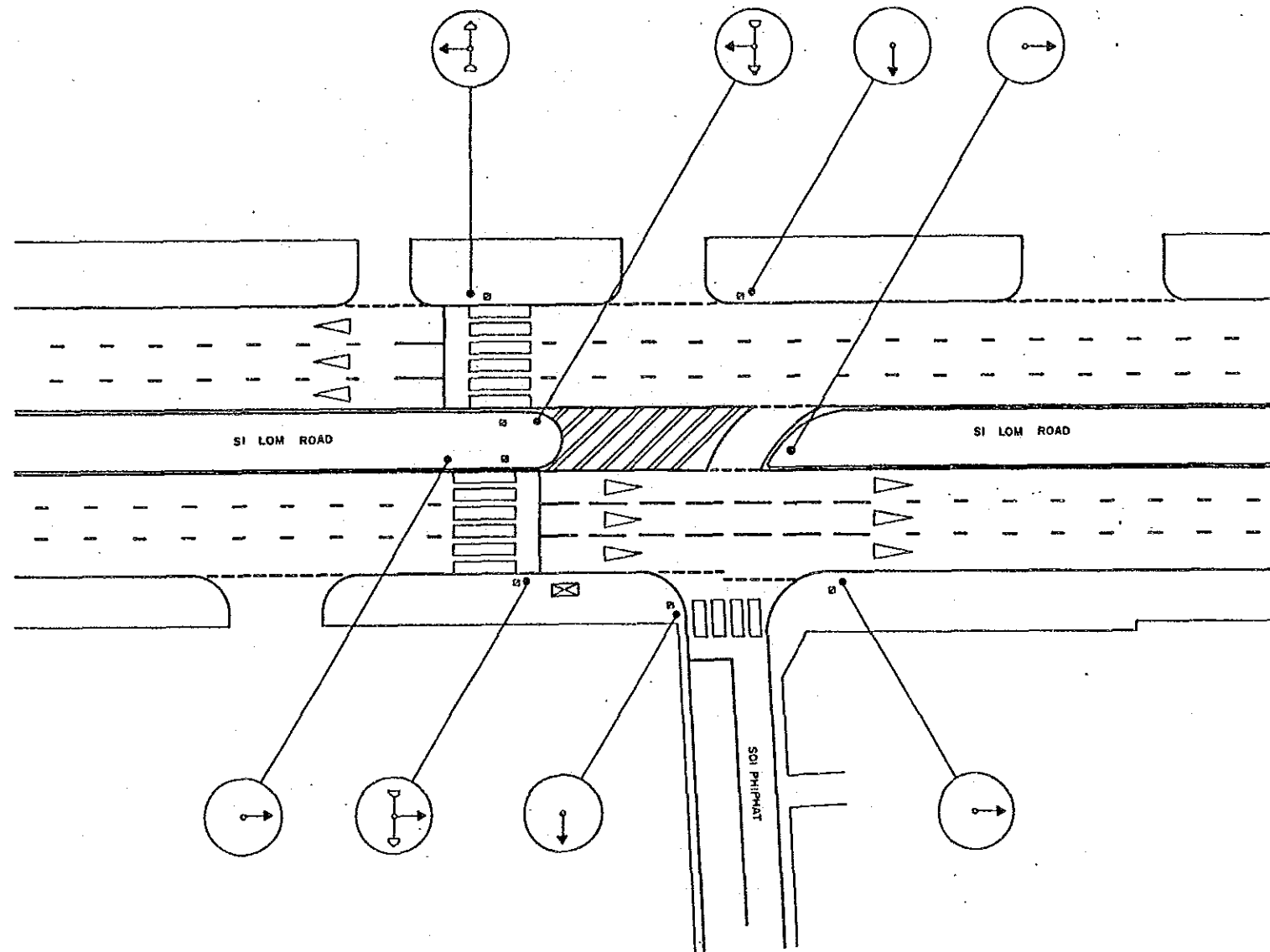

BANGKOK AREA TRAFFIC CONTROL SYSTEM PROJECT : STAGE I			
INTERSECTION EXISTING LAYOUT		Submitted By :	Approved By :
SI LOM-SOI PHIPHAT (BANGKOK BANK)		Jiro Kodera JICA Study Team Leader	<i>[Signature]</i> Boonyawat Tiptua BMA Study Team Leader
INTERSECTION NO		175	
Code	Rev	Date	Initial
Associated Plan No. :		JICA Japan International Cooperation Agency	BMA Bangkok Metropolitan Administration
		Scale	1 / 250
		Date	SEPTEMBER '90
		Drawing No	5175
		Total	102 / 143

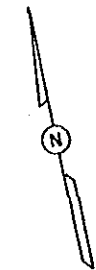
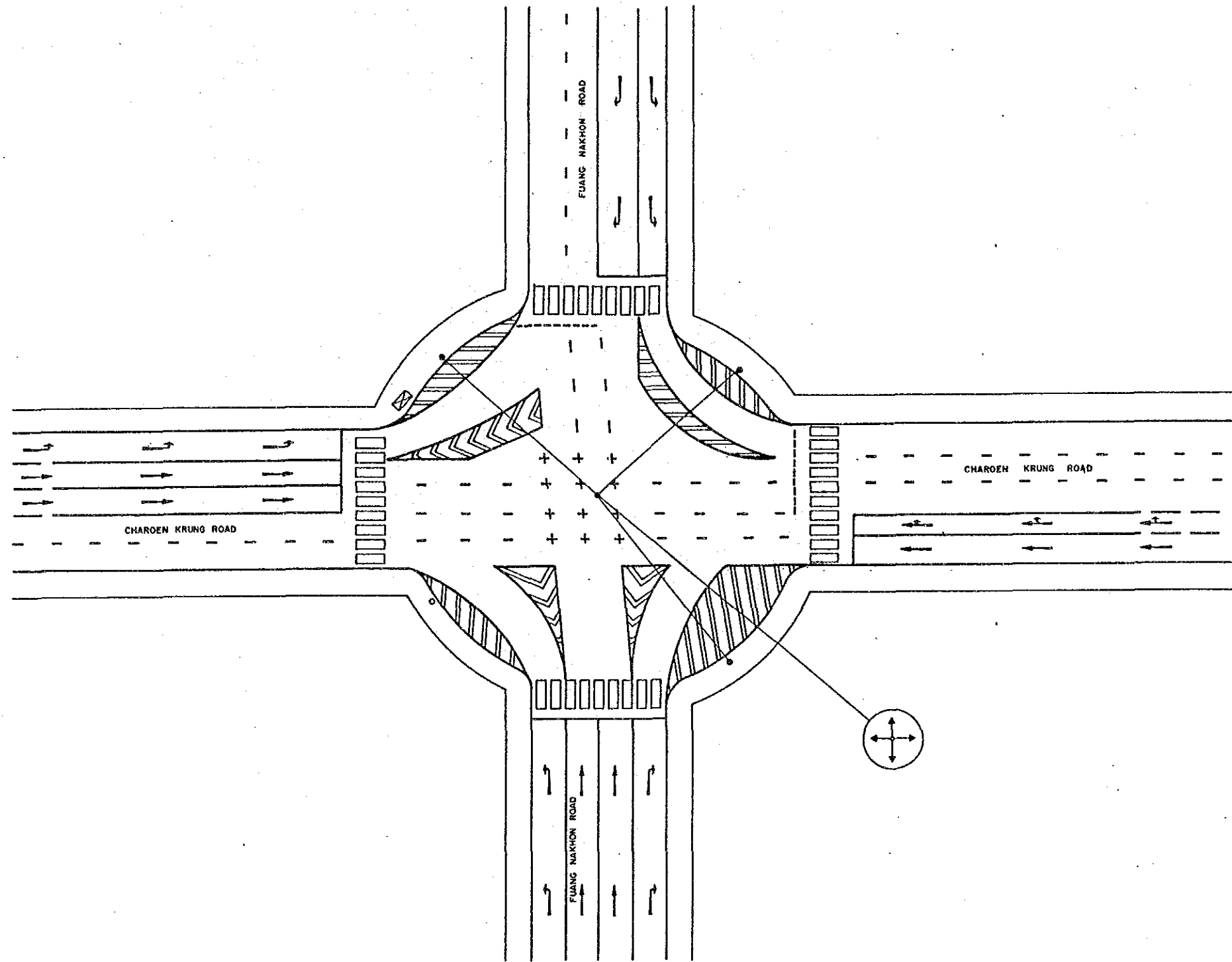

BANGKOK AREA TRAFFIC CONTROL SYSTEM PROJECT : STAGE I			
INTERSECTION EXISTING LAYOUT		Submitted By :	Approved By :
FUANG NAKHON - CHAROEN KRUNG		Juro Kodera JICA Study Team Leader	Boonsawat Titus BMA Study Team Leader
INTERSECTION NO 176			
Code	Survey	Date	Initial
Associated Plan No. :		JICA Japan International Cooperation Agency	BMA Bangkok Metropolitan Administration
		Scale 1 / 250	Drawing No 5176
		Date SEPTEMBER '90	Total 103 / 143

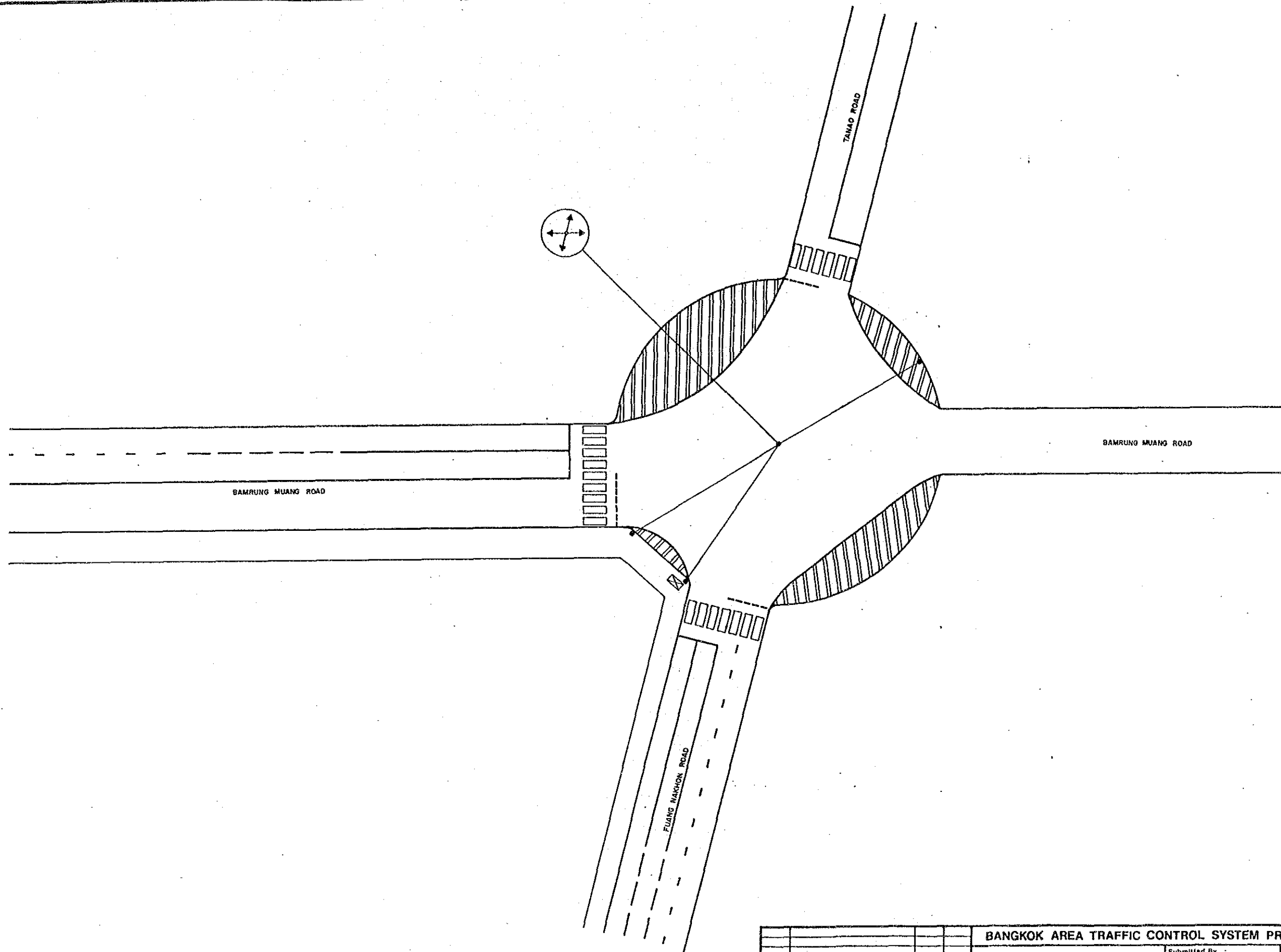

BANGKOK AREA TRAFFIC CONTROL SYSTEM PROJECT : STAGE I			
INTERSECTION EXISTING LAYOUT		Submitted By :	Approved By :
TANAO-BAMRUNG MUANG-FUANG NAKHON		Juro Kodera JICA Study Team Leader	<i>[Signature]</i> Boonpawel Tiplas PMA Study Team Leader
INTERSECTION NO . 177			
Case	Survey	Date	Initial
Associated Plan No. :	JICA Japan International Cooperation Agency	SMA Bangkok Metropolitan Administration	Scale 1 / 250 Date SEPTEMBER '90
			Drawing NO 5177 Total 104 / 143

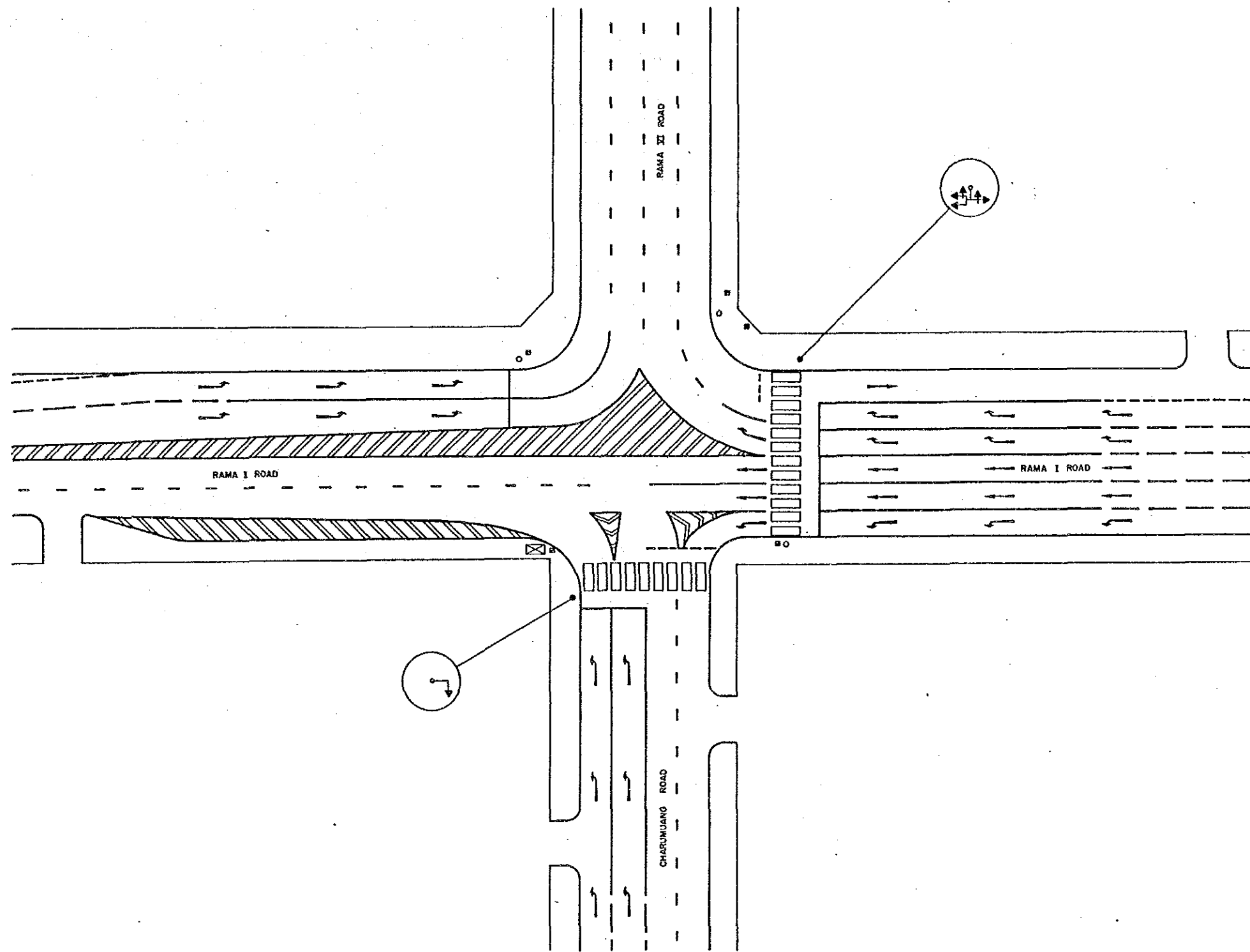

BANGKOK AREA TRAFFIC CONTROL SYSTEM PROJECT : STAGE I			
INTERSECTION EXISTING LAYOUT		Submitted By :	Approved By :
RAMA I--RAMA VI--CHARU MUANG		Jiro Kodera JICA Study Team Leader	<i>[Signature]</i> Sanyawat Titus BMA Study Team Leader
INTERSECTION NO 184			
Code	Survey	Date	Initial
Associated Plan No. :		JICA Japan International Cooperation Agency	BMA Bangkok Metropolitan Administration
		Scale 1/250	Drawing No 5184
		Date SEPTEMBER '90	Total 105 / 143

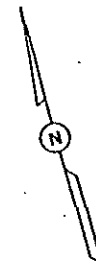
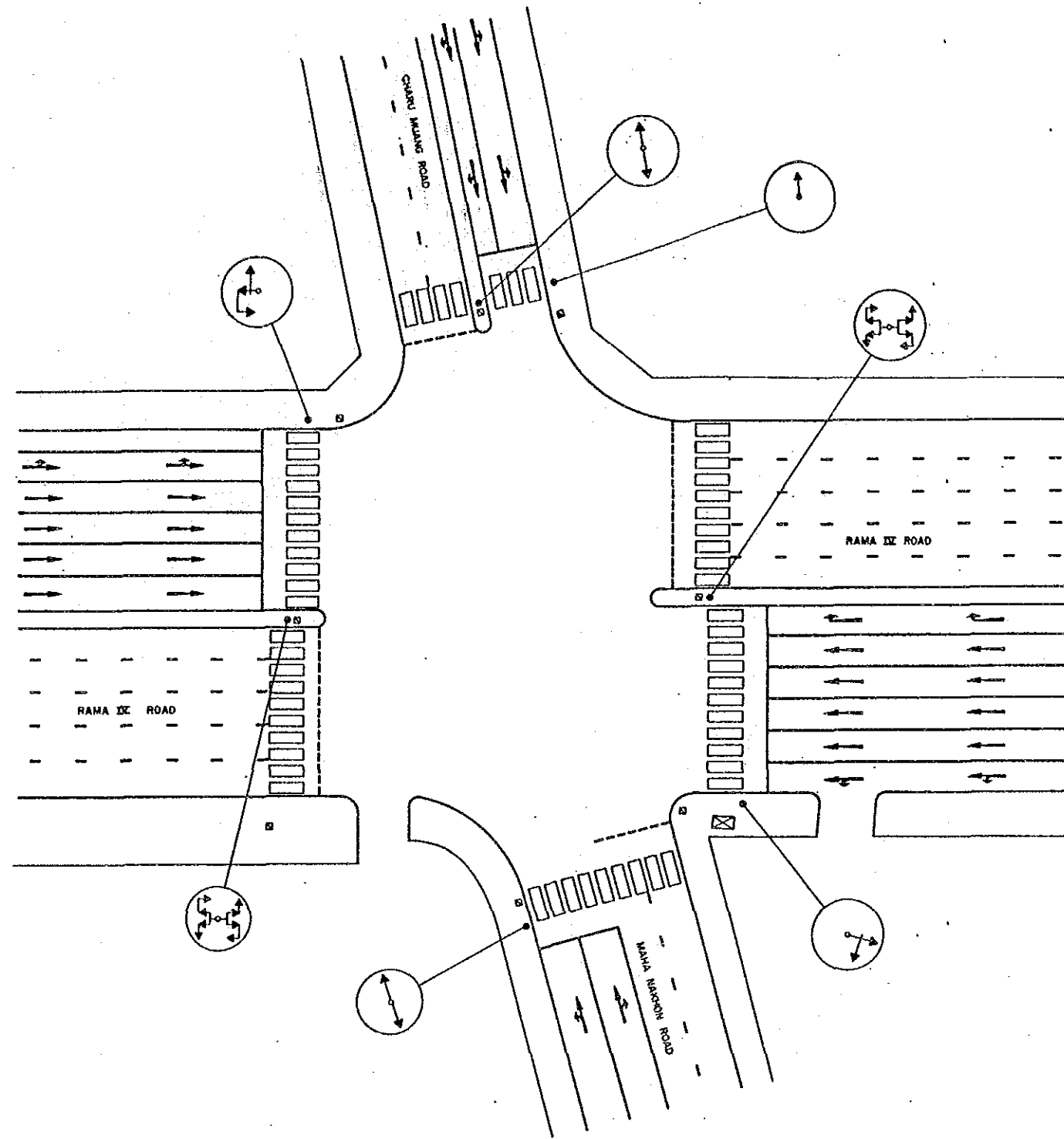

				BANGKOK AREA TRAFFIC CONTROL SYSTEM PROJECT: STAGE I			
				INTERSECTION EXISTING LAYOUT		Submitted By :	
				RAMA IV - CHARU MUANG - MAHA NAKHON		Approved By :	
				INTERSECTION NO 185		JICA Study Team Leader	
						Professional Title	
						BMA Study Team Leader	
				JICA		BMA	
				Japan International Cooperation Agency		Bangkok Metropolitan Administration	
Case				Summary		Date	
Associated Plan No. :				Scale		Drawing No.	
				1 / 250		5185	
				Date		Total	
				SEPTEMBER '90		106 / 143	

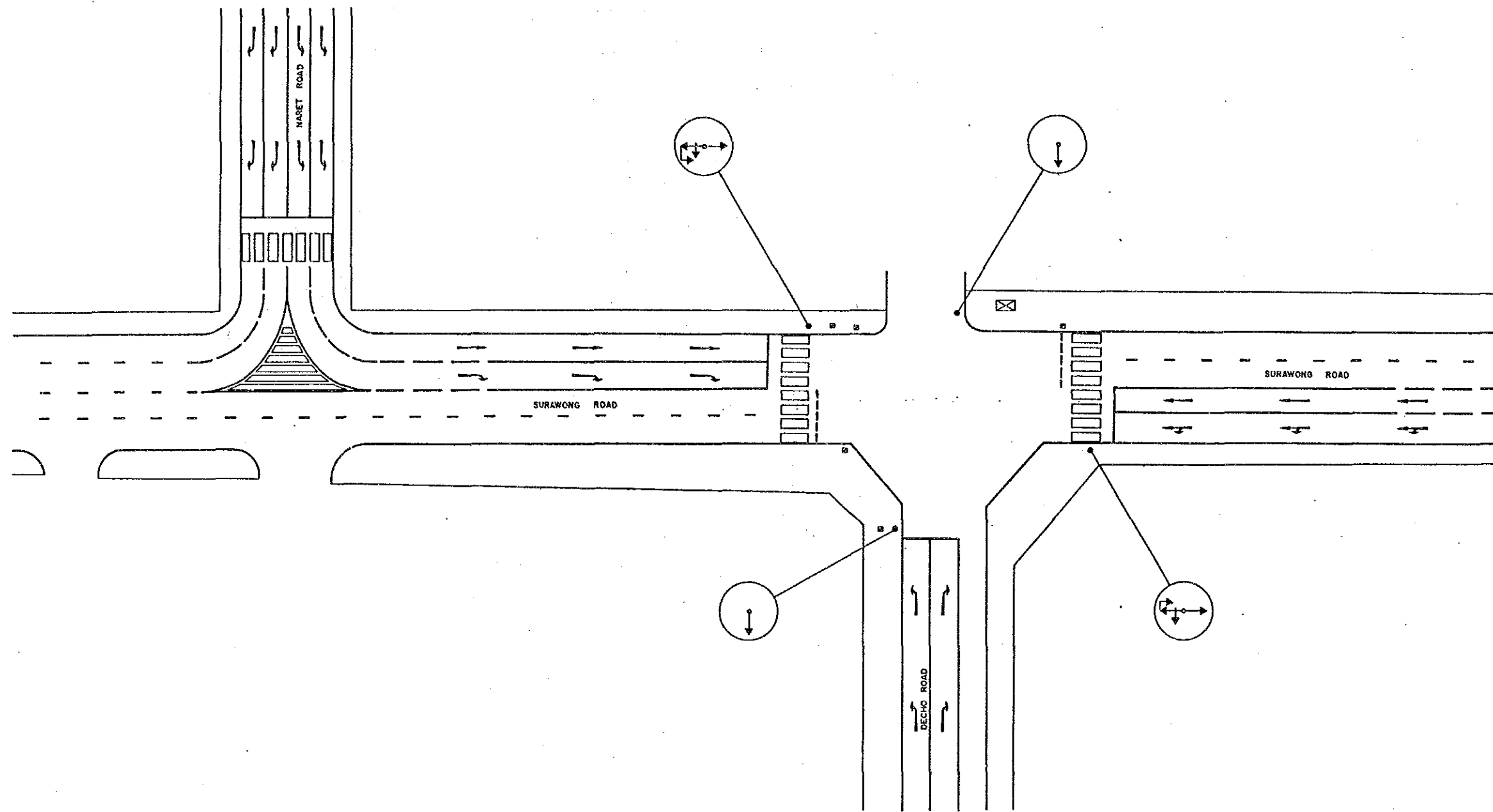

101

				BANGKOK AREA TRAFFIC CONTROL SYSTEM PROJECT: STAGE I			
				INTERSECTION EXISTING LAYOUT		Submitted By :	
				SURAWONG - DECHO		Jiro Kodera JICA Study Team Leader	
				INTERSECTION NO 188		Approved By :	
						Boonchai Tipton BMA Study Team Leader	
Case	Bunny	Date	Initial	JICA	BMA	Scale	Drawing No
Associated Plan No. :				Japan International Cooperation Agency	Bangkok Metropolitan Administration	1 / 250	5188
						Date	Total
						SEPTEMBER '90	107 / 143

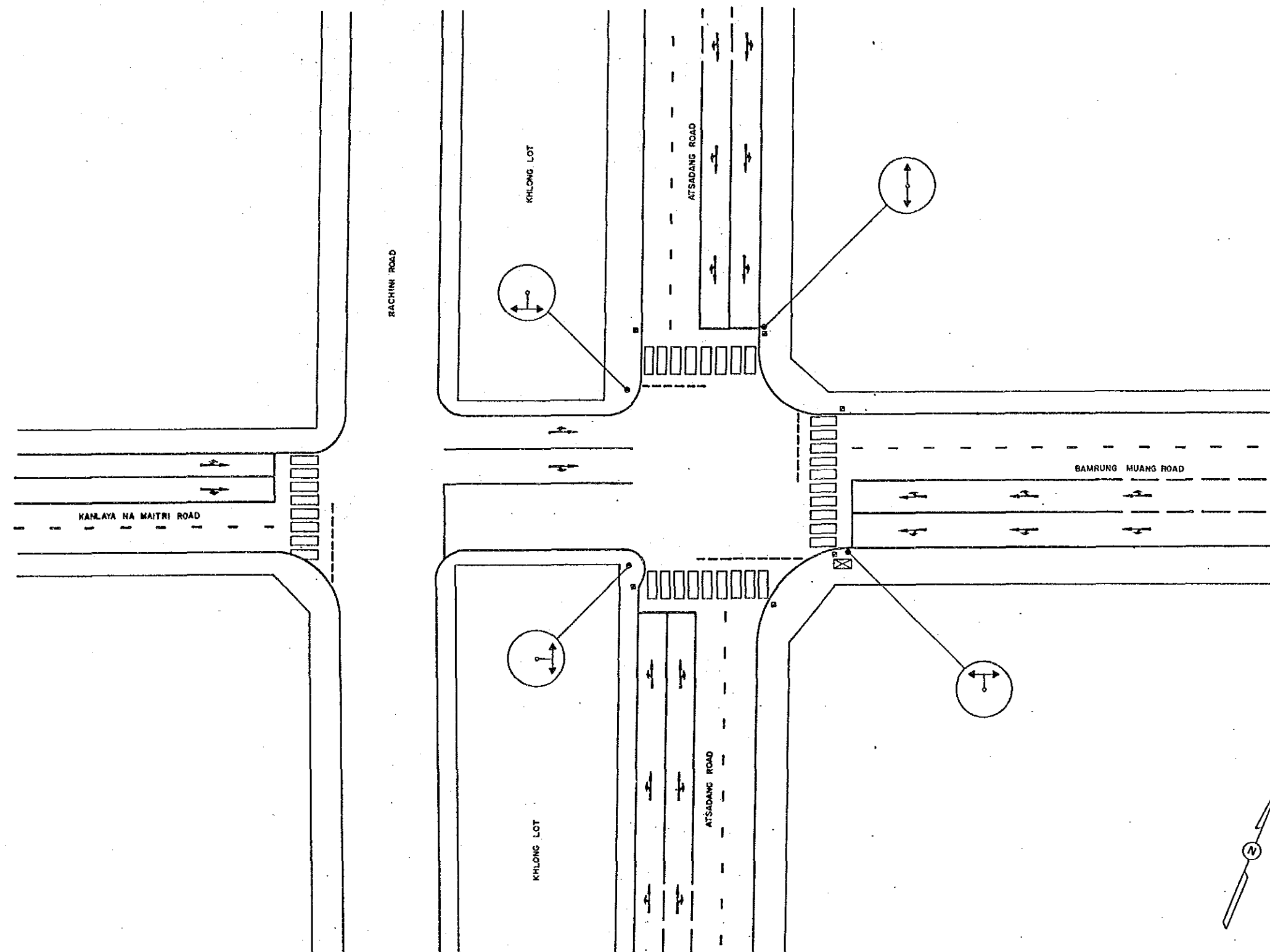

BANGKOK AREA TRAFFIC CONTROL SYSTEM PROJECT : STAGE I			
INTERSECTION EXISTING LAYOUT		Submitted By :	Approved By :
ATSADANG - BAMRUNG MUANG		Juro Kadera JICA Study Team Leader	<i>Juro Kadera</i> Roonsawat Tapin BMA Study Team Leader
INTERSECTION NO 189			
Case	Survey	Date	Initial
Associated Plan No. :		JICA Japan International Cooperation Agency	BMA Bangkok Metropolitan Administration
		Scale 1 / 250	Drawing No 5189
		Date SEPTEMBER '90	Total 108 / 143

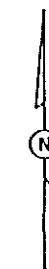
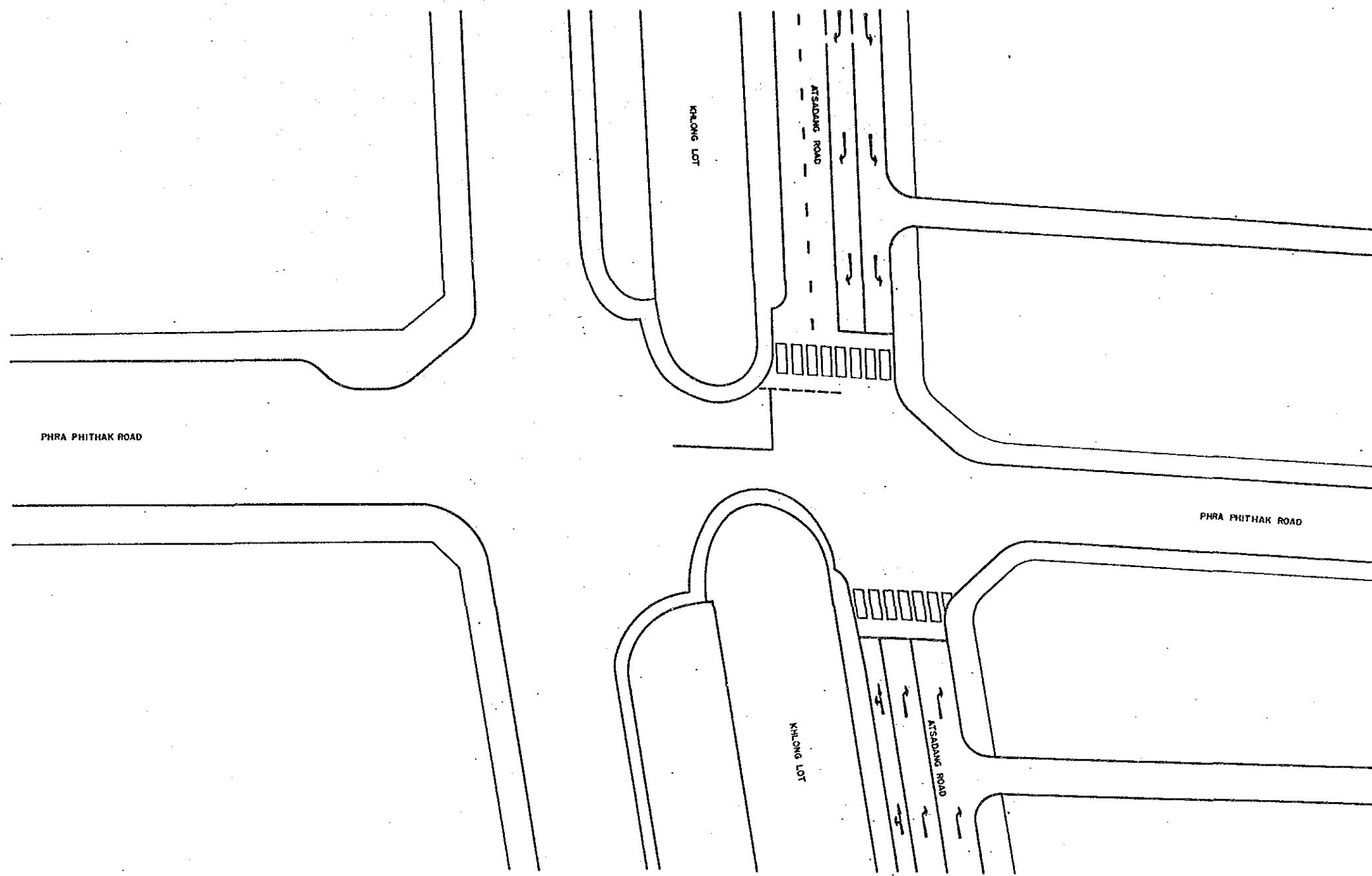

				BANGKOK AREA TRAFFIC CONTROL SYSTEM PROJECT : STAGE I			
				INTERSECTION EXISTING LAYOUT		Submitted By :	Approved By :
				ATSDANG-PHRA PHITHAK		Jira Kodera JICA Study Team Leader	<i>[Signature]</i> Boonchorn Tiptee BMA Study Team Leader
				INTERSECTION NO		191	
Code	Survey	Date	Initial	JICA	BMA	Scale	1 / 250
Associated Plan No. 1				Japan International Cooperation Agency	Bangkok Metropolitan Administration	Date	SEPTEMBER '90
						Drawing NO	5191
						Total	109 / 143

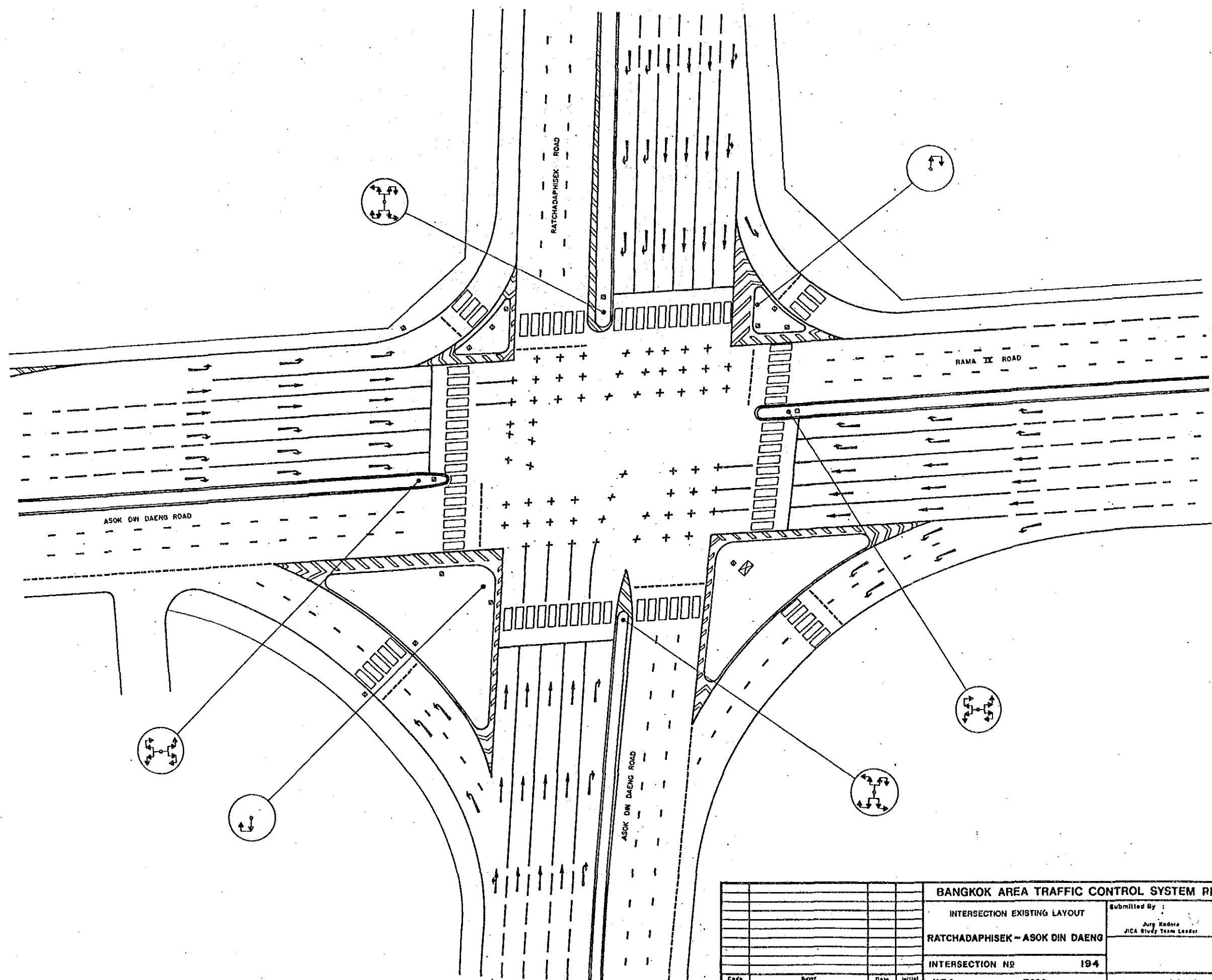

BANGKOK AREA TRAFFIC CONTROL SYSTEM PROJECT : STAGE I									
INTERSECTION EXISTING LAYOUT						Submitted By :		Approved By :	
RATCHADAPHISEK - ASOK DIN DAENG						Jung Kudara JICA Study Team Leader		Boonswat Yitua BMA Study Team Leader	
INTERSECTION NO						194			
Case	Survey	Date	Initial	JICA		BMA		Scale	1 / 250
Associated Plan No. :				JICA Japan International Cooperation Agency		BMA Bangkok Metropolitan Administration		Date	SEPTEMBER '80
						Drawing No		5194	
						Total		110 / 143	

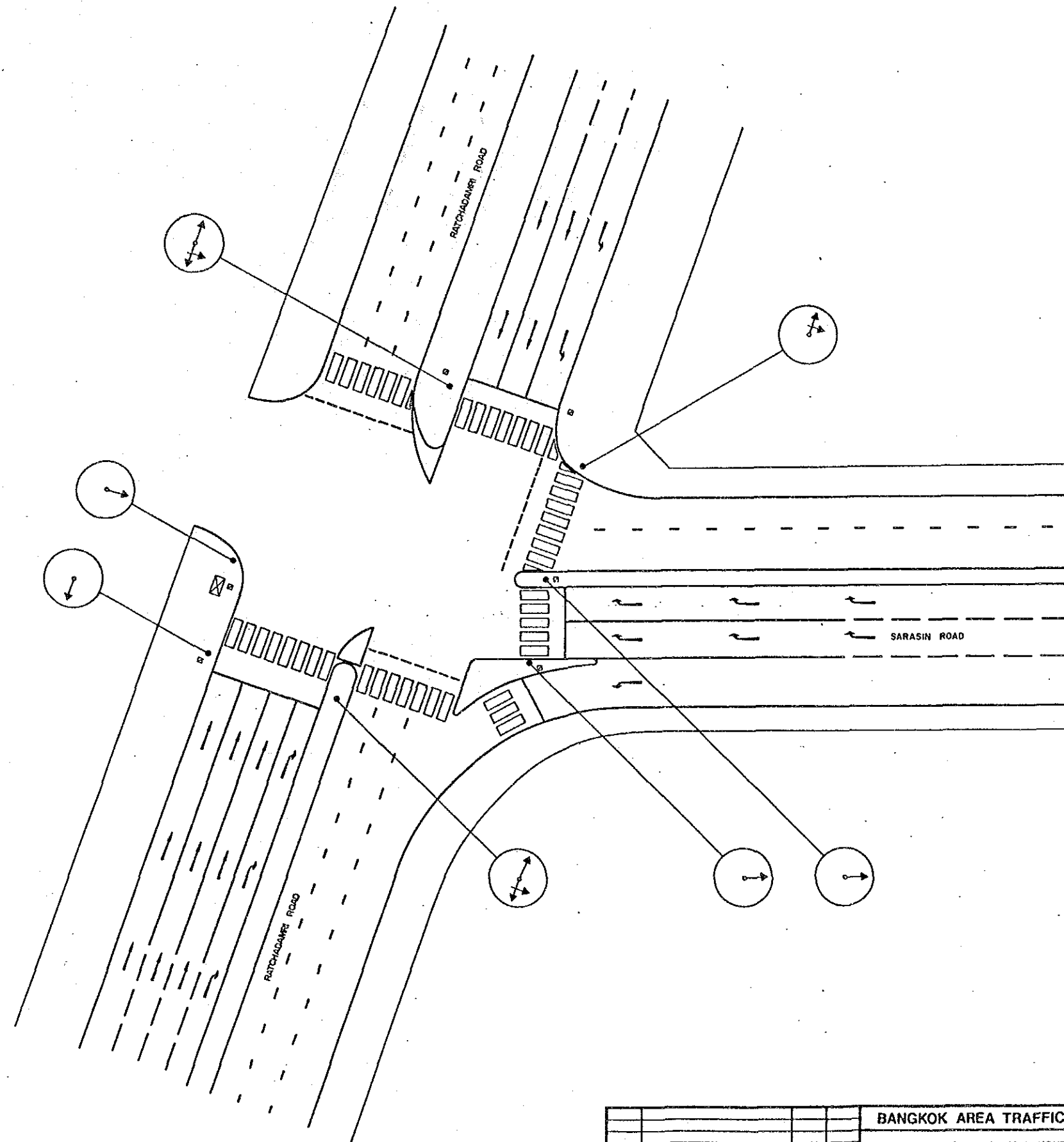

BANGKOK AREA TRAFFIC CONTROL SYSTEM PROJECT : STAGE I			
INTERSECTION EXISTING LAYOUT		Submitted By :	Approved By :
SARASIN - RATCHADAMRI		Jira Kudara JICA Study Team Leader	<i>[Signature]</i> Boonyarat Titluw BMA Study Team Leader
INTERSECTION N ^o 196			
Code	Survey	Date	Initial
Associated Plan No. :	JICA Japan International Cooperation Agency	BMA Bangkok Metropolitan Administration	Scale 1/250 Date SEPTEMBER '90
		Drawing N ^o 5196	Total 111 / 143

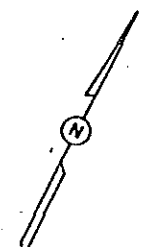
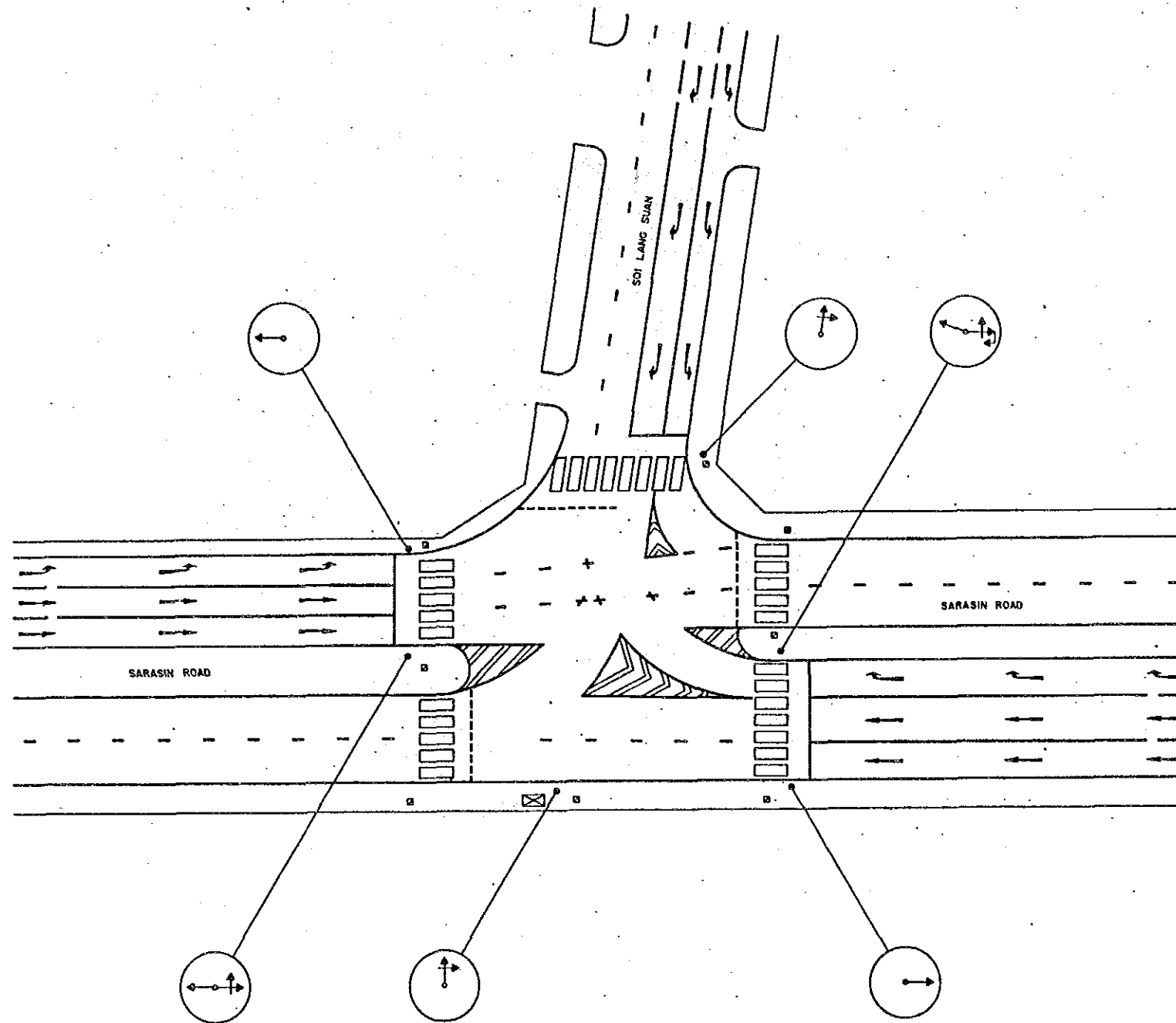

BANGKOK AREA TRAFFIC CONTROL SYSTEM PROJECT : STAGE I			
INTERSECTION EXISTING LAYOUT		Submitted By :	Approved By :
SARASIN - SOI LANG SUAN		Jiro Kodera JICA Study Team Leader	Boonpradit Thipha BMA Study Team Leader
INTERSECTION NO 197			
Code	Survey	Date	Initial
Associated Plan No. :		JICA Japan International Cooperation Agency	BMA Bangkok Metropolitan Administration
		Scale 1 / 250	Drawing NO 5197
		Date SEPTEMBER '90	Total 112 / 143

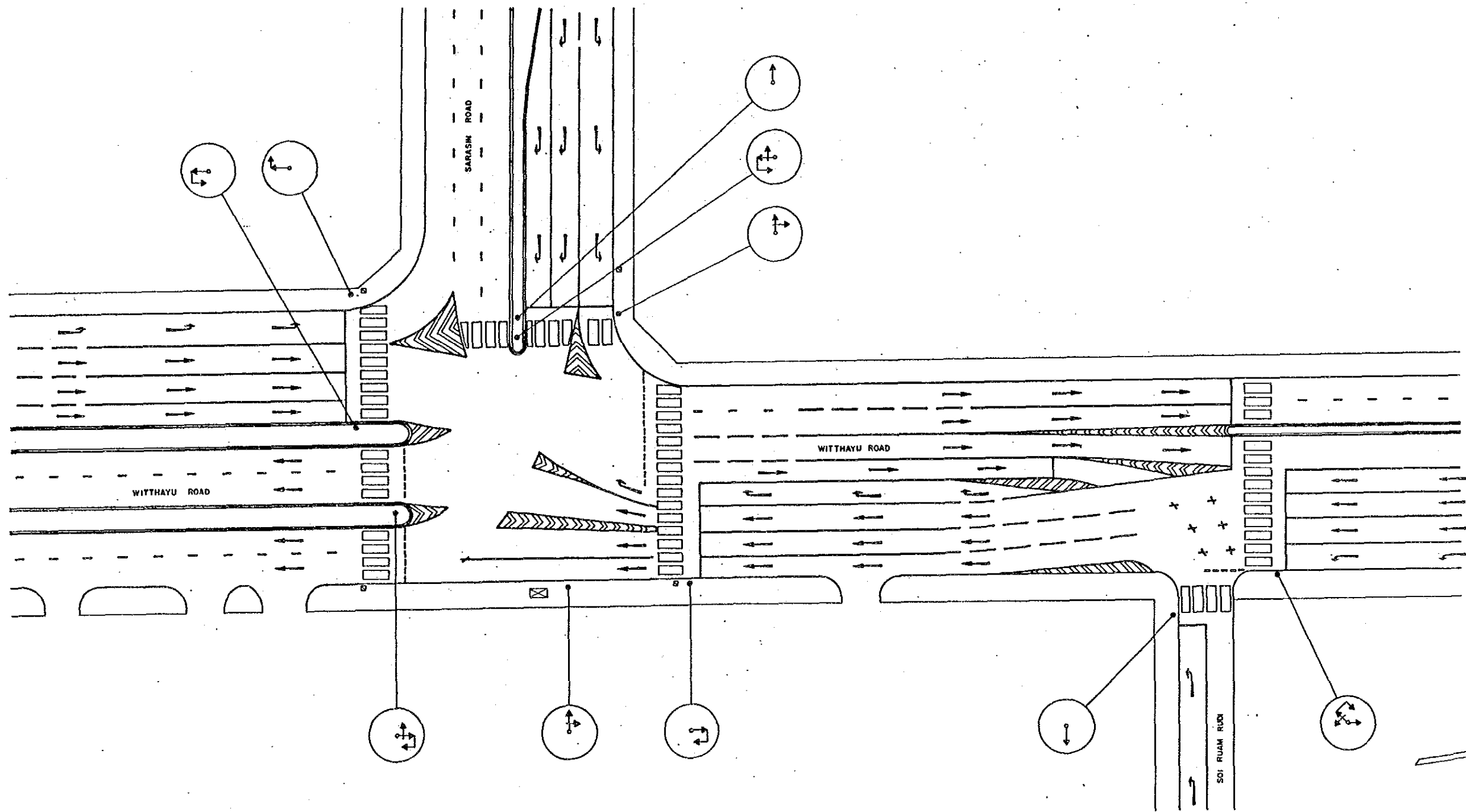

				BANGKOK AREA TRAFFIC CONTROL SYSTEM PROJECT: STAGE I			
				INTERSECTION EXISTING LAYOUT		Submitted By :	
				SARASIN - WITTHAYU -		Jiro Kodera JICA Study Team Leader	
				SOI RUAM RUDI		Approved By :	
				INTERSECTION NO 198		S. Jitkumthorn SMA Study Team Leader	
Code	Survey	Date	Initial	JICA	BMA	Scale	Drawing No
Associated Plan No. :				Japan International Cooperation Agency	Bangkok Metropolitan Administration	1 / 250	5198
						Date	Total
						SEPTEMBER '90	113 / 143

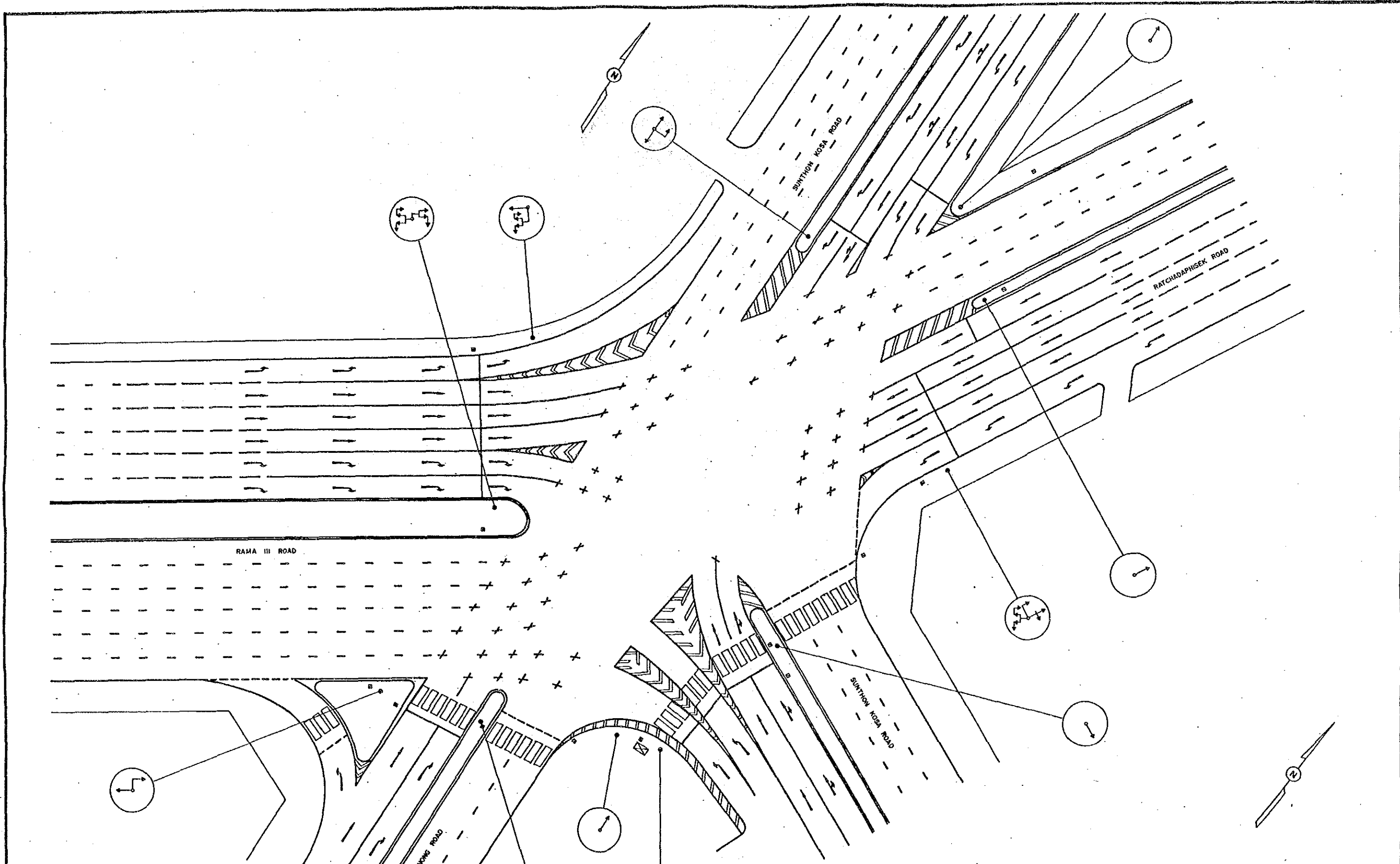

				BANGKOK AREA TRAFFIC CONTROL SYSTEM PROJECT : STAGE I			
				INTERSECTION EXISTING LAYOUT		Submitted By :	Approved By :
				RATCHADAPHISEK-SUNTHON KOSA- RAMA III-NA RANONG		Jun Kudara JICA Study Team Leader	<i>[Signature]</i> Sasawat Titus BMA Study Team Leader
				INTERSECTION NO		199	
Case	Survey	Date	Initial	JICA	BMA	Scale	Drawing No
Associated Plan No. :				Japan International Cooperation Agency	Bangkok Metropolitan Administration	1 / 250	5199
						Date	Total
						SEPTEMBER '90	114 / 143

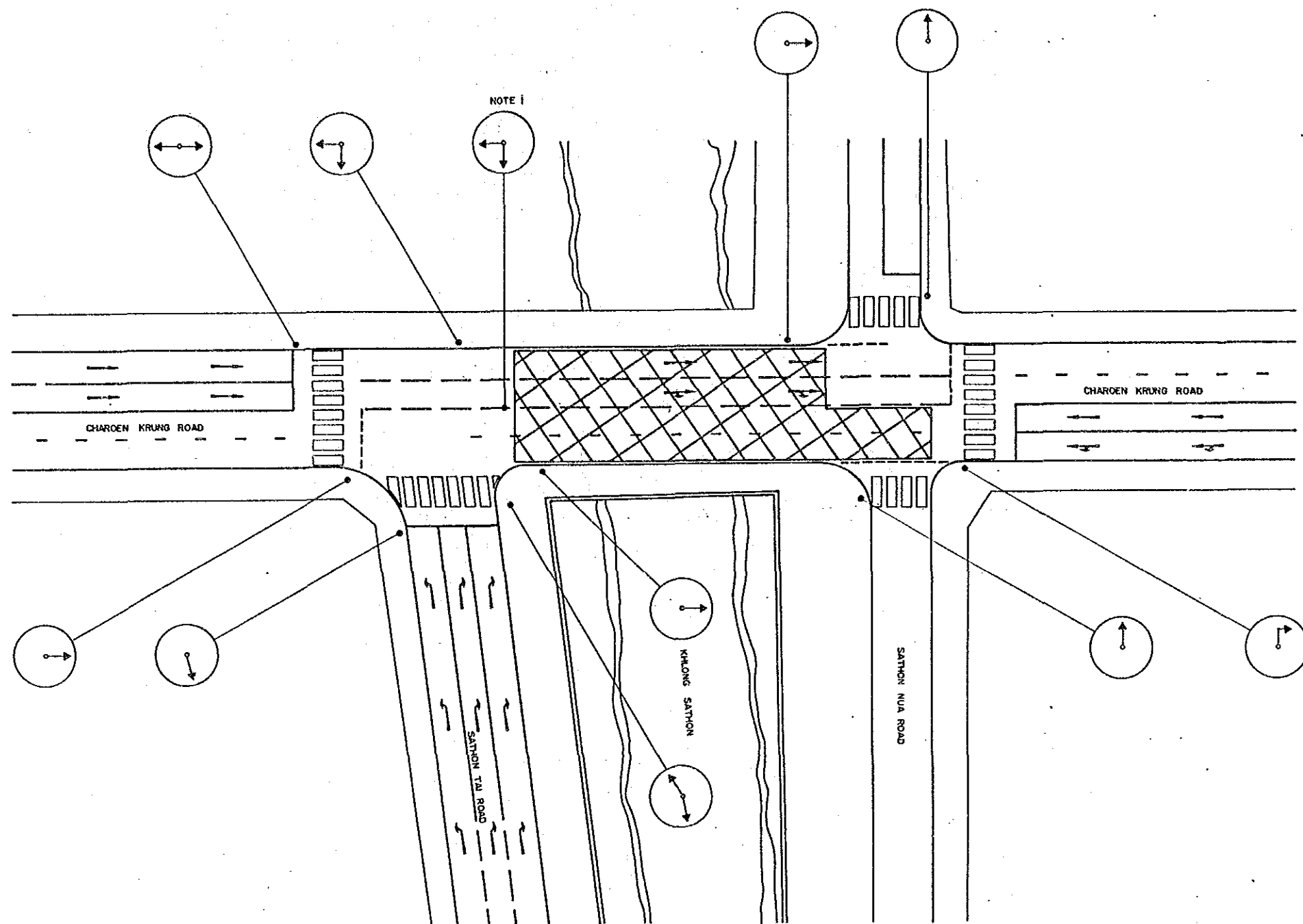

BANGKOK AREA TRAFFIC CONTROL SYSTEM PROJECT : STAGE I			
INTERSECTION EXISTING LAYOUT		Submitted By :	Approved By :
SATHON-CHAROEN KRUNG		Jaro Keeree JICA Study Team Leader	<i>[Signature]</i> Boonyasri Tiptun BMA Study Team Leader
INTERSECTION NO 214			
Code	Rev	Date	Initial
Associated Plan No. :	JICA Japan International Cooperation Agency	BMA Bangkok Metropolitan Administration	Scale 1 / 250 Date SEPTEMBER '90
		Drawing No 5214	Total 115 / 143

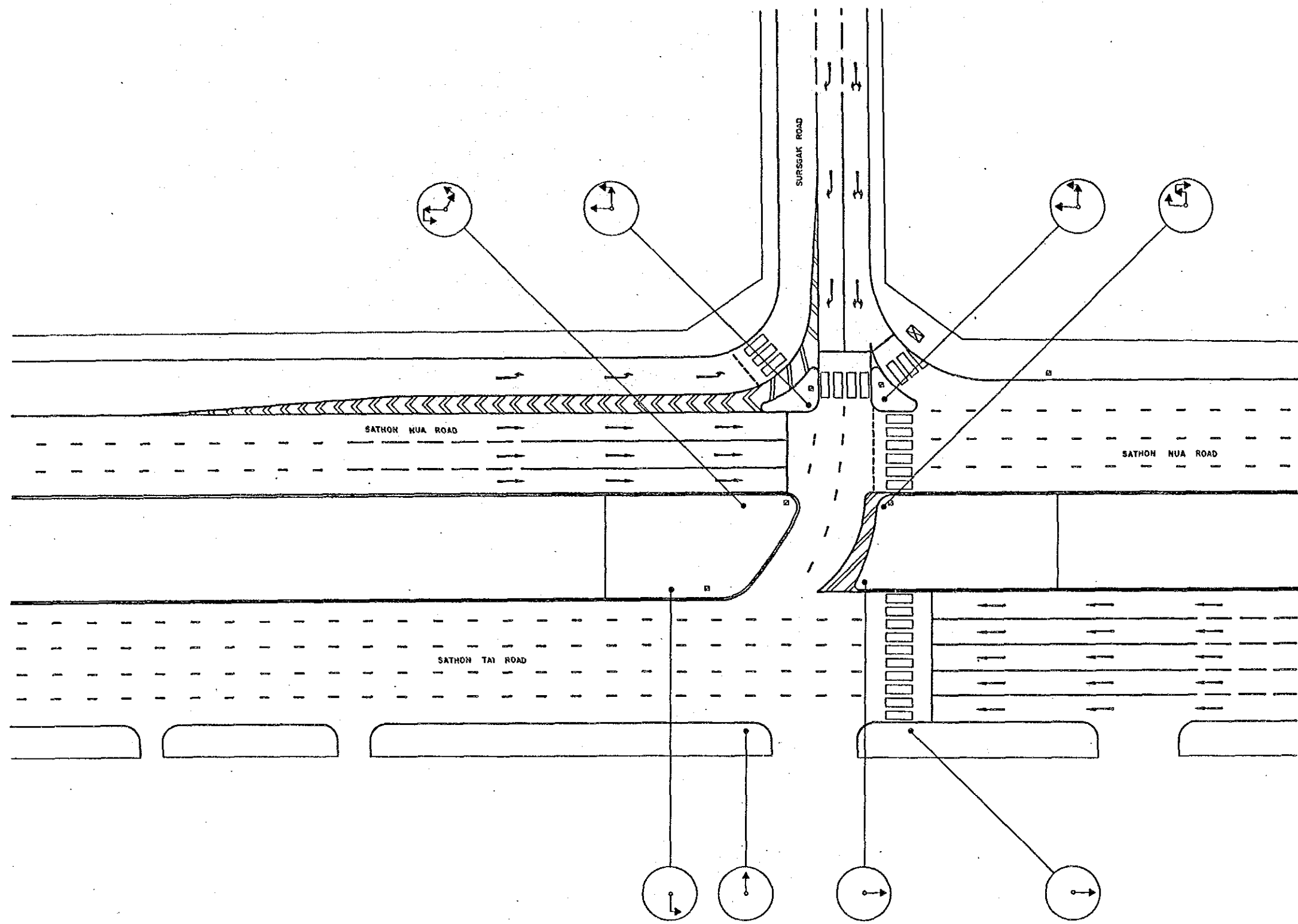

BANGKOK AREA TRAFFIC CONTROL SYSTEM PROJECT : STAGE I			
INTERSECTION EXISTING LAYOUT		Submitted By :	Approved By :
SATHON NUA - SURASAK		Jaro Kadera JICA Study Team Leader	<i>[Signature]</i> Boonyawat Yipius BMA Study Team Leader
INTERSECTION NO 215			
Code	Survey	Date	Initial
Associated Plan No. :	JICA Japan International Cooperation Agency	BMA Bangkok Metropolitan Administration	Scale 1 / 250 Date : SEPTEMBER '90
			Drawing No 5215 Total 116 / 143

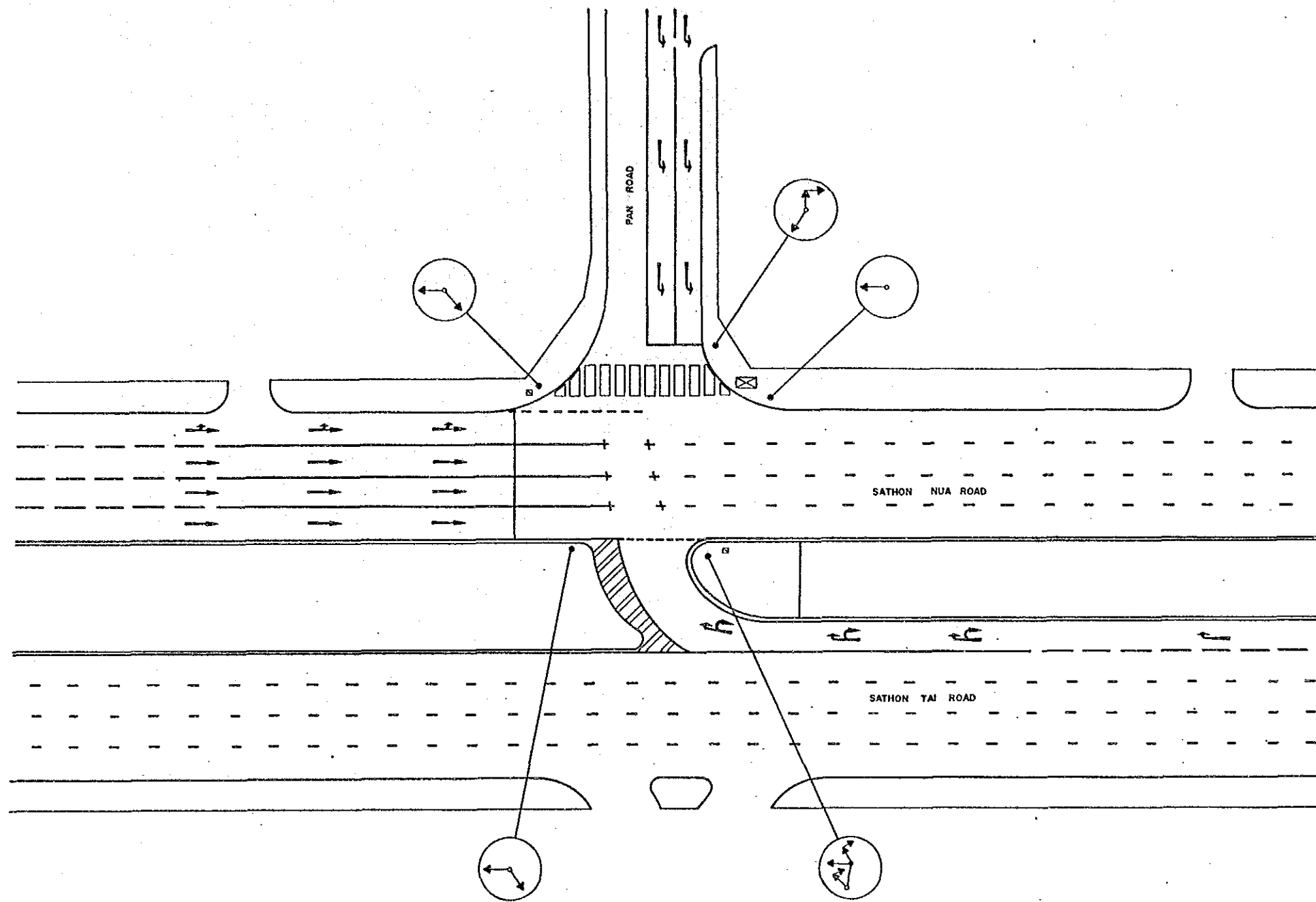

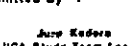
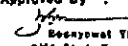
				BANGKOK AREA TRAFFIC CONTROL SYSTEM PROJECT : STAGE I			
				INTERSECTION EXISTING LAYOUT		Submitted By :	
				SATHON NUA - PAN		Approved By :	
				INTERSECTION NO 217		 JICA Study Team Leader	
				JICA Japan International Cooperation Agency		 BMA Study Team Leader	
Code				Date		Scale 1/250	
Associated Plan No. :				Date		Drawing No 5217	
				Date SEPTEMBER '90		Total 117 / 143	

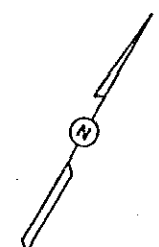
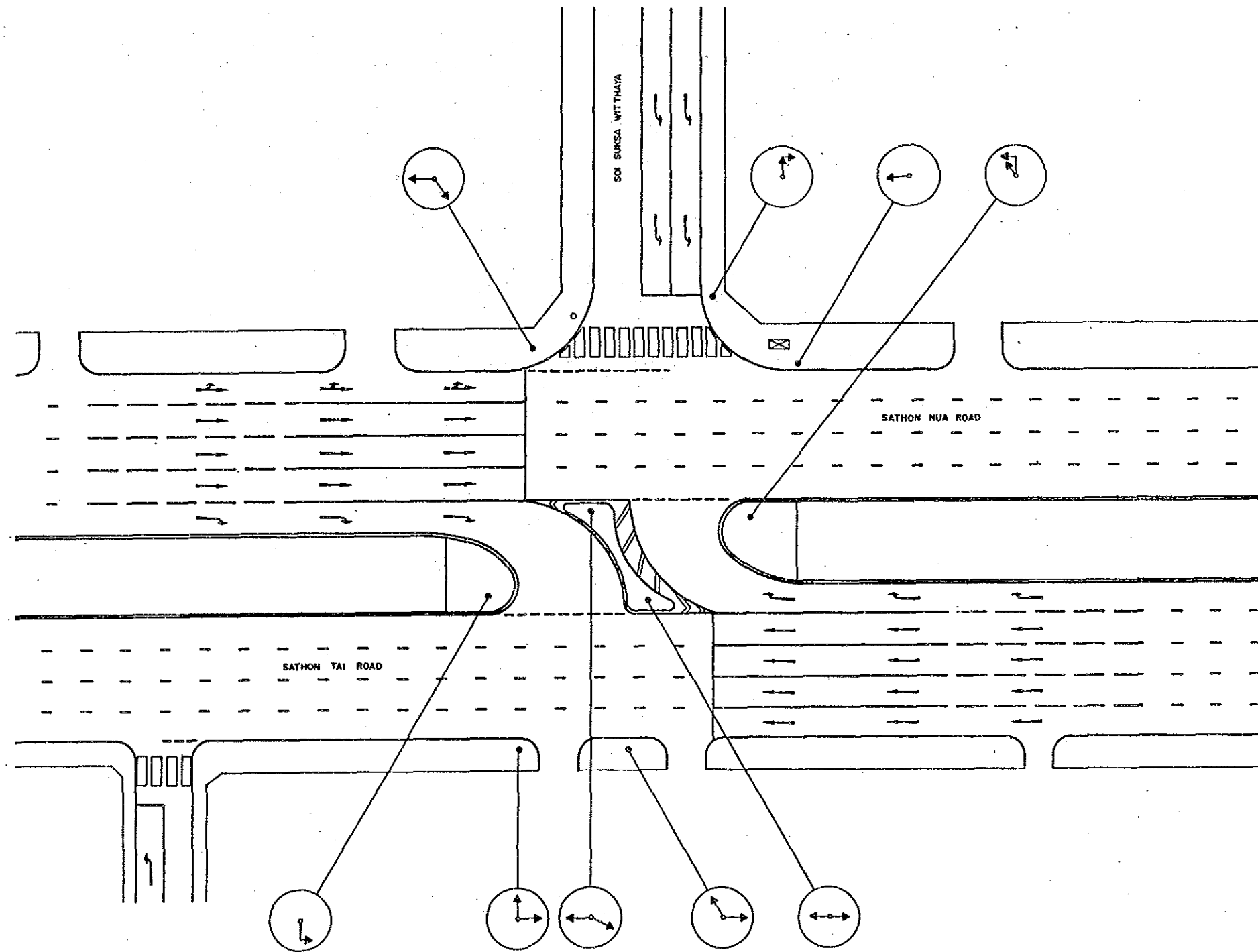

				BANGKOK AREA TRAFFIC CONTROL SYSTEM PROJECT : STAGE I			
				INTERSECTION EXISTING LAYOUT		Submitted By :	
				SATHON - SOI SUKSA WITTHAYA		Jiro Kodera	
				(BANG RAK HOSPITAL)		JICA Study Team Leader	
				INTERSECTION NO 219		Approved By :	
				JICA		Somyoung Tiptoo	
				Japan International		BMA Study Team Leader	
				Cooperation Agency		BMA Administration	
Code				Survey		Scale 1 / 250	
Associated Plan No. :				Date		Drawing No 5219	
				Date SEPTEMBER '90		Total 118 / 143	

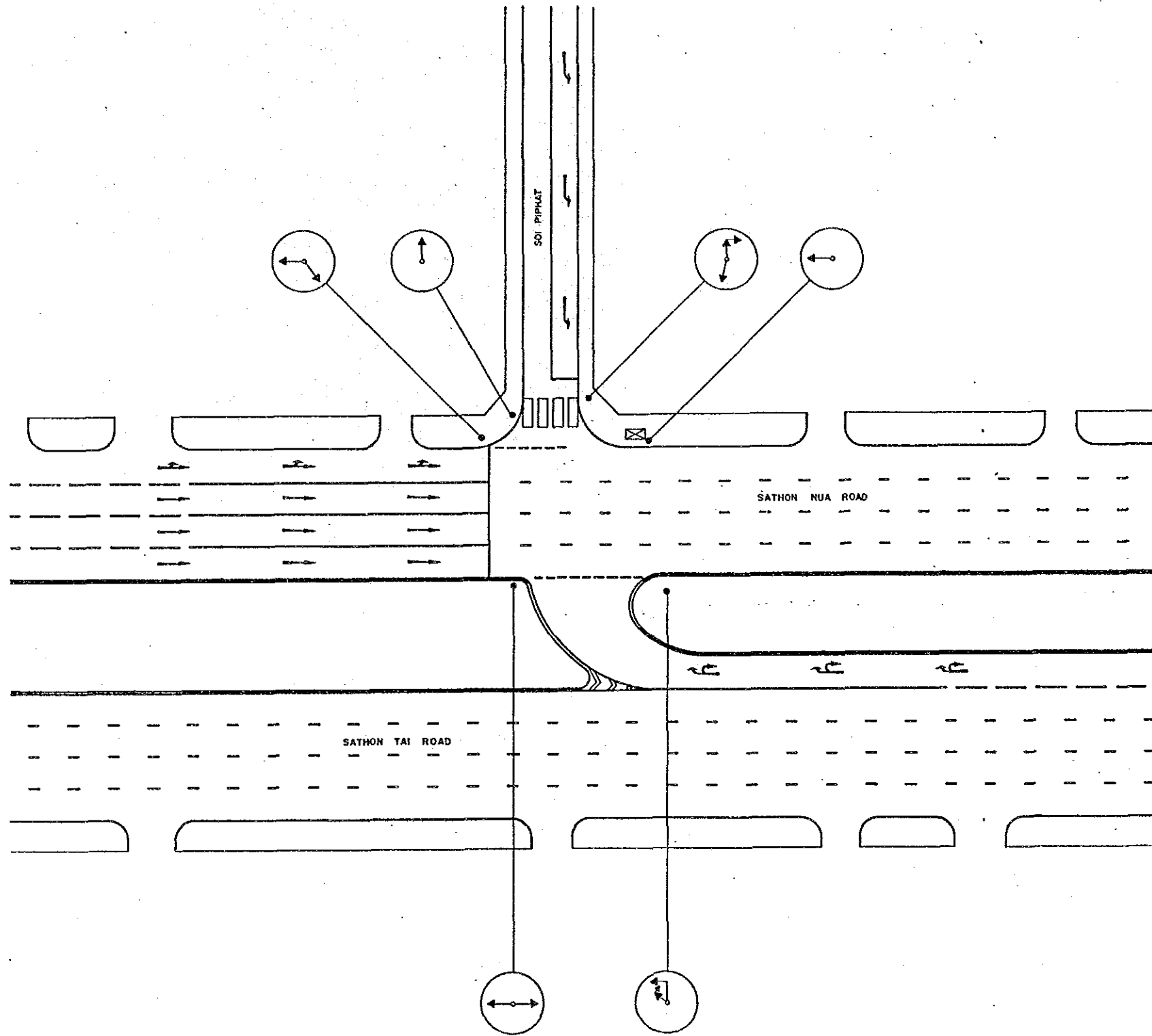

				BANGKOK AREA TRAFFIC CONTROL SYSTEM PROJECT : STAGE I			
				INTERSECTION EXISTING LAYOUT		Submitted By : Jiro Kodera JICA Study Team Leader	
				SATHON NUA - SOI PHIPHAT		Approved By : <i>Jiro Kodera</i> BMA Study Team Leader	
				INTERSECTION NO 221			
Code	Survey	Date	Initial	JICA Japan International Cooperation Agency	BMA Bangkok Metropolitan Administration	Scale 1 / 250	Drawing No 5221
Associated Plan No. :						Date SEPTEMBER '90	Total 119 / 143

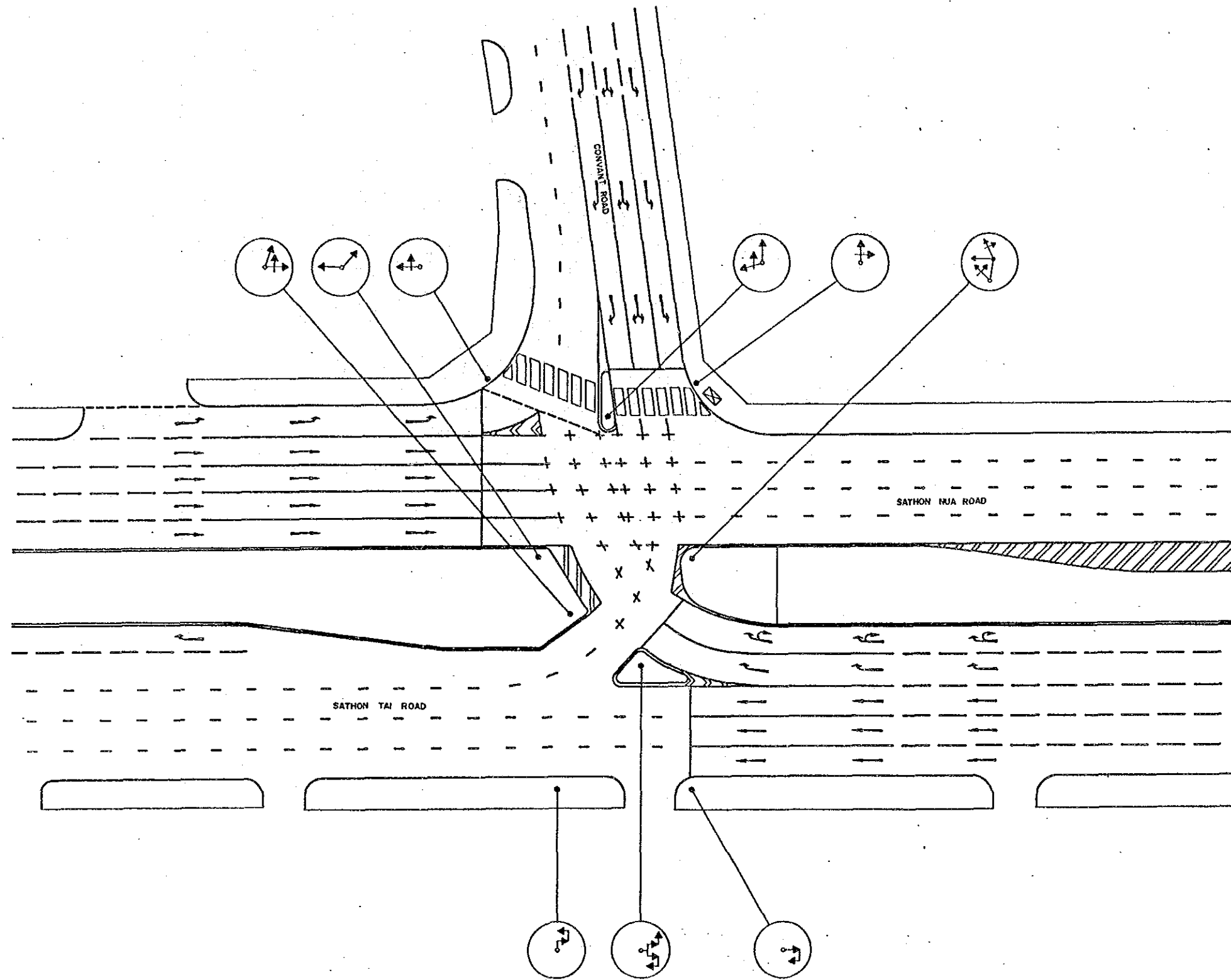

BANGKOK AREA TRAFFIC CONTROL SYSTEM PROJECT : STAGE I			
INTERSECTION EXISTING LAYOUT		Submitted By :	Approved By :
SATHON NUA-CONVENT		Jaro Rodora JICA Study Team Leader	Boonyawat Tiptua BMA Study Team Leader
INTERSECTION NO 222			
Code	Burey	Date	DATE
Associated Plan No. :	JICA Japan International Cooperation Agency	BMA Bangkok Metropolitan Administration	Scale 1 / 250 Date SEPTEMBER '90
			Drawing No 5222 Total 120 / 143

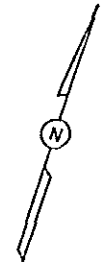
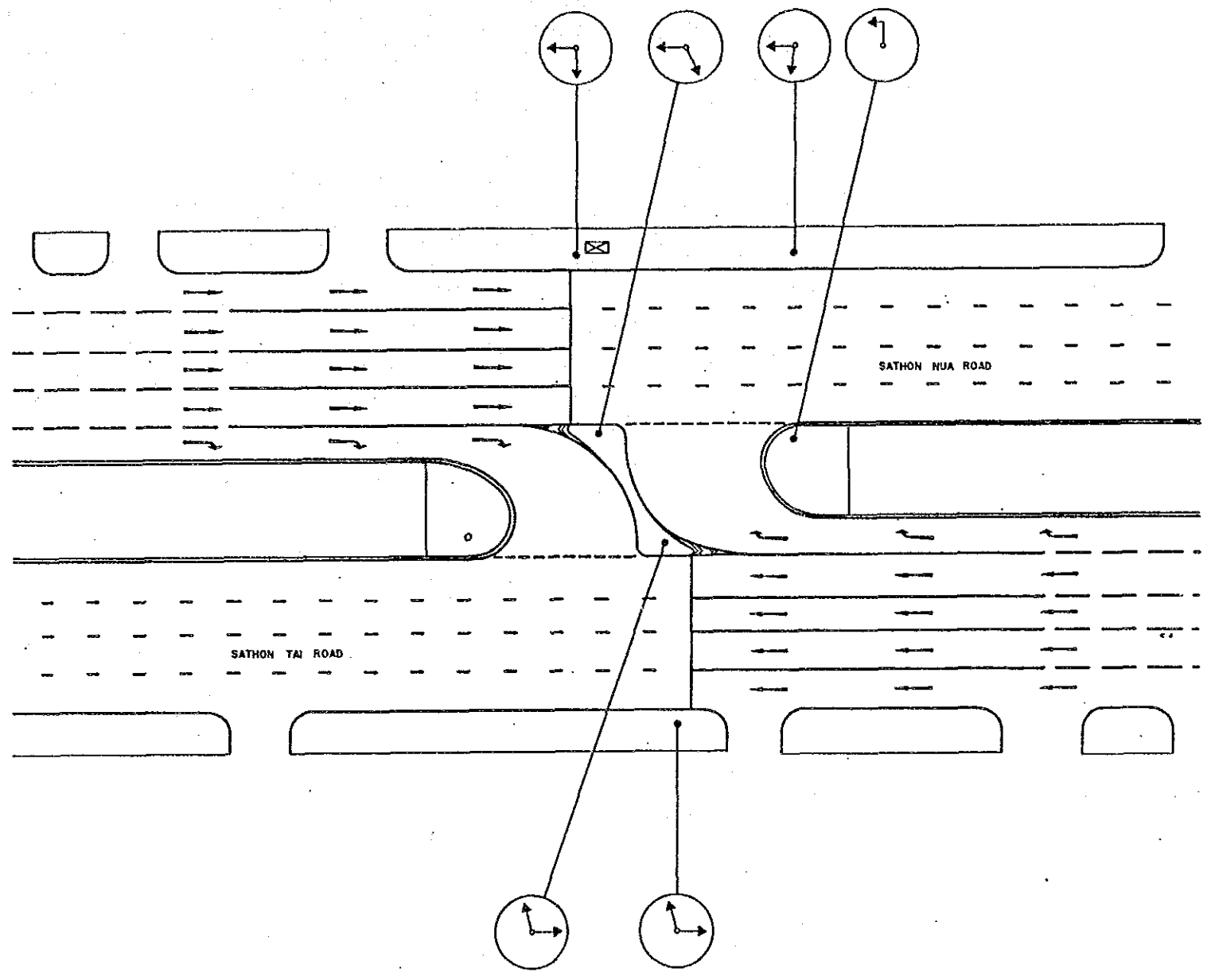

BANGKOK AREA TRAFFIC CONTROL SYSTEM PROJECT : STAGE I			
INTERSECTION EXISTING LAYOUT		Submitted By :	Approved By :
SATHON(U-TURN NEAR SOI ATTHAKAN PRASIT)		Jiro Kodera JICA Study Team Leader	Boonpratek Tipkha BMA Study Team Leader
INTERSECTION NO 224			
Code	Survey	Date	Initial
Associated Plan No. :	JICA Japan International Cooperation Agency	BMA Bangkok Metropolitan Administration	Scale 1 / 250 Date SEPTEMBER '90
		Drawing NR 5224	Total 121 / 143

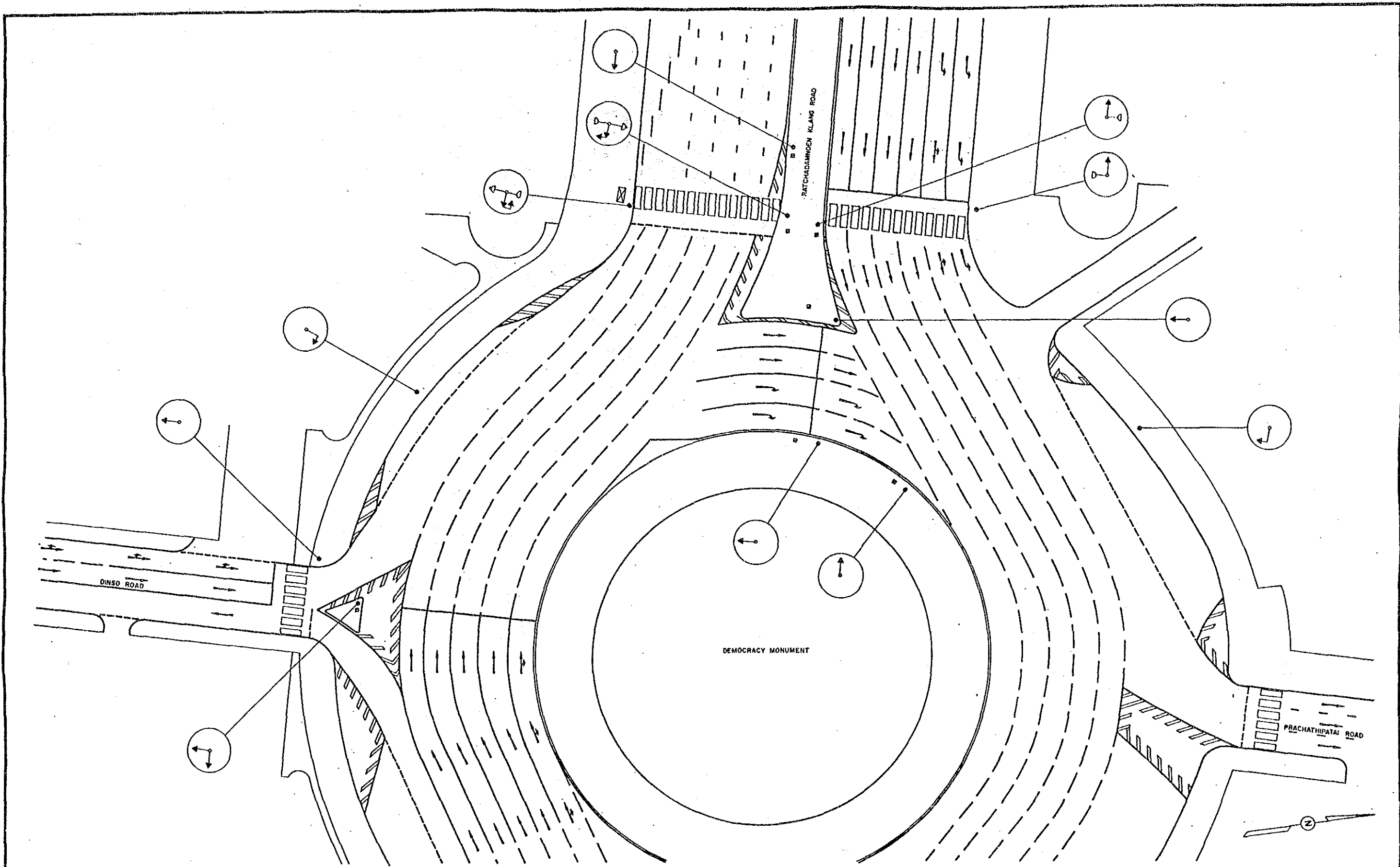

				BANGKOK AREA TRAFFIC CONTROL SYSTEM PROJECT : STAGE I			
				INTERSECTION EXISTING LAYOUT		Submitted By :	Approved By :
				DEMOCRACY MONUMENT I		Jiro Kodera JICA Study Team Leader	Boonyawat Tipton BMA Study Team Leader
				INTERSECTION NO 227			
Code	Survey	Date	Initial	JICA	BMA	Scale	Drawing No
				Japan International Cooperation Agency	Bangkok Metropolitan Administration	1 / 250	5227
Associated Plan No. :						Date	Total
						SEPTEMBER '90	122 / 143

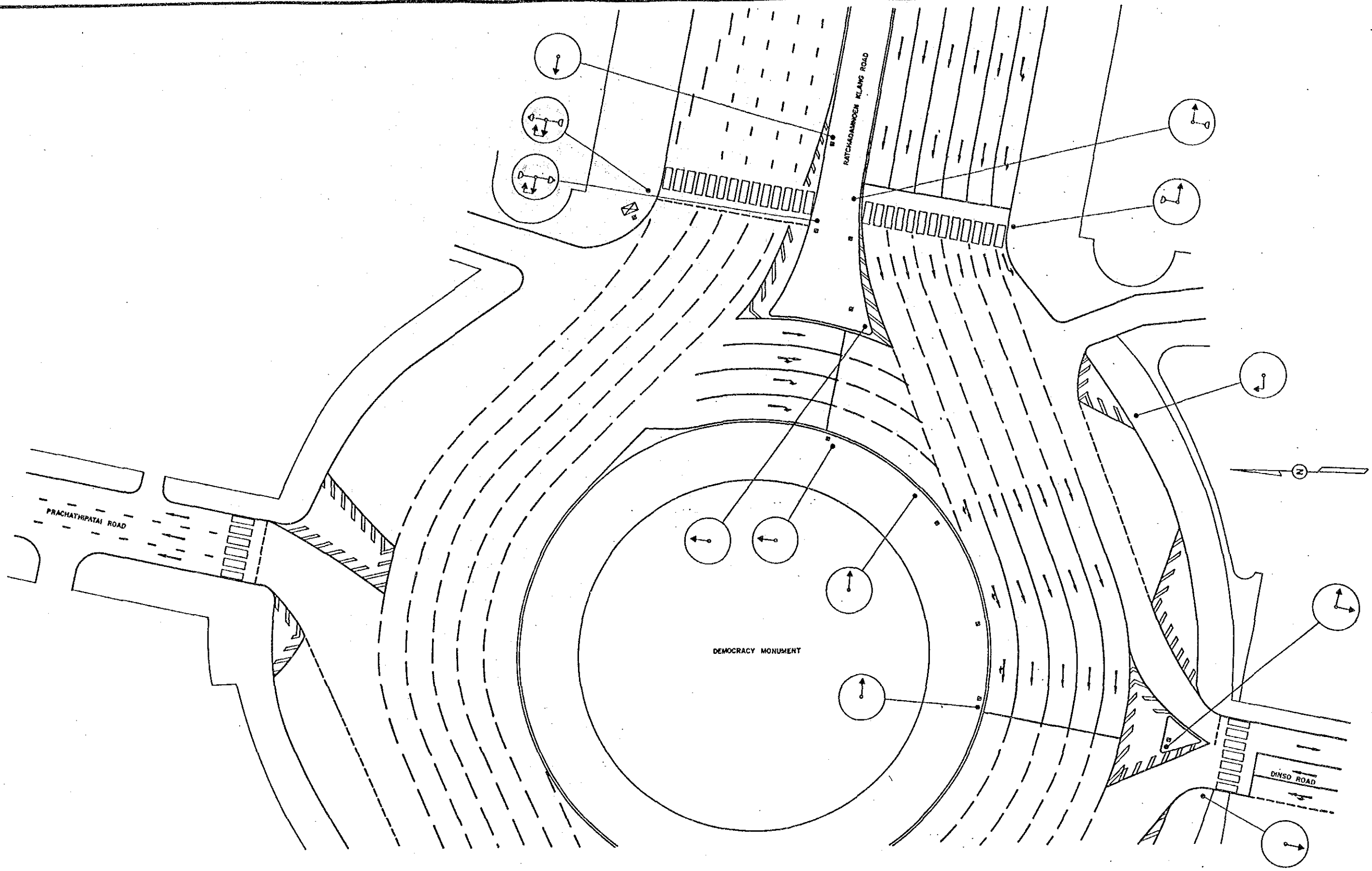

BANGKOK AREA TRAFFIC CONTROL SYSTEM PROJECT : STAGE I			
INTERSECTION EXISTING LAYOUT		Submitted By :	Approved By :
DEMOCRACY MONUMENT 2		Juro Kodera JICA Study Team Leader	Boonyarat Tiptas BMA Study Team Leader
INTERSECTION NO 228			
Code	Survey	Date	Initial
Associated Plan No. :	JICA Japan International Cooperation Agency	BMA Bangkok Metropolitan Administration	Scale 1 / 250 Date SEPTEMBER '90
			Drawing NR . 5228 Total 123 / 143

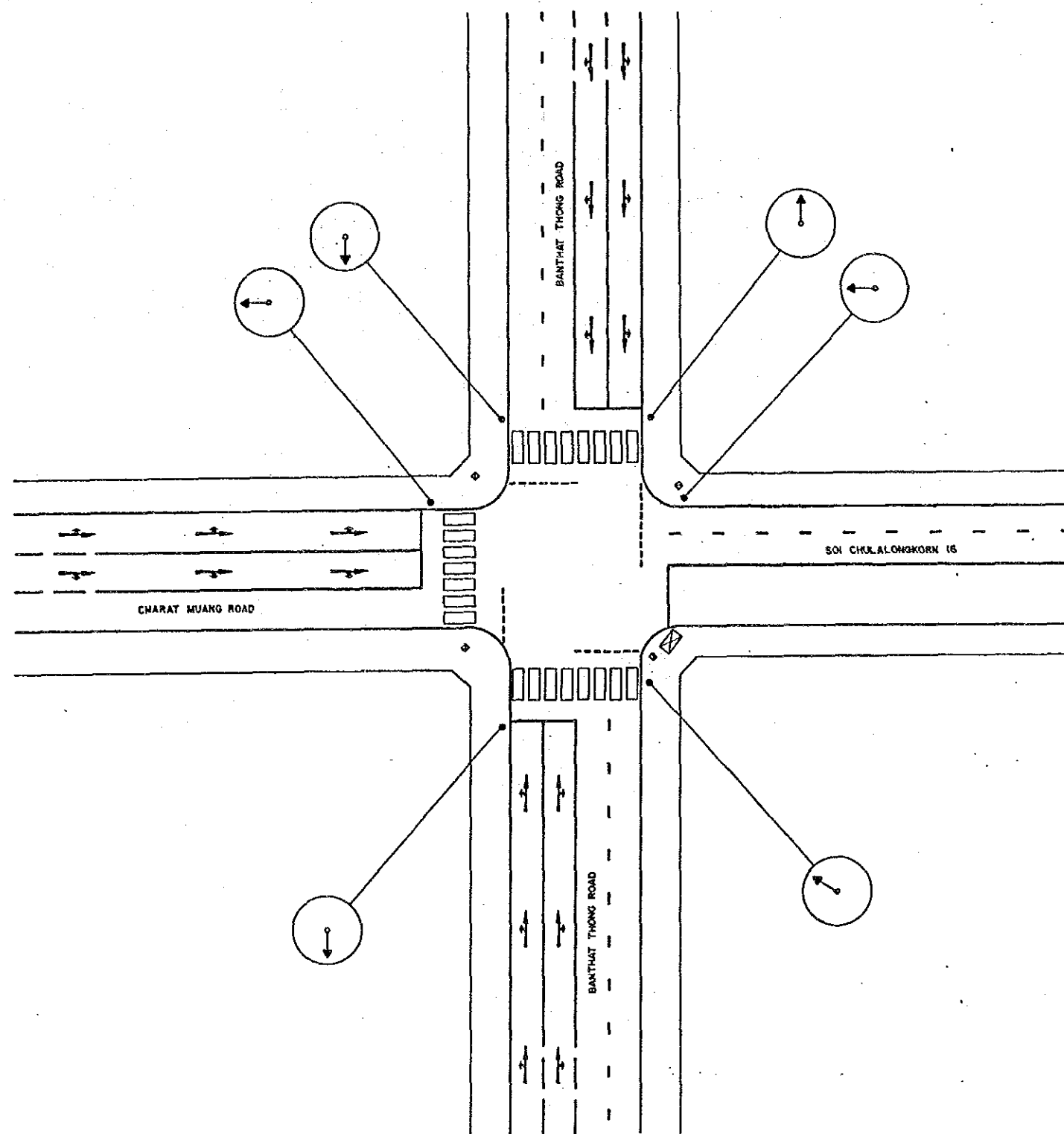

BANGKOK AREA TRAFFIC CONTROL SYSTEM PROJECT : STAGE I			
INTERSECTION EXISTING LAYOUT		Submitted By :	Approved By :
BANTHAT THONG - SOI CHULALONGKORN 16		Juro Kudara JICA Study Team Leader	Boonyawat Tiplar BMA Study Team Leader
INTERSECTION NO 232			
Code	Survey	Date	Initial
Associated Plan No. 1	JICA Japan International Cooperation Agency	BMA Bangkok Metropolitan Administration	Scale 1/250 Date SEPTEMBER '90
		Drawing NR 5232	Total 124 / 143

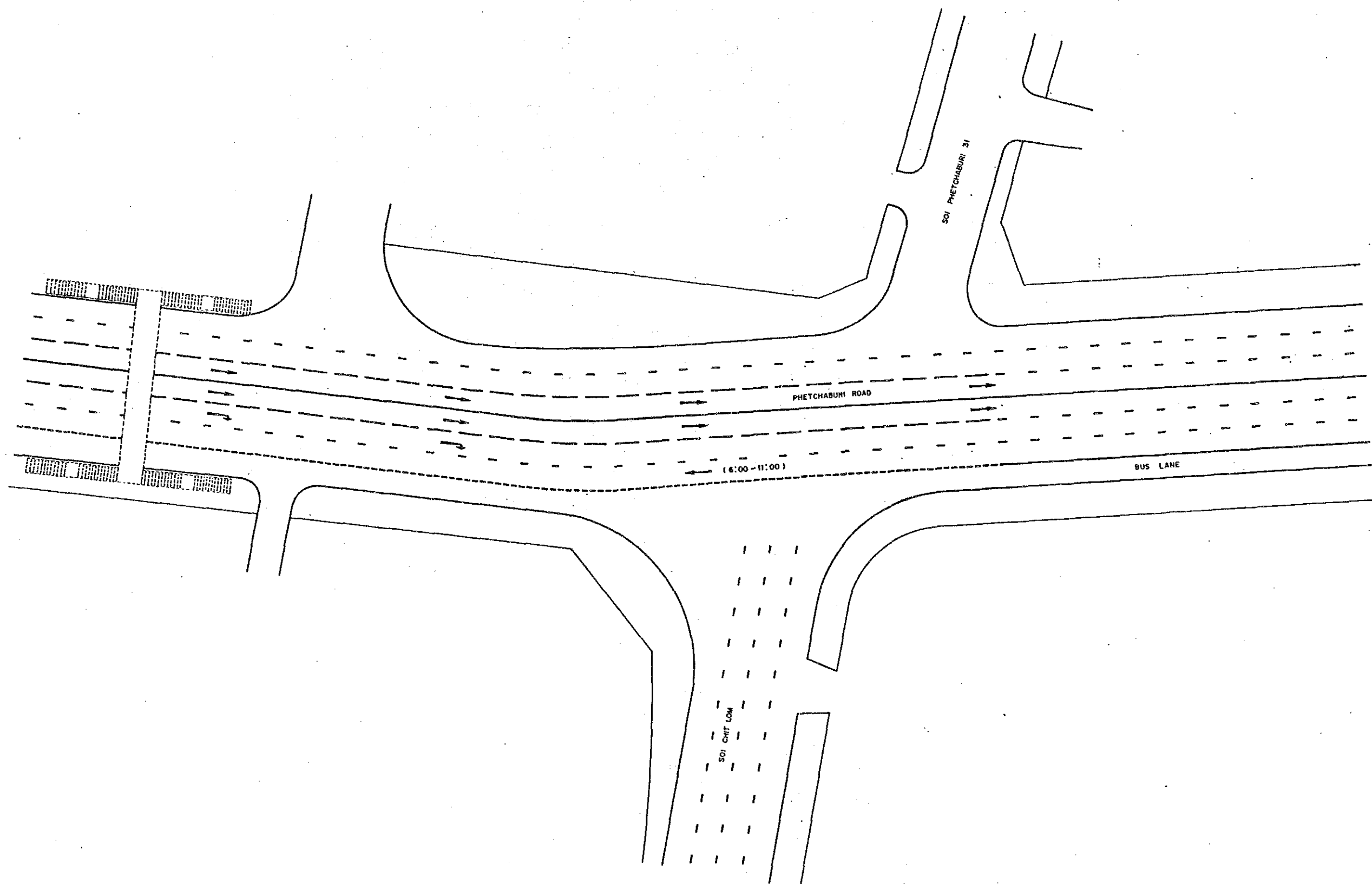

BANGKOK AREA TRAFFIC CONTROL SYSTEM PROJECT : STAGE I			
INTERSECTION EXISTING LAYOUT		Submitted By :	Approved By :
PHETCHABURI - SOI CHIT LOM		Jira Keerak JICA Study Team Leader	Boonyarat Tiptan BMA Study Team Leader
INTERSECTION NO 236			
Code	Survey	Date	Initial
Associated Plan No. :	JICA Japan International Cooperation Agency	BMA Bangkok Metropolitan Administration	Scale 1 / 250 Date SEPTEMBER '99 Drawing NR 5236 Total 125 / 143

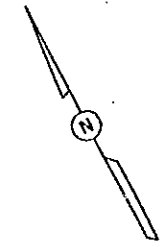
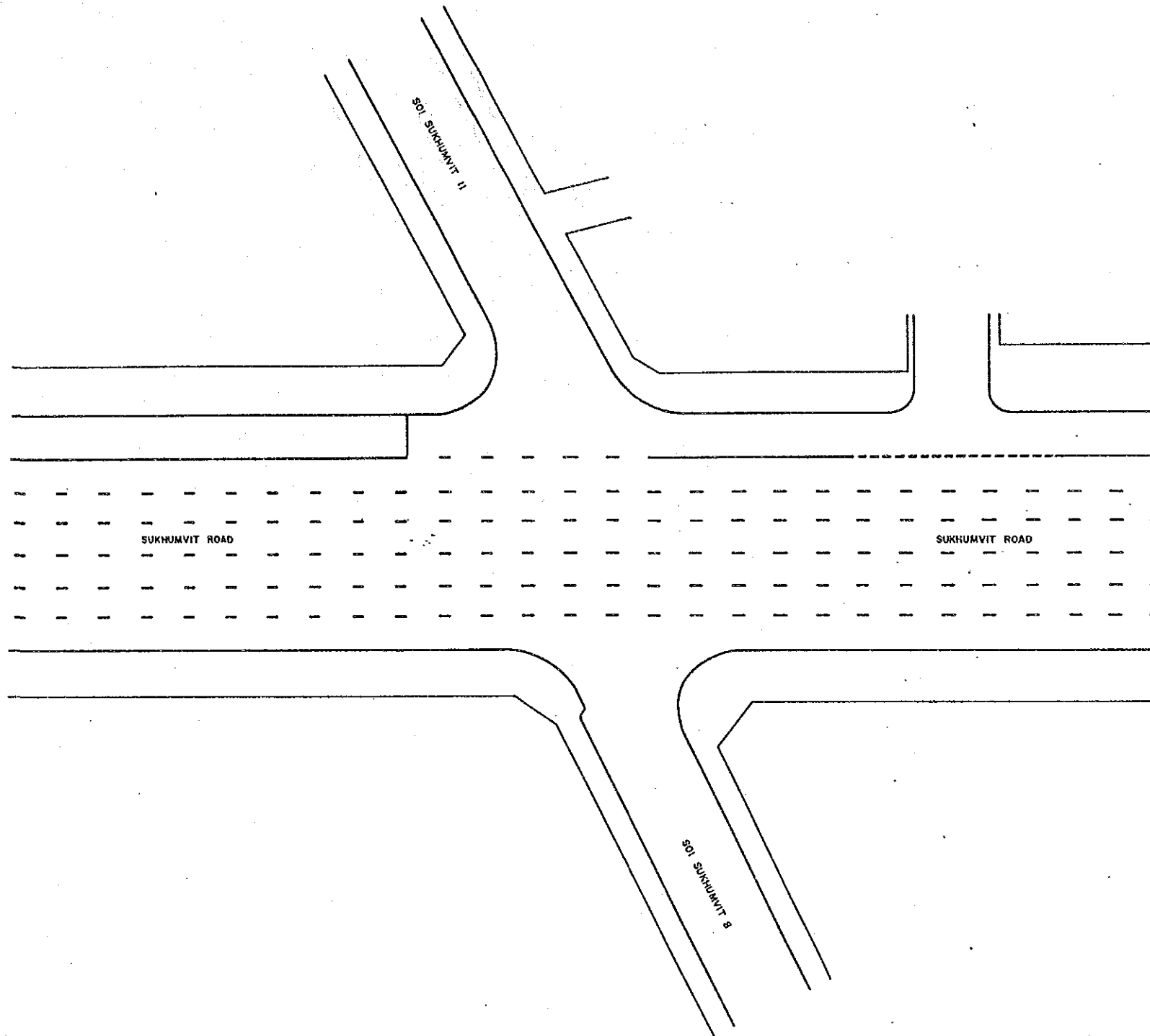

				BANGKOK AREA TRAFFIC CONTROL SYSTEM PROJECT : STAGE I			
				INTERSECTION EXISTING LAYOUT		Submitted By :	Approved By :
				SUKHUMVIT - SOI SUKHUMVIT II		Jiro Nakara JICA Study Team Leader	 Boonanal Titus BMA Study Team Leader
				INTERSECTION NO 237			
Code	Survey	Date	Initial	JICA	BMA	Scale 1 / 250	Drawing No 5237
Associated Plan No. :				Japan International Cooperation Agency	Bangkok Metropolitan Administration	Date SEPTEMBER '00	Total 126 / 143

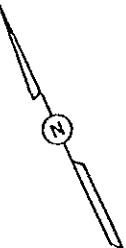
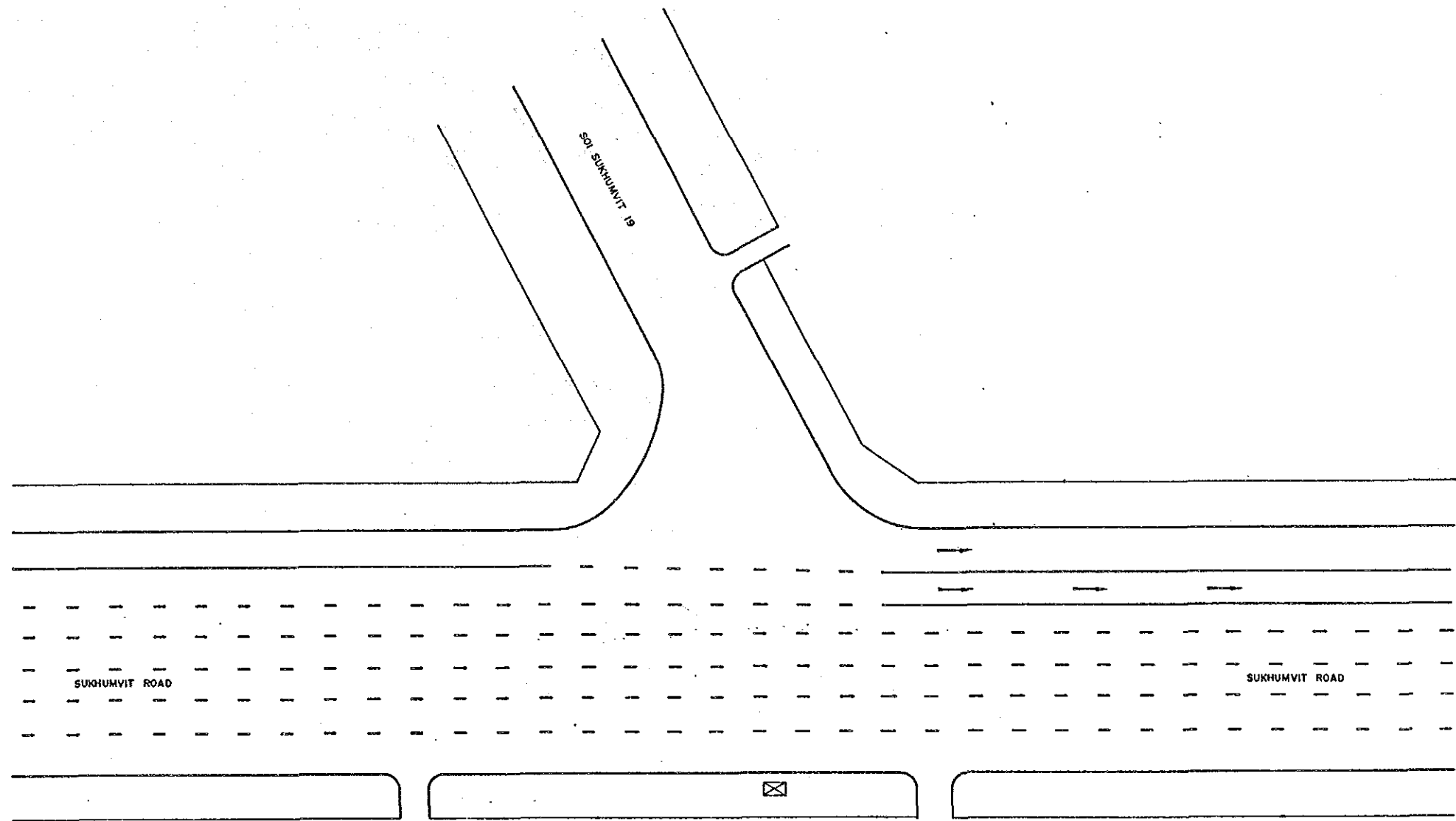

				BANGKOK AREA TRAFFIC CONTROL SYSTEM PROJECT : STAGE I			
				INTERSECTION EXISTING LAYOUT	Submitted By :	Approved By :	
				SUKHUMVIT-SOI SUKHUMVIT 19	Jira Kudara JICA Study Team Leader	Boonyawat Titluw BMA Study Team Leader	
				INTERSECTION NO	238		
Code	Survey	Date	Initial	JICA	BMA	Scale	Drawing No
Associated Plan No. :				Japan International Cooperation Agency	Bangkok Metropolitan Administration	1 / 250	5238
						Date	Total
						SEPTEMBER '90	127 / 143

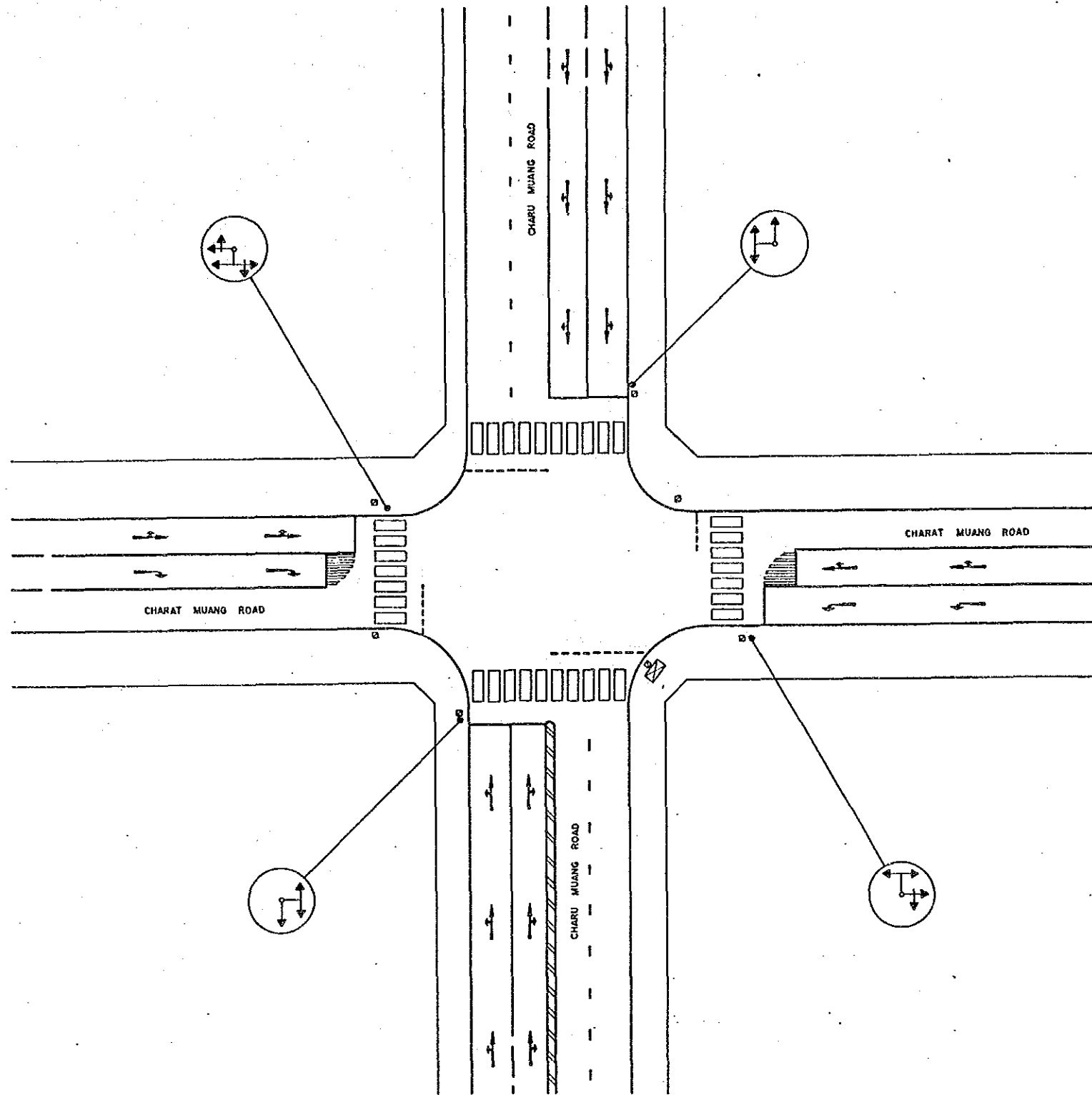

BANGKOK AREA TRAFFIC CONTROL SYSTEM PROJECT: STAGE I									
				INTERSECTION EXISTING LAYOUT		Submitted By :		Approved By :	
				CHARU MUANG - CHARAT MUANG		Jwe Kodara JICA Study Team Leader		<i>Boonyarat Tiplas</i> BMA Study Team Leader	
				INTERSECTION NO		245			
Code	Drawn	Date	Initial	JICA	BMA	Scale	1/250	Drawing No	5245
Associated Plan No. 1				Japan International Cooperation Agency	Bangkok Metropolitan Administration	Date	SEPTEMBER '80	Total	128 / 143

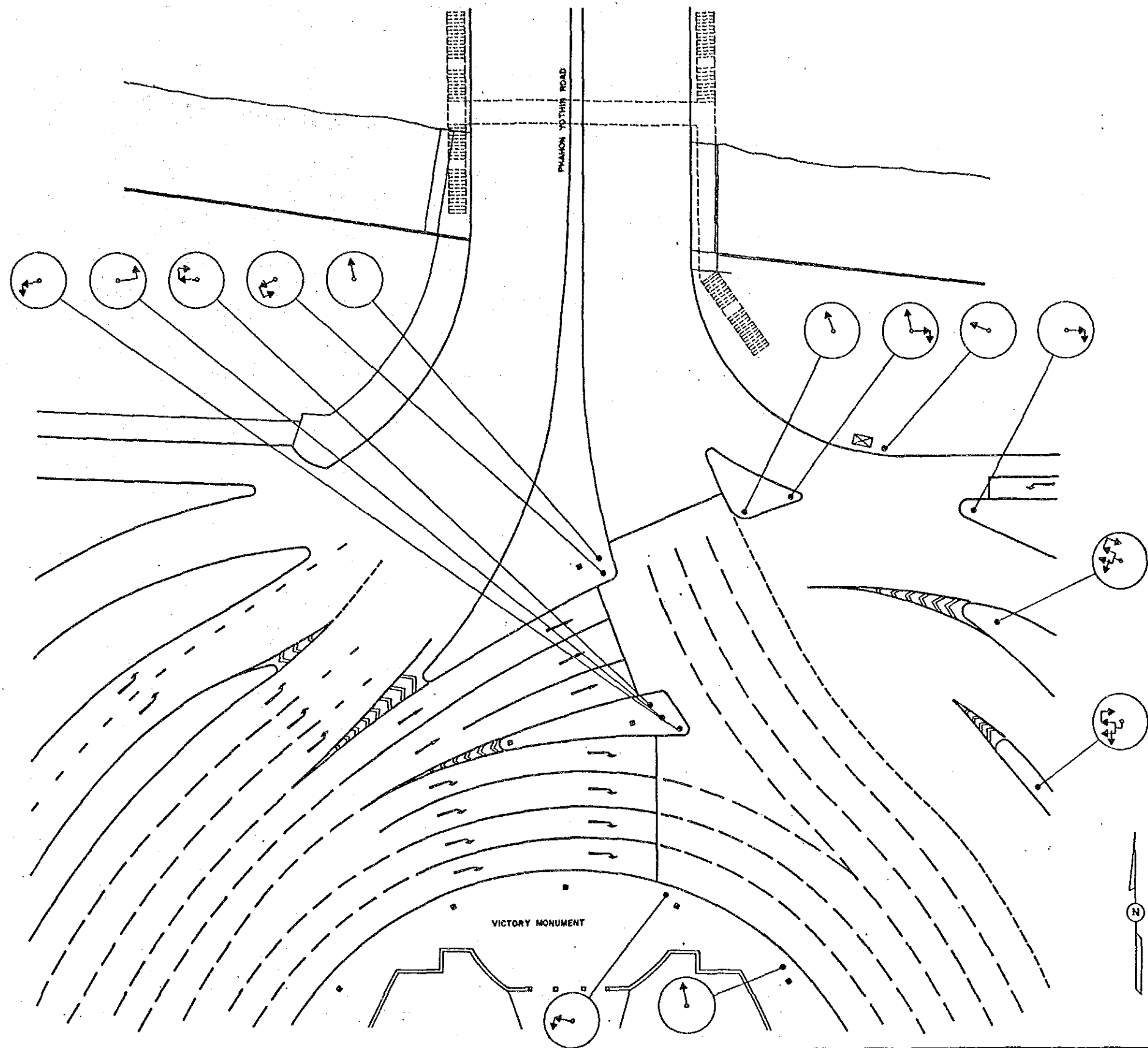

				BANGKOK AREA TRAFFIC CONTROL SYSTEM PROJECT : STAGE I			
				INTERSECTION EXISTING LAYOUT		Submitted By : <i>Jiro Kodera</i> JICA Study Team Leader	
				VICTORY MONUMENT-PHAHON YOTHIN		Approved By : <i>Boonyarat Tiplus</i> BMA Study Team Leader	
				INTERSECTION NO 254			
Code	Survey	Date	Initial	JICA	BMA	Scale	1 / 250
Associated Plan No. :				Japan International Cooperation Agency	Bangkok Metropolitan Administration	Drawing No.	5254
						Date	SEPTEMBER '90
						Total	129 / 143

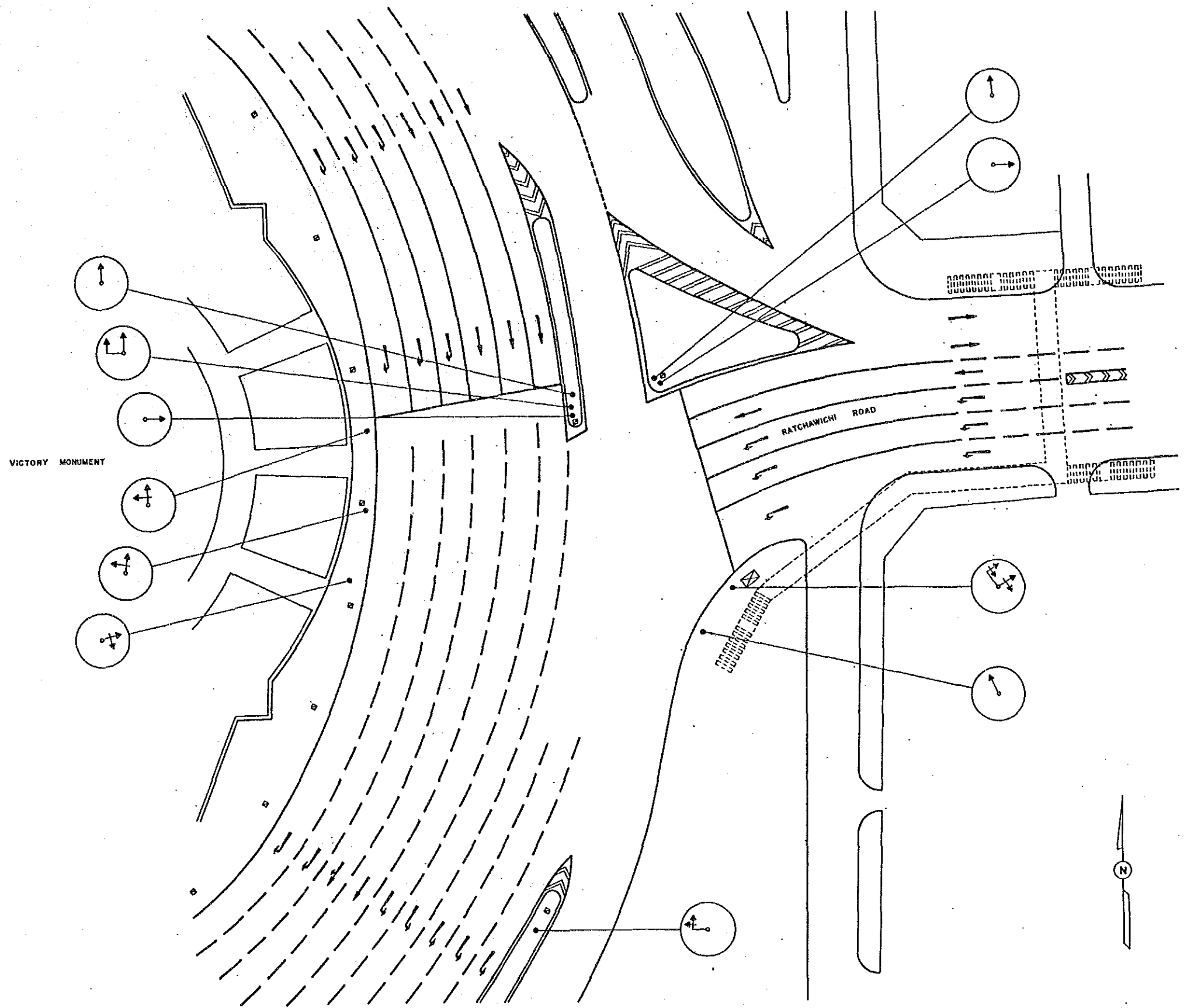

				BANGKOK AREA TRAFFIC CONTROL SYSTEM PROJECT ; STAGE I			
				INTERSECTION EXISTING LAYOUT		Submitted By :	Approved By :
				VICTORY MONUMENT - RATCHAWITHI (EAST)		Jiro Kodera JICA Study Team Leader	Boonyawat Tiptua BMA Study Team Leader
				INTERSECTION NO 255			
Code	Survey	Date	Initial	JICA	BMA	Scale	Drawing No
Associated Plan No. :				Japan International Cooperation Agency	Bangkok Metropolitan Administration	1 / 250	5255
						Date	Total
						SEPTEMBER '90	130 / 143

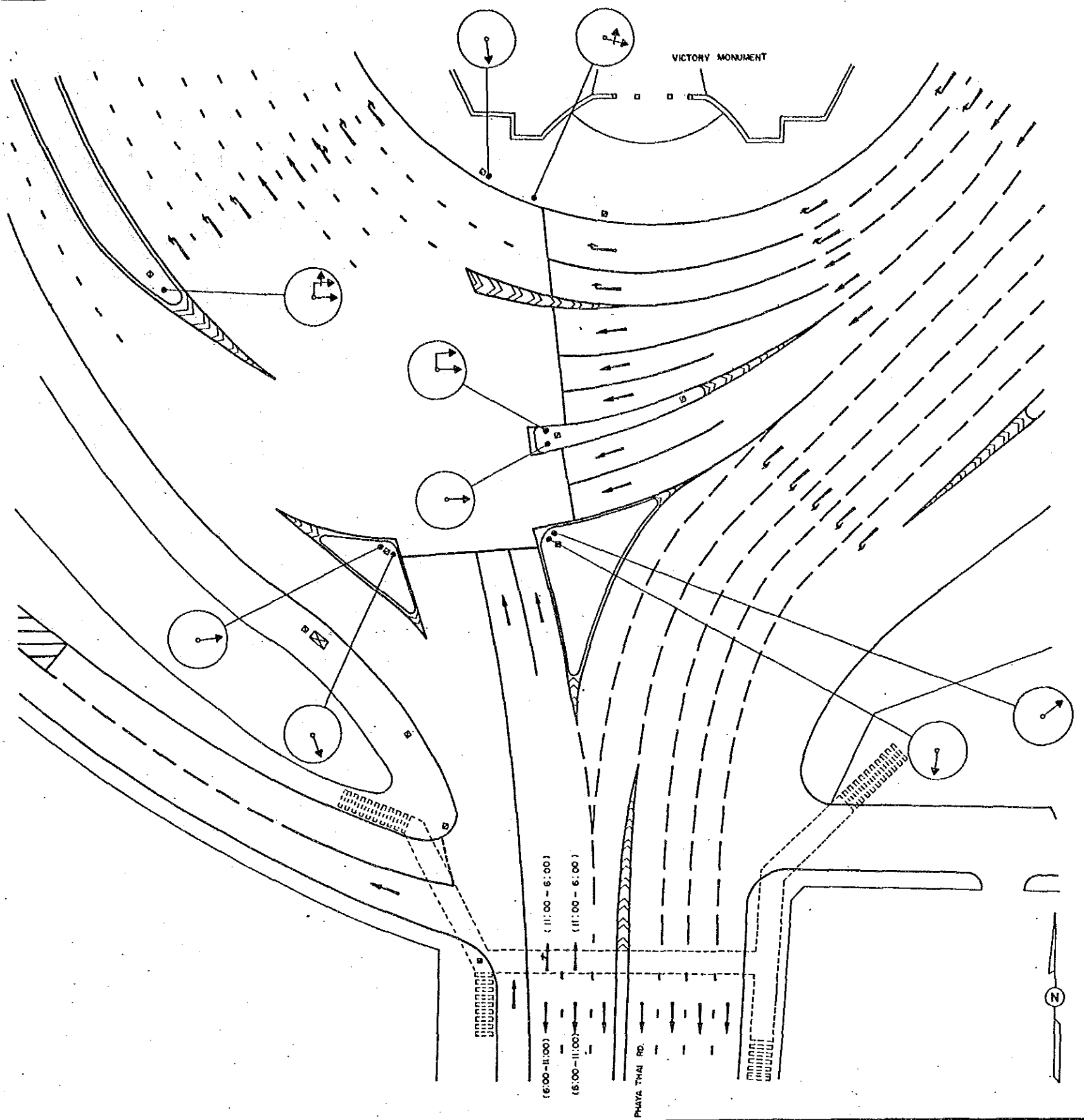

				BANGKOK AREA TRAFFIC CONTROL SYSTEM PROJECT : STAGE I			
				INTERSECTION EXISTING LAYOUT		Submitted By : Jun Kodera JICA Study Team Leader	
				VICTORY MONUMENT - PHAYA THAI		Approved By : Boonyawat Tiptee BMA Study Team Leader	
				INTERSECTION NO 256			
Code	Drawn	Date	Initial	JICA	BMA	Scale	Drawing No.
Associated Plan No. 1				Japan International Cooperation Agency	Bangkok Metropolitan Administration	1 / 250	5256
						Date	Total
						SEPTEMBER '90	131 / 143

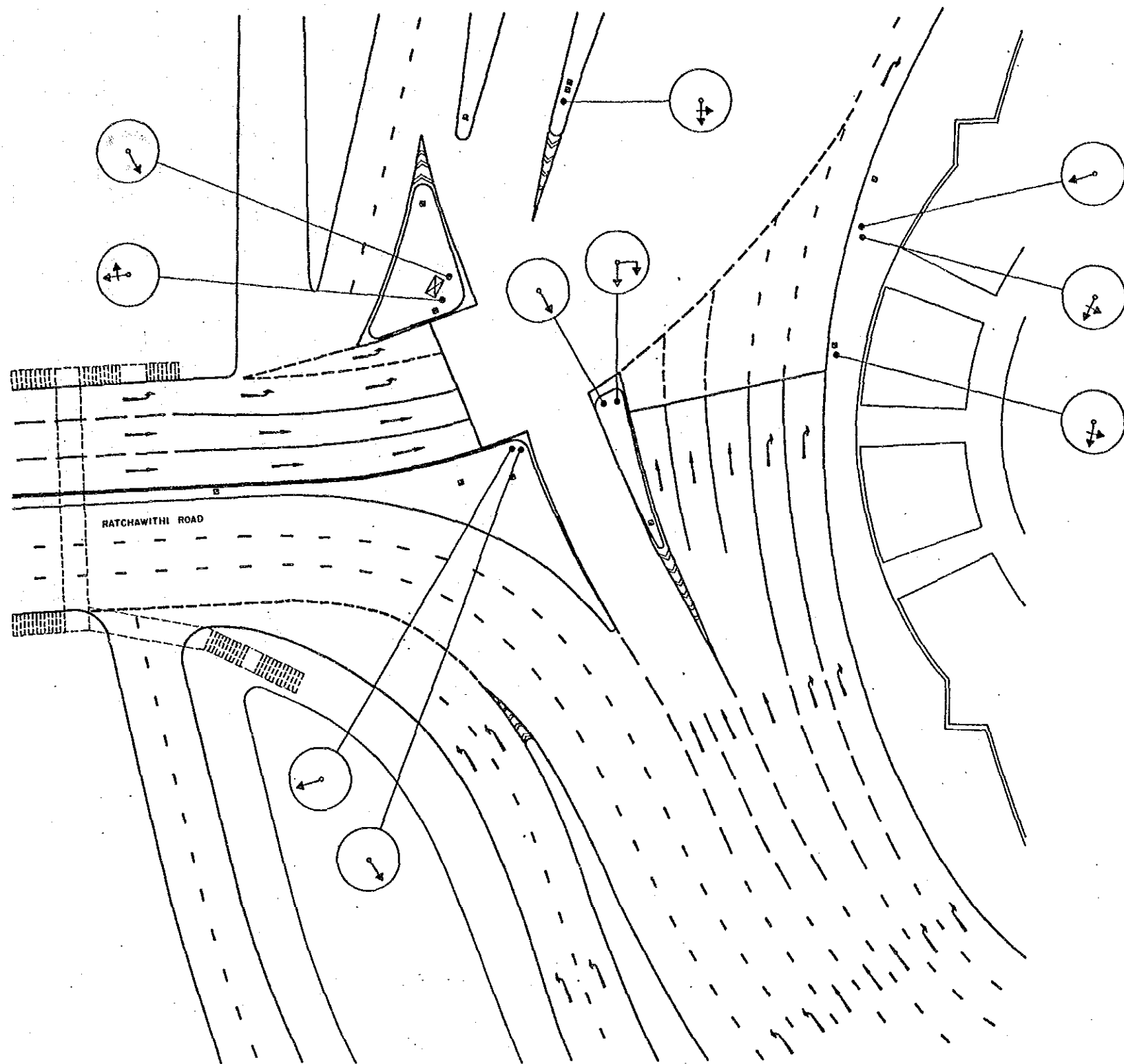

				BANGKOK AREA TRAFFIC CONTROL SYSTEM PROJECT : STAGE I			
				INTERSECTION EXISTING LAYOUT		Submitted By :	Approved By :
				RATCHAWITHI (WEST-VICTORY MONUMENT)		Jiro Kodera JICA Study Team Leader	Wanawat Titluw BMA Study Team Leader
				INTERSECTION NO 257			
Assocated Plan No. :	Scale	Date	Initial	JICA Japan International Cooperation Agency	BMA Bangkok Metropolitan Administration	Scale 1/250	Drawing NO 5257
		SEPTEMBER '90				Date	Total 132 / 143

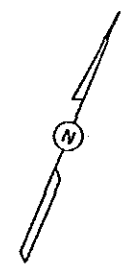
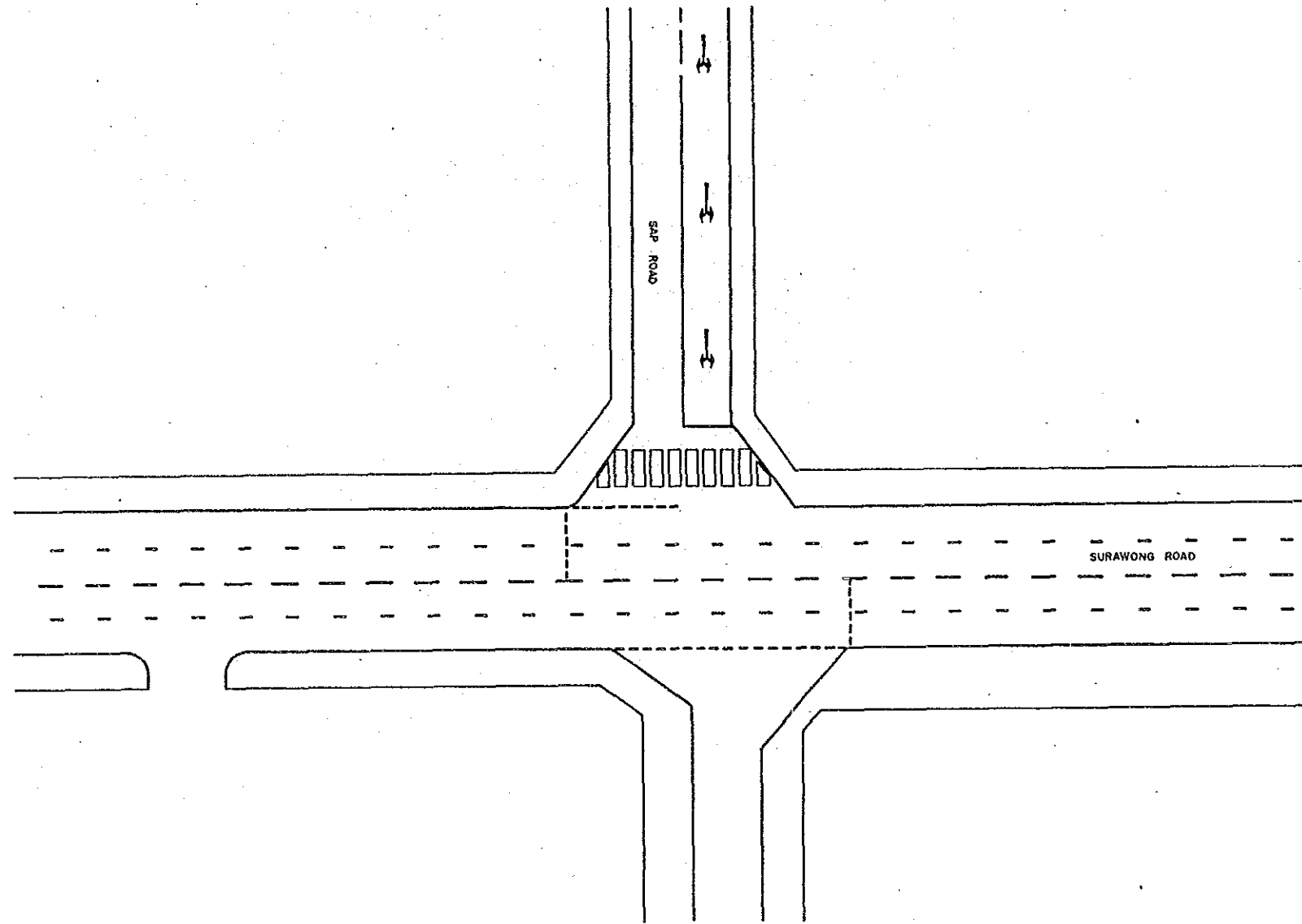

				BANGKOK AREA TRAFFIC CONTROL SYSTEM PROJECT: STAGE I			
				INTERSECTION EXISTING LAYOUT		Submitted By :	
				SURAWONG - SAP		Juno Tanaka JICA Study Team Leader	
				INTERSECTION NO 266		Approved By : Junyongki Tiptus BMA Study Team Leader	
Code	Survey	Date	Initial	JICA	BMA	Scale	1 / 250
Associated Plan No. :				Japan International Cooperation Agency	Bangkok Metropolitan Administration	Date	SEPTEMBER '60
						Drawing No	5266
						Total	133 / 143

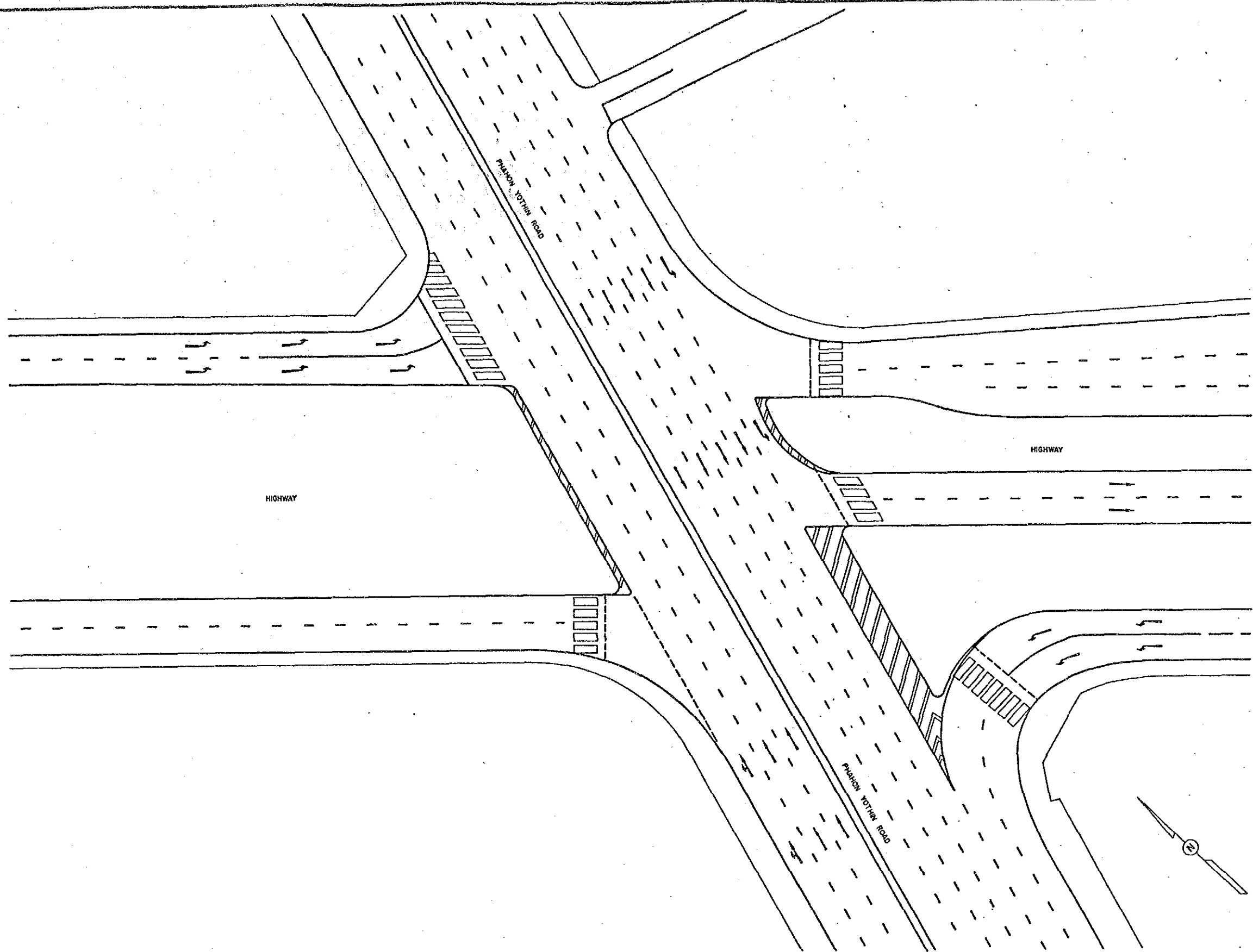

BANGKOK AREA TRAFFIC CONTROL SYSTEM PROJECT : STAGE I			
INTERSECTION EXISTING LAYOUT		Submitted By :	Approved By :
HIGHWAY - PHAHON YOTHIN		Jure Kodera JICA Study Team Leader	<i>[Signature]</i> Boonyasai Titus BMA Study Team Leader
INTERSECTION NO 706			
Code	Survey	Date	Initial
Associated Plan No. :	JICA Japan International Cooperation Agency	BMA Bangkok Metropolitan Administration	Scale : 1 / 250 Date : SEPTEMBER '90.
		Drawing No	5706
		Total	134 / 143

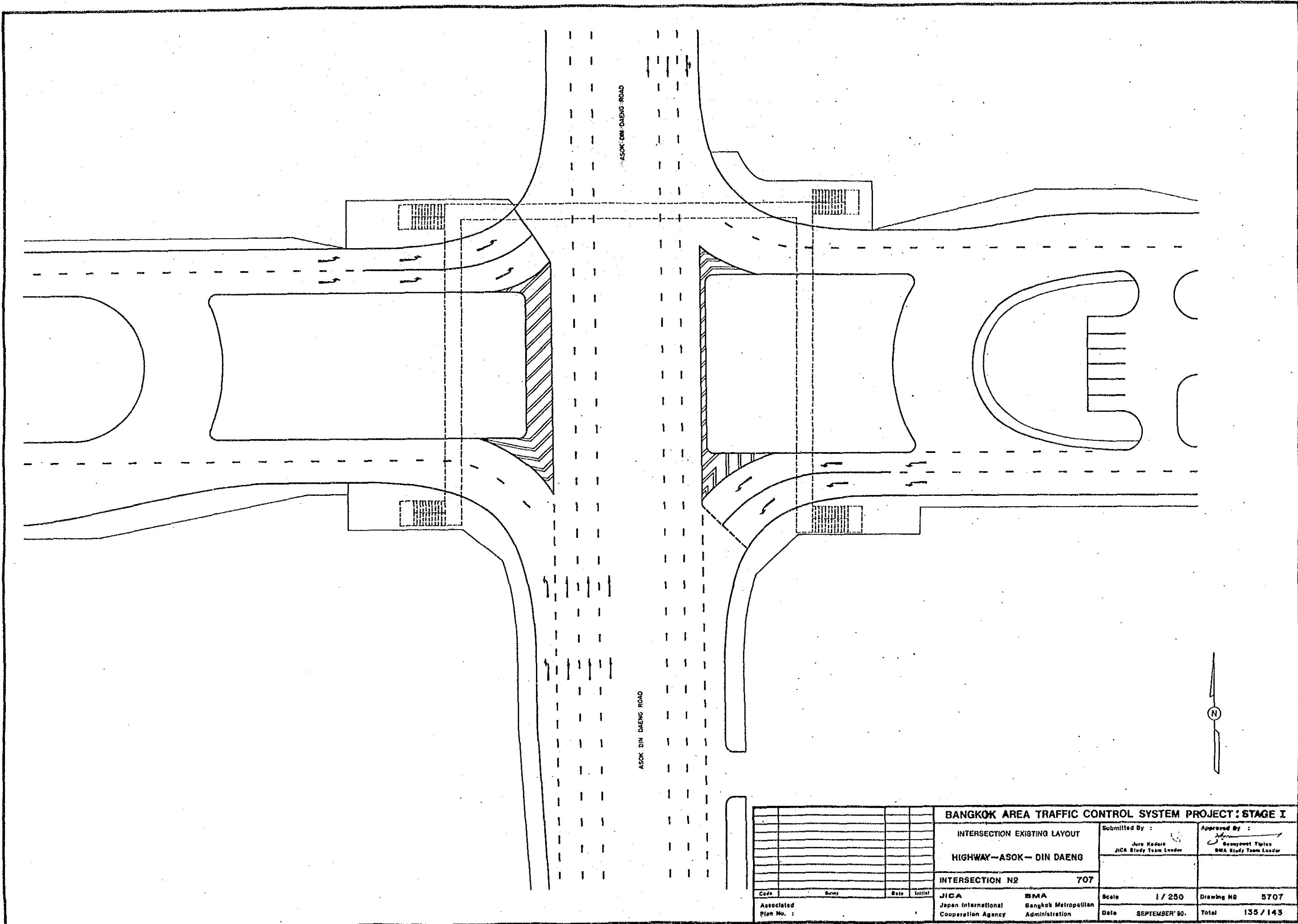

BANGKOK AREA TRAFFIC CONTROL SYSTEM PROJECT : STAGE I			
INTERSECTION EXISTING LAYOUT		Submitted By :	Approved By :
HIGHWAY-ASOK-DIN DAENG		Juro Kadera JICA Study Team Leader	Somyawat Tiplas BMA Study Team Leader
INTERSECTION NO 707			
Code	Scale	Date	Sheet
Associated Plan No. :	JICA Japan International Cooperation Agency	BMA Bangkok Metropolitan Administration	Scale 1 / 250 Date SEPTEMBER '90.
			Drawing NO 5707 Total 135 / 143

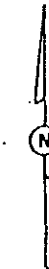
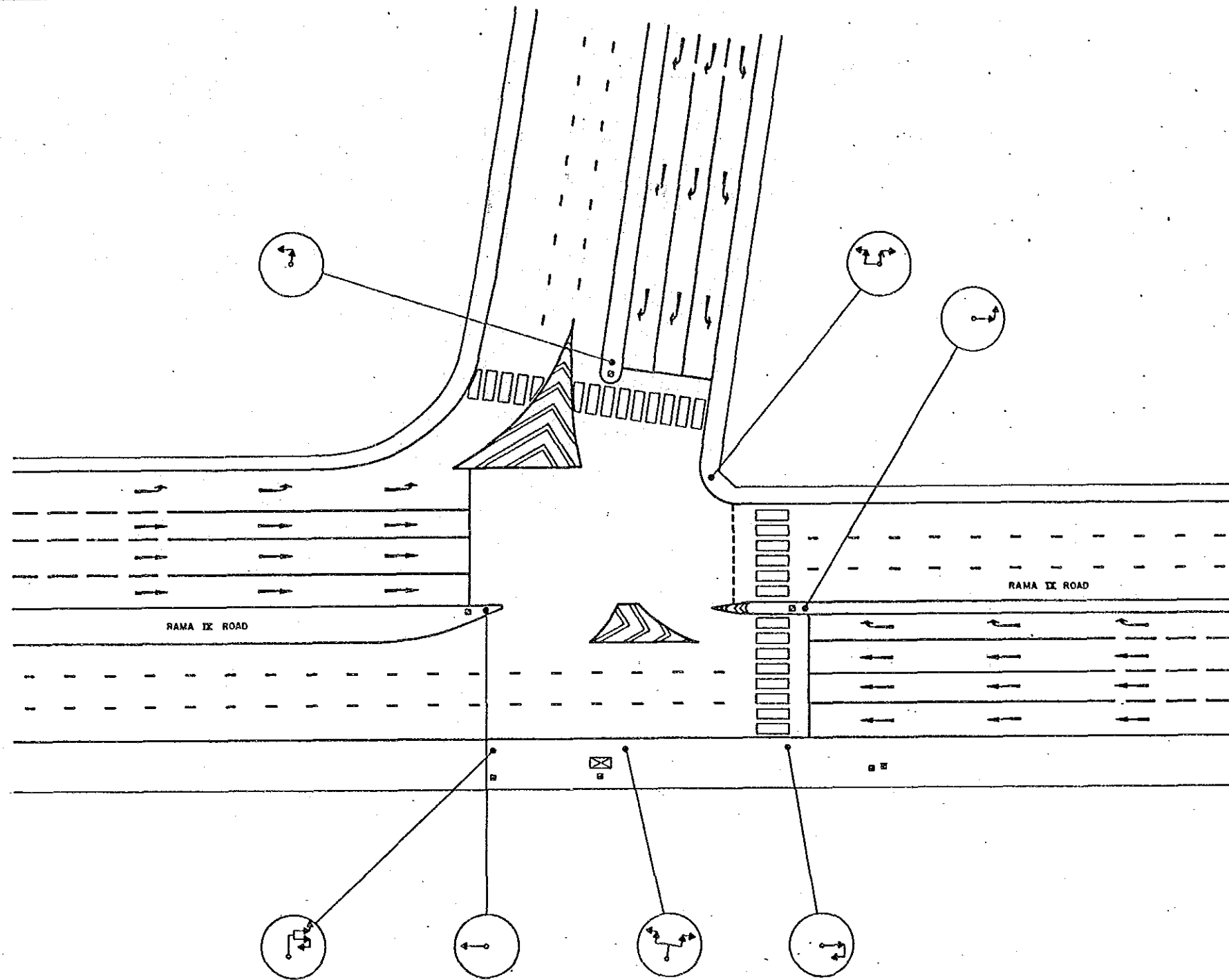

				BANGKOK AREA TRAFFIC CONTROL SYSTEM PROJECT : STAGE I			
				INTERSECTION EXISTING LAYOUT		Submitted By :	
				HIGHWAY - RAMA IX		Jiro Kodera JICA Study Team Leader	
				INTERSECTION NO 708		Approved By : Boonwong Tiplua BMA Study Team Leader	
Code	Rev	Date	Initial	JICA	BMA	Scale	1 / 250
Associated Plan No. :				Japan International Cooperation Agency	Bangkok Metropolitan Administration	Date	SEPTEMBER '90
						Drawing No	5708
						Total	136 / 143

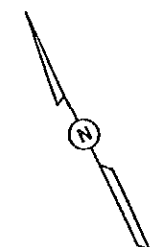
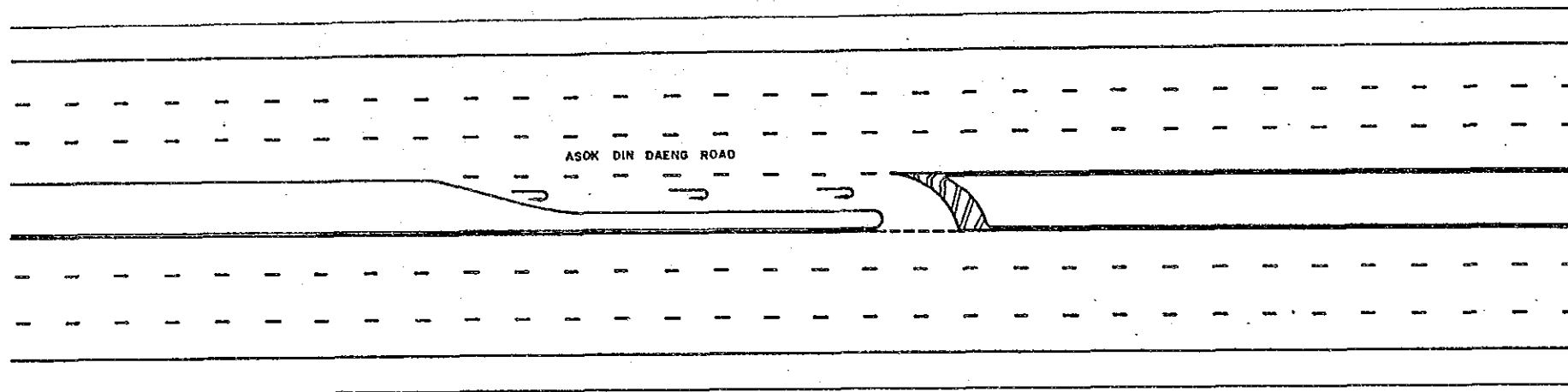

				BANGKOK AREA TRAFFIC CONTROL SYSTEM PROJECT : STAGE I			
				INTERSECTION EXISTING LAYOUT		Submitted By : <i>Jura Kodera</i>	
				U-TURN AT ASOK DIN DAENG(WEST)		Approved By : <i>Boonjaval Tiptua</i>	
				INTERSECTION NO 801			
				JICA		BMA	
Associated				Japan International		Bangkok Metropolitan	
Plan No. :				Cooperation Agency		Administration	
				Scale 1 / 250		Drawing No 5801	
				Date SEPTEMBER '90		Total 137 / 143	

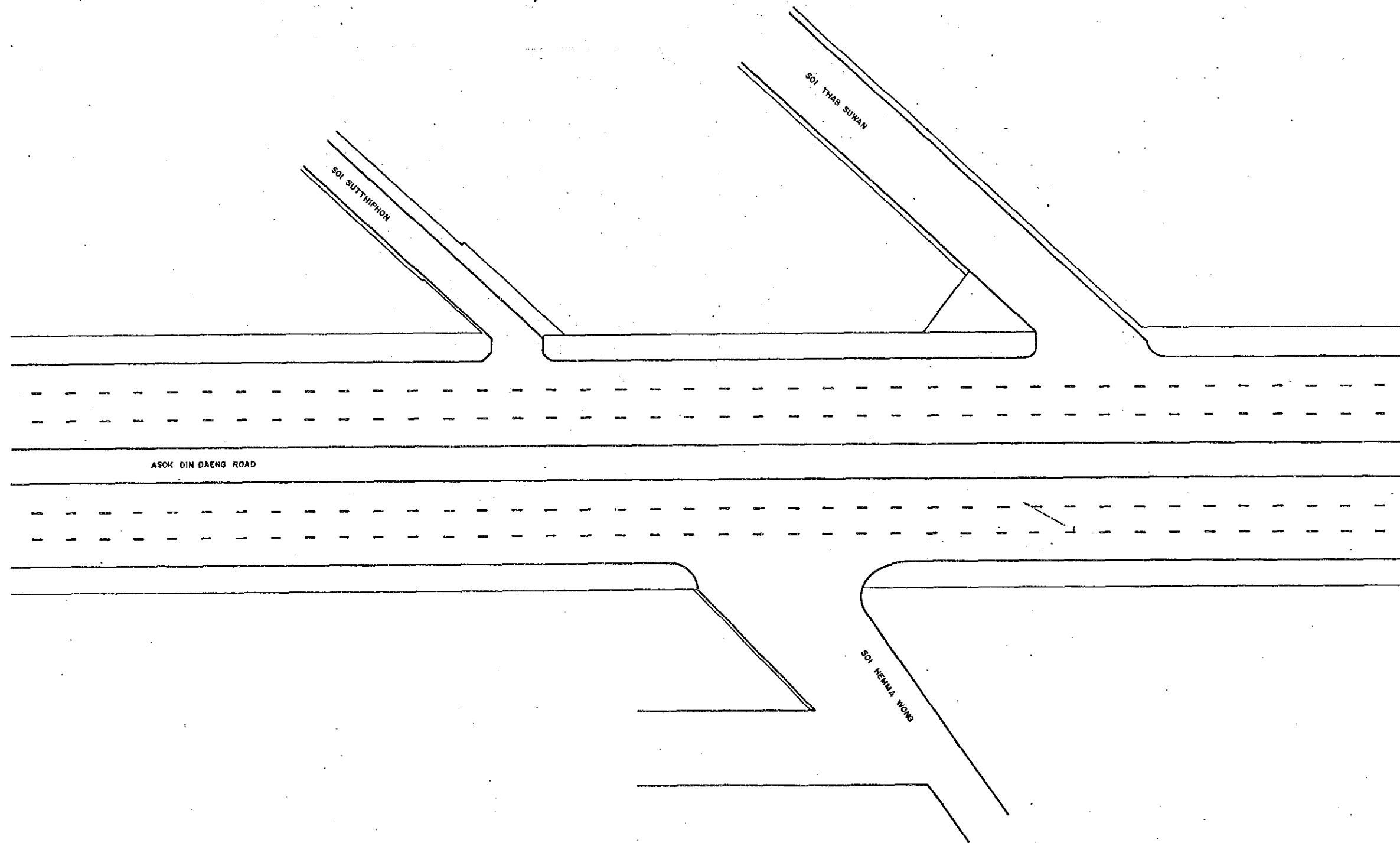

ASOK DIN DAENG ROAD

SOI SUTTHIPHON

SOI THAB SUWAN

SOI NEMA WONG

N

				BANGKOK AREA TRAFFIC CONTROL SYSTEM PROJECT : STAGE I			
				INTERSECTION EXISTING LAYOUT		Submitted By :	Approved By :
				U-TURN AT ASOK DIN DAENG (EAST)		Jaro Kodera JICA Study Team Leader	Boonyasri Titus BMA Study Team Leader
				INTERSECTION NO		802	
Code	Survey	Date	Initial	JICA	BMA	Scale	1 / 250
Associated Plan No. :				Japan International Cooperation Agency	Bangkok Metropolitan Administration	Date	SEPTEMBER '90
						Drawing No	5802
						Total	138 / 143

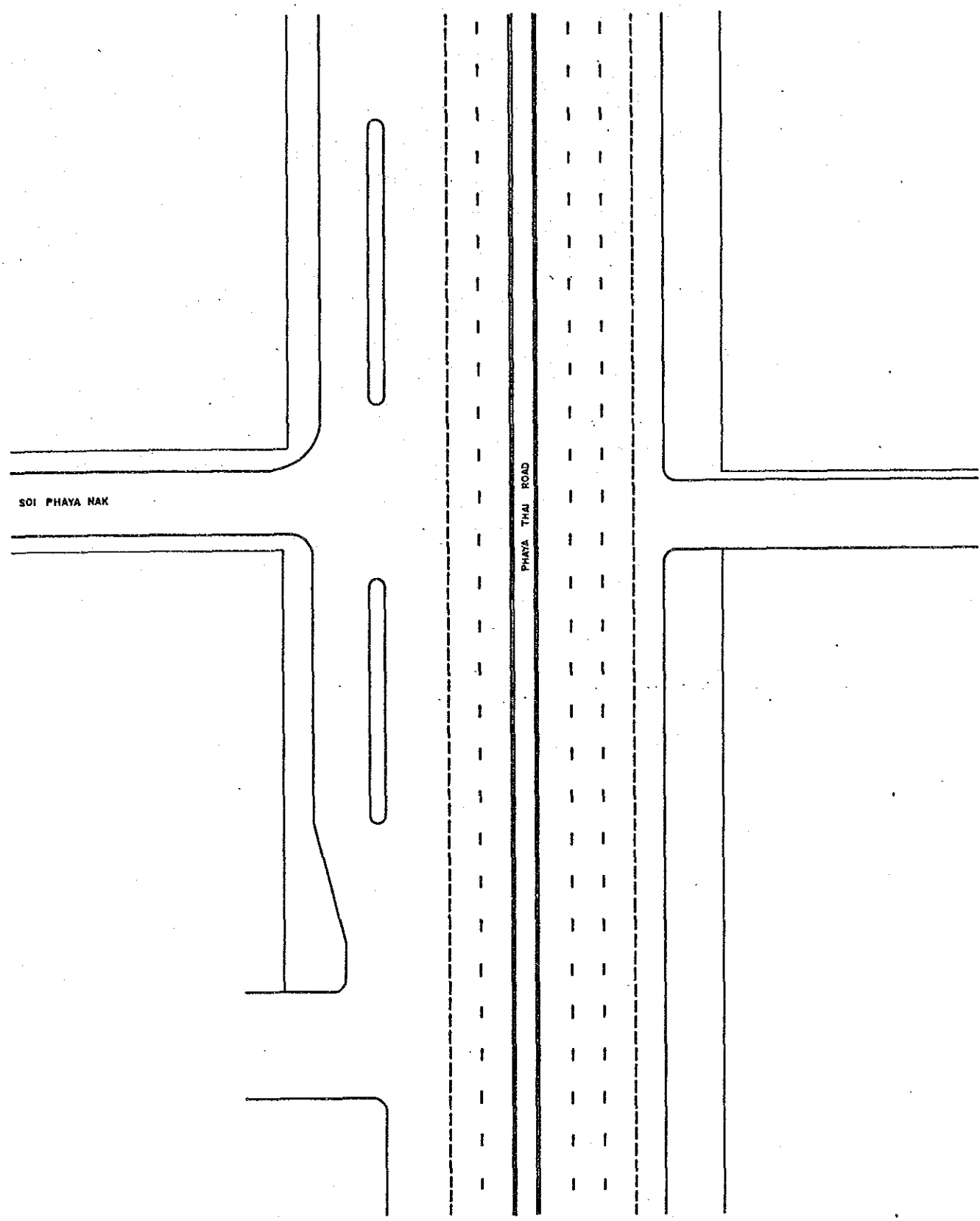

				BANGKOK AREA TRAFFIC CONTROL SYSTEM PROJECT : STAGE I			
				INTERSECTION EXISTING LAYOUT		Submitted By :	
				U-TURN AT PHAYA THAI (ASIA HOTEL)		 Jiro Kodera JICA Study Team Leader	
				INTERSECTION NO 803		 Boonawat Tipiva BMA Study Team Leader	
Code	Survey	Date	Initial	JICA	BMA	Scale	Drawing No
Associated Plan No. :				Japan International Cooperation Agency	Bangkok Metropolitan Administration	1 / 250	5803
						Date	Total
						SEPTEMBER '90	139 / 143

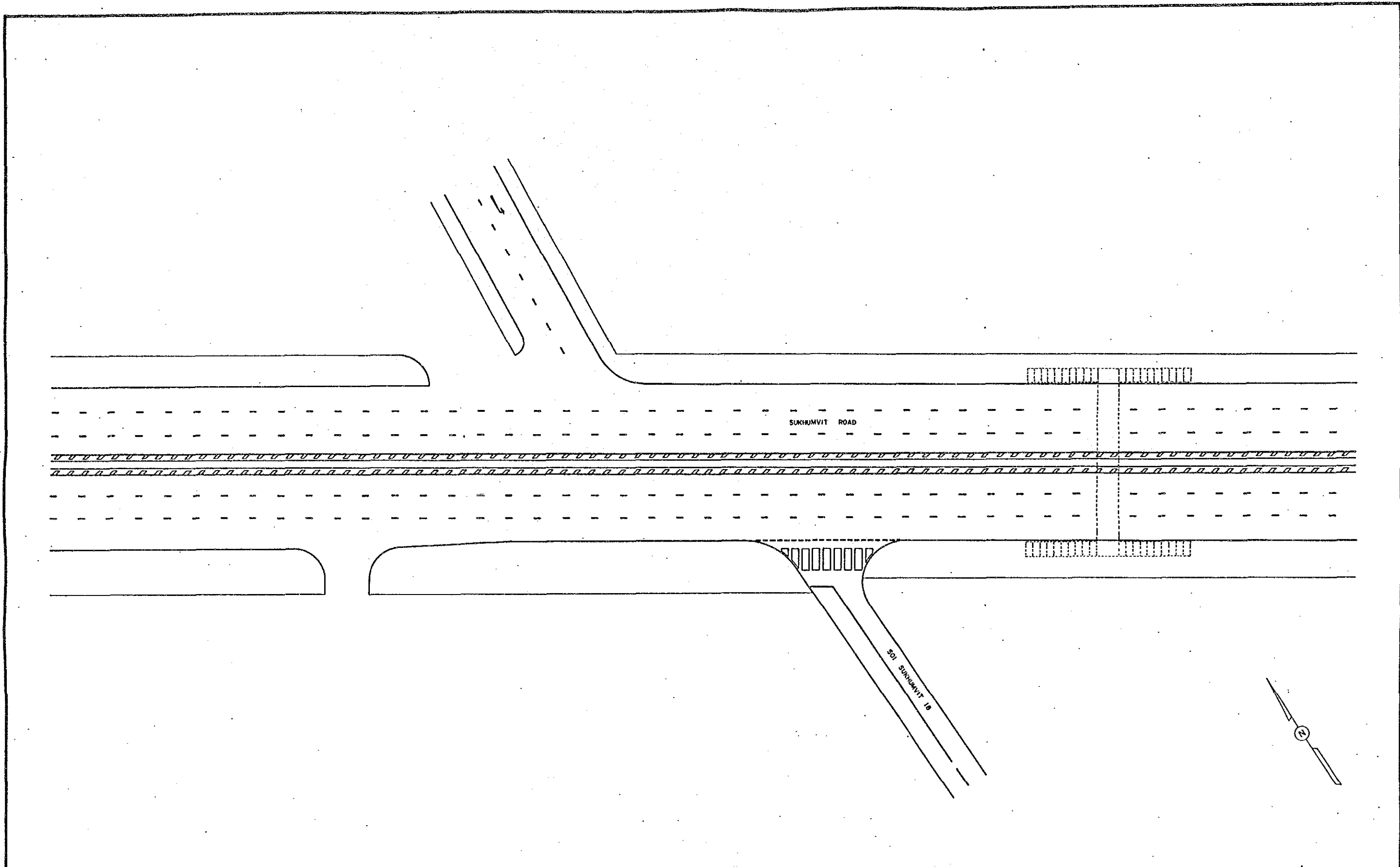

				BANGKOK AREA TRAFFIC CONTROL SYSTEM PROJECT : STAGE I			
				INTERSECTION EXISTING LAYOUT		Submitted By :	
				U - TURN AT SUKHUMVIT		 Jiro Kadota JICA Study Team Leader	
				INTERSECTION N ^o 604		 Boonyawat Tiptan BMA Study Team Leader	
Code	Rev	Date	Initial	JICA	BMA	Scale	Drawing N ^o
Associated Plan No. :				Japan International Cooperation Agency	Bangkok Metropolitan Administration	1 / 250	5804
						Date	Total
						SEPTEMBER '90	140 / 143

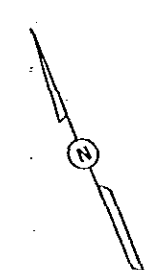
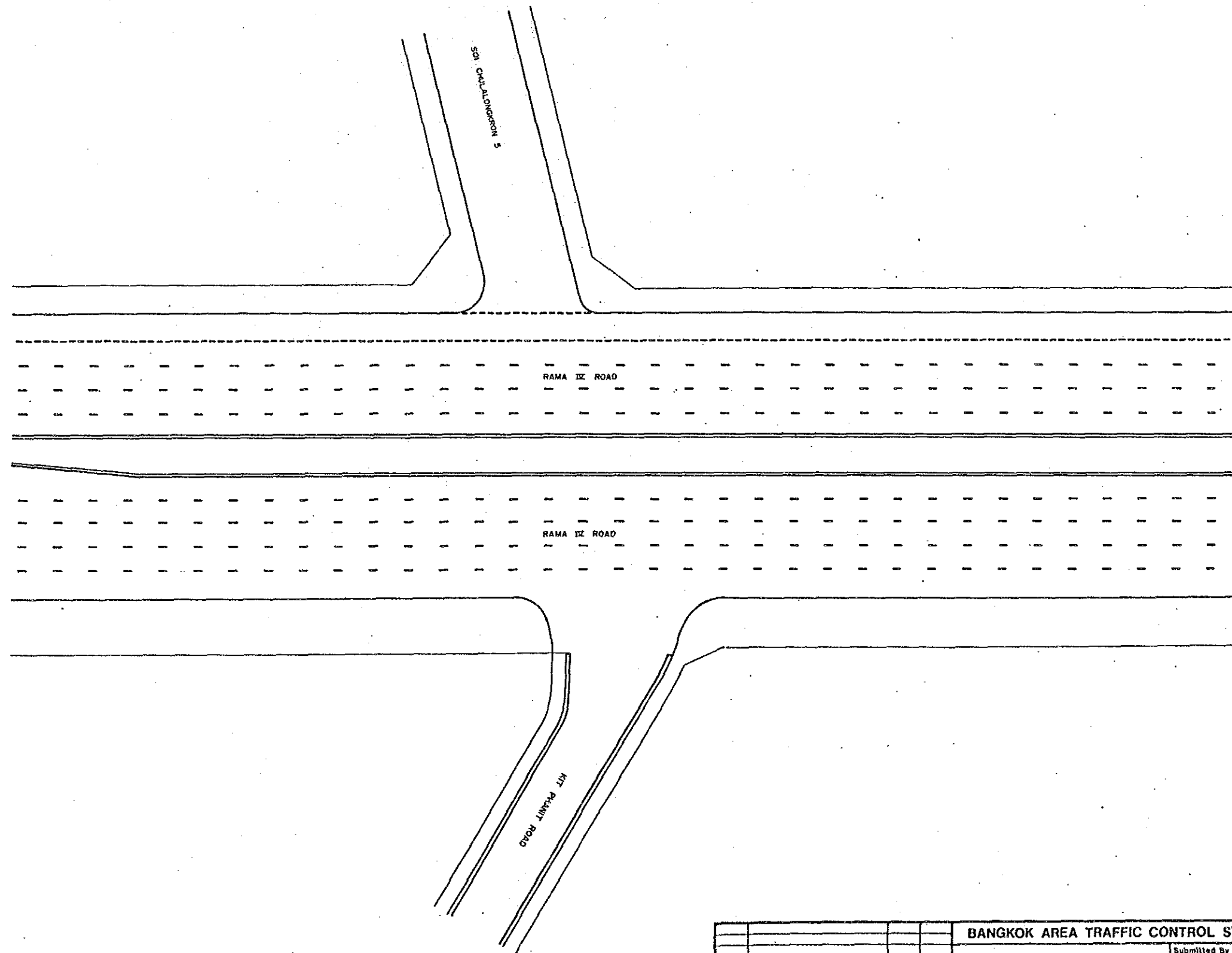

BANGKOK AREA TRAFFIC CONTROL SYSTEM PROJECT : STAGE I			
INTERSECTION EXISTING LAYOUT		Submitted By :	Approved By :
U-TURN AT RAMA IV		Jiro Kikora JICA Study Team Leader	<i>[Signature]</i> Boonwatt Titus BMA Study Team Leader
INTERSECTION NO 805			
Code	Survey	Date	Initial
Associated Plan No. :		JICA Japan International Cooperation Agency	BMA Bangkok Metropolitan Administration
		Scale 1/250	Drawing NO 5805
		Date SEPTEMBER '90	Total 141 / 143

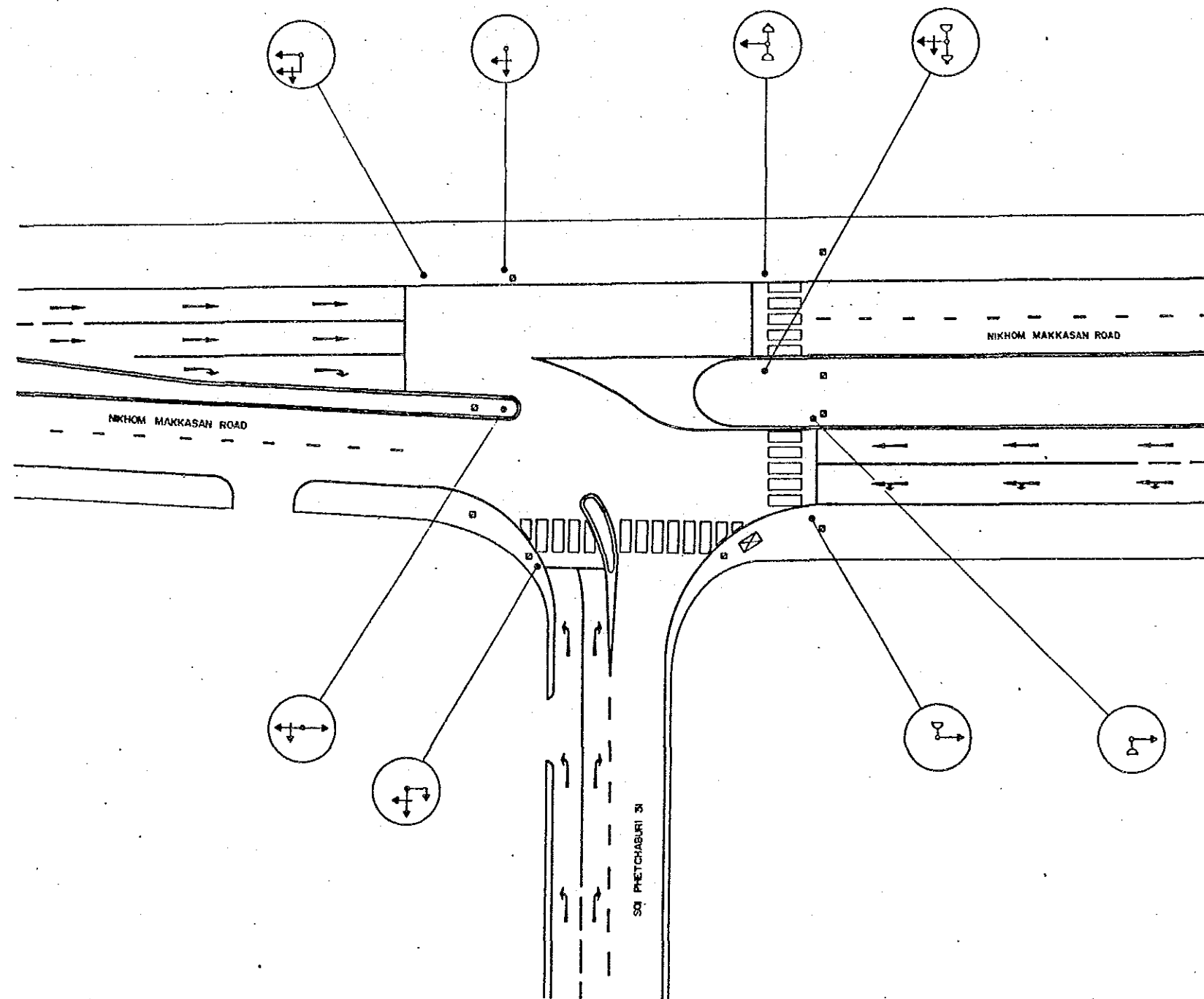

				BANGKOK AREA TRAFFIC CONTROL SYSTEM PROJECT : STAGE I			
				INTERSECTION EXISTING LAYOUT		Submitted By :	Approved By :
				NIKHOM MAKKASAN — SOI PHETCHABURI 31		Jiro Kodera JICA Study Team Leader	<i>[Signature]</i> Boonwut Tiplua BMA Study Team Leader
				INTERSECTION NO	904		
Case	Survey	Date	Initial	JICA	BMA	Scale	Drawing No
Associated Plan No. :				Japan International Cooperation Agency	Bangkok Metropolitan Administration	1 / 250	5904
						Date	Total
						SEPTEMBER '90	142 / 143

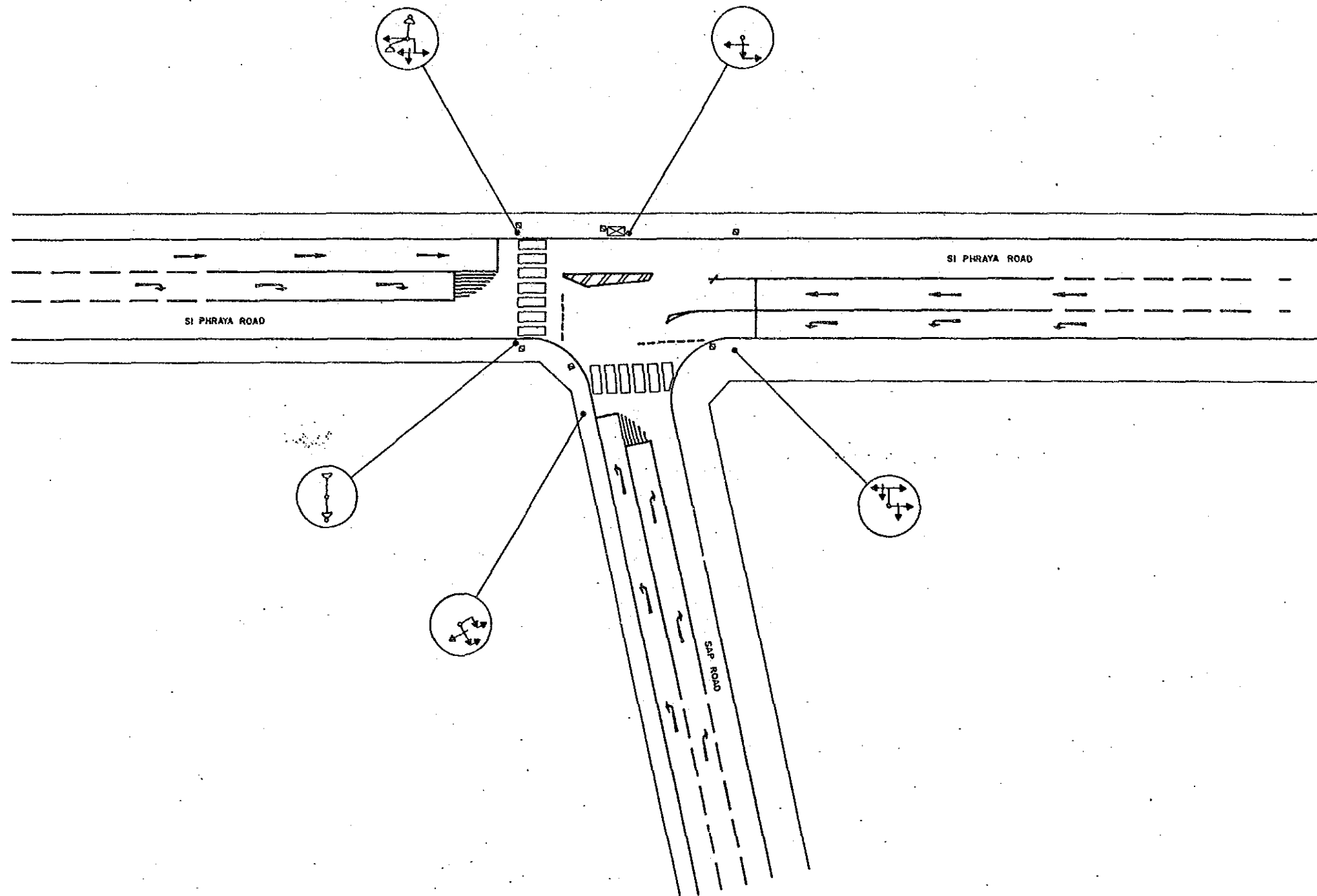

				BANGKOK AREA TRAFFIC CONTROL SYSTEM PROJECT : STAGE I			
				INTERSECTION EXISTING LAYOUT		Submitted By :	Approved By :
				SI PHRAYA - SAP		Juru' Rodesa JICA Study Team Leader	<i>[Signature]</i> Keongwal Tiptua BMA Study Team Leader
				INTERSECTION NO	905		
Code	Survey	Date	Initial	JICA	BMA	Scale	1 / 250
Associated Plan No. :				Japan International Cooperation Agency	Bangkok Metropolitan Administration	Date	SEPTEMBER '90
						Drawing NO	5905
						Total	143 / 143

