

GENERAL PLAN

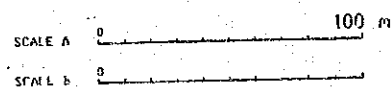

Fig. 4.17
 General Plan of Kemubu Dam

GOVERNMENT OF MALAYSIA
 STUDY
 ON
 KELANTAN RIVER BASIN - WIDE FLOOD MITIGATION
 JAPAN INTERNATIONAL COOPERATION AGENCY

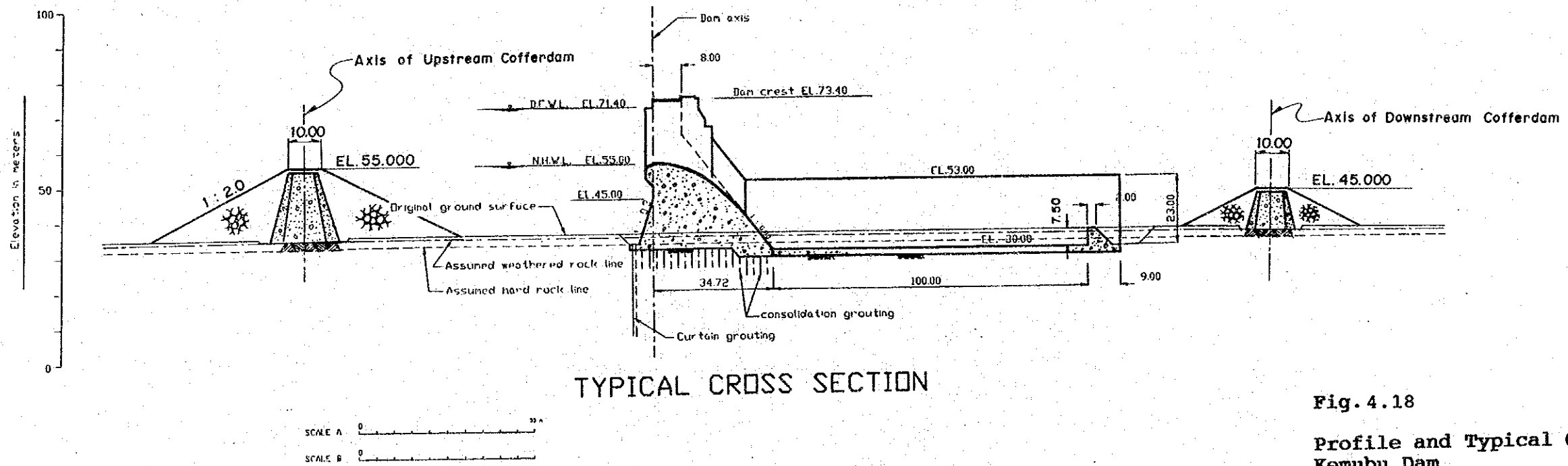
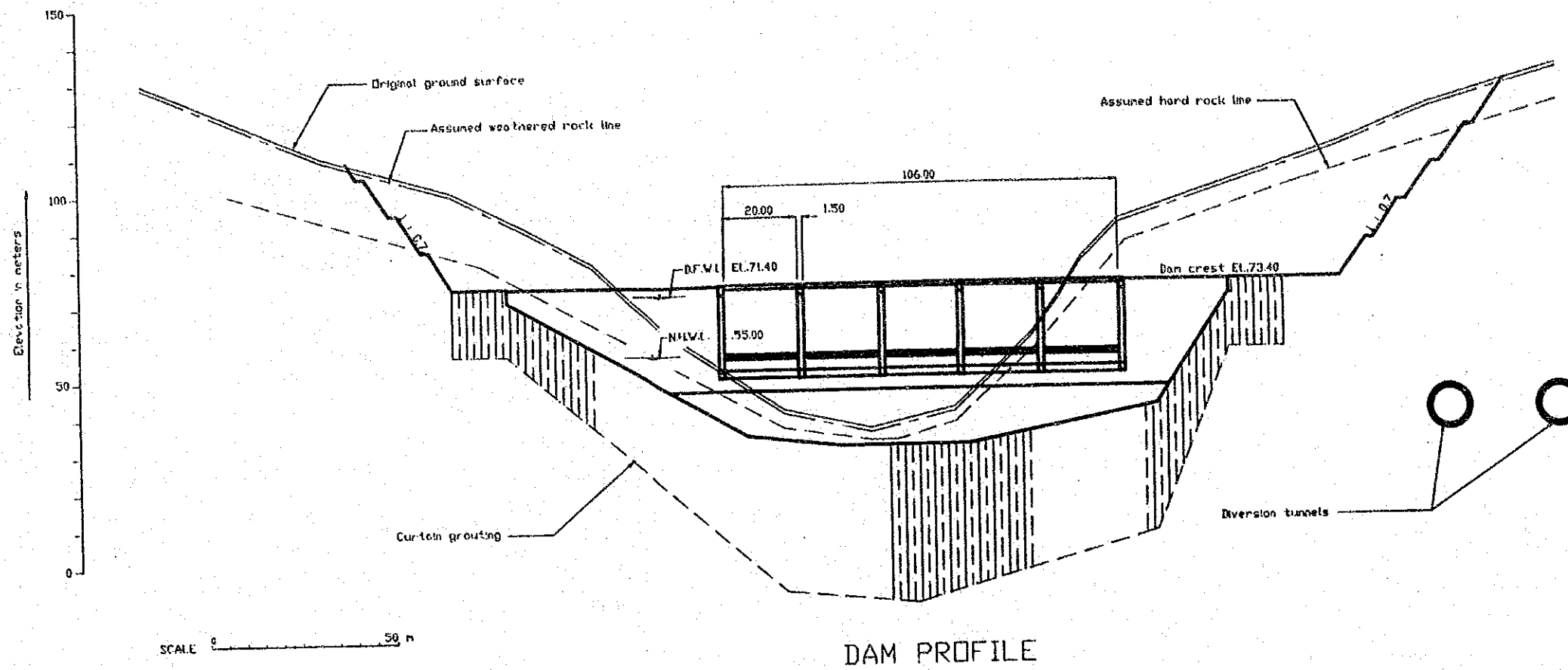

Fig. 4.18

Profile and Typical Cross Section of Kemubu Dam

GOVERNMENT OF MALAYSIA
 STUDY
 ON
 KELANTAN RIVER BASIN - WIDE FLOOD MITIGATION
 JAPAN INTERNATIONAL COOPERATION AGENCY

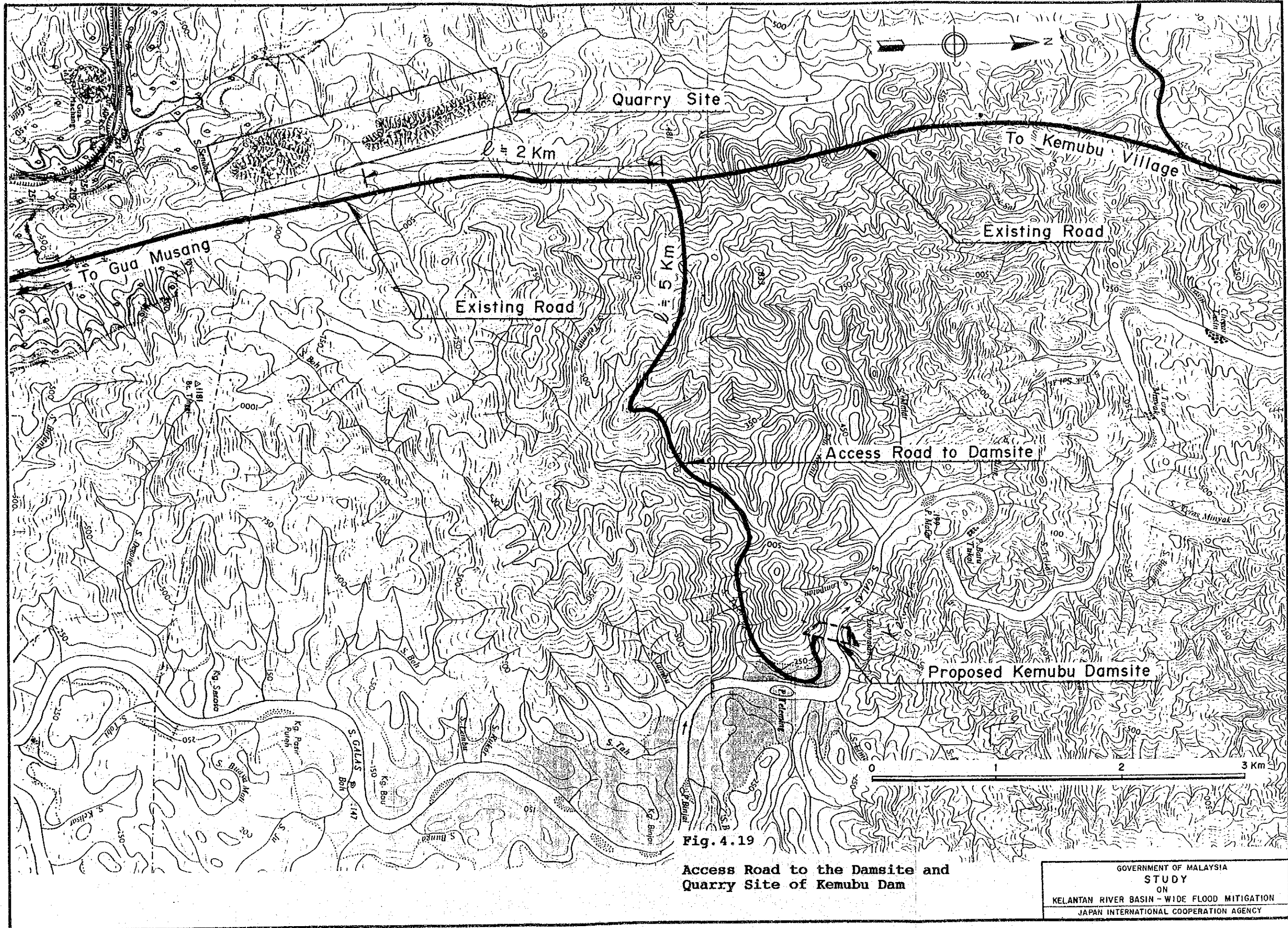

Fig. 4.19

Access Road to the Damsite and Quarry Site of Kemubu Dam

GOVERNMENT OF MALAYSIA
 STUDY
 ON
 KELANTAN RIVER BASIN - WIDE FLOOD MITIGATION
 JAPAN INTERNATIONAL COOPERATION AGENCY

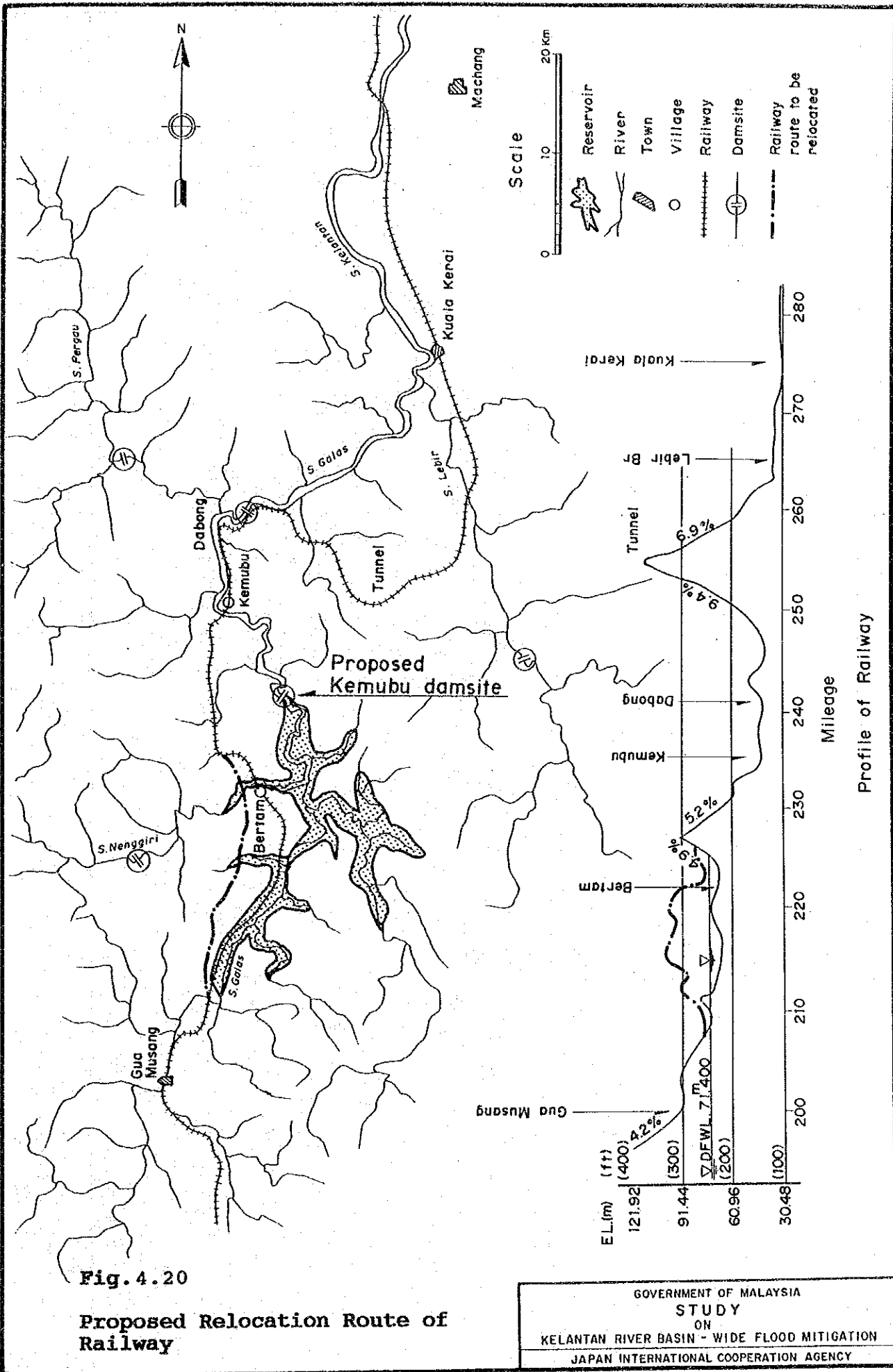
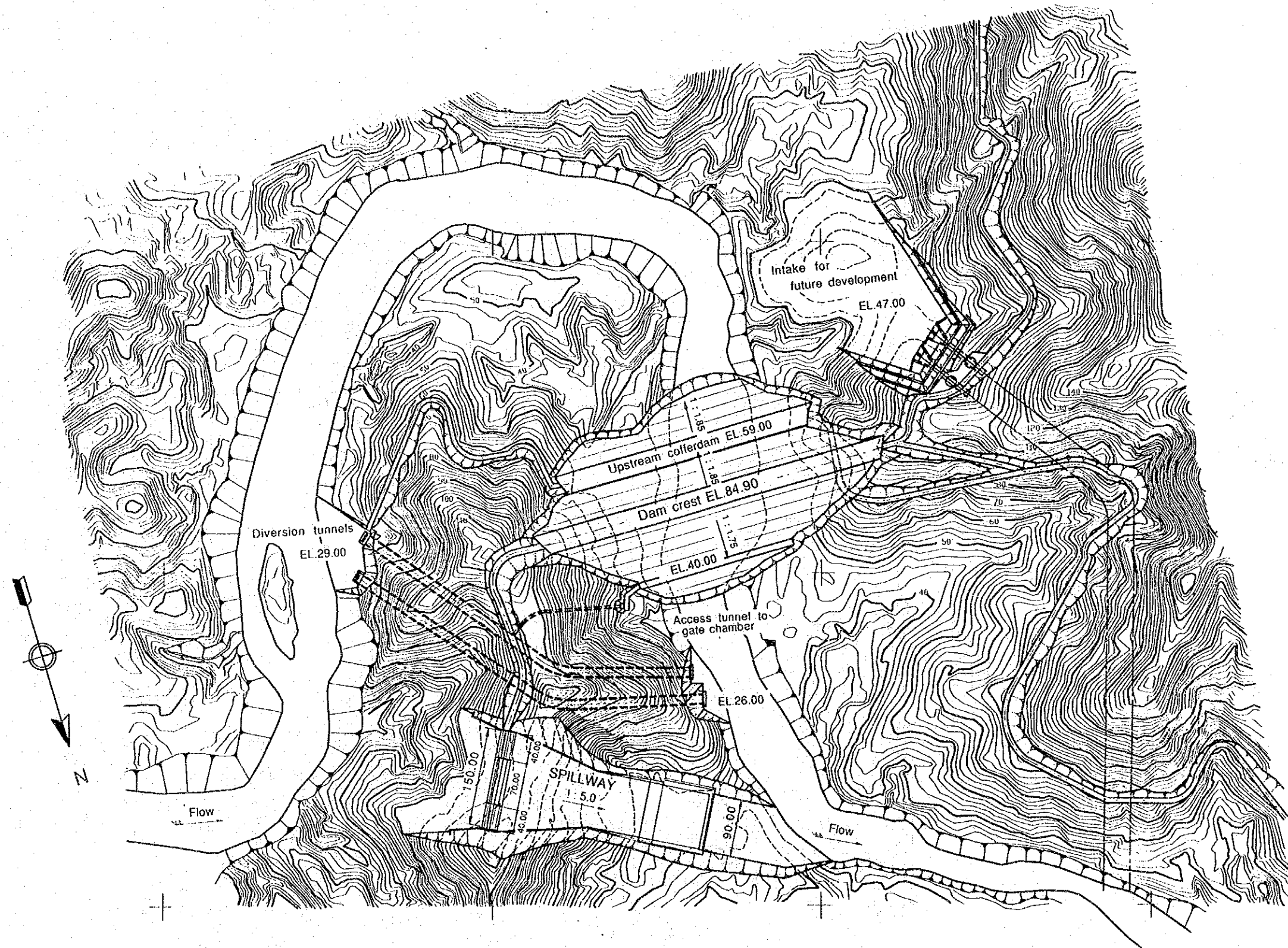

Fig. 4.20

Proposed Relocation Route of Railway

GOVERNMENT OF MALAYSIA
 STUDY
 ON
 KELANTAN RIVER BASIN - WIDE FLOOD MITIGATION
 JAPAN INTERNATIONAL COOPERATION AGENCY



SCALE 1:1000

GENERAL PLAN

Fig. 4.21

General Plan of Lebir Dam

GOVERNMENT OF MALAYSIA
 STUDY
 ON
 KELANTAN RIVER BASIN - WIDE FLOOD MITIGATION
 JAPAN INTERNATIONAL COOPERATION AGENCY

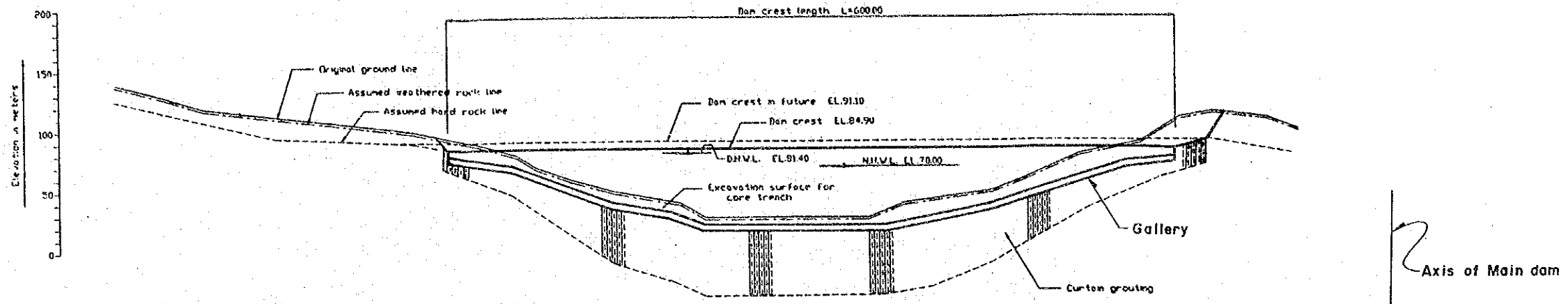

Scale 1:10000

PROFILE OF LEBIR DAM

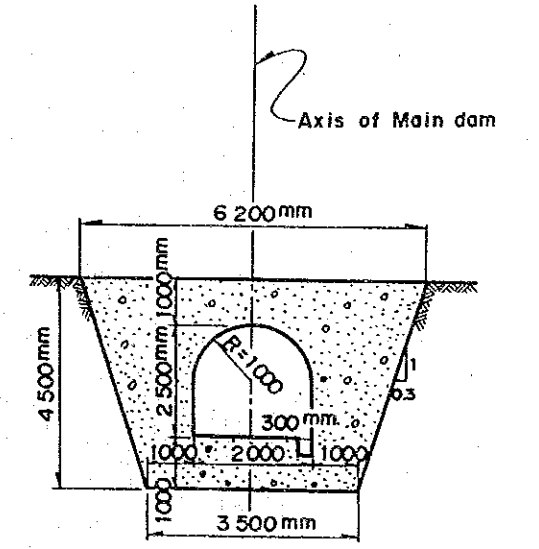

TYPICAL CROSS SECTION OF GALLERY

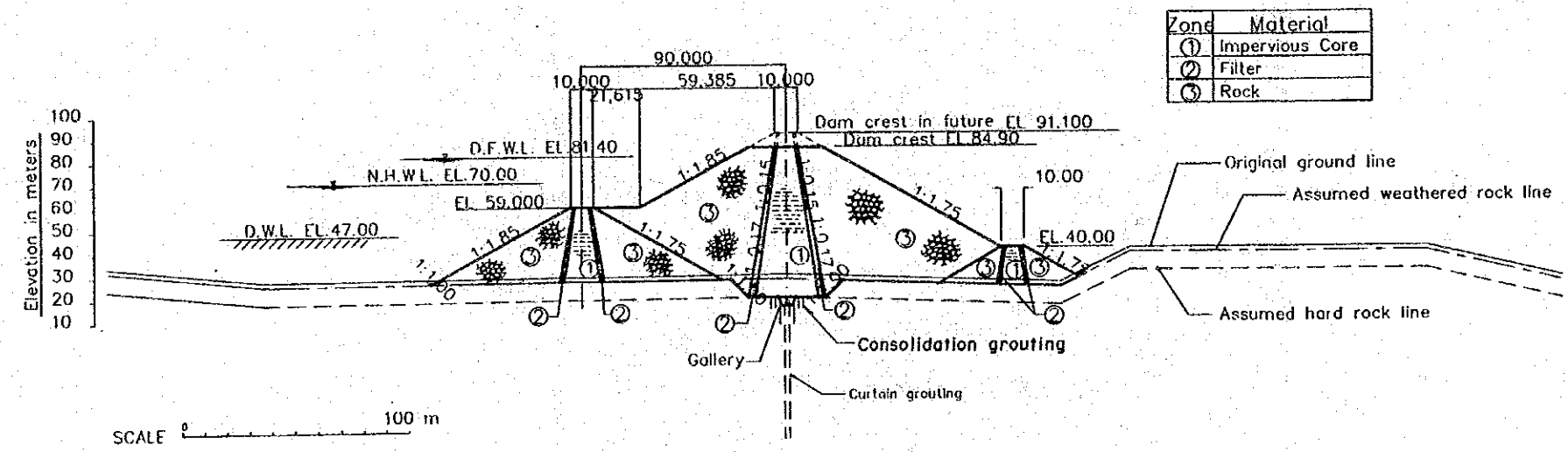

SCALE 1:10000

TYPICAL CROSS SECTION OF MAIN DAM

Fig. 4.22

Profile and Typical Cross Section of Lebir Dam

GOVERNMENT OF MALAYSIA
 STUDY
 ON
 KELANTAN RIVER BASIN - WIDE FLOOD MITIGATION
 JAPAN INTERNATIONAL COOPERATION AGENCY

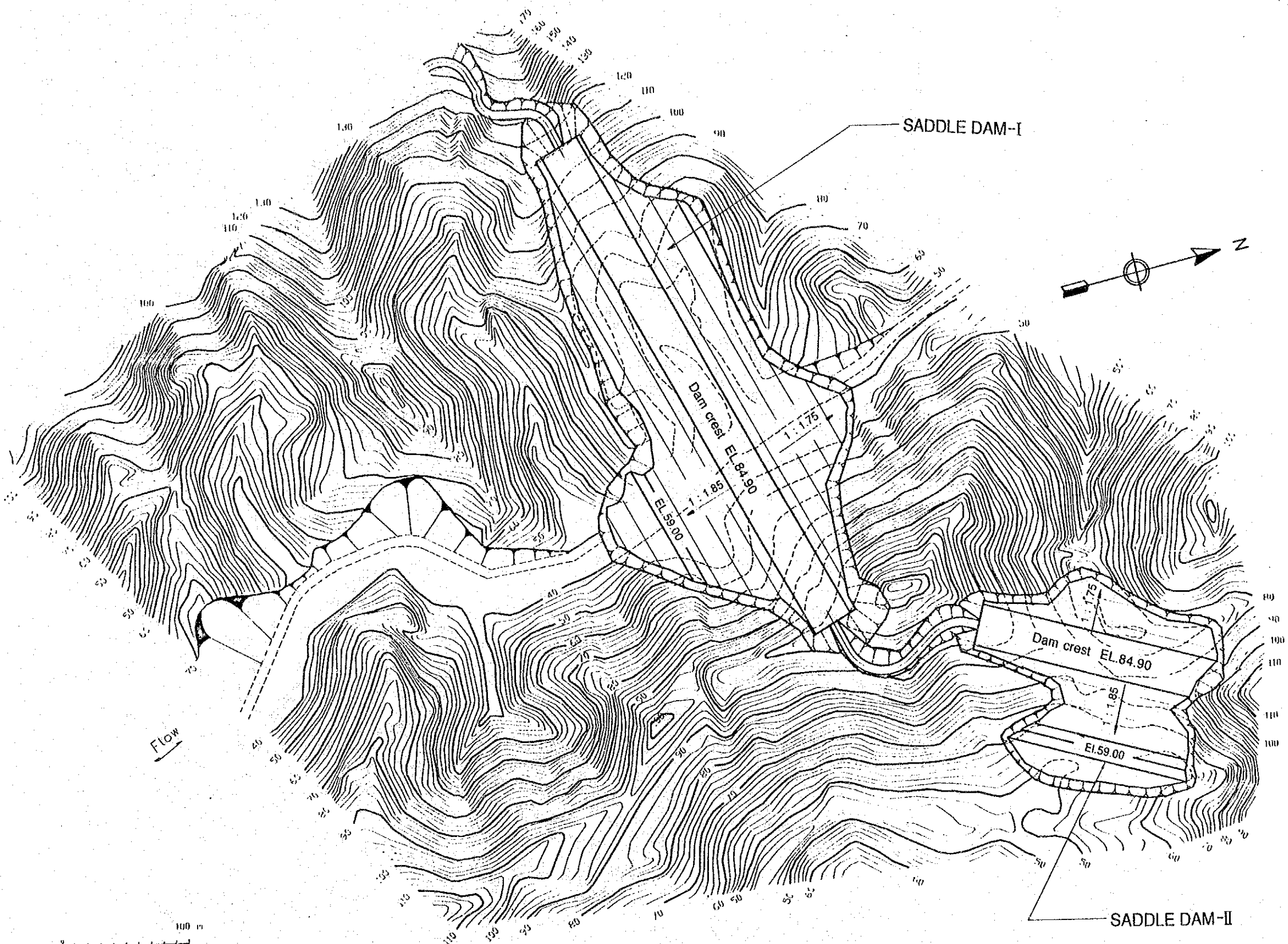

GENERAL PLAN OF SADDLE DAM I AND II

Fig. 4.23

General Plan of Saddle Dams I and II

GOVERNMENT OF MALAYSIA
 STUDY
 ON
 KELANTAN RIVER BASIN - WIDE FLOOD MITIGATION
 JAPAN INTERNATIONAL COOPERATION AGENCY

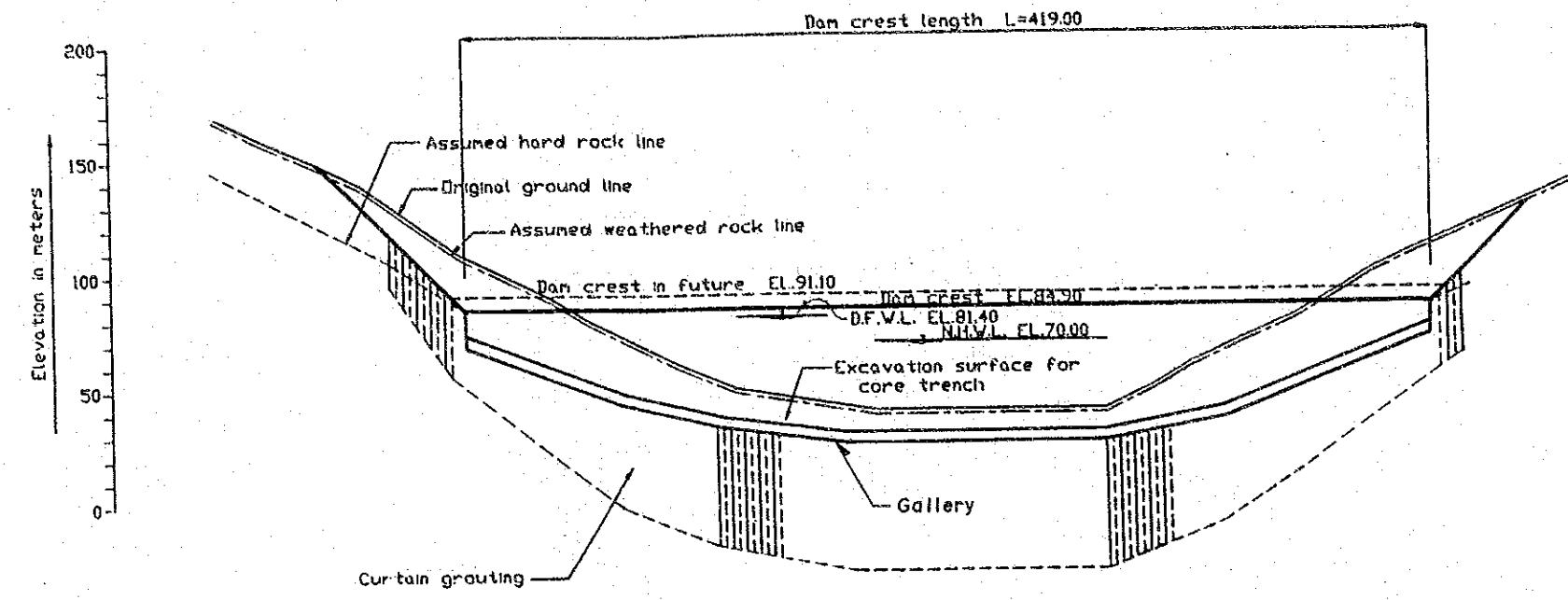

SCALE 1:10000

PROFILE OF SADDLE DAM I

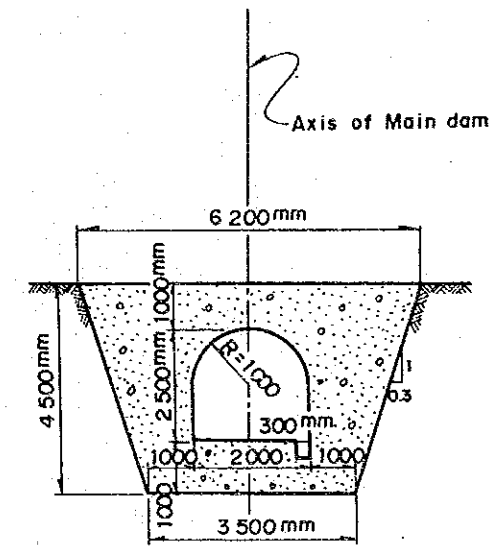

TYPICAL CROSS SECTION OF GALLERY

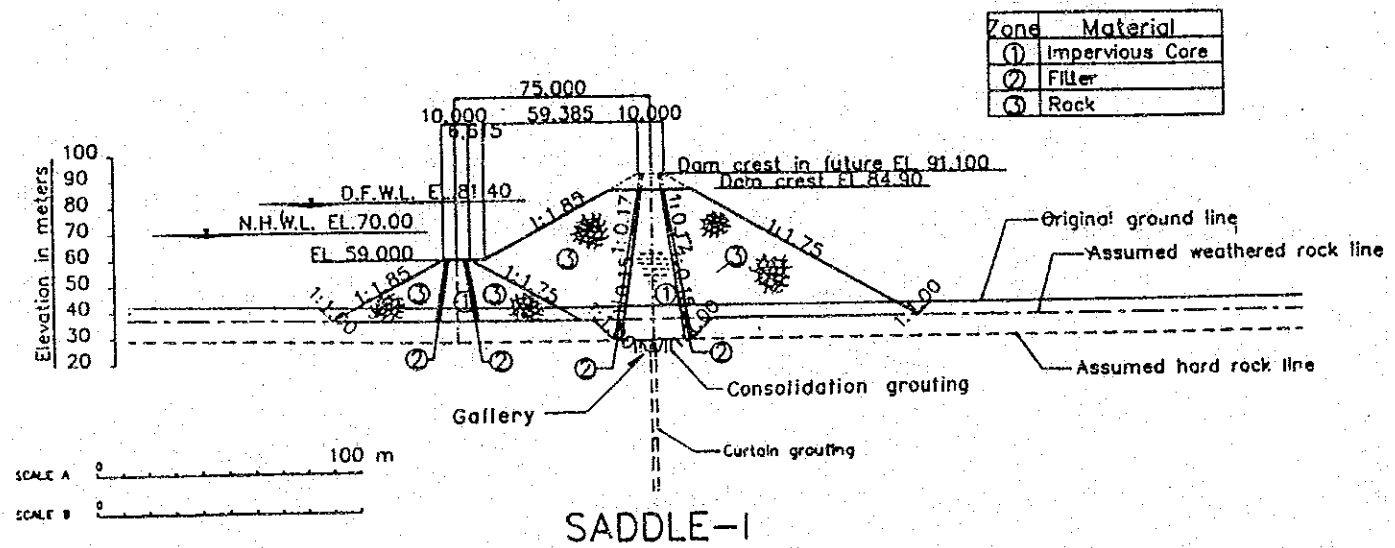

SCALE A 1:10000
SCALE B 1:5000

SADDLE-I

Fig. 4.24

Profile and Cross Section of Saddle Dam I of Lebir Scheme

GOVERNMENT OF MALAYSIA
STUDY
ON
KELANTAN RIVER BASIN - WIDE FLOOD MITIGATION
JAPAN INTERNATIONAL COOPERATION AGENCY

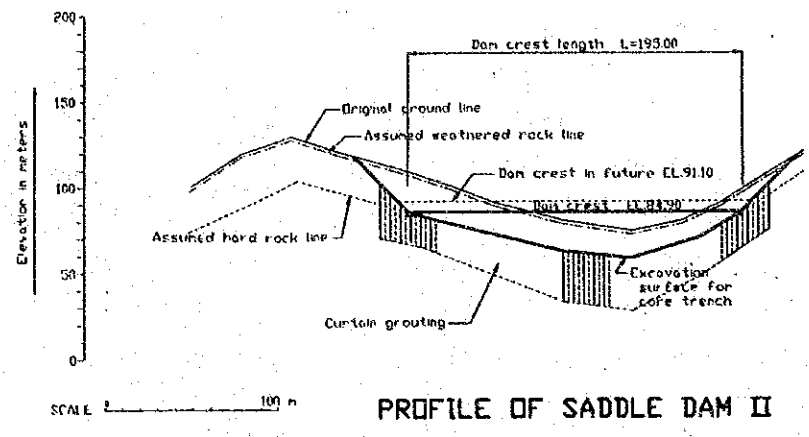

PROFILE OF SADDLE DAM II

| Zone | Material |
|------|-----------------|
| ① | Impervious Core |
| ② | Filter |
| ③ | Rock |

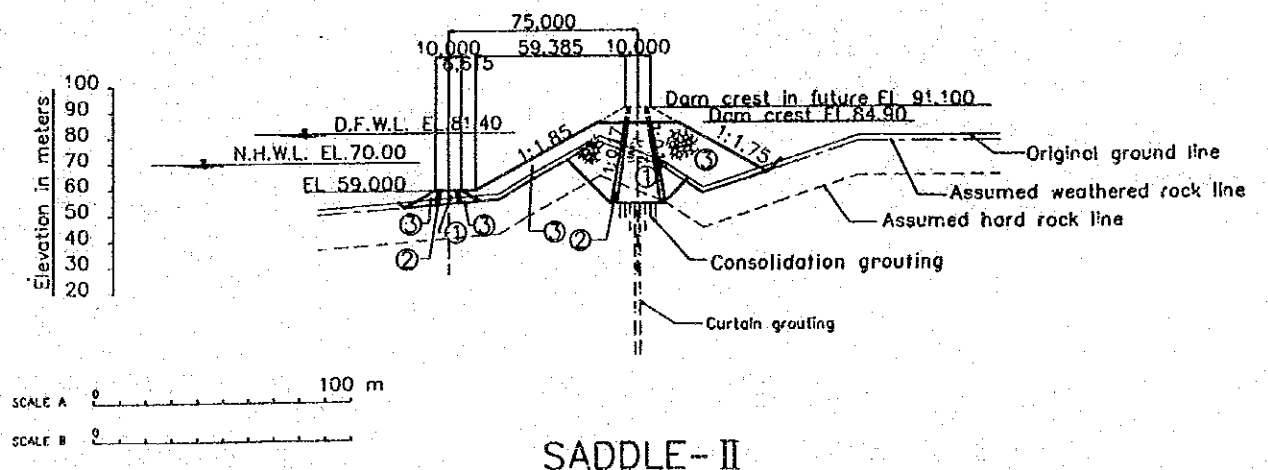

SADDLE-II

Fig. 4.25

Profile and Cross Section of Saddle Dam II of Lebir Scheme

GOVERNMENT OF MALAYSIA
 STUDY
 ON
 KELANTAN RIVER BASIN - WIDE FLOOD MITIGATION
 JAPAN INTERNATIONAL COOPERATION AGENCY

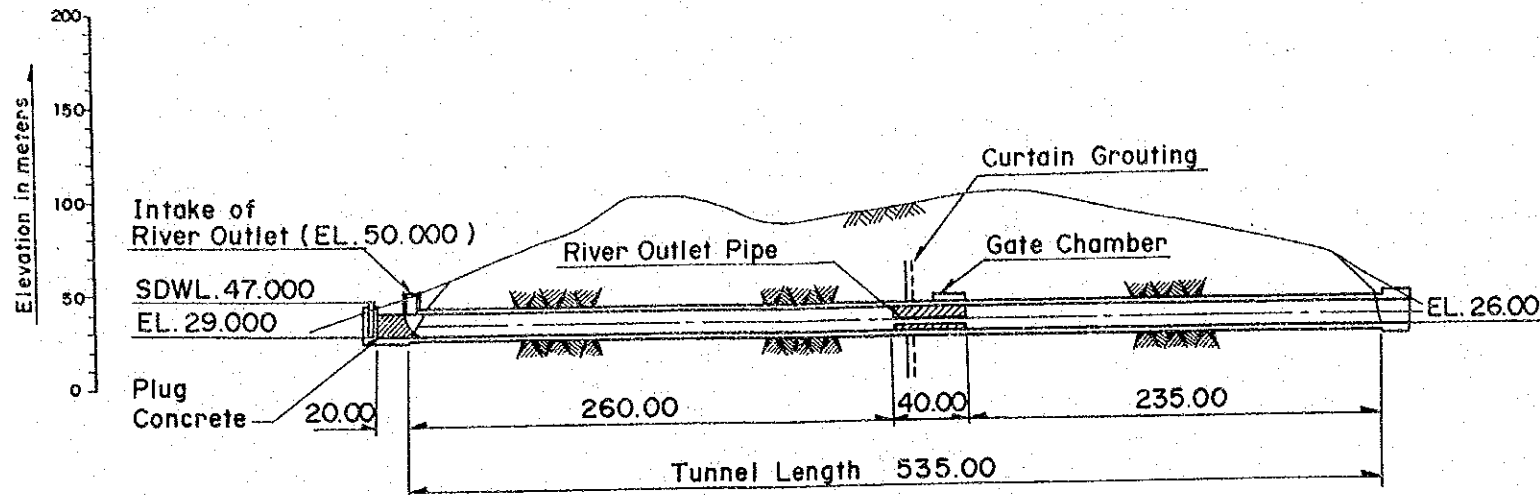

PROFILE OF DIVERSION TUNNEL SCALE A

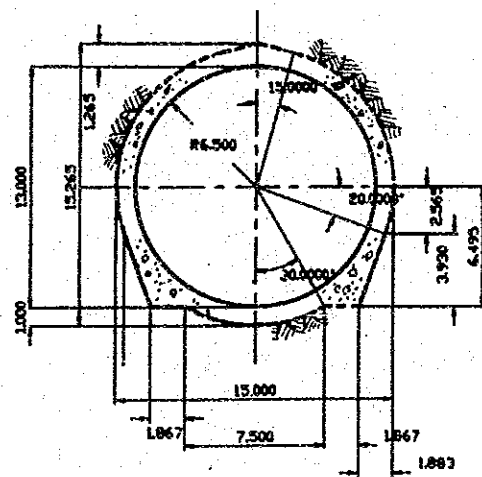
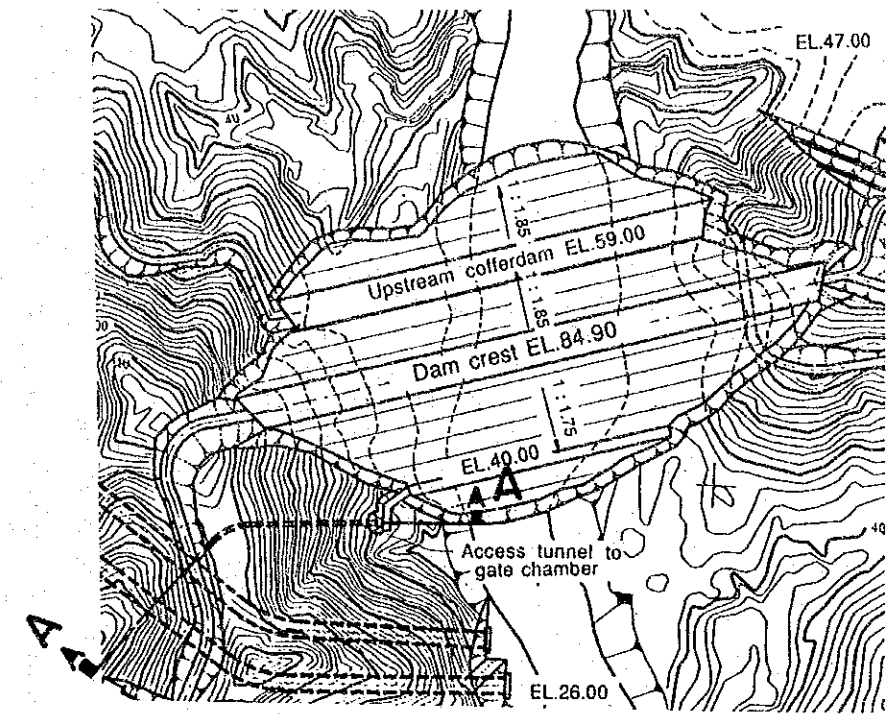

TYPICAL CROSS SECTION

SCALE B

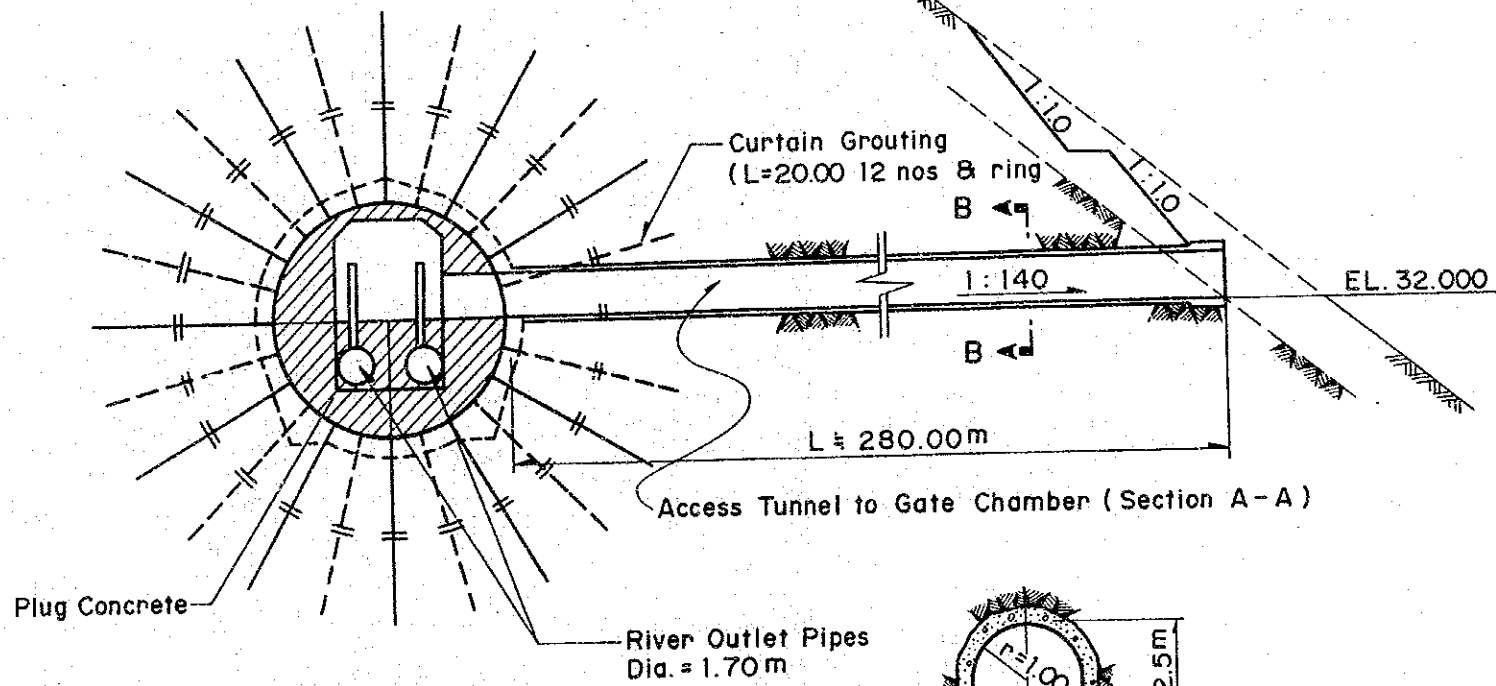

PLUG CONCRETE PART

SCALE B

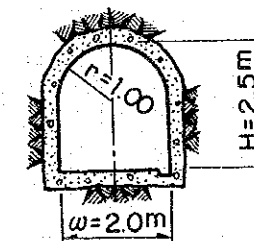

TYPICAL CROSS SECTION OF ACCESS TUNNEL (SECTION B-B)

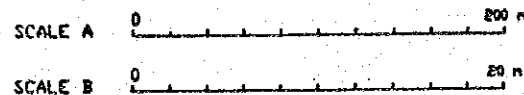
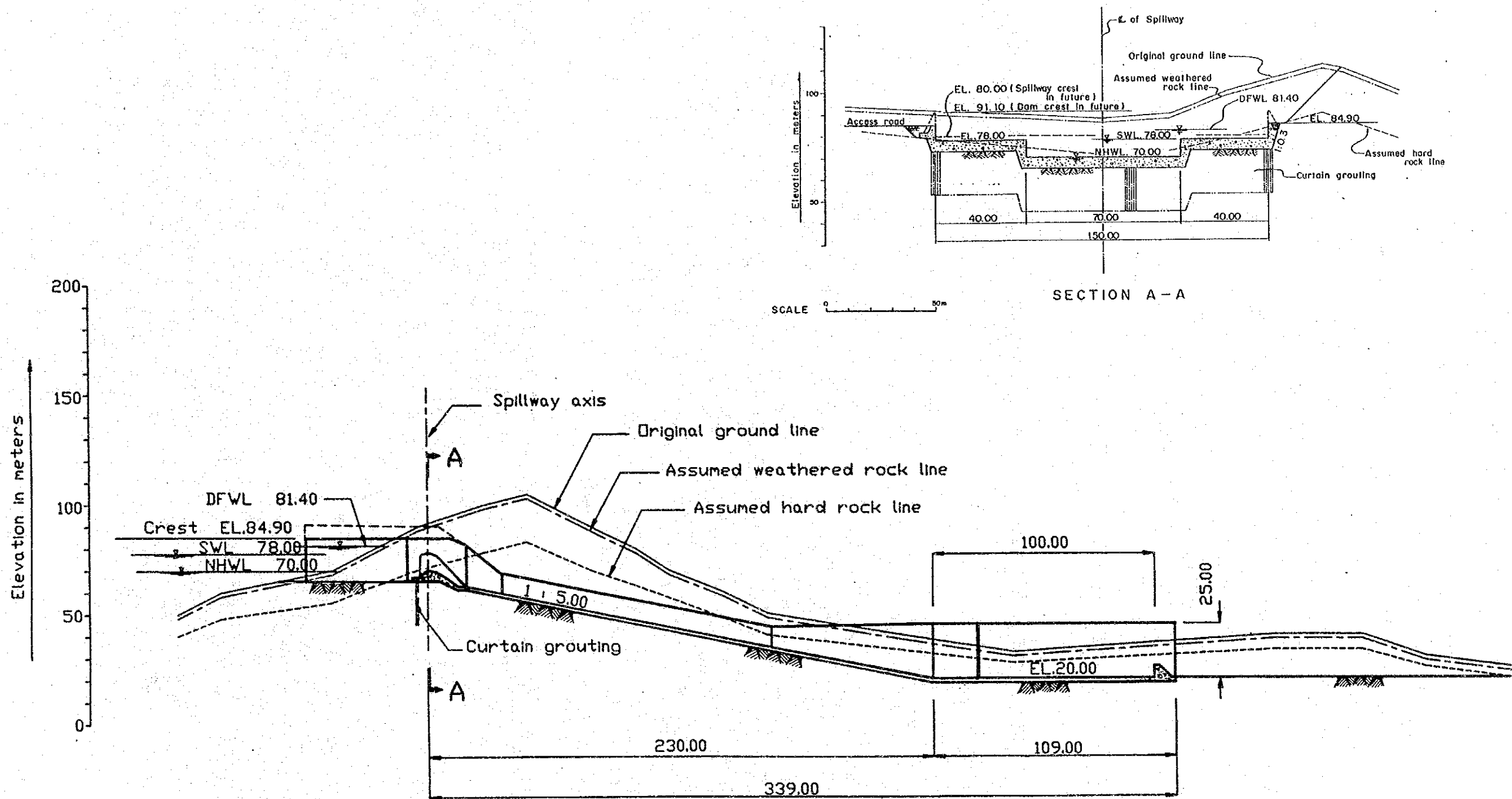

Fig. 4.26

Diversion and River Outlet of Lebir Dam

GOVERNMENT OF MALAYSIA
STUDY
ON
KELANTAN RIVER BASIN - WIDE FLOOD MITIGATION
JAPAN INTERNATIONAL COOPERATION AGENCY



SPILLWAY PROFILE

Fig. 4.27

Profile and Cross Section of Spillway of Lebir Dam

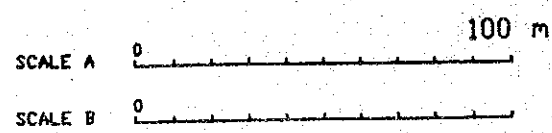

GOVERNMENT OF MALAYSIA
 STUDY
 ON
 KELANTAN RIVER BASIN - WIDE FLOOD MITIGATION
 JAPAN INTERNATIONAL COOPERATION AGENCY

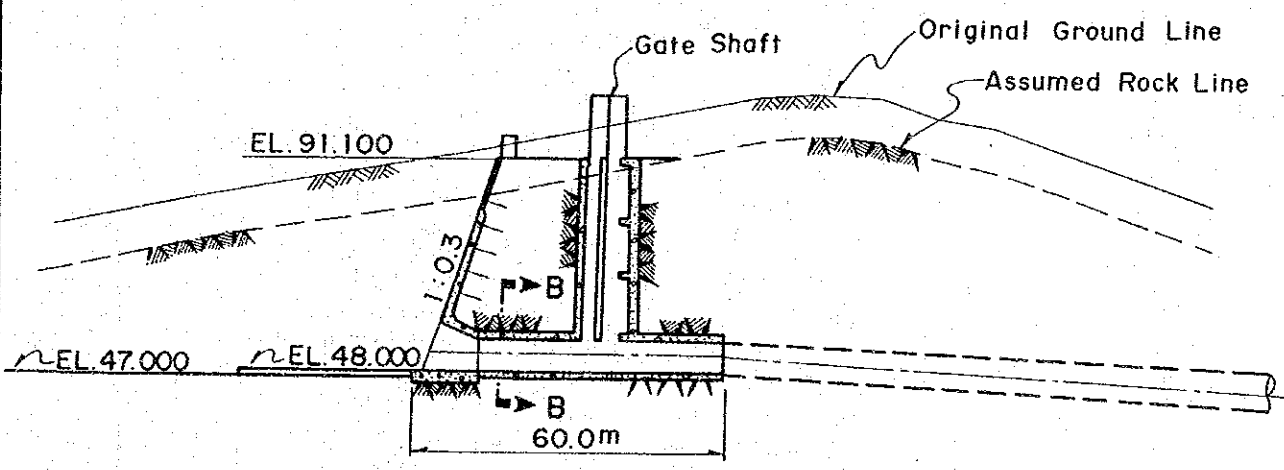
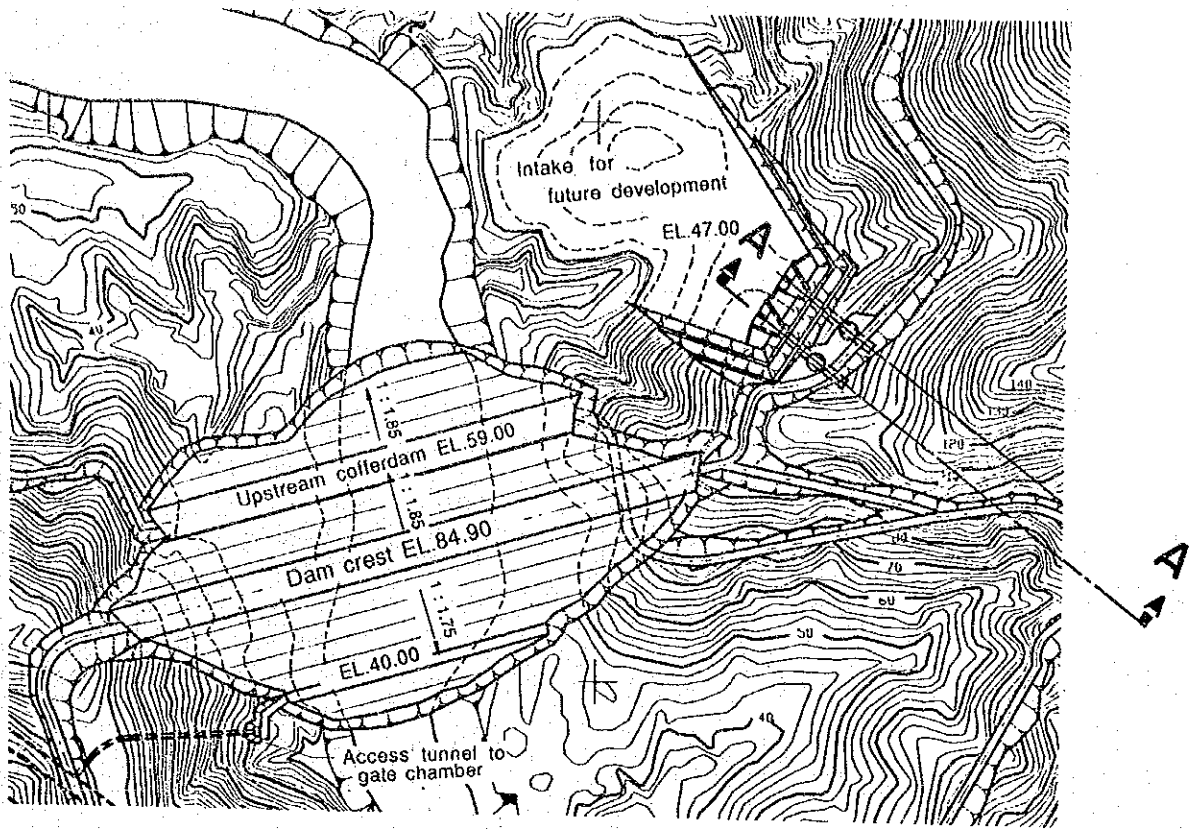

Longitudinal Section of Power Intake (Section A - A)

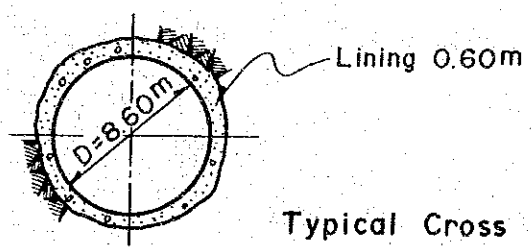

Typical Cross Section of Power Intake Tunnel (Section B - B)

Fig. 4.28

Power Intake Construction Scheme to be Proposed at First Stage

GOVERNMENT OF MALAYSIA
 STUDY
 ON
 KELANTAN RIVER BASIN - WIDE FLOOD MITIGATION
 JAPAN INTERNATIONAL COOPERATION AGENCY

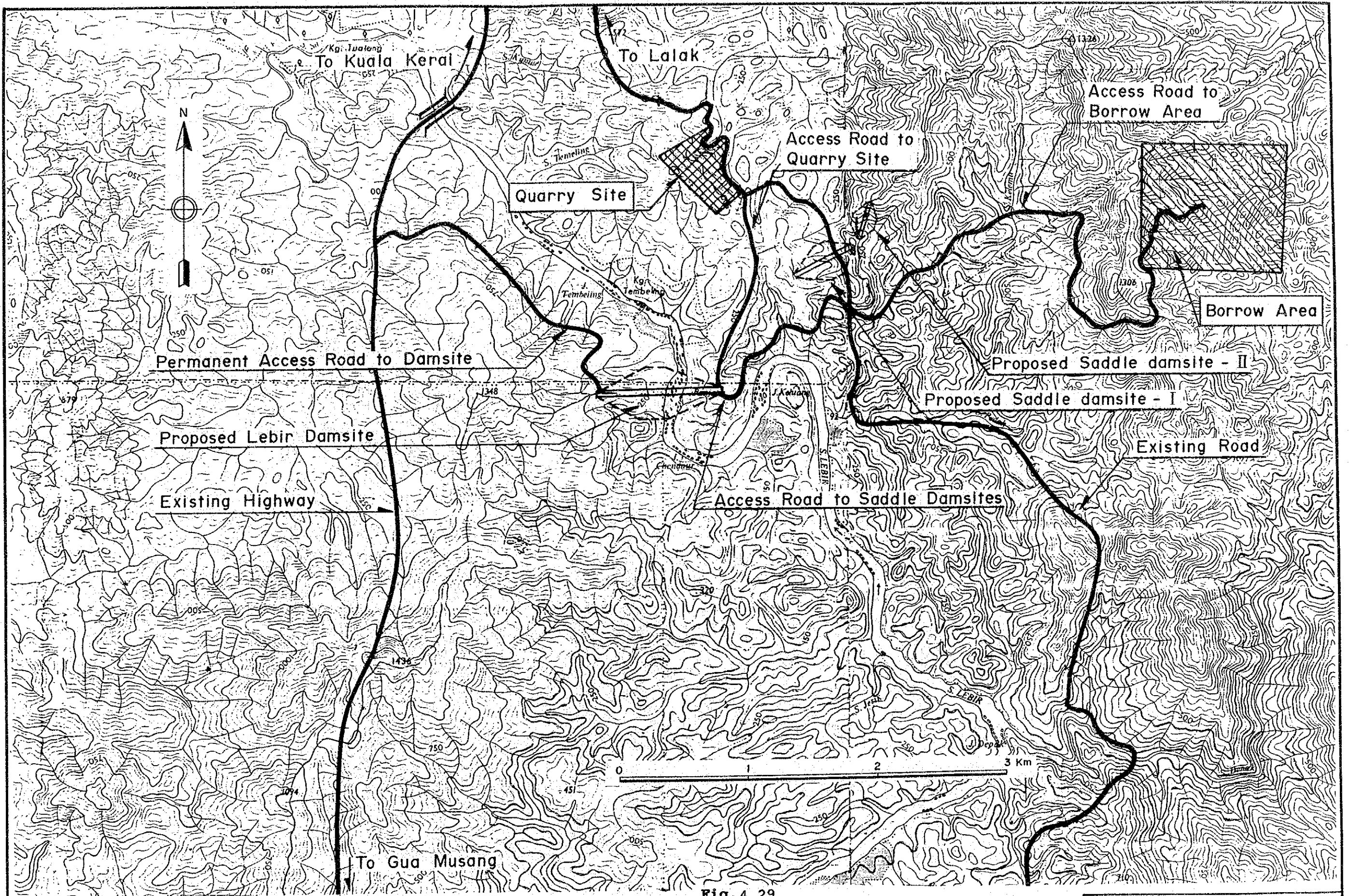

Fig. 4.29

Access Roads to Damsites, Quarry Site and Borrow Area

GOVERNMENT OF MALAYSIA
 STUDY
 ON
 KELANTAN RIVER BASIN - WIDE FLOOD MITIGATION
 JAPAN INTERNATIONAL COOPERATION AGENCY

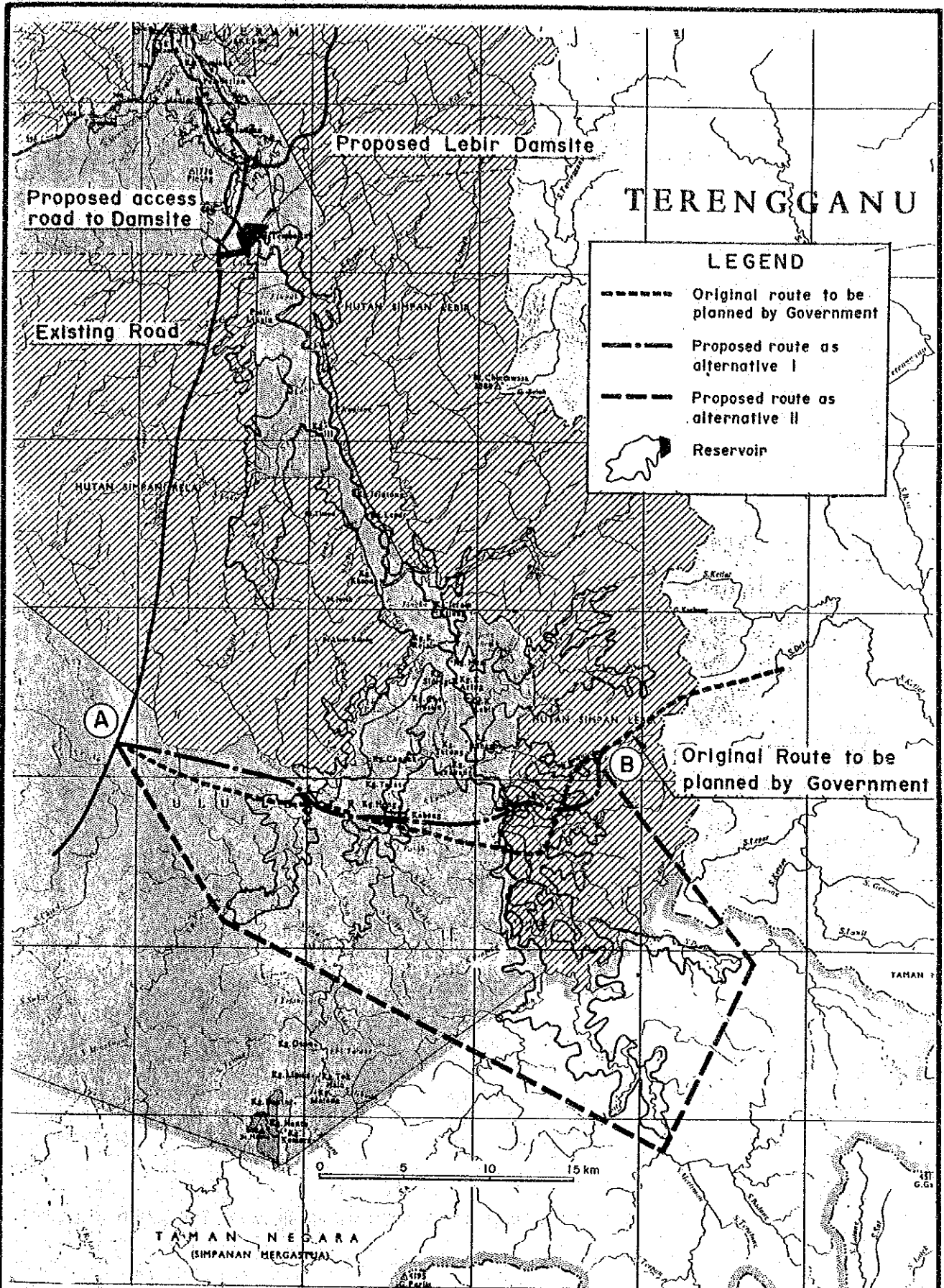
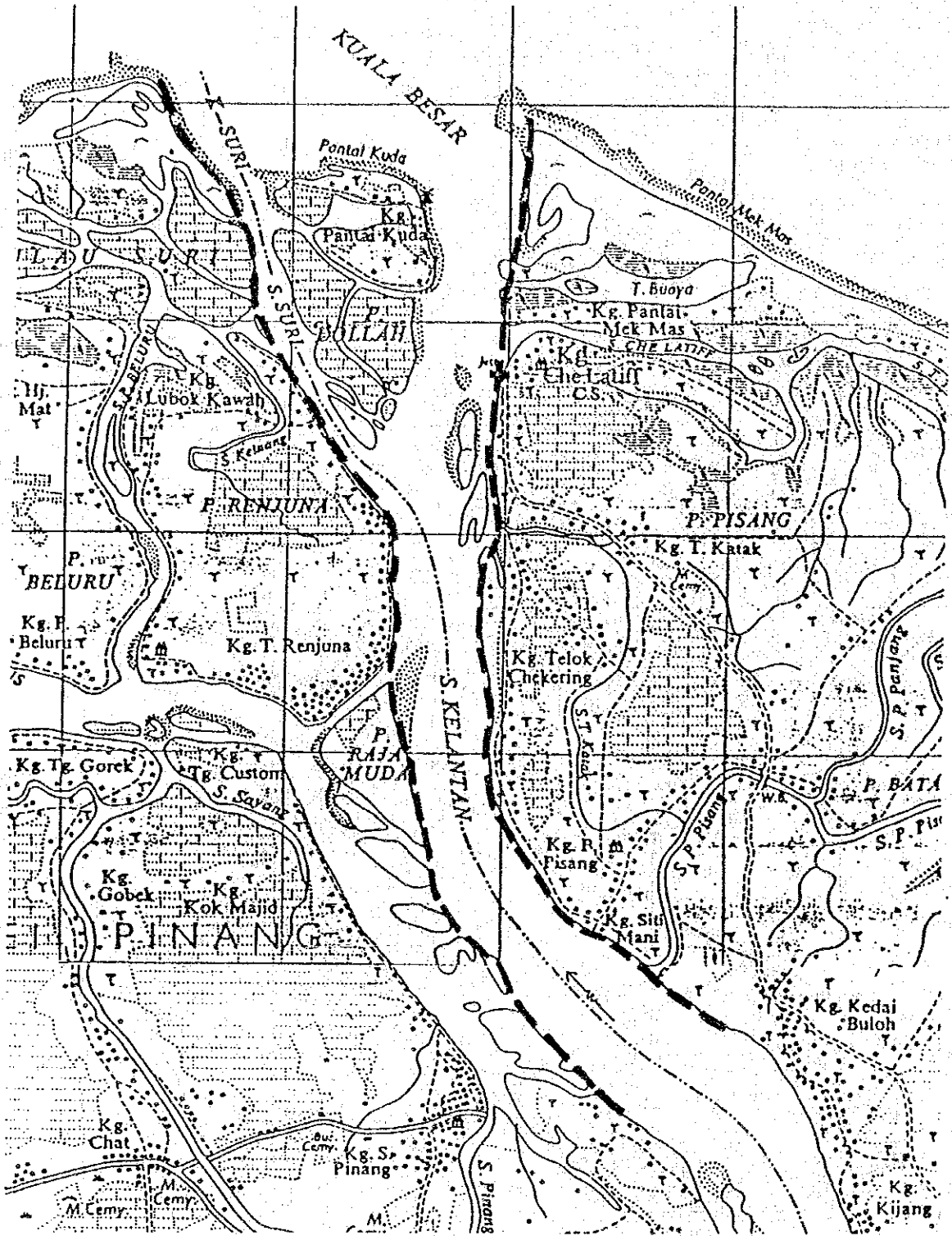

Fig. 4.30

**Alternative Plan of Highway Route
around Lebir Reservoir**

GOVERNMENT OF MALAYSIA
STUDY
ON
KELANTAN RIVER BASIN - WIDE FLOOD MITIGATION
JAPAN INTERNATIONAL COOPERATION AGENCY



--- BOUNDARY OF PREDOMINANT FLOW AT THE FLOOD TIME

Fig. 5.1

Predominant Flow Condition
for the Flood Time

GOVERNMENT OF MALAYSIA
STUDY
ON
KELANTAN RIVER BASIN - WIDE FLOOD MITIGATION
JAPAN INTERNATIONAL COOPERATION AGENCY

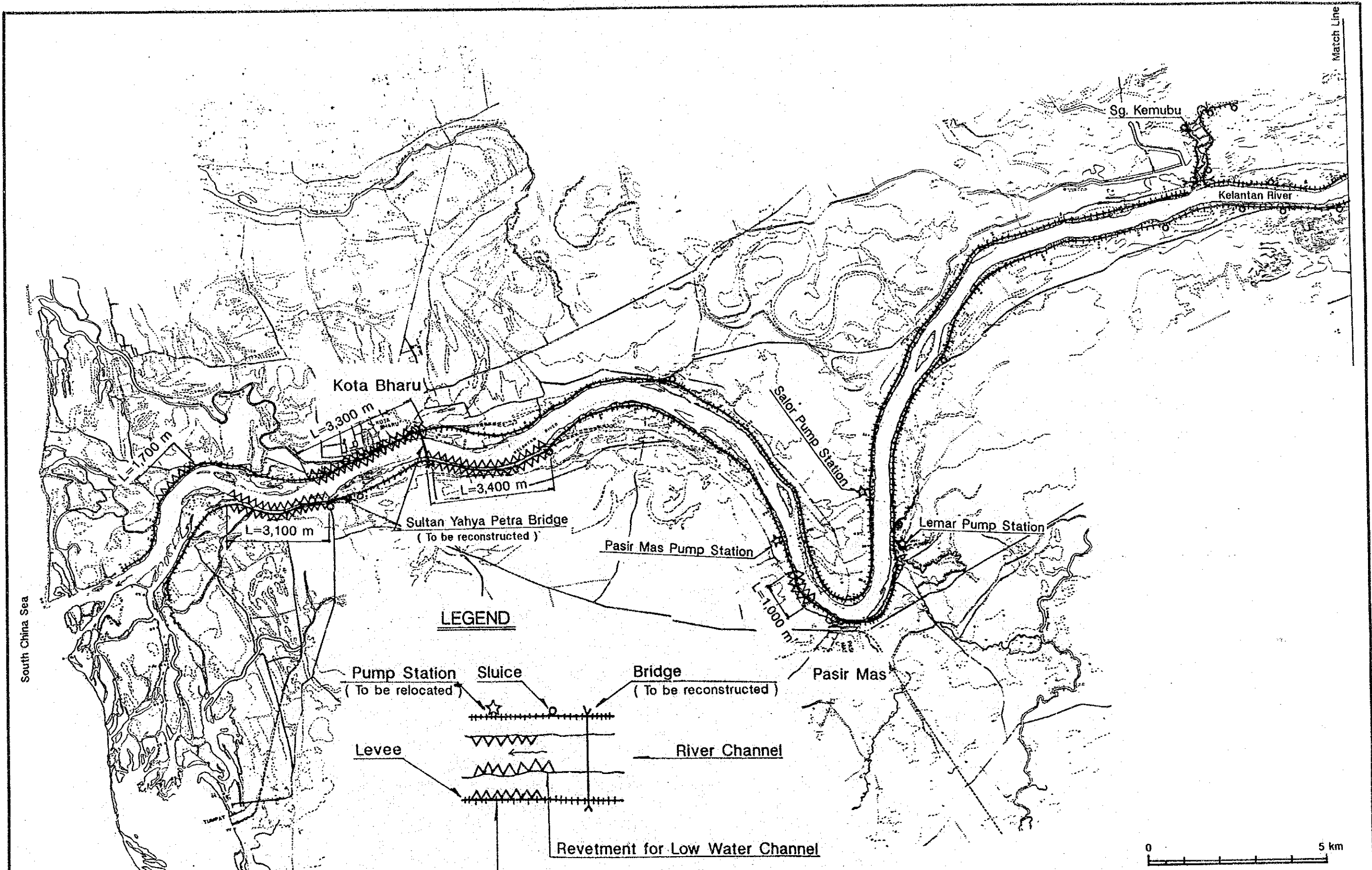

Fig.5.2
Plan of Proposed River Improvement (1/2)

GOVERNMENT OF MALAYSIA
STUDY
ON
KELANTAN RIVER BASIN - WIDE FLOOD MITIGATION
JAPAN INTERNATIONAL COOPERATION AGENCY

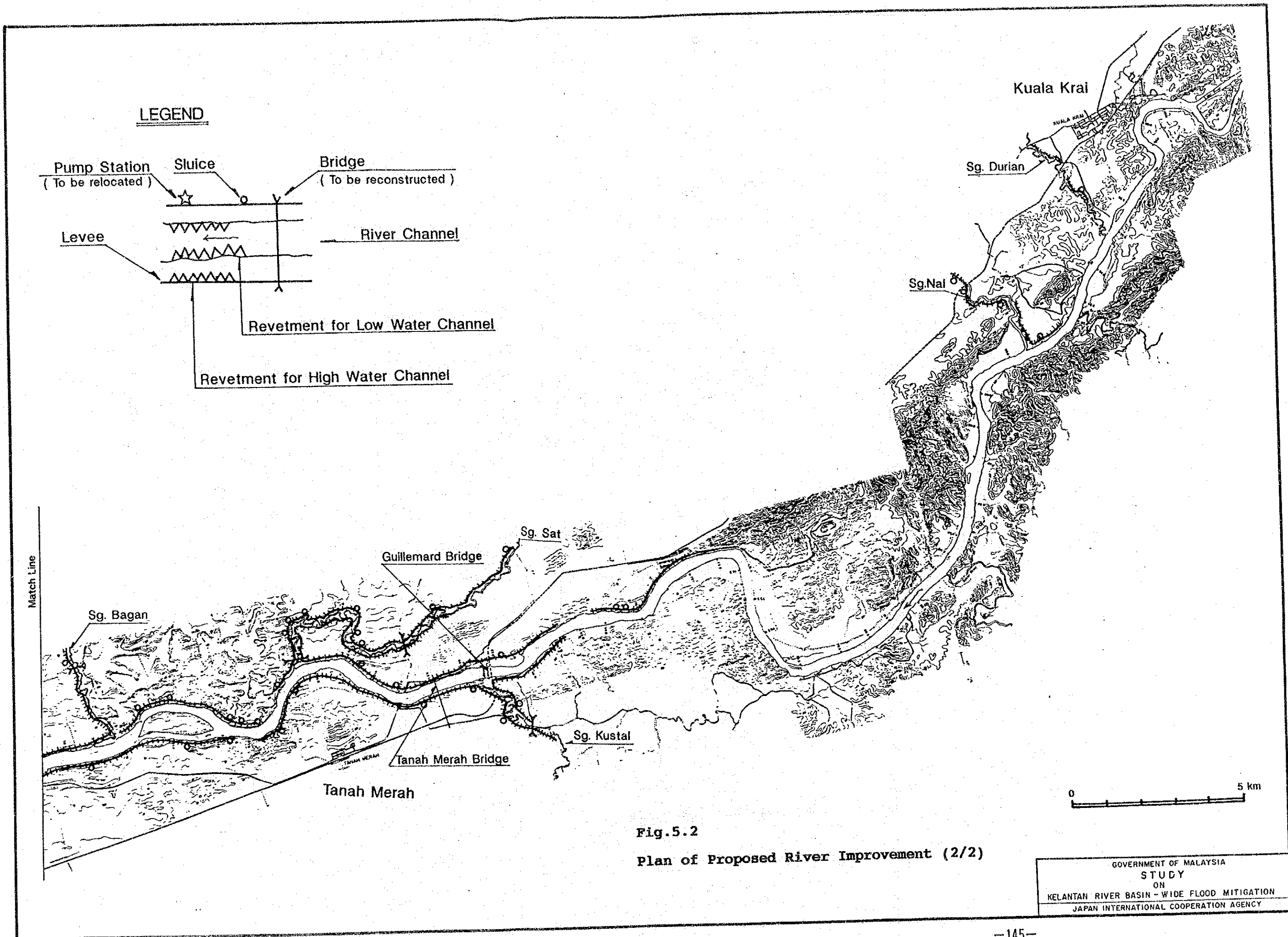

Fig.5.2
Plan of Proposed River Improvement (2/2)

GOVERNMENT OF MALAYSIA
 STUDY
 ON
 KELANTAN RIVER BASIN - WIDE FLOOD MITIGATION
 JAPAN INTERNATIONAL COOPERATION AGENCY

Legend

- Right Bank
- Left Bank
- Lowest River Bed
- Average River Bed
- (R) Right Bank Side
- (L) Left Bank Side

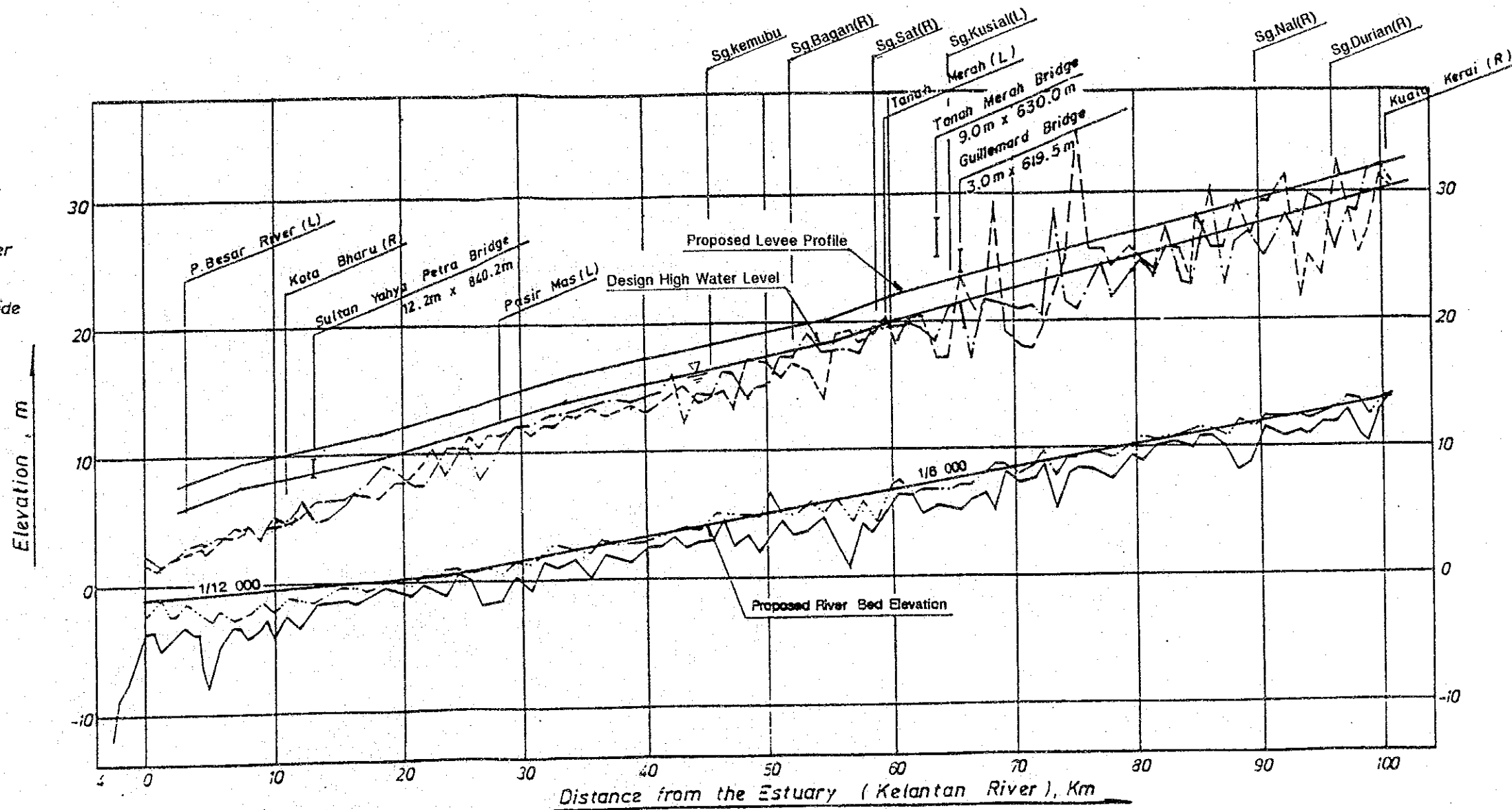

Fig.5.3

Longitudinal Profile of Proposed River Channel

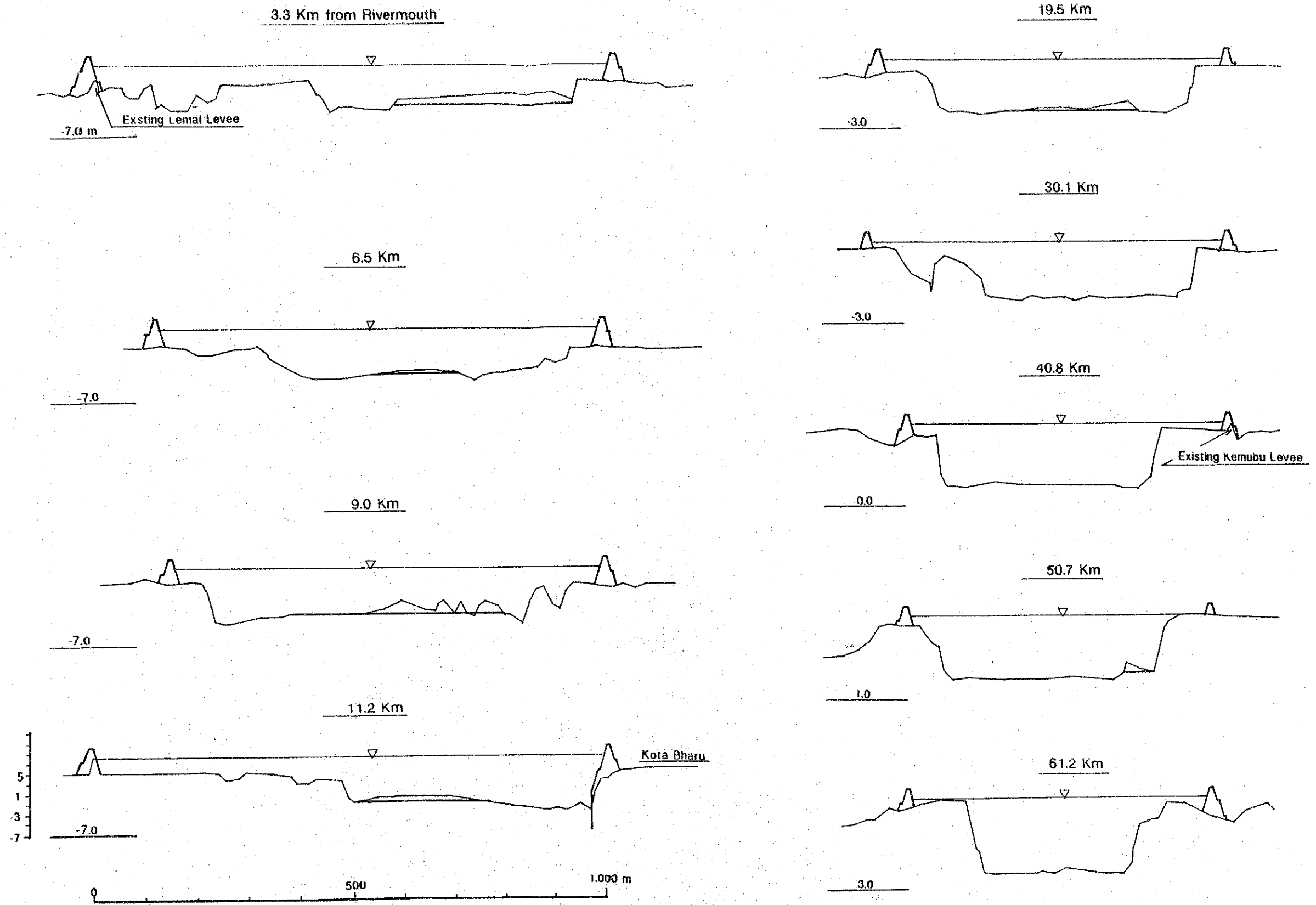

Fig.5.4
 Typical Cross Section of Proposed River Channel

GOVERNMENT OF MALAYSIA
 STUDY
 ON
 KELANTAN RIVER BASIN - WIDE FLOOD MITIGATION
 JAPAN INTERNATIONAL COOPERATION AGENCY

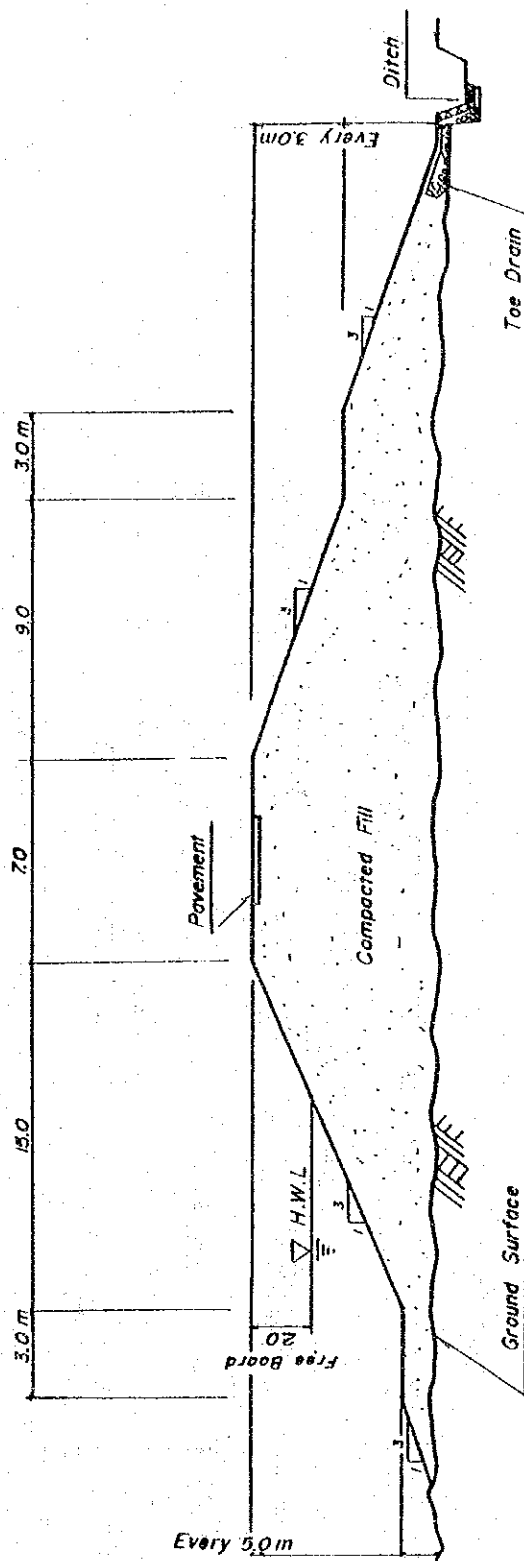

Fig.5.5
Typical Cross Section of Earth Levee

GOVERNMENT OF MALAYSIA
 STUDY
 ON
 KELANTAN RIVER BASIN - WIDE FLOOD MITIGATION
 JAPAN INTERNATIONAL COOPERATION AGENCY

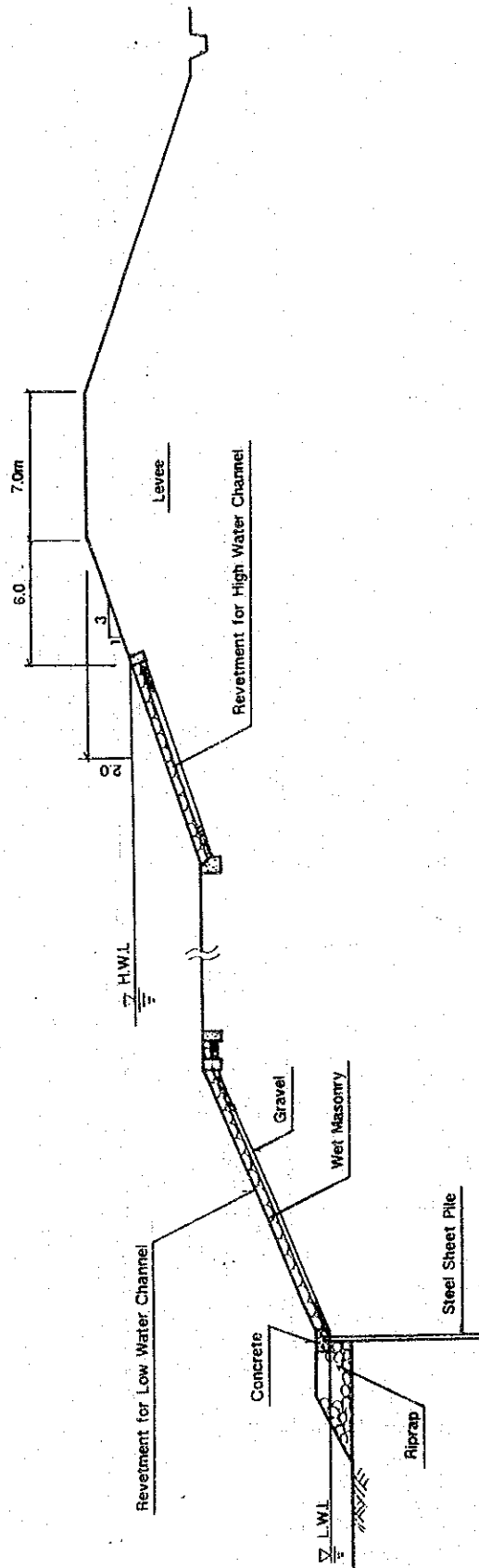

Fig.5.6
Typical Cross Section of Revetment

GOVERNMENT OF MALAYSIA
 STUDY
 ON
 KELANTAN RIVER BASIN - WIDE FLOOD MITIGATION
 JAPAN INTERNATIONAL COOPERATION AGENCY

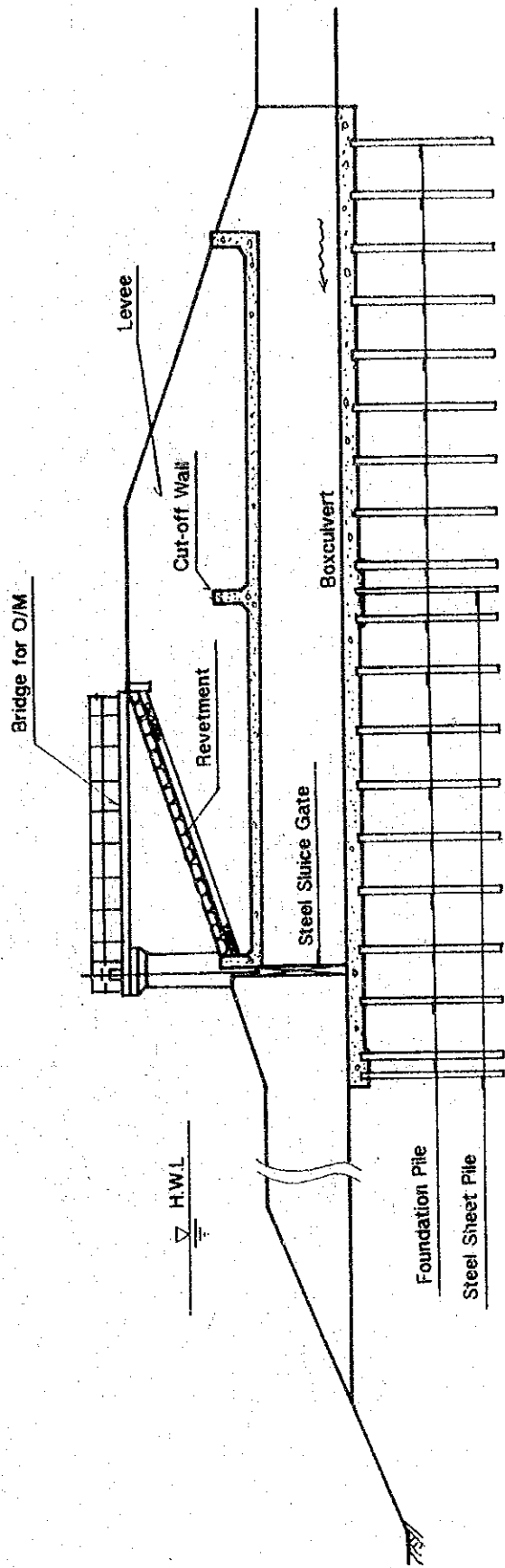

Fig.5.7
Typical Cross Section of Box Culvert

GOVERNMENT OF MALAYSIA
 STUDY
 ON
 KELANTAN RIVER BASIN - WIDE FLOOD MITIGATION
 JAPAN INTERNATIONAL COOPERATION AGENCY

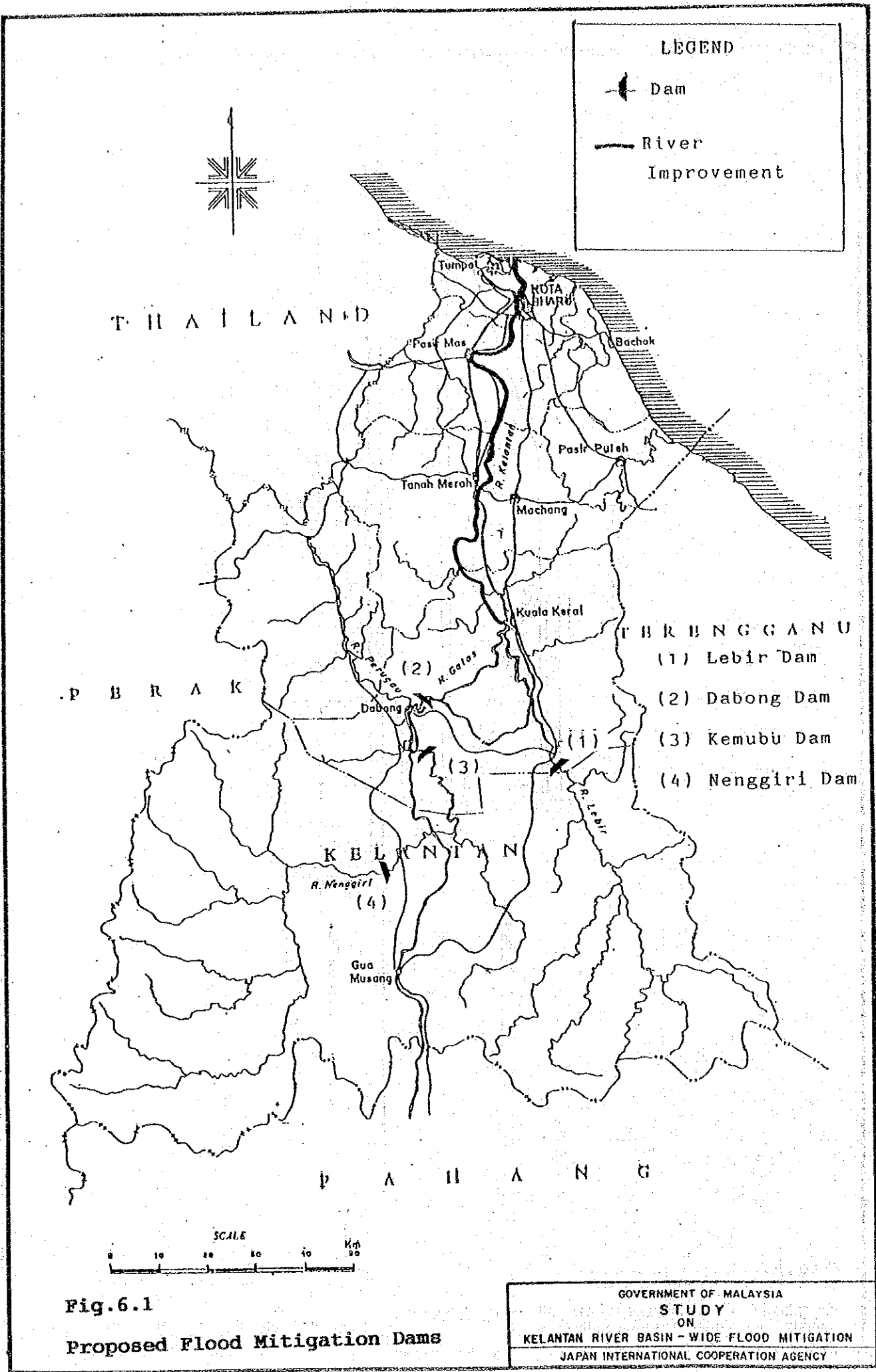
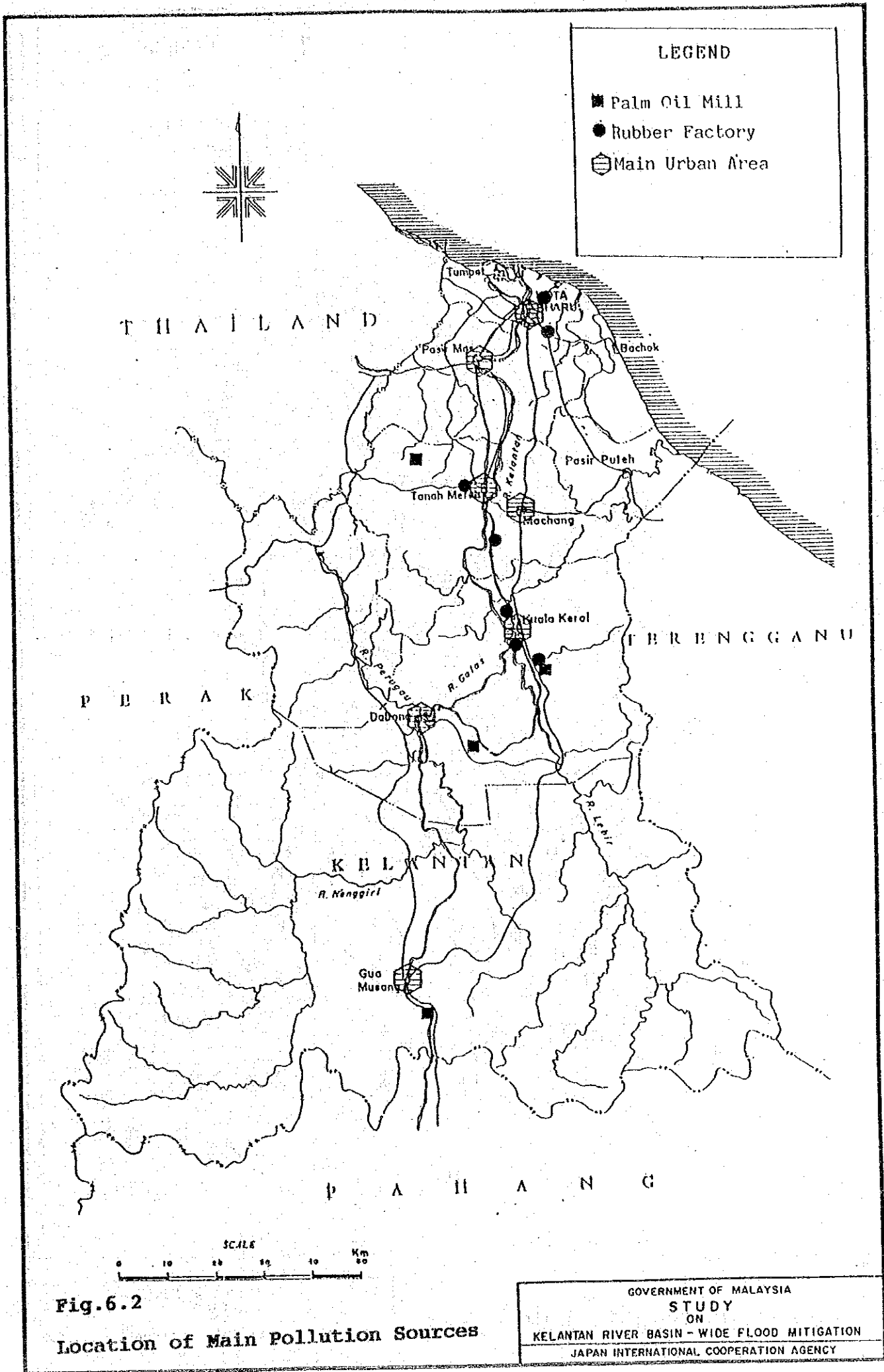

Fig.6.1
Proposed Flood Mitigation Dams



LEGEND

- Palm Oil Mill
- Rubber Factory
- ▨ Main Urban Area

T H A I L A N D

P E R A K

K E L A N T A N

P A H A N G

Fig.6.2
Location of Main Pollution Sources

GOVERNMENT OF MALAYSIA
 STUDY
 ON
 KELANTAN RIVER BASIN - WIDE FLOOD MITIGATION
 JAPAN INTERNATIONAL COOPERATION AGENCY

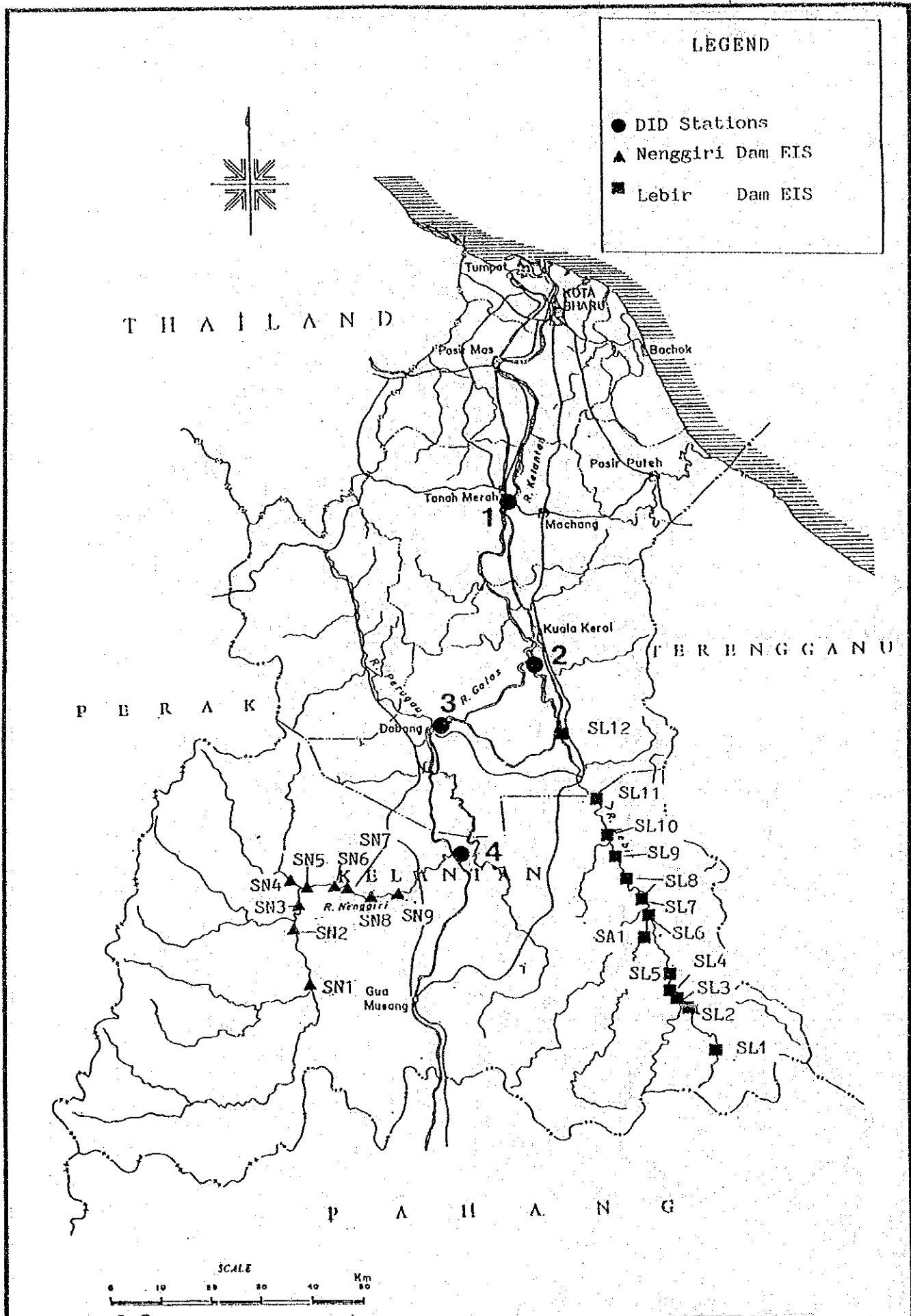

LEGEND

- DID Stations
- ▲ Nenggiri Dam EIS
- Lebir Dam EIS

Fig.6.3
Location of Water Quality Monitoring Stations

GOVERNMENT OF MALAYSIA
STUDY
 ON
 KELANTAN RIVER BASIN - WIDE FLOOD MITIGATION
 JAPAN INTERNATIONAL COOPERATION AGENCY

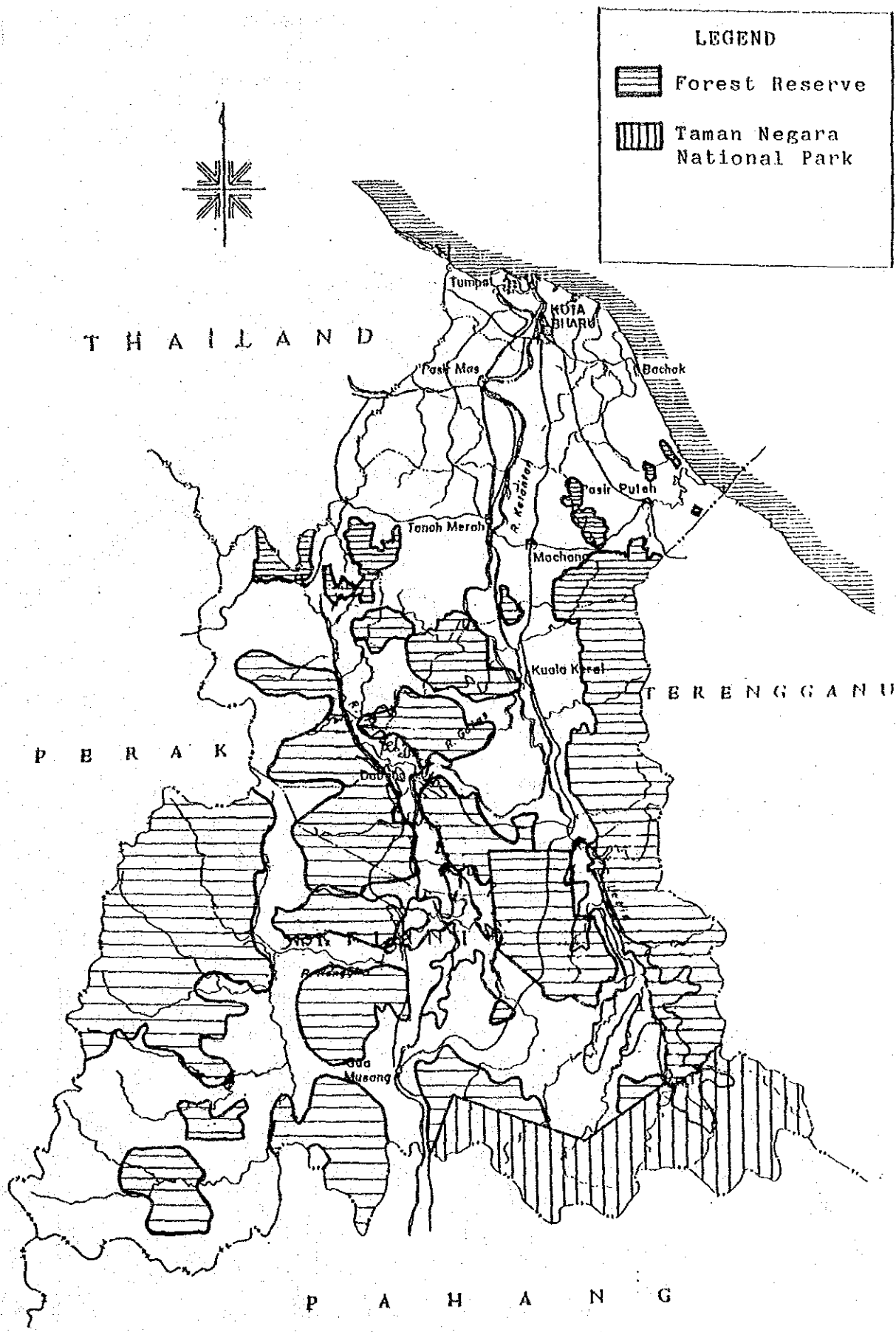

LEGEND

 Forest Reserve

 Taman Negara National Park

Fig.6.4
Forest Reserve Area Map

GOVERNMENT OF MALAYSIA
 STUDY
 ON
 KELANTAN RIVER BASIN - WIDE FLOOD MITIGATION
 JAPAN INTERNATIONAL COOPERATION AGENCY

