

LEGEND :

- | | |
|--------------------------------|----------------------------------|
| ○ CENTRAL AREA | ▨ FLOODWAY |
| ○ DISTRICT CENTRE | ▩ IRRIGATION SCHEME AREA |
| ○ COMMUNITY CENTRE | ✈ AIRPORT |
| ▨ RESIDENTIAL AREA | ▨ SPECIAL USE AREA |
| ▨ INDUSTRIAL AREA | ▨ RESIDENTIAL/INSTITUTIONAL AREA |
| ▨ FUTURE URBAN AREA | — ROAD (--- PROPOSED) |
| ▨ INDUSTRIAL ESTATE | --- BOUNDARY OF MPKB |
| ▨ WORKER ACCOMODATION | (KOTA BHARU MUNICIPAL COUNCIL) |
| □ OPEN SPACE/AGRICULTURAL AREA | |

図 2.5 コタバル市政区の開発計画

GOVERNMENT OF MALAYSIA
 STUDY
 ON
 KELANTAN RIVER BASIN - WIDE FLOOD MITIGATION
 JAPAN INTERNATIONAL COOPERATION AGENCY



図 2.6 クランタン川の特徴

GOVERNMENT OF MALAYSIA
 STUDY
 ON
 KELANTAN RIVER BASIN - WIDE FLOOD MITIGATION
 JAPAN INTERNATIONAL COOPERATION AGENCY

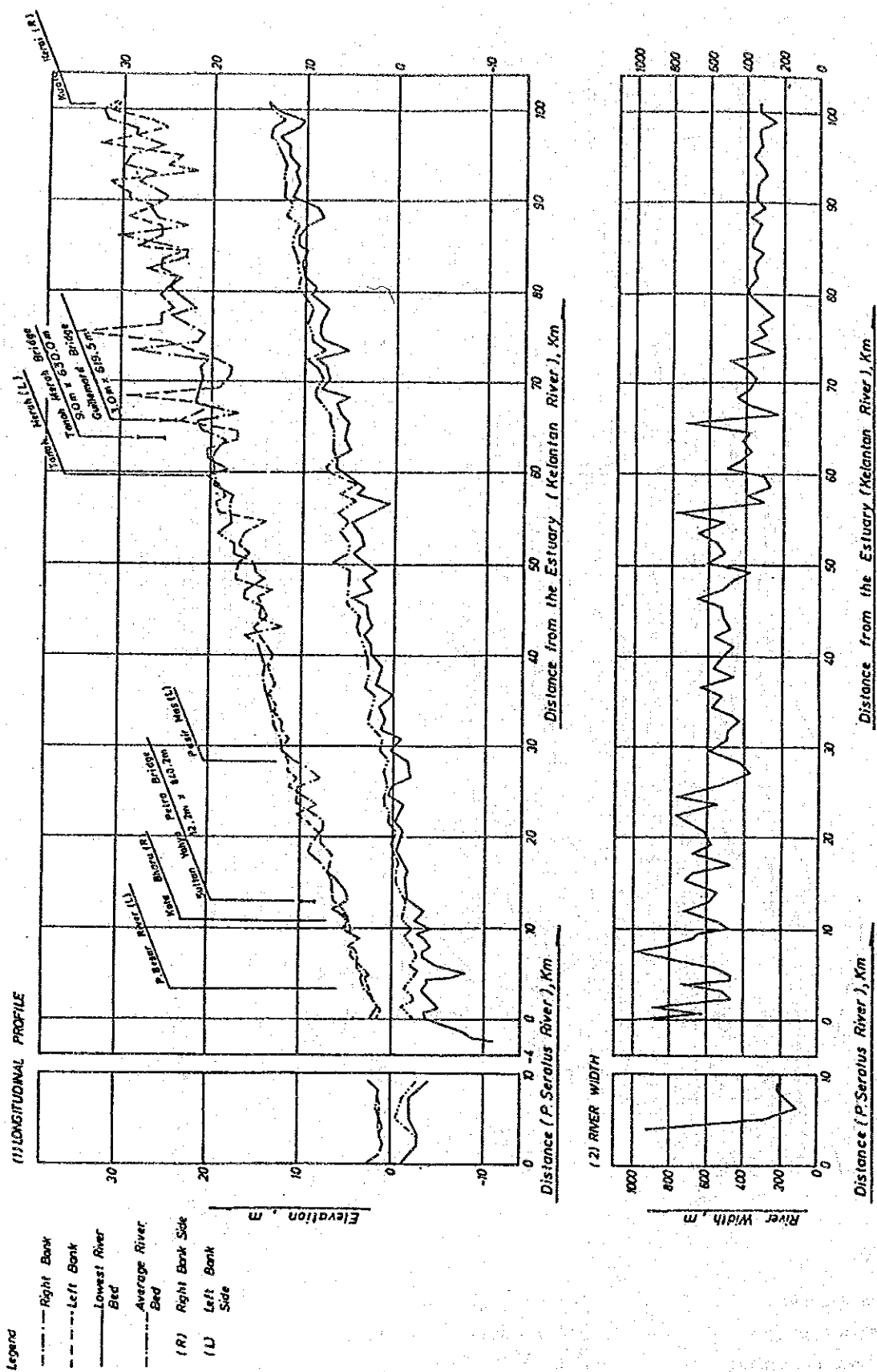

図 2.7 クランタン川の通水容量

GOVERNMENT OF MALAYSIA
 STUDY
 ON
 KELANTAN RIVER BASIN - WIDE FLOOD MITIGATION
 JAPAN INTERNATIONAL COOPERATION AGENCY

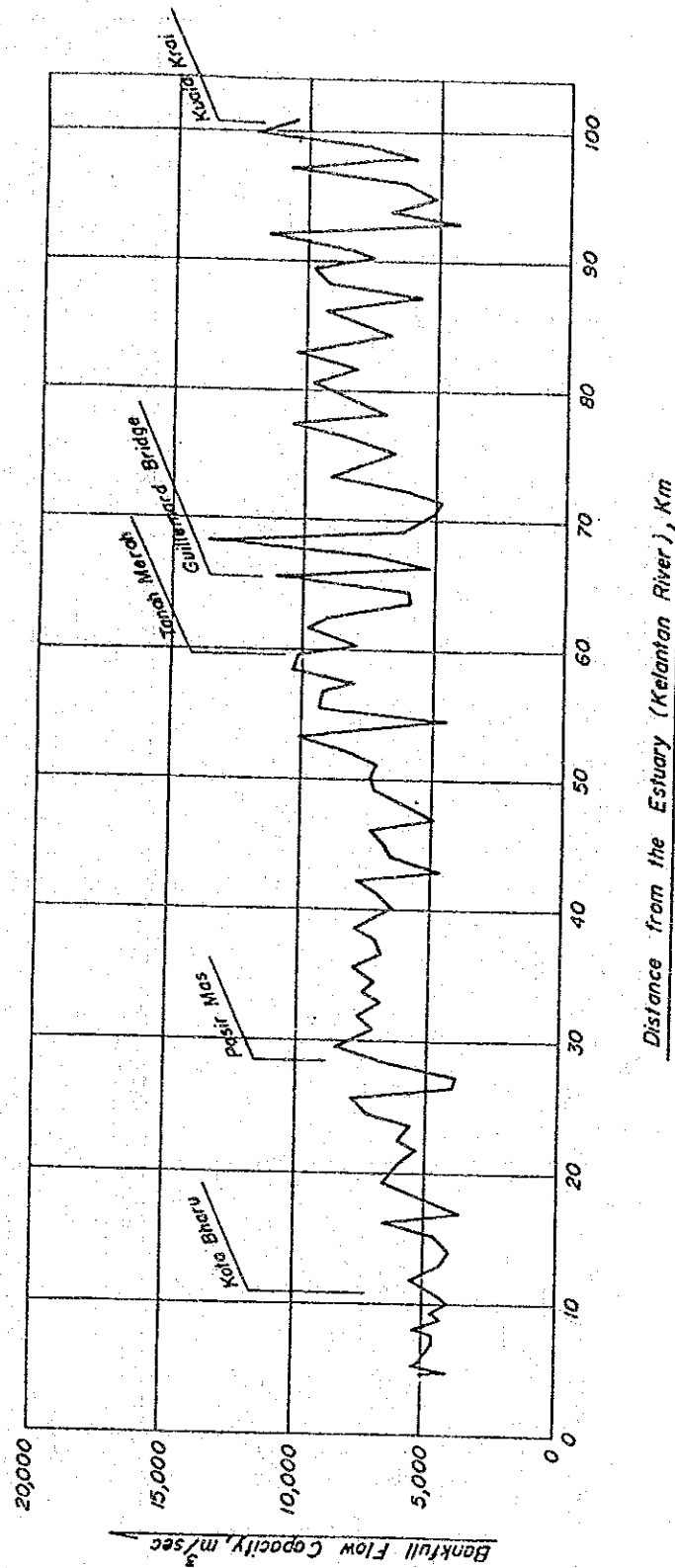

図 2. 8 1986年11月降雨の等高線図

GOVERNMENT OF MALAYSIA
STUDY
 ON
KELANTAN RIVER BASIN - WIDE FLOOD MITIGATION
 JAPAN INTERNATIONAL COOPERATION AGENCY

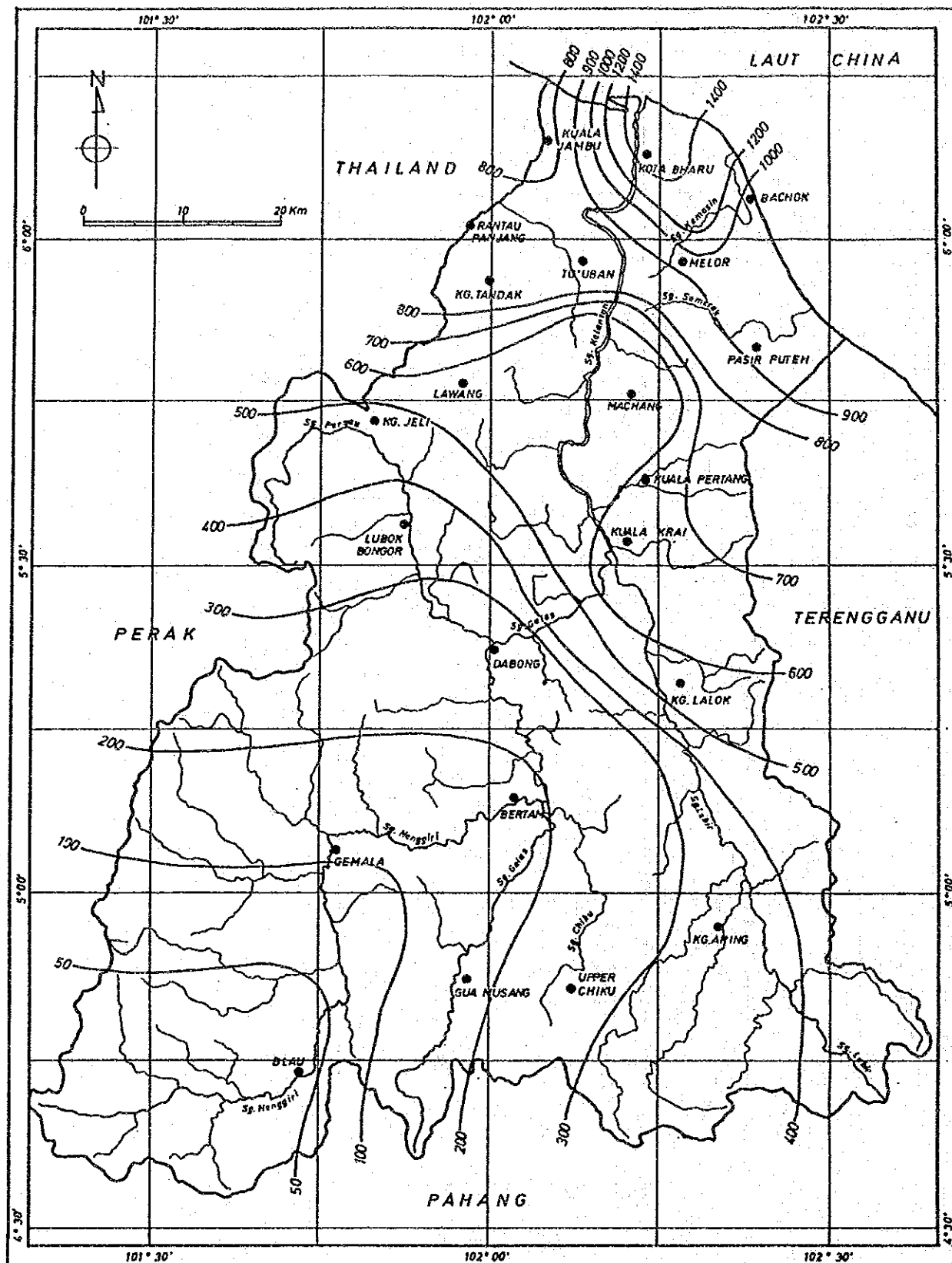

図 2.10 クランタン川の既存治水施設

GOVERNMENT OF MALAYSIA
STUDY
 ON
 KELANTAN RIVER BASIN - WIDE FLOOD MITIGATION
 JAPAN INTERNATIONAL COOPERATION AGENCY

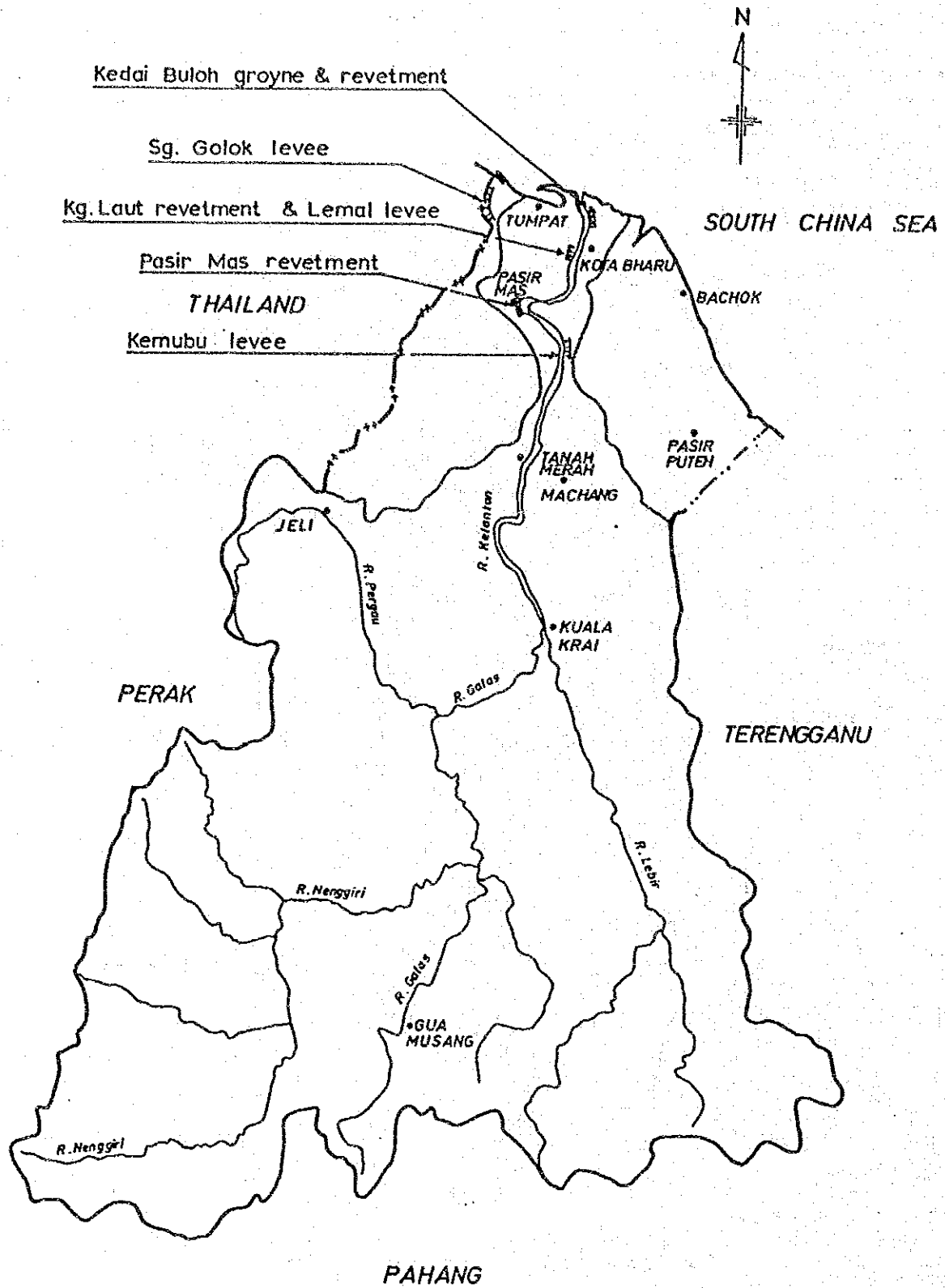

図 2.11 クラントン川の既存河川構造物

GOVERNMENT OF MALAYSIA
 STUDY
 ON
 KELANTAN RIVER BASIN - WIDE FLOOD MITIGATION
 JAPAN INTERNATIONAL COOPERATION AGENCY

Rainfall / water level data from the telemetric stations (6 for rainfall and 7 for water level)

Telemetric system via a relay station at Bukit Bakar.

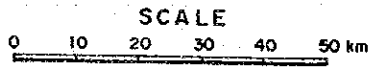
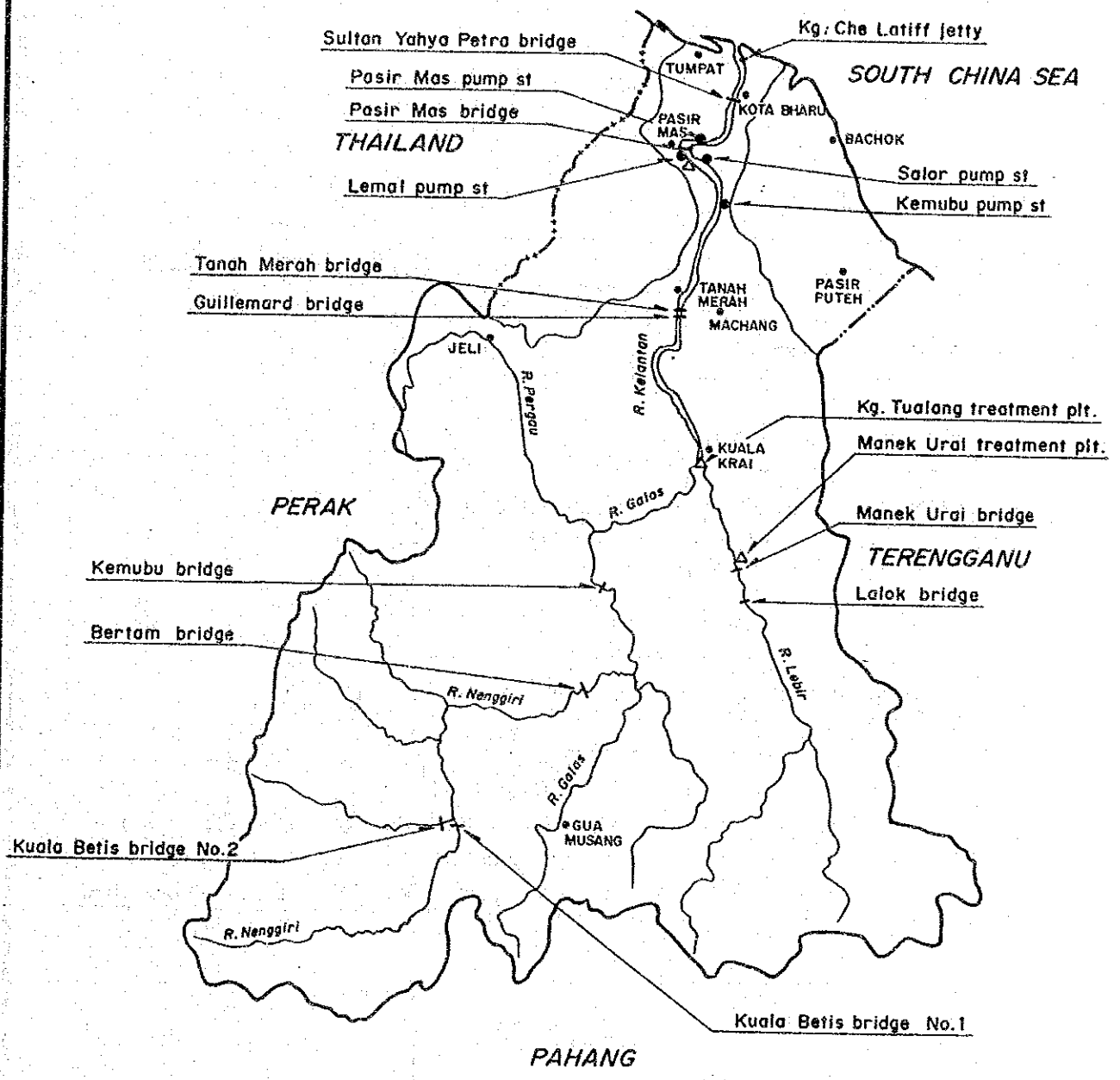
D.I.D Flood operation room in Kota Bharu (key station of telemetric system)

Water level forecast (Tank Model and correlation diagram of water levels)

Issue of flood warning by State Flood warning committes

LEVEL OF WARNING

- 1. Alert (WL 65 feet at Kuala Krai)
- 2. Warning (WL 75 feet at Kuala Krai)
- 3. Emergency (WL 85 feet at Kuala Krai)

Public warning to people affected with such media as TV, radio, loud-speaker and so on

図 2.12

クランタン川流域の洪水予警報システム

GOVERNMENT OF MALAYSIA
STUDY
ON
KELANTAN RIVER BASIN - WIDE FLOOD MITIGATION
JAPAN INTERNATIONAL COOPERATION AGENCY

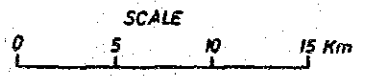
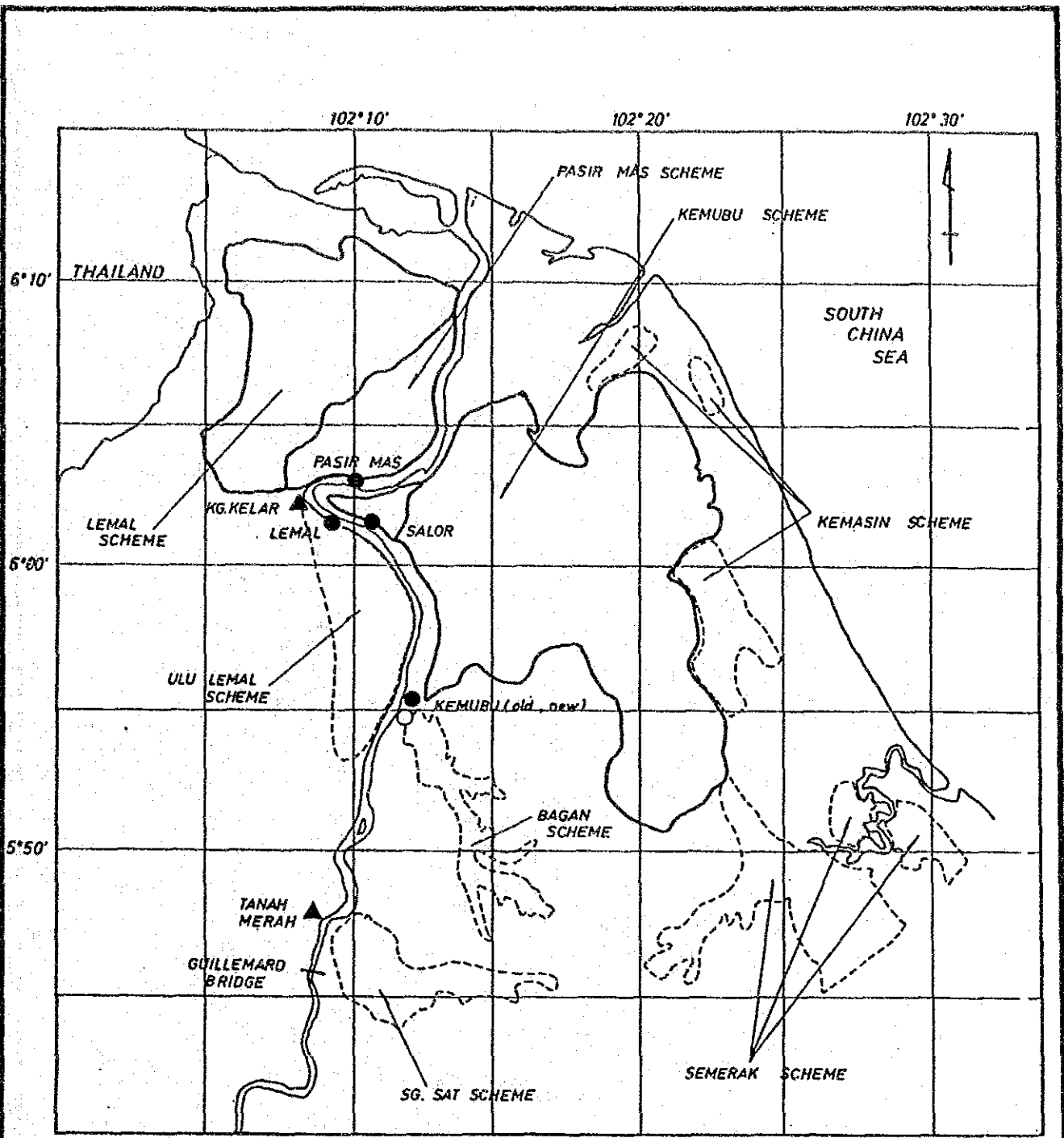

LEGEND

- Existing Pumping Station For Irrigation
- Project Pumping Station For Irrigation
- ▲ Existing Pumping Station For Domestic And Industrial Water
- Boundary Of Existing Irrigation Area
- - - Boundary Of Projected Irrigation Area

図 3. 1
かんがい地区及びポンプ場の位置図

GOVERNMENT OF MALAYSIA
STUDY
ON
KELANTAN RIVER BASIN - WIDE FLOOD MITIGATION
JAPAN INTERNATIONAL COOPERATION AGENCY



图 3. 2 全国送電網図

GOVERNMENT OF MALAYSIA
 STUDY
 ON
 KELANTAN RIVER BASIN - WIDE FLOOD MITIGATION
 JAPAN INTERNATIONAL COOPERATION AGENCY

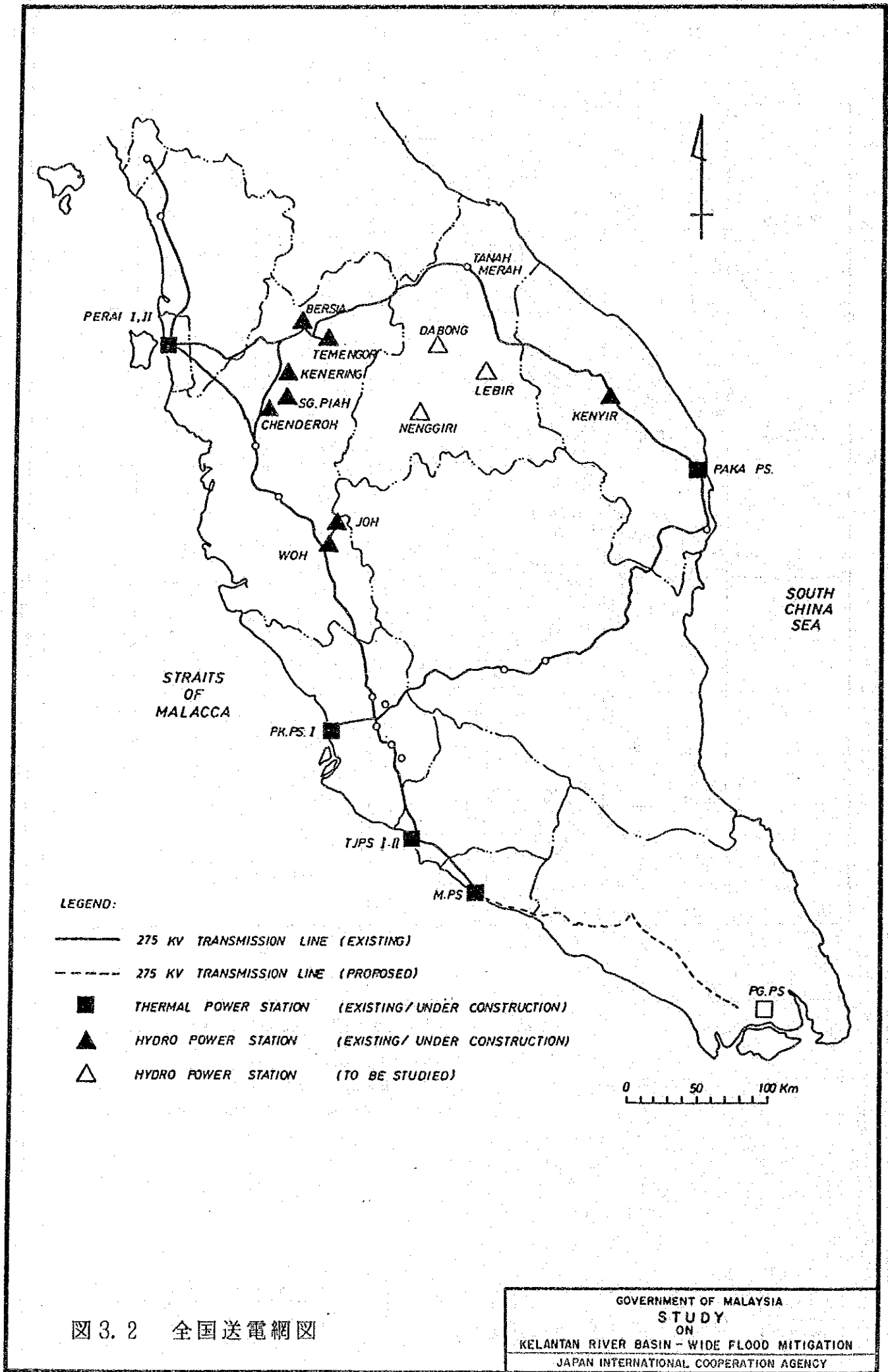
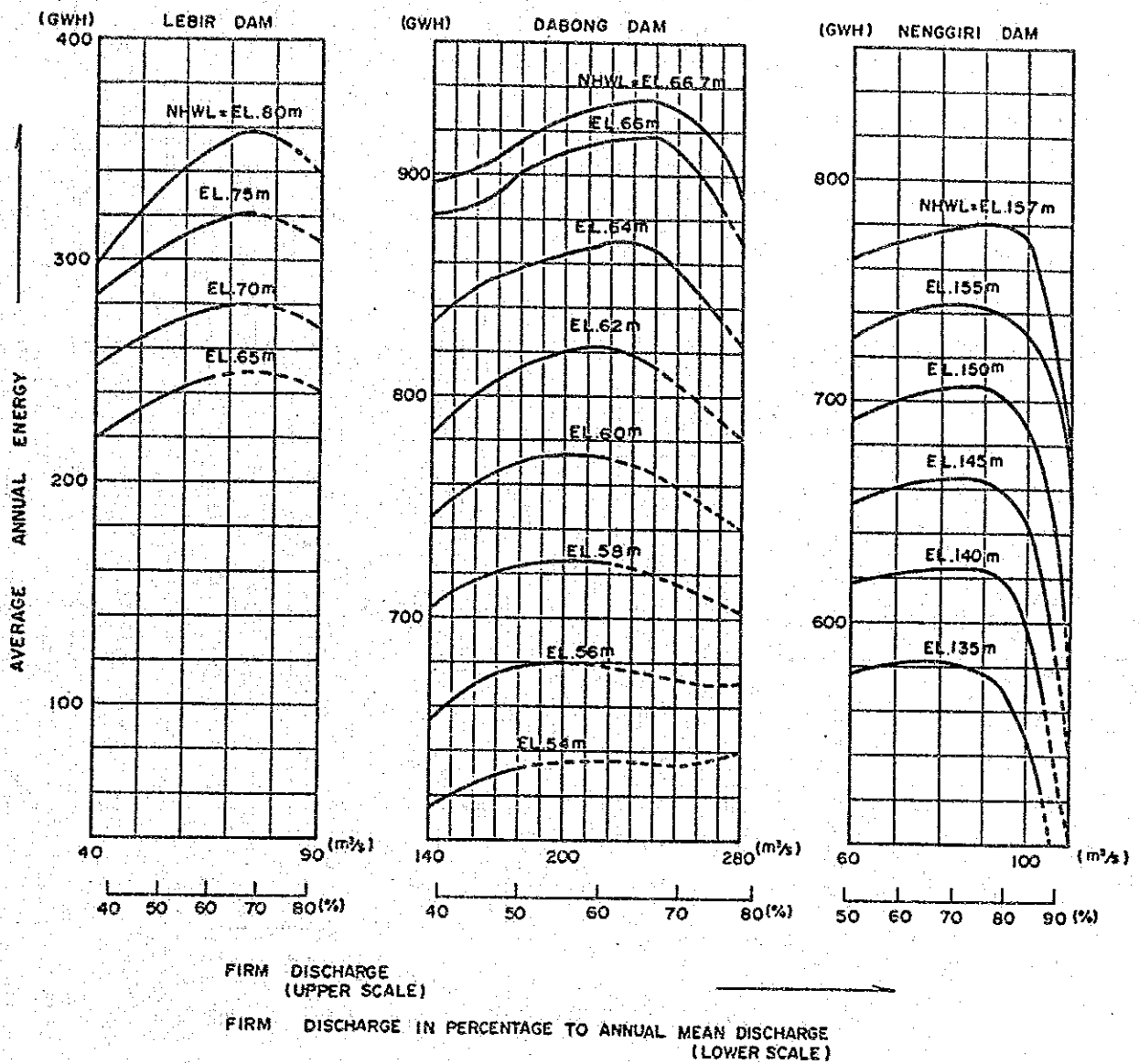

Note
 ----- : Firm Discharge is not insured

図 3.3 常時満水位に対する発生電力量

GOVERNMENT OF MALAYSIA
 STUDY
 ON
 KELANTAN RIVER BASIN - WIDE FLOOD MITIGATION
 JAPAN INTERNATIONAL COOPERATION AGENCY



図 3.4 レビルダムの位置図



図 3.5 レビルダムの湛水面積

GOVERNMENT OF MALAYSIA
 STUDY
 ON
 KELANTAN RIVER BASIN - WIDE FLOOD MITIGATION
 JAPAN INTERNATIONAL COOPERATION AGENCY

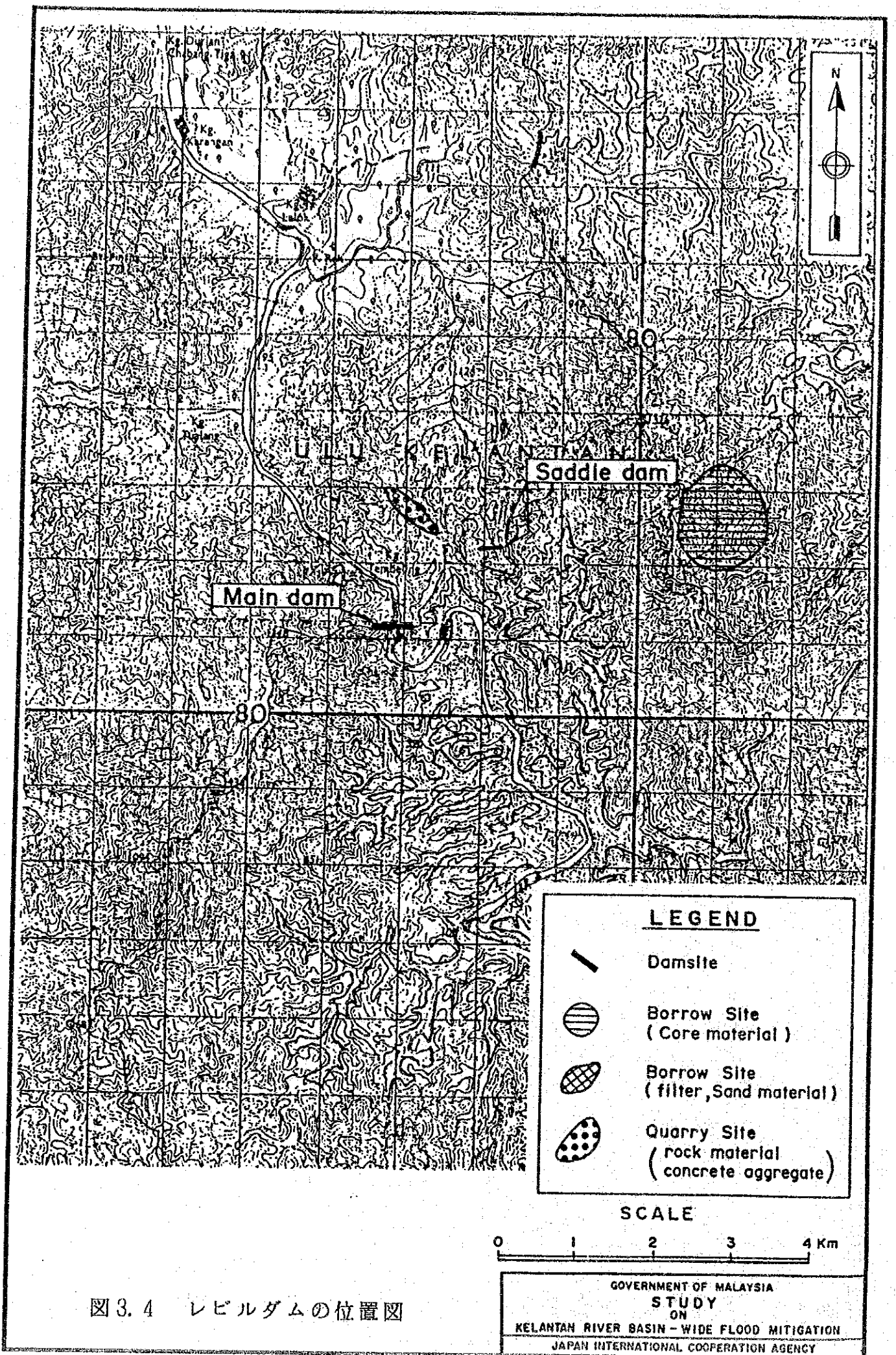

図 3. 6

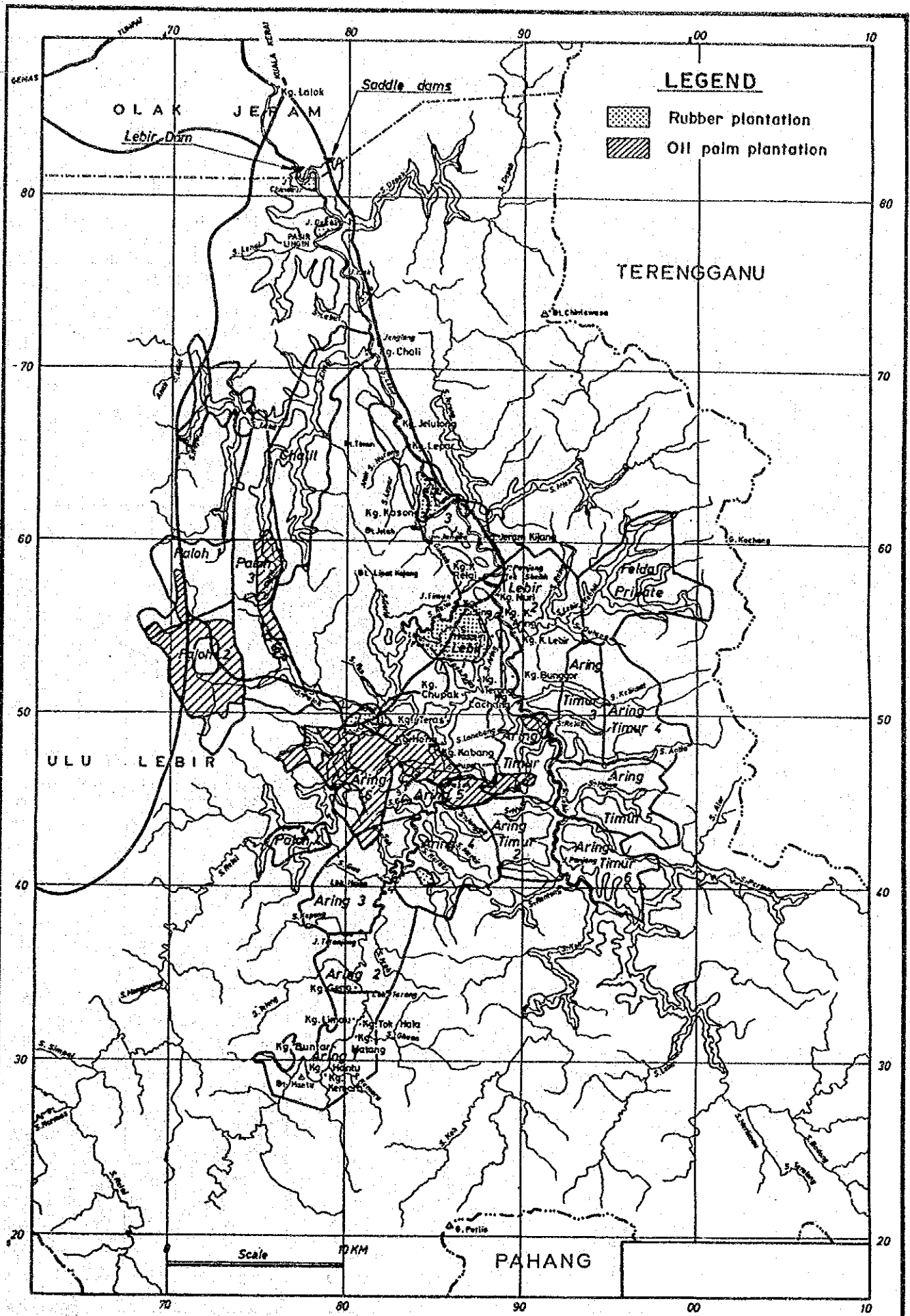
チクークアラブラン道路計画の再計画案

GOVERNMENT OF MALAYSIA
STUDY
 ON
 KELANTAN RIVER BASIN - WIDE FLOOD MITIGATION
 JAPAN INTERNATIONAL COOPERATION AGENCY

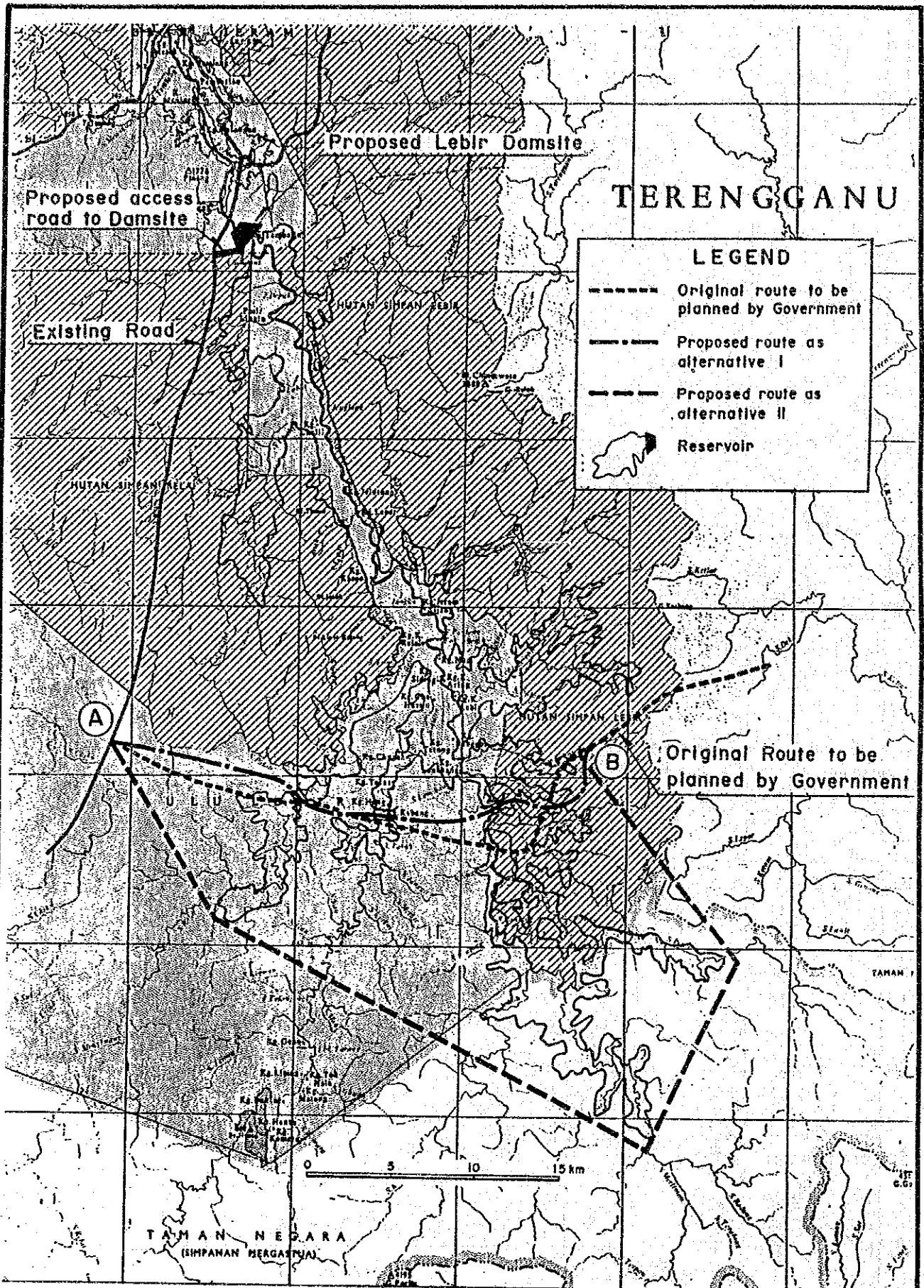

図 3.7 レビルダムの貯水池容量曲線

GOVERNMENT OF MALAYSIA
STUDY
ON
KELANTAN RIVER BASIN - WIDE FLOOD MITIGATION
JAPAN INTERNATIONAL COOPERATION AGENCY



PLAN OF MAIN DAM (SCALE A)

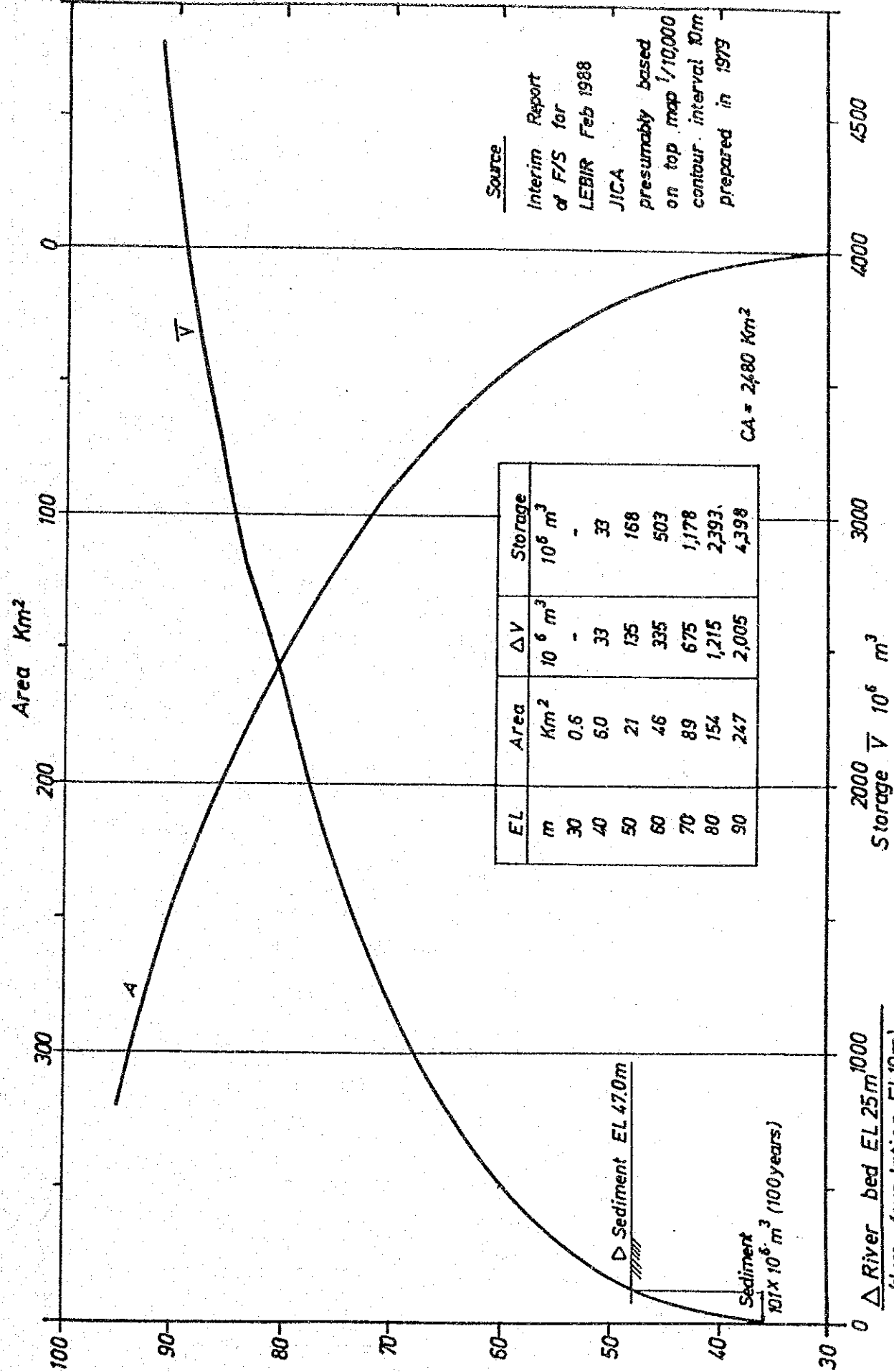
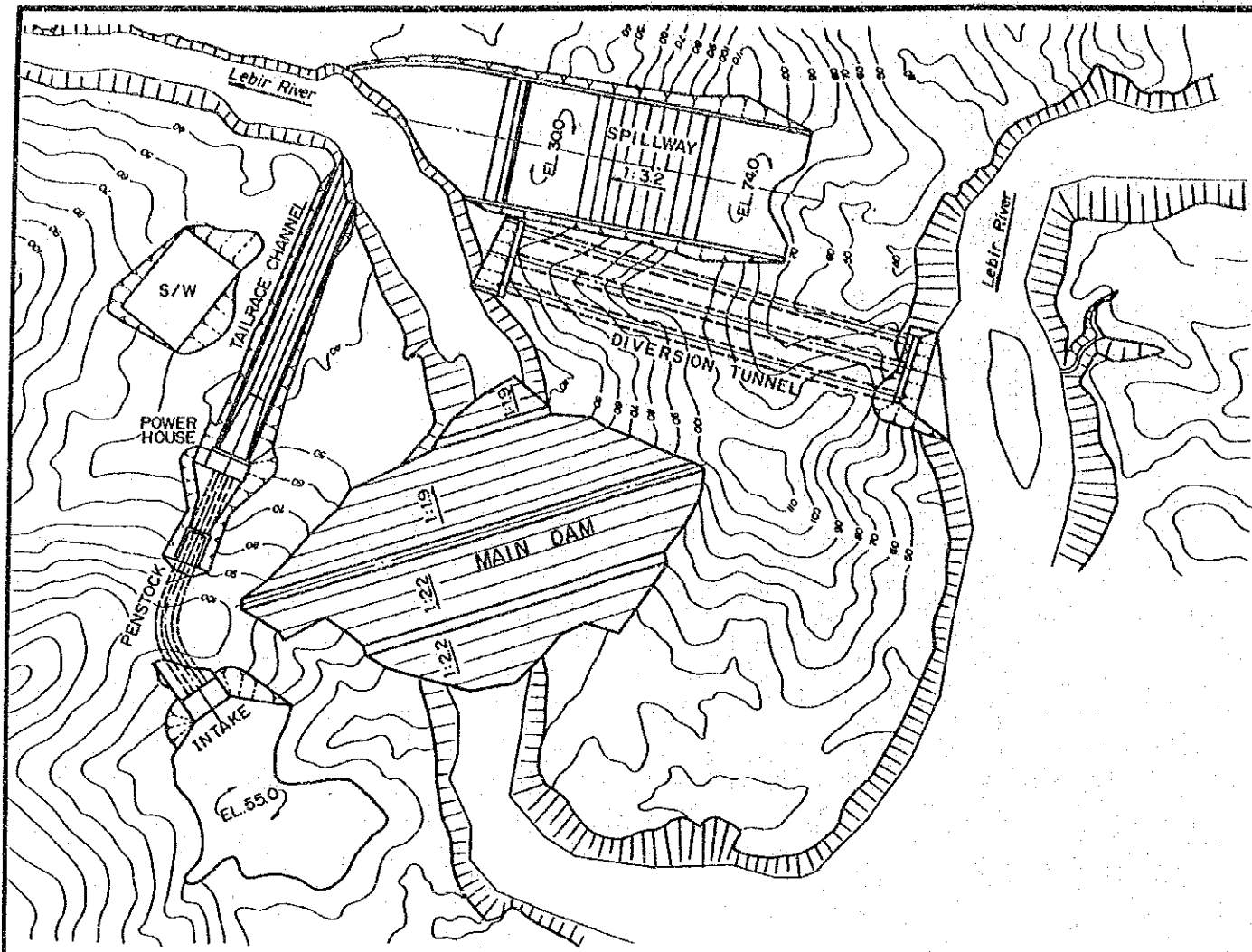
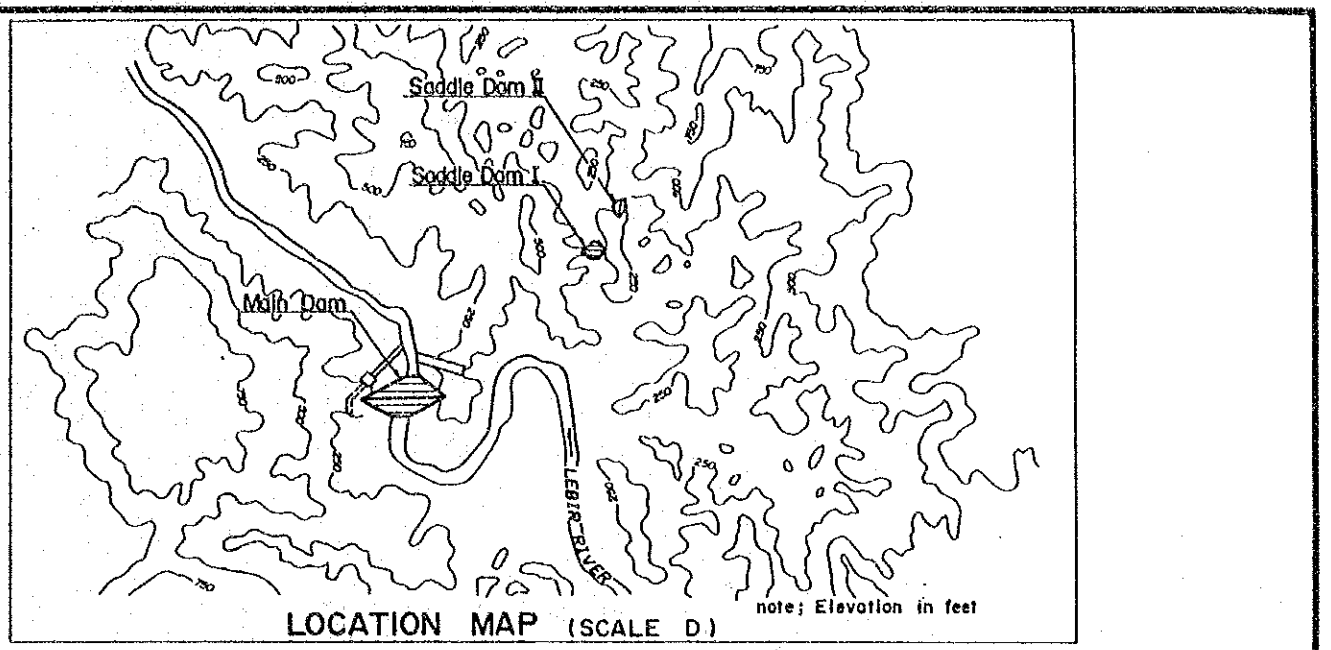

LOCATION MAP (SCALE D)

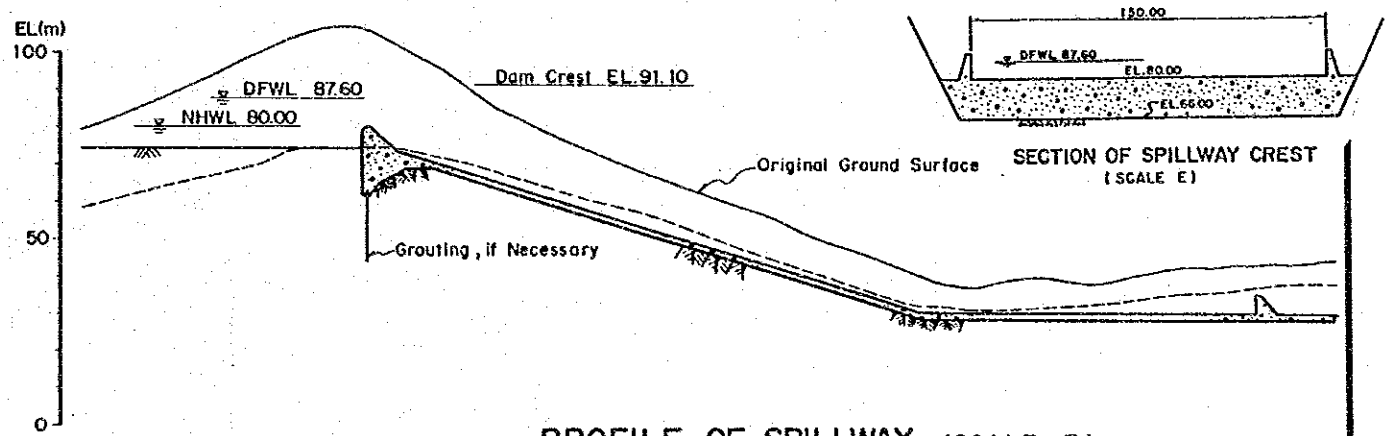

PROFILE OF SPILLWAY (SCALE E)

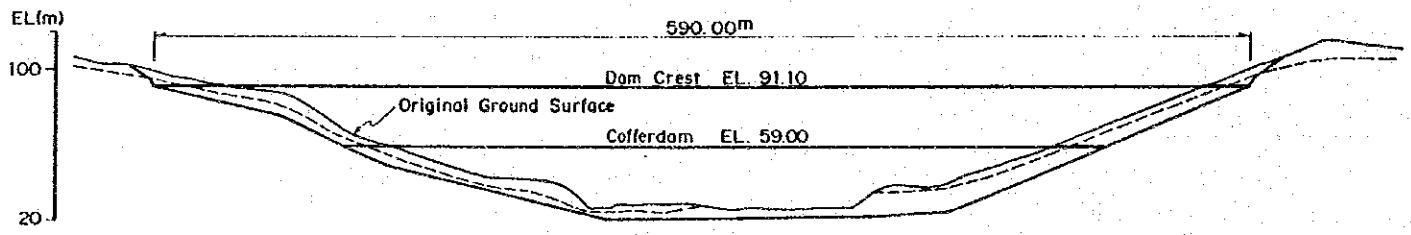

UPSTREAM ELEVATION OF MAIN DAM (SCALE B)

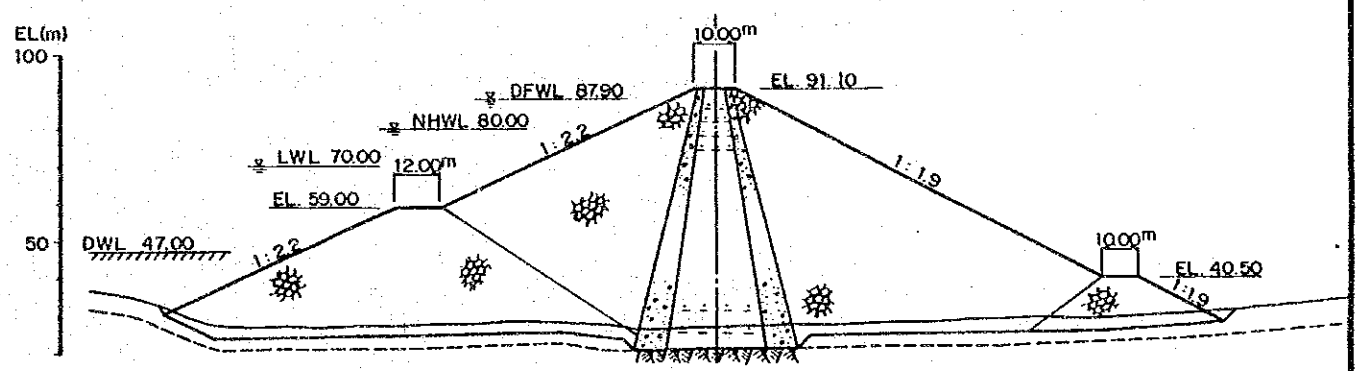

TYPICAL SECTION OF MAIN DAM (SCALE E)

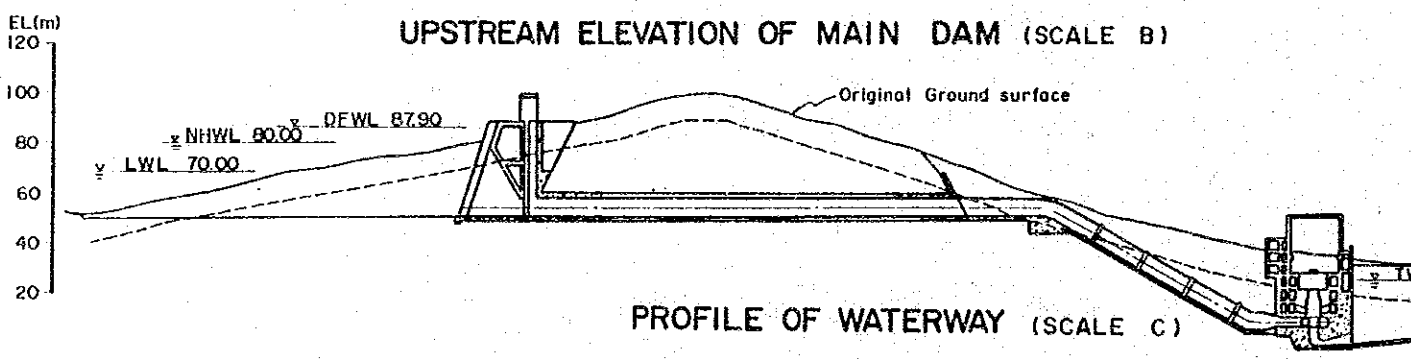

PROFILE OF WATERWAY (SCALE C)

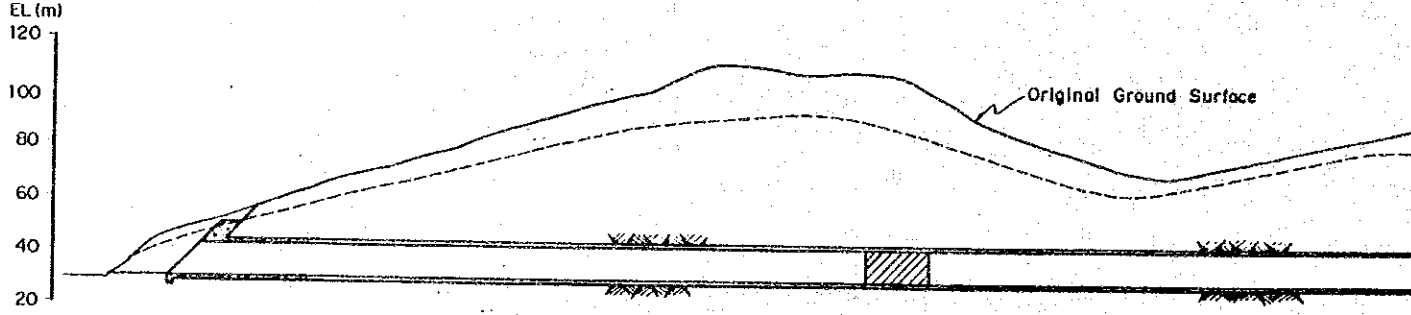

PROFILE OF DIVERSION TUNNEL (SCALE C)



図 3.8
レビルダムの基本開発案
(1 / 2)

GOVERNMENT OF MALAYSIA
STUDY
ON
KELANTAN RIVER BASIN - WIDE FLOOD MITIGATION
JAPAN INTERNATIONAL COOPERATION AGENCY



PLAN OF SADDLE DAMS (SCALE A)

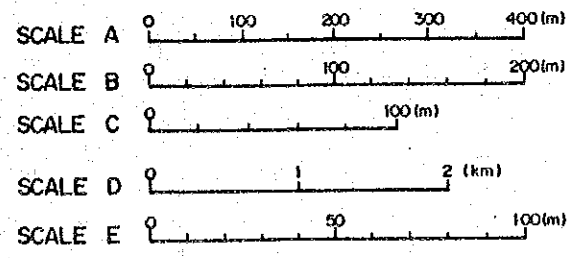
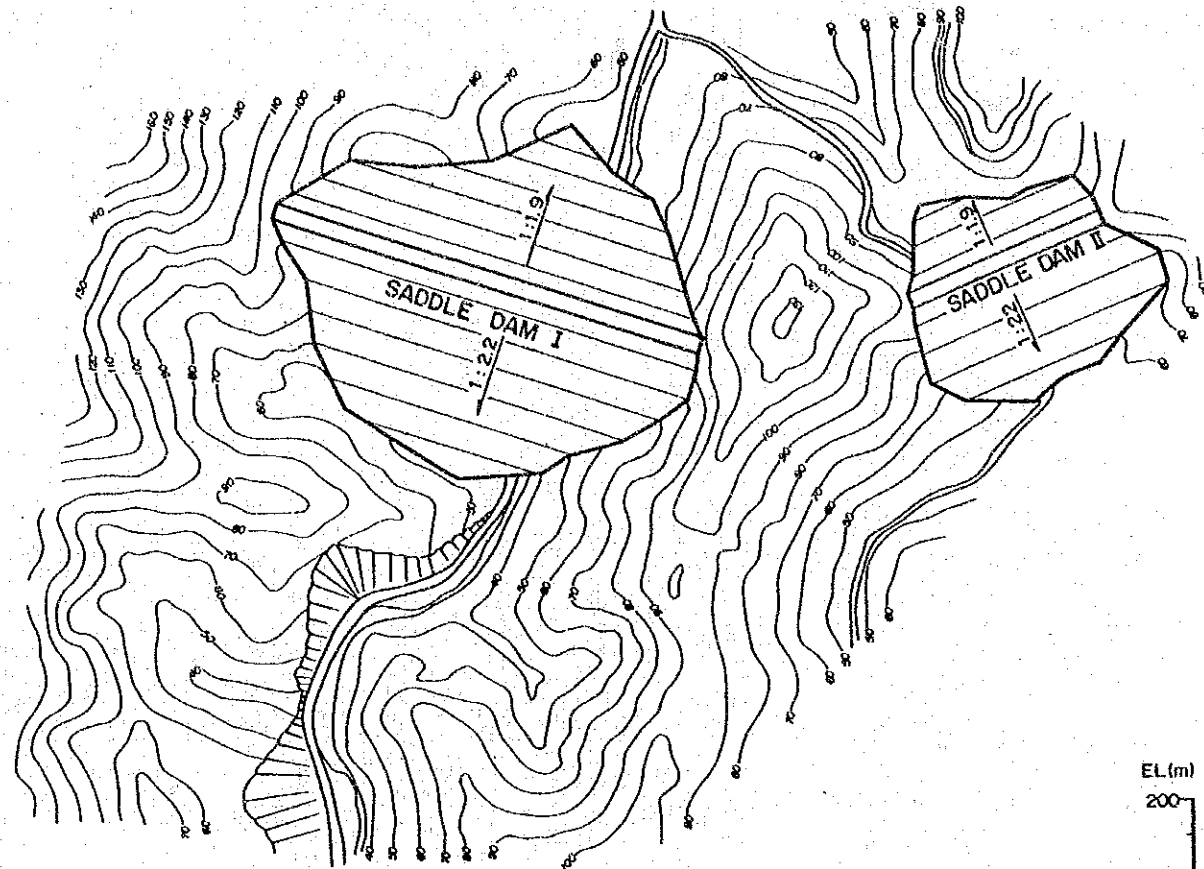
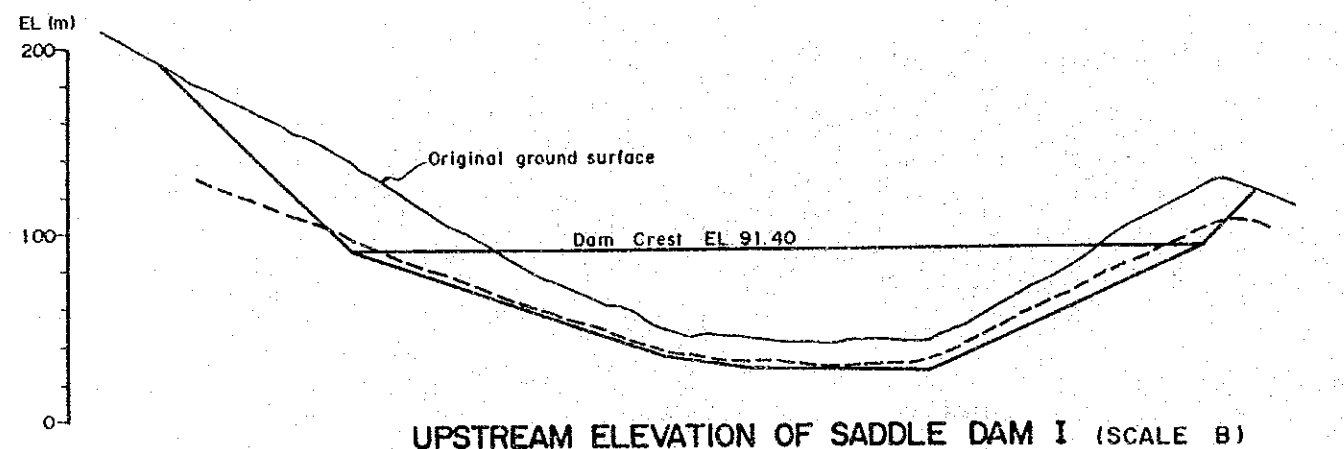

UPSTREAM ELEVATION OF SADDLE DAM I (SCALE B)

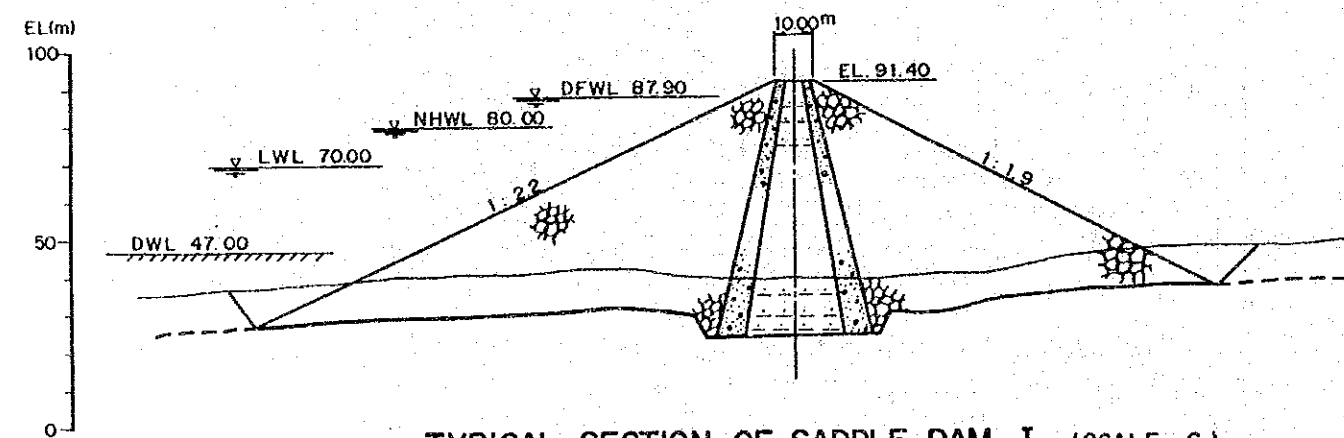

TYPICAL SECTION OF SADDLE DAM I (SCALE C)

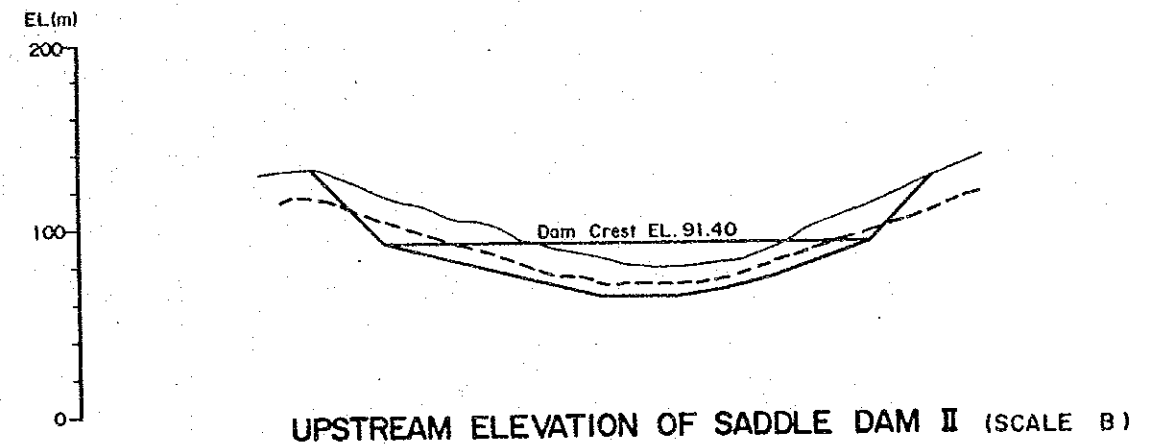

UPSTREAM ELEVATION OF SADDLE DAM II (SCALE B)

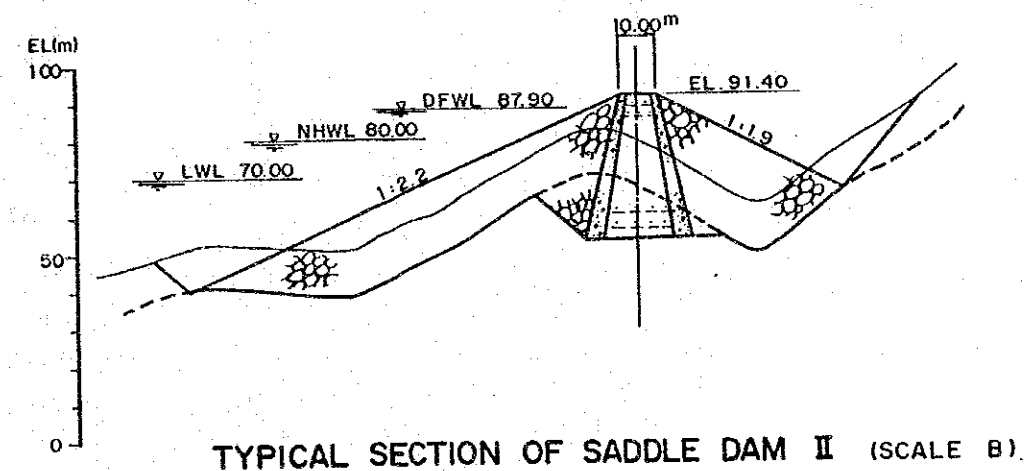

TYPICAL SECTION OF SADDLE DAM II (SCALE B)



図 3.8
レビルダムの基本開発案 (2 / 2)

GOVERNMENT OF MALAYSIA
STUDY
ON
KELANTAN RIVER BASIN - WIDE FLOOD MITIGATION
JAPAN INTERNATIONAL COOPERATION AGENCY



図 3.9 ダボンダムの位置図

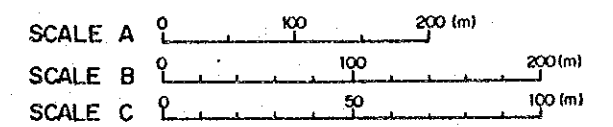

図 3.10 既存鉄道の横断図及び平面図

GOVERNMENT OF MALAYSIA
 STUDY
 ON
 KELANTAN RIVER BASIN - WIDE FLOOD MITIGATION
 JAPAN INTERNATIONAL COOPERATION AGENCY

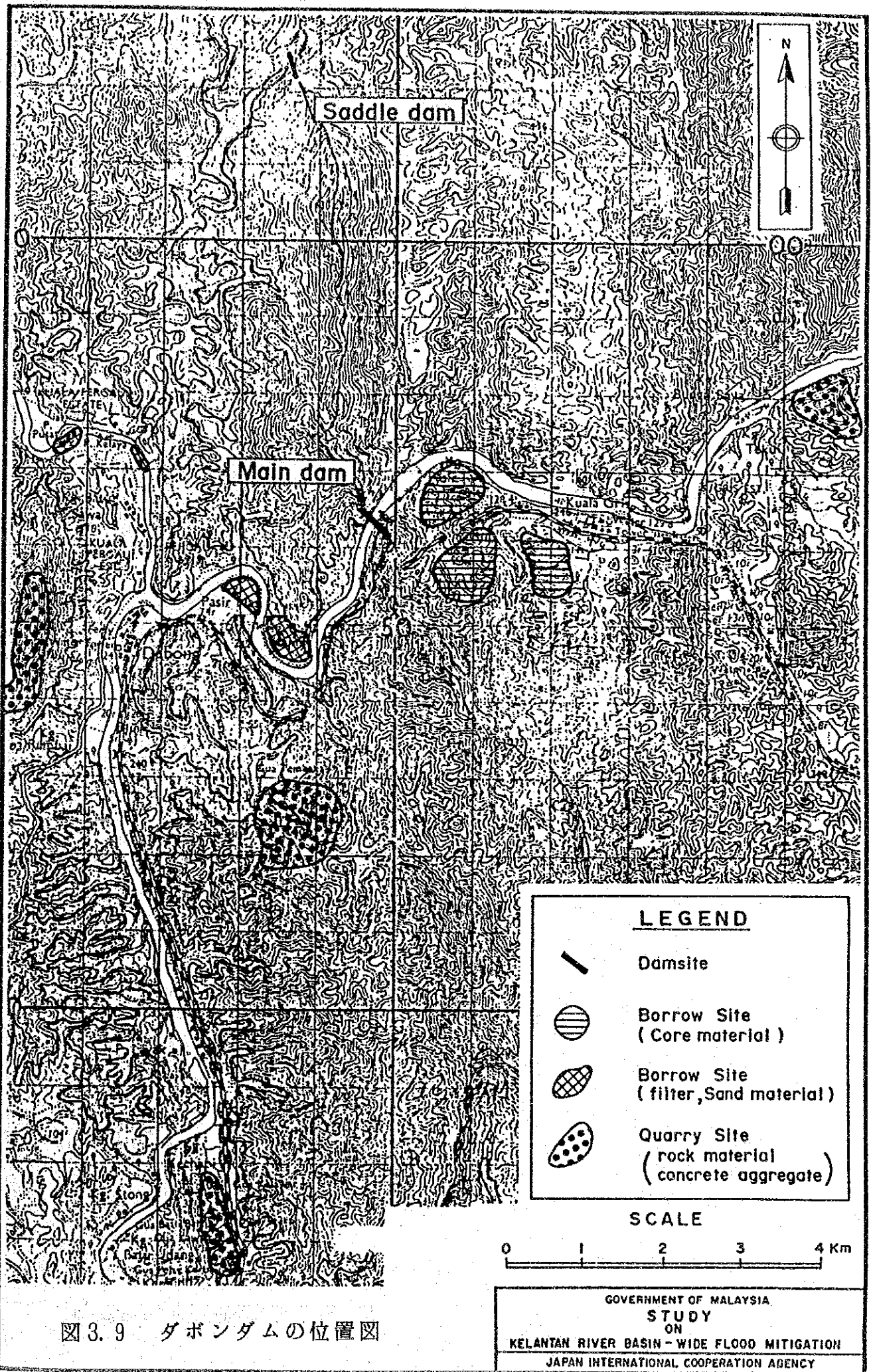

図 3.12 ダボンダムの貯水池容量曲線

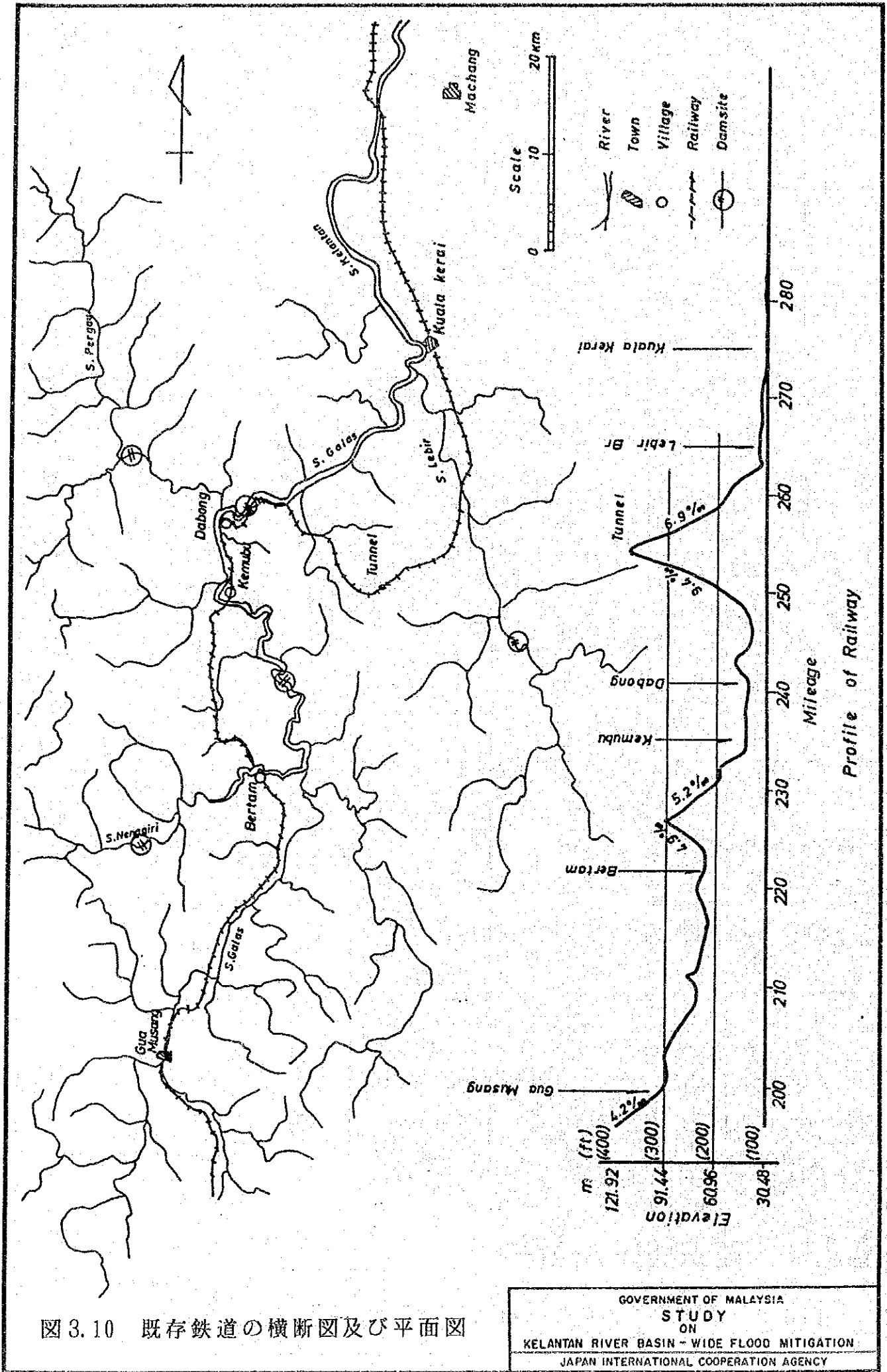
GOVERNMENT OF MALAYSIA
 STUDY
 ON
 KELANTAN RIVER BASIN - WIDE FLOOD MITIGATION
 JAPAN INTERNATIONAL COOPERATION AGENCY





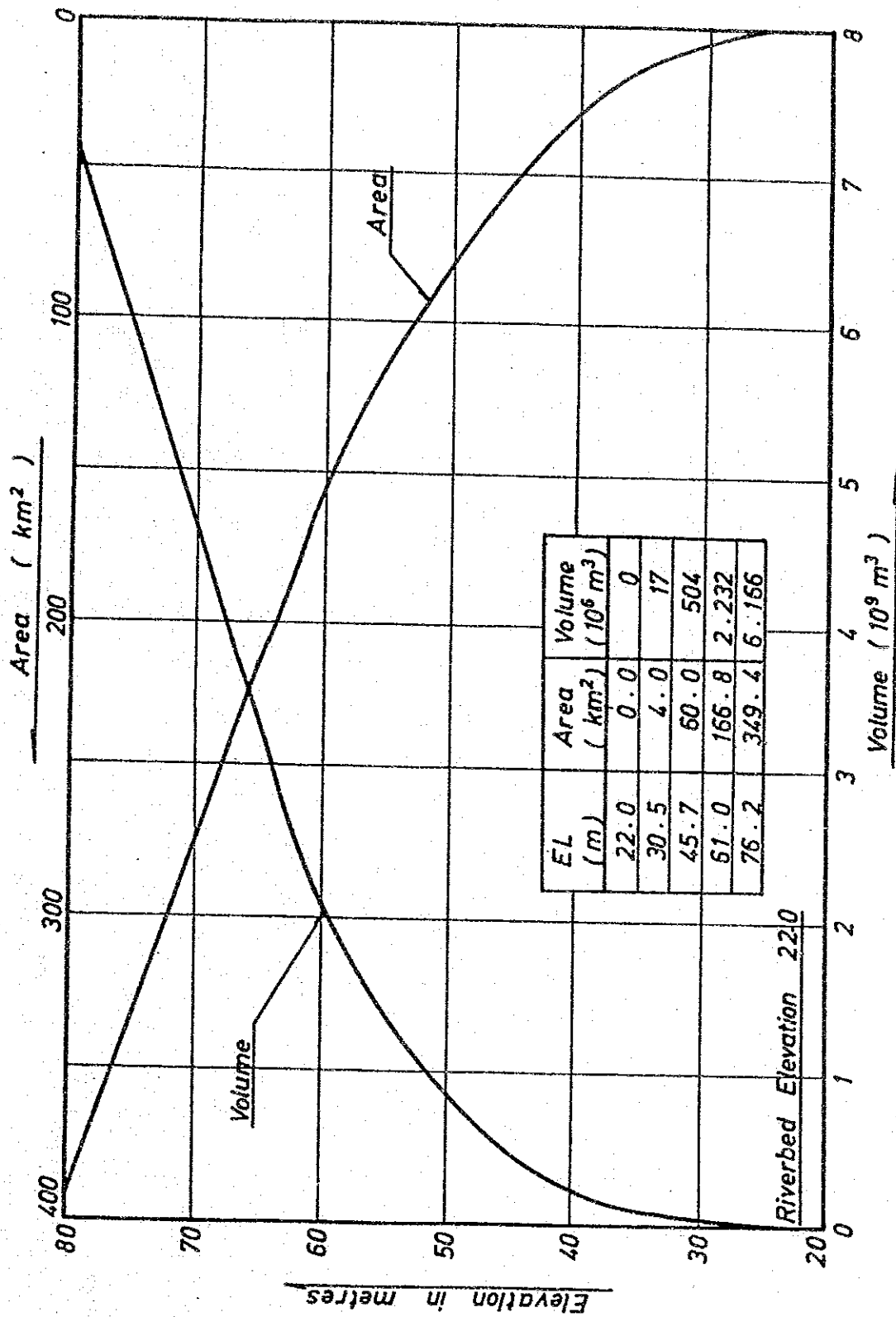
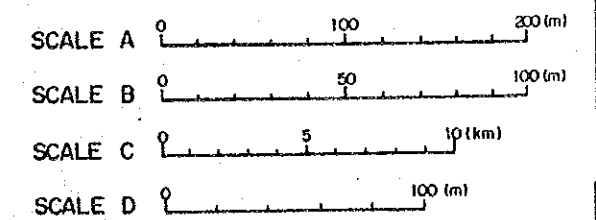
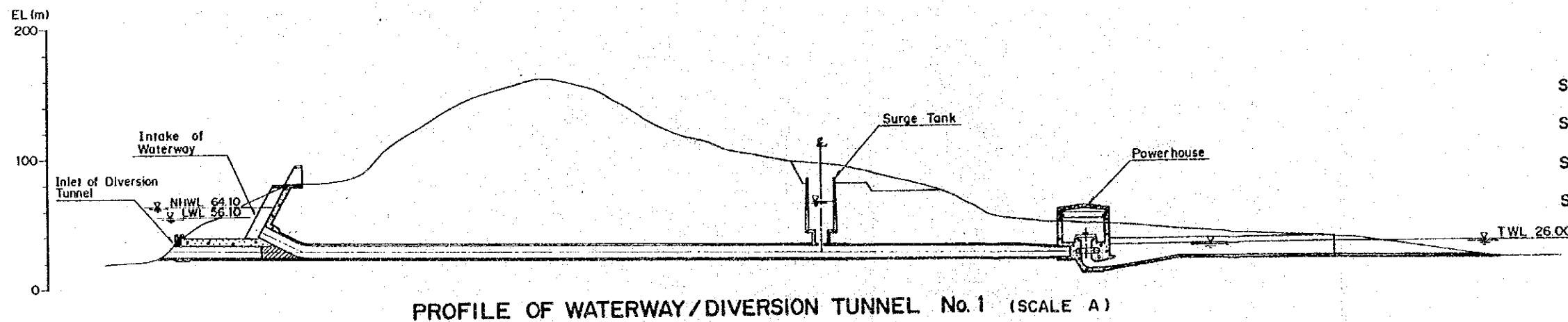
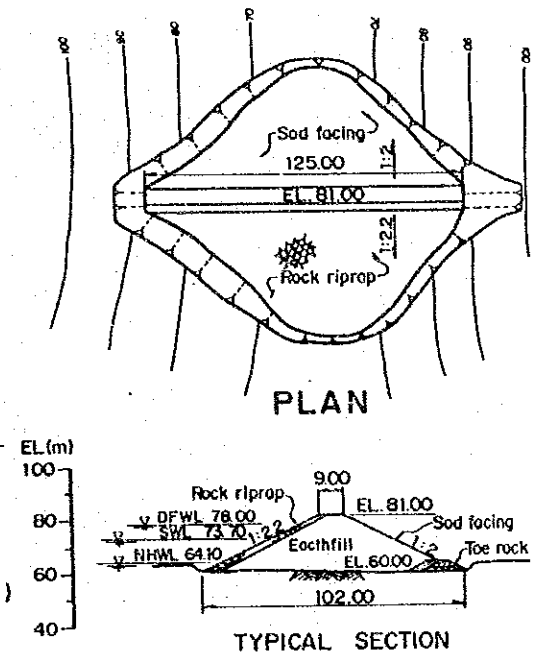
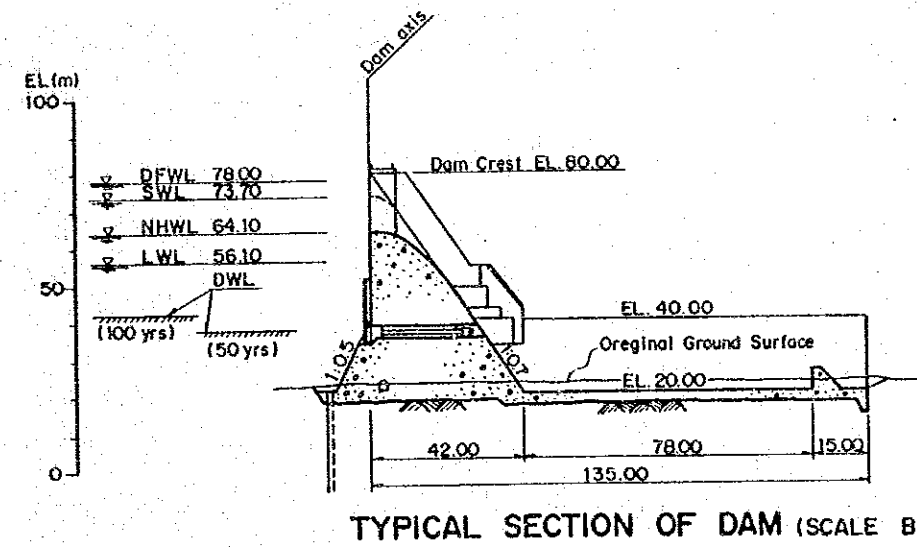
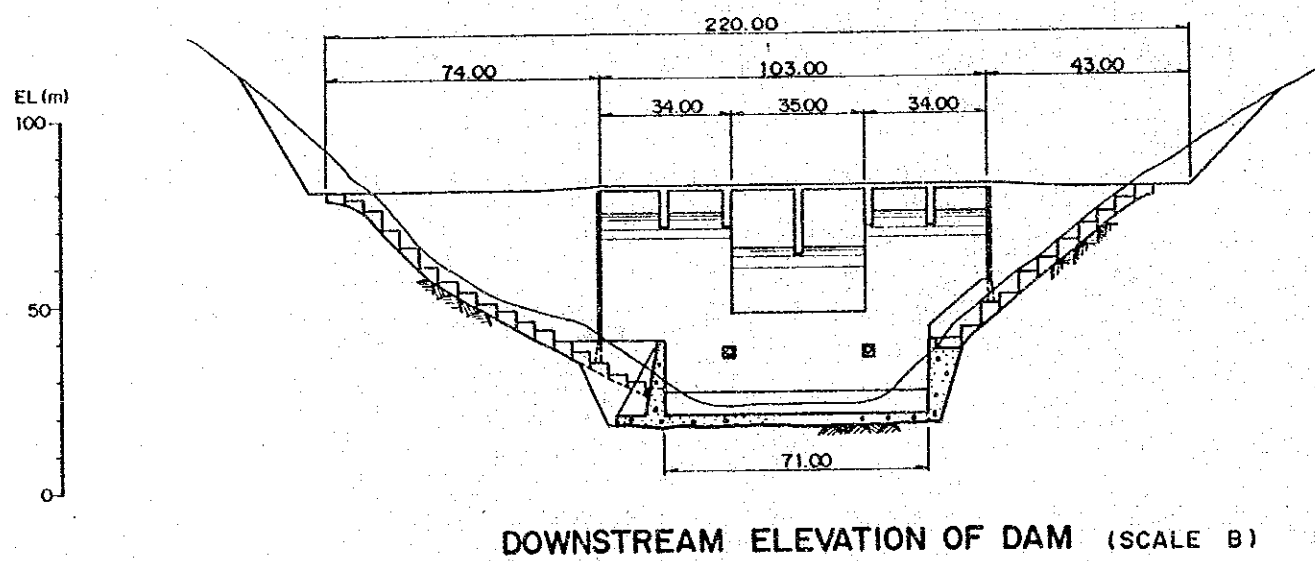
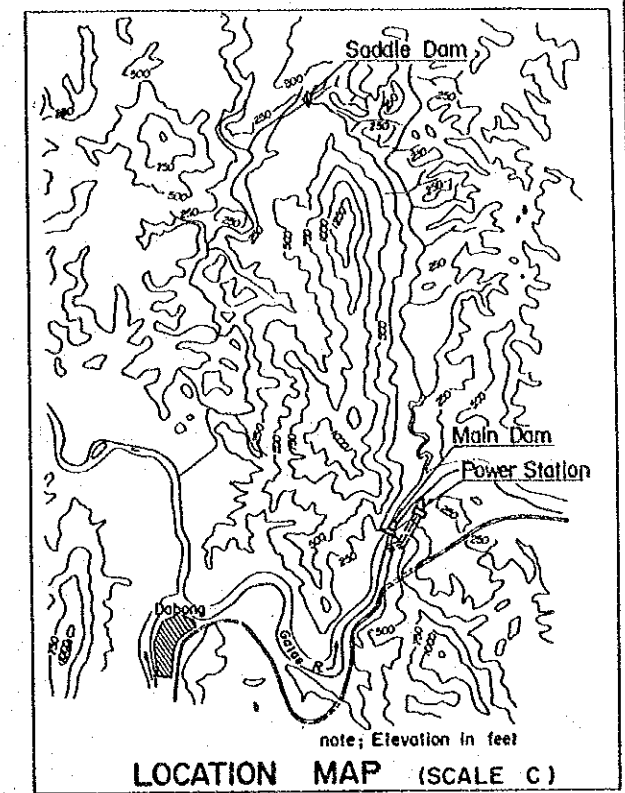
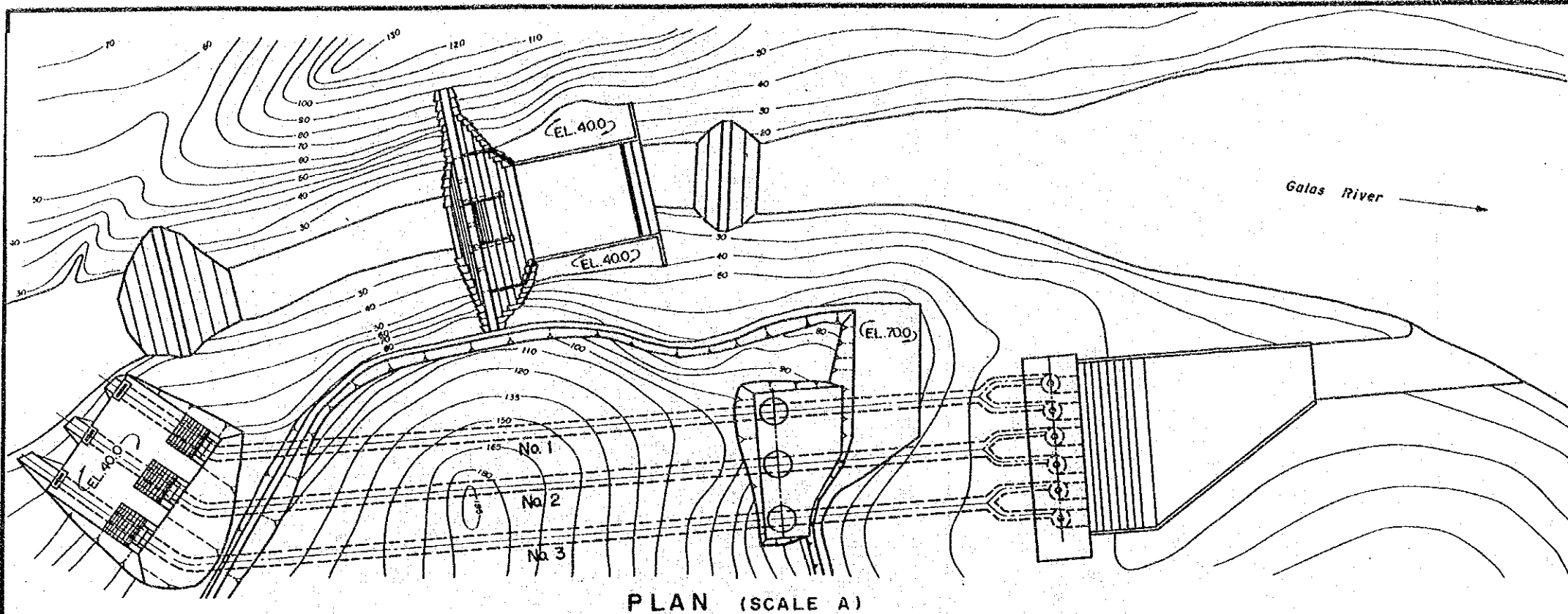

PROFILE OF WATERWAY/DIVERSION TUNNEL No. 1 (SCALE A)

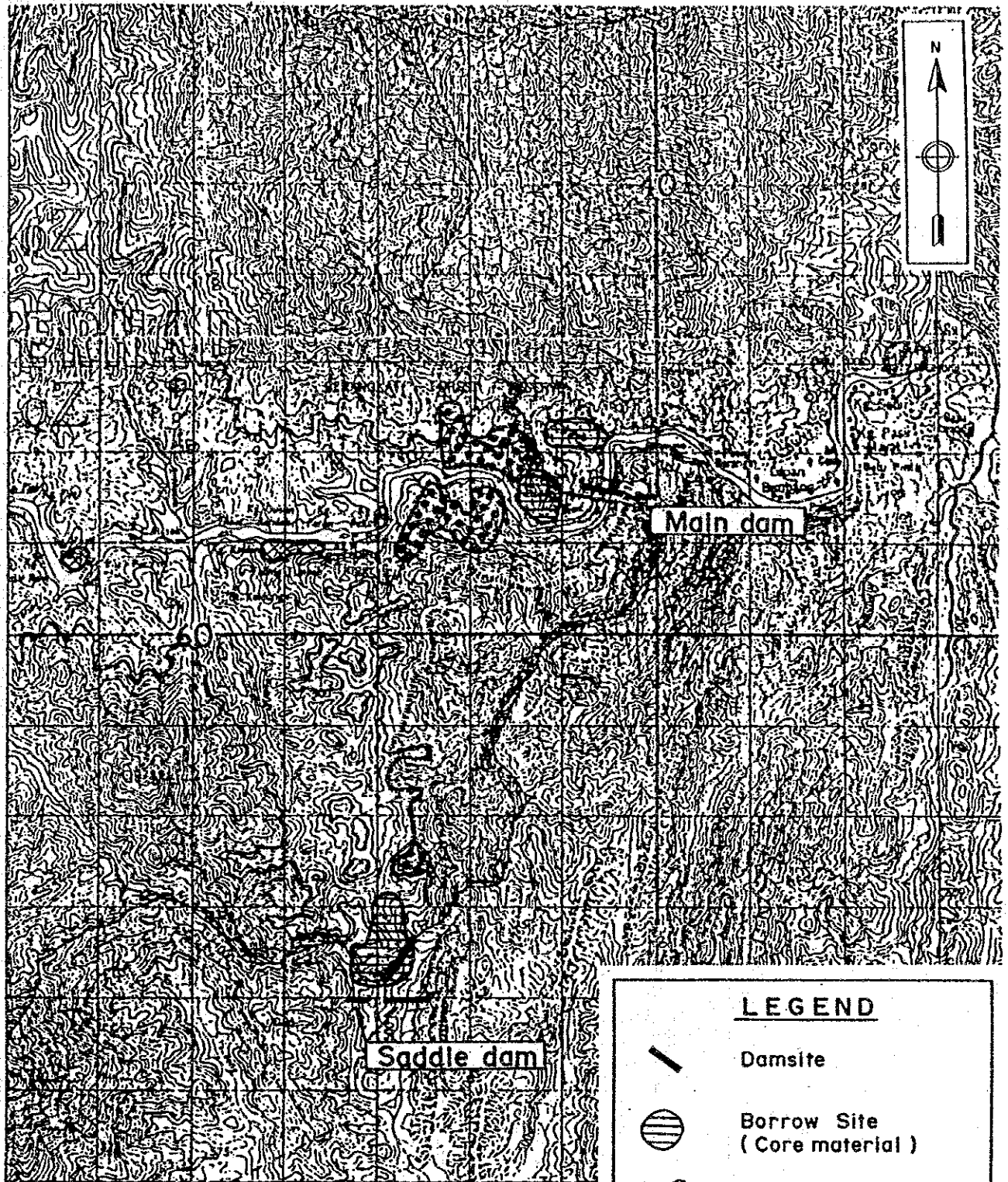
図 3.13 ダボンダムの基本開発案

GOVERNMENT OF MALAYSIA
STUDY
ON
KELANTAN RIVER BASIN - WIDE FLOOD MITIGATION
JAPAN INTERNATIONAL COOPERATION AGENCY



LEGEND

-  Damsite
-  Borrow Site (Core material)
-  Borrow Site (filter, Sand material)
-  Quarry Site (rock material concrete aggregate)



図 3.14 ネンギリダムの位置図

GOVERNMENT OF MALAYSIA
 STUDY
 ON
 KELANTAN RIVER BASIN - WIDE FLOOD MITIGATION
 JAPAN INTERNATIONAL COOPERATION AGENCY

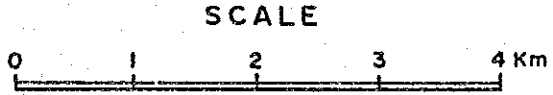

図 3.15 ネンギリダムの湛水面積

GOVERNMENT OF MALAYSIA
 STUDY
 ON
 KELANTAN RIVER BASIN - WIDE FLOOD MITIGATION
 JAPAN INTERNATIONAL COOPERATION AGENCY

Area Km²

100

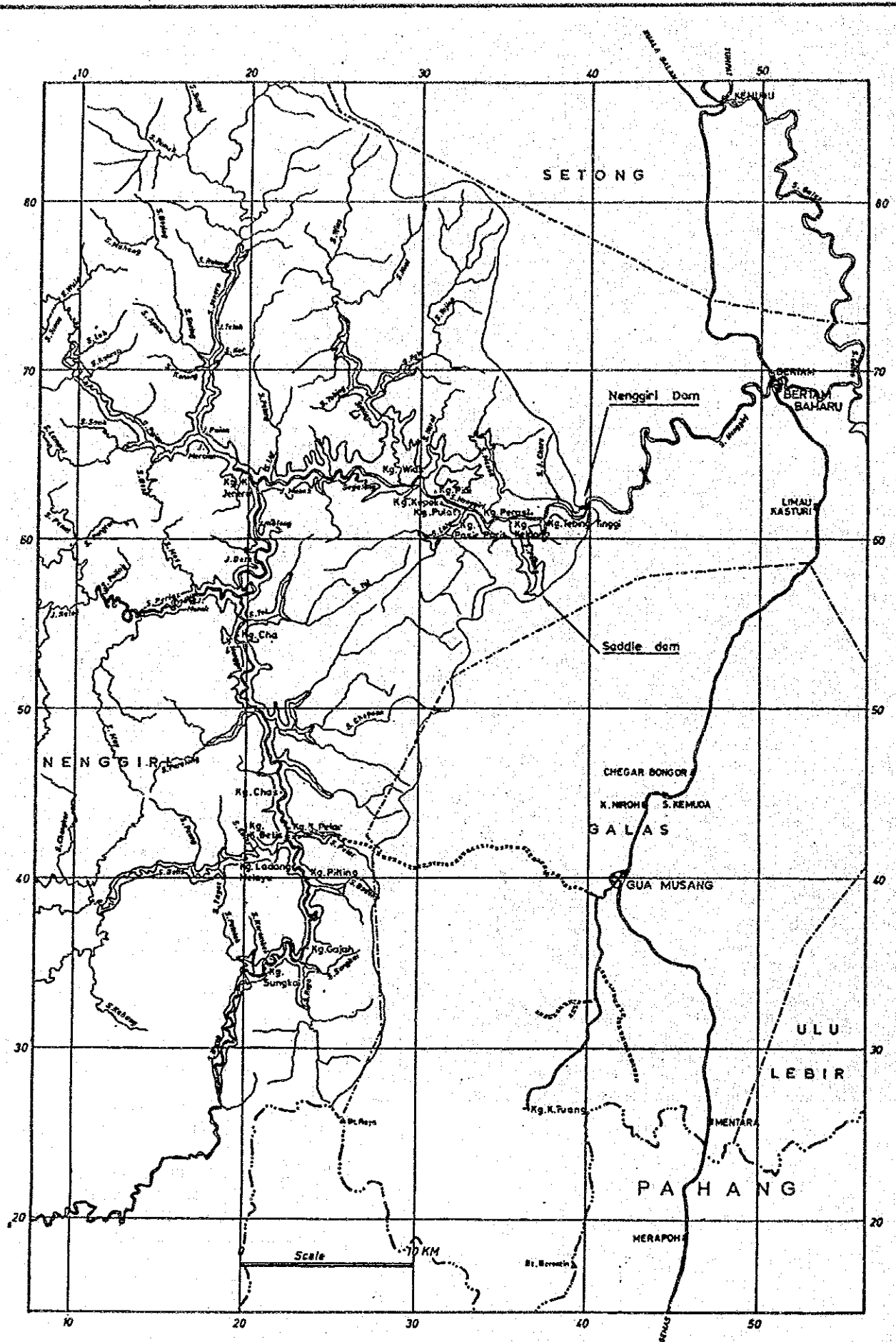
150

200

0

50

100

150

200

A

V

EL M	Area KM ²	DV 10 ⁶ m ³	Storage 10 ⁶ m ³
60	0.00	-	-
65	0.52	1.3	1.3
70	1.4	4.8	6.1
75	2.6	10.0	16.1
80	4.6	18.0	34.1
85	7.0	29.0	63.1
90	9.25	40.6	103.7
95	11.8	52.6	156.3
100	14.4	65.5	221.8
105	17.75	80.4	302.2
110	21.25	97.5	399.7
115	26.7	119.9	519.6
120	31.8	146.2	665.8
125	38.6	176.0	841.8
130	46.0	211.5	1053.3
135	55.5	253.8	1307.1
140	65.3	302.0	1609.1
145	78.5	359.5	1968.6
150	90.75	423.1	2391.7
155	104.0	486.9	2878.6
160	118.0	555.0	3433.6
165	136.0	635.0	4068.6
170	154.3	725.8	4794.4

CA = 3,690 km²

Storage V 10⁶ m³

2000

1000

500

4000

3000

100

150

200

0

Source
F/s Report
NENGGIRI
Vol 6.
Sept 1986
ELC

△River bed EL 62 m

△Dam Foundation EL 54 m

図 3.16 ネンギリダムの貯水池容量曲線

GOVERNMENT OF MALAYSIA
STUDY
ON
KELANTAN RIVER BASIN - WIDE FLOOD MITIGATION
JAPAN INTERNATIONAL COOPERATION AGENCY

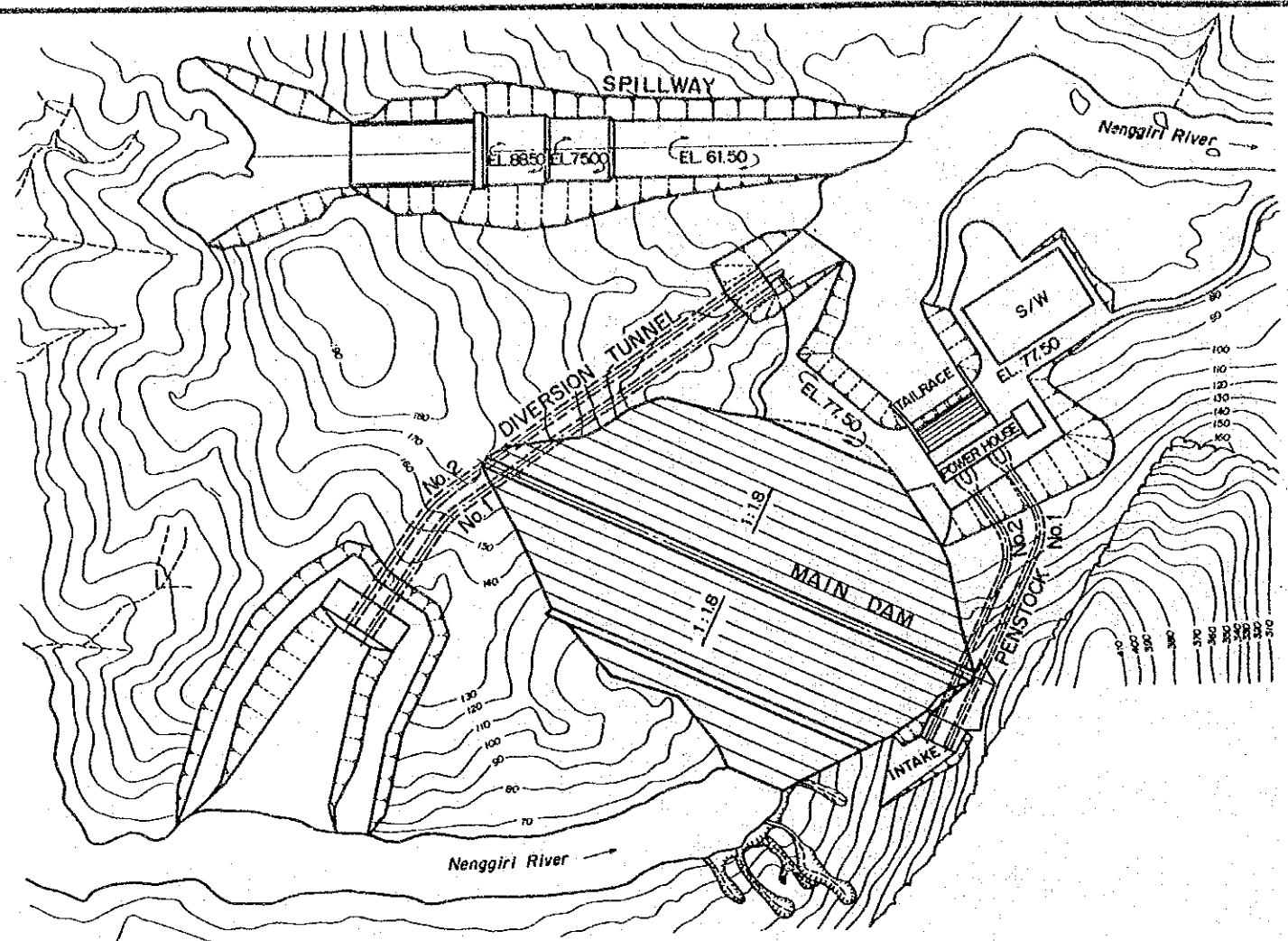

PLAN (SCALE A)

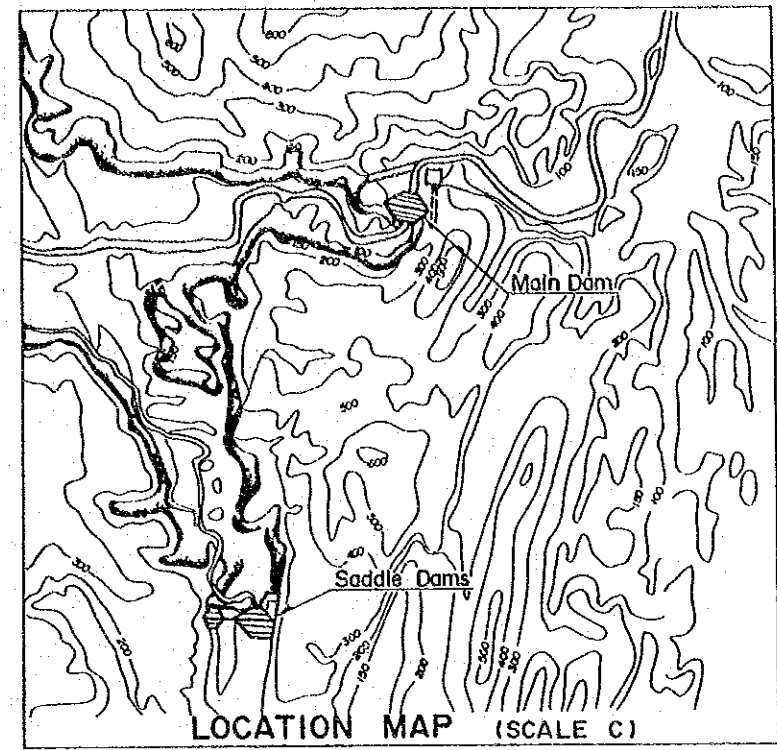

LOCATION MAP (SCALE C)

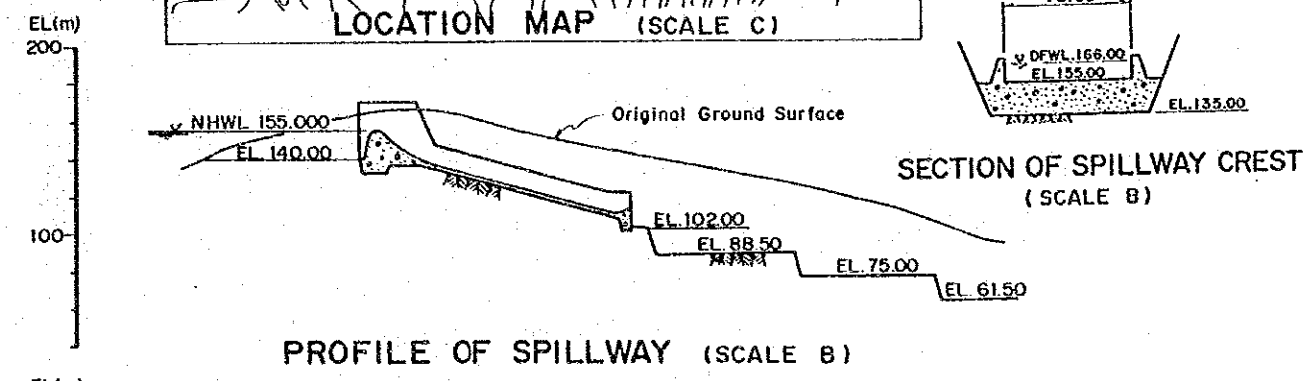

PROFILE OF SPILLWAY (SCALE B)

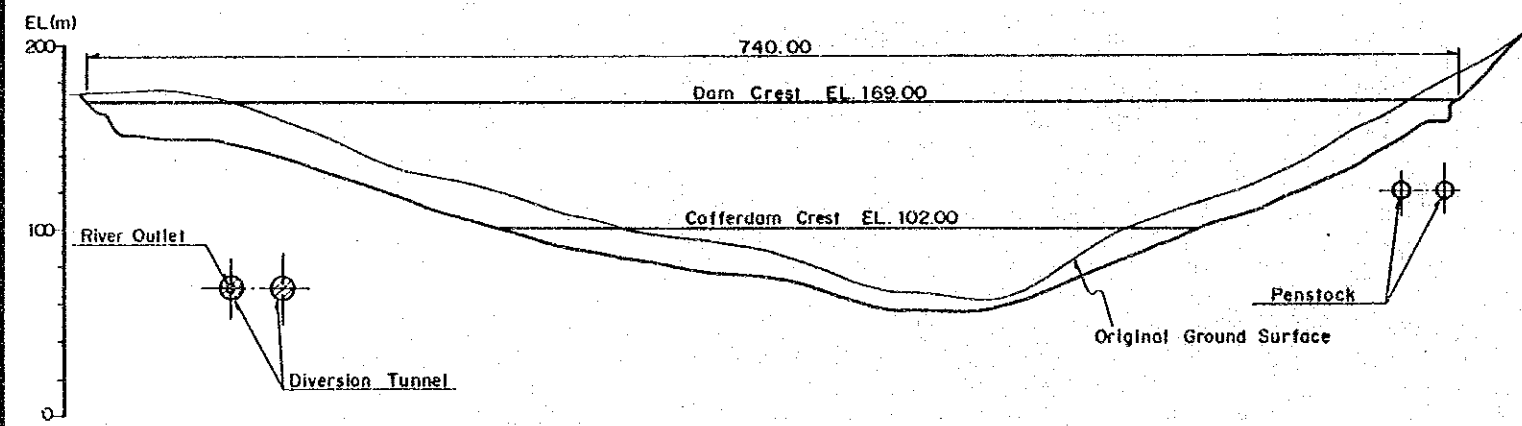

UPSTREAM ELEVATION OF MAIN DAM (SCALE B)

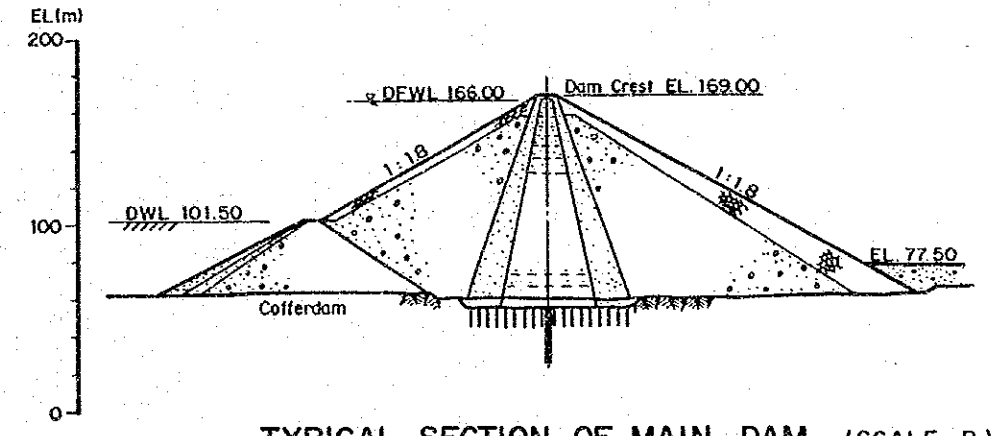

TYPICAL SECTION OF MAIN DAM (SCALE B)

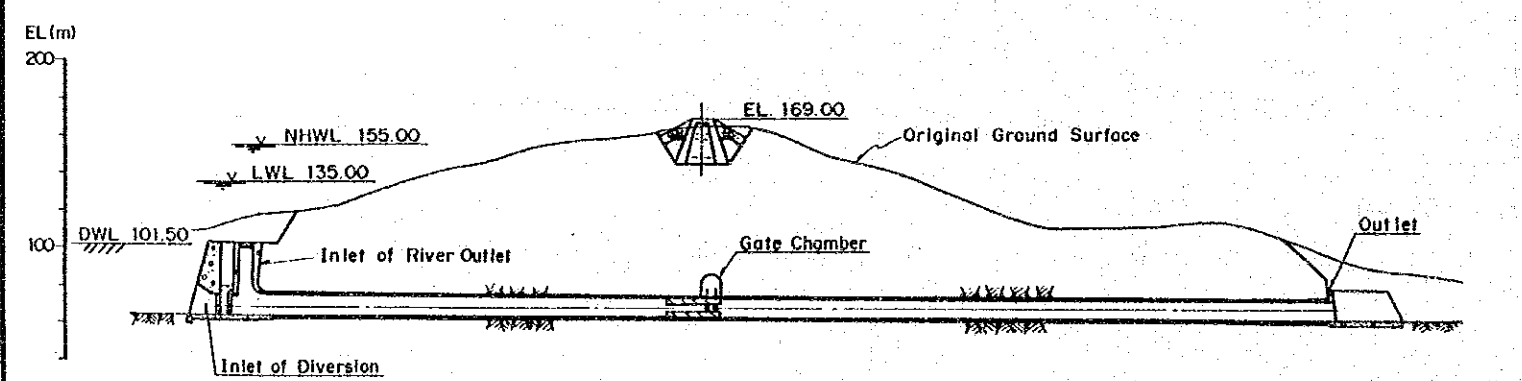

PROFILE OF DIVERSION TUNNEL No.1/RIVER OUTLET (SCALE B)

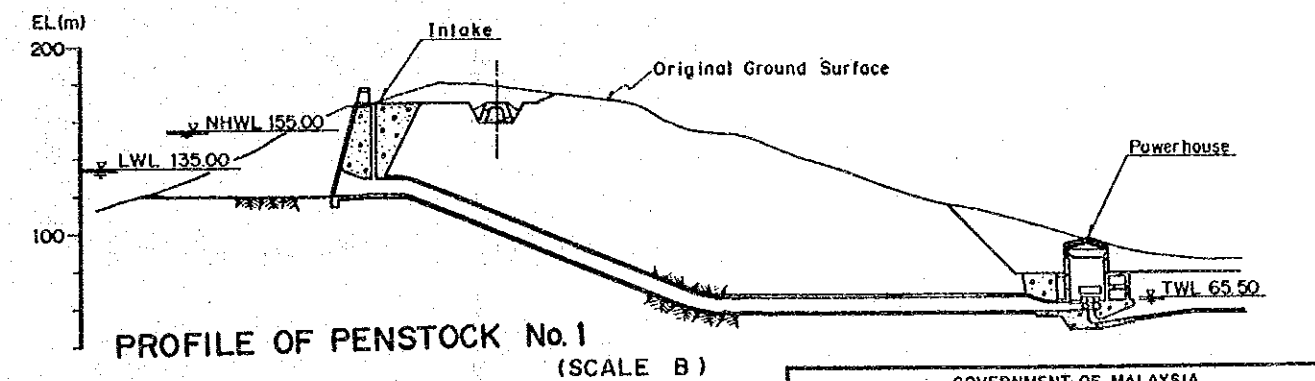

PROFILE OF PENSTOCK No.1 (SCALE B)

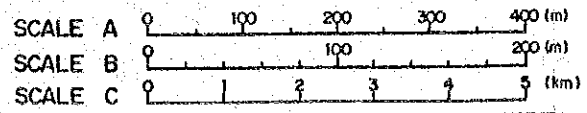

GOVERNMENT OF MALAYSIA
STUDY
 ON
KELANTAN RIVER BASIN - WIDE FLOOD MITIGATION
 JAPAN INTERNATIONAL COOPERATION AGENCY

図3.17 ネンギリダムの基本開発案 (1/2)

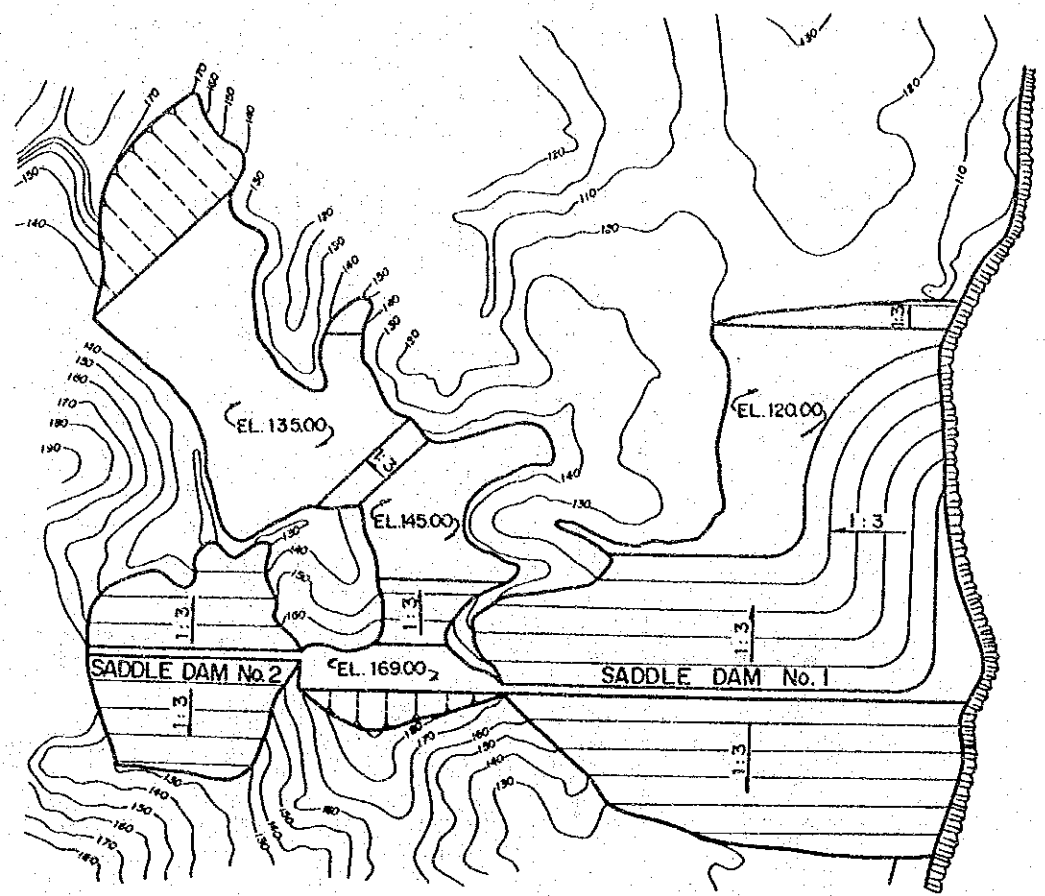

PLAN OF SADDLE DAMS (SCALE A)

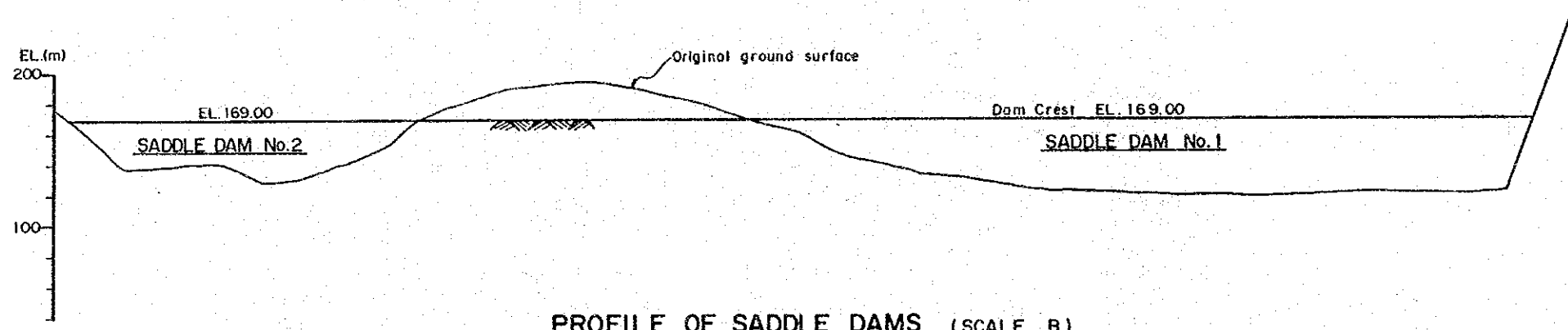

PROFILE OF SADDLE DAMS (SCALE B)

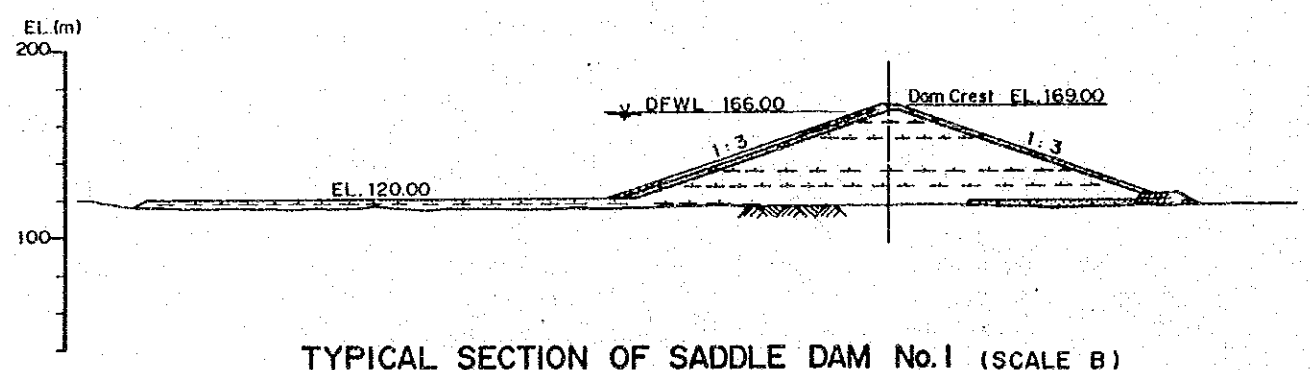
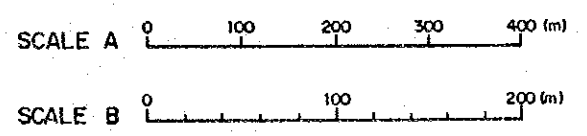

TYPICAL SECTION OF SADDLE DAM No.1 (SCALE B)

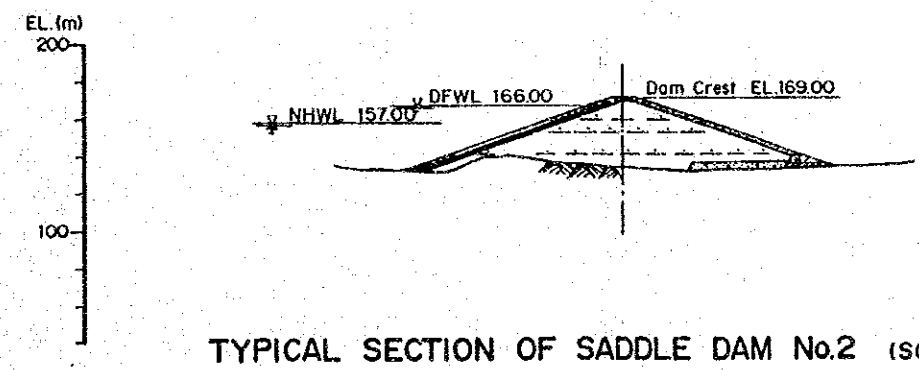

TYPICAL SECTION OF SADDLE DAM No.2 (SCALE B)

図3.17 ネンギリダムの基本開発案 (2 / 2)

GOVERNMENT OF MALAYSIA
 STUDY
 ON
 KELANTAN RIVER BASIN - WIDE FLOOD MITIGATION
 JAPAN INTERNATIONAL COOPERATION AGENCY







図 3.18 クムブダムの位置図

LEGEND

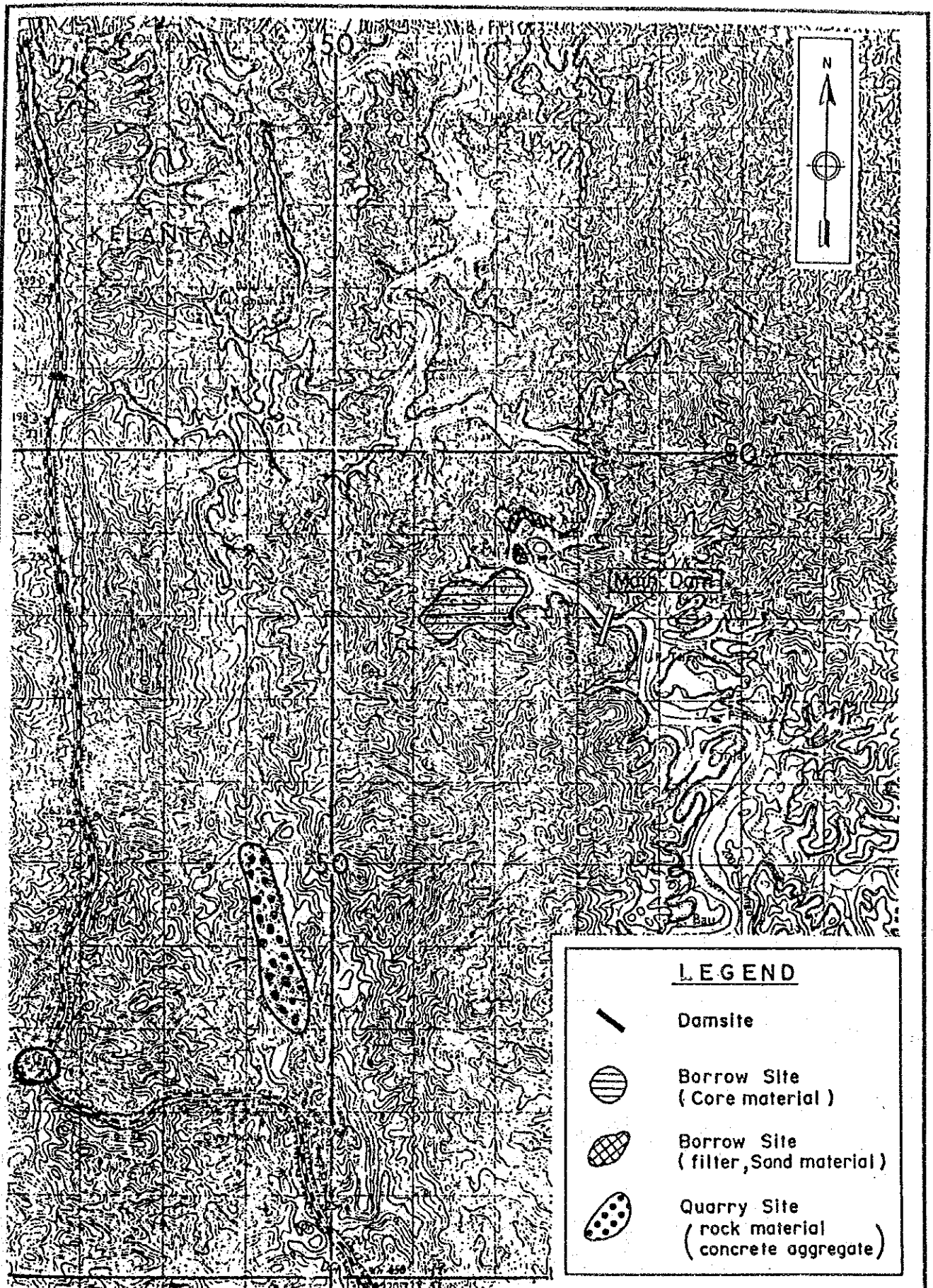
-  Damsite
-  Borrow Site (Core material)
-  Borrow Site (filter, Sand material)
-  Quarry Site (rock material concrete aggregate)

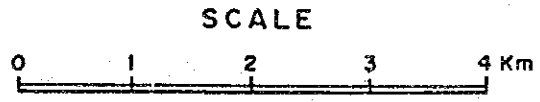

GOVERNMENT OF MALAYSIA
 STUDY
 ON
 KELANTAN RIVER BASIN - WIDE FLOOD MITIGATION
 JAPAN INTERNATIONAL COOPERATION AGENCY



図 3.19 クムブダムの貯水池容量曲線

GOVERNMENT OF MALAYSIA
 STUDY
 ON
 KELANTAN RIVER BASIN - WIDE FLOOD MITIGATION
 JAPAN INTERNATIONAL COOPERATION AGENCY



PLAN (SCALE A)

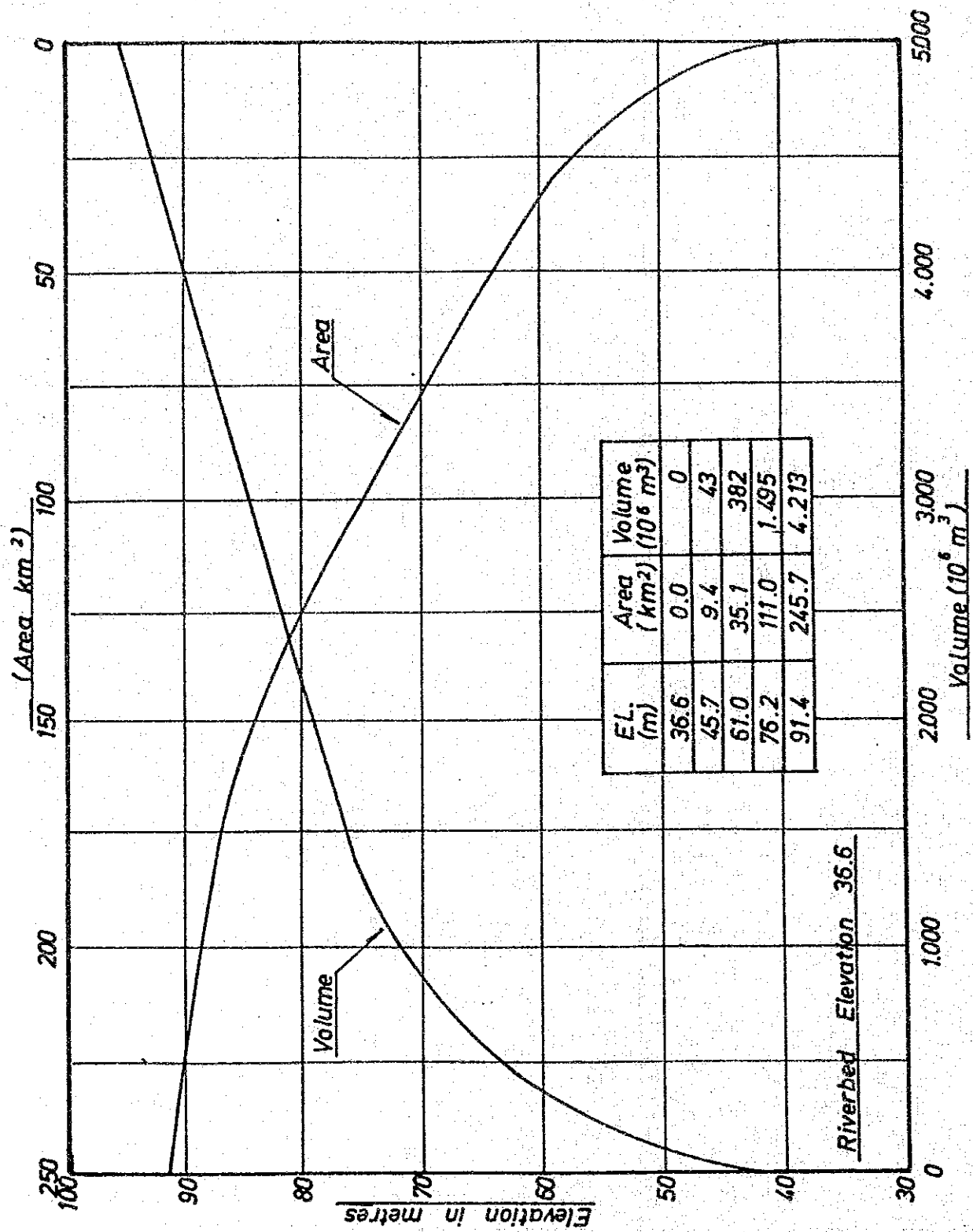
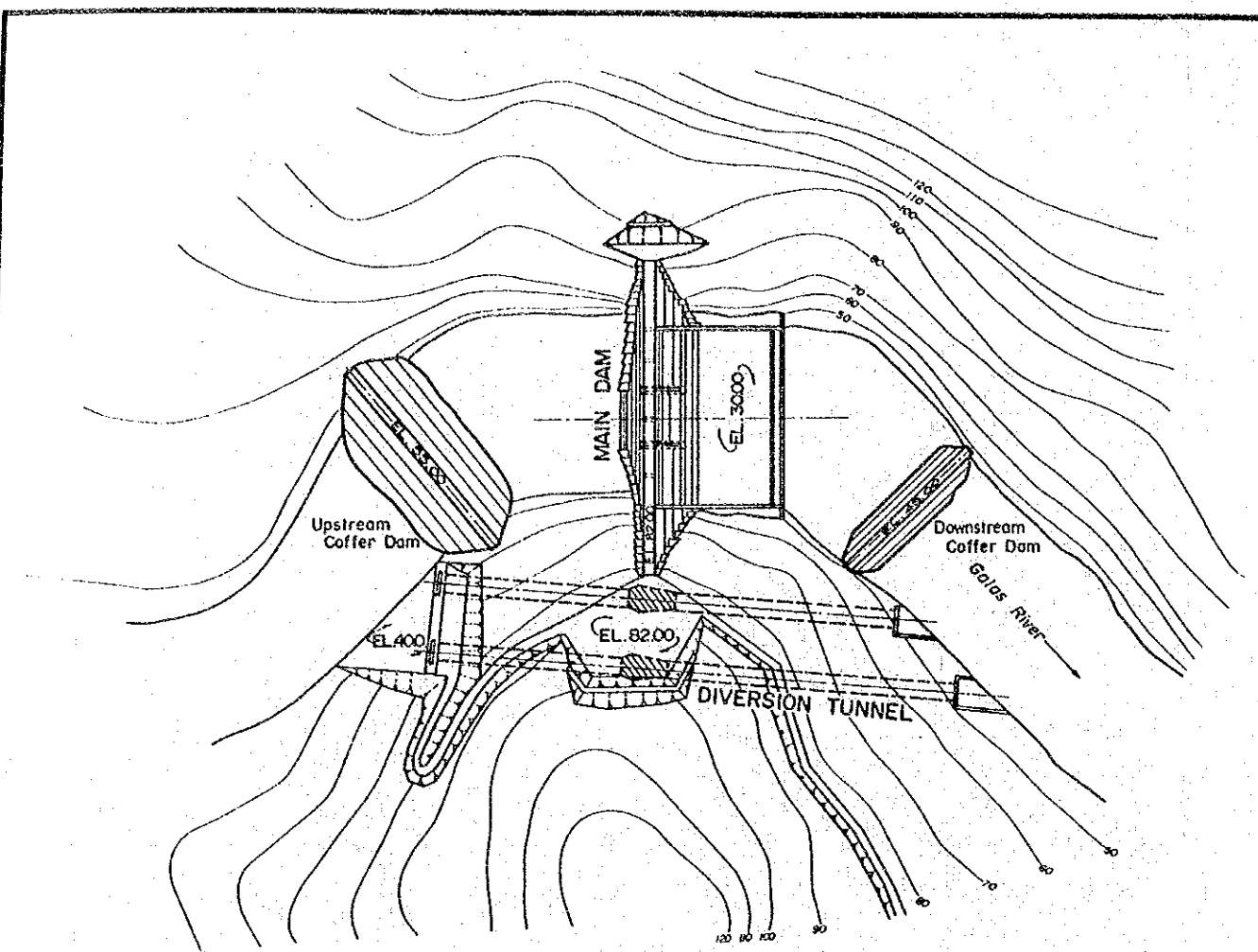
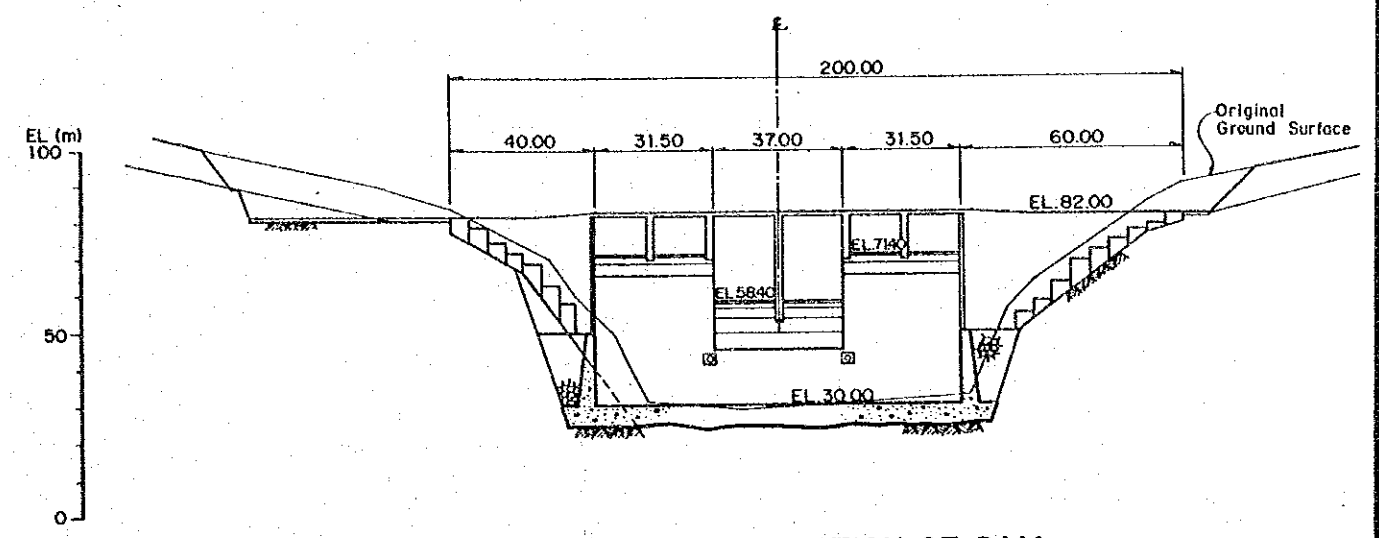

DOWNSTREAM ELEVATION OF DAM (SCALE B)

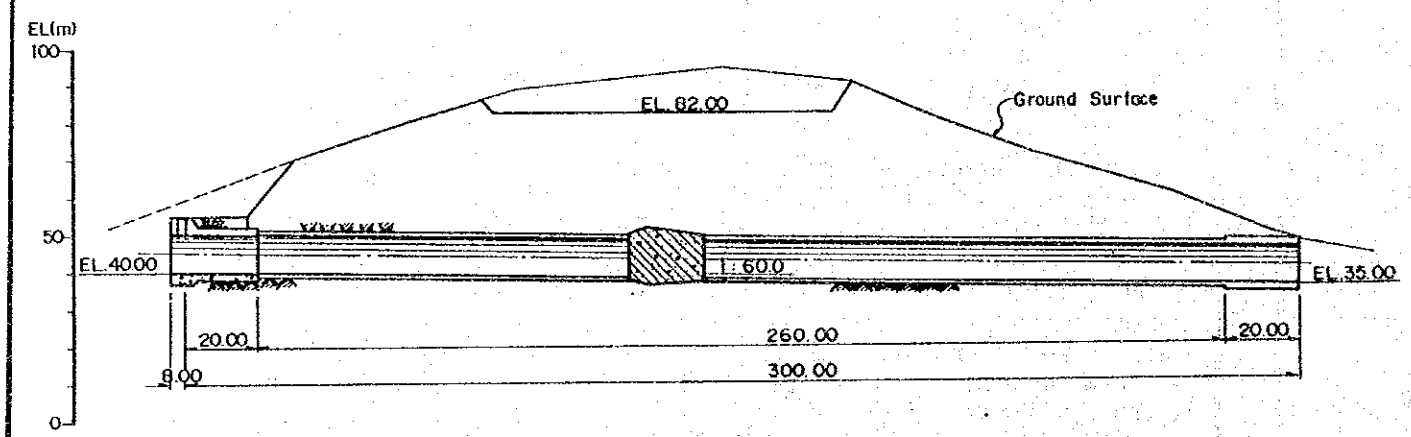

PROFILE OF DIVERSION TUNNEL (SCALE B)

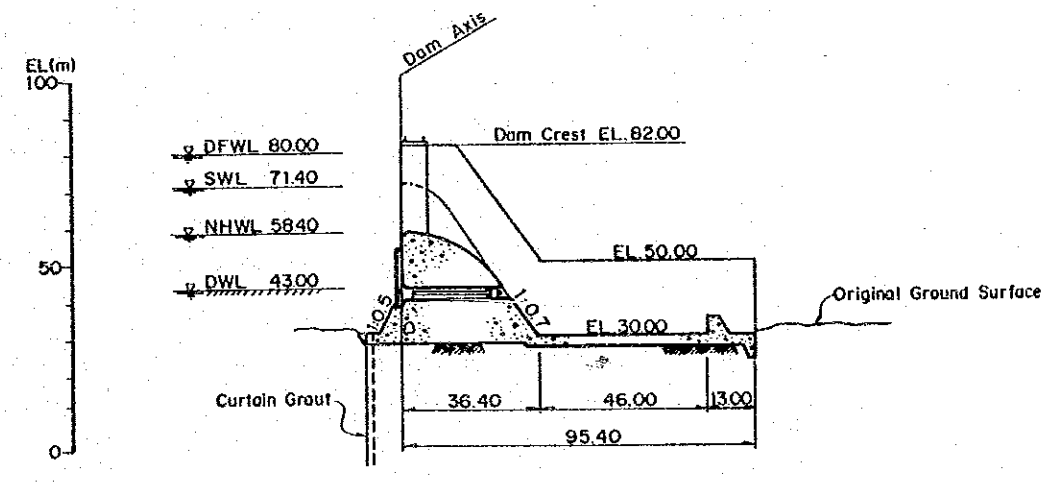

TYPICAL SECTION OF DAM (SCALE B)







図 3.20 クムブダムの基本開発案

GOVERNMENT OF MALAYSIA
STUDY
 ON
 KELANTAN RIVER BASIN - WIDE FLOOD MITIGATION
 JAPAN INTERNATIONAL COOPERATION AGENCY

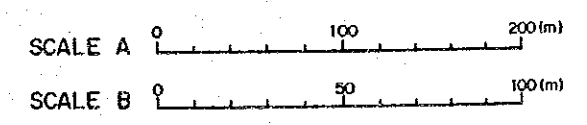
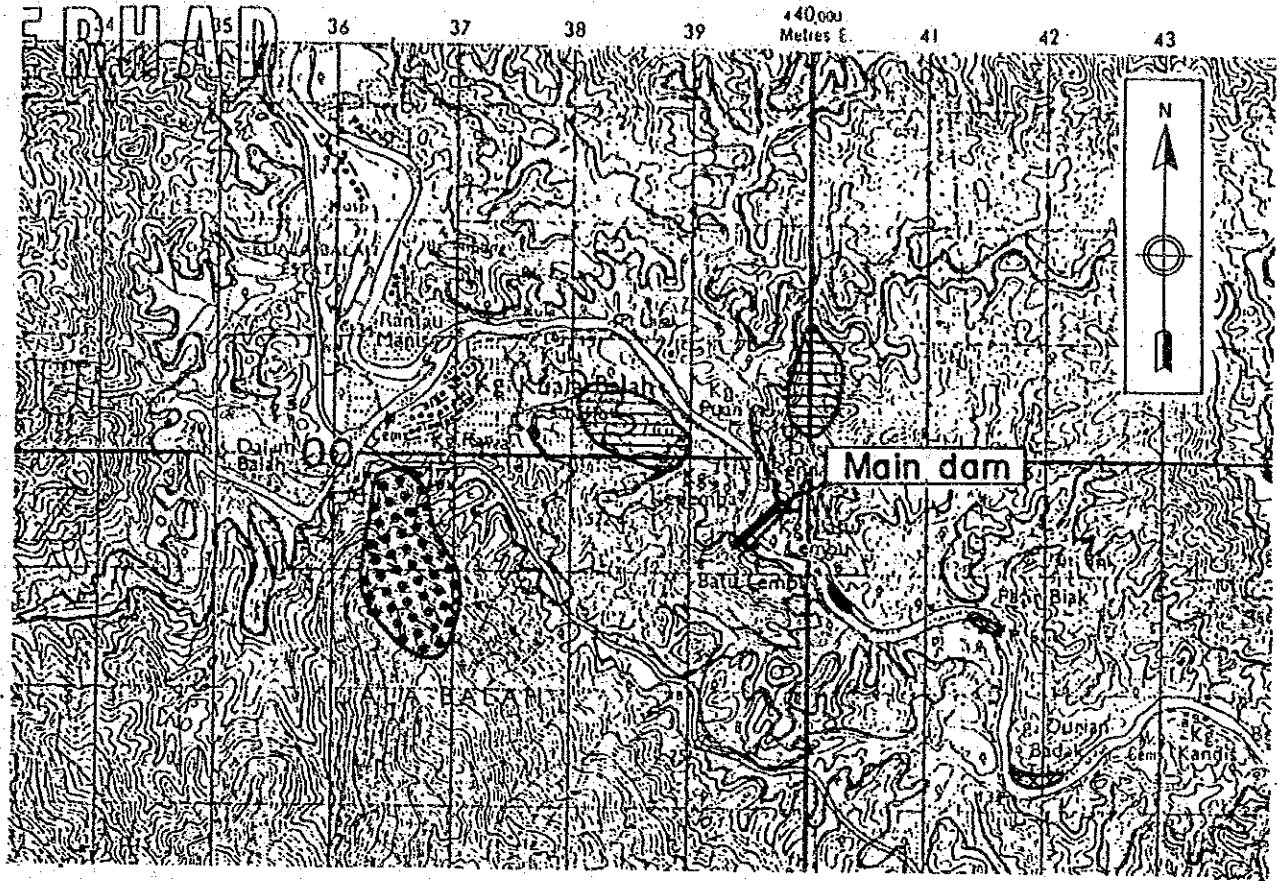

LEGEND

-  Damsite
-  Borrow Site
(Core material)
-  Borrow Site
(filter, Sand material)
-  Quarry Site
(rock material
concrete aggregate)

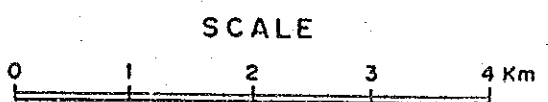

GOVERNMENT OF MALAYSIA
STUDY
 ON
 KELANTAN RIVER BASIN - WIDE FLOOD MITIGATION
 JAPAN INTERNATIONAL COOPERATION AGENCY

図 3.21 ローアープルガウダムの位置図