

Specification

Section 1. General Specification

Technical Specification

Section 2. Earthwork

Section 3. Concrete Works

Section 4. Land Consolidation Works

Section 5. Farm Road Works

Section 6. Irrigation Pipeline Works

Section 7. Drainage Canal works

Appendix A. Guideline for Construction Control

Specification

Section 1. General Specification

1.1 Scope of works

The Experiment Farm Construction Project is located in the Institute of Postgraduate Studies in Agriculture (IPSA) Campus, SALNA. The extent of farm area is shown on the Drawings and total area is 8.0 ha.

The works to be carried out by the Contractor under the Contract will include:

- (1) Land consolidation work for experimental farm of 8.0 ha.
- (2) Construction of irrigation facilities
 - (i) Main pipeline VP ϕ 150 m/m L=1,025 m
 - (ii) Secondary pipeline VP ϕ 75 m/m L=887 m
 - (iii) Hydrant 48 places
- (3) Construction of farm roads
 - (i) Main road (width 7.0 m) L=370 m
 - (ii) Secondary road (width 4.0 m) L=1,845 m
- (4) Construction of drainage canals
 - (i) Farm ditch L=1,025 m
 - (ii) Drainage Pipe culvert 8 places

The Drawing shall be accurate and clear denoting the scope of works.

1.2 Work Schedule

The Contractor shall submit his work schedule before the commencement of the works at the job site. If the Contractor intends to change the work schedule, the approval from the Engineer shall be obtained prior to the modification of schedule.

Also the Contractor shall submit the machineries scheme including the numbers, and kind of machineries and using period of them.

1.3 Notices

The JICA and the Contractor shall submit the notices to each other, as necessary, in accordance with Article 11 in the Construction Contract Document within reasonable time except that special articles are provided in Construction Contract Document and Specification of this Contract.

1.4 Field Test and Inspection

The field tests in accordance with the Technical specifications and the demands from the Engineer shall be the responsibility for the Contractor. The charges for such field test shall be included in the total amount of the construction cost, and the Contractor is not entitled to claim any amount of the field test charges.

1.5 Modification of Plan

In case the JICA estimates the cost for the modification in accordance with Article 12, and if there are two portions, one for the increase and the other for the decrease of the construction cost resulting from such modification, the JICA shall have the right to offset them in the payment and pay or claim the difference between the increase of the construction cost as the case may be.

1.6 Release from the Works

After the final acceptance of the works by the JICA, the Contractor shall remove its own temporary facilities, office, warehouses, surplus material, debris and so forth which were provided by itself within 15 (fifteen) days. Upon approval of the Engineer for the removal of the above-mentioned facilities etc. The Contractor will be released from its responsibility of the works but remains responsible under six (6) months guarantee of the works as specified in Article 18 in this Construction Contract Document.

1.7 General Obligations of the Contractor

(1) Temporary office and residence

In case the Contractor intends to build the temporary office, residence and so forth, the Contractor shall submit the plan to the Engineer for approval at least 10 (ten) days in advance of the commencement of such works.

The Contractor is required to always keep the buildings and facilities in good condition and to make proper drainage and sanitary system. Should the Contractor build them outside of the job site, the Contractor shall arrange with the owner of such land and at its own expense.

(2) Fuel storage

In area of temporary office and residence, the fuel tank capacity shall not exceed 1,000 litres and shall be far away from the buildings.

Fuel storage and transportation shall be done with care and shall have a good system of fire prevention. If storage license is required, the Contractor shall arrange for obtaining it.

(3) Other facilities

All necessary facilities for the construction works and the Contractor's convenience shall be provided and maintained in good condition by the Contractor.

(4) Transportation

The Contractor shall make transportation of materials, equipment, earth and the rail in the campus and on the public roads carefully, and if necessary of in case the Engineer indicates, shall arrange the traffic control staff at the indicated points.

1.8 General text

The Contractor shall implement the works in accordance with the Contract Documents in broad sense such as construction Contract Document in narrow sense, General Specification, Technical Specification and Guideline for Supervision. Should the events occur that the both parties can not reach agreement on the interpretation of the above-mentioned Contract Documents

in broad sense, both parties shall negotiate with sincerity and good faith for settlement of any disagreement, failing which the decision of the JICA shall prevail.

Section 2. Earthwork

2.1 General

This Section deals with matters common to earthwork for respective works. Any and all earthwork shall conform to the stipulations set forth in this section unless otherwise specified therein. The term of "earthwork" will mean and include all classes of grading, leveling, ditching, earthmoving, all other excavation backfill and banking construction work.

All earthwork shall be performed accurately to the lines, grades and dimensions as shown on the Drawings or as directed by the Engineer. The Contractor shall furnish all labours, materials, equipment and supplies and perform all operations in connection with excavation, trimming, construction of embankment, excavation and backfilling around structures, and all incidental grading, subject to the terms and conditions of the Contract and in strict accordance with these specifications and the applicable drawing.

2.2 Land Clearing

(1) The Contractor shall clear the land including the rough levelling of existing boundary borders, trees, stumps, anthills and so forth.

(2) The abandoned materials above-mentioned such as trees and stumps which are taken out shall be brought to the places where the Engineer indicates, then burnt and destroyed.

2.3 Classification of Excavation

(1) Rock excavation

Rock excavation includes all solid rock in place which can not be removed smoothly by such excavating machinery such as a bulldozer, power shovel or scraper until loosened by blasting or wedging. All boulders or detached pieces of solid rock less than one cubic meter in volume shall not be recognized as rock.

(2) Common excavation

Common excavation includes all materials other than rock including, but not restricted to, earth, gravel, and soft or disintegrated rock which can be treated efficiently either by hand tools or excavating machinery as mentioned above.

2.4 Excavation Line

The Contractor shall remove from the excavation line all loosened rock, fractured rock and/or loosened materials which may slide. Any over excavation shall be filled with suitable compacted material, and shall be tamped or rolled with suitable tools and equipment to form a firm foundation for the structures. Excess excavation below the foundation of a concrete structure shall be filled with suitable concrete or compacted materials approved by the Engineer.

2.5 Disposal of Excavated Material

Excavated materials may be used for backfilling and/or embarking unless otherwise specified or directed by the Engineer. Excavated material in excess of requirements, shall be disposed of in the disposal area appointed by the Engineer. Waste material shall be piled by taking sufficient measures to avoid injury or damage to adjacent area and properties.

2.6 Excavation for Structures

The Contractor shall perform the required excavation for construction of structures. On excavation work, the Contractor shall exercise care and precaution for safety to the satisfaction of the Engineer. Especially, in case of deep excavation, sheathing or retaining shall be made. Sliding or falling of the slope shall be repaired immediately by the Contractor at his own expense. The Contractor shall be held entirely responsible for accidents. Approval by the Engineer of the excavation method and safety shall not relieve the Contractor of his responsibility.

Excavation for the foundation of concrete structure shall be to the elevations as shown on the Drawings or as directed by the Engineer. The Contractor shall prepare the foundations for the concrete structure by methods which will make firm foundations for the concrete structure. The bottom end side slopes of earth excavation upon or against which concrete is to be placed,

shall be finished by hand to the directed dimensions and with suitable tools to form firm foundations.

Surface against which concrete is to be placed shall be cleaned of all loose and objectionable materials by means of brooming, high velocity air or air and water jets, or by other approved means. Prior to placing concrete, the prepared surfaces shall be inspected by the Engineer.

If the foundation material is excavated beyond the lines required to receive the structure, the over-excavation shall be filled with suitable materials and compacted in accordance with the requirements of Paragraph 2.7 (3). If the natural foundation material is disturbed or loosened during the excavation process or otherwise, it shall be compacted in place or, where directed it shall be removed and replaced with suitable material and compacted in accordance with the requirements of Paragraph 2.7 (3). Any and all excess excavation conducted by the Contractor for any purpose or reason except for additional excavation as may be directed by the Engineer, shall be at the expense of the Contractor. Fill and compacting of fill for such excess excavation or over-excavation, shall be at the sole expense of the Contractor.

Where concrete is to be placed directly upon or against rock, the excavation shall be sufficient to provide for the minimum thickness of concrete at all points. This minimum thickness shall be maintained as much as practicable. All loose or shattered rock shall be removed. Any over-excavation shall be filled completely with concrete at the expense of the Contractor, including the cost of all work and materials required.

2.7 Backfill and Banking

(1) Insofar as practicable backfill and banking material shall be obtained from material removed in excavating, but when sufficient suitable material is not available from this source, additional material shall be obtained from approved borrow pits. Materials used for backfill or banking shall not include rocks, boulders, large roots and other organic matter. Materials which are excessively moist shall not be used directly for banking and backfill.

Where the ground surface under the banking is not suitable, as determined by the Engineer, for a foundation for the banking, the Contractor

shall strip the area under the banking of such unsuitable material to such depth as may be directed.

(2) Backfill and Banking

The Contractor shall undertake the work, providing measures for draining lest runoff and leakage water should be stored in the surface of land.

Extra banking is not given on the Drawing. Nevertheless, it shall be taken as 10% of the depth or height of backfill or banking unless specified. The quantities of the extra banking shall not be calculated as quantities of work for which payments will be made. The costs required for the extra banking shall be included in the unit price of banking and/or backfill.

(3) Compacting

Before the material for the first layer of the banking is placed, the foundation of the banking shall be prepared and provided in 2.2 and shall be moistened and compacted in the manner hereinafter specified for each layer of compacted banking to be placed thereon. The banking including extra banking shall be compacted to the elevation and to the top widths and side slopes.

Where compacting of earth materials as required, the materials shall be deposited in horizontal layers and compacted as specified in this Paragraph. The distribution of materials shall be such that the compacted material will be homogeneous and free from lenses, pockets, breaks, or other imperfections.

The Contractor's operations in the excavation of materials for the compacted banking shall be such as will result in an acceptable gradation of materials to provide for impermeability and stability after being compacted. The maximum dimensions of stones placed in the compacted banking shall not exceed 0.12 metre, and should stones larger than 0.12 metre be found in otherwise approved material, these materials shall be removed the Contractor before the commencement of compacting operation. This Paragraph shall also apply where sloping walls or slabs are to be placed directly on earth foundations without intervening forms, and where compacted banking is required in the bottom of the structures.

In the place specified by the Specifications, compaction shall be made by utilization of earth material containing an appropriate mixture of clay

or silt. Prior to the commencement of the work stated hereinabove, the Contractor shall obtain the approval of the Engineer concerning the following items:

- The capacity of compacting machinery
- The thickness of the horizontal layer
- Method of Compacting
- Reports of the compaction tests which were conducted in compliance with instruction(s) from the Engineer, if any

The excavation and placing operations shall be such that the materials when compacted will be sufficiently bound to secure the best practicable degree of compaction, impermeability, and stability. The dry density of the soil fraction in the compacted material shall in no case be less than 85 percent of the laboratory standard maximum dry soil density as determined for the materials being compacted. Insofar as practicable, and as determined by the Engineer, moistening of the material shall be supplemented by sprinkling at the site of compaction if necessary and mixing by such equipment as disc harrows.

If the moisture content is less than optimum for compaction, the compaction operations shall not proceed, except with the specified approval of the Engineer, and if the moisture content is greater than optimum for compaction, the compaction operations shall be delayed until such time as the material has dried to the optimum moisture content. No adjustment in price will be made on account of any operation of the Contractor in drying the materials or on account of delays occasioned thereby.

Section 3. Concrete Works

3.1 General

All concrete works shall be performed as established on the Drawing or directed by the Engineer. Unless specifically provided in this specification, the concrete shall be produced, transported, placed, cured, finished and tested in accordance with the ASTM or JIS provisions.

3.2 Materials

(1) Cement

- (i) Cement used in Concrete mixture shall be normal portland cement, properties of which shall be in accordance with ASTM-C150 or JIS-T5210.
- (ii) Cement shall be reliable brand, good quality and absolutely dry.
- (iii) The Contractor shall construct a water-proof cement storage shed at the job site, floor of which shall be higher than the ground surface at least 30 (thirty) cm.
- (iv) The Contractor shall not keep cement at the job site more than 1 (one) month, and the storage period is counted from the date when the cement is transported from the manufacturing factory to the job site.
- (v) During the course of construction, the Contractor shall not use cement for the works properties of which are changed, especially consolidated.

(2) Fine aggregate

- (i) Fine aggregate shall be river sand that is clean and rigid without organic matter and other substance.

Fine aggregate shall have the properties as shown in following table.

No.	Experimentation	Allowance Index	Remarks
1.	grading	95% of material shall pass through the sieve No. 4 and 90% of material shall not pass through the sieve No. 100	by weight
2.	dust passed through the sieve No. 200	not exceeding 3%	
3.	finess Modulus	not less than 2.3 not more than 3.1	
4.	organic unpurity (Tested by the method of Soldium hydroxide 30% type)	the color of the material after the experiment shall show paler than the standard color No. 3	
5.	very mild material ASTM C-142	not exceeding 1%	by weight

(ii) The Contractor shall keep fine aggregate at clean and good drainage place, which shall be protect against the mixture with harmful substance such as clay, soil and so on.

(3) Coarse aggregate

(i) The Contractor shall use crushed stone as coarse aggregate which is rigid and endurable substance without organic and harmful materials.

(ii) Coarse aggregate shall have the grading as shown in the following table.

Sieve Size	Passing Percent by Weight
2"	100
1-1/2"	90 - 100
1"	20 - 55
3/4"	0 - 15
3/8"	0 - 5

(iii) Coarse aggregate shall have the properties as shown in following table:

No.	Experimentation	Allowance Index	Remarks
1.	Dust passed through the sieve No. 200	not exceeding 1.5 Y	by weight
2.	Very mild material (ASTM C-142)	not exceeding 0.25%	by weight
3.	Other mild material	not exceeding 5.0 Y	by weight
4.	Stability test method	lost part shall not exceeding 12% of total weight	solphate sulphate method
5.	Abrasion	lost part shall not exceed 40 Y of total weight	By Los-Angeles Abrasion Test method

(4) Water

Water used concrete mixture shall not contain harmful substances such as oil, acid, salt and so on. Should the Engineer thinks that water used for the concrete mixture is harmful, the Contractor shall inspect the water as following way; the Contractor makes two kinds of cylindrical mortar test pieces one used actual field water that the Contractor will used, another used standard water that the Engineer specifies. In case the compression strength of former is larger than 90 (ninety) percent of the latter at 7th (seven) day and 28th (twenty-eight) day after making test pieces the Contractor may use the

actual field water. If not, the Contractor shall look for another water source by the Contractor's responsibility.

3.3 Mixing Design of Concrete

Concrete shall have the proportion as follows:

	Compressive Strength 28 days	Mixing portion Cement: Fine A: Coarse A	Slump Test
Reinforce concrete	$f_c = 210 \text{ kg/cm}^2$	1 : 2 : 3 (by volume)	8 - 12 cm
Plain concrete	$f_c = 180 \text{ kg/cm}^2$	1 : 2 : 3 (by volume)	8 - 12 cm
Lean concrete	-	1 : 4 : 6 (by volume)	-

Fine A : fine aggregate
Coarse A : coarse aggregate

Other proportions for mixed design may be indicated by the Engineer at the job site, if it is necessary.

3.4 Slump Test

The Contractor shall make slump test in each batch in accordance with JIS 1101. In case the Contractor intends to place concrete, the Contractor shall not pour the concrete without prior inspection for the value of slump test by the Engineer. After the completion of the concrete Works, the Contractor shall submit the data of slump test to the Engineer.

3.5 Mixing the Concrete

The Contractor shall use a power-driven concrete mixer and quantities of cement, aggregate and water in concrete mixture shall be measured correctly in each time. The driving time for mixing concrete shall be more than 2 (two) minutes and less than 5 (five) minutes in order to make concrete with constant consistency and good quality. Take out from the concrete mixer, concrete shall be placed in the form within 30 (thirty) minutes. The concrete

mixer shall be checked and cleaned every day and the Contractor shall remove concrete debris attached the concrete mixer.

3.6 Concrete Form Work

(1) Concrete form shall be rigid and strong enough to support the weight of concrete without deformation, and the Contractor shall make concrete form tightly in order to prevent water seepage from unsolid concrete.

(2) The Contractor may use wood form, plywood form and steel form, in any case surface of form shall be smooth and have no damage.

(3) In case the Contractor set up concrete form, the iron embedded within concrete to hold the form shall be cut at concrete surface.

(4) Before placing concrete, concrete form shall be inspected by the Engineer for correctness of size, good preparation and so on.

(5) Before placing concrete, the Contractor shall paint oil on inner side of concrete form for good separation between concrete and concrete form after solidness of concrete.

3.7 Placing Concrete

(1) Before placing concrete, the Contractor shall check and clean and floor and the surface of concrete form.

(2) After a batch of concrete is placed, the surface height of concrete in concrete form shall have same height in a block, and the height of placed concrete layer shall be less than 40 (forty) cm. in each placing.

(3) The Contractor shall place concrete continuously into a block of structure such as wall, slab and so on.

(4) In case the new concrete is placed on solid concrete, the Contractor shall take out laitance, loose aggregate, low quality concrete on the surface of solid concrete.

3.8 Compaction of Concrete

After placing concrete, the contractor shall compact concrete by using immersion type vibrator. Should the Contractor intends to use another type of vibrator, the Contractor shall obtain the prior permission of the engineer.

3.9 Curing

The Contractor shall cure concrete completely with water. If the Contractor intends to use curing chemical, the Contractor shall obtain the prior permission of the Engineer.

3.10 Reinforcement

(1) Material

Reinforcement which is used in reinforce concrete works shall be round bar or deformed bar in accordance with ASTM designation A-7-55 and A-141-55 or JIS G 3112, also it shall be good quality and never using before.

(2) Shaping steel bar

- (i) The Contractor shall shape make shape of steel bar in accordance with the drawings without heat. Should the contractor heat material to make shape, the Contractor shall obtain the prior permission of the Engineer.
- (ii) The Contractor shall steel bar before assembling it and in case steel bar is bent for making hook and corner, the Contractor shall bend as follow:

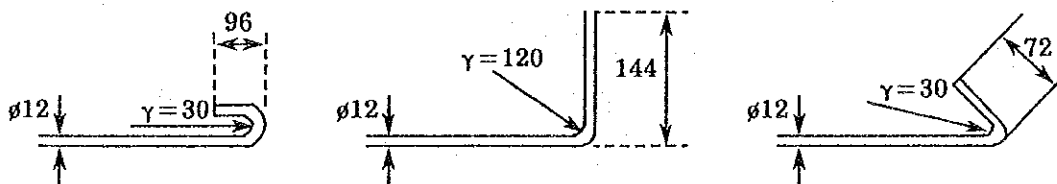

(3) Assembling steel bar

- (i) Steel bar shall be connected in order not to move by wire not less than 2 rounds.
- (ii) In case the Contractor set steel bar, it shall be supported by spacer that is made from mortar and its specification is as follows:

ratio Cement : sand = 1 : 1

- thickness
- 1) In case bottom of structure, thickness is not less than 8 (eight) cm, from ground surface to the steel bar.
 - 2) In case side of structure, thickness is not 5 (five) cm. from concrete surface to steel bar.

(4) Overlapping steel bar

In case that two straight steel bars are connected, the Contractor shall use wire for connection and bind the steel bars at several places, especially in case tensile stress functions on steel bars, two steel bars shall overlap each other as follows:

$$l = \frac{\sigma_{sa}}{4 \tau_{oa}} \phi$$

- where
- l = length of overlapping
 - σ_{sa} = tensile strength of steel bar
 - τ_{oa} = Cohesive strength between concrete and steel bar
 - ϕ = diameter of steel bar

Section 4. Land Consolidation Work

4.1 Scope

The work under this Section shall consist of clearing and grubbing and grading works, all in accordance with the Drawing and these specifications or as directed by the Engineer.

4.2 Work Preparation

Prior to the work, the planned area shall be isolated from outside drainage to prevent the water coming in. During the work, surface water in the planned area shall be removed as much as practicable.

4.3 Clearing and Grubbing Work

(1) The Contractor shall conform the boundary of work area in attendance of the Engineer before the commencement of work and shall place boundary posts, if necessary.

(2) Clearing and grubbing work shall conform to the requirements specified under Section 2.2.

4.4 Cutting and Banking

(1) Primary cutting and banking shall be made within the planned area as a rule.

(2) Cutting and banking work shall conform to the requirements specified under Section 2.6 and 2.7.

(3) Slope surface shall be finished evenly with the grade given in the Drawings.

(4) In case of over-excavation, the Contractor shall dispose according to the instruction of the Engineer. Its cost shall be borne by the Contractor.

(5) If natural crumbling, landslide, etc. occur or threaten to occur during cutting work, the Contractor shall execute the work in consultation with the Engineer.

Section 5. Farm Road Works

5.1 Scope

The scope under this Section shall cover the construction of Farm roads consisting of Main and Secondary roads. The work shall include grubbing, clearing, sodding, embankment and excavation, all in accordance with the Drawings and these specification, or as directed by the Engineer.

5.2 Earthwork

The earthwork needed for construction of the roads shall be conducted according to the applicable provisions of Section 2.

5.3 Earth Materials

The farm road base shall be formed with those earth materials as surplus in excavation of ditch, when those materials are appropriate or equivalent in quality to those found in borrow pits.

5.4 Compaction

The base of the embankment shall be compacted with road roller and thickness of one compaction shall be about 30 cm in spread. During compaction, water shall be sprinkled for keeping optimum moisture content of the materials.

5.5 Slope Protection

Finishing work of slopes shall be made by compacted with hand rammer and sodding for protection of slopes from erosion.

Section 6. Irrigation Pipeline Works

6.1 Scope

This Section deals with matters of irrigation pipeline. The pipeline is composed of the main and secondary pipeline. All pipe, fittings and appurtenances shall be supplied by the Contractor.

The Contractor shall furnish and transport materials, equipment and supplies needed for the construction of these pipelines abovementioned and

perform installation and testing of them at the site in accordance with Specifications and Drawings.

6.2 Pipes

The pipe shall be polyvinyl chloride pipes (PVC pipes) and conform to JIS K6741 class VP, unless otherwise noted. The pipe shall be suitable for field cutting and jointing.

6.3 Installation

(1) Excavation of trench

The section of excavation for laying pipes are shown on the Drawings. The excavation of trenches shall be made in accordance with specification described in Section 2. Additional costs for the excavation exceed the limits and backfill to such sections other than by direction of the Engineer shall be borne by the Contractor.

(2) Pipe bedding

The Contractor shall make pipe beds for pipelines as shown on the Drawings.

The bedding material shall be carefully placed on the bottom of the prepared trench, hand tamped and shaped to fit the lower portion of the pipe conduit barrel. Care shall be taken to ensure that the pipe will be uniformly supported on the bedding material.

(3) Pipe joints

Joints for pipe shall be taper sized solvent welding method, and shall construction the jointing in accordance with the manufacture's technical instruction. In making connections, clean dirt, moisture and oil from pipe and fittings. Particular care shall be taken not to overstress threaded connections at joint.

(4) Pipe cutting

When cuts are necessary, they shall be perpendicular to the axis of the pipe and smooth. Cut shall be made with tools in conformity with the pipe manufacture's recommendations.

(5) Appurtenant equipment

Such as sluice valves and air valves shall be carried out in accordance with the manufacture's instruction.

(6) Protection device

Such as concrete thrust block or locking device shall be done in accordance with the Drawings.

Section 7. Drainage Canal Works

7.1 Scope

The scope under this Section shall consist of excavation of drainage canals and construction of necessary structures.

7.2 Earthwork

Earthwork for drainage canals shall be in accordance with Section 2.

7.3 Curvert

Where shown on the Drawings or as directed by the Engineer, reinforced concrete pipes should be laid. Inlet and outlet structures shall be constructed at the ends of the pipeline as shown on the Drawings or as directed by the Engineer. Pipe installation shall comply with the applicable provisions of Paragraph 6.3 (Section 6). Concrete works shall comply with the Section 3.

Appendix A. Guideline for Construction Control

1. Objective

During the course of construction the Contractor shall implement the works according to the Technical Specifications, drawings and so on, however, it is very difficult to control the quality and quantity exactly from the technical point of view. So the Engineer determines the range of allowable error, and the Contractor shall control quality and quantity within this range of allowable error.

2. Method

For the dimensions of the works such as length, width, thickness of the facility, the Contractor shall measure them at the completion of the Works, write the dimensions on the drawings by red ink and submit them to the Engineer. Should the dimensions of the facility are out of the range of allowable error, the Contractor shall rebuild for correct dimensions. For the quality control such as slump test, field density of compacted earth and so on, the Contractor shall get the data during course of construction and submit them to the Engineer. The Contractor shall not use the material of not good quality out of the range of allowable error.

1. Guideline for Measurements

Description	Item	Range of allowable error (mm)	Guideline		
			Measurement Section	by result table	Written on the drawing with red ink
Earth work	Elevation	± 50	one section every 60 m Length Elevations at Center and both edges.		actual dimensions are written on the drawings.
	Width B, B ₁ , B ₂	± 100			
		Bank Cut - 100 - 200			
Concrete foundation	Elevation El.	± 30	one section every 40 m in case the length of a block is not more than 40 m, 2 Sections a block.	Elevation, Width, Height, Length are written in a table.	actual dimensions are written on the drawings.
	Width w.	- 30			
	Height h.	- 30			
	Length L.	- 200			
Concrete pipe	Elevation	± 30	2 Section a block in case the length of a block is not less than 40 m.	Elevation, Width, Height, Length are written in a table.	actual dimensions are written on the drawings.
	Width a.	- 50			
	Height n.	- 30			
	Length L.	- 200			
Land levelling	Elevation	± 50 more than 75% of total points shall be in the range of ± 40 mm	Elevation at 14 points shall be measured in the soil bin as specified in this remarks.	* Table contains design dimension and difference between them. actual elevations are written on the drawing which will be made by the Contractor at the scale of 1-100.	
Water supply pipe	error of center line in straight	50	One section every 20 m. length in case their length not more than 20 m 2 sections		actual dimensions are written on drawings.
	error of center line in curve elevation	100			
		± 30			

2. Guideline for Quality control

Description	Work	Item	Test item	Guideline
Concrete	Concrete		Compressive strength (plain and reinforced concrete).	Designed strength is specified in the Technical Specifications. Probability that the strength of test pieces does not reach at 80% of the designed strength, shall not more than 5%. And probability that the strength of test pieces does not reach to the designed strength shall not be more than 25%.

3. Standard Test
1) Concrete

Description	Testing item	Guideline		Remarks
		Method	Guideline for testing	
Material	1. specific gravity test for aggregate	JIS A 1109 JIS A 1110	The Contractor shall test once for each 300 m ³ required volume. If the Contractor use it from different sources, the Contractor shall test once for each sources.	
	2. absorption test for aggregate	JIS A 1109 JIS A 1110	If necessary, the Inspection Committee will indicate.	
	3. grading test for aggregate	JIS A 1102	The contractor shall test once for each 300 m ³ required volume of fine aggregate 50 m ³ .	
	4. physical test for cement	JIS R 5201	Required volume of coarse aggregate. It the Contractor use it from different source, the Contractor shall test once for each source.	
	5. chemical test for cement	JIS R 5202	If necessary, the Inspection Committee will indicate.	
	6. abrasion test for coarse aggregate	JIS A 1120 JIS A 1121		
	7. harmful material test for aggregate	JIS A 1126	If necessary, the Inspection Committee will indicate.	

Description	Testing item	Method	Guideline		Remarks
			Method	Guideline for testing	
Concrete work	1. slump test	JISA 1101	It is shown in the Technical Specifications.		
	2. surface water content test for aggregate	JISA 1111	If necessary, the Inspection Committee will indicate.		
		JISA 1116			
		JISA 1117 JISA 1118			
	4. compressive strength of concrete	JISA 1108	The Inspection Committee will indicate number, time, batch and so on for making test pieces.		
5. bending strength of concrete	JISA 1106				

2) Embankment

Description	Testing item	Guideline		Remarks
		Method	Guideline for testing	
Material	1. specific gravity test	JIS A 1202	The Contractor shall take samples each 5,000 m ³ required volume and test in principle, if the Contractor use it from different source, the Contractor shall take samples and test once for each different source.	The Contractor shall take at least 3 samples for a point.
	2. grading test	JIS A 1204		
	3. liquid limit test	JIS A 1205		
	4. plastic limit test	JIS A 1206		
	5. compaction test	JIS A 1210 ASTM D 698-66 T		
Embankment work	1. water content test	JIS A 1203	According to the day working schedule, the Contractor shall take at least 3 samples in the expected job area, in the morning and in the afternoon and test the soil.	The workable range of water content will be shown by the Inspection Committee.
	2. field density test	JIS A 1214	In case of road, the Contractor shall test field density at center and both edges of each layer of road every 50 m length. In case of plot boarder and dike, the Contractor shall test field density at center of them every 100 m length. If the length is not more than 100 m, the Contractor shall test field density twice for each structure.	

7-4 工事申請書 (案)

昭和 年 月 日

国際協力事業団

総裁 殿

事務所長

氏名 印

下記によりモデルインフラ整備費の支給を申請する。

- (1) プロジェクト名 バングラデシュ農業大学院計画
- (2) 工 事 名 I P S A 試験圃場造成工事
- (3) 概算工事費 23,800千円 (積算内訳別添 参照)
- (4) 工事内容
 - A) 工事概要 8.0ha の試験圃場 (畑 6.0ha, 果樹園 2.0ha) の造成と、これにともなう農道及び用排水施設の建設を行う。
 - B) 主要工事数量
 - i) 圃場整地 圃 場 面 積 : 8.0ha
造成掘削土量 : 26,400^m₃
 - ii) 道路工 幹 線 道 路 : 全巾7.0^m, 延長 370m
支 線 道 路 : 全巾4.0^m, 延長1,845m
 - iii) 用水施設 幹線用水路 : 口径φ150 m/m, 延長1,025m
支線用水路 : 口径φ 75 m/m, 延長 887m
給 水 栓 : 48ヶ所
 - iv) 排水施設 圃場内排水路 : 1,025m
横断暗渠工 : 8ヶ所

C) 工期

昭和 年 月 日 ~ 昭和 年 月 日

(5) 申請の事由

7-5 工事施工業者

バングラデシュ国で比較的大きい規模の施工業者はつぎのとおりである。

(1) 土木・建築関係

a) CONCORD ENGINEERS & CONSTRUCTION LTD,
ENGINEERS & BUILDERS
43, NORTH COMMERCIAL AREA, GULSHAN, DHAKA-12
BANGLADESH
PHONE : -601700, 606688.

b) RANA CONSTRUCTION LTD.
ROAD-14A, HOUSE NO-33,
DHANMANDI RA. DHAKA-9, BANGLADESH.
PHONE : -311689, 319610.

c) GEOCON LTD.
ENGINEERS, CONTRACTORS
6, MOTIJHEEL C/A, DHAKA-2, BANGLADESH
PHONE : -232366, 238770

d) GREEN ENGINEER LTD,
60/C PURANAPALTAN
DHAKA-2, BANGLADESH
PHONE : -316962, 238505.

e) FAZLE AZIM ENGINEERS LTD.
B-65, MALIBAGH CHOWDHURY PARA,
DIT ROAD, DHAKA-19
PHONE : -405345, 412746.

(2) 電気・機械・管工事関係

a) SUPERIOR BUILDERS AND ENGINEERS LTD.
30, PURANA PALTAN LINE (GROUND FLOOR)
DHAKA-2, BANGLADESH.
PHONE : -413213, 411872

b) TECHNICAL CONCERN LTD.
326, DHANMANDI RA. ROAD-27
DHAKA-9, BANGLADESHU.
PHONE : -311348, 318541.

以上のうち、CONCORD ENGINEERS & CONSTRUCTION LTD. 及びFAZLE AZIM ENGINEERS LTD. は三井建設の下でIPSAの工事の経験をもっており、CONCORD は現在進行中の工事で約100億円に達している。なお、FAZLE AZIMは他よりやや小規模な会社である。

第8章 付 属 資 料

第8章 付 属 資 料

8-1 調査団の構成

調査団の構成は以下のとおりである。

- | | | |
|-------------|-------|-------------------------------|
| (1) 団長 (総括) | 大村 武 | 九州大学農学部教授 |
| (2) 業務調整 | 渡辺 健 | 国際協力事業団
農業開発協力部
農業技術協力課 |
| (3) 圃場設計 | 後藤 兵作 | 太陽コンサルタンツ㈱
技術顧問 |
| (4) 灌漑排水設計 | 岩井 功 | 太陽コンサルタンツ㈱
海外事業本部 技術部長 |

8-2 調査日程

調査日程は以下のとおりである。

月・日 (曜)	旅 程	行 程 動
2. 18 (土)	東京ーバンコク (TG-641)	移 動
2. 19 (日)	バンコクーダッカ (TG-321)	移 動 調査日程打合せ・プロジェクト現状聴取
2. 20 (月)		表敬：計画省、対外資源部、計画委員会 IPSA 在バングラデシュ日本大使館 JICAバングラデシュ事務所
2. 21 (火)		日本人専門家と協議
2. 22 (水)		IPSAスタッフと打合せ 現地調査
2. 23 (木)		現地調査 BARI, BRRI の施設視察
2. 24 (金)		現地調査
2. 25 (土)		IPSAスタッフ・日本人専門家と協議
2. 26 (日)		IPSAスタッフ・計画委員会スタッフ・日本人専門家と協議
2. 27 (月)		基本計画・団長レター作成 現地調査

月・日(曜)	旅 程	行 動
2. 28 (火)		表敬：農業省次官 団長レター提出
3. 1 (水)		調査報告：在バングラデシュ日本大使館 JICAバングラデシュ事務所
3. 2 (木)	ダッカーバンコク (TG-322)	大村・渡辺団員 移動 後藤・岩井団員 地形測量
3. 3 (金)	バンコクーダッカ	大村・渡辺団員 移動 後藤・岩井団員 地形測量
3. 4 (土)		地形測量 IPSAの土地利用状況調査
3. 5 (日)		地形測量 IPSAの土地利用状況調査
3. 6 (月)		地形測量 排水流域の調査
3. 7 (火)		地形測量 IPSA構内及び周辺の排水状況調査
3. 8 (水)		地形測量 BARIにて気象資料の収集
3. 9 (木)		地形測量 ダッカにて気象資料の収集
3. 10 (金)		収集資料の整理 測量の内業
3. 11 (土)		地形測量 深井戸の揚水試験
3. 12 (日)		地形測量 深井戸の揚水試験
3. 13 (月)		地形測量及び土壌調査 機材及び単価調査
3. 14 (火)		土壌調査 機材及び単価調査
3. 15 (水)		土壌調査 単価の調査

月・日(曜)	旅 程	行 動
3. 16 (木)		測量の図化 単価の調査
3. 17 (金)		収集資料の整理 測量の図化
3. 18 (土)		測量の図化 I P S Aと圃場計画について打合せ
3. 19 (日)		圃場造成工概略設計 単価の調査
3. 20 (月)		圃場造成工概略設計 I P S A担当者と圃場計画及び単価等について打合せ
3. 21 (火)		圃場造成工概略設計 施工業者の調査
3. 22 (水)		施設の概略設計 概算工事費の算出
3. 23 (木)		現地報告書の作成
3. 24 (金)		現地報告書の作成
3. 25 (土)		I P S A所長へ現地報告書提出
3. 26 (日)		J I C A事務所に現地報告書の説明
3. 27 (月)		I P S Aに帰国あいさつ
3. 28 (火)	ダッカーバンコク (TG322)	移動
3. 29 (水)	バンコクー東京 (TG740)	移動

8-3 主要面会者リスト

(1) バングラデシュ側

イ. 計画省

対外資源課	次官補	Mr. Md. Nashim
計画委員会	メンバー	Dr. S. M. Hasanuzzaman
	農業担当部長	Dr. Altaf Ali

ロ. 農業省

次官	Mr. M. A. Syed
次官補	Mr. Abul Hashem
総務	Mr. Ai Waheed Khan

ハ. IP SA

学長	Dr. S. H. Khan
助教授	Dr. Abdul Hamid
助手	Dr. A. Aruadra Bhownick
助手	Dr. M. A. Quadir
助手	Dr. Jamil Haider
技術者	Mr. M. Haque

(2) 日本側

イ. 在バングラデシュ日本大使館

井口大使
保母一等書記官
野田二等書記官

ロ. JICAバングラデシュ事務所

松沢 憲夫 所長
梅崎 裕 所員

ハ. プロジェクト日本人専門家

山田 芳雄 チームリーダー
隆杉 実夫 業務調整
大野 和郎 昆虫学
宮島 郁夫 園芸学

(3) その他

USAID 専門家 Dr. L. M. Eisgruber

JAPAN INTERNATIONAL COOPERATION AGENCY
(JICA)
DETAILED DESIGN SURVEY TEAM
FOR
THE INSTITUTE OF POSTGRADUATE STUDIES
IN AGRICULTURE PROJECT IN BANGLADESH

Feb. 28, 1989

Mr. M.A. Syed
Secretary,
Ministry of Agriculture (MOA)
the People's Republic of Bangladesh

Re: The Model Infrastructure Improvement Works
for the Institute of Postgraduate Studies
in Agriculture Project in Bangladesh

Dear Sir,

We, the Detailed Design Survey Team (hereinafter referred to as "The Team") has been organized by Japan International Cooperation Agency (hereinafter referred to as "JICA") for the purpose of promoting the Model Infrastructure Improvement Works which is as stipulated in the clause V of the Attached Document to "THE RECORD OF DISCUSSIONS BETWEEN THE JAPANESE IMPLEMENTATION SURVEY TEAM AND THE AUTHORITIES CONCERNED OF THE GOVERNMENT OF BANGLADESH ON THE JAPANESE TECHNICAL COOPERATION FOR THE INSTITUTE OF POSTGRADUATE STUDIES IN AGRICULTURE PROJECT IN BANGLADESH" signed on the 4th of July, 1985.

The Team has, so far, made a series of site reconnaissances and discussions with your staff concerned as well as Japanese Expert Team in order to determine the location, scale of the new experimental farm and its facilities. As a result of exchange of views and field surveys, we have a great honour of

submitting to you the Summary Report attached hereto. This Report presents the outline of the design of the new experimental farm.

In accordance with this report, two team members, Mr. Goto and Mr. Iwai, will proceed with your staff to conduct further field surveys and investigations at the site and make the detailed design on the basis of the result of those surveys. After the completion of the detailed design and assessment of its cost estimated by JICA, you will be informed of its result through the JICA Bangladesh office.

Further, for the timely commencement of the construction we would like to request you to take the necessary formalities in due consultation with the JICA Bangladesh office.

Finally, we would like to appreciate for the kind cooperation of your staff during our stay.

Sincerely Yours,

Dr. Takeshi OMURA

Team Leader

Detail Design Survey Team for the
Institute of Post-graduate Studies
in Agriculture Project in Bangladesh

- cc: 1. Dr. S.H. Hasanuzzaman, Member, Planning Commission, M.P.
2. Dr. Altaf Ali, Division Chief, Planning Commission M.P.
3. Mr. Md. Nasim, Deputy Secretary, External Resources Division, M.P.
4. Dr. S.H. Khan, Director, IPSA
5. Mrs. Prescilla Boughton, Mission Director, USAID Mission
6. Mr. Noda, Second Secretary, the Embassy of Japan in Bangladesh
7. Mr. N. Matsuzawa, Resident Representative, JICA Bangladesh Office
8. Dr. Y. Yamada, Team Leader, Japanese Expert Team

SUMMARY REPORT

I. INTRODUCTIONS

The Team has been dispatched in order to formulate a basic plan and a detailed design plan on the Model Infrastructure Improvement Works. Through a series of site reconnaissances and discussions with your staff concerned and Japanese Expert Team, basically, the Team recognized the necessity of the new experimental farm.

The Team has decided the basic plan as follows, based on the field reconnaissances. However, some of the items below may be changed after the detailed design survey and the subsequent study in Japan.

II. BASIC PLAN ON THE MODEL INFRASTRUCTURE IMPROVEMENT WORKS

(1) Location

The location of the new experimental farm is planned in consideration of following conditions.

- a) access from the project buildings
- b) advantage of construction cost
- c) relation to the existing experimental farm and its facilities
- d) condition of irrigation and drainage

Considering the above, the experimental farm is selected at the Northern and Eastern area of the existing experimental farm as shown in Fig.-1.

(2) Scale

The area of the new experimental farm will be about 8.0ha as shown in Fig.-2. The new experimental farm will consist of as follows.

- a) the field for rice and/or upland crops (6.0ha)
- b) the field for orchard (2.0ha)

(3) Components of The New Experimental Farm and its Facilities

Considering the relation to the existing experimental farm and its facilities, components of the new experimental farm is planned as shown in Fig.-2.

The new experimental farm will consist of the following facilities;

a) Irrigation system

Intake -- Irrigation water for the new experimental farm will be intaken from the existing deep well and reservoir by utilizing the existing deep well pump and booster pump.

Irrigation method-- Sprinkler irrigation system will be proposed for the new experimental farm. But this system will be also utilized for flood irrigation. The existing sprinkler sets will be utilized for the new experimental farm.

b) Drainage system

Drainage canal for the internal surface water will be planned in the center of the farm block.

Underdrainage system will be planned in 1 plot as a demonstration.

The pipe culverts will be designed to cross the roads.

c) Farm road

Main and secondary road will be designed to have access to the experimental farm.

The pavement of the farm road will not be planned in this Works.

d) Field

The farm block will be designed as one hectare (100m×100m) which is surrounded with the main and secondary roads. As for land leveling for the field, the surface of the field will be leveled in order to avoid soil erosion. The soil dressing will be planned in order to improve the poor soil.

III. OUTLINE OF THE SCHEDULE OF THE MODEL INFRASTRUCTURE IMPROVEMENT WORKS

The tentative schedule and procedures for the Model Infrastructure Improvement Works is as shown in the TABLE-1.

IV. MEASURES TO BE TAKEN BY THE BANGLADESH SIDE

- (1) The land for the new experimental farm will be provided by the Bangladesh side.
- (2) In accordance with the Project Proforma of Bangladesh, necessary manpower of IPISA (faculty staff, the other staff and temporary laborers)

should be assigned immediately for the smooth implementation of The Project and the efficient use of the experimental farm.

- (3) The pavement of the farm road will be constructed by the Bangladesh side soon after this Works finish.
- (4) Though the border fence will be an obstacle for this Works, that will be moved away by the Bangladesh side.

Fig-1 INSTITUTE OF POST-GRADUATE STUDIES IN AGRICULTURE
GENERAL PLAN

- LEGEND
- Experimental Field
 U - Upland Field
 O - Orchard Field
 P - Paddy Field
- Buildings
 ■ Existing Bldg.
 □ Proposed Bldg.
 ① Functional Bldg.
 ② College Bldg.
 ③ Hostel Bldg.
 ④ Workshop
 ⑤ Community Facilities
 ⑥ Residential Bldg. (Officer)
 ⑦ Residential Bldg. (Staff)
 ⑧ Residential Bldg. (Labor)
 ⑨ Farm Machinery Center
 ⑩ Green House
 ⑪ Library
- Irrigation and Drainage Facilities
 ○ Deep Well Pump
 □ Irrigation Pump
 [R] Reservoir
 --- Irrigation Pipeline
 --- Farm Drain
 [] Box Culvert
 --- Pipe Culvert
- Roads
 = Main Road
 = Secondary Road
- Existing Experimental Farm
 Proposed Experimental Farm

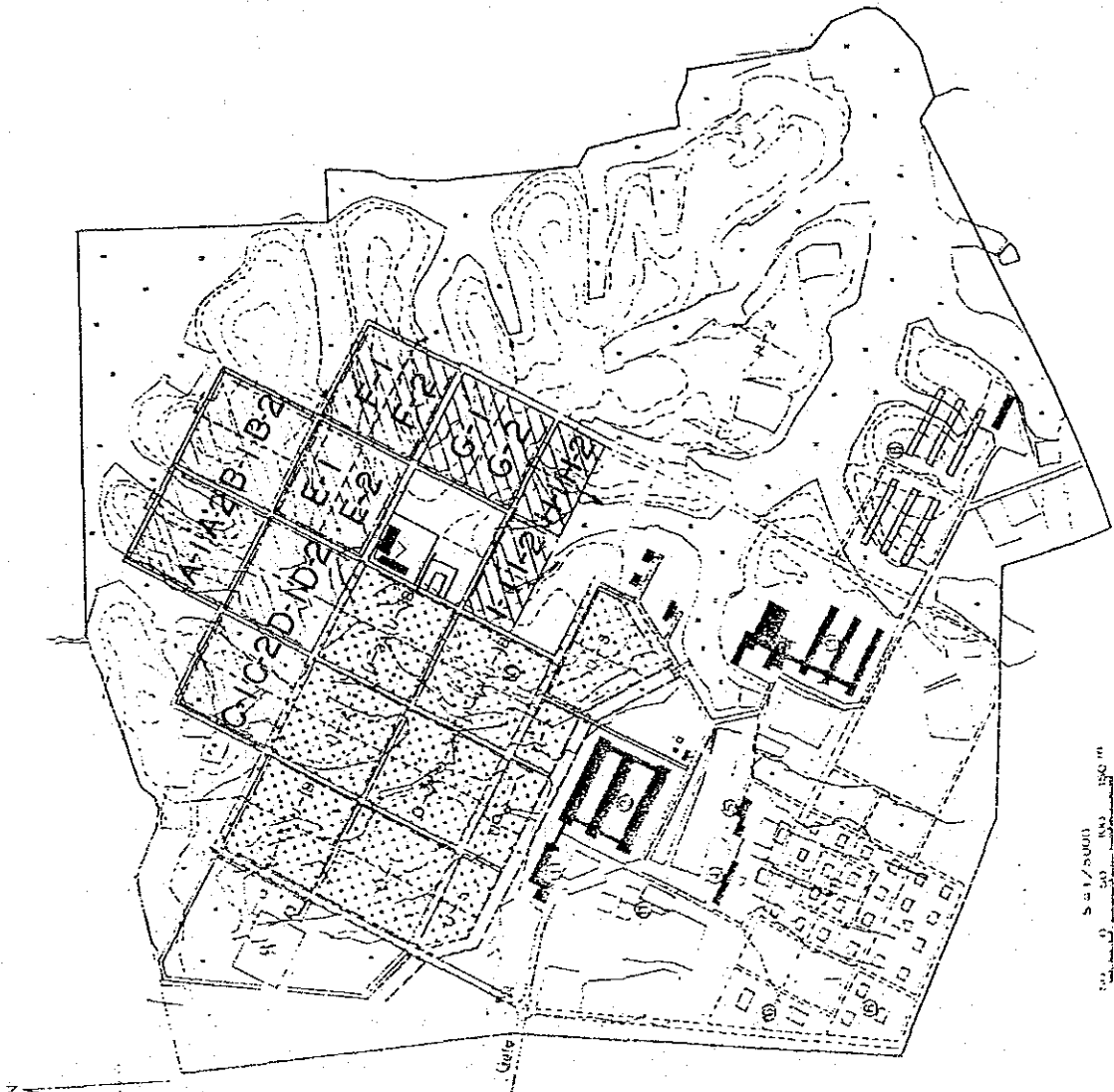

Fig-2
 INSTITUTE OF POST-GRADUATE STUDIES IN AGRICULTURE
 GENERAL PLAN

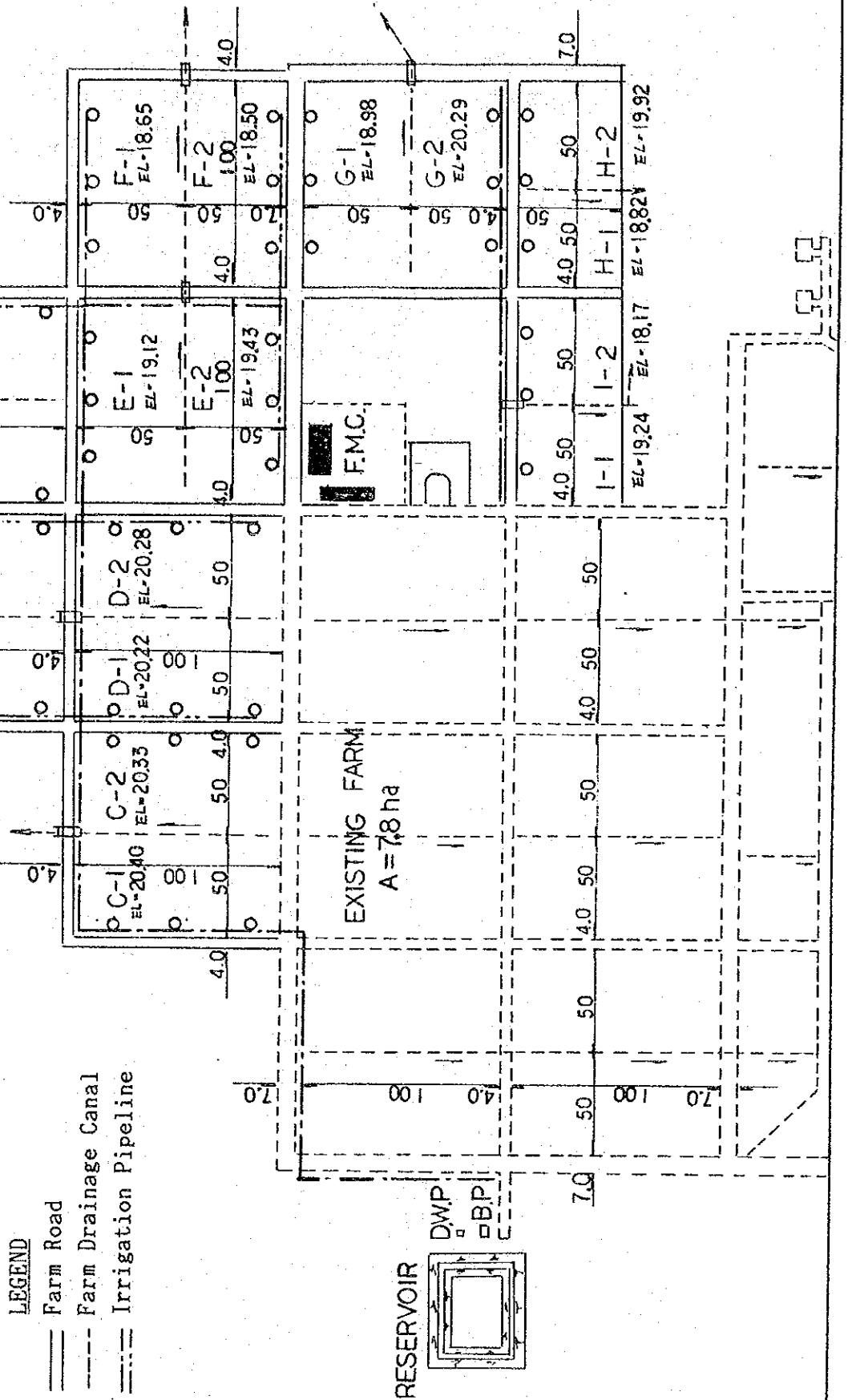

TABLE-2

MEMBER'S LIST

DETAILED DESIGN SURVEY TEAM
FOR
THE INSTITUTE OF POSTGRADUATE STUDIES
IN AGRICULTURE PROJECT IN BANGLADESH

Assignment	Name	Present Position
Team Leader	Takeshi OMURA	Professor, Faculty of Agriculture, KYUSHU University
Coordinator	Takeshi WATANABE	Project Officer, Technical Cooperation Div., Agriculture Development Cooperation Dept., Japan International Cooperation Agency (JICA)
Design of Farm	Hyosaku GOTO	Technical Advisor, Taiyo Consul- tants CO., LTD.
Design of Irriga- tion and Drainage	Isao IWAI	Irrigation Engineer, Overseas Engineering Division, Taiyo Consultants Co., Ltd.

JAPAN INTERNATIONAL COOPERATION AGENCY (JICA)
P. O. BOX 216, Shinjuku-Mitsui Bldg.,
2-1 Nishi-Shinjuku, Shinjuku-ku, Tokyo, Japan 163
tel. 03-346-5311

TABLE-3

THE TENTATIVE ITINERARY FOR THE TEAM

Date	Description
Feb. 19 (Sun)	Arrive at Dhaka (TG-321)
Feb. 20 (Mon)	Courtesy call to the Ministry of planning, External Resources Division Planning Commission IPSA, the Embassy of Japan, JICA Bangladesh Office
Feb. 21 (Tue)	Discussion with Japanese Expert Team in Dhaka
Feb. 22 (Wed)	Discussion with IPSA officials Field survey
Feb. 23 (Thu)	Field survey Inspection to BARI, BRRI
Feb. 24 (Fri)	Field survey
Feb. 25 (Sat)	Discussion with IPSA officials and Japanese Experts
Feb. 26 (Sun)	Discussion with IPSA officials, members of Planning Commission and Japanese Experts
Feb. 27 (Mon)	Preparation of the basic plan on the Model Infrastructure Improvement Works
Feb. 28 (Tue)	Courtesy call to and submit the summary report to the Ministry of Agriculture
Mar. 1 (Wed)	Report the result of this survey to the Embassy of Japan, JICA Bangladesh Office
Mar. 2 (Thu)	Depart from Dhaka [Dr. OMURA and Mr. WATANABE] (TG-322)
Mar. 2 (Thu)	Continue the field survey for the detailed design ~ [Mr. GOTO and Mr. IWAI]
Mar. 26 (Sun)	
Mar. 27 (Mon)	Report the result of this survey to the Embassy of Japan, JICA Bangladesh Office
Mar. 28 (Tue)	Depart from Dhaka [Mr GOTO and Mr. IWAI] (TG-322)

添付図面



LEGEND

- Main Pipeline (Ø150)
- Secondary Pipeline (Ø75)
- Hydrant
- Pipe Culvert
- - - Field Drain

THE GOVERNMENT OF BANGLADESH
 EXPERIMENTAL FARM CONSTRUCTION PROJECT
 FOR
 THE INSTITUTE OF POSTGRADUATE STUDIES
 IN AGRICULTURE (IPSA), SALNA

TITLE OF DRAWING
 GENERAL PLAN

JAPAN INTERNATIONAL COOPERATION AGENCY
 TOKYO JAPAN

DWG.NO.
 I

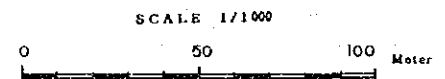
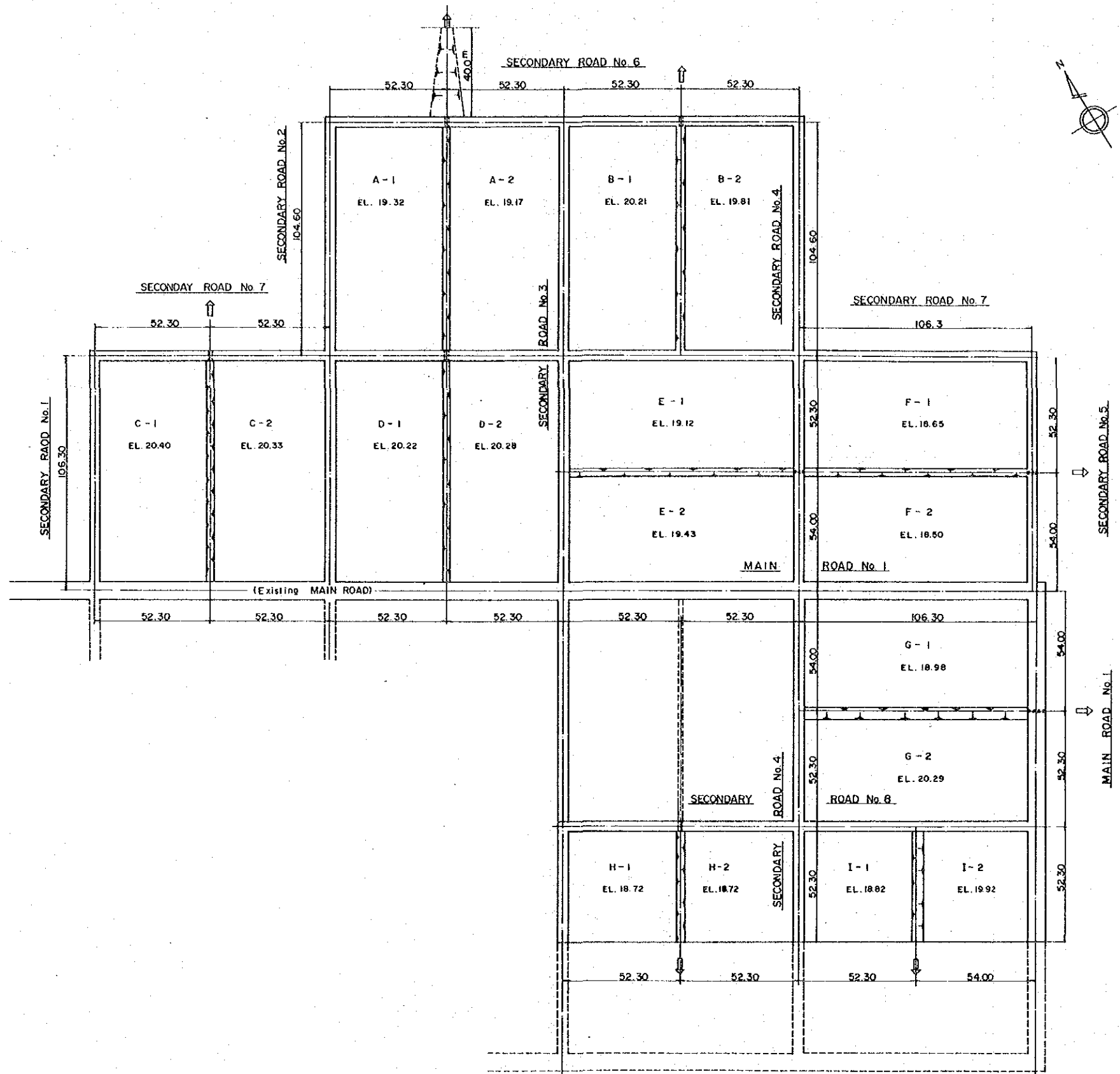

THE GOVERNMENT OF BANGLADESH
 EXPERIMENTAL FARM CONSTRUCTION PROJECT
 FOR
 THE INSTITUTE OF POSTGRADUATE STUDIES
 IN AGRICULTURE (IPSA), SALNA

TITLE OF DRAWING
 ROAD AND DRAINAGE NETWORK

JAPAN INTERNATIONAL COOPERATION AGENCY TOKYO JAPAN DWG.NO. 2

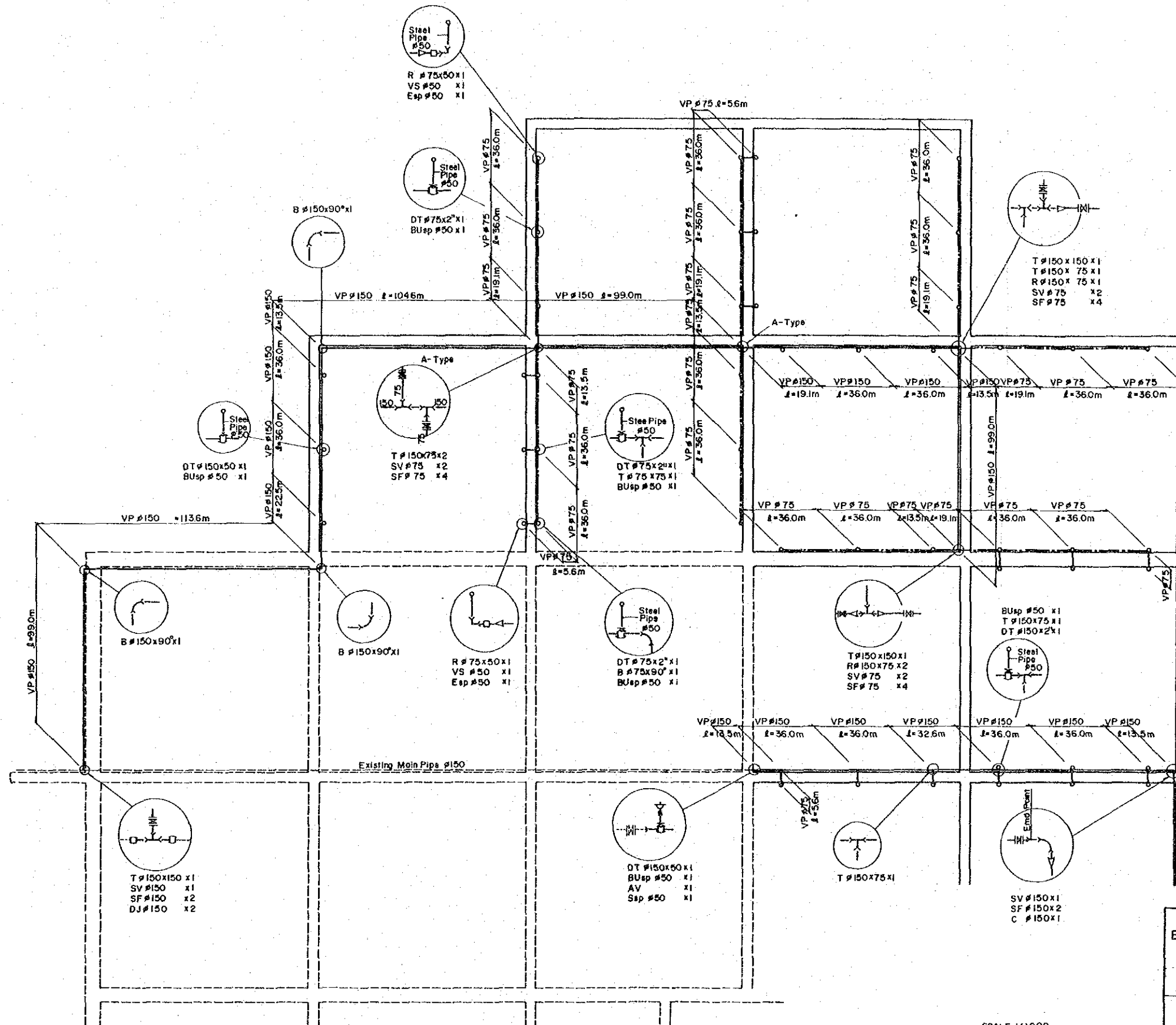

- LEGEND**
- Main Pipe Line (VP)
 - - - Secondary Pipe Line (VP)
 - ⋄ Bend (B) or Elbow (E)
 - ⊥ Tee (T)
 - ⋈ Reducer (R)
 - ⊥ SV Stulce Valve (SV) and Socket Flange (SF)
 - ⊙ Valve Socket (VS)
 - ⊕ Dressor Tee (DT)
 - ⊙ Dressor Joint (DJ)
 - ⊥ Short Pipe (SP)
 - ⊥ Air Valve (AV)
 - ⊥ Bush for Steel Pipe (BUsp)
 - ⊥ Socket for Steel Pipe (Ssp)
 - ⊥ Hydrant for Upland Field Cap (C)

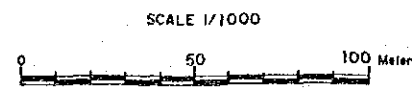

THE GOVERNMENT OF BANGLADESH
 EXPERIMENTAL FARM CONSTRUCTION PROJECT
 FOR
 THE INSTITUTE OF POSTGRADUATE STUDIES
 IN AGRICULTURE (IPSA), SALNA
 TITLE OF DRAWING
 SKELTON OF PIPELINE SYSTEM
 JAPAN INTERNATIONAL COOPERATION AGENCY TOKYO JAPAN DWG.NO. 3

TYPICAL SECTION OF PIPELINE

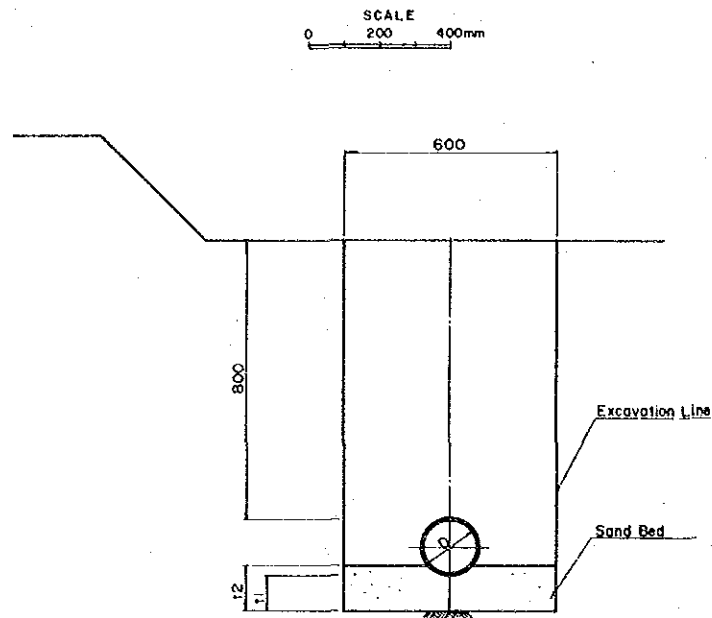

DIMENSION TABLE (mm)

Nominal Dia	Pipe Material	Outer Dia	11	12	Trench Depth
50	PVC (VP)	60	100	115	960
75	PVC (VP)	89	100	122	989
100	PVC (VP)	114	100	129	1014
150	PVC (VP)	165	100	141	1065

X VP-Unplasticized Polyvinyl Chloride Pipe

DETAIL OF HYDRANT

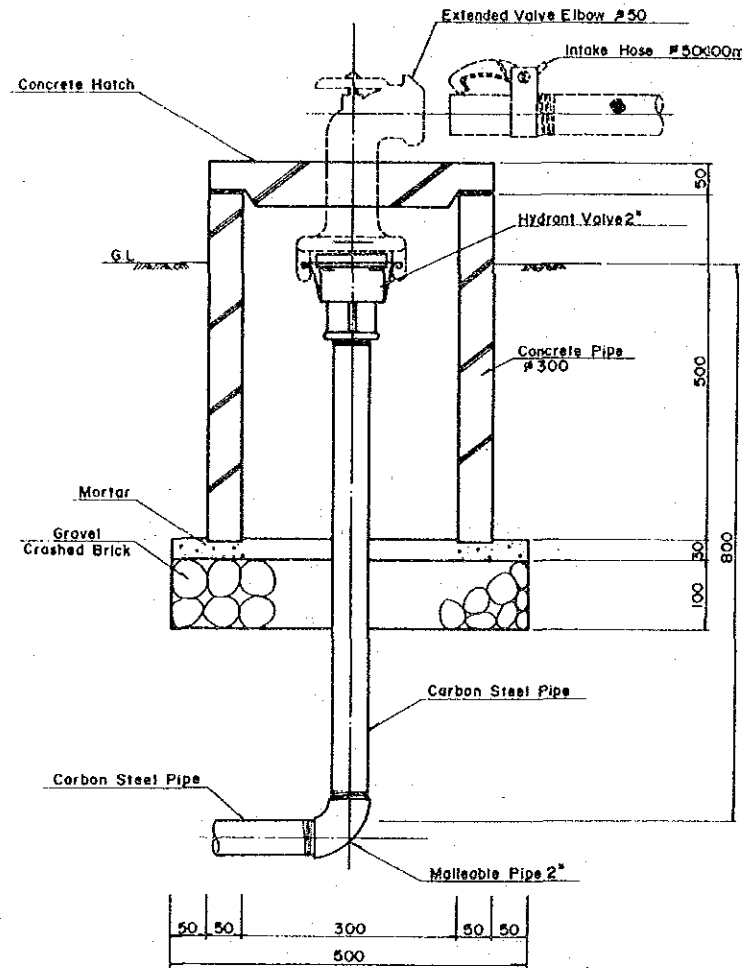
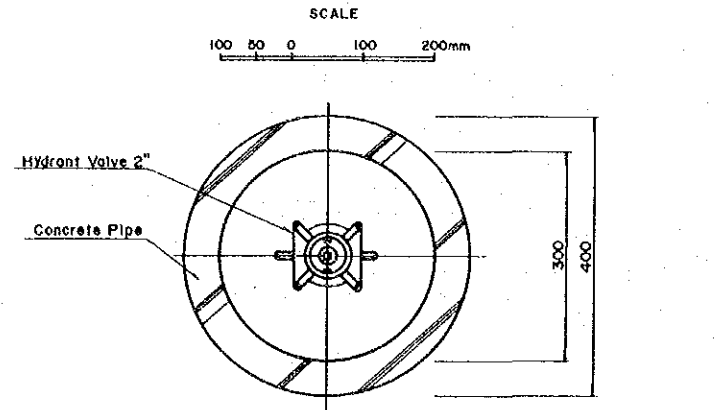

SLUICE VALVE

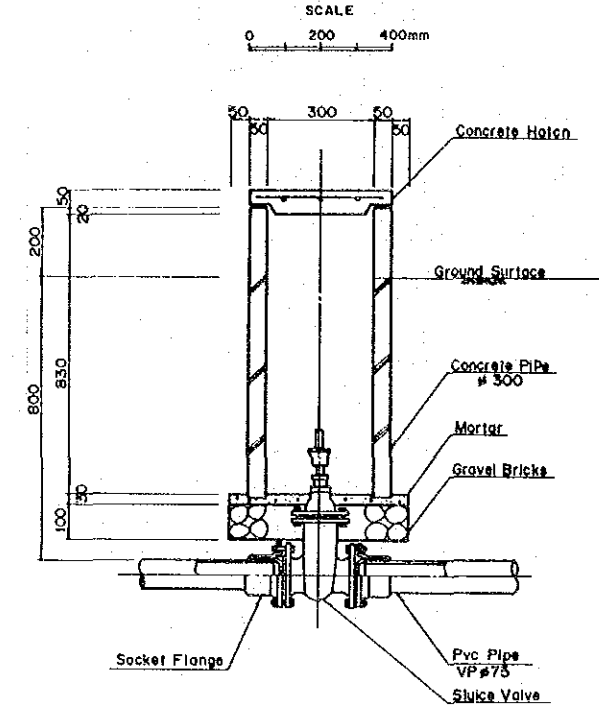

CONCRETE HATCH DETAIL

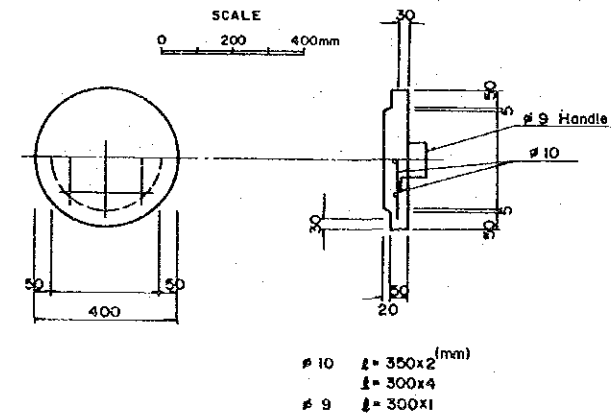

AIR VALVE

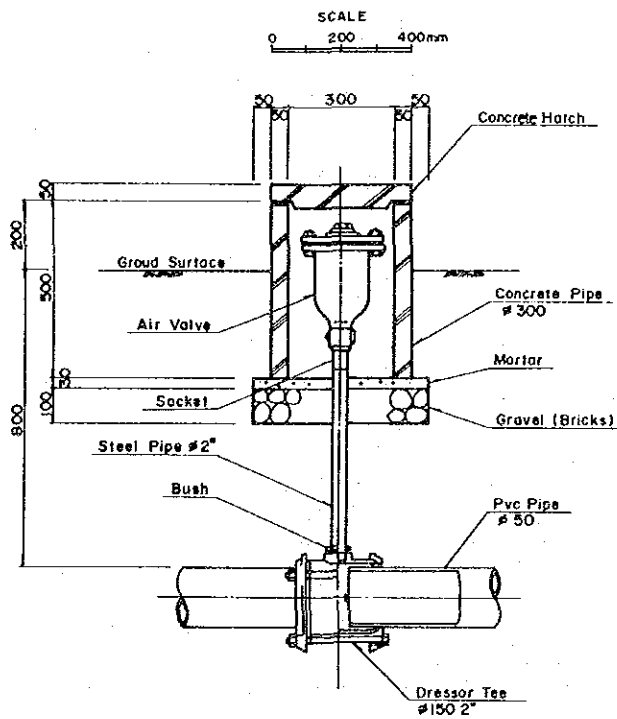

THE GOVERNMENT OF BANGLADESH
 EXPERIMENTAL FARM CONSTRUCTION PROJECT
 FOR
 THE INSTITUTE OF POSTGRADUATE STUDIES
 IN AGRICULTURE (IPSA), SALNA
 TITLE OF DRAWING
 TYPICAL SECTION OF PIPELINE
 AND VALVE
 JAPAN INTERNATIONAL COOPERATION AGENCY
 TOKYO JAPAN
 DWG.NO.
 4

TYPICAL SECTION

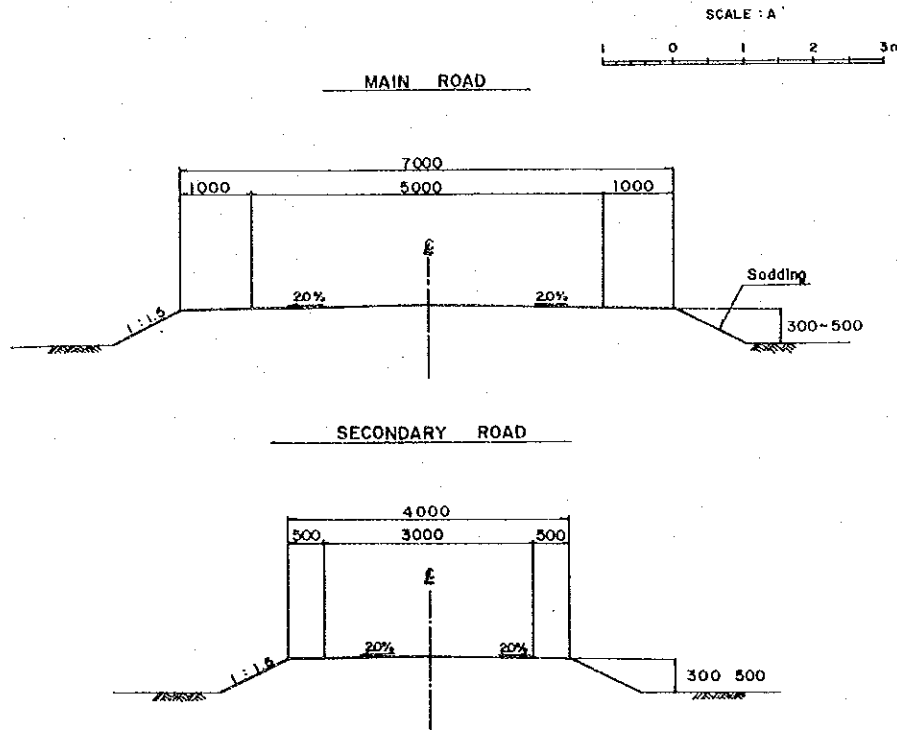

CORNER CUTTING

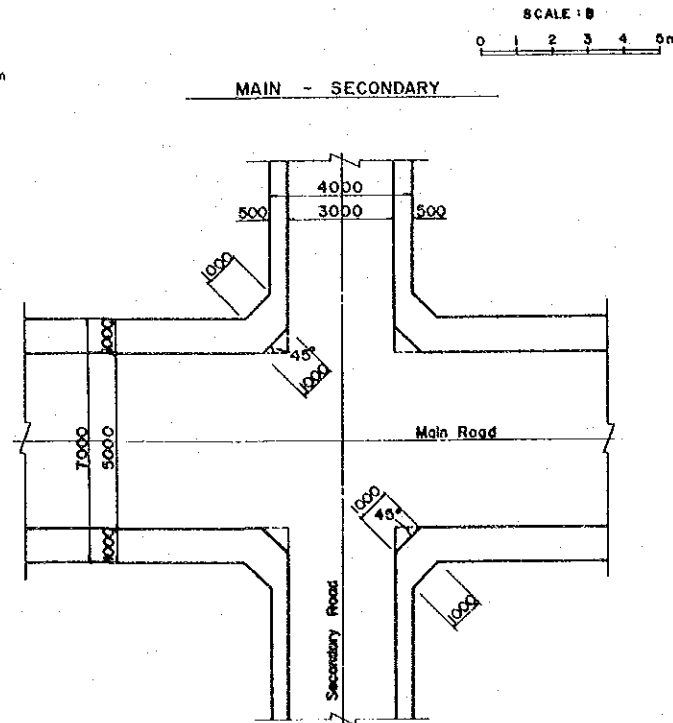

TRACTOR PASSAGE

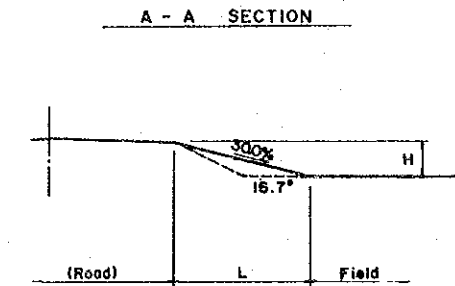
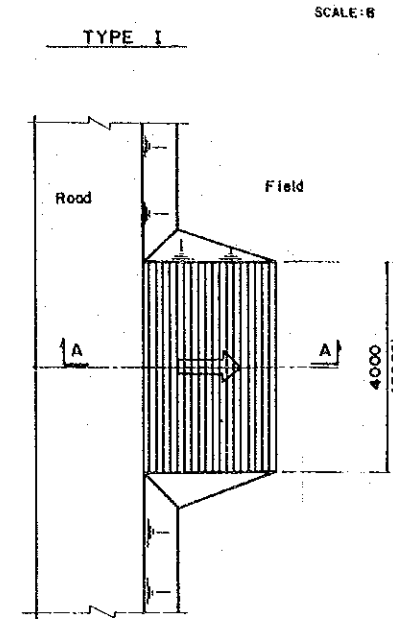

DRAINAGE CANAL
(FARM DRAIN)

UPLAND FIELD

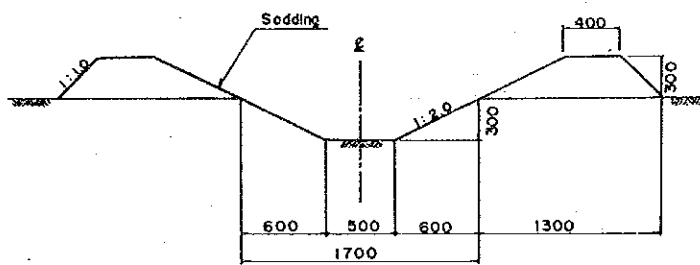

SECONDARY - SECONDARY

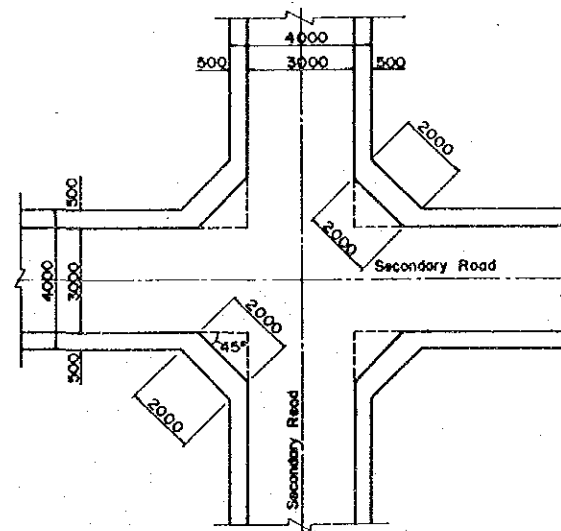

TRACTOR PASSAGE

TYPE II

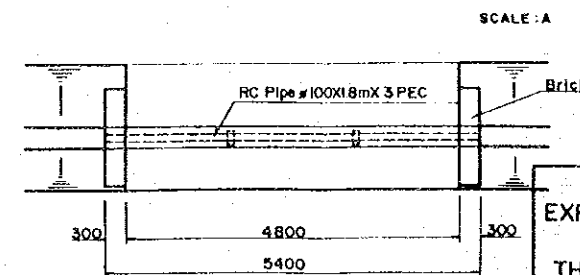
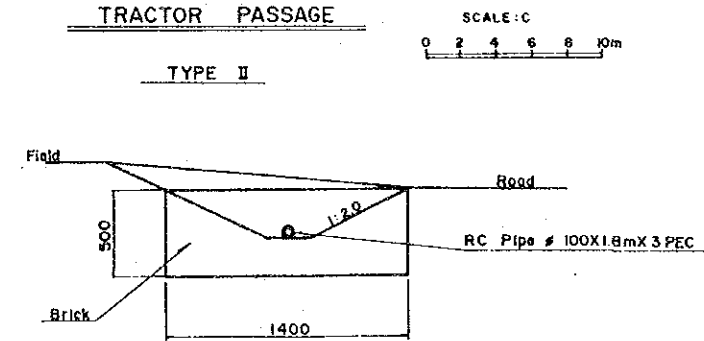

THE GOVERNMENT OF BANGLADESH
EXPERIMENTAL FARM CONSTRUCTION PROJECT
FOR
THE INSTITUTE OF POSTGRADUATE STUDIES
IN AGRICULTURE (IPSA), SALNA

TITLE OF DRAWING
TYPICAL SECTION OF ROAD
AND DRAINAGE CANAL

JAPAN INTERNATIONAL COOPERATION AGENCY
TOKYO JAPAN

DWG.NO.
5

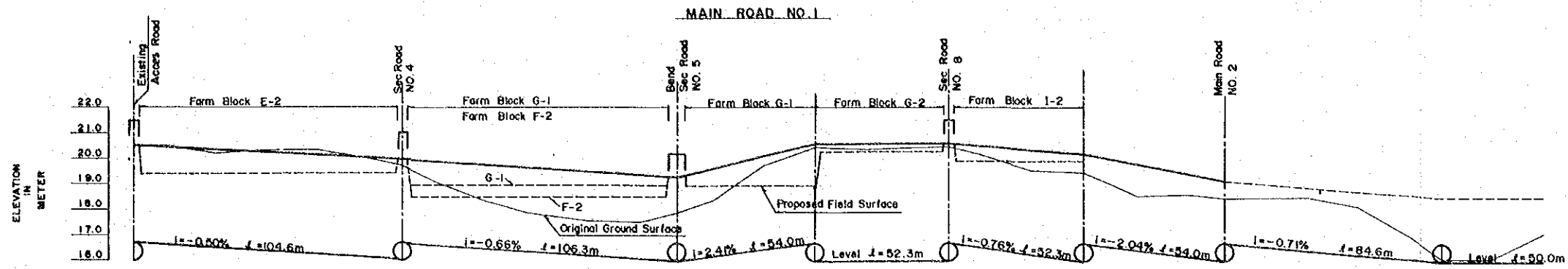

ADJACENT FIELD SURFACE ELEVATION	ROAD SURFACE ELEVATION	GROUND SURFACE ELEVATION	ACCUMULATED DISTANCE
19.43	20.52	20.52	0
	20.46	20.56	12.3
	20.36	20.20	32.3
	20.26	20.34	52.3
	20.16	20.33	72.3
	20.06	20.01	92.3
	20.00	19.72	104.6
	19.92	19.12	116.9
	19.79	18.36	136.9
	19.66	17.90	156.9
	19.52	17.57	176.9
	19.39	17.50	196.9
	19.30	17.84	210.9
	19.64	18.39	224.9
	20.12	18.76	244.9
	20.60	20.45	264.9
	20.60	20.34	284.9
	20.60	20.48	304.9
	20.60	20.50	317.2
	20.51	20.21	329.5
	20.35	19.56	349.5
	20.20	19.41	369.5
	19.79	18.54	389.5
	19.39	18.59	409.5
	19.10	18.47	423.5
	19.01	18.50	432.8
	18.67	18.50	452.8
	18.75	18.12	472.8
	18.59	17.01	492.8
	18.50	16.10	509.1
	18.10	18.10	526.6
	18.50	17.12	546.6

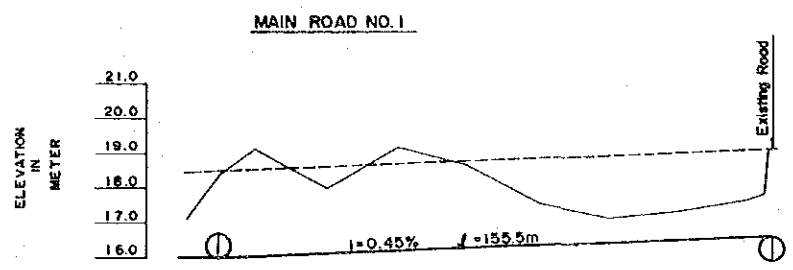
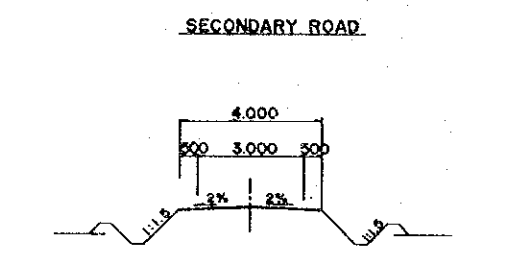
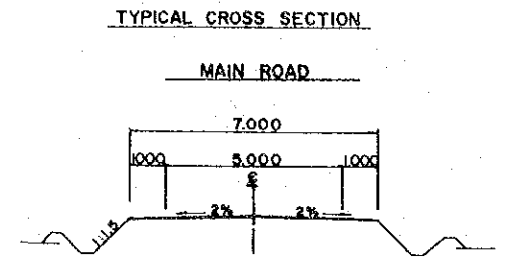

ADJACENT FIELD SURFACE ELEVATION	ROAD SURFACE ELEVATION	GROUND SURFACE ELEVATION	ACCUMULATED DISTANCE
	18.50	17.12	546.6
	18.50	18.40	558.1
	18.54	18.13	566.6
	18.63	18.01	586.6
	18.72	19.20	606.6
	18.81	18.72	626.6
	18.90	17.61	646.6
	18.99	17.20	666.6
	19.08	17.41	686.6
	19.17	17.72	706.6
	19.20	19.20	713.6

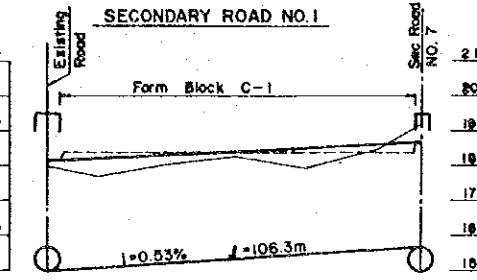

ADJACENT FIELD SURFACE ELEVATION	ROAD SURFACE ELEVATION	GROUND SURFACE ELEVATION	ACCUMULATED DISTANCE
	20.14	20.01	0
	20.21	19.72	14.0
	20.32	20.38	34.0
	20.42	20.25	54.0
	20.53	19.85	74.0
	20.64	20.50	94.0
	20.70	21.20	106.3

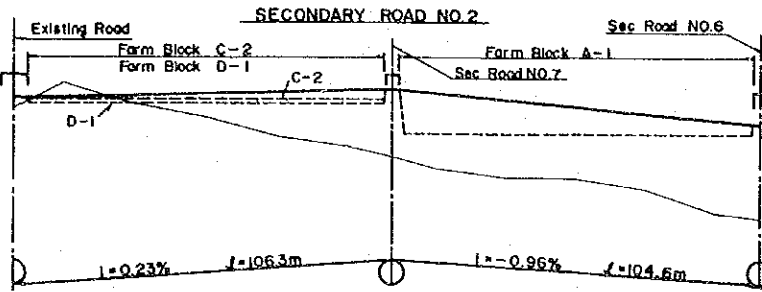

ADJACENT FIELD SURFACE ELEVATION	ROAD SURFACE ELEVATION	GROUND SURFACE ELEVATION	ACCUMULATED DISTANCE
	20.36	20.09	0
	20.39	20.79	14.0
	20.44	20.14	34.0
	20.48	19.82	54.0
	20.53	19.26	74.0
	20.57	18.96	94.0
	20.60	18.64	106.3
	20.48	18.30	118.6
	20.29	18.04	139.6
	20.10	18.05	158.6
	19.91	17.74	178.6
	19.72	17.57	198.6
	19.60	17.42	210.9

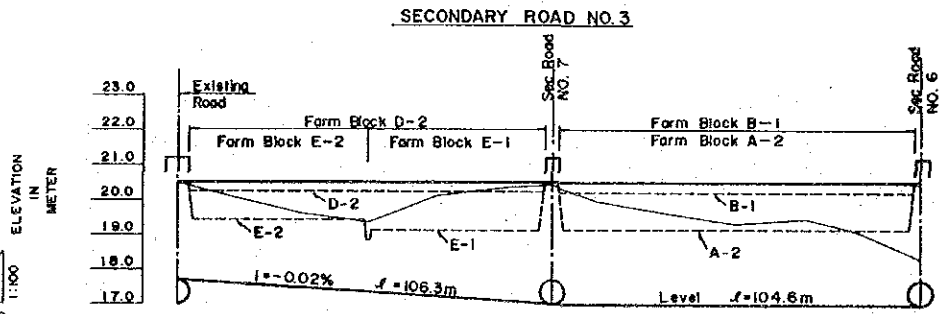

ADJACENT FIELD SURFACE ELEVATION	ROAD SURFACE ELEVATION	GROUND SURFACE ELEVATION	ACCUMULATED DISTANCE
	20.52	20.52	0
	20.52	20.12	14.0
	20.51	19.60	34.0
	20.51	19.34	54.0
	20.51	20.12	74.0
	20.50	20.36	94.0
	20.50	20.41	106.3
		19.98	118.6
		19.64	138.6
		19.32	158.6
		19.49	178.6
		19.10	198.6
	20.50	18.30	210.9

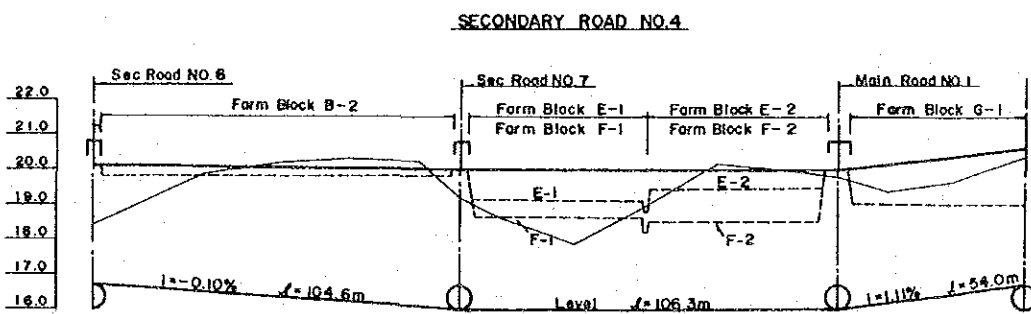

ADJACENT FIELD SURFACE ELEVATION	ROAD SURFACE ELEVATION	GROUND SURFACE ELEVATION	ACCUMULATED DISTANCE
	20.10	18.41	0
	20.09	18.94	12.3
	20.07	19.84	32.3
	20.05	20.18	52.3
	20.05	20.30	72.3
	20.01	20.20	92.3
	20.00	19.19	104.6
		18.96	116.9
		17.88	136.9
		18.90	156.9
		20.16	176.9
		19.97	196.9
	20.00	19.72	210.9
	20.16	19.32	224.9
	20.36	19.61	244.9
	20.60	20.36	264.9

REMARKS

Section for Construction

M. R. NO.1: Between 0 to +369.5m

S. R. NO.1: Between 0 to End

S. R. NO.2: -do-

S. R. NO.3: -do-

S. R. NO.4: Between 0 to +369.5m

THE GOVERNMENT OF BANGLADESH
 EXPERIMENTAL FARM CONSTRUCTION PROJECT
 FOR
 THE INSTITUTE OF POSTGRADUATE STUDIES
 IN AGRICULTURE (IPSA), SALNA

TITLE OF DRAWING
 PROFILE OF FARM ROAD - 1/2 -

JAPAN INTERNATIONAL COOPERATION AGENCY TOKYO JAPAN

DWG.NO.
 6

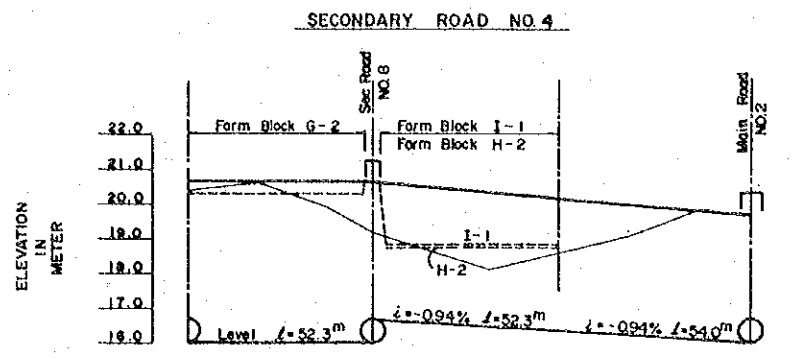

ADJACENT FIELD SURFACE ELEVATION	20.29	18.82 (18.72)	18.82 (18.72)
ROAD SURFACE ELEVATION	20.60	20.48	20.11
GROUND SURFACE ELEVATION	20.36	19.96	19.07
ACCUMULATED DISTANCE	264.9	317.2	423.5

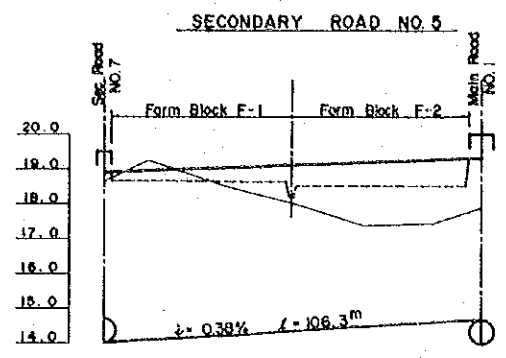

ADJACENT FIELD SURFACE ELEVATION	18.65	18.50	18.50
ROAD SURFACE ELEVATION	18.50	19.02	19.25
GROUND SURFACE ELEVATION	18.66	18.56	17.45
ACCUMULATED DISTANCE	0	32.3	106.3

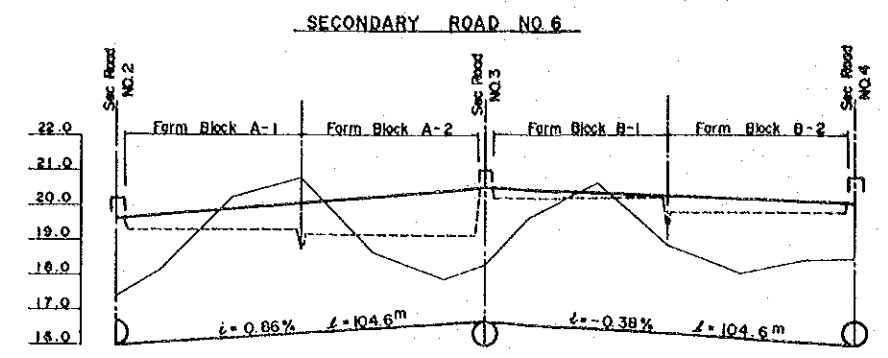

ADJACENT FIELD SURFACE ELEVATION	19.32	19.17	19.17	20.21	19.81	19.81
ROAD SURFACE ELEVATION	19.60	19.71	20.05	20.22	20.30	20.10
GROUND SURFACE ELEVATION	17.42	18.15	20.79	18.46	20.61	18.41
ACCUMULATED DISTANCE	0	12.3	32.3	72.3	136.9	209.2

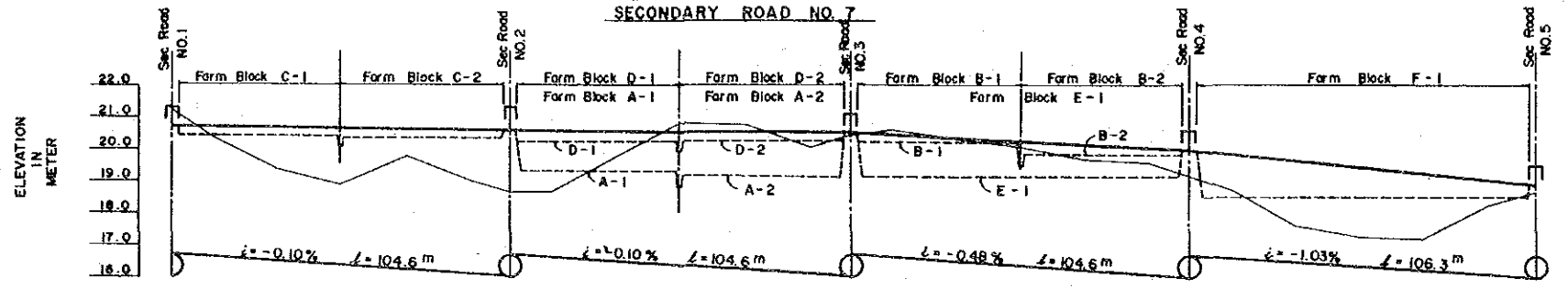

ADJACENT FIELD SURFACE ELEVATION	20.40	20.33	20.33	20.22 (19.32)	20.28 (19.17)	20.21 (19.12)	19.81 (19.12)	19.81 (19.12)	18.65
ROAD SURFACE ELEVATION	20.70	20.69	20.67	20.63	20.59	20.53	20.51	20.50	19.67
GROUND SURFACE ELEVATION	21.20	20.33	19.32	18.95	19.76	18.99	20.41	19.56	17.28
ACCUMULATED DISTANCE	0	12.3	32.3	52.3	72.3	104.5	176.9	221.5	346.1

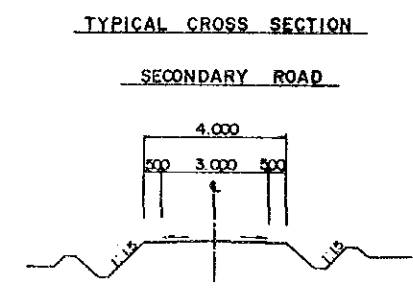

REMARKS
 Section for Construction.
 S.R. NO.5 : Between 0 to End.
 S.R. NO.6 : -do-
 S.R. NO.7 : -do-
 S.R. NO.8 : -do-

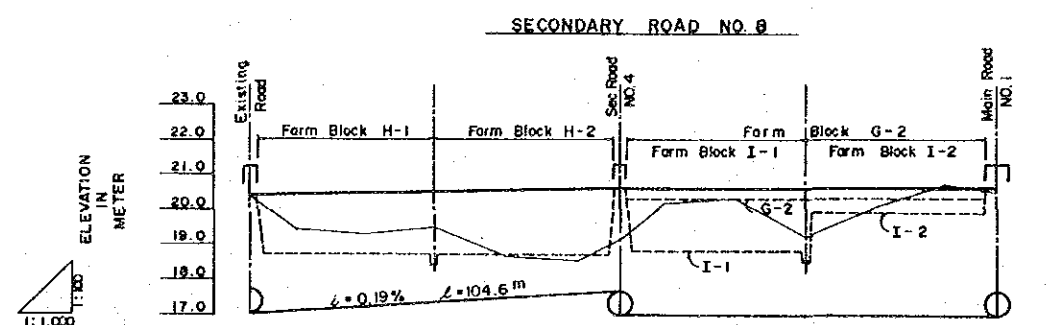

ADJACENT FIELD SURFACE ELEVATION	18.72	18.72	18.72	20.25 (18.82)	20.25 (19.82)	20.25 (19.82)
ROAD SURFACE ELEVATION	20.40	20.42	20.50	20.54	20.59	20.60
GROUND SURFACE ELEVATION	20.40	19.43	19.48	18.63	18.51	20.70
ACCUMULATED DISTANCE	0	12.3	32.3	72.3	136.9	210.9

THE GOVERNMENT OF BANGLADESH
 EXPERIMENTAL FARM CONSTRUCTION PROJECT
 FOR
 THE INSTITUTE OF POSTGRADUATE STUDIES
 IN AGRICULTURE (IPSA), SALNA

TITLE OF DRAWING
 PROFILE OF
 FARM ROAD - 2/2 -

JAPAN INTERNATIONAL COOPERATION AGENCY
 TOKYO JAPAN

DWG.NO.
 7

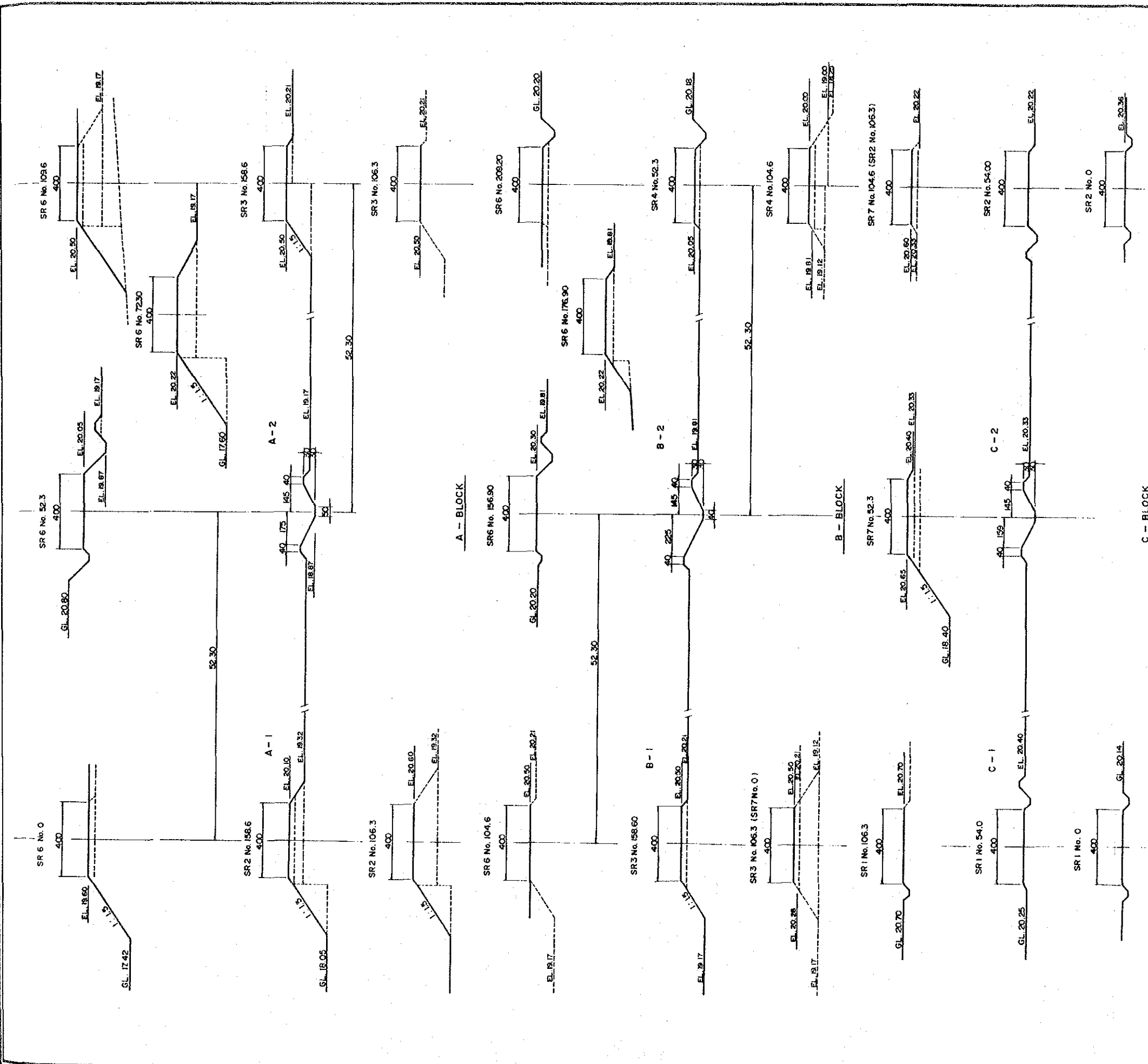

THE GOVERNMENT OF BANGLADESH
 EXPERIMENTAL FARM CONSTRUCTION PROJECT
 FOR
 THE INSTITUTE OF POSTGRADUATE STUDIES
 IN AGRICULTURE (IPSA), SALNA

TITLE OF DRAWING
 CROSS SECTION OF FIELD, ROAD
 AND DRAINAGE CANAL - 1 / 3

JAPAN INTERNATIONAL COOPERATION AGENCY DWG.NO.
 TOKYO JAPAN 8

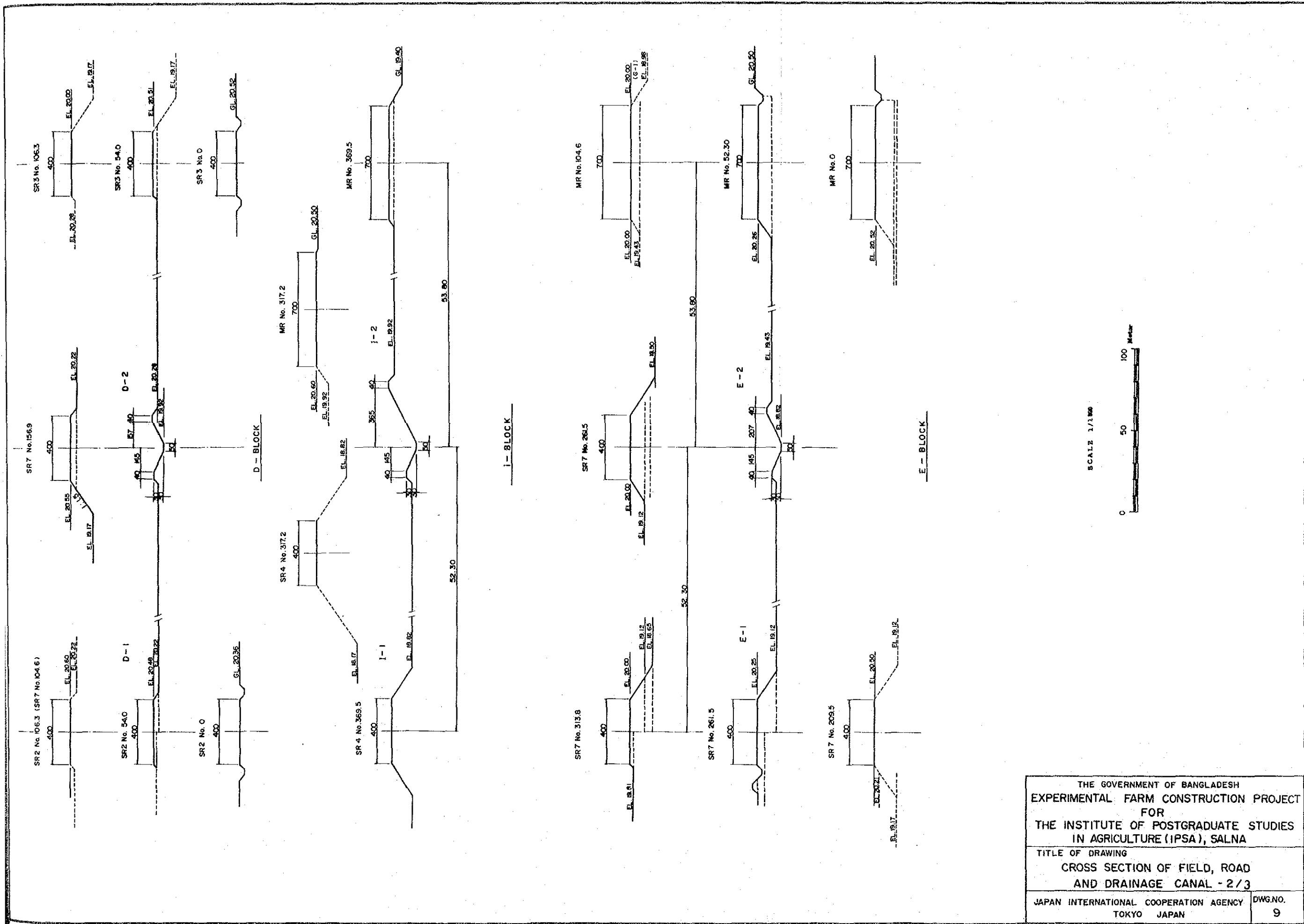

THE GOVERNMENT OF BANGLADESH EXPERIMENTAL FARM CONSTRUCTION PROJECT FOR THE INSTITUTE OF POSTGRADUATE STUDIES IN AGRICULTURE (IPSA), SALNA	
TITLE OF DRAWING CROSS SECTION OF FIELD, ROAD AND DRAINAGE CANAL - 2/3	
JAPAN INTERNATIONAL COOPERATION AGENCY TOKYO JAPAN	DWG.NO. 9

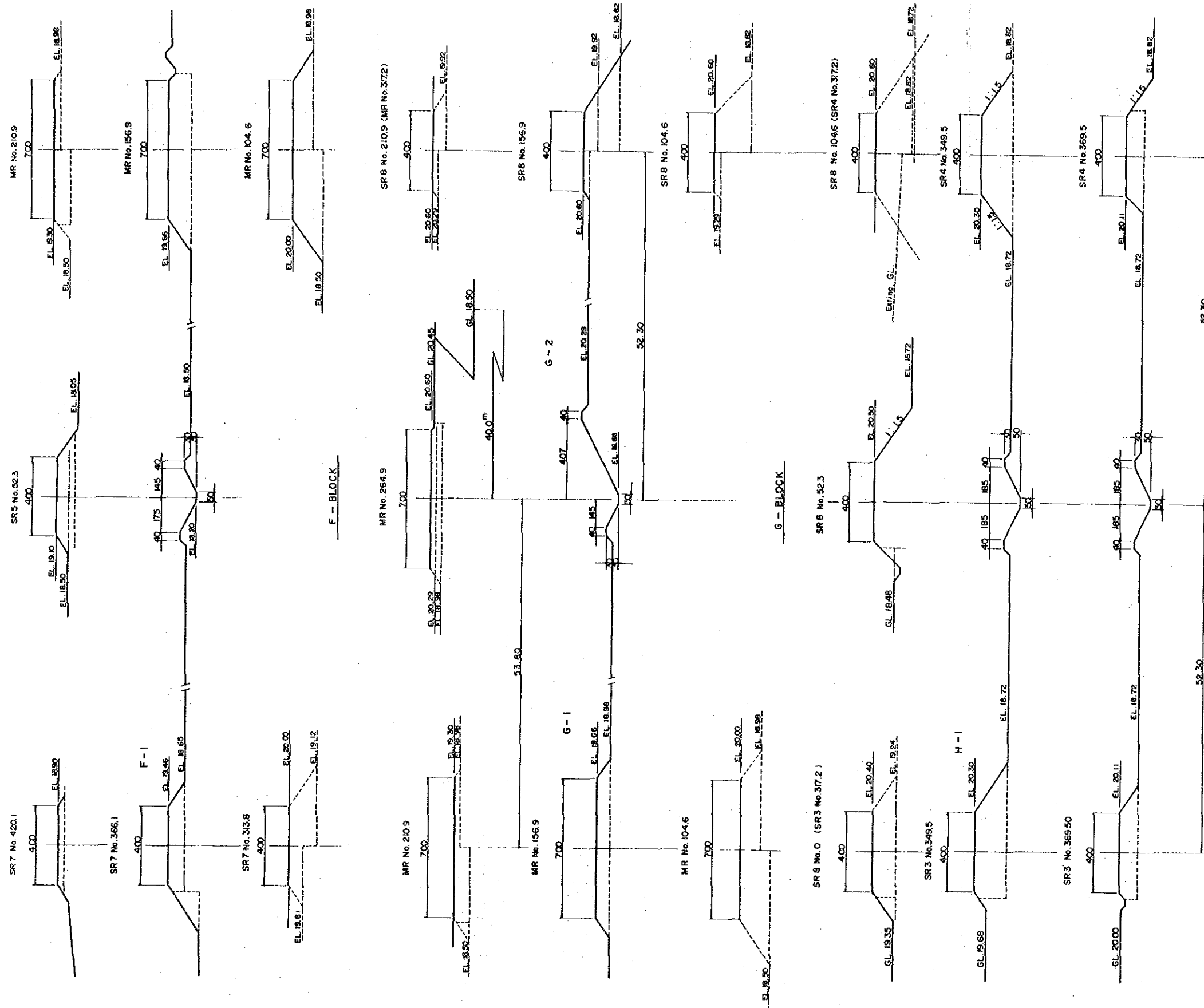

THE GOVERNMENT OF BANGLADESH
 EXPERIMENTAL FARM CONSTRUCTION PROJECT
 FOR
 THE INSTITUTE OF POSTGRADUATE STUDIES
 IN AGRICULTURE (IPSA), SALNA

TITLE OF DRAWING
 CROSS SECTION OF FIELD, ROAD
 AND DRAINAGE CANAL -3 /3

JAPAN INTERNATIONAL COOPERATION AGENCY TOKYO JAPAN DWG.NO. 10

A - BLOCK DESIGN DRAWING OF DRAINAGE SYSTEM S = 1/50

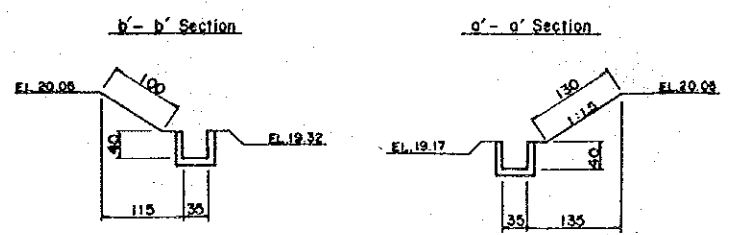
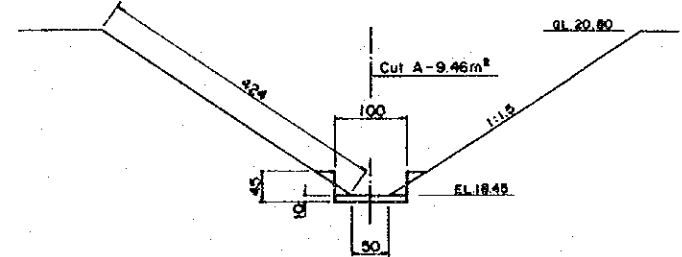
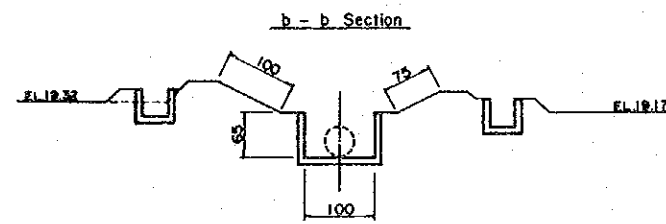
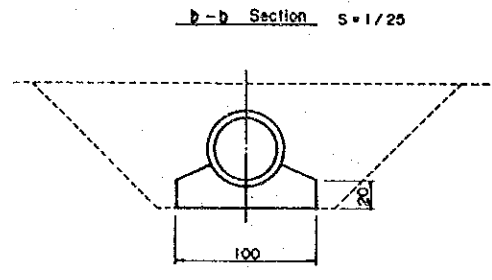
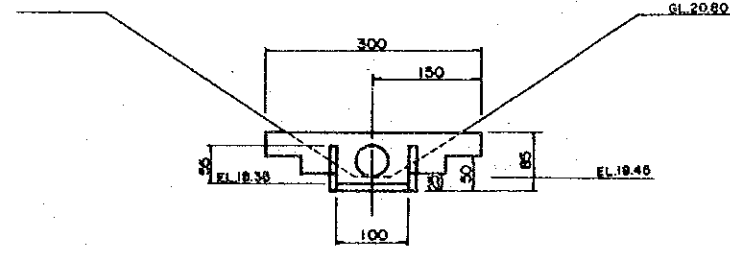
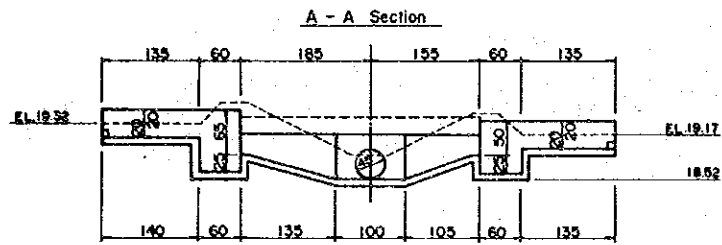
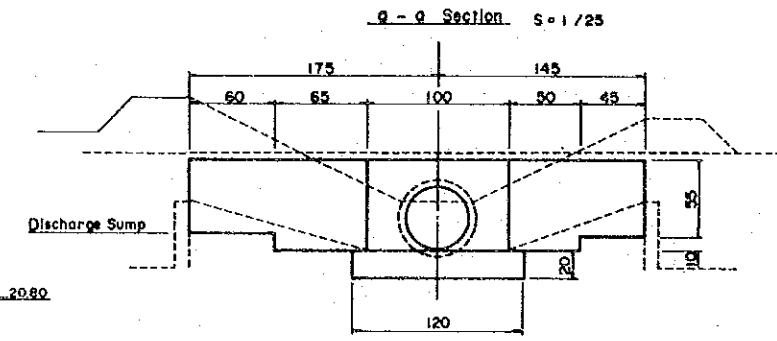
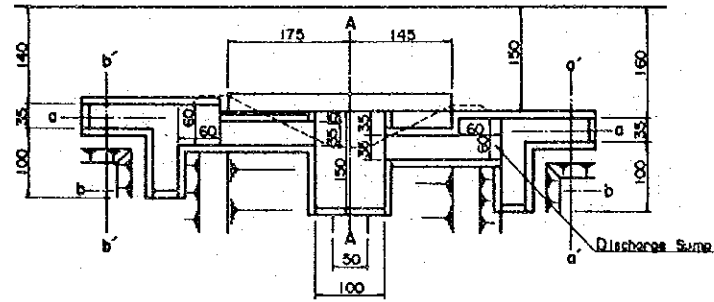
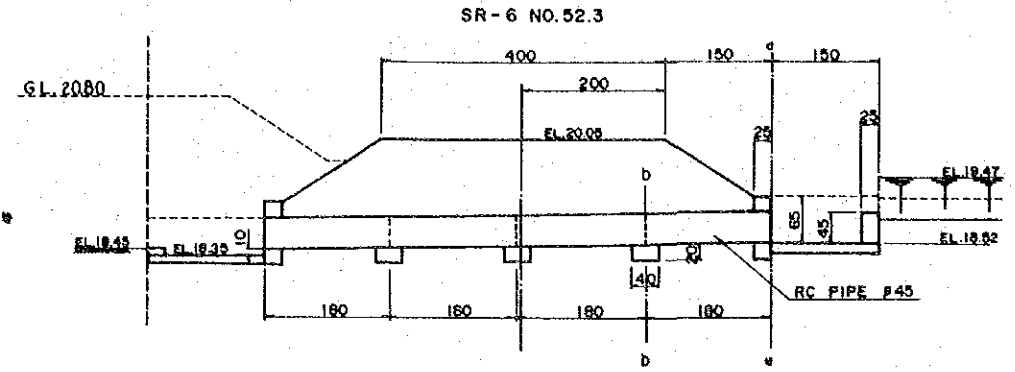
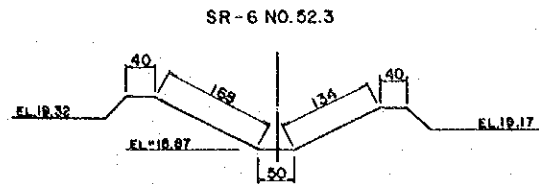

REMARKS
 1. Dimension Shows in Centi-Meter (cm).
 2. All Structures Such as Inlet, Outlet Wall and Discharge Sump Should be Made by Brick

THE GOVERNMENT OF BANGLADESH EXPERIMENTAL FARM CONSTRUCTION PROJECT FOR THE INSTITUTE OF POSTGRADUATE STUDIES IN AGRICULTURE (IPSA), SALNA	
TITLE OF DRAWING A-BLOCK DESIGN DRAWING OF DRAINAGE SYSTEM	
JAPAN INTERNATIONAL COOPERATION AGENCY TOKYO JAPAN	DWG.NO. 11

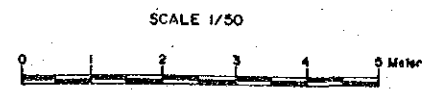

B - BLOCK DESIGN DRAWING OF DRAINAGE SYSTEM S-1/50

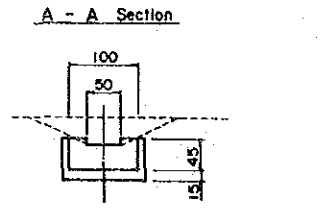
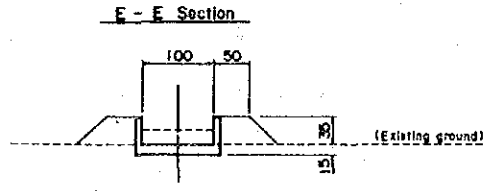
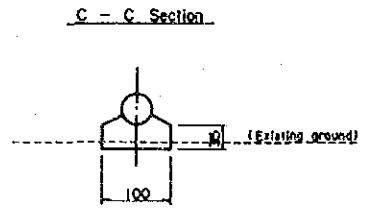
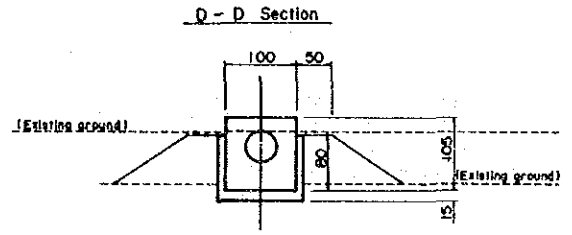
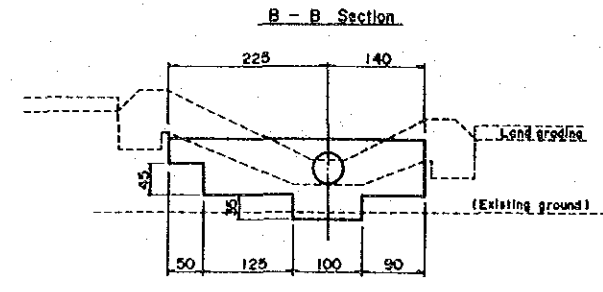
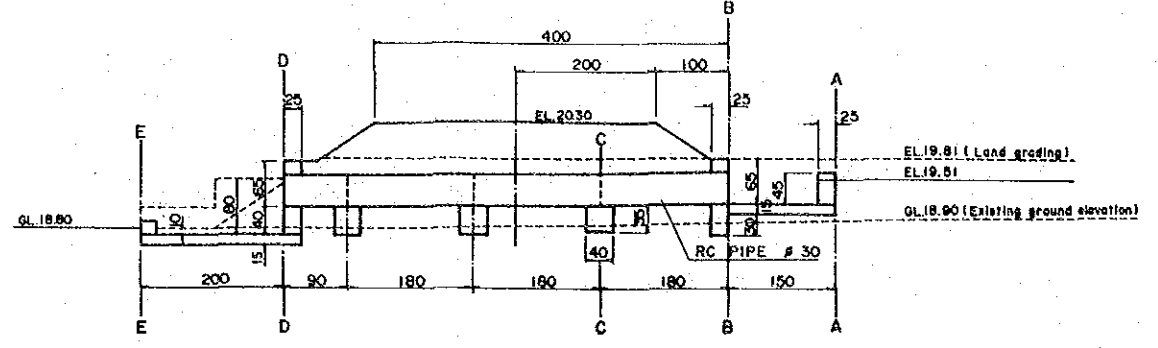
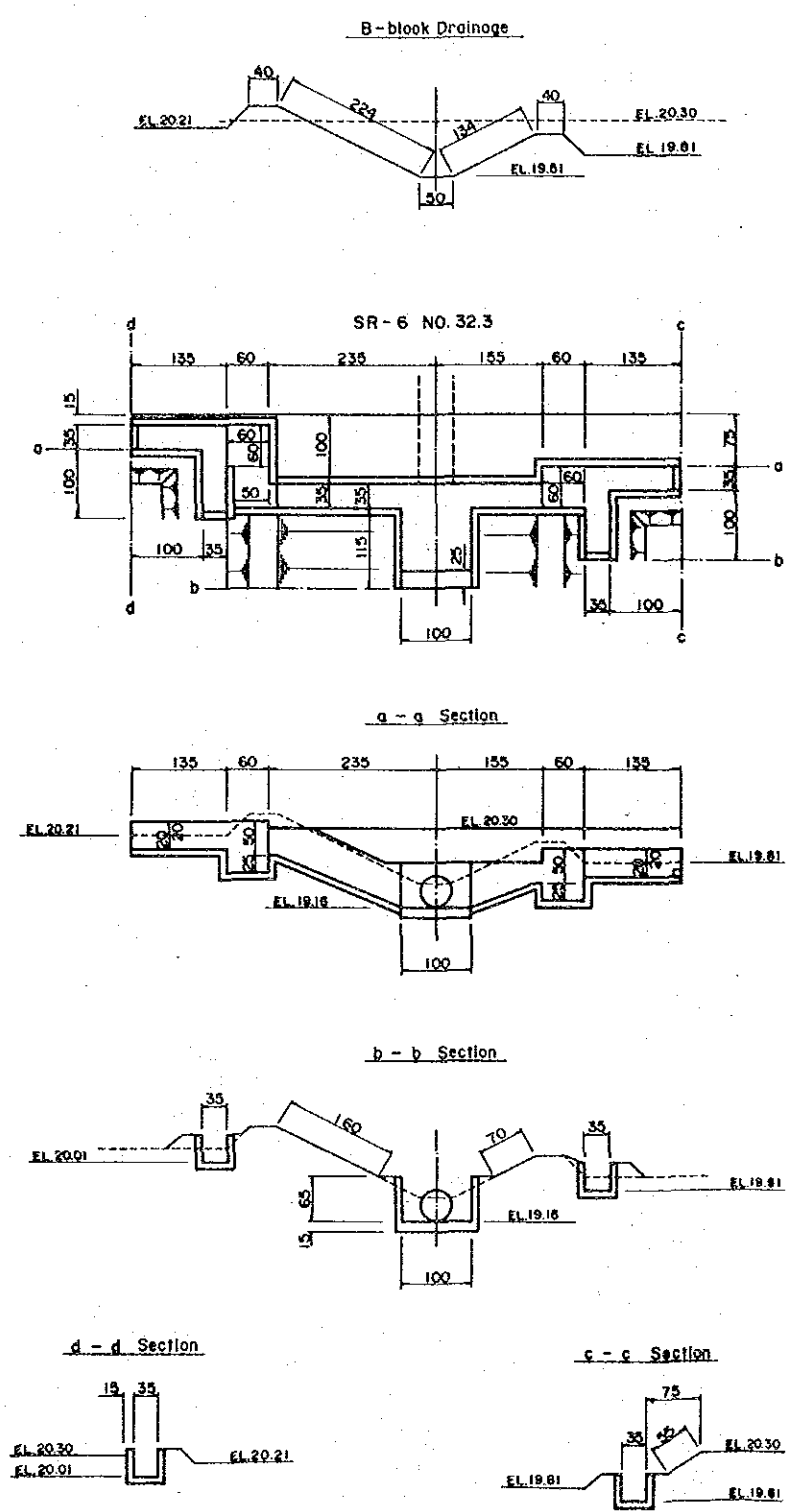

- REMARKS
1. Dimension Shows in Centi-Meter (cm).
 2. All Structures Such as Inlet, Outlet Wall and Discharge Sump should be Made by Brick

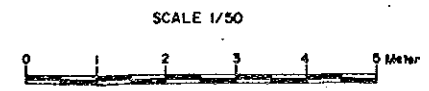

THE GOVERNMENT OF BANGLADESH EXPERIMENTAL FARM CONSTRUCTION PROJECT FOR THE INSTITUTE OF POSTGRADUATE STUDIES IN AGRICULTURE (IPSA), SALNA	
TITLE OF DRAWING B-BLOCK DESIGN DRAWING OF DRAINAGE SYSTEM	
JAPAN INTERNATIONAL COOPERATION AGENCY TOKYO JAPAN	DWG.NO. 12

C-BLOCK DESIGN DRAWING OF DRAINAGE SYSTEM S-1/50

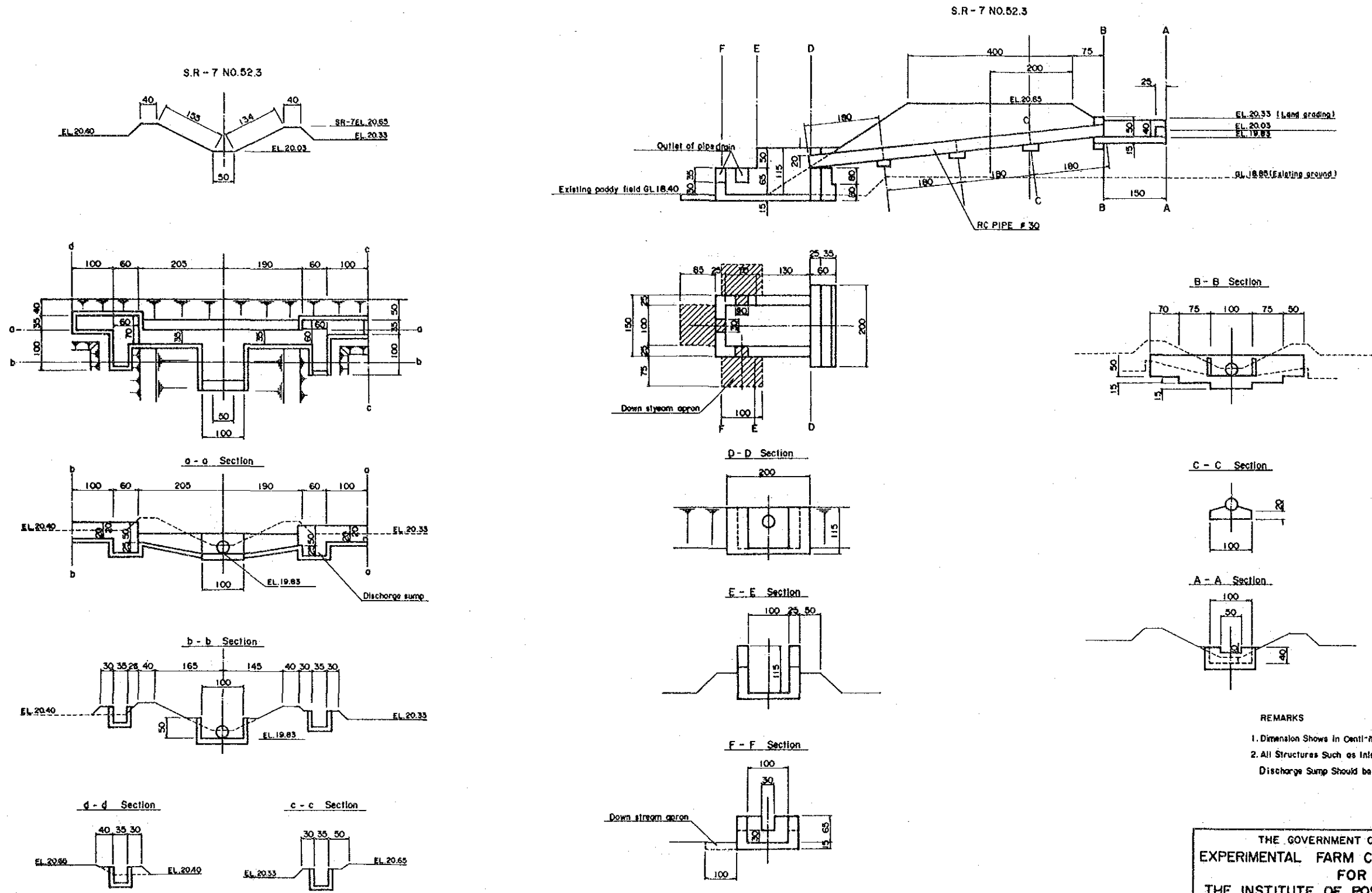

REMARKS
 1. Dimension Shows in Centi-meter (cm).
 2. All Structures Such as Inlet, Outlet Wall and Discharge Sump Should be Made by Brick.

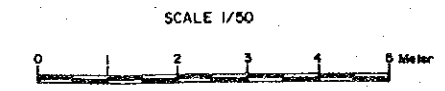

THE GOVERNMENT OF BANGLADESH EXPERIMENTAL FARM CONSTRUCTION PROJECT FOR THE INSTITUTE OF POSTGRADUATE STUDIES IN AGRICULTURE (IPSA), SALNA	
TITLE OF DRAWING C - BLOCK DESIGN DRAWING OF DRAINAGE SYSTEM	
JAPAN INTERNATIONAL COOPERATION AGENCY TOKYO JAPAN	DWG.NO. 13

D-BLOCK DESIGN DRAWING OF DRAINAGE SYSTEM S-1/50

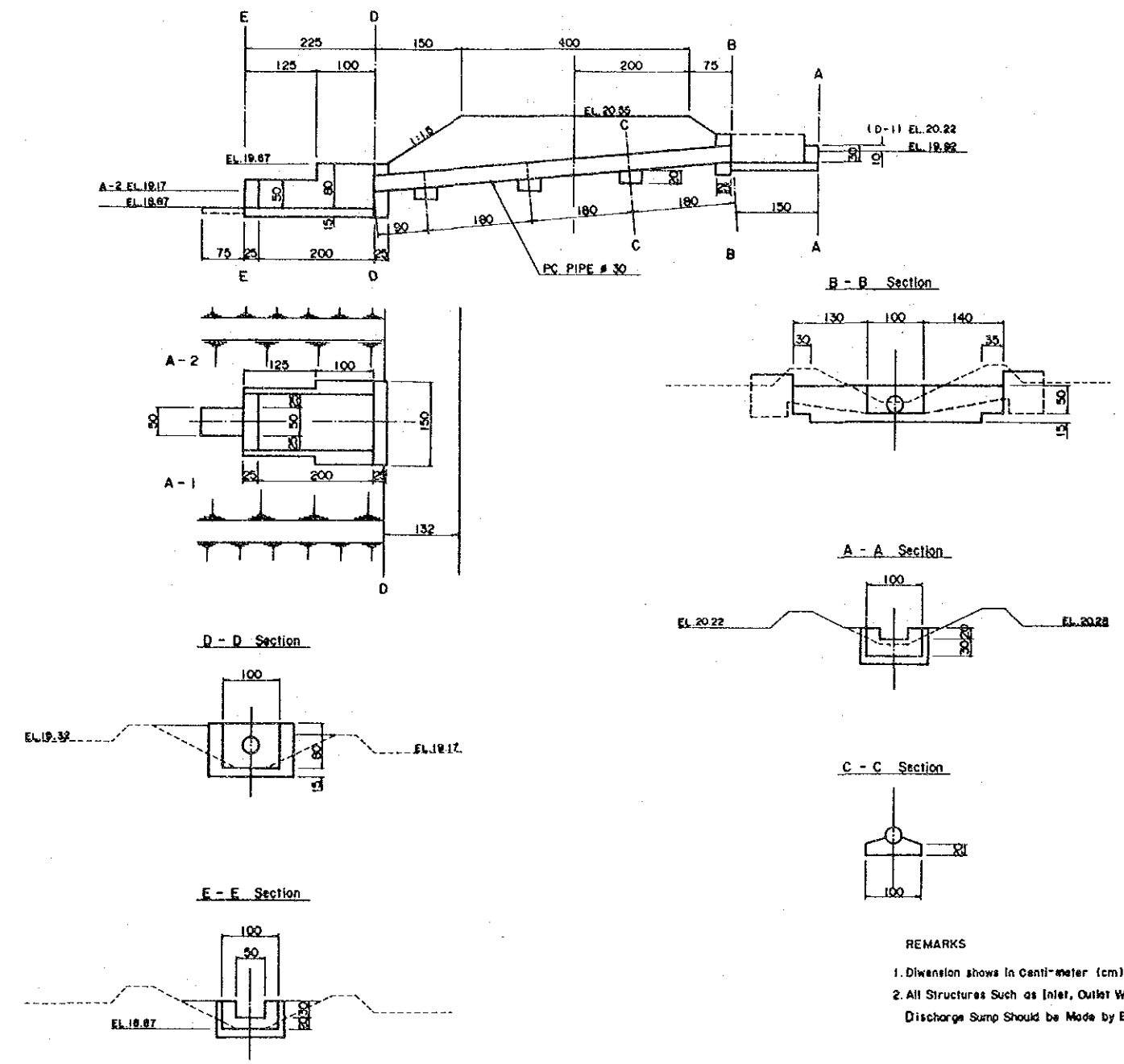
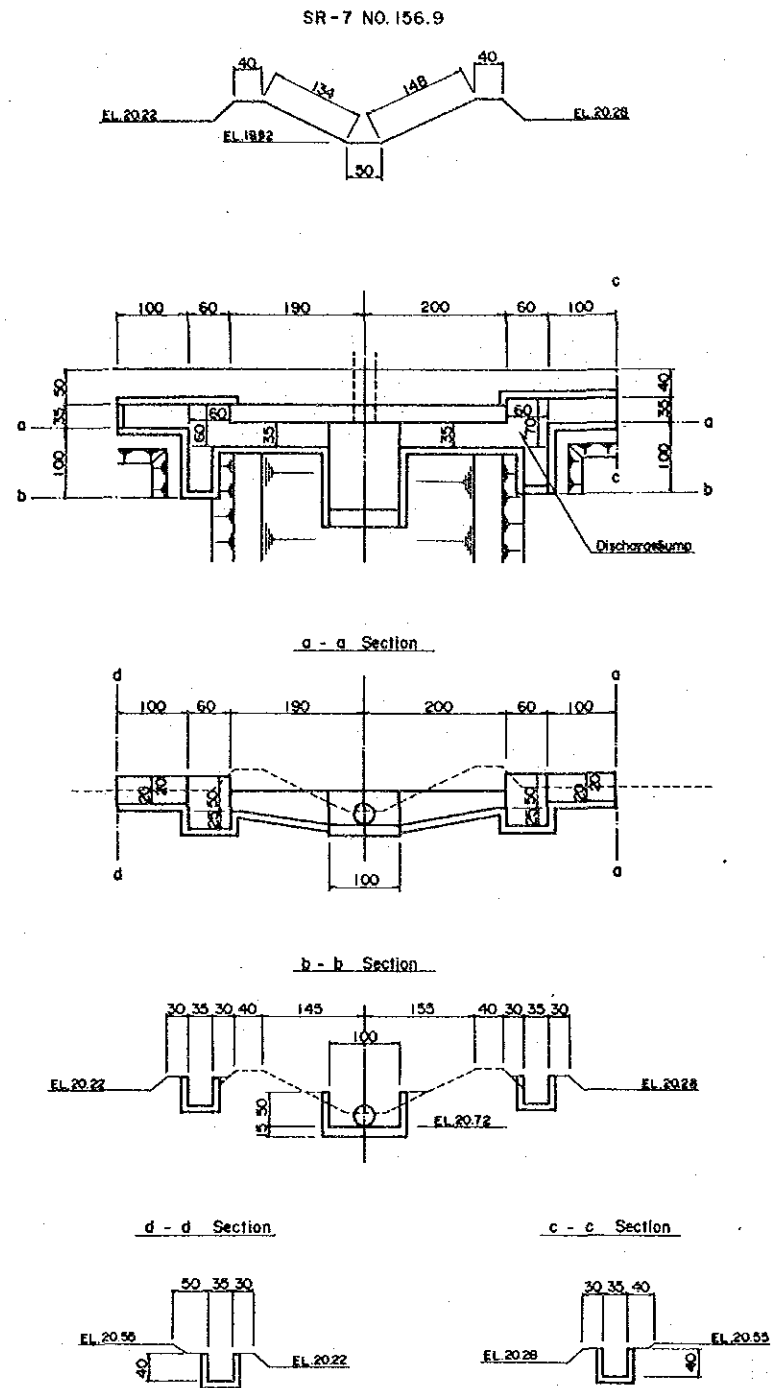

REMARKS
 1. Dimension shows in Centi-meter (cm).
 2. All Structures Such as Inlet, Outlet Wall and Discharge Sump should be Made by Brick.



THE GOVERNMENT OF BANGLADESH
 EXPERIMENTAL FARM CONSTRUCTION PROJECT
 FOR
 THE INSTITUTE OF POSTGRADUATE STUDIES
 IN AGRICULTURE (IPSA), SALNA
 TITLE OF DRAWING
 D-BLOCK DESIGN DRAWING OF
 DRAINAGE SYSTEM
 JAPAN INTERNATIONAL COOPERATION AGENCY
 TOKYO JAPAN
 DWG.NO.
 14

E-BLOCK DESIGN DRAWING OF DRAINAGE SYSTEM S-1/50

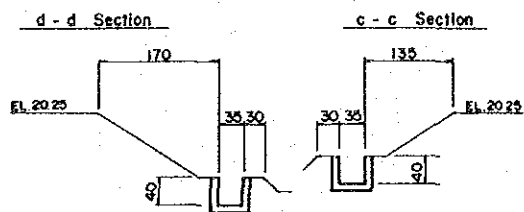
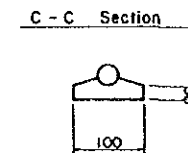
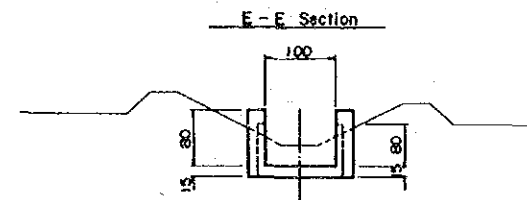
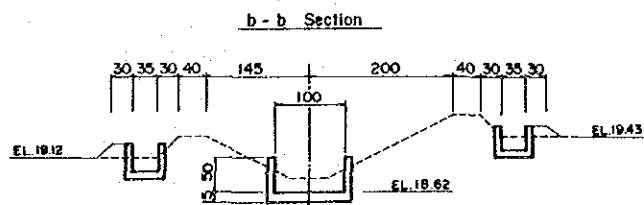
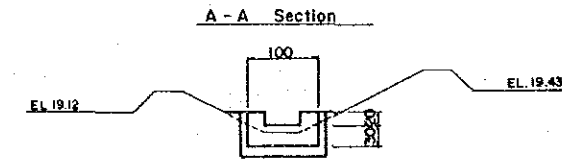
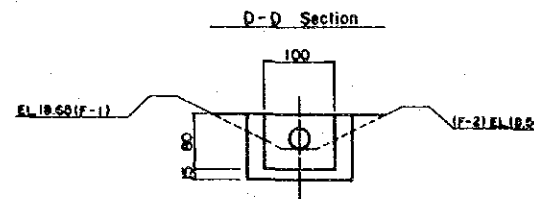
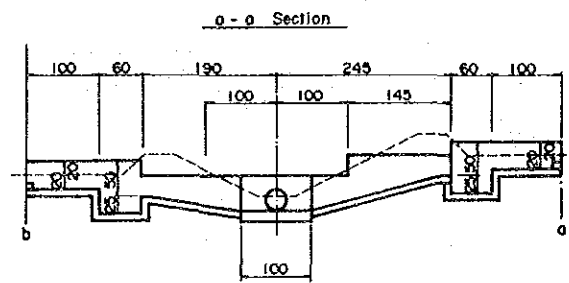
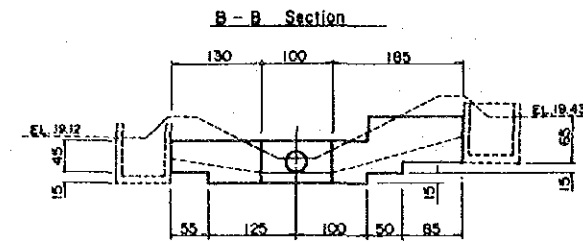
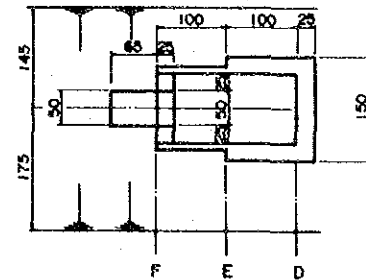
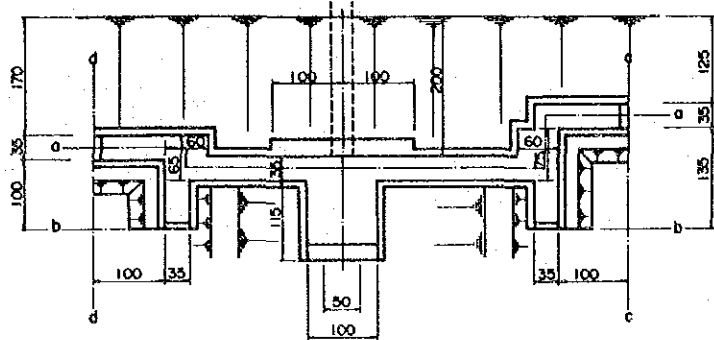
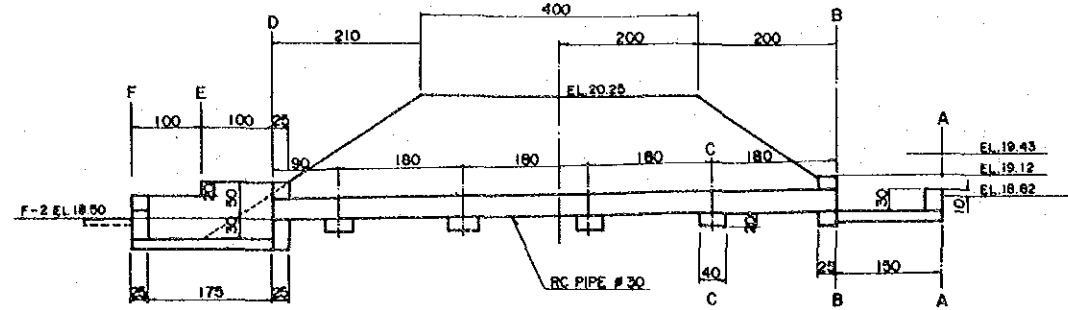
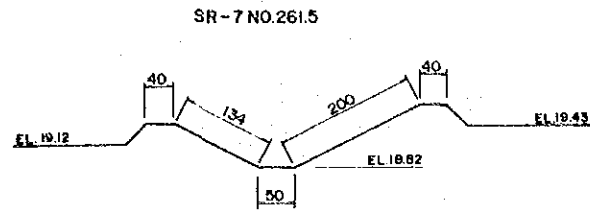

REMARKS

1. Dimension Shows in Centi-meter (cm).
2. All Structures Such as Inlet, Outlet Well and Discharge Sump Should be Made by Brick.

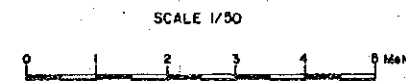

THE GOVERNMENT OF BANGLADESH EXPERIMENTAL FARM CONSTRUCTION PROJECT FOR THE INSTITUTE OF POSTGRADUATE STUDIES IN AGRICULTURE (IPSA), SALNA	
TITLE OF DRAWING E - BLOCK DESIGN DRAWING OF DRAINAGE SYSTEM	
JAPAN INTERNATIONAL COOPERATION AGENCY TOKYO JAPAN	DWG.NO. 15

F - BLOCK DESIGN DRAWING OF DRAINAGE SYSTEM S-1/50

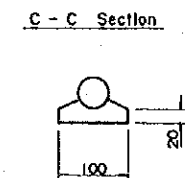
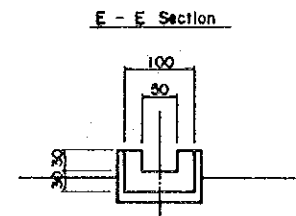
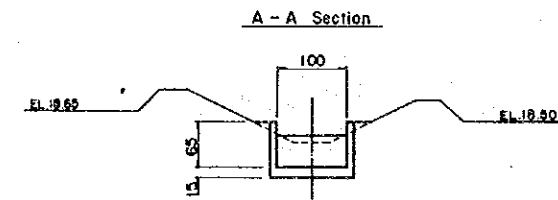
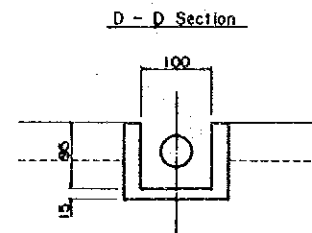
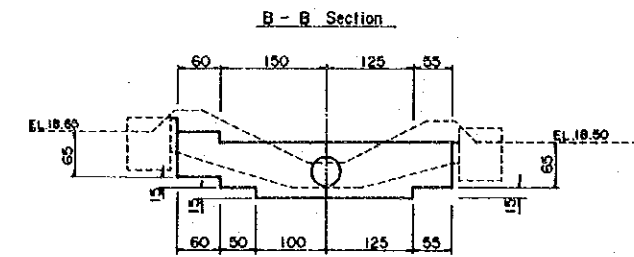
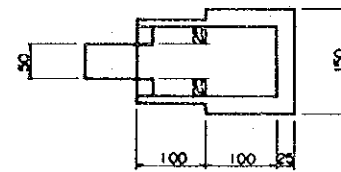
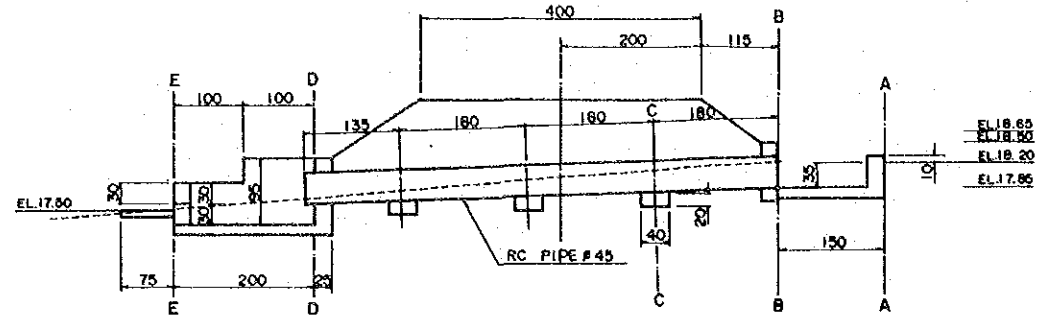
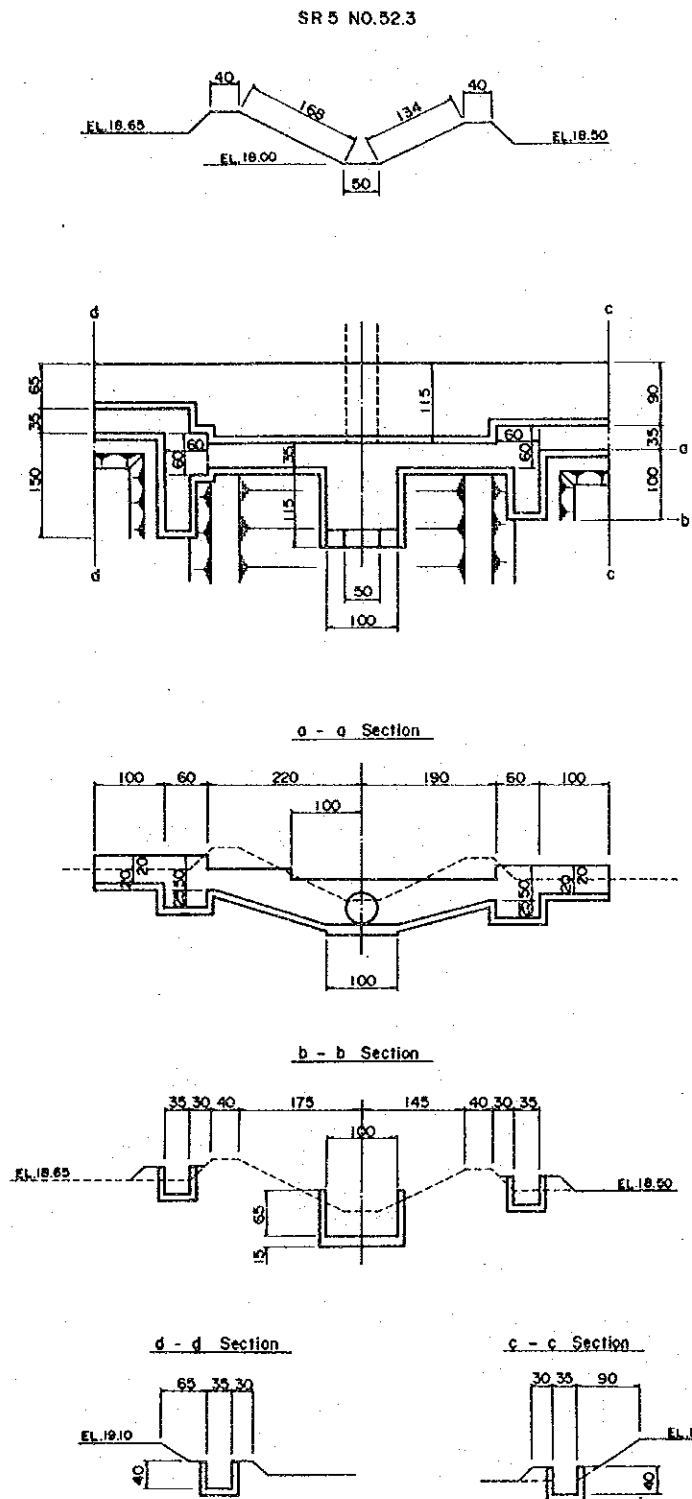

REMARKS

- 1 Dimension given in centi-meter (cm).
- 2 All structures such as inlet, outlet wall and discharge pump should be made by brick.

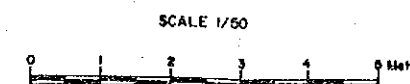

THE GOVERNMENT OF BANGLADESH EXPERIMENTAL FARM CONSTRUCTION PROJECT FOR THE INSTITUTE OF POSTGRADUATE STUDIES IN AGRICULTURE (IPSA), SALNA	
TITLE OF DRAWING F - BLOCK DESIGN DRAWING OF DRAINAGE SYSTEM	
JAPAN INTERNATIONAL COOPERATION AGENCY TOKYO JAPAN	DWG. NO. 16

G-BLOCK DESIGN DRAWING OF DRAINAGE SYSTEM

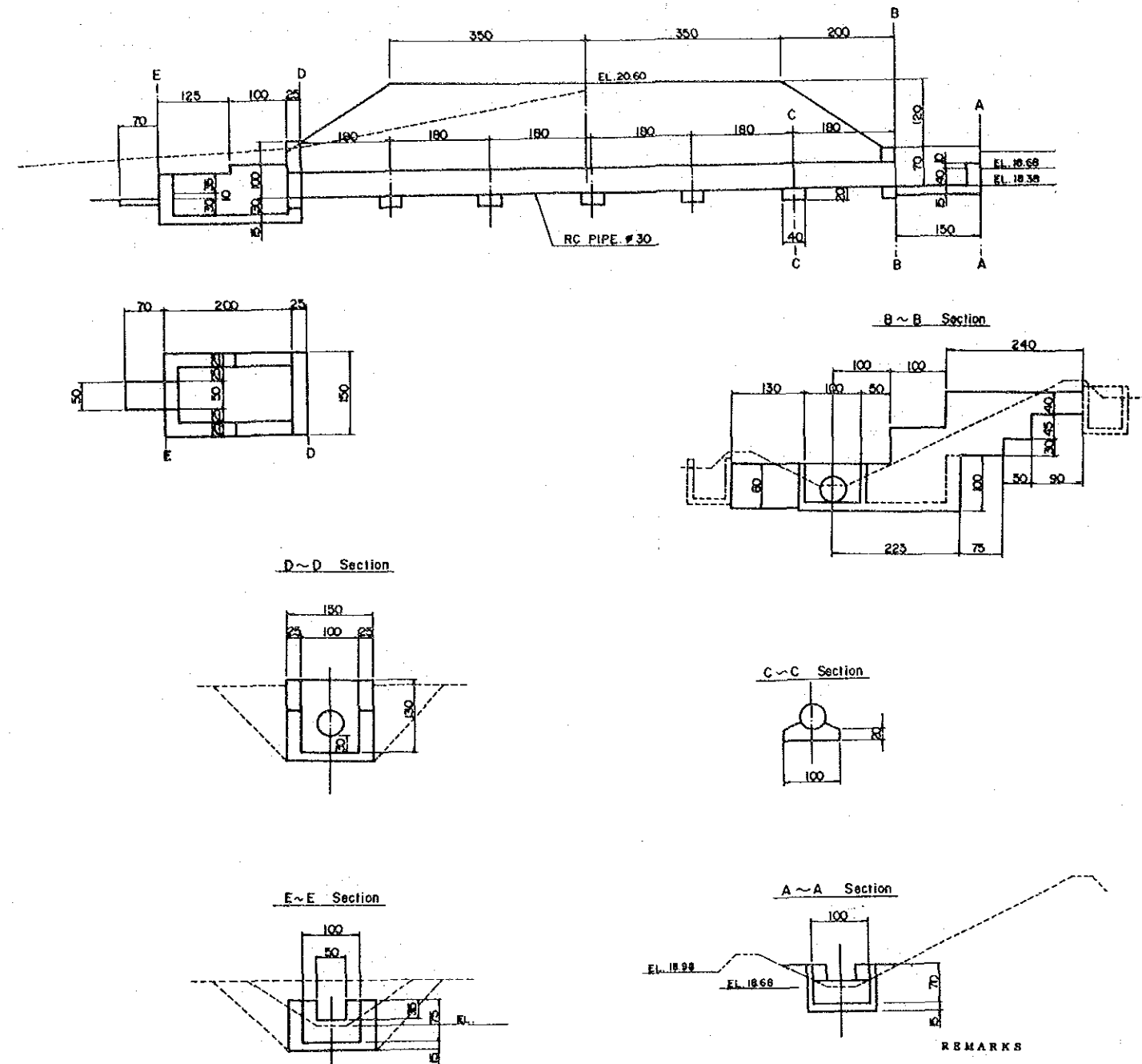
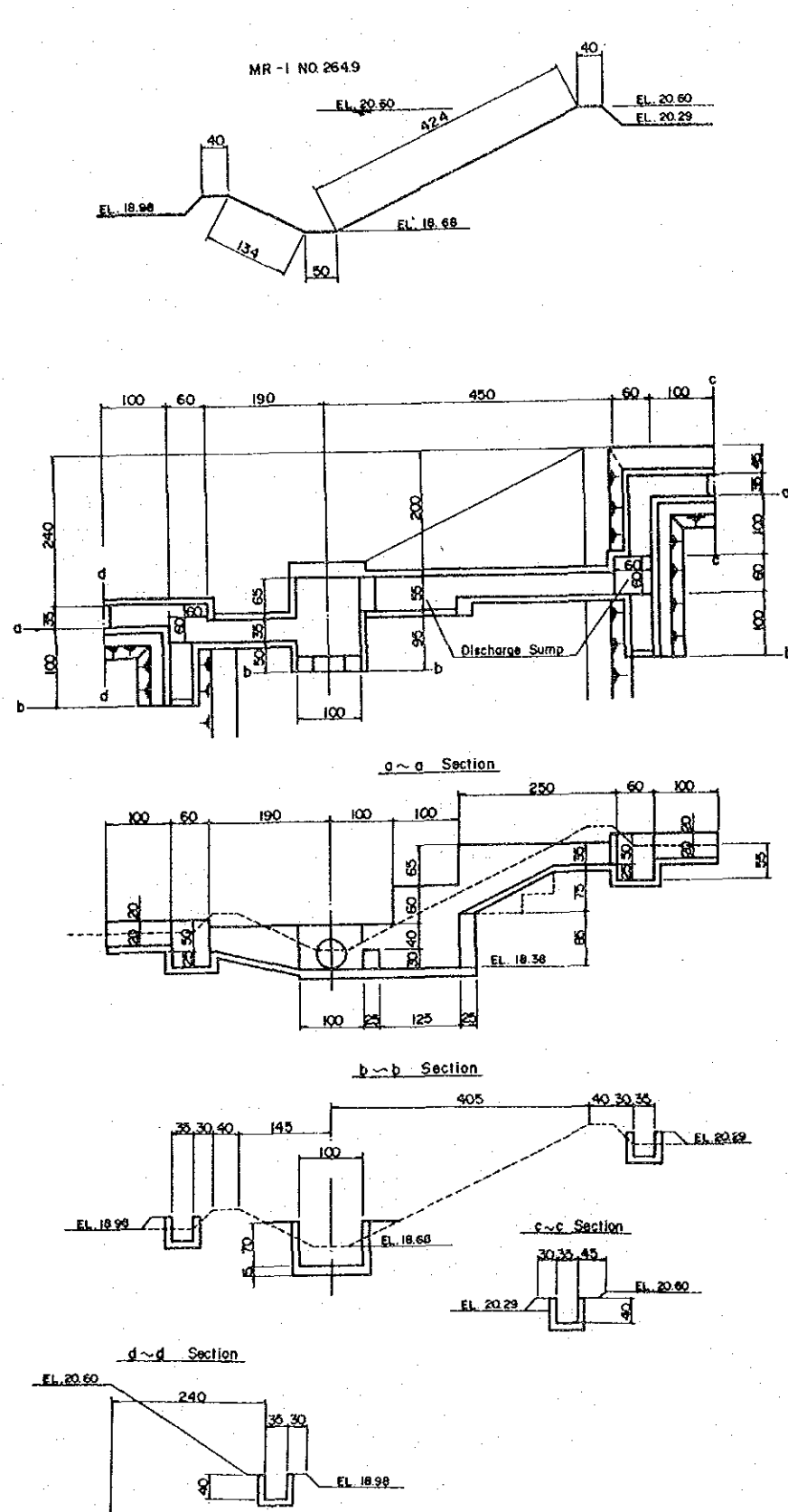

REMARKS
 1 Dimension shown in centi-meter(cm).
 2 All structures such as inlet, outlet well and discharge sump should be made by brick.

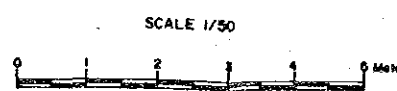

THE GOVERNMENT OF BANGLADESH EXPERIMENTAL FARM CONSTRUCTION PROJECT FOR THE INSTITUTE OF POSTGRADUATE STUDIES IN AGRICULTURE (IPSA), SALNA	
TITLE OF DRAWING G-BLOCK DESIGN DRAWING OF DRAINAGE SYSTEM	
JAPAN INTERNATIONAL COOPERATION AGENCY TOKYO JAPAN	DWG. NO. 17

H-BLOCK DESIGN DRAWING OF DRAINAGE SYSTEM (Nursery bed) S-1/50

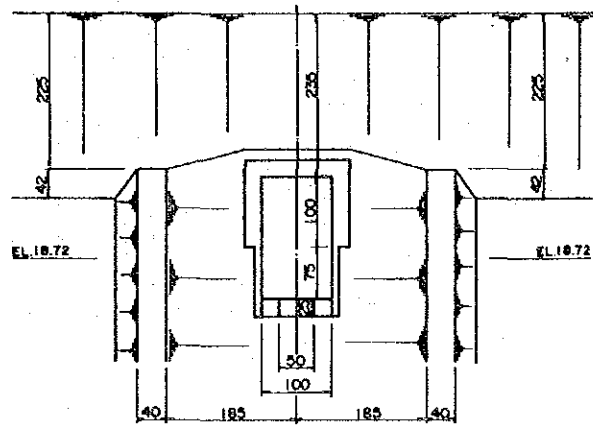
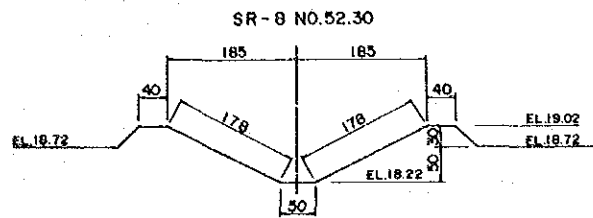

D - D Section

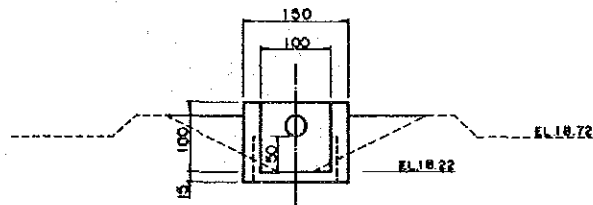

E - E Section

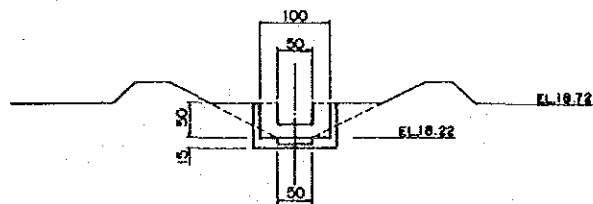

Outlet of drainage

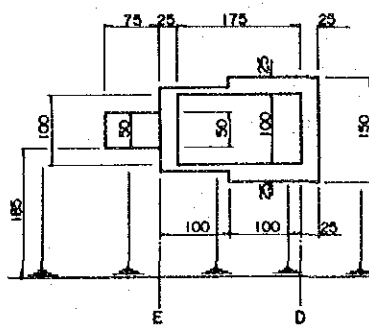
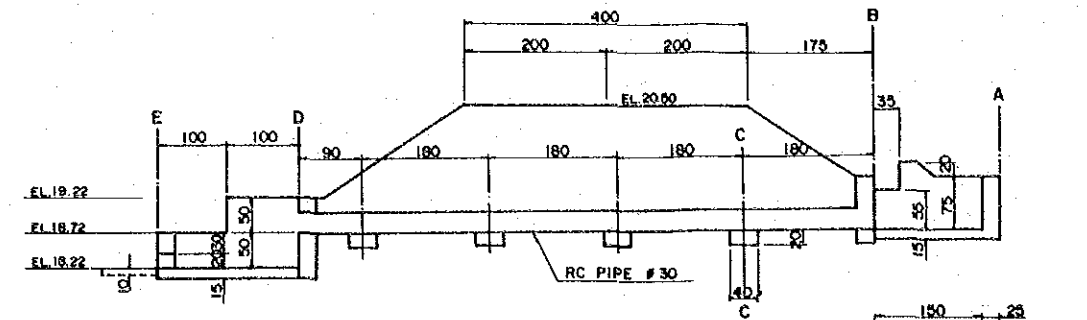
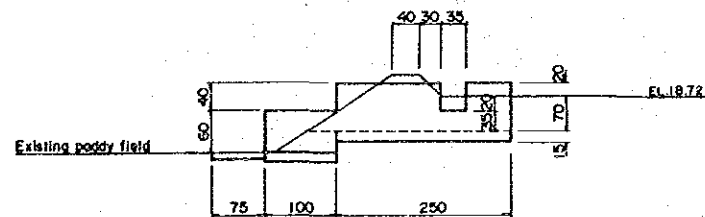

a - a Section

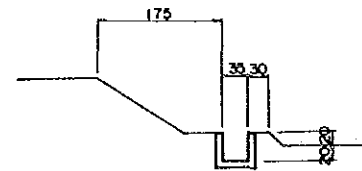

I - BLOCK (drainage Canal)

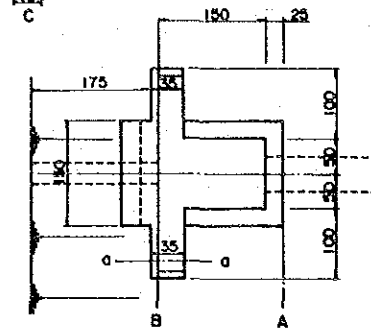
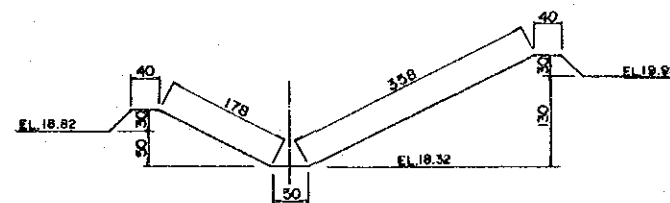

B - B Section

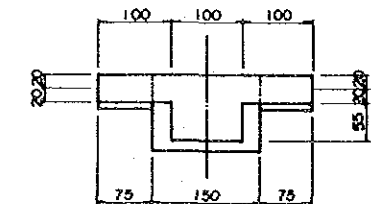

A - A Section

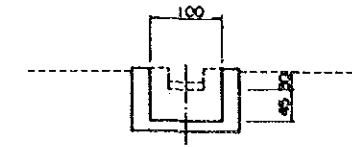

C - C Section

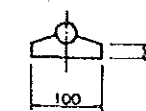

REMARKS

- 1 Dimension shown in centi-meter (cm).
- 2 All structures such as inlet, outlet wall and discharge pump should be made by brick.

THE GOVERNMENT OF BANGLADESH
EXPERIMENTAL FARM CONSTRUCTION PROJECT
FOR
THE INSTITUTE OF POSTGRADUATE STUDIES
IN AGRICULTURE (IPSA), SALNA

TITLE OF DRAWING
H-BLOCK DESIGN DRAWING OF
DRAINAGE SYSTEM

JAPAN INTERNATIONAL COOPERATION AGENCY
TOKYO JAPAN

DWG. NO.
18

SCALE 1/50



LOCATION OF THE PIPE DRAINED FIELD

SCALE
0 40 80(m)

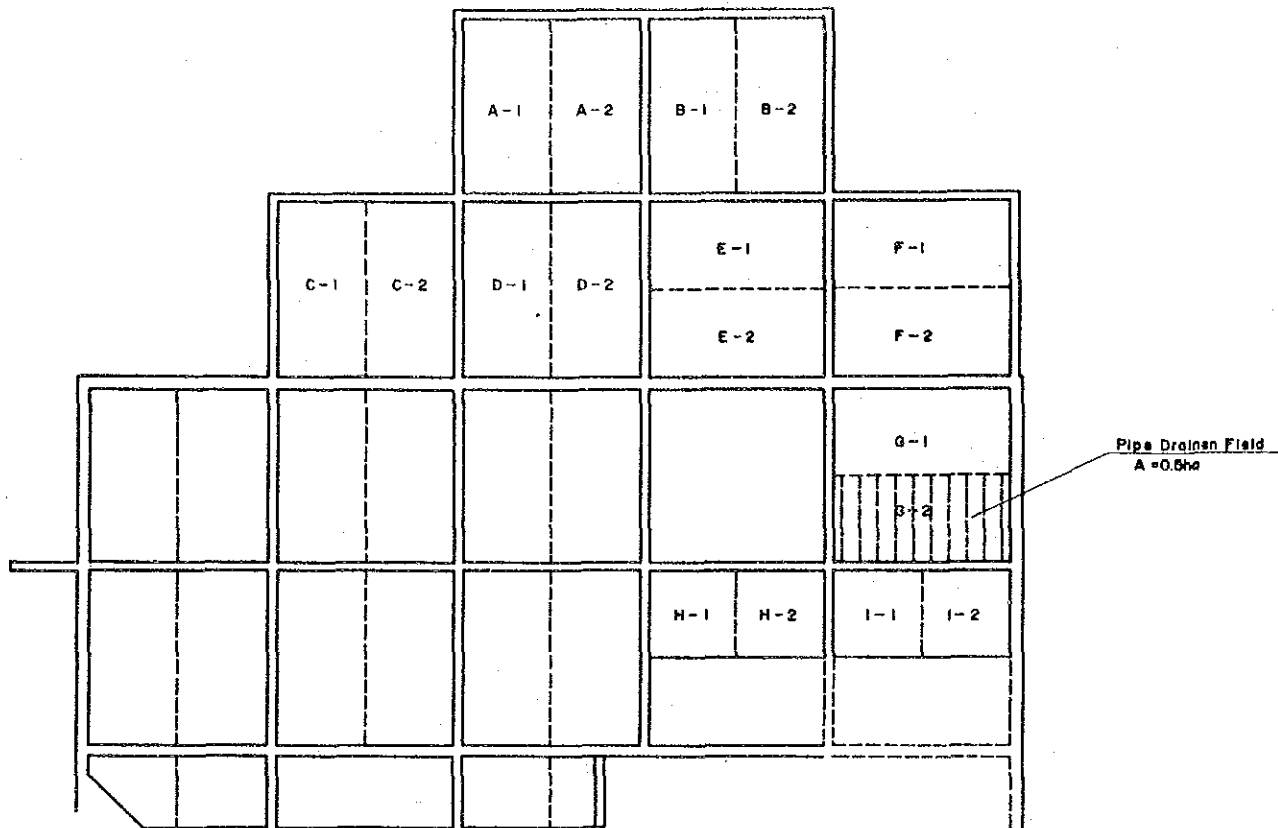

PIPE DRAIN PLAN (G-2 BLOCK)

SCALE
0 10 20 (m)

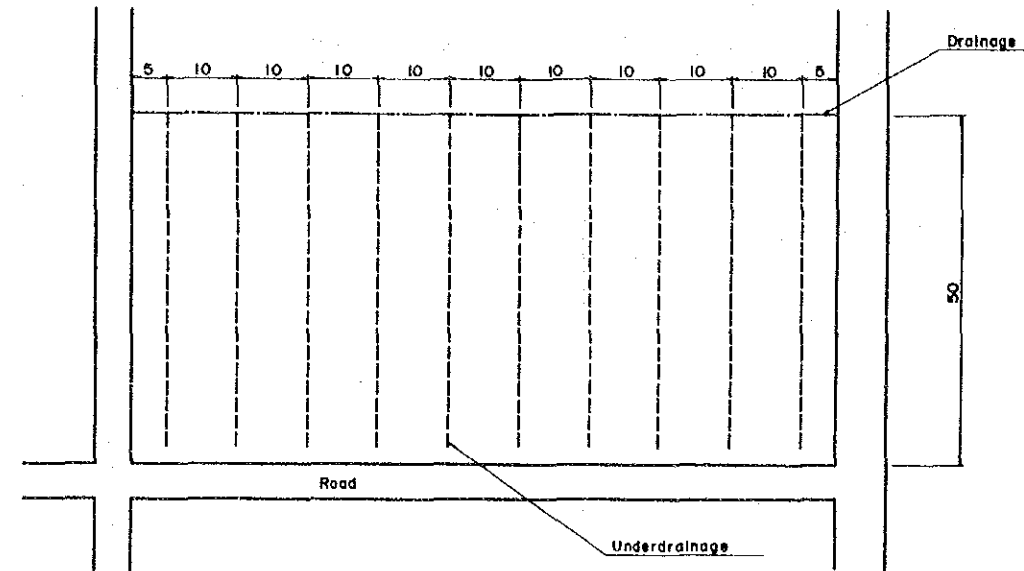

LONG SECTION

SCALE
0 400 800 (mm)

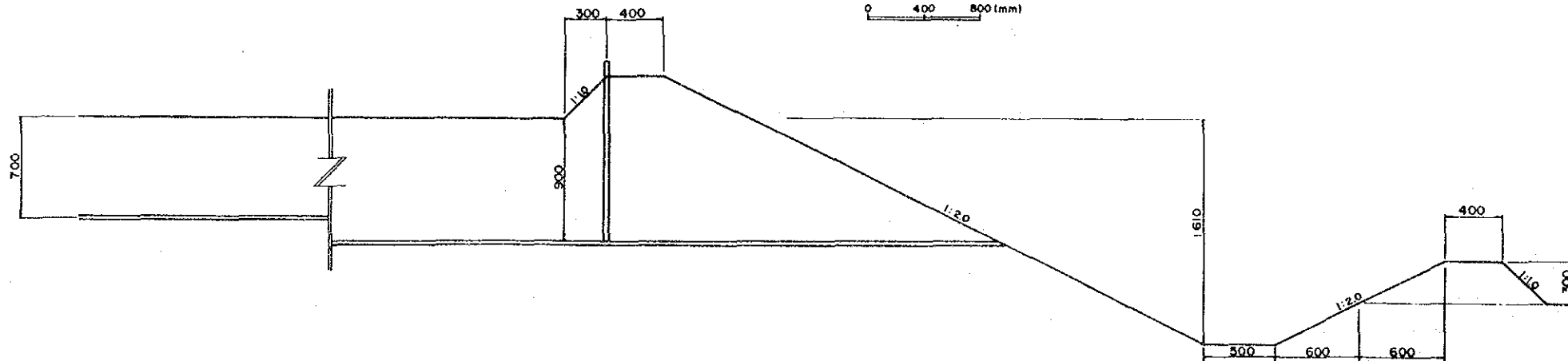

CROSS SECTION

SCALE
0 200 400(mm)

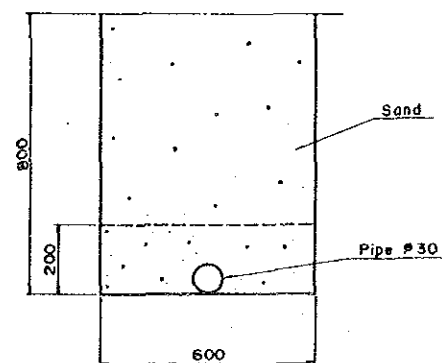

THE GOVERNMENT OF BANGLADESH
EXPERIMENTAL FARM CONSTRUCTION PROJECT
FOR
THE INSTITUTE OF POSTGRADUATE STUDIES
IN AGRICULTURE (IPSA), SALNA

TITLE OF DRAWING
PIPE DRAIN PLAN

JAPAN INTERNATIONAL COOPERATION AGENCY TOKYO JAPAN DWG.NO. 19

JICA