

No. 31

**LA PRIMAVERA  
GEOHERMAL DEVELOPMENT PROJECT  
IN UNITED MEXICAN STATES**

**FINAL REPORT  
APPENDIX**

FEBRUARY, 1989

**JAPAN INTERNATIONAL COOPERATION AGENCY**

MPN
CR (3)
89-63

LA PRIMAVERA GEOHERMAL DEVELOPMENT PROJECT IN UNITED MEXICAN STATES FINAL REPORT APPENDIX FEBRUARY 1989

53



JICA LIBRARY



1073141[2]

10936



**LA PRIMAVERA  
GEOTHERMAL DEVELOPMENT PROJECT  
IN UNITED MEXICAN STATES**

**FINAL REPORT  
APPENDIX**

**FEBRUARY. 1989**

**JAPAN INTERNATIONAL COOPERATION AGENCY**



国際協力事業団

18936



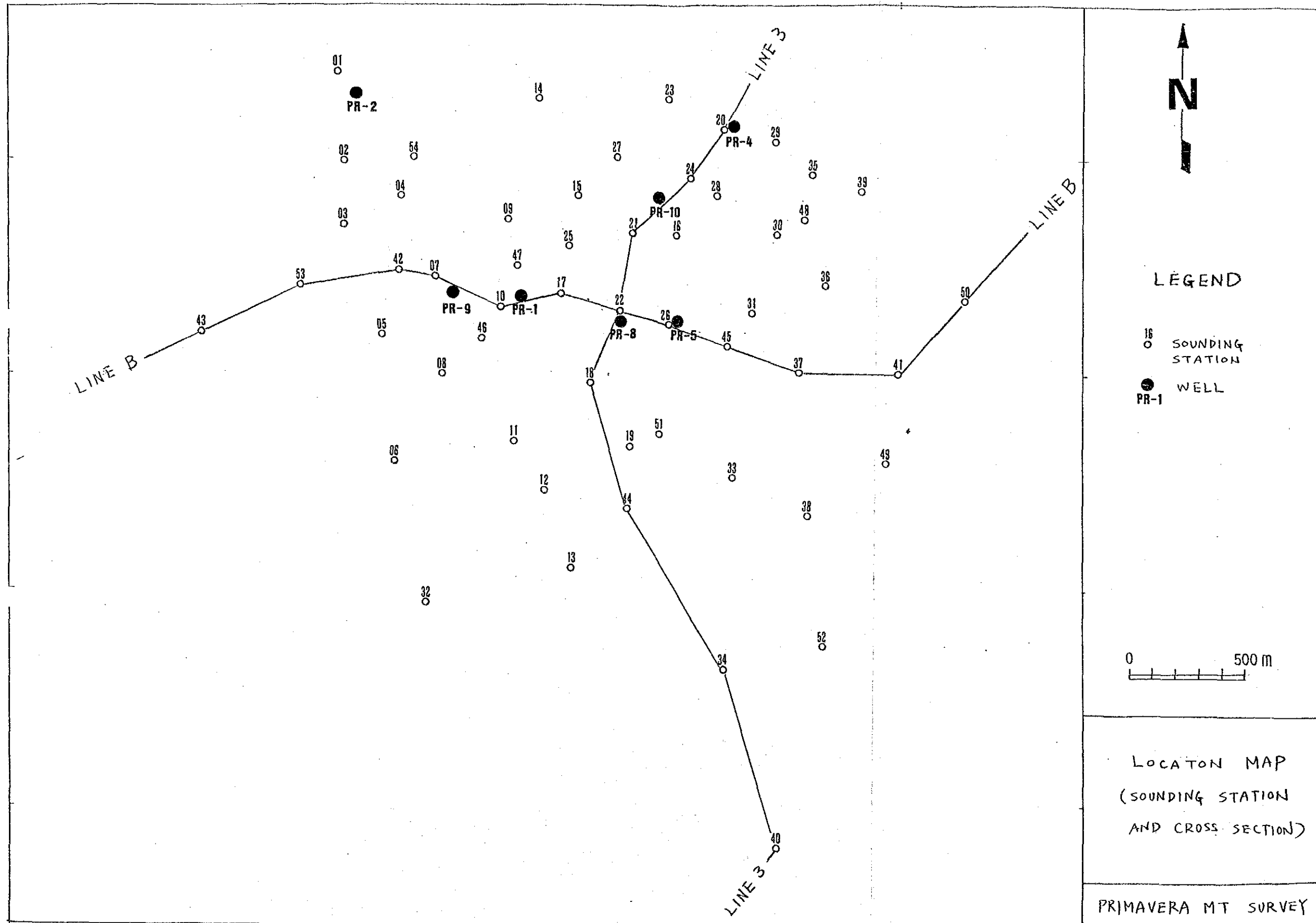

LOCATION MAP  
(SOUNDING STATION  
AND CROSS SECTION)  
PRIMAVERA MT SURVEY







PRIMAVERA MT SURVEY  
THE RESULTS OF MODE SELECTION

ST Nō.	MODE		ST Nō.	MODE		ST Nō.	MODE		ST Nō.	MODE	
	TE	TM		TE	TM		TE	TM		TE	TM
01	XY	YX	15	YX	XY	29	XY	YX	43	XY	YX
02	XY	YX	16	X Y	YX	30	YX	XY	44	YX	X Y
03	YX	XY	17	XY	YX	31	YX	XY	45	XY	YX
04	YX	XY	18	XY	YX	32	YX	XY	46	XY	YX
05	YX	XY	19	XY	YX	33	YX	XY	47	YX	XY
06	XY	YX	20	XY	YX	34	XY	YX	48	YX	XY
07	XY	YX	21	XY	YX	35	XY	YX	49	YX	XY
08	X Y	YX	22	XY	YX	36	XY	YX	50	YX	XY
09	XY	YX	23	YX	XY	37	YX	XY	51	YX	XY
10	YX	XY	24	XY	YX	38	XY	YX	52	YX	XY
11	XY	YX	25	XY	YX	39	XY	YX	53	YX	XY
12	XY	YX	26	XY	YX	40	XY	YX	54	YX	XY
13	XY	YX	27	YX	XY	41	YX	XY			
14	YX	XY	28	YX	XY	42	XY	YX			



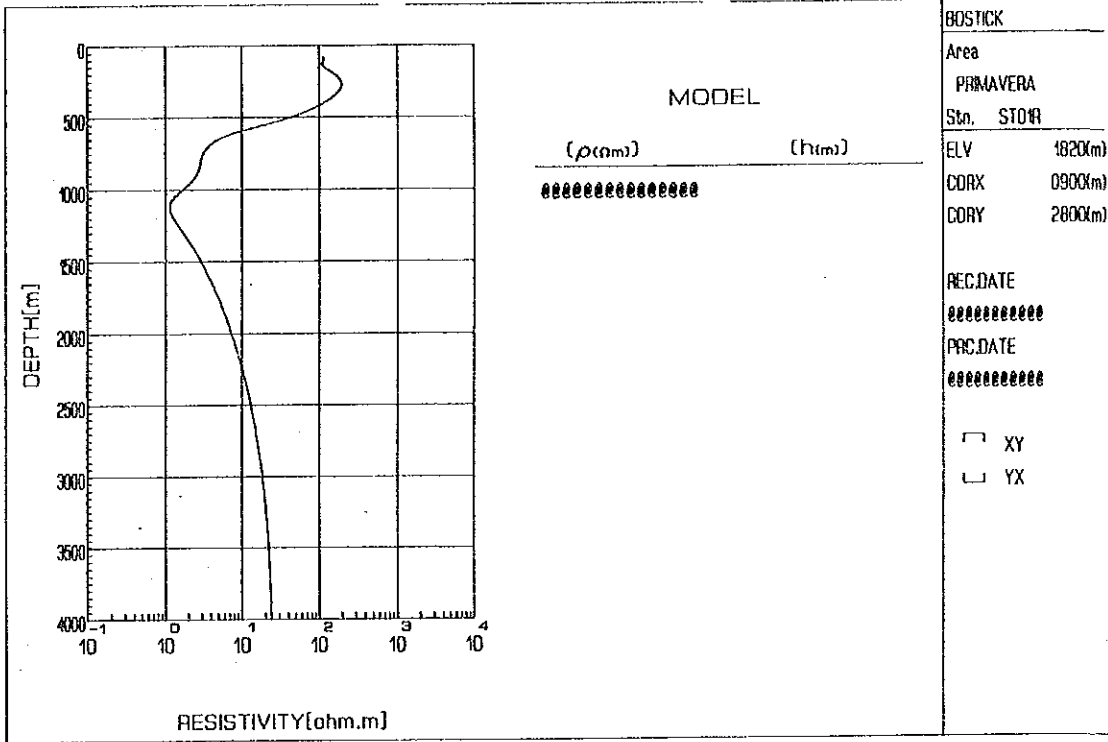

Sta. ST01

May 12 1986

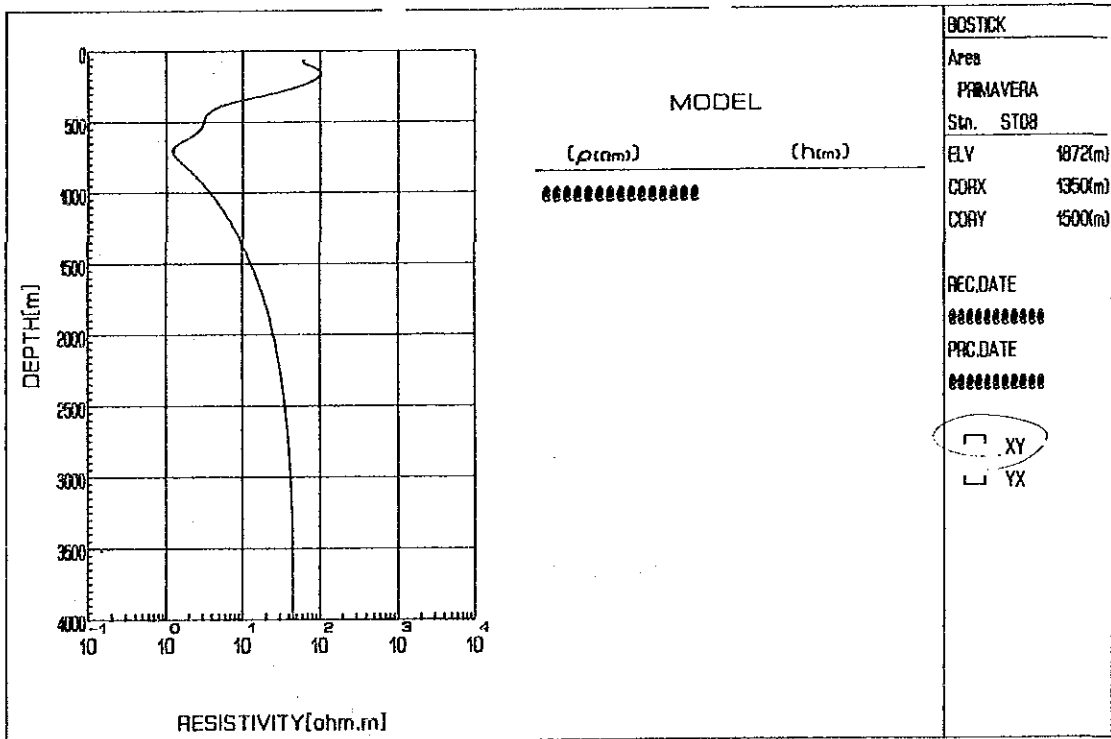

Sta. ST08

May 12 1986

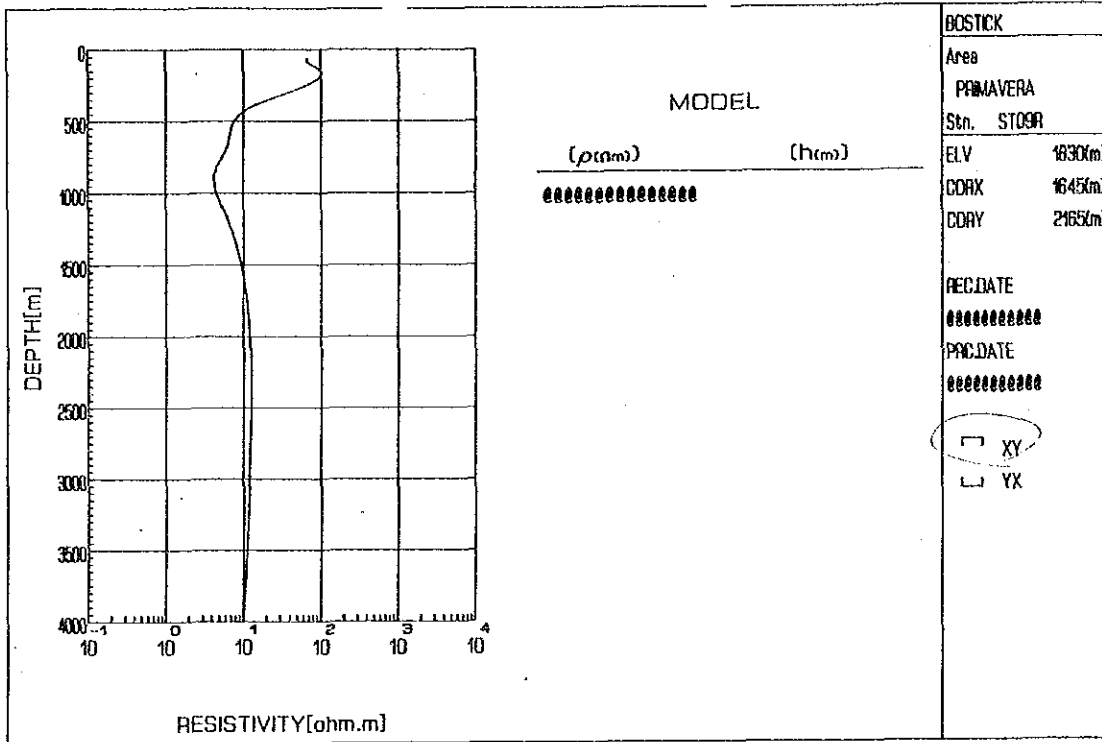

Sta. ST09

May 12 1986

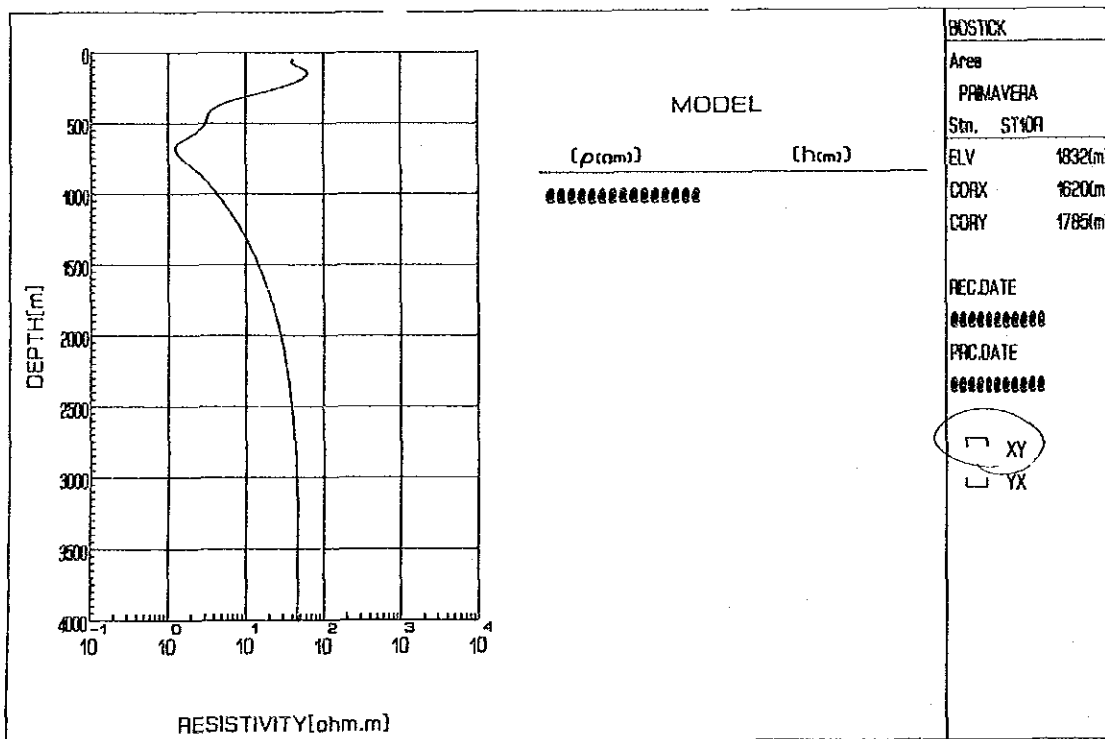

Sta. ST10

May 12 1986

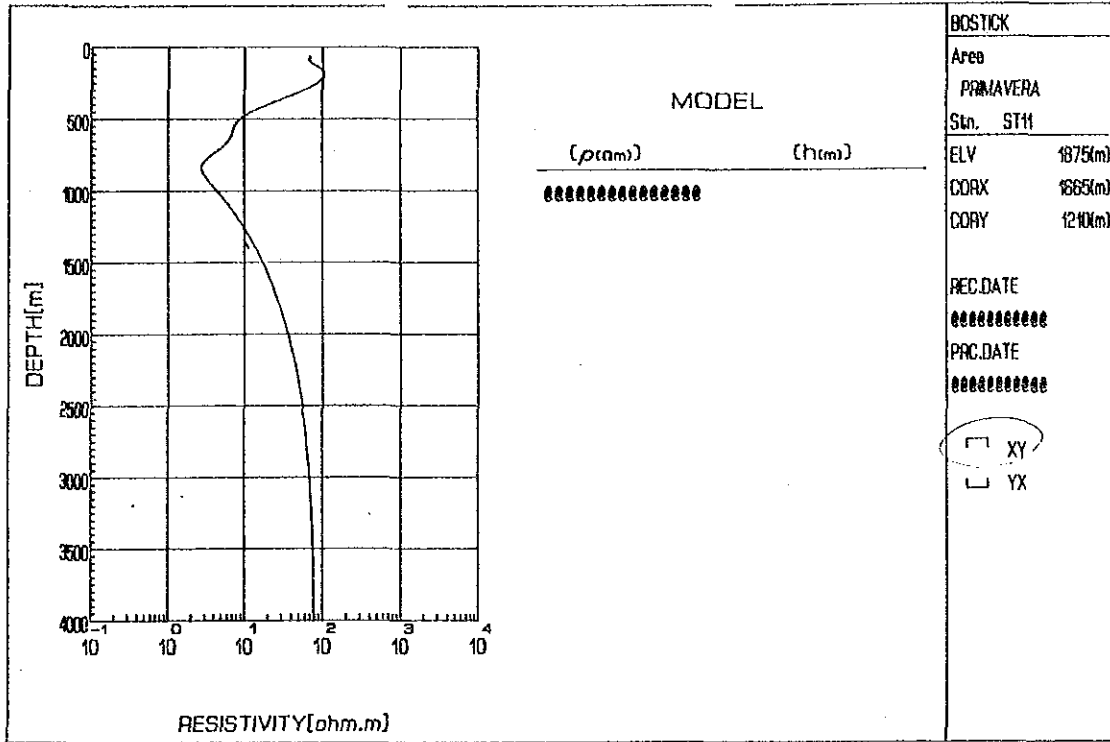

Sta. ST11

May 12 1986

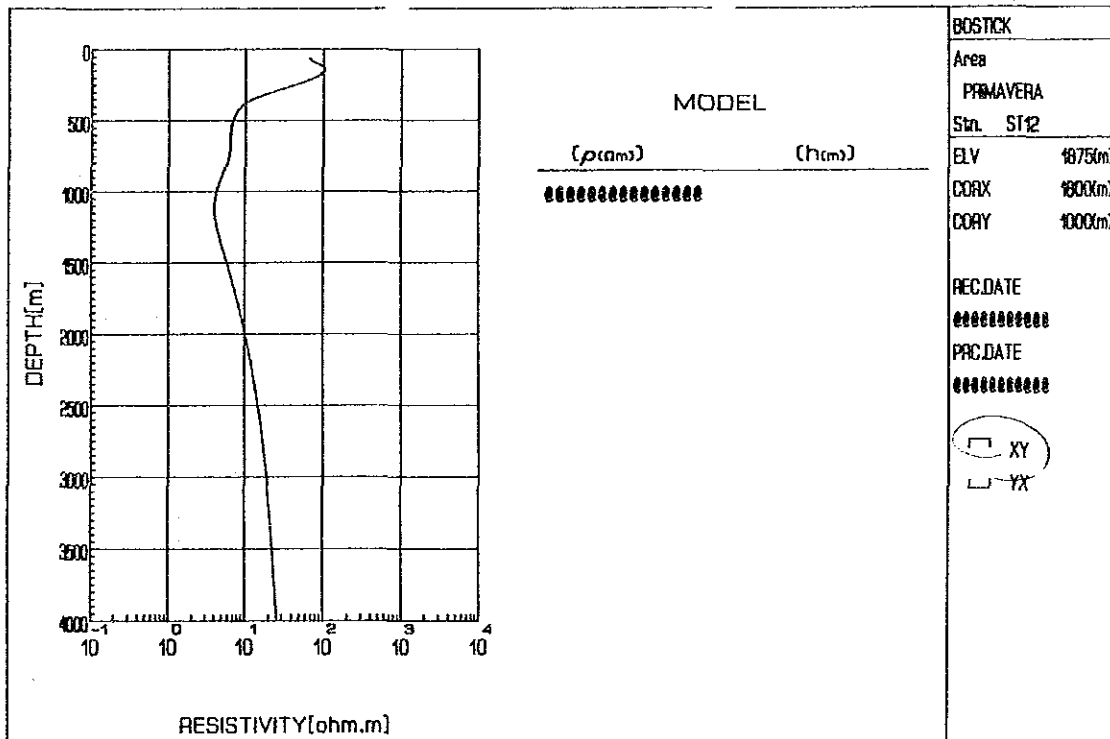

Sta. ST12

May 12 1986

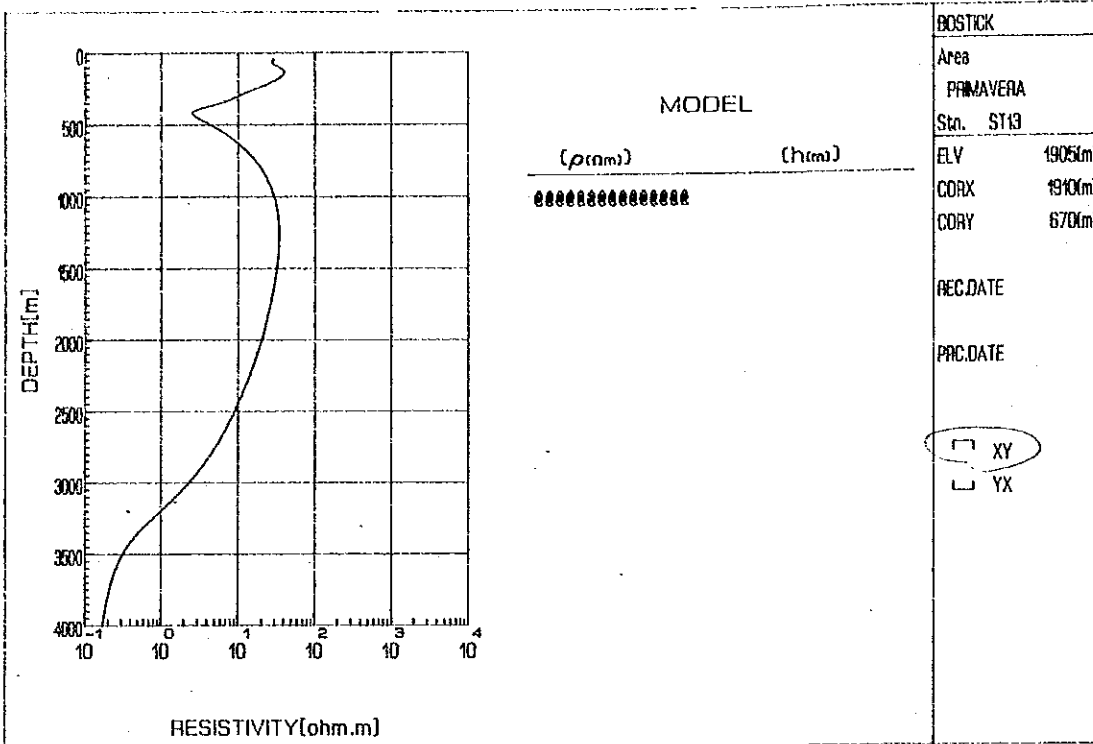

Sta. ST13

May 14 1986

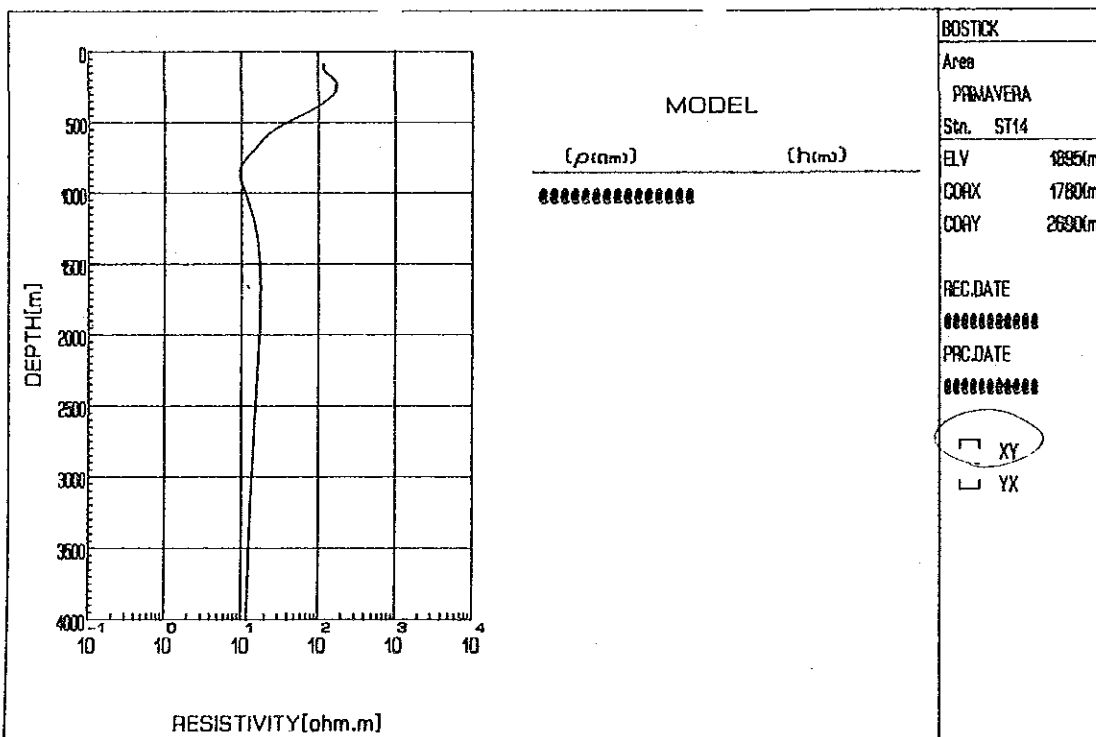

Sta. ST14

May 12 1986



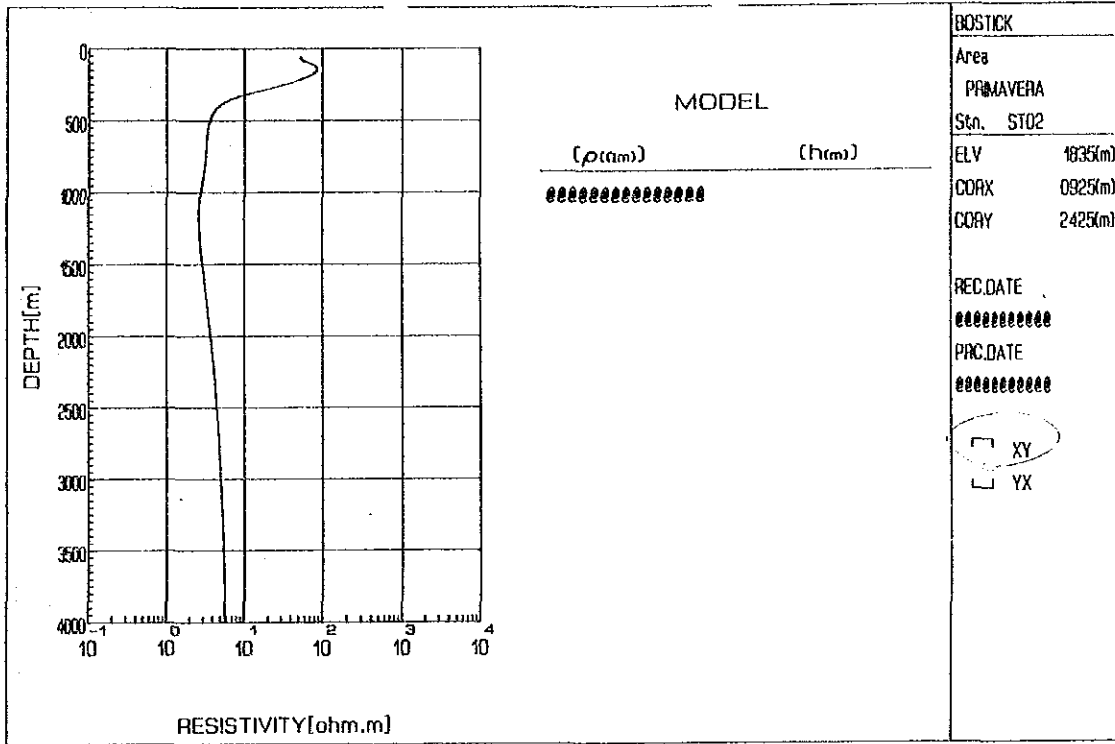

Stn. ST02

May 12 1986

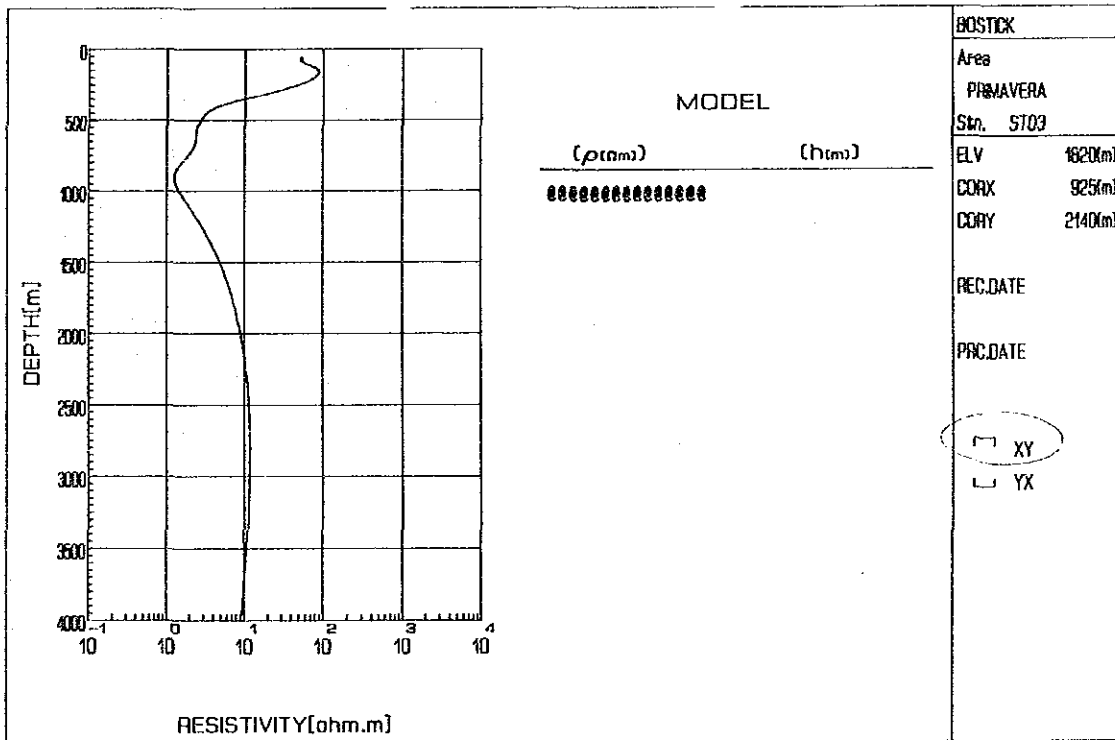

Stn. ST03

May 12 1986

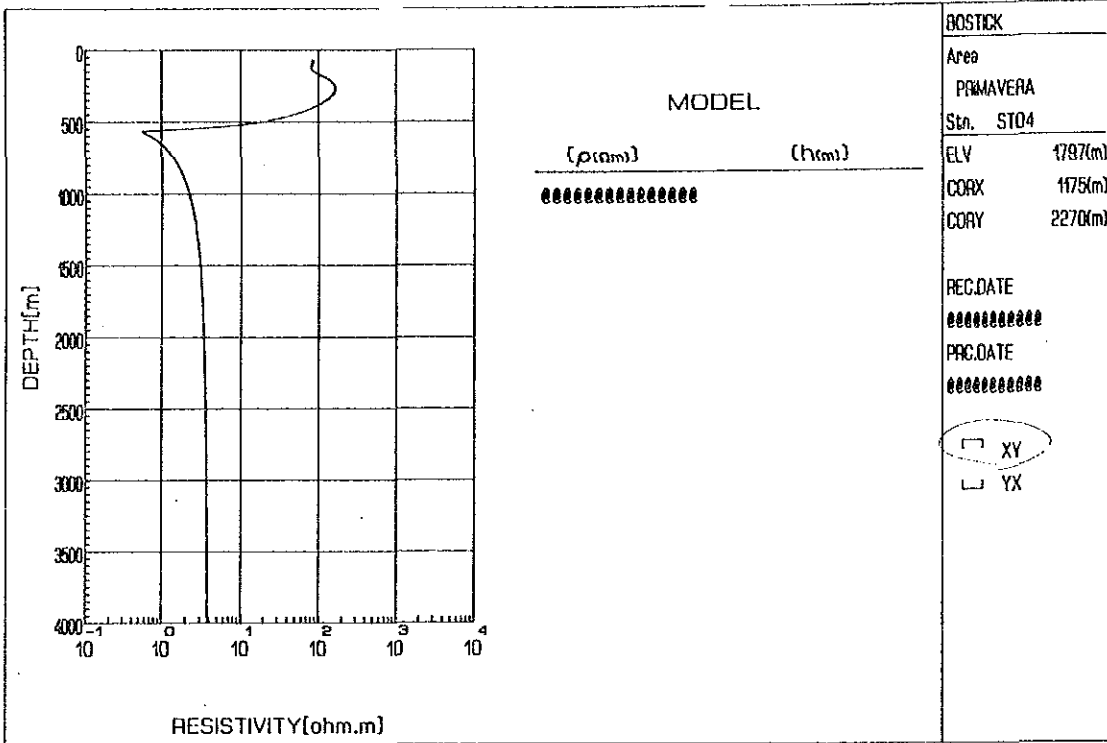

Sta. ST04

May 12 1996

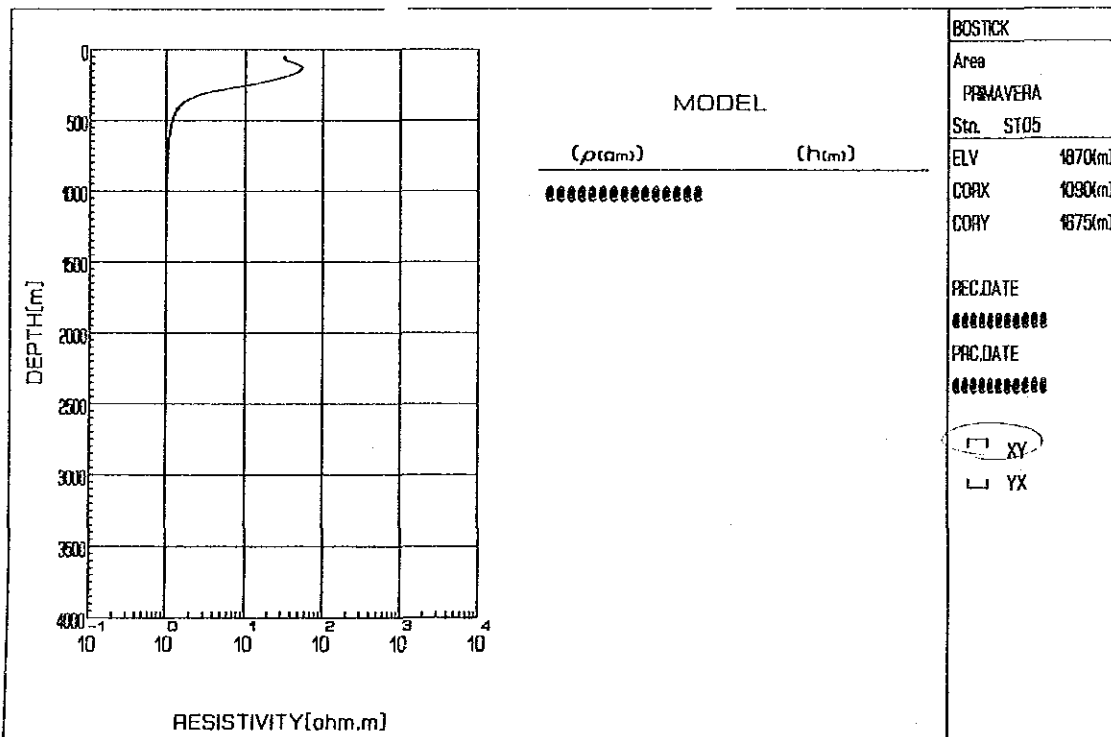

Sta. ST05

May 12 1996

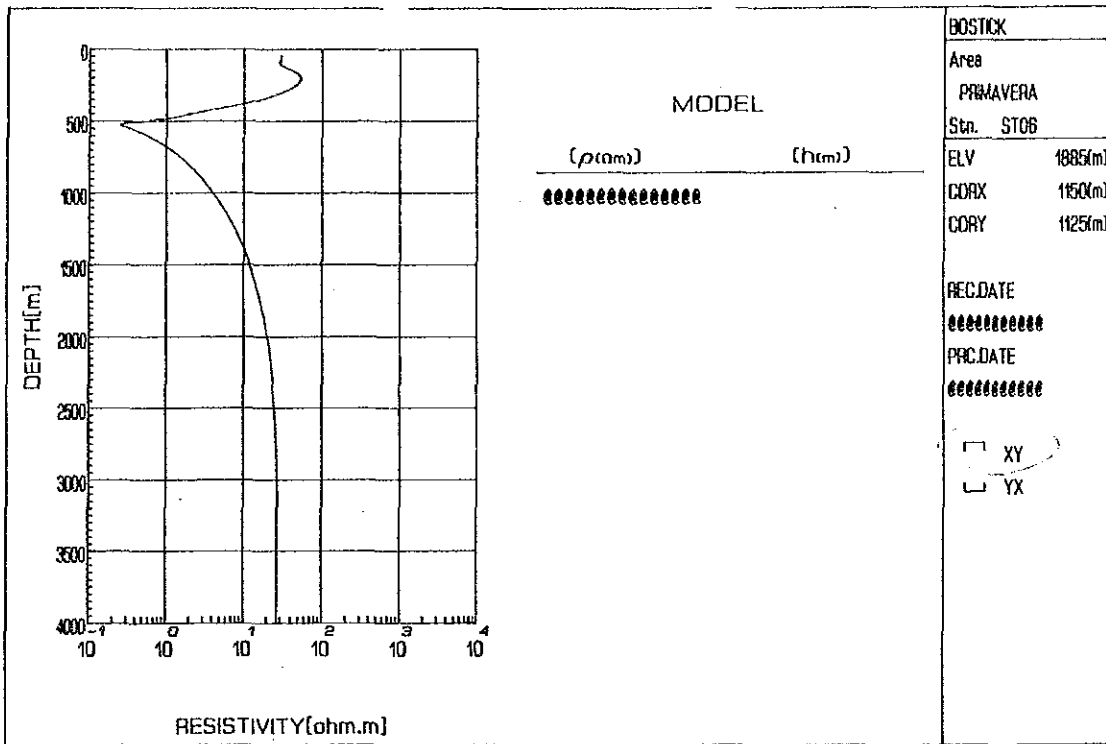

Sta. ST06

May 12 1986

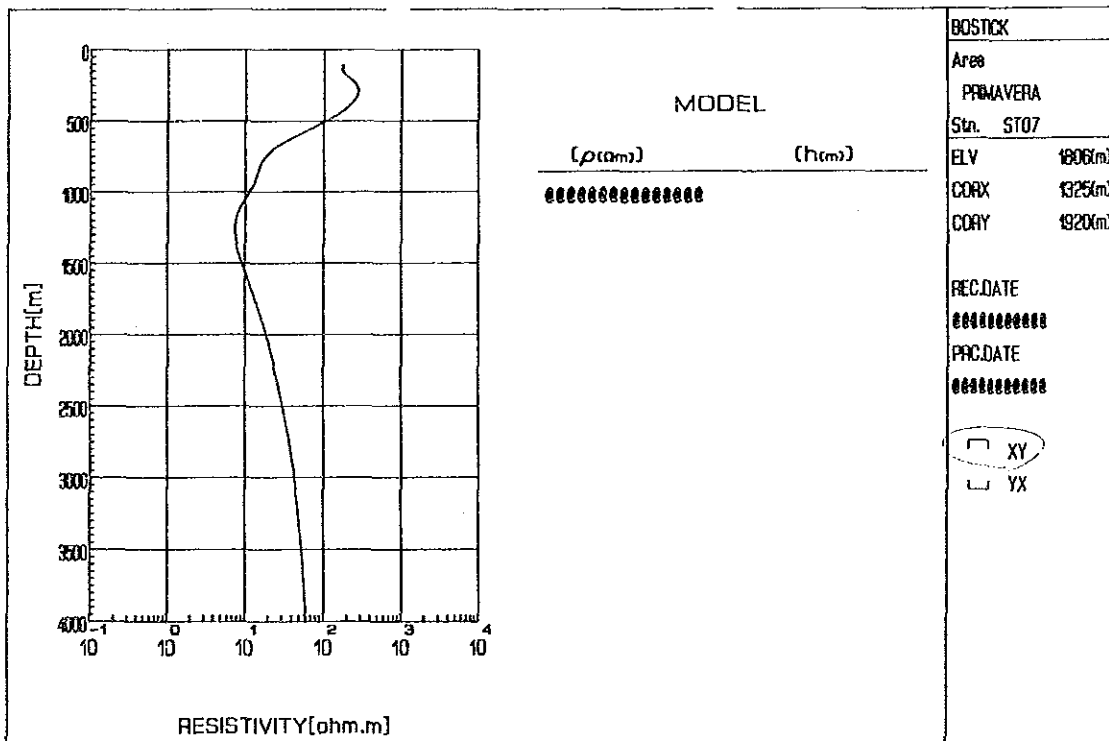

Sta. ST07

May 12 1986

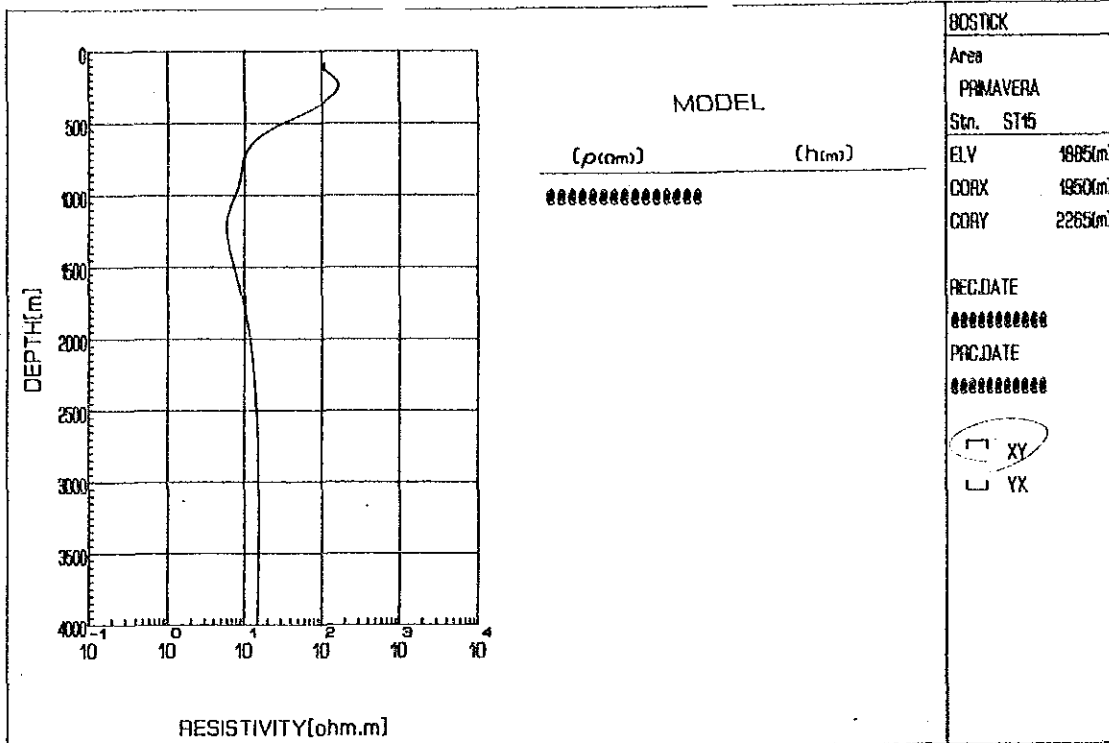

Stn. ST15

May 12 1986

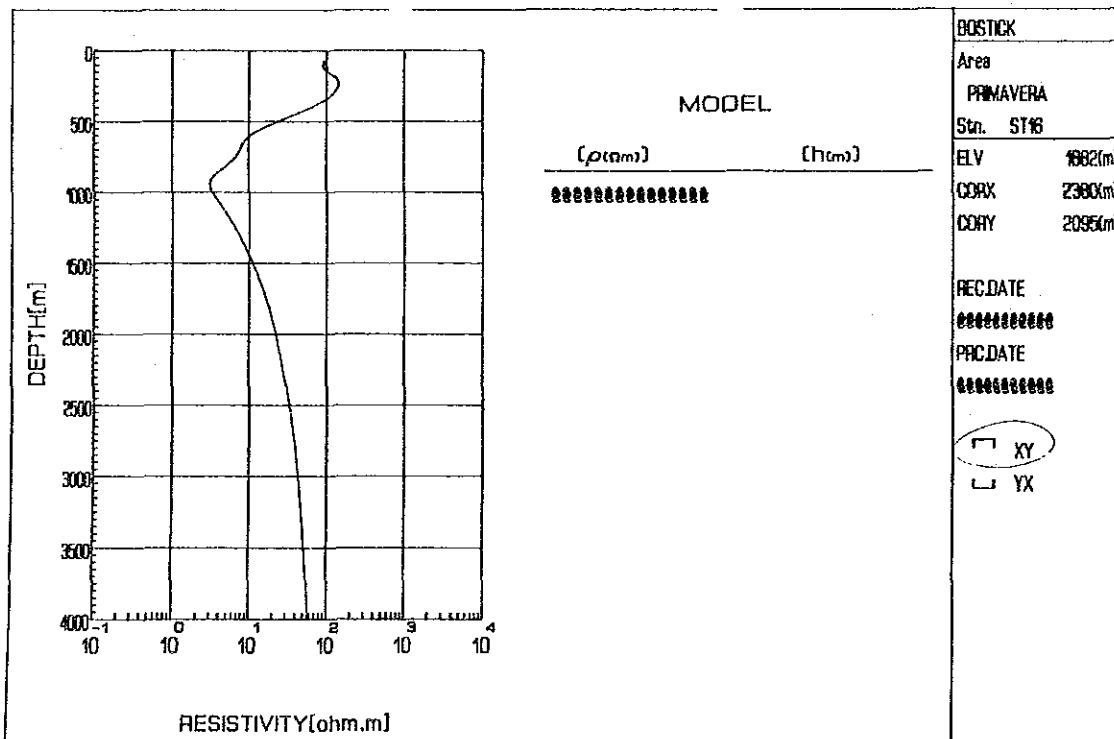

Stn. ST16

May 12 1986

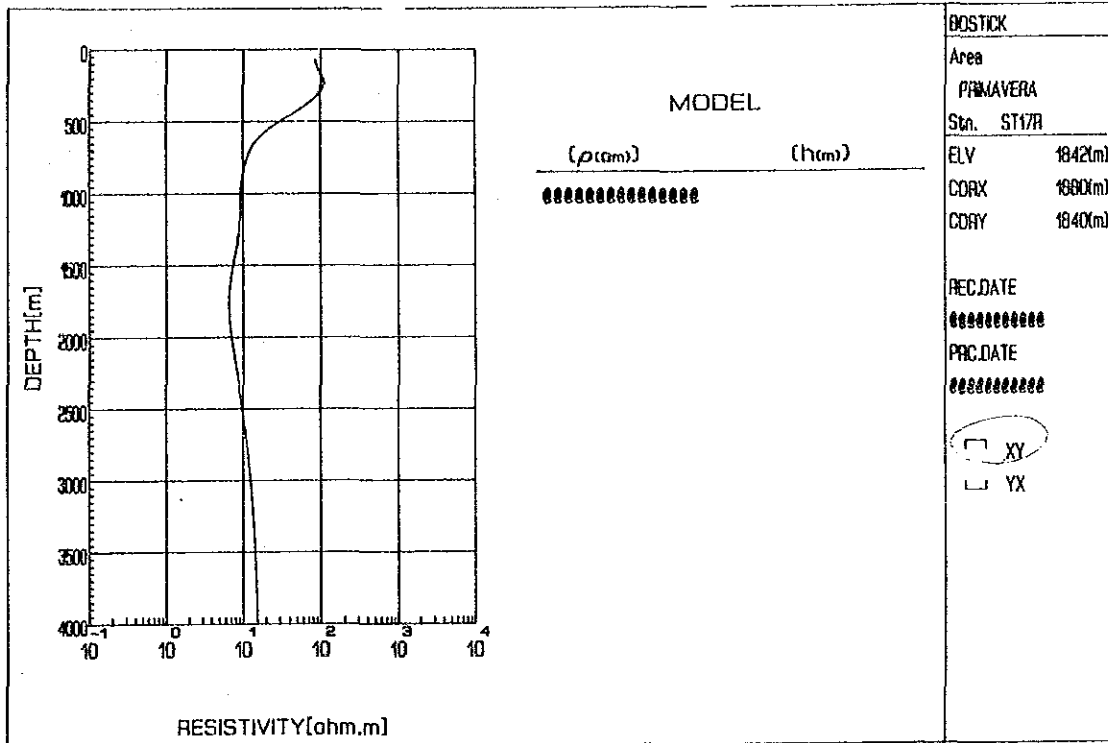

Stn. ST17

May 12 1986

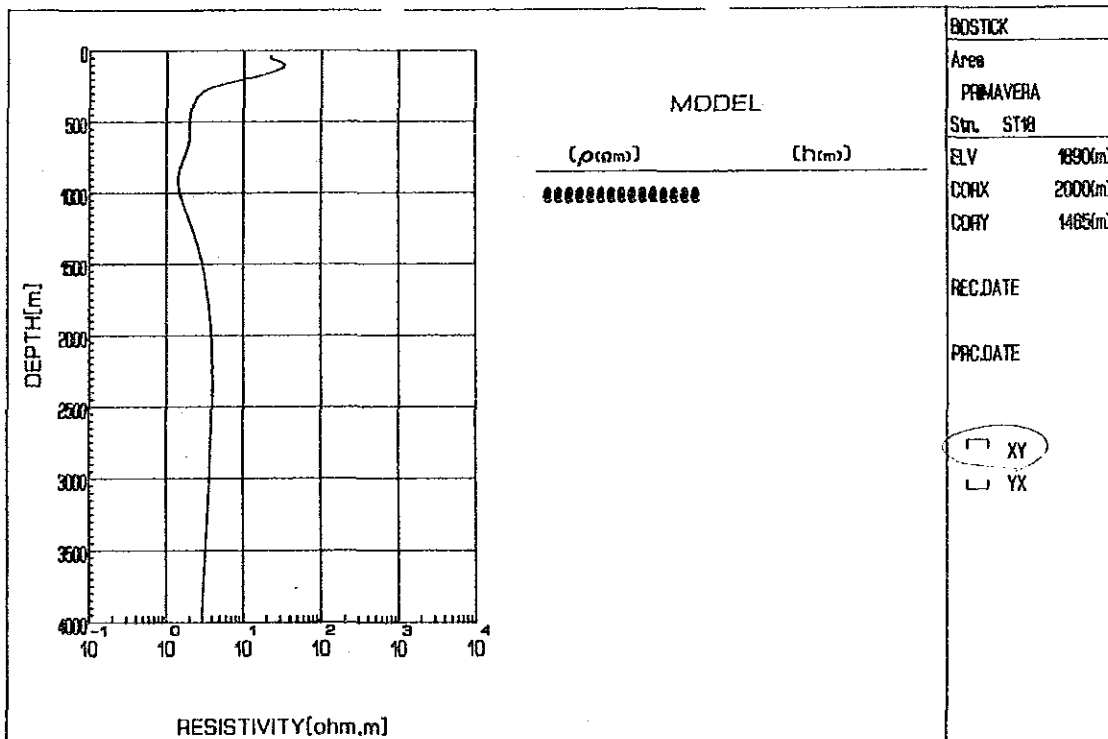

Stn. ST18

May 12 1986

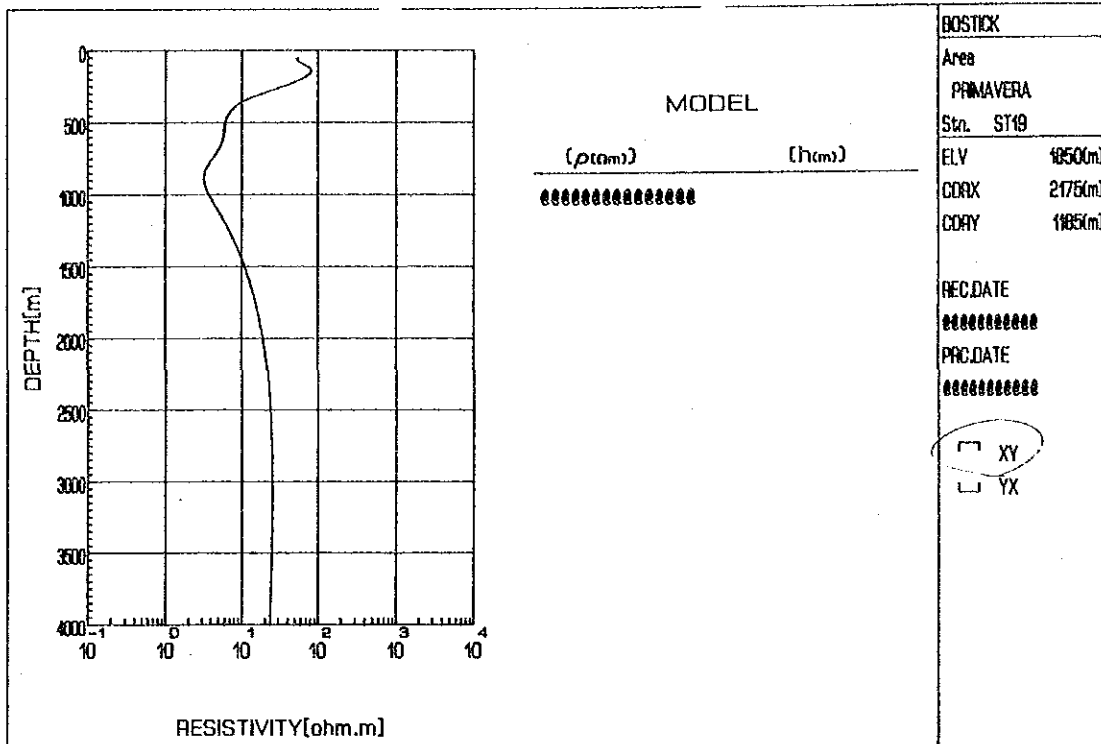

Stn. ST19

May 12 1986

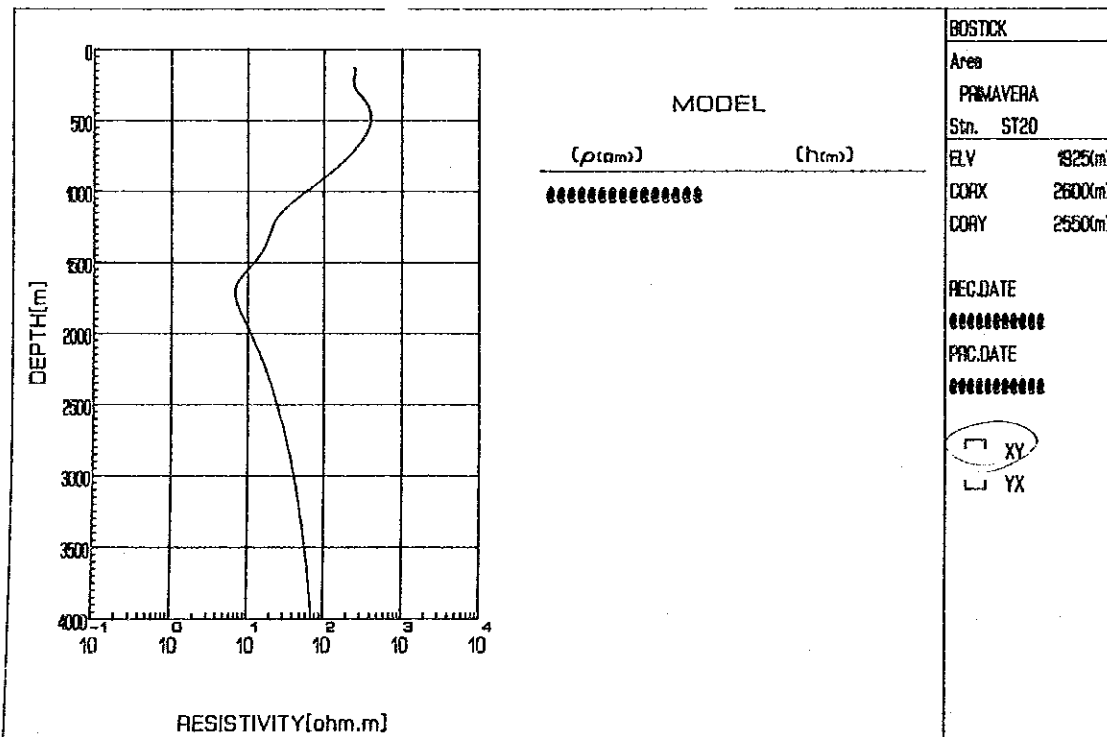

Stn. ST20

May 12 1986

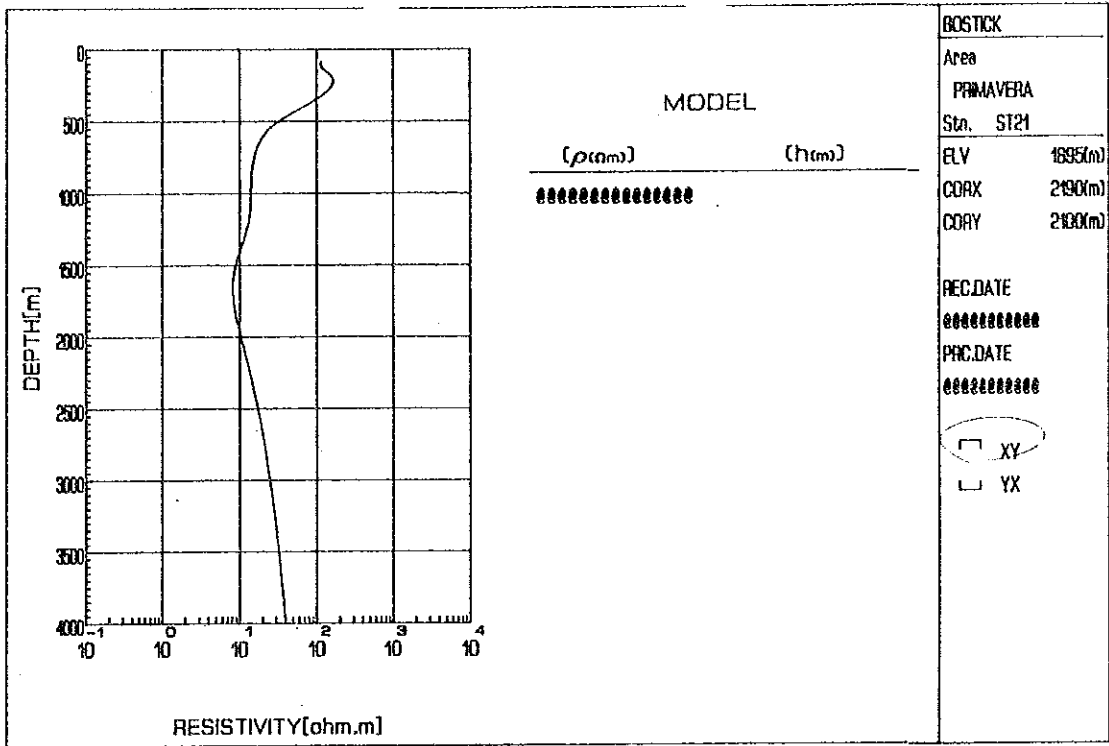

Sta. ST21

May 12 1986

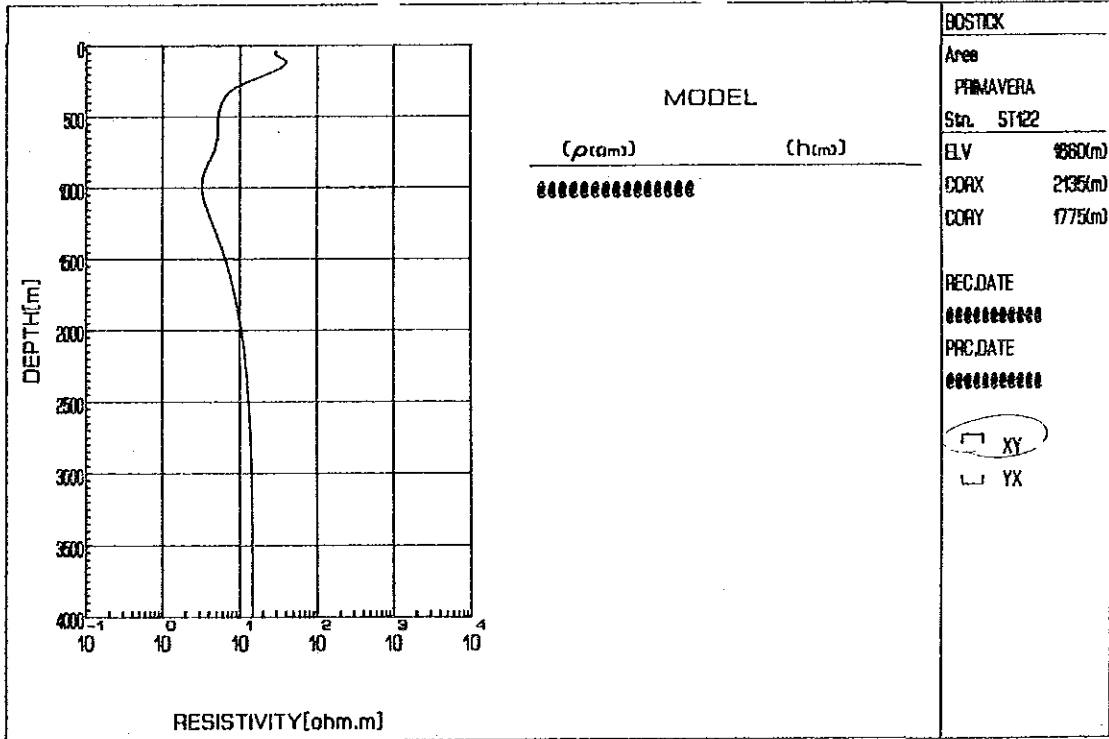

Sta. ST12

May 12 1986





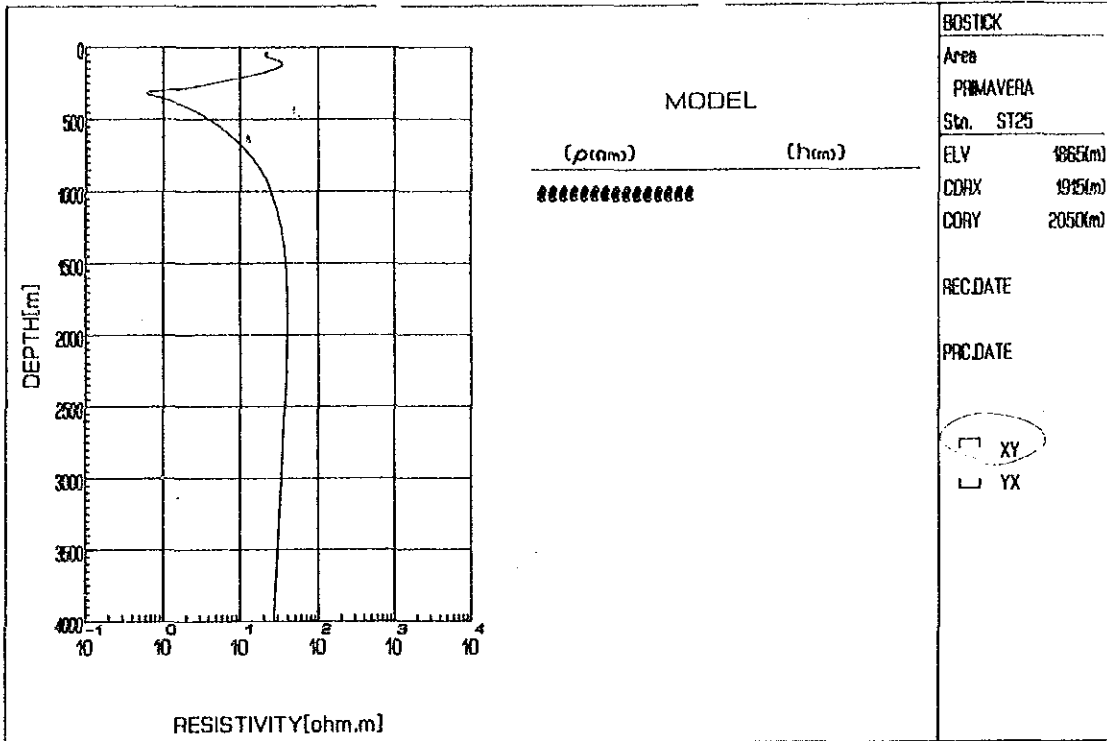

Sta. ST25

May 12 1986

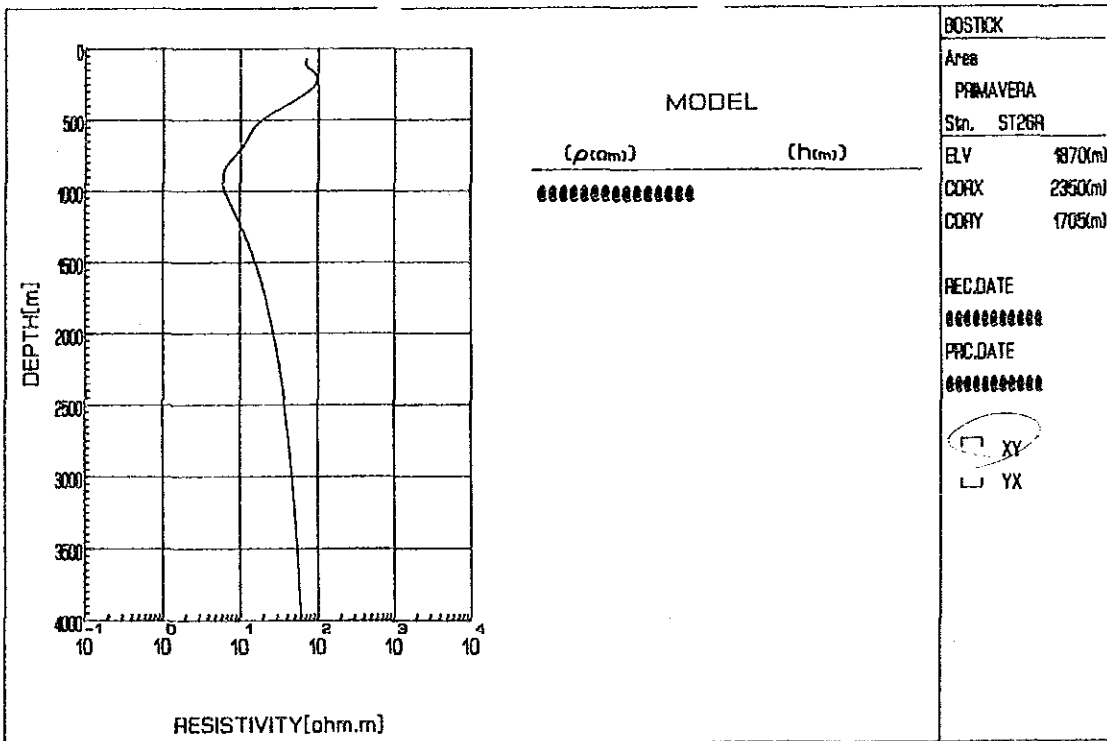

Sta. ST26

May 12 1986



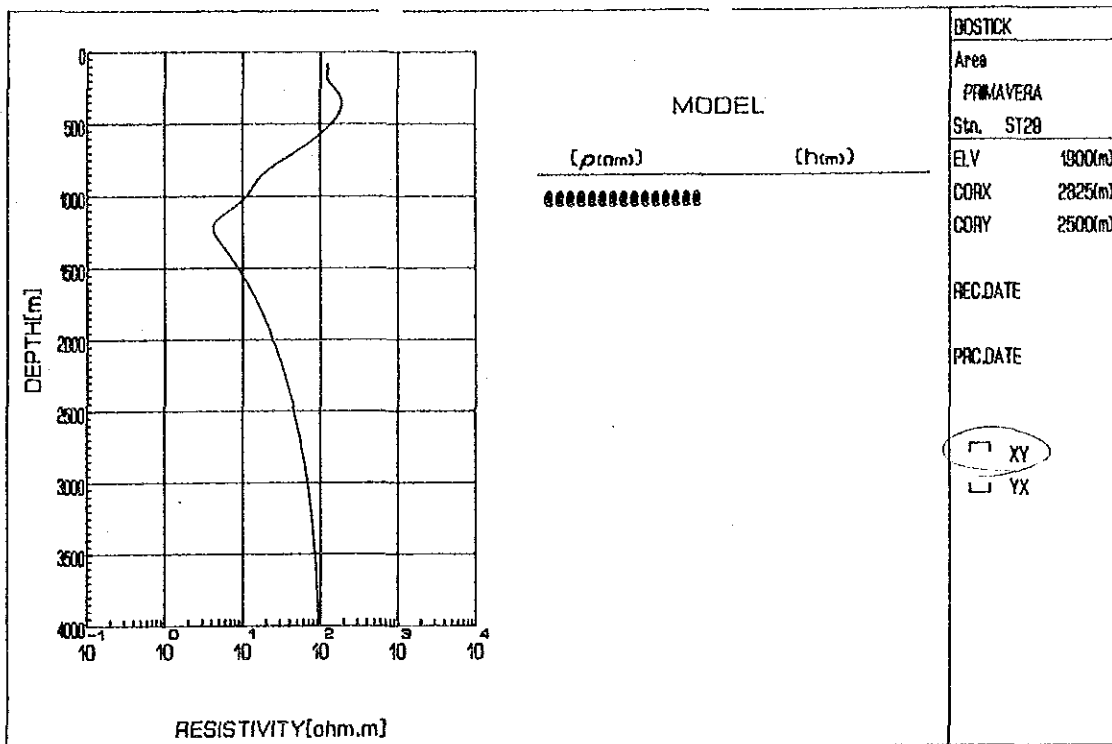

Sta. ST29

May 12 1986

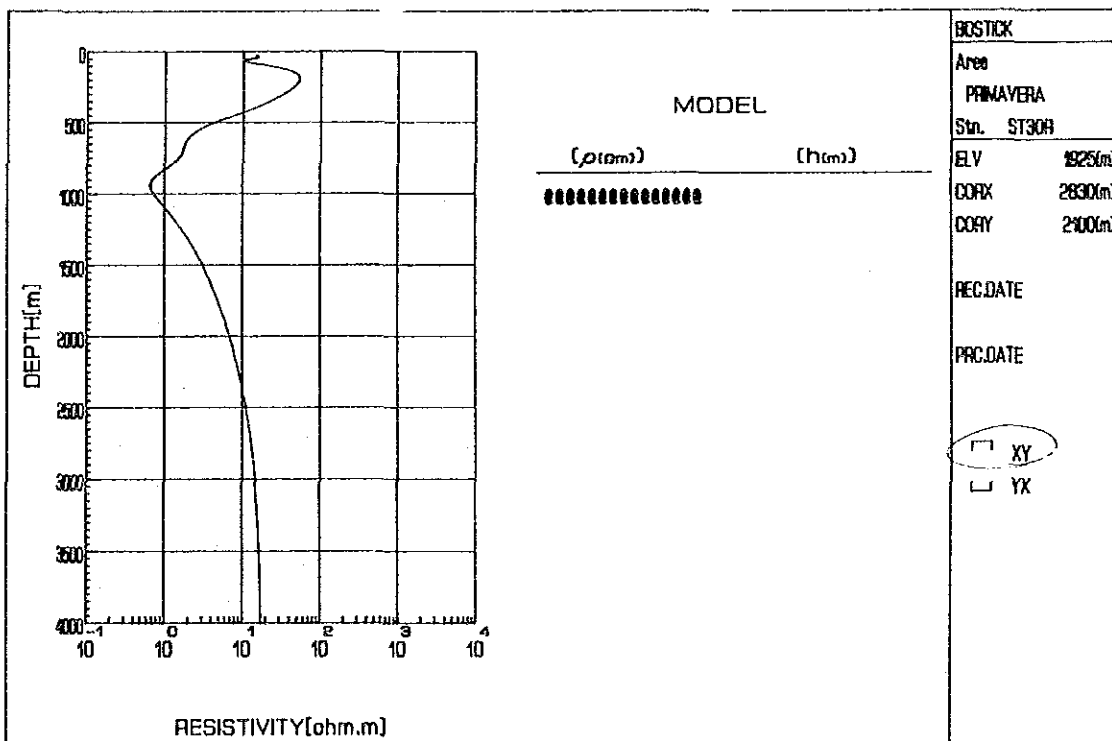

Sta. ST30

May 12 1986

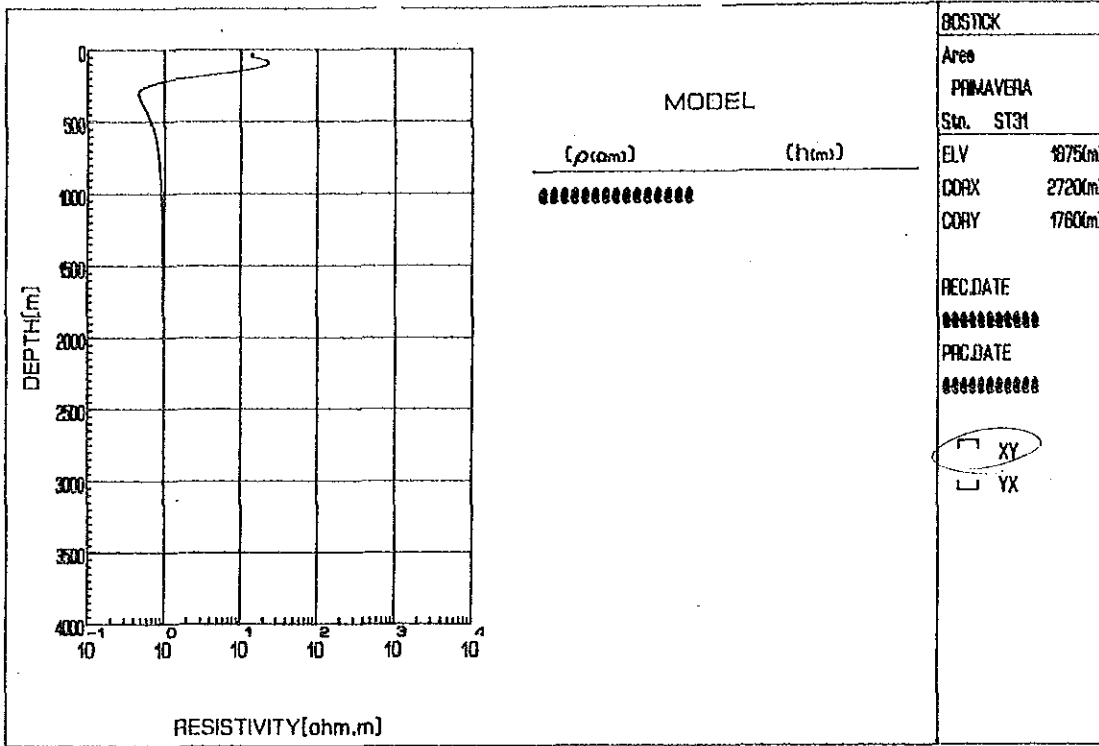

Sta. ST31

May 12 1986

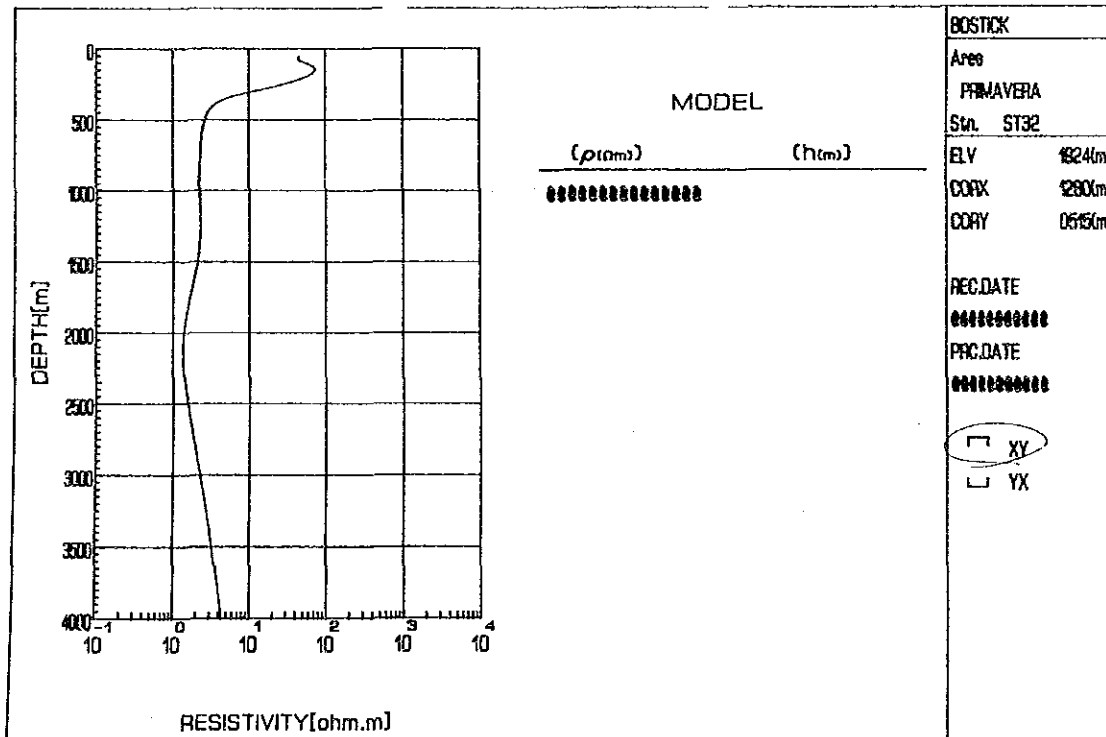

Sta. ST32

May 12 1986



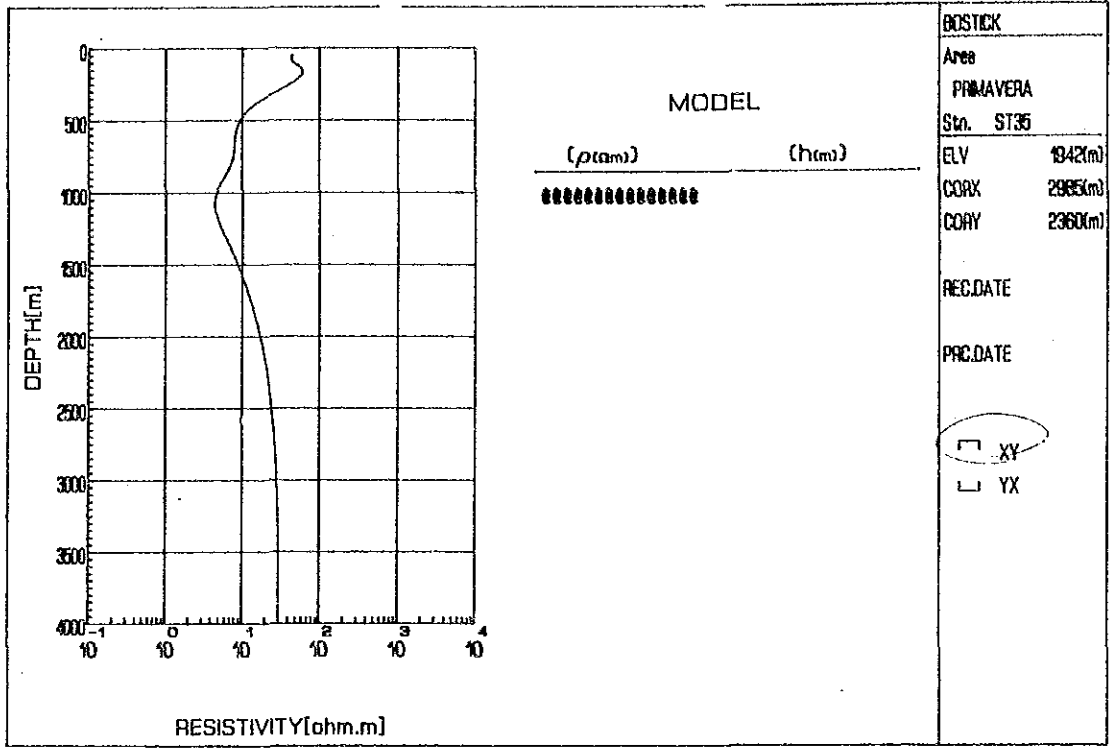

Sta. ST35

May 12 1986

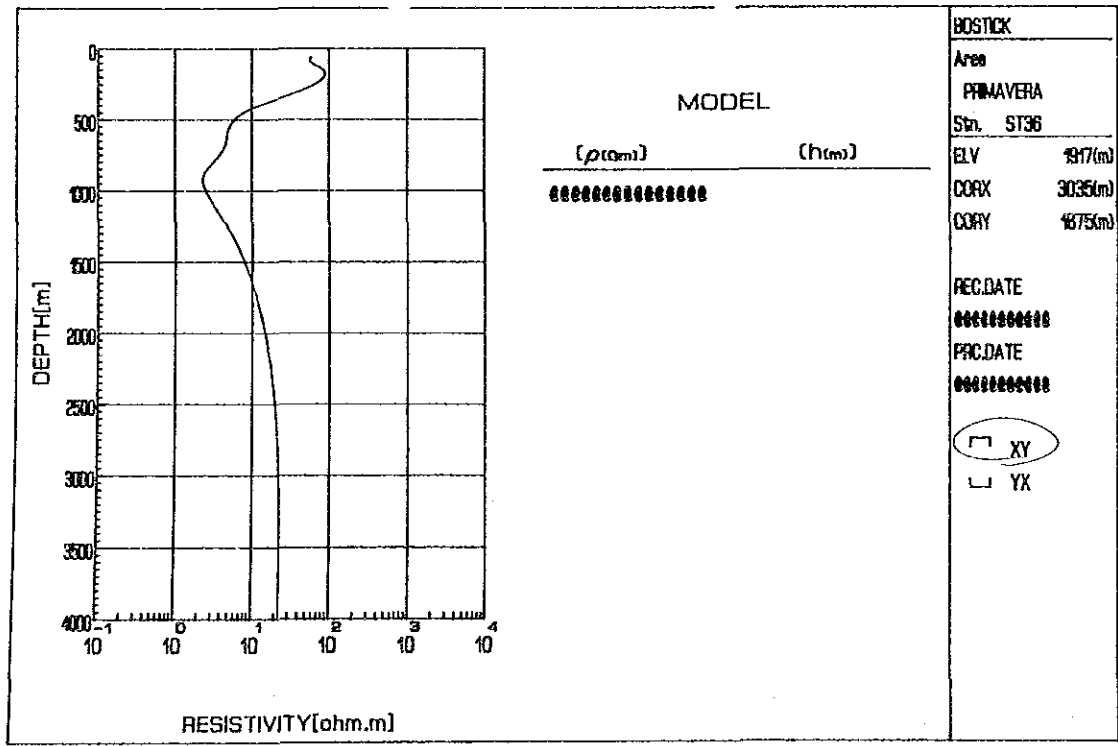

Sta. ST36

May 12 1986

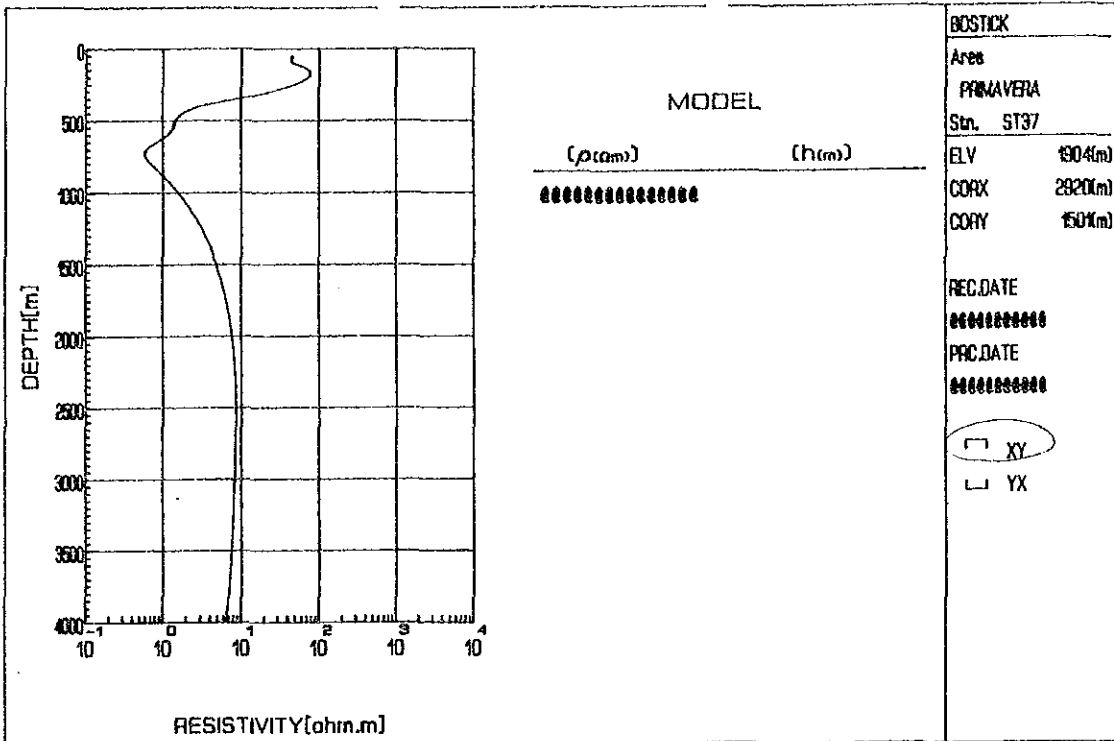

Sta. ST37

May 12 1988

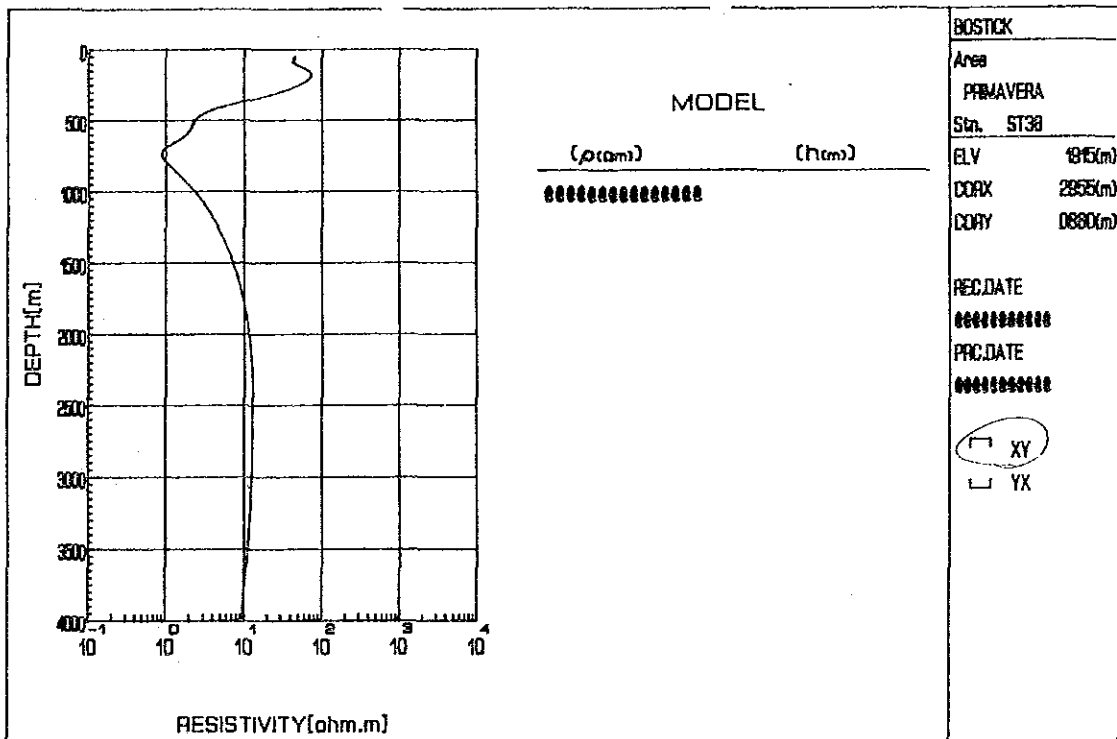

Sta. ST38

May 12 1988

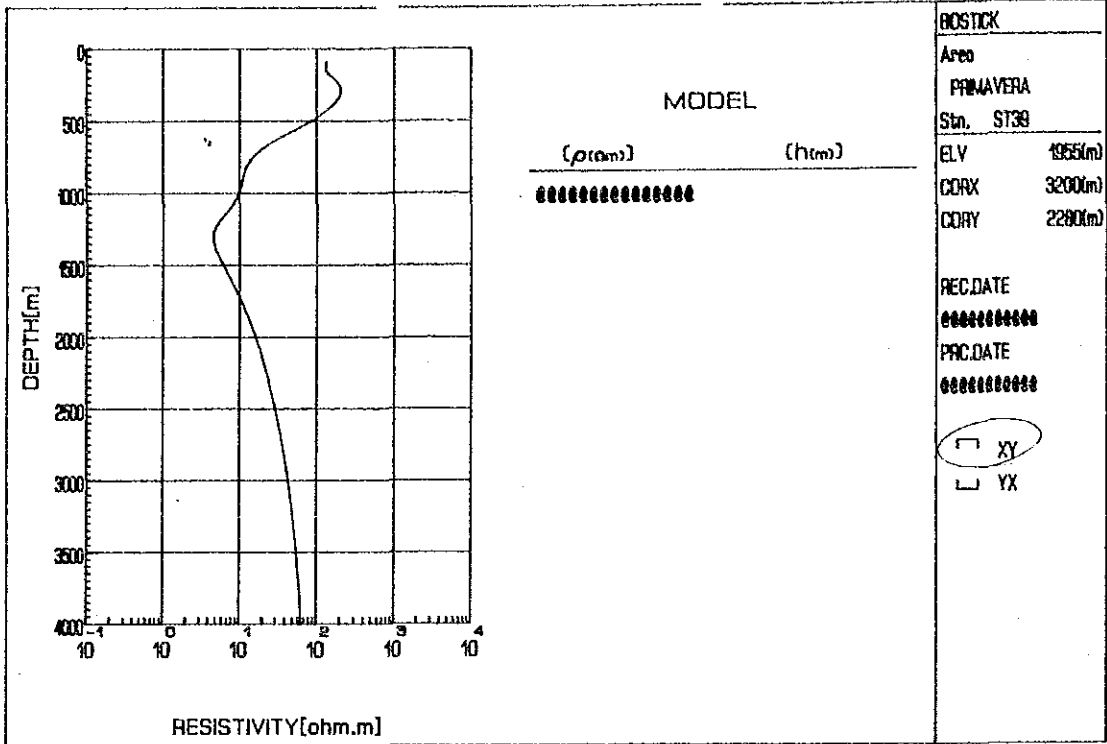

Sta. ST39

May 12 1986

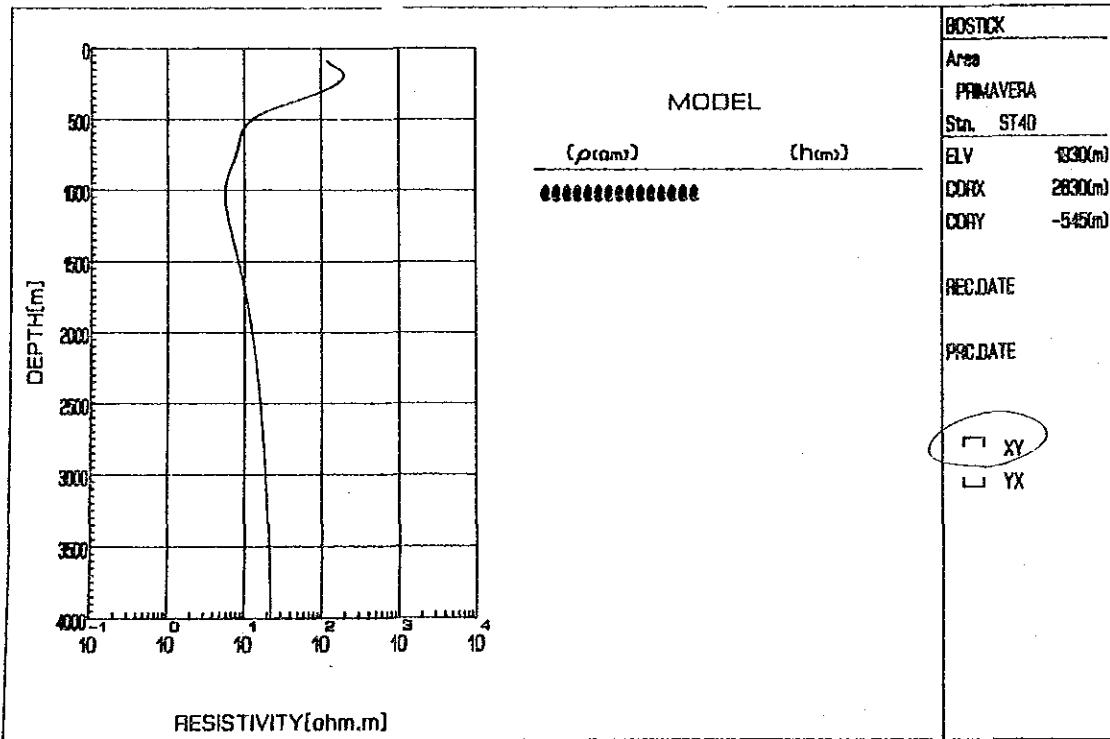

Sta. ST40

May 12 1986



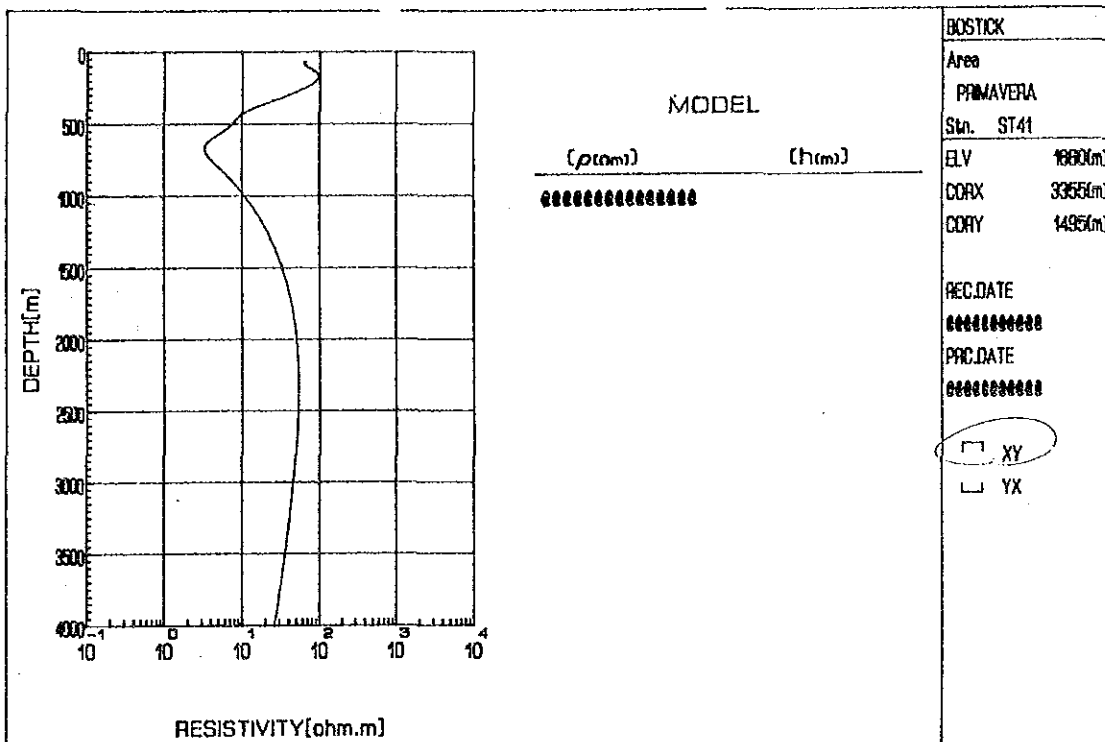

Sta. ST41

May 12 1986

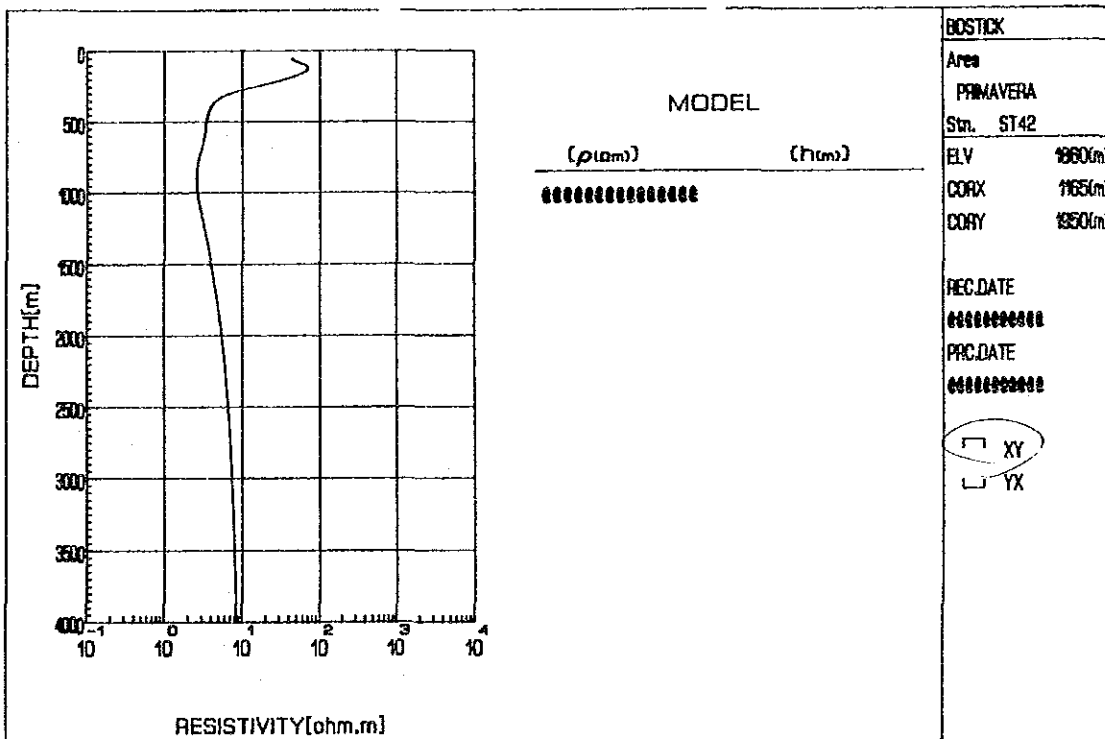

Sta. ST42

May 12 1986

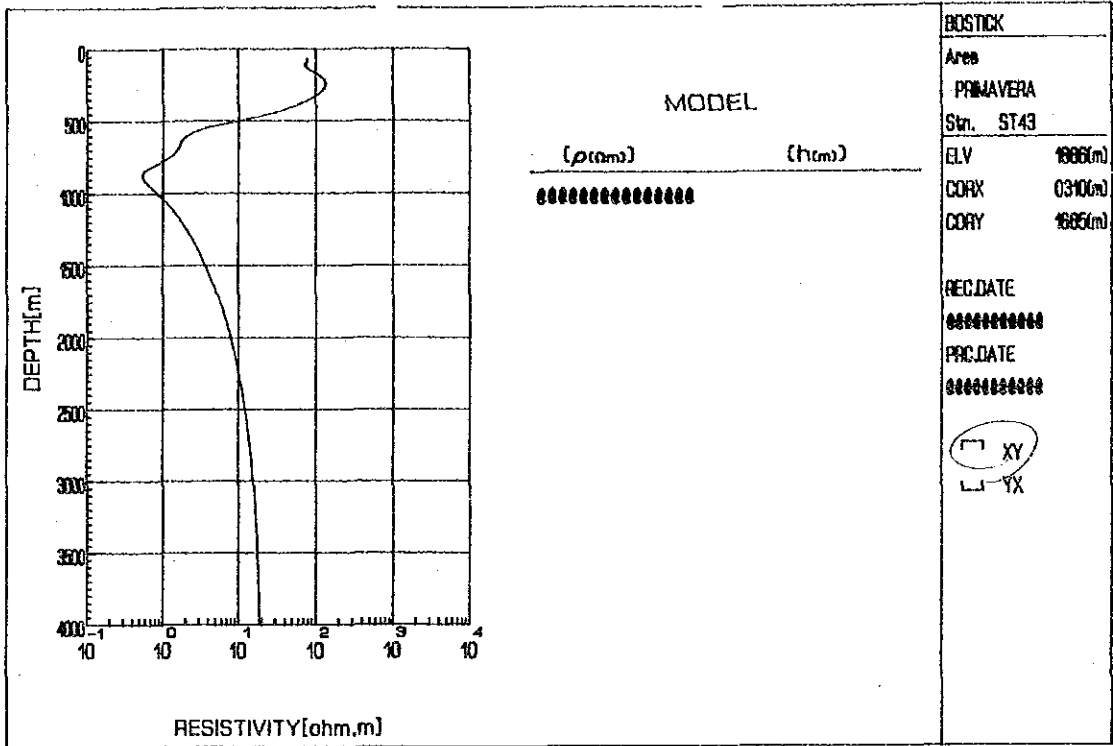

Stn. ST43

May 12 1996

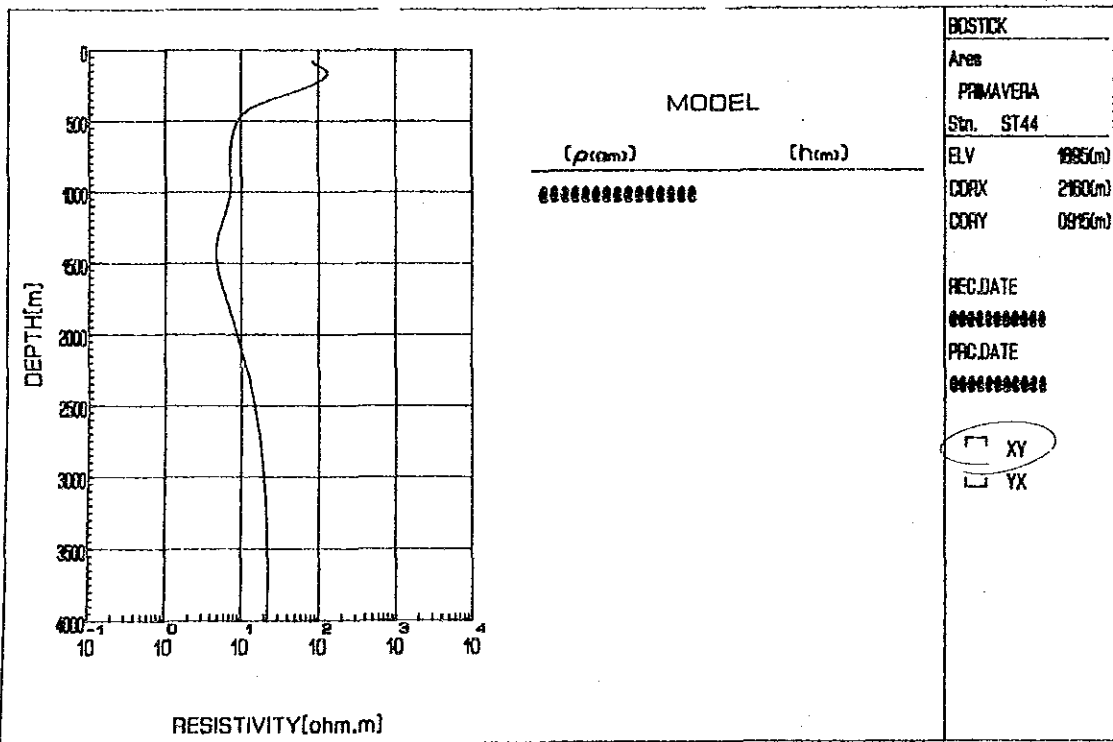

Stn. ST44

May 12 1996

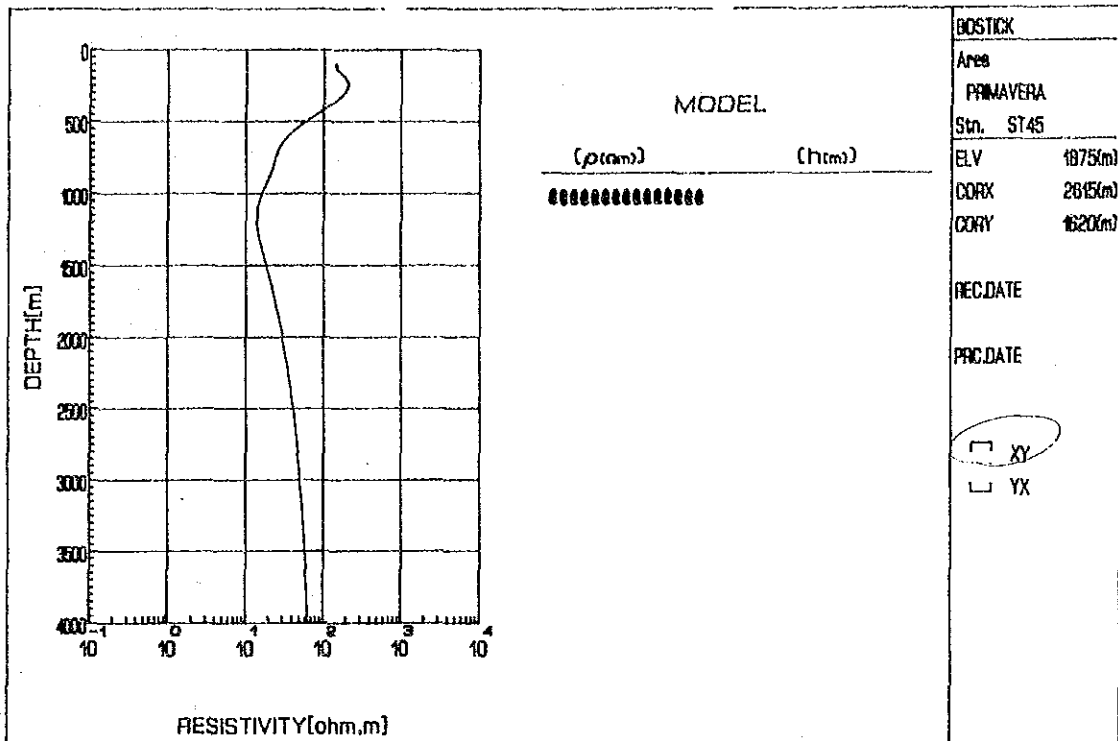

Stn. ST45

May 12 1988

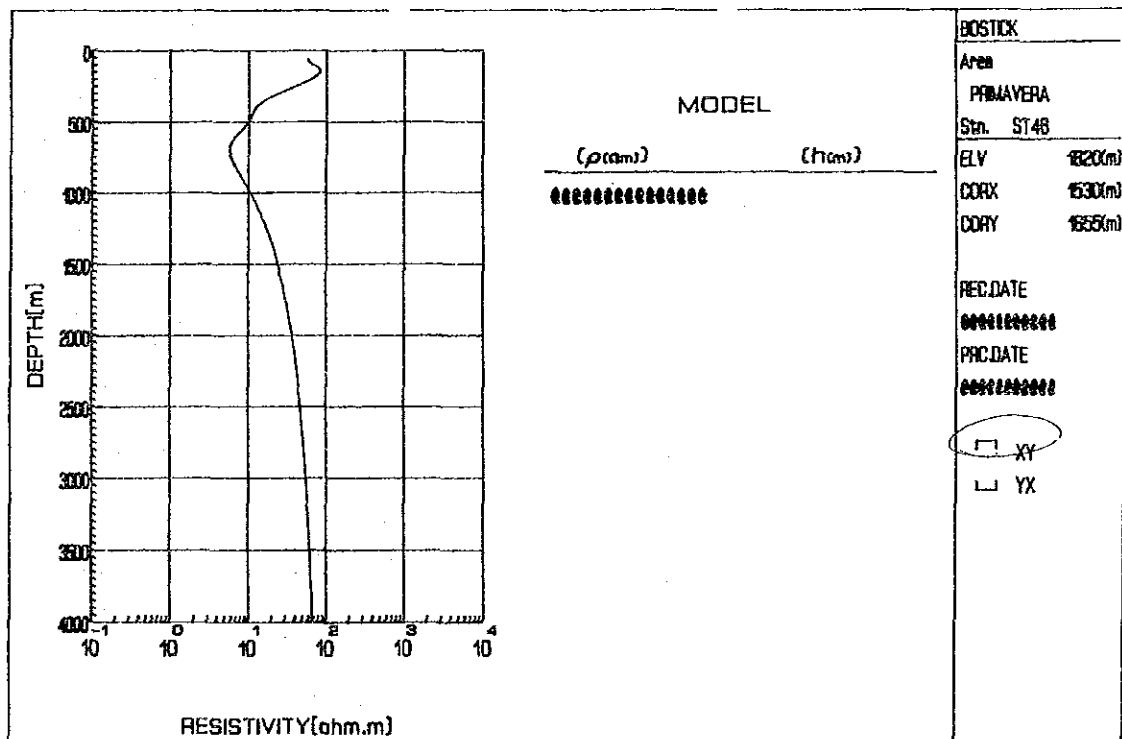

Stn. ST48

May 12 1988

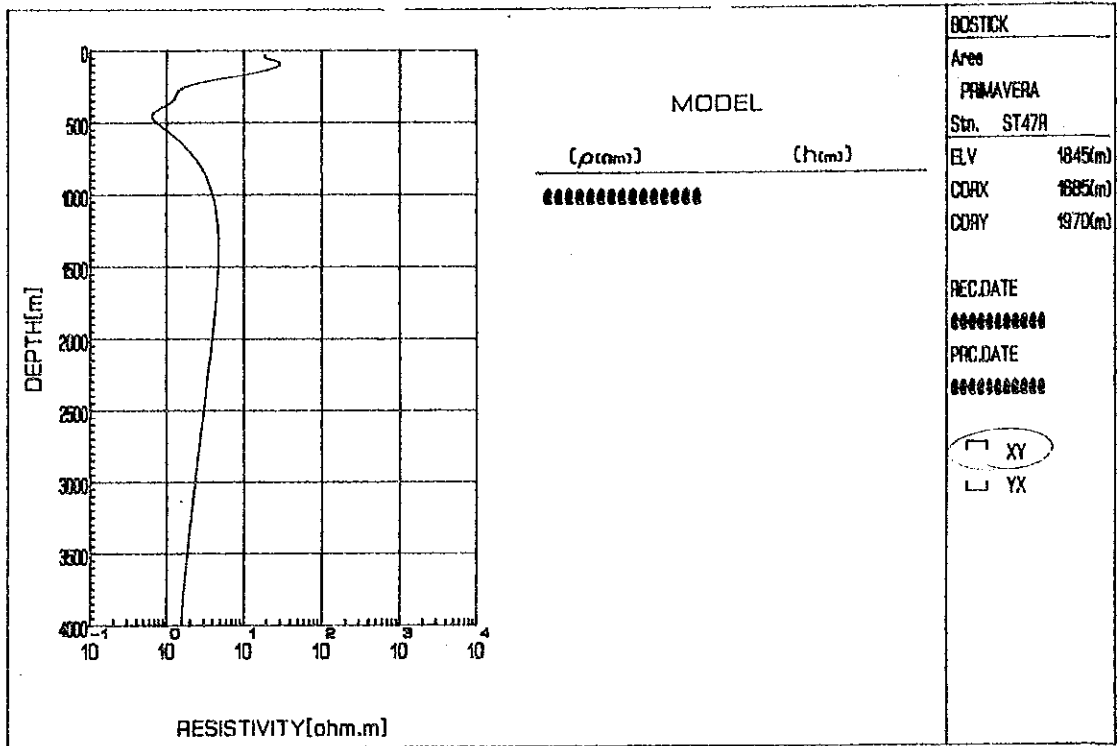

Sta. ST47

May 12 1986

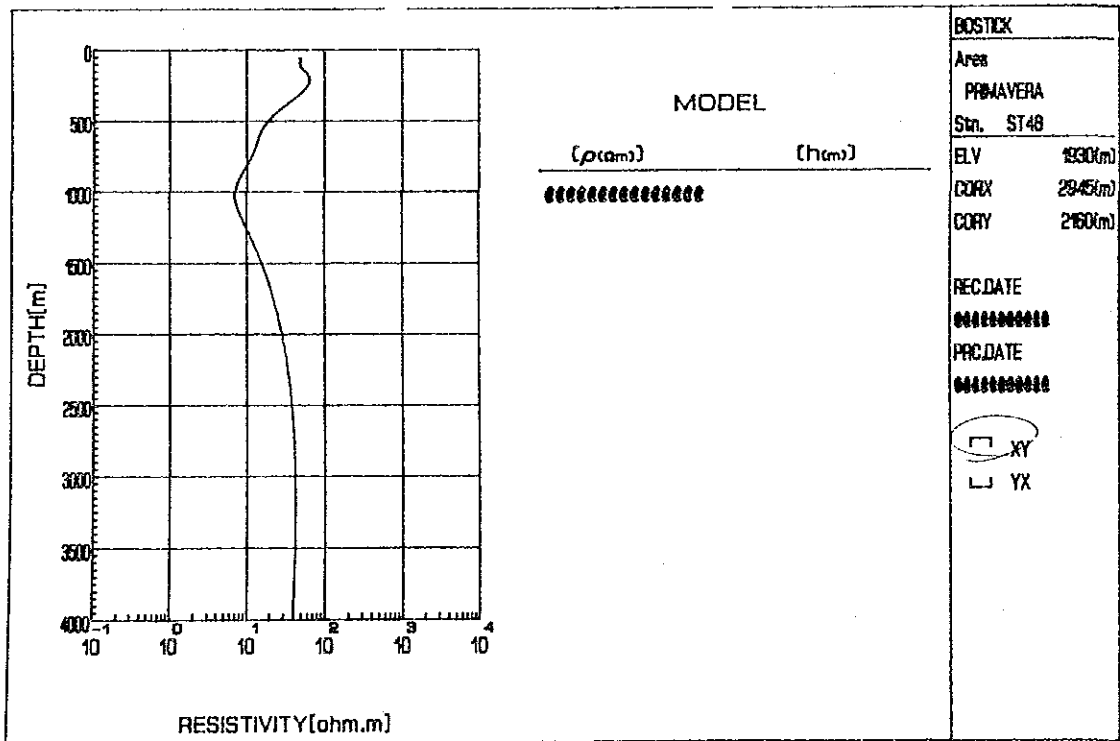

Sta. ST48

May 12 1986



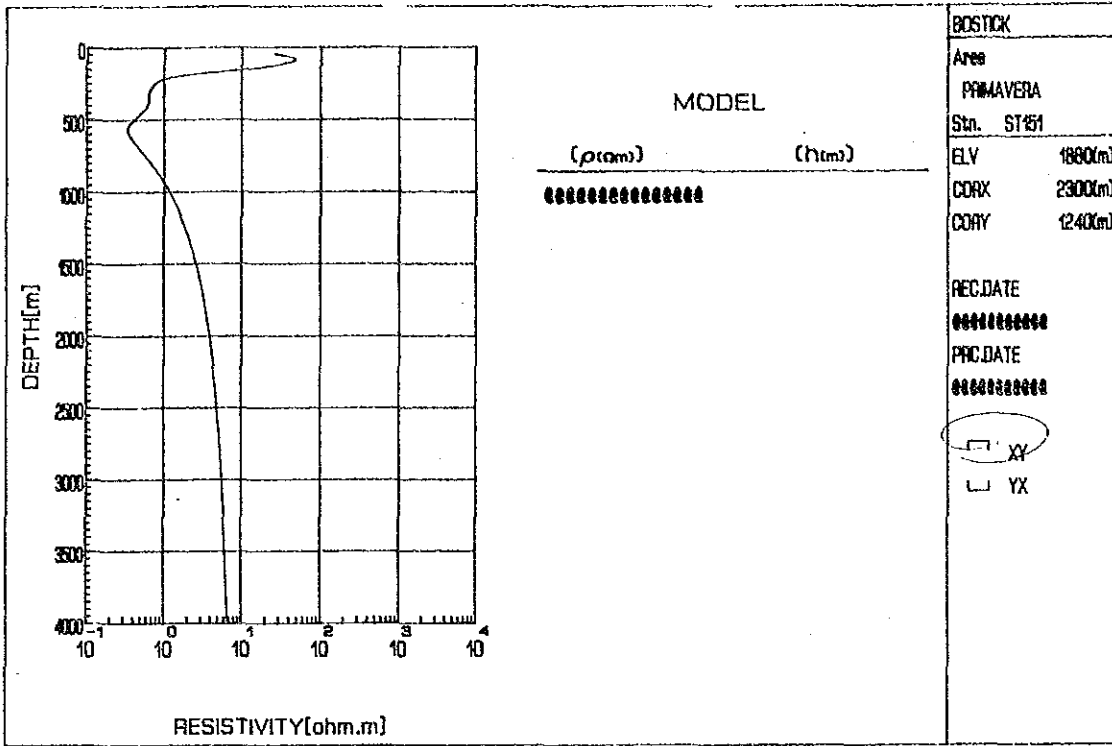

Sta. ST15

May 12 1966

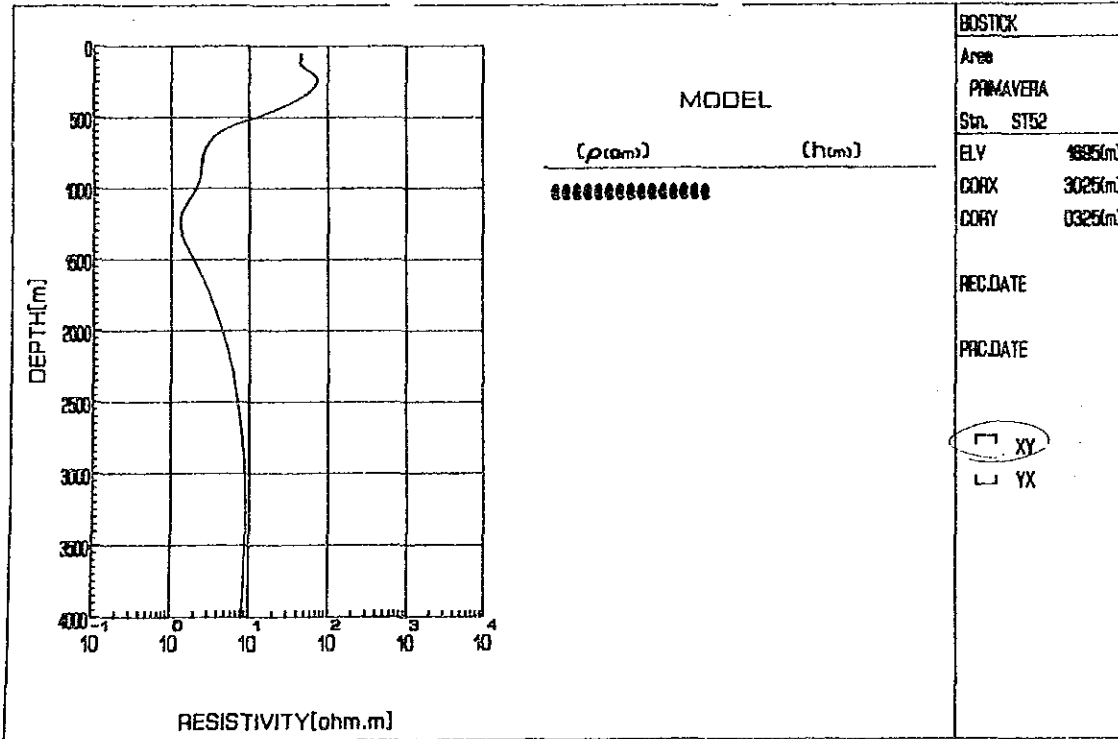

Sta. ST52

May 12 1966

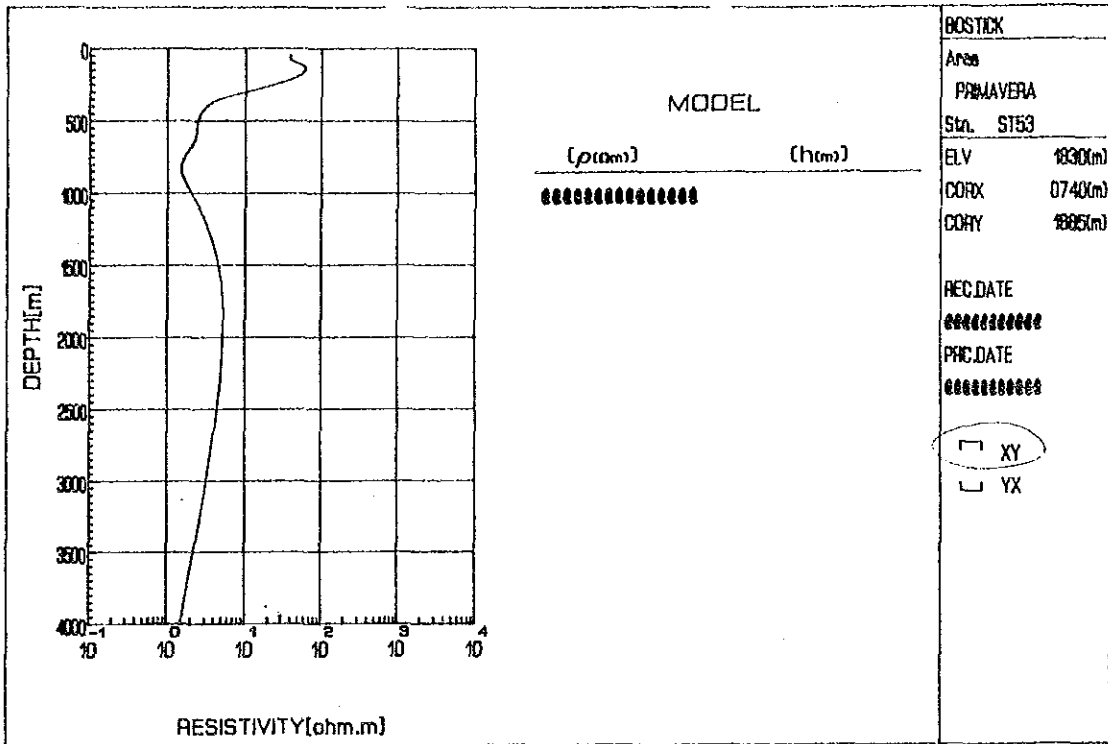

Sta. ST53

May 12 1986

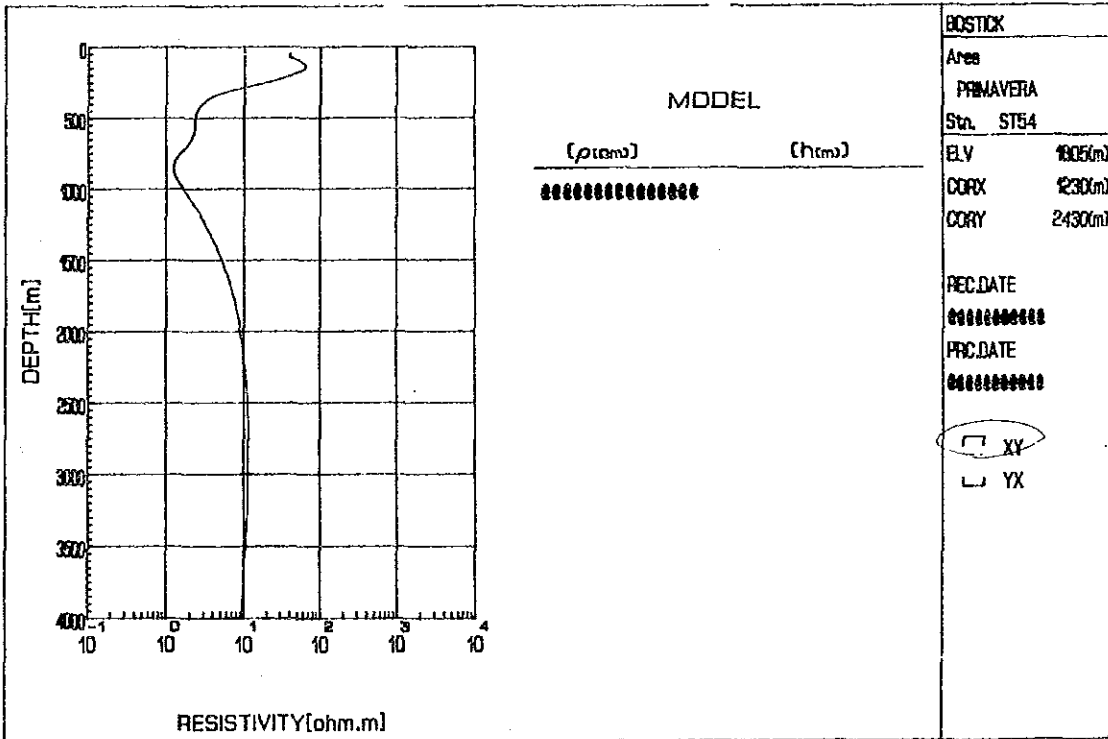

Sta. ST54

May 12 1986





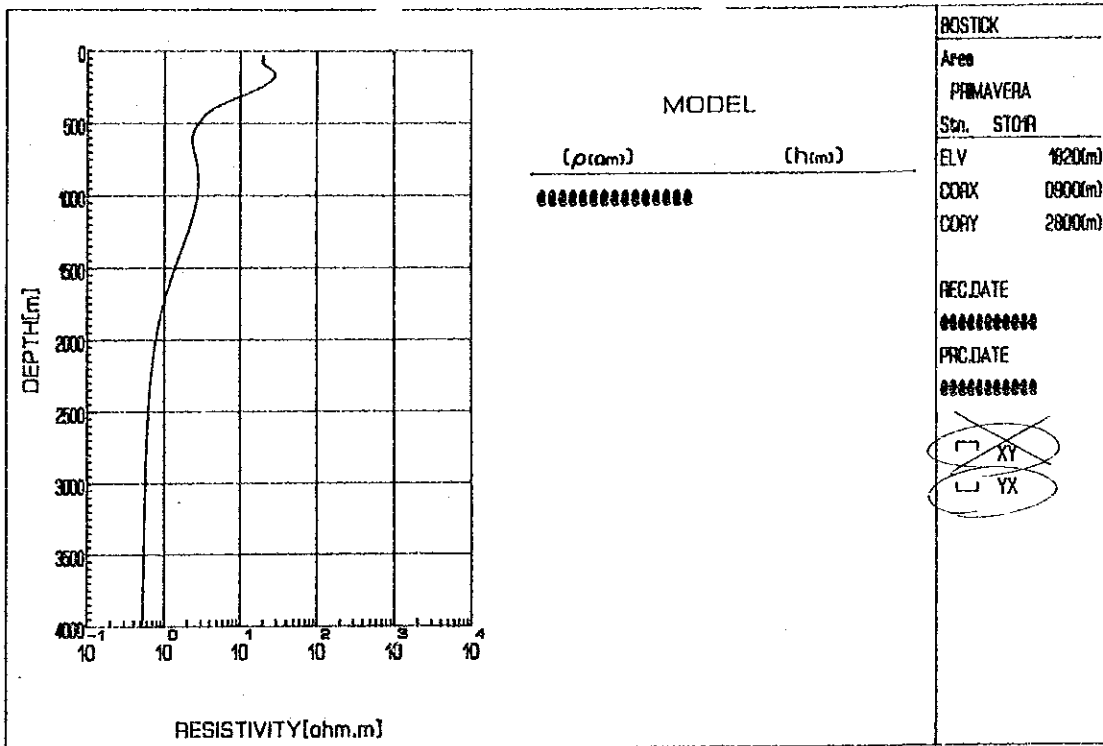

Sta. ST01

May 12 1986

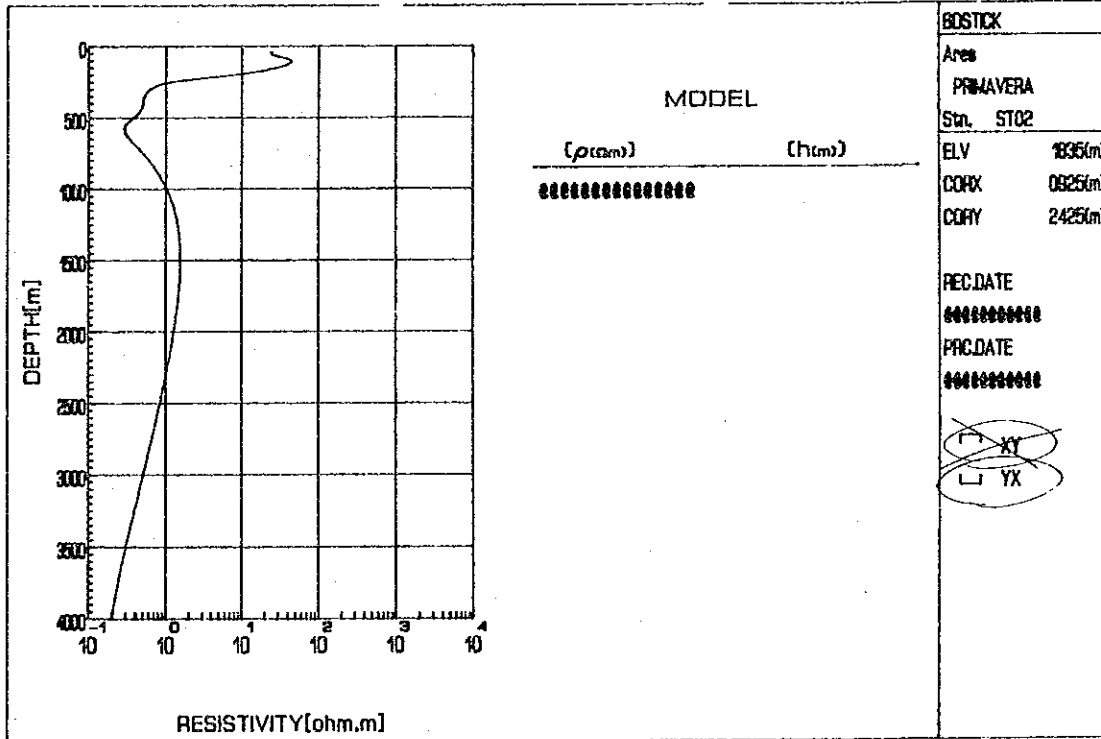

Sta. ST02

May 12 1986

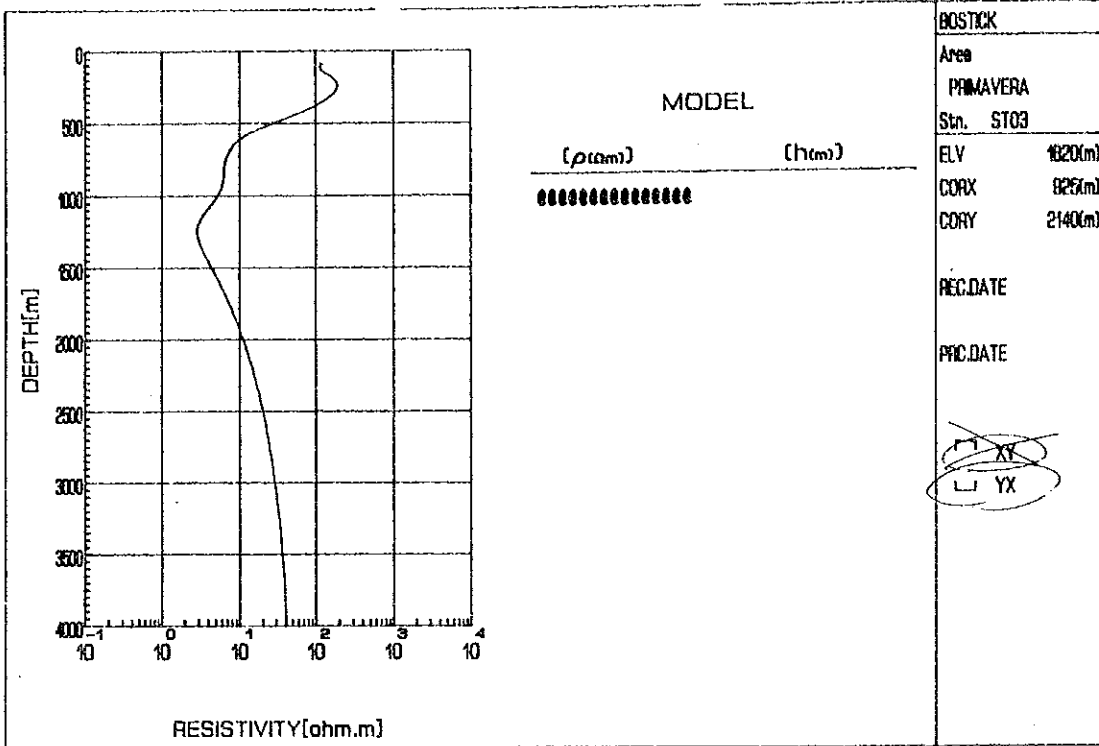

Stn. ST03

May 12 1988

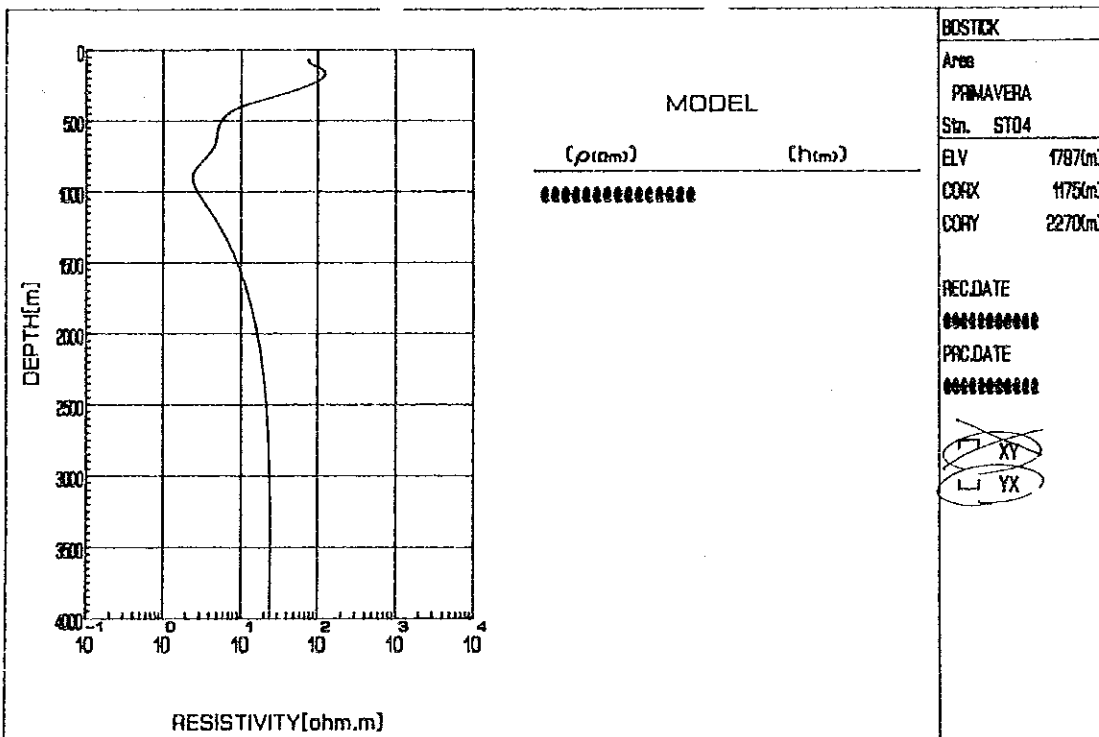

Stn. ST04

May 12 1988





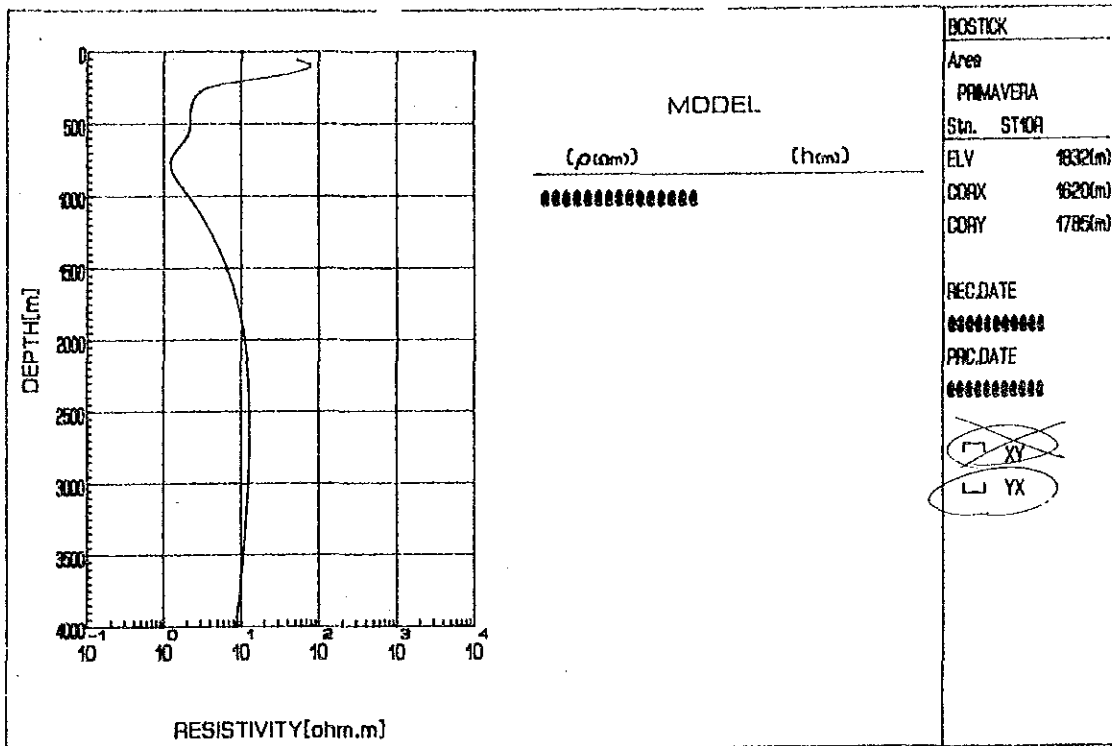

Sta. ST10

May 12 1966

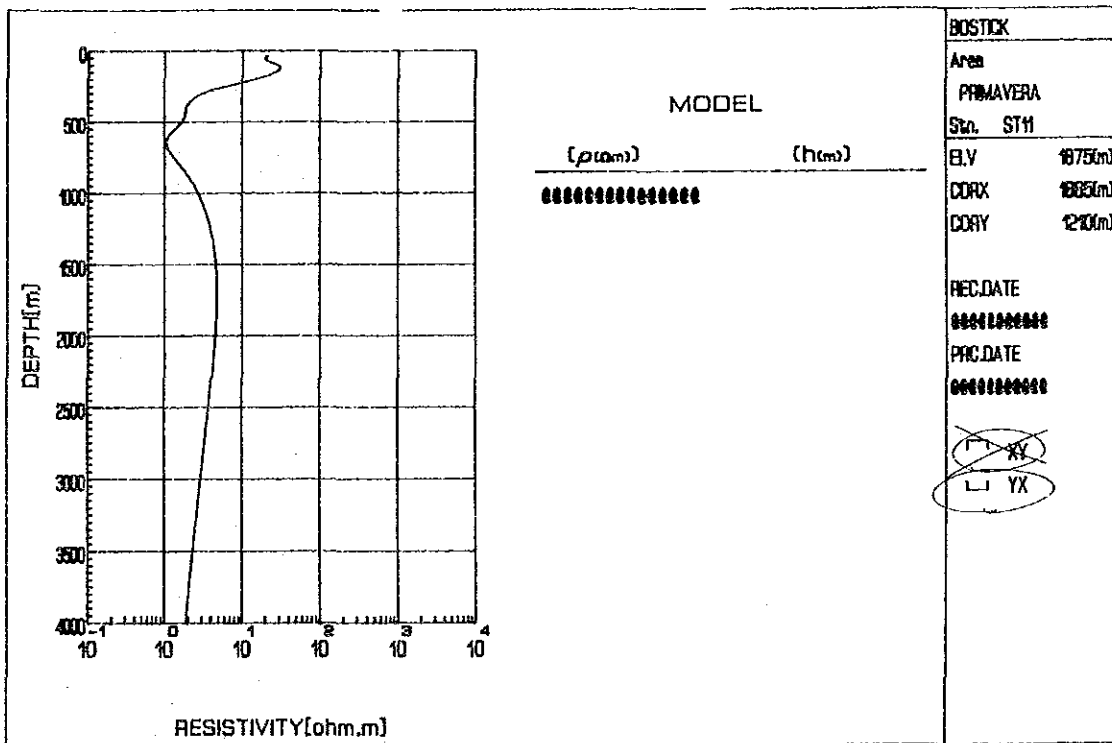

Sta. ST11

May 12 1966

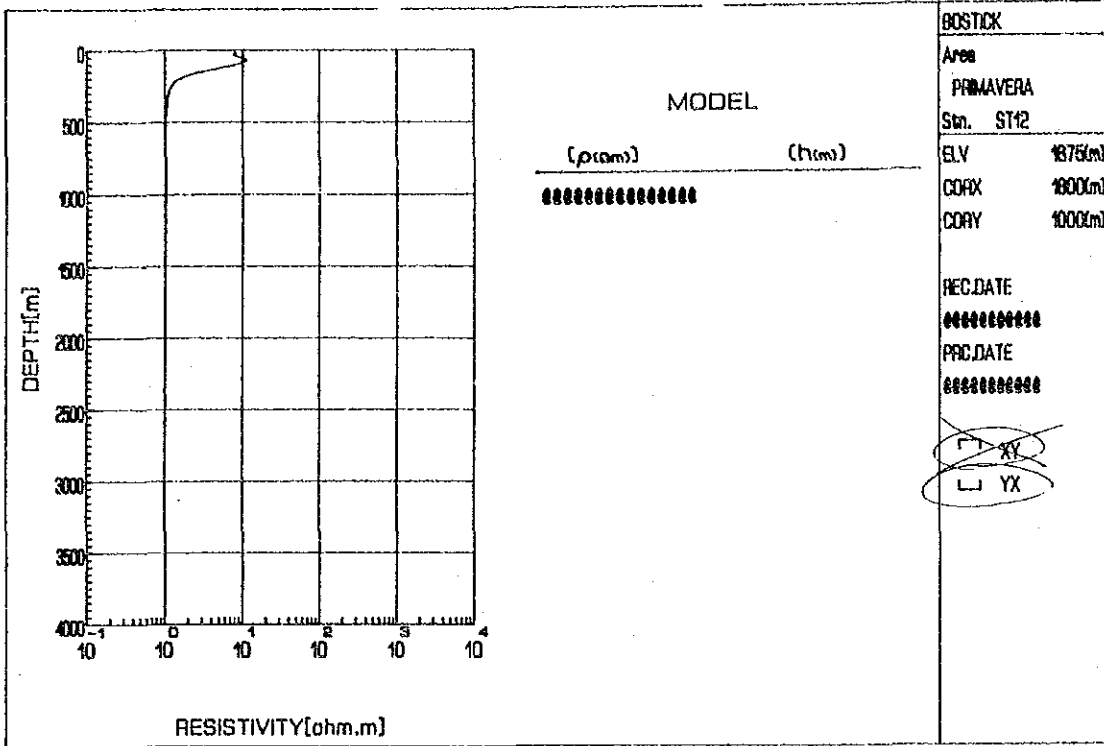

Sta. ST12

May 12 1986

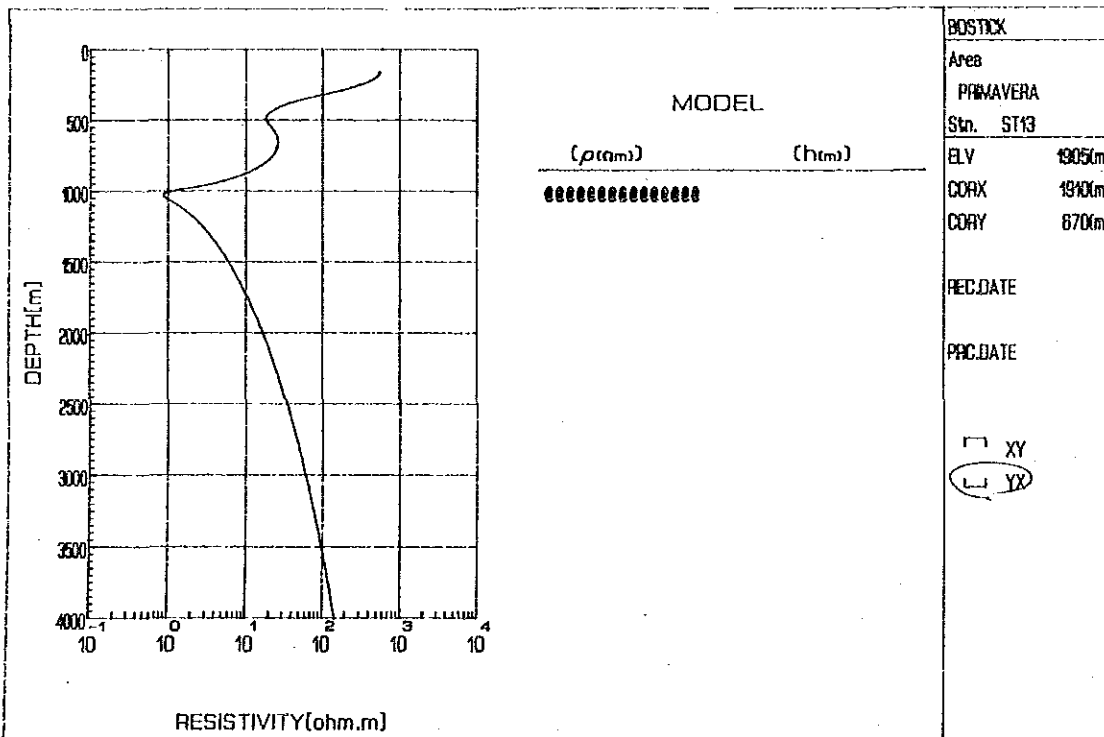

Sta. ST13

May 14 1986



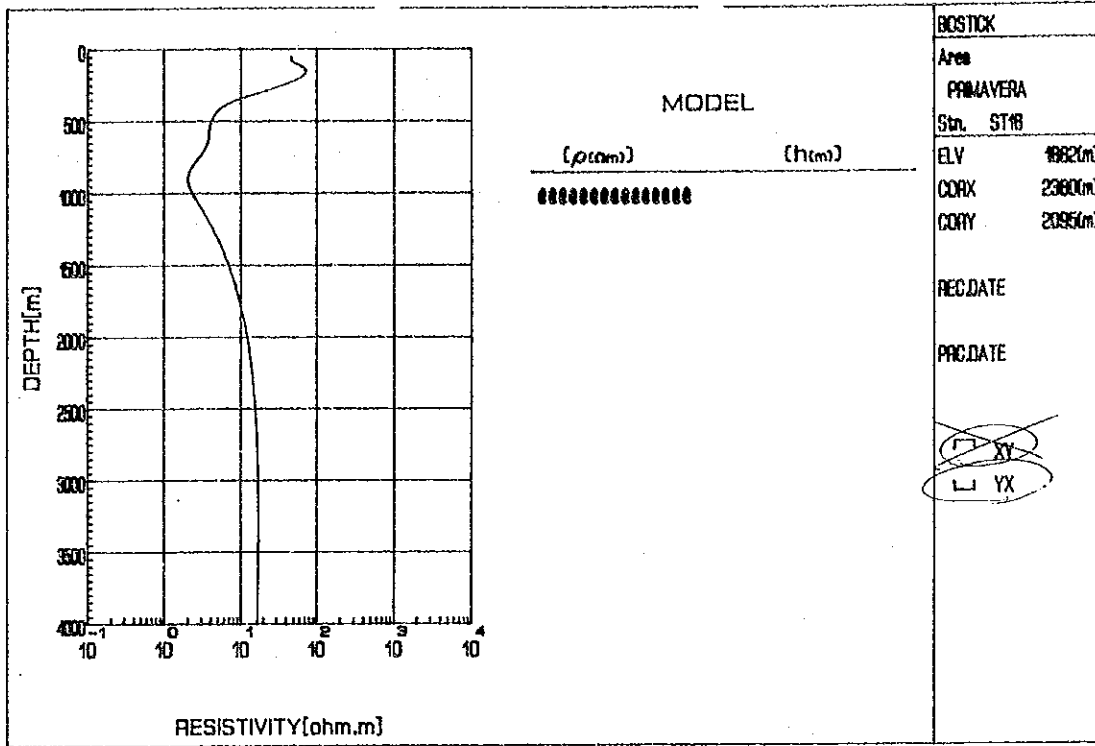

Sta. ST16

May 12 1988

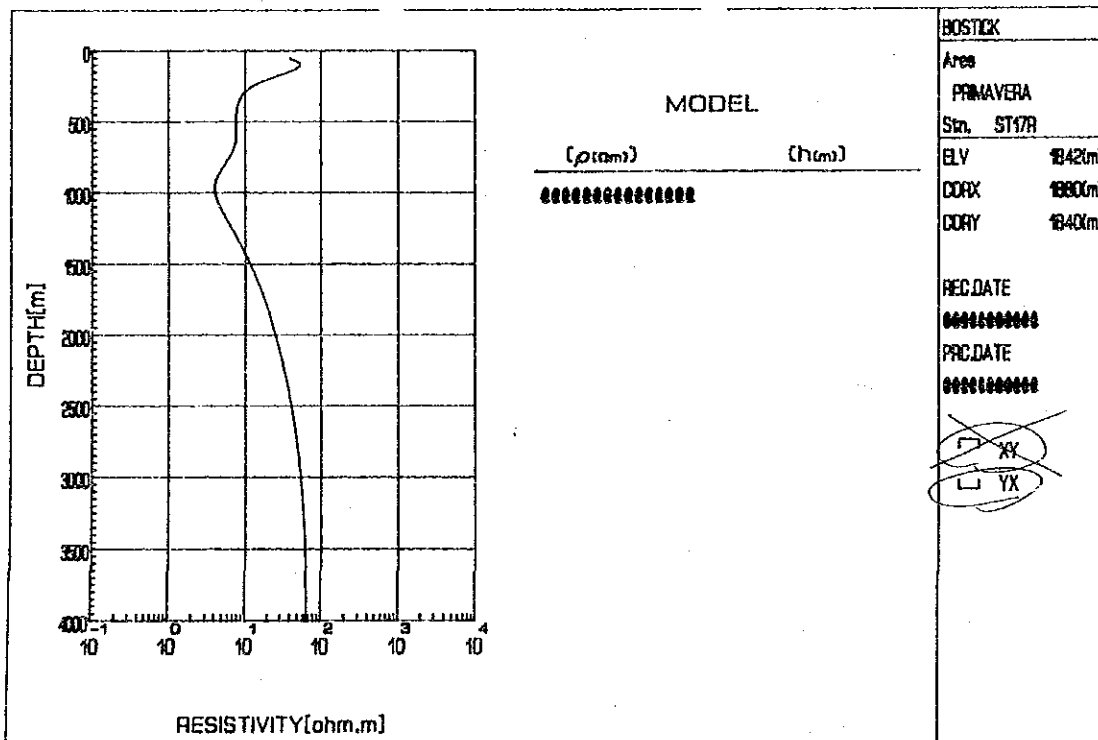

Sta. ST17

May 12 1988



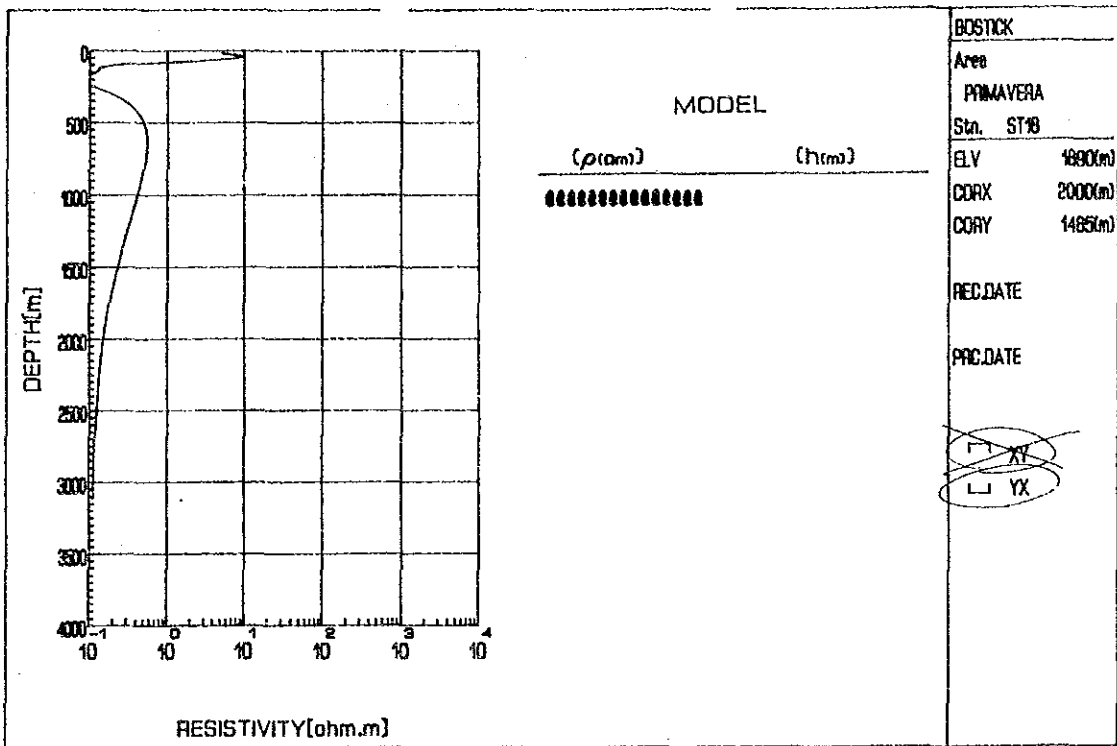

Sta. ST18

May 12 1988

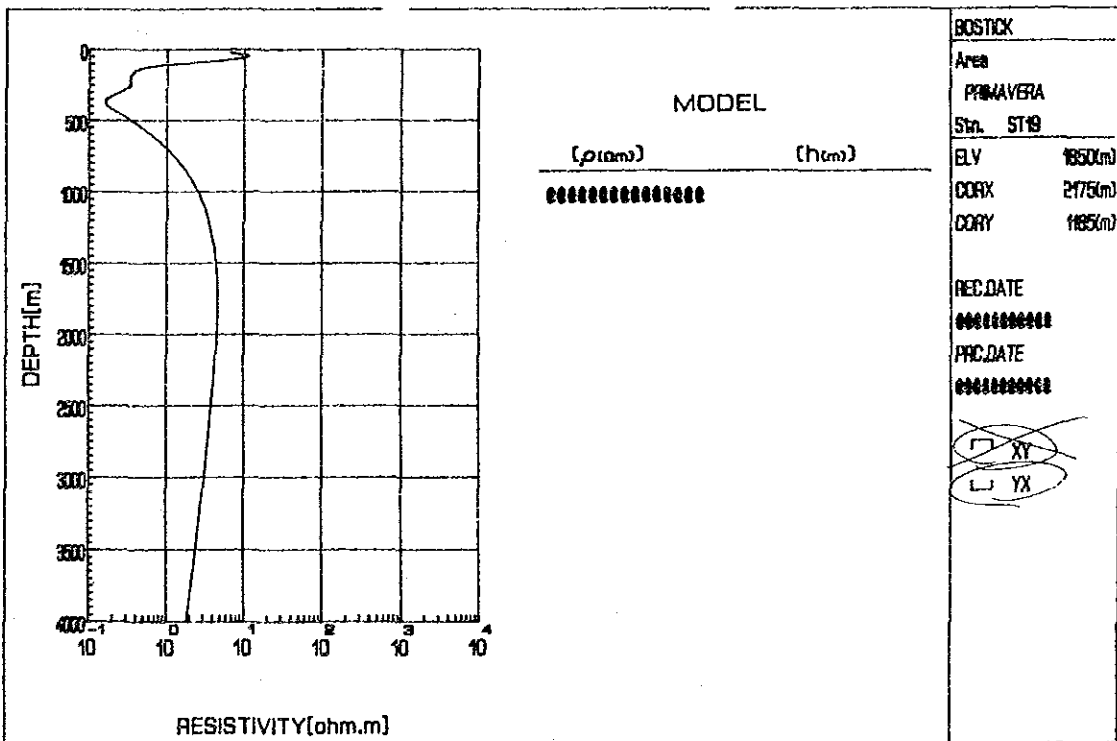

Sta. ST19

May 12 1988

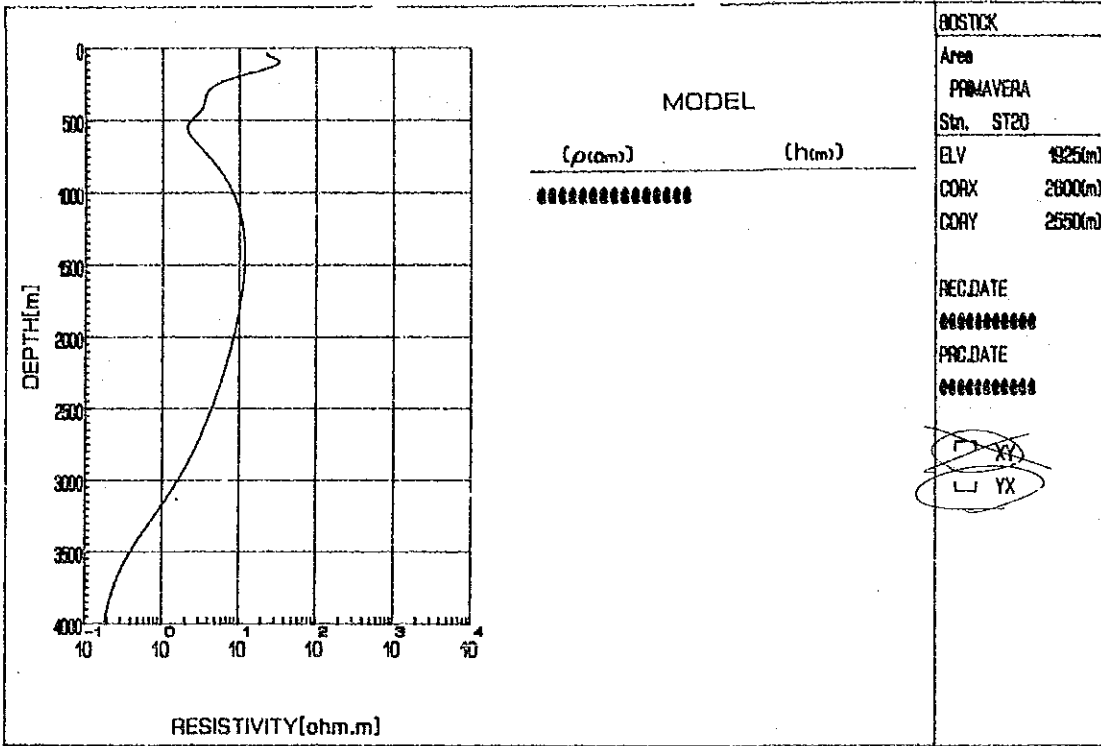

Sta. ST20

May 12 1986

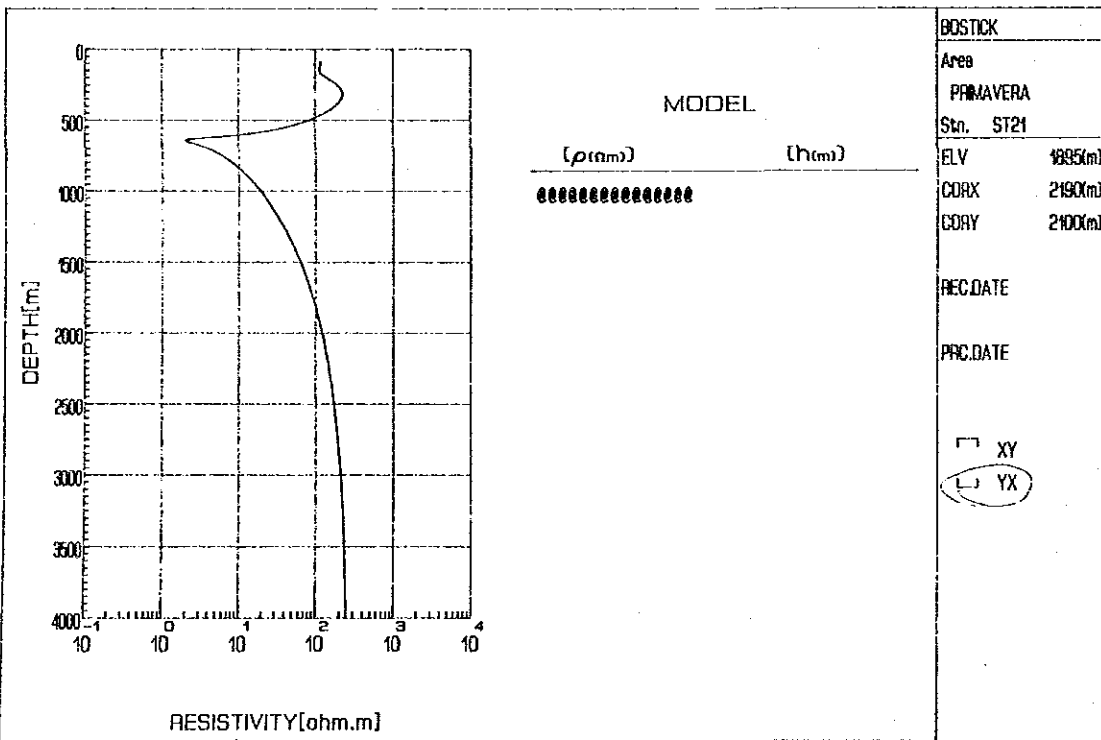

Sta. ST21

May 14 1986

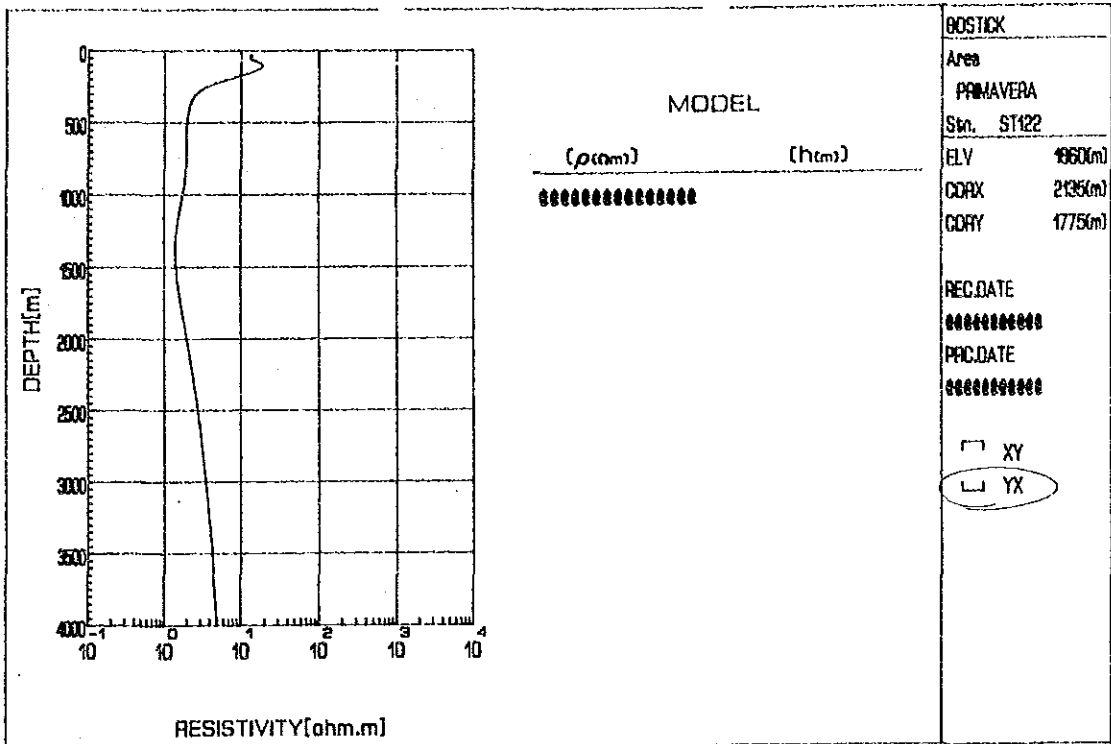

Sta. ST12

May 12 1966

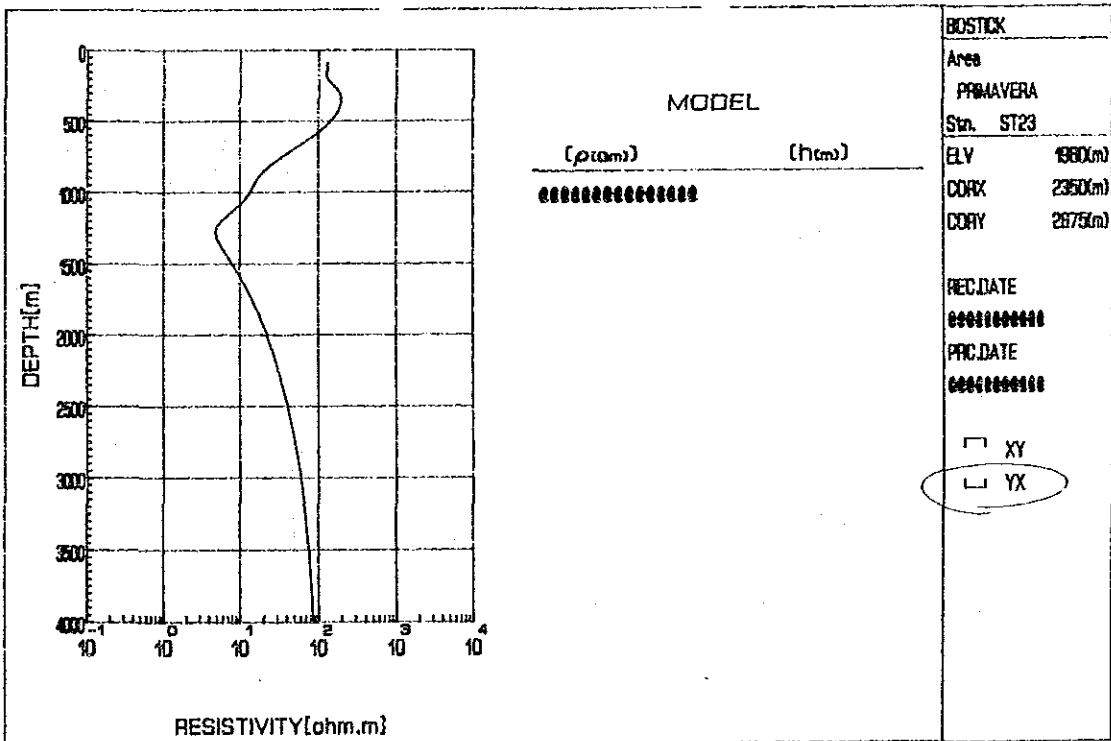

Sta. ST23

May 12 1966





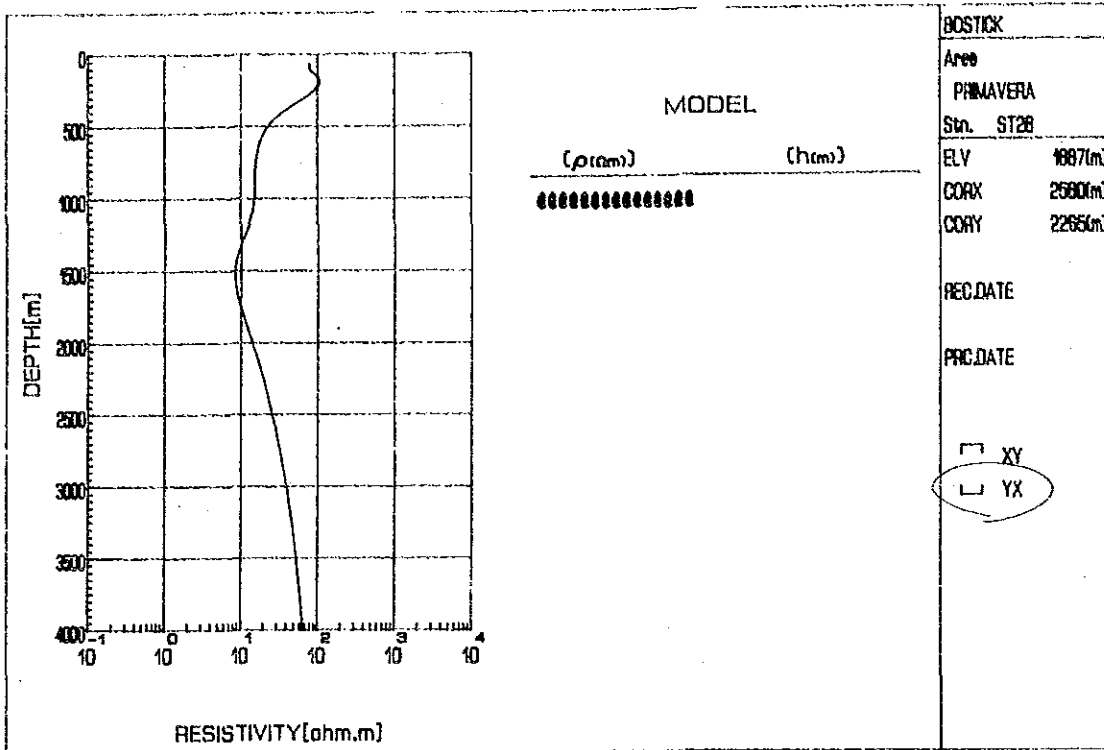

Sta. ST28

May 12 1986

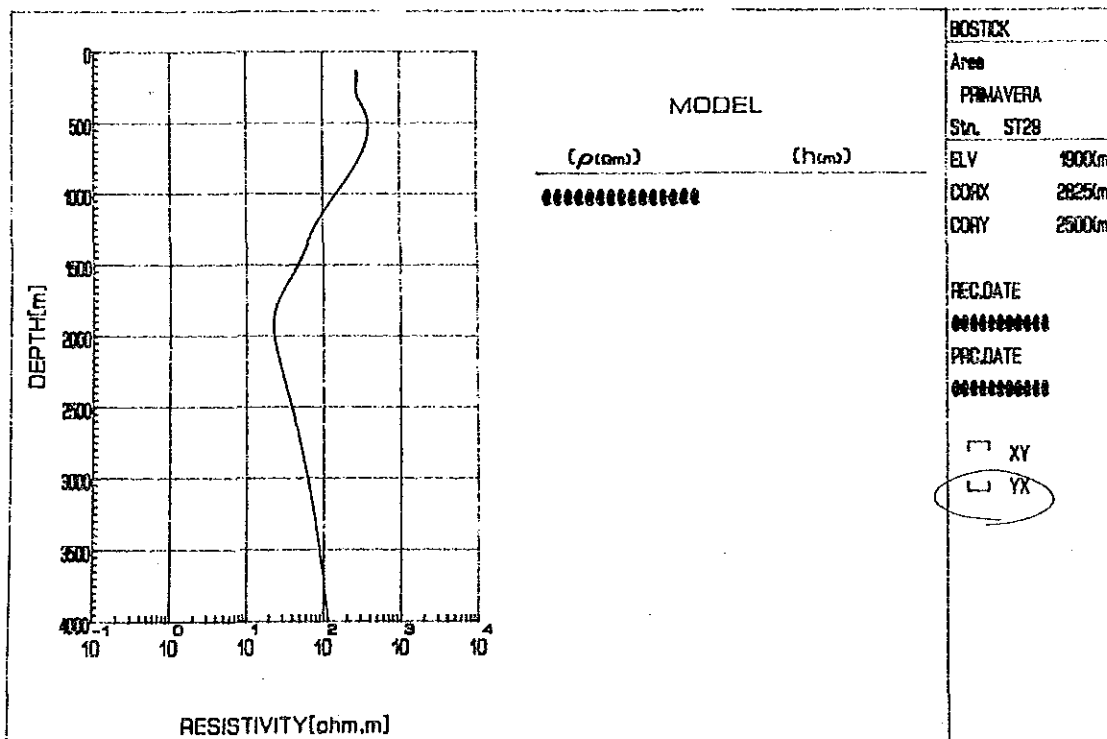

Sta. ST29

May 12 1986

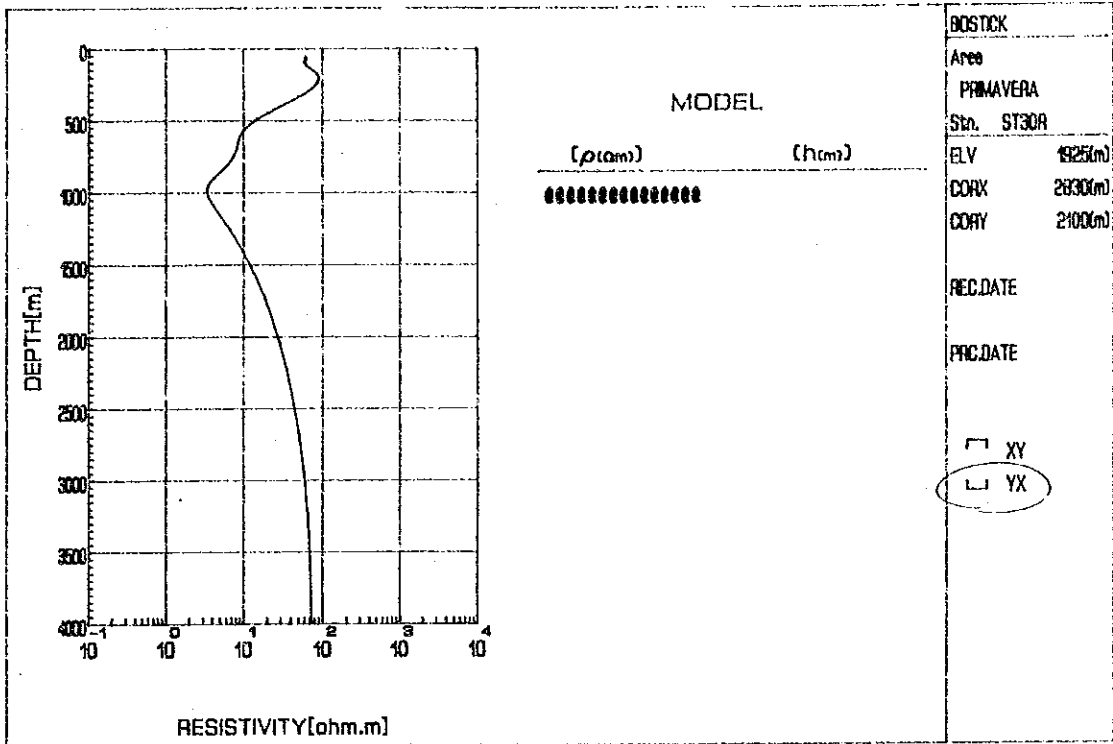

Sta. ST30

May 12 1988

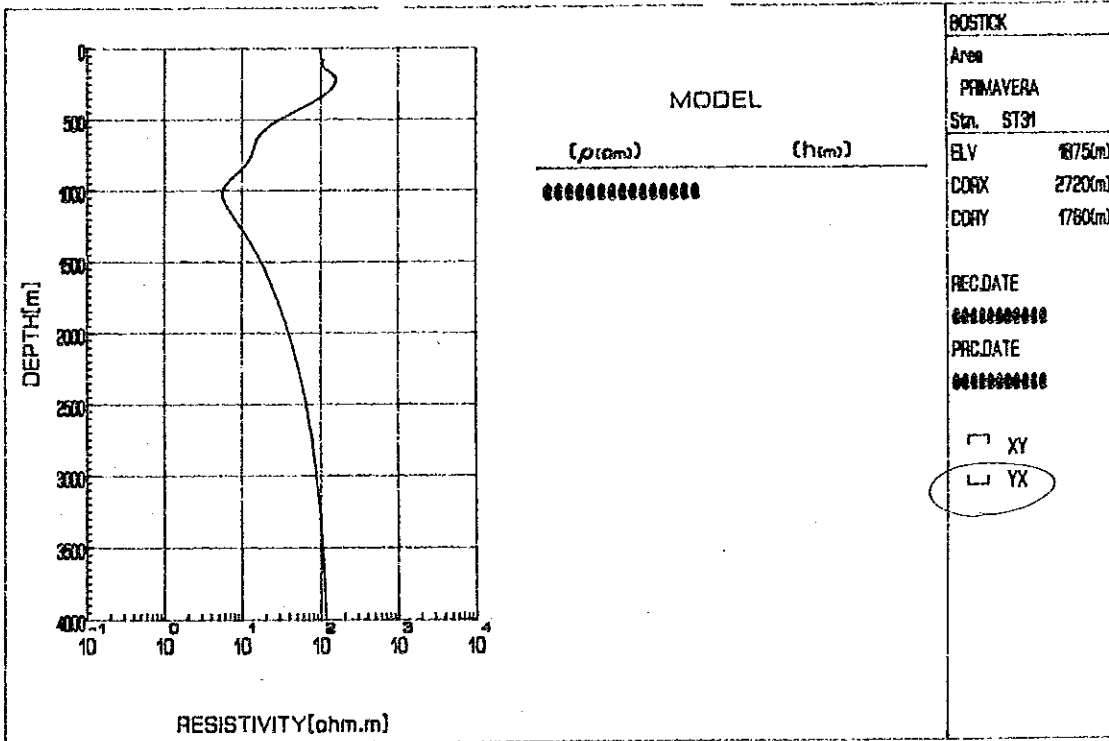

Sta. ST31

May 12 1988







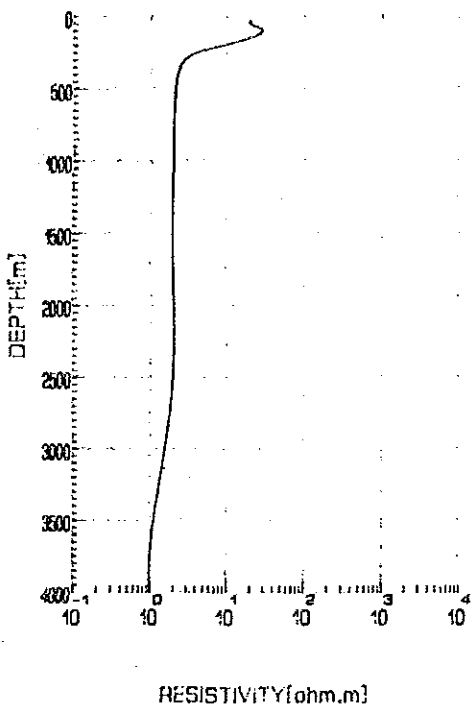

MODEL  
 (ρ(m)) (hm)  
 ●●●●●●●●●●●●●●●●●●●●

BOSTICK  
 Area  
 PRIMAVERA  
 Sta. ST36  
 ELV 1917(m)  
 CORX 3035(m)  
 CORY 1875(m)

REC.DATE  
 ●●●●●●●●●●  
 PRC.DATE  
 ●●●●●●●●●●

XY  
 L.Y.

Sta. ST36

May 12 1988

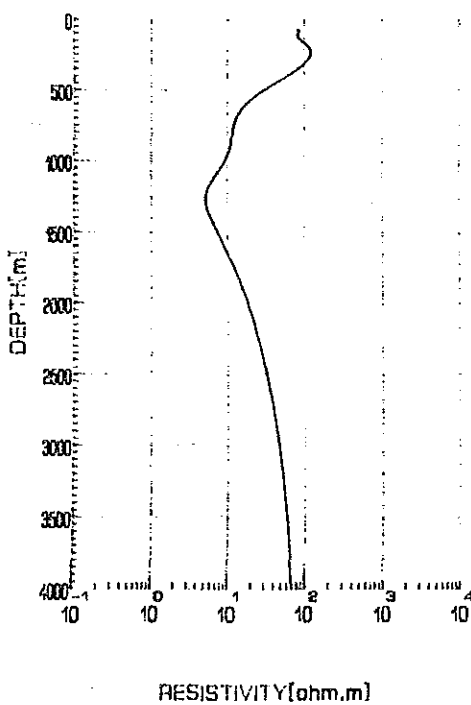

MODEL  
 (ρ(m)) (hm)  
 ●●●●●●●●●●●●●●●●●●●●

BOSTICK  
 Area  
 PRIMAVERA  
 Sta. ST37  
 ELV 1904(m)  
 CORX 2820(m)  
 CORY 1501(m)

REC.DATE  
 ●●●●●●●●●●  
 PRC.DATE  
 ●●●●●●●●●●

XY  
 L.Y.

Sta. ST37

May 12 1988

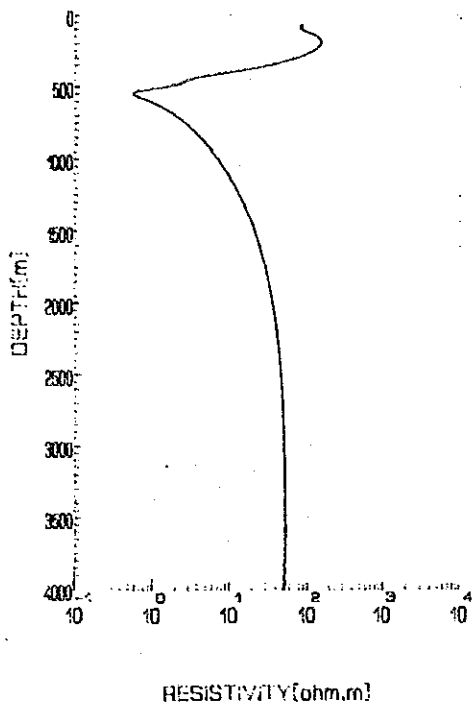

Sta. ST38

BOSTON  
 Area  
 PRIMAVERA  
 Sta. ST38  
 ELY 1945(m)  
 CORX 2955(m)  
 CORY 0880(m)

REC.DATE  
 \*\*\*\*\*  
 PRC.DATE  
 \*\*\*\*\*

11 11  
 11 11

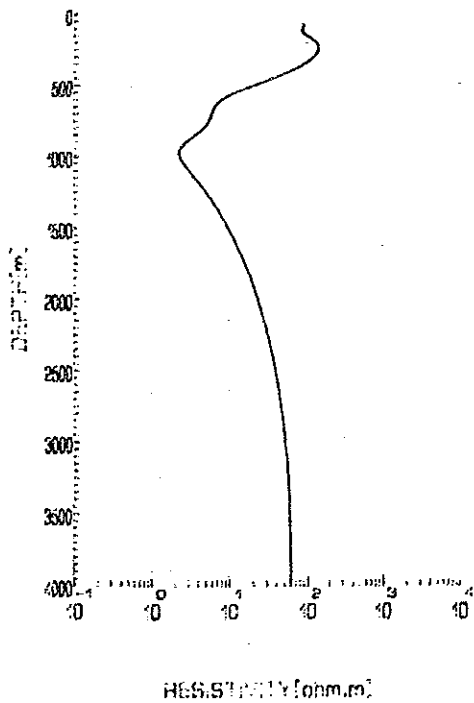

Sta. ST38

BOSTON  
 Area  
 PRIMAVERA  
 Sta. ST38  
 ELY 1955(m)  
 CORX 3200(m)  
 CORY 2280(m)

REC.DATE  
 \*\*\*\*\*  
 PRC.DATE  
 \*\*\*\*\*

11 11  
 11 11

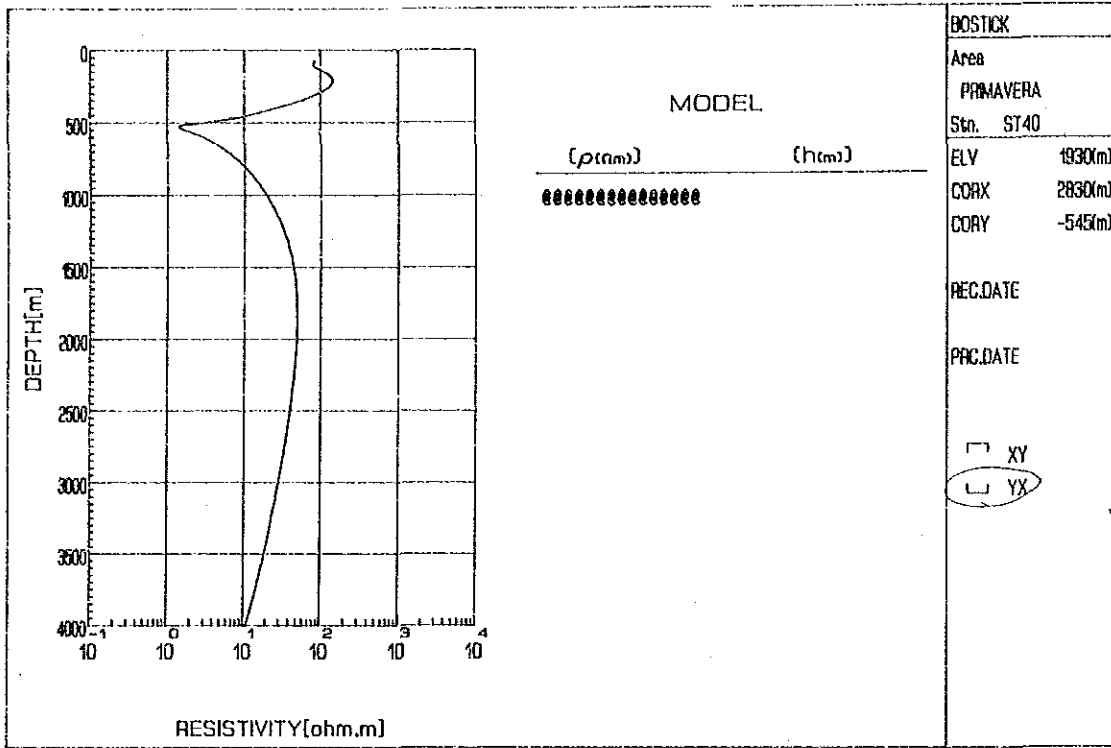

Stn. ST40

May 14 1986

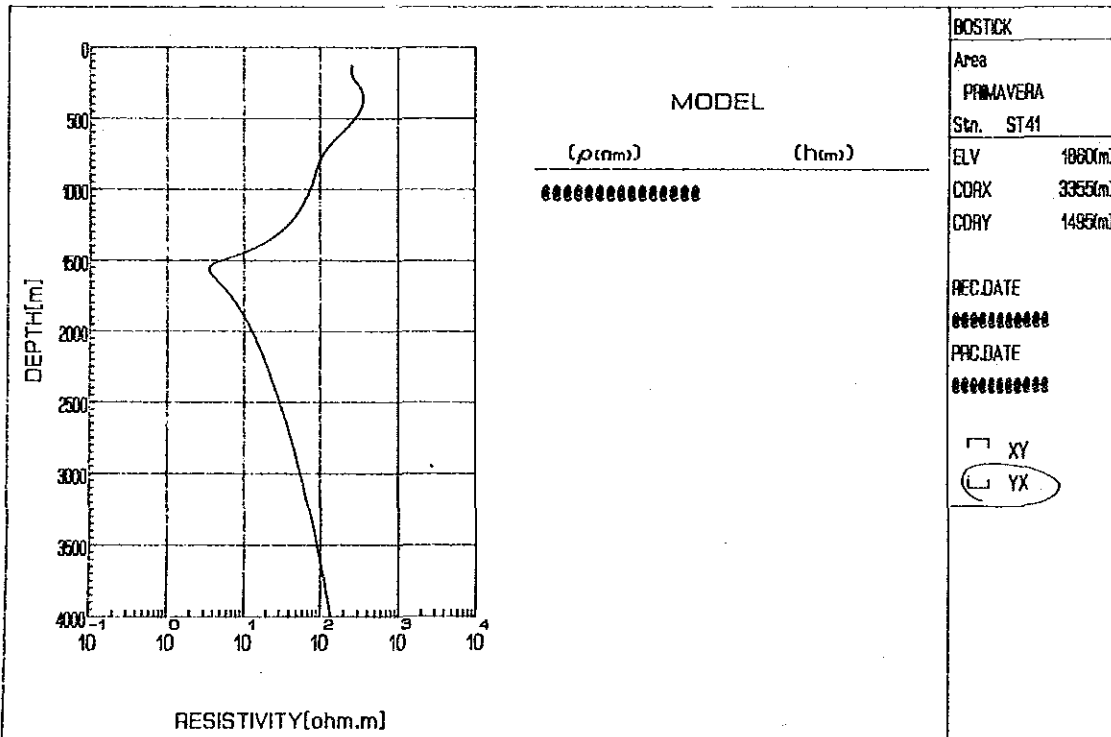

Stn. ST41

May 14 1986

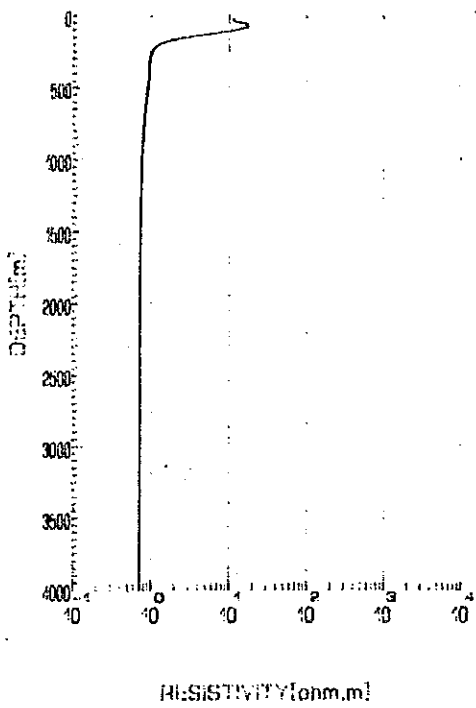

Sta. ST42

BOSTICK  
 Area  
 PRMAYERA  
 Sta. ST42  
 ELV 1860(m)  
 CORX 1.65(m)  
 CORV 1850(m)

REC.DATE  
 #####  
 PRG.DATE  
 #####

Y  
 Y

MODEL

( $\rho$ (ohm)) (h(m))  
 #####

RESISTIVITY[ohm.m]

May '2 1986

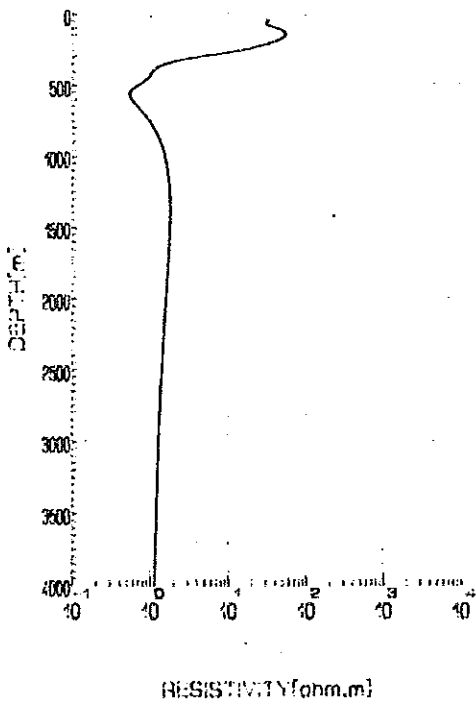

Sta. ST43

BOSTICK  
 Area  
 PRMAYERA  
 Sta. ST43  
 ELV 1886(m)  
 CORX 0.310(m)  
 CORV 1885(m)

REC.DATE  
 #####  
 PRG.DATE  
 #####

Y  
 Y

MODEL

( $\rho$ (ohm)) (h(m))  
 #####

RESISTIVITY[ohm.m]

May '2 1986



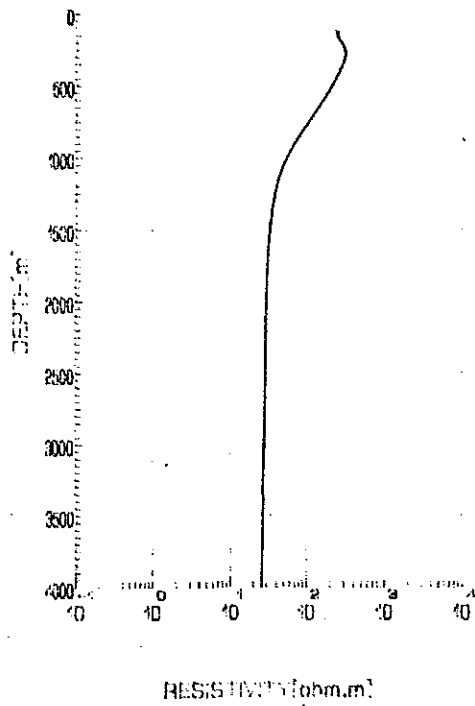

Sta. S146

BOSTON  
Area  
PARAMETER  
Sta. S146  
ELEV 1020(m)  
CORR 1530(m)  
CONF 1545(m)

REC.DATE  
\*\*\*\*\*  
PRG.DATE  
\*\*\*\*\*

1 1 77  
1 1 77

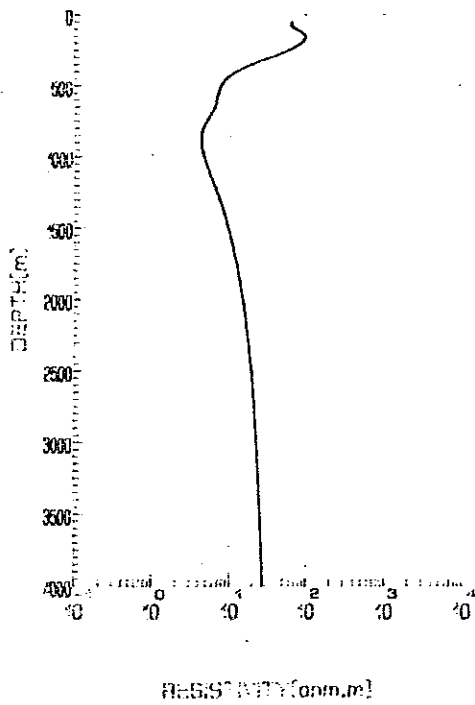

Sta. S147

BOSTON  
Area  
PARAMETER  
Sta. S147  
ELEV 1045(m)  
CORR 1585(m)  
CONF 1570(m)

REC.DATE  
\*\*\*\*\*  
PRG.DATE  
\*\*\*\*\*

1 1 77  
1 1 77

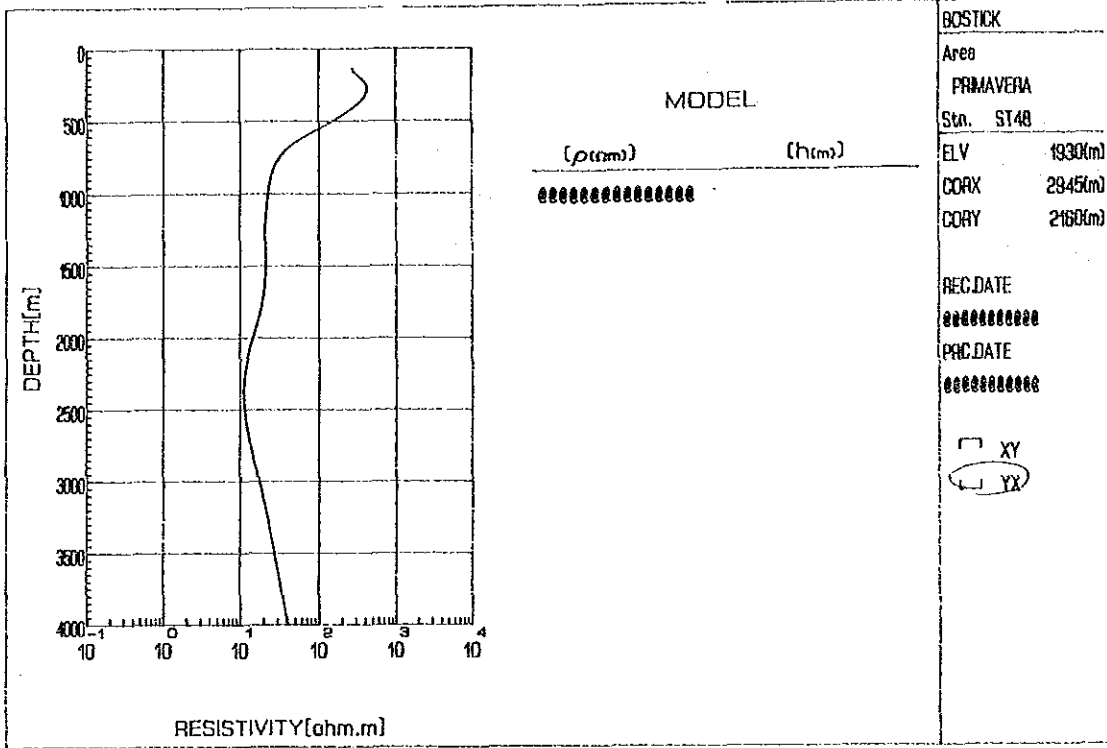

Sta. ST48

May 14 1986

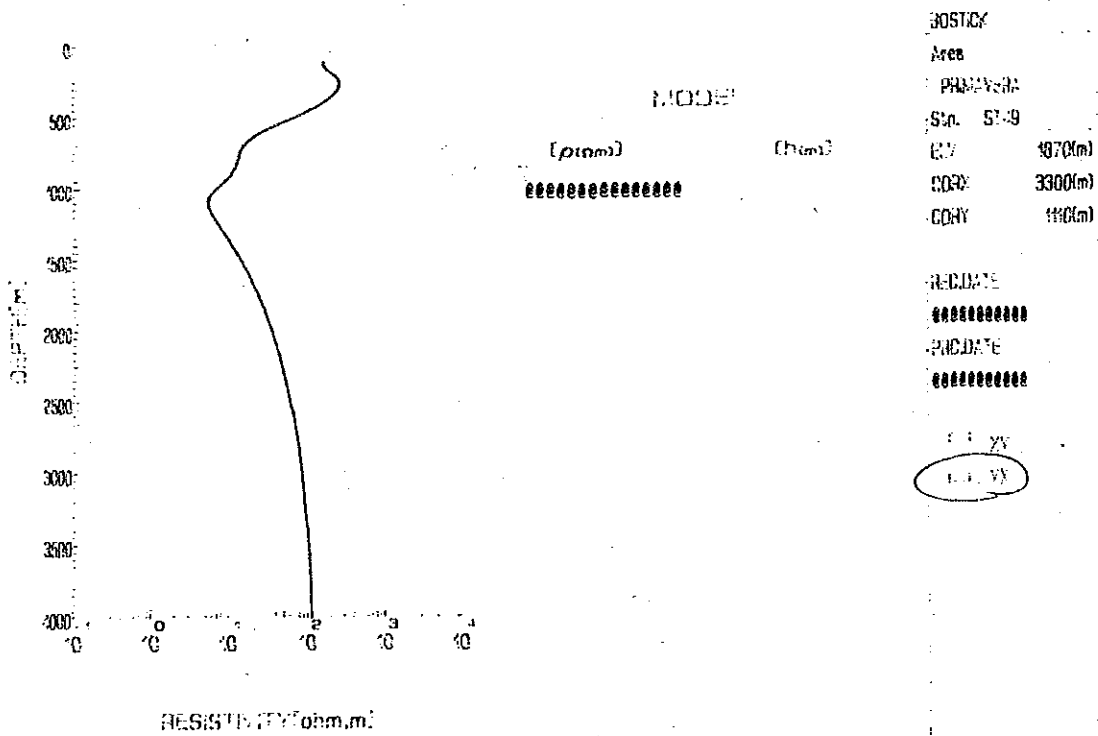

Sta. ST49

May 12 1986



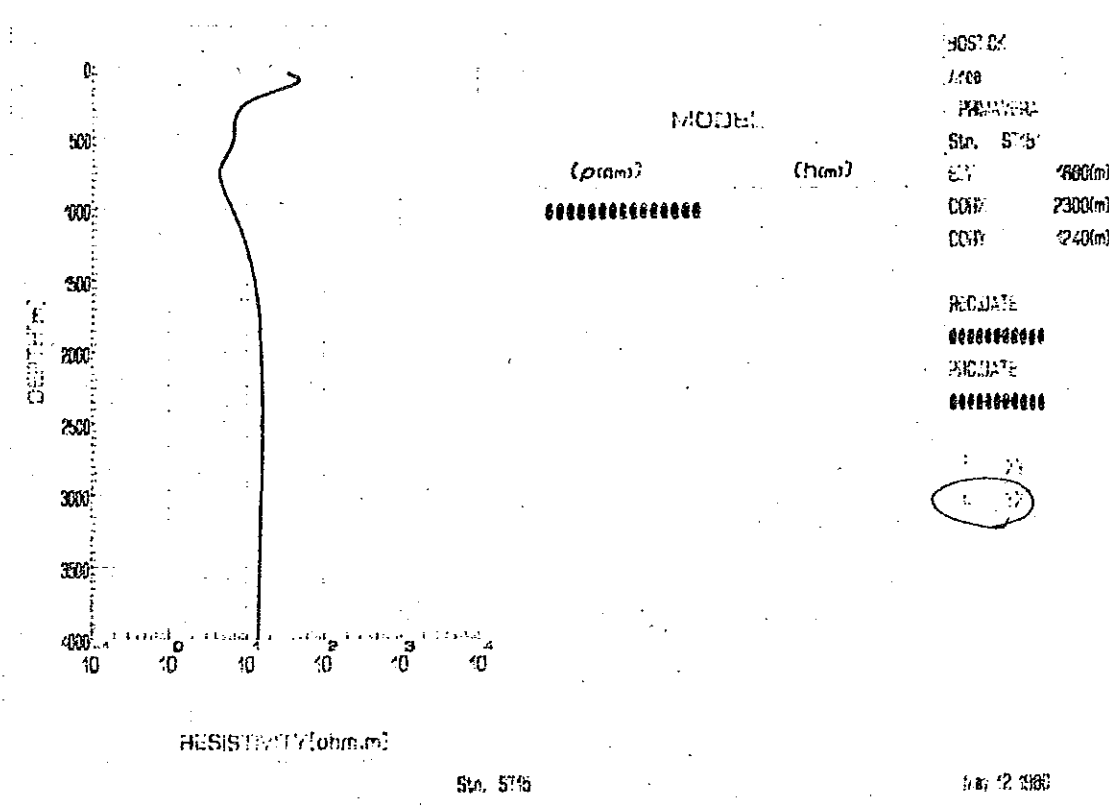
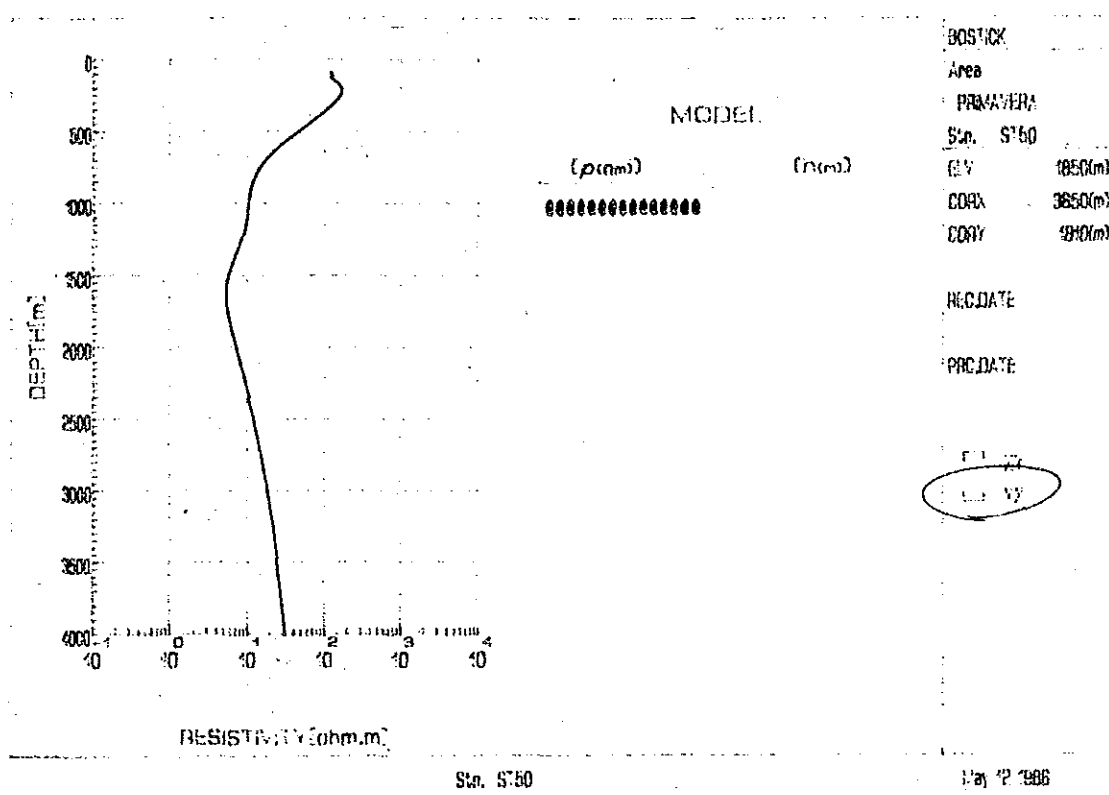

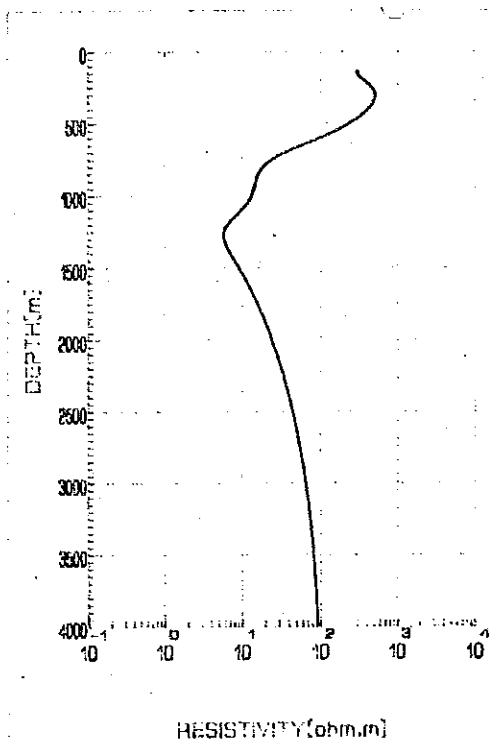

MODEL  
 (ρ(ohm)) (h(m))  
 @@@@@@@@@@@@@@@@

BOSTICK  
 Area  
 PRIMAVERA  
 Sta. ST52  
 ELV 1895(m)  
 CORX 3021(m)  
 CORY 0325(m)

REC DATE  
 @@@@@@@@@@@@  
 PRC DATE  
 @@@@@@@@@@@@

XY  
 YX

Sta. ST52

May 12 1988

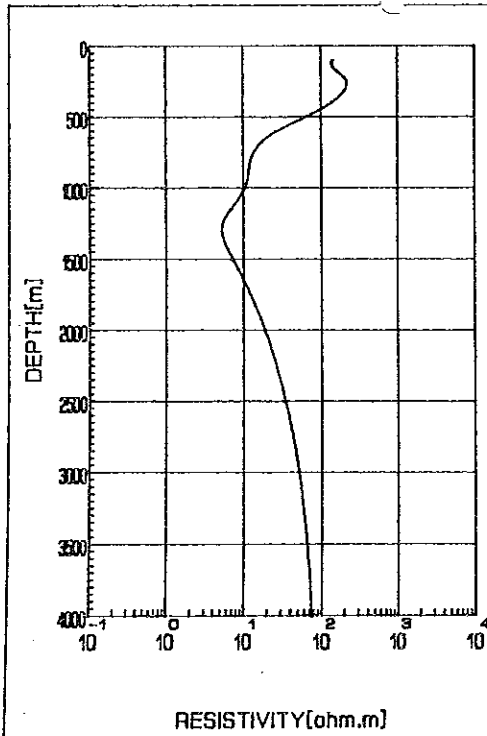

MODEL  
 (ρ(ohm)) (h(m))  
 @@@@@@@@@@@@@@@@

BOSTICK  
 Area  
 PRIMAVERA  
 Sta. ST53  
 ELV 1830(m)  
 CORX 0740(m)  
 CORY 1865(m)

REC DATE  
 @@@@@@@@@@@@  
 PRC DATE  
 @@@@@@@@@@@@

XY  
 YX

Sta. ST53

May 12 1988

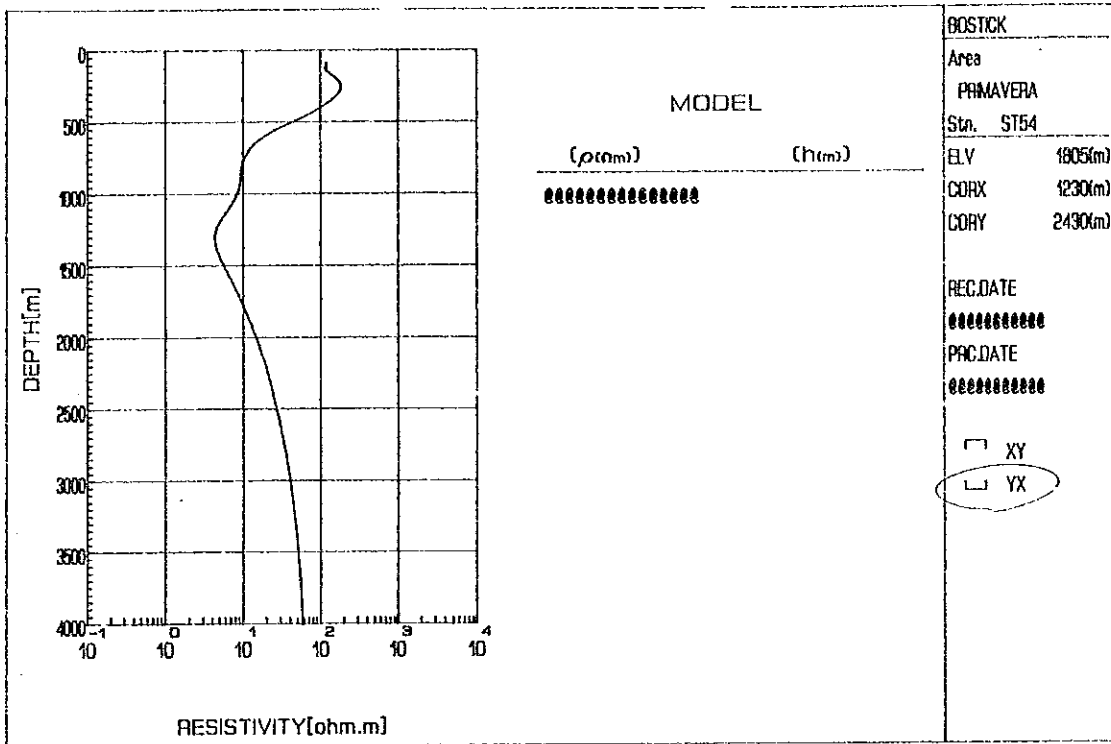

Sta. ST54

May 12 1986



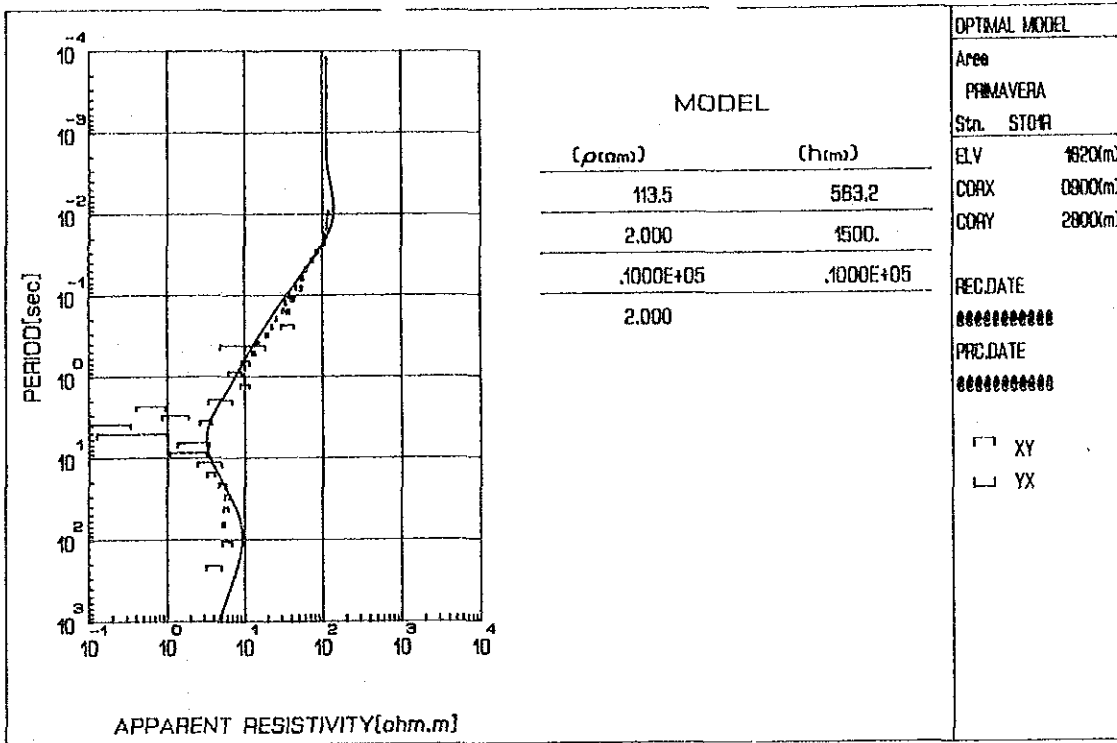

Sta. ST01

May 10 1986

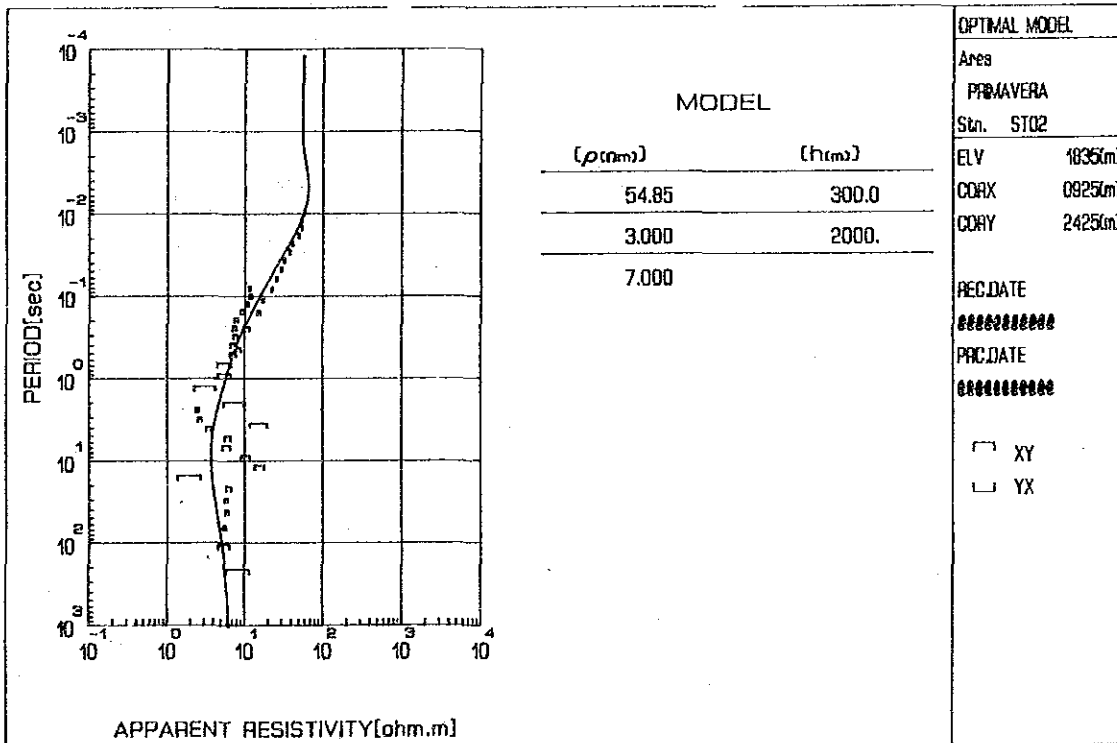

Sta. ST02

May 10 1986

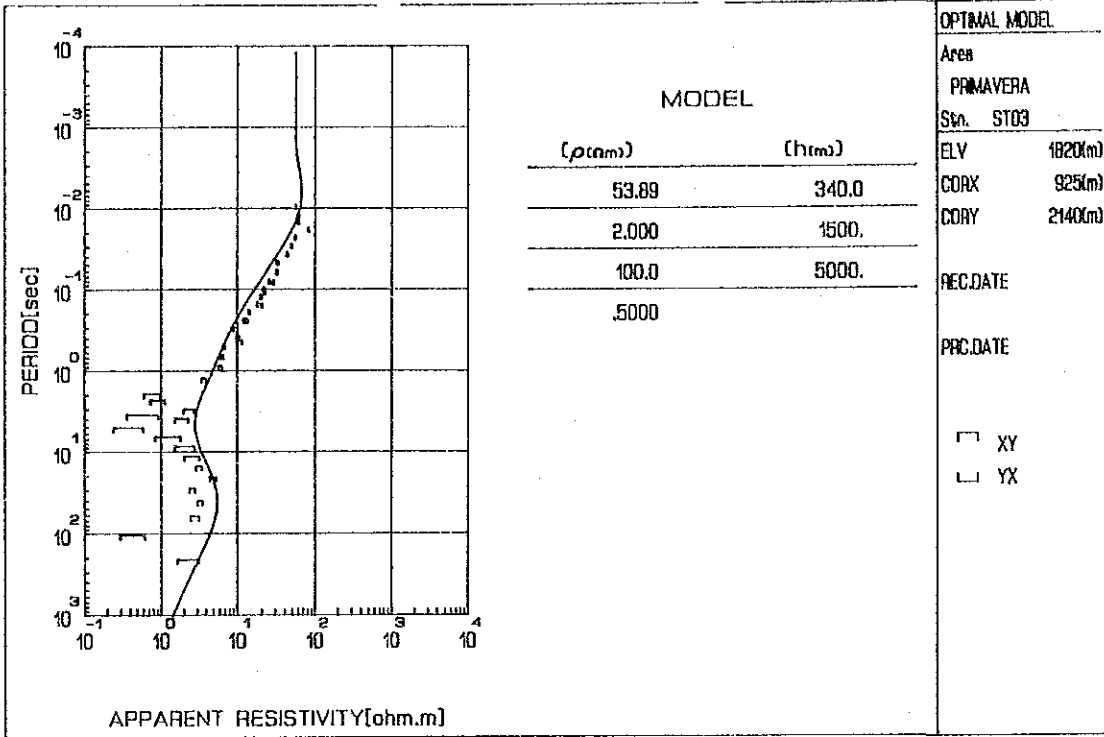

Sta. ST03

May 10 1986

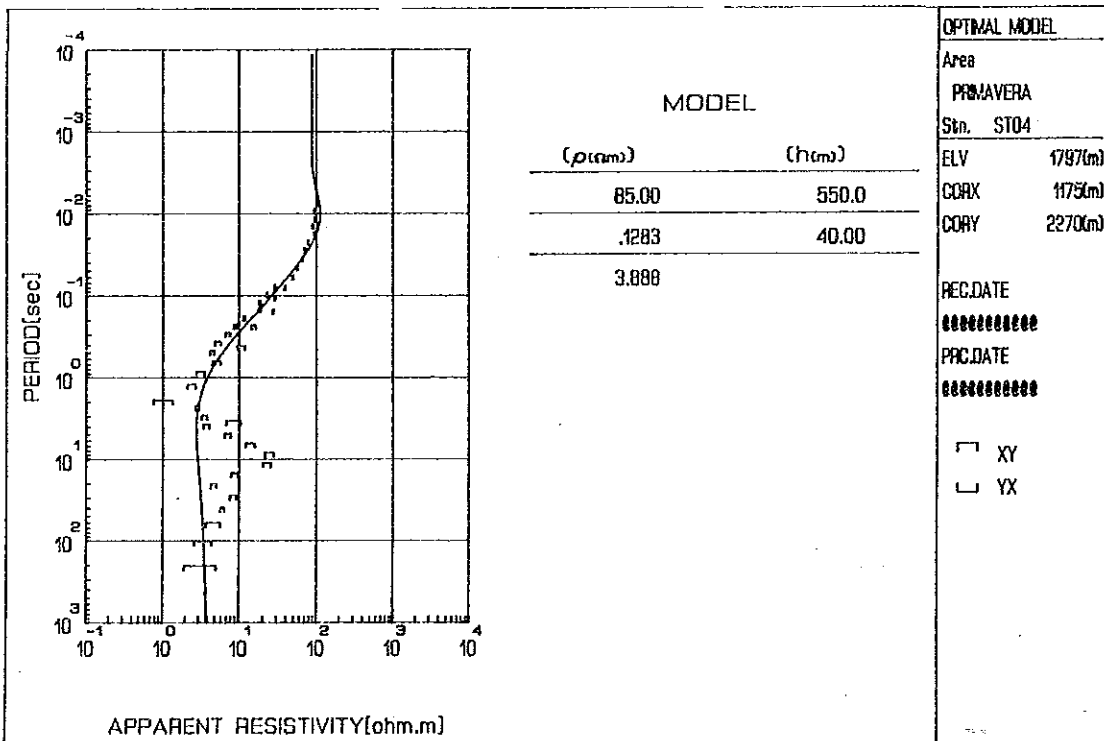

Sta. ST04

May 10 1986

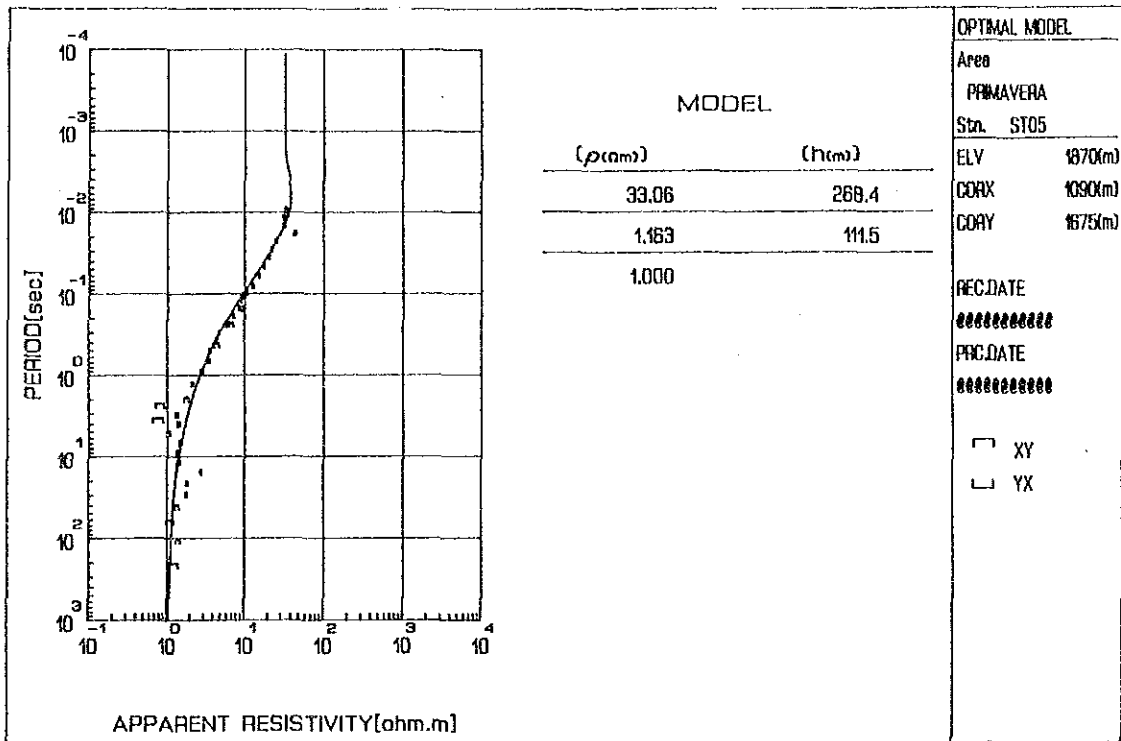

Sta. ST05

May 10 1986

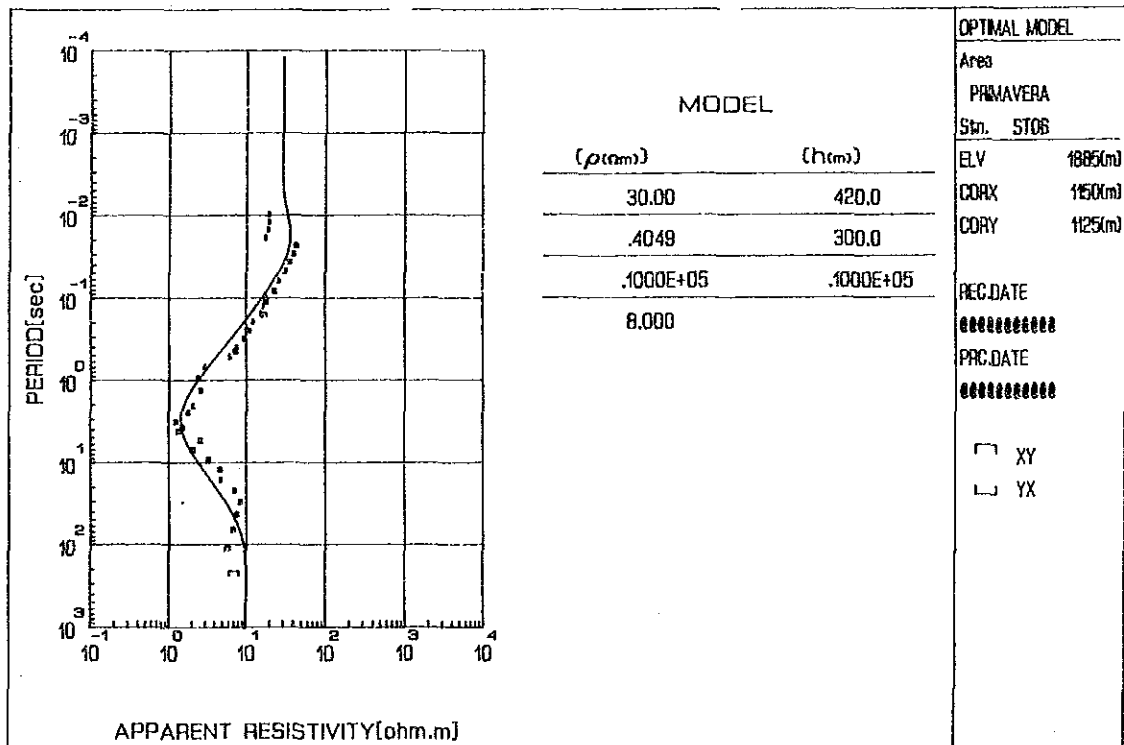

Sta. ST06

May 10 1986

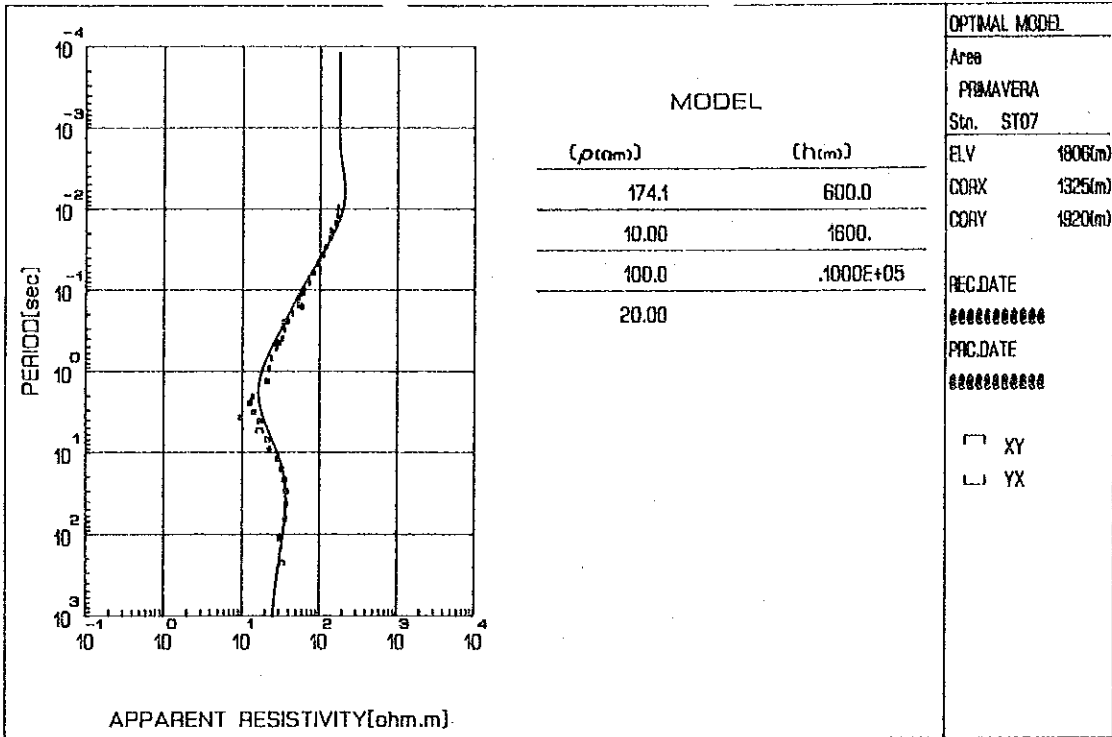

Sta. ST07

May 10 1986

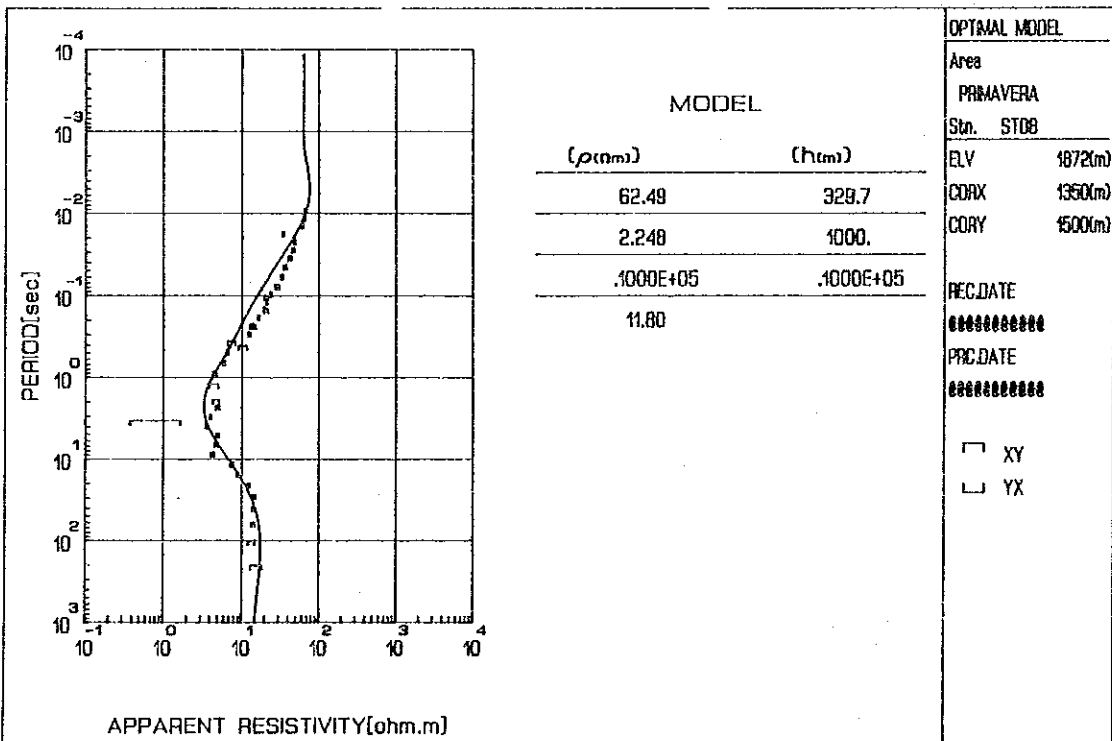

Sta. ST08

May 10 1986



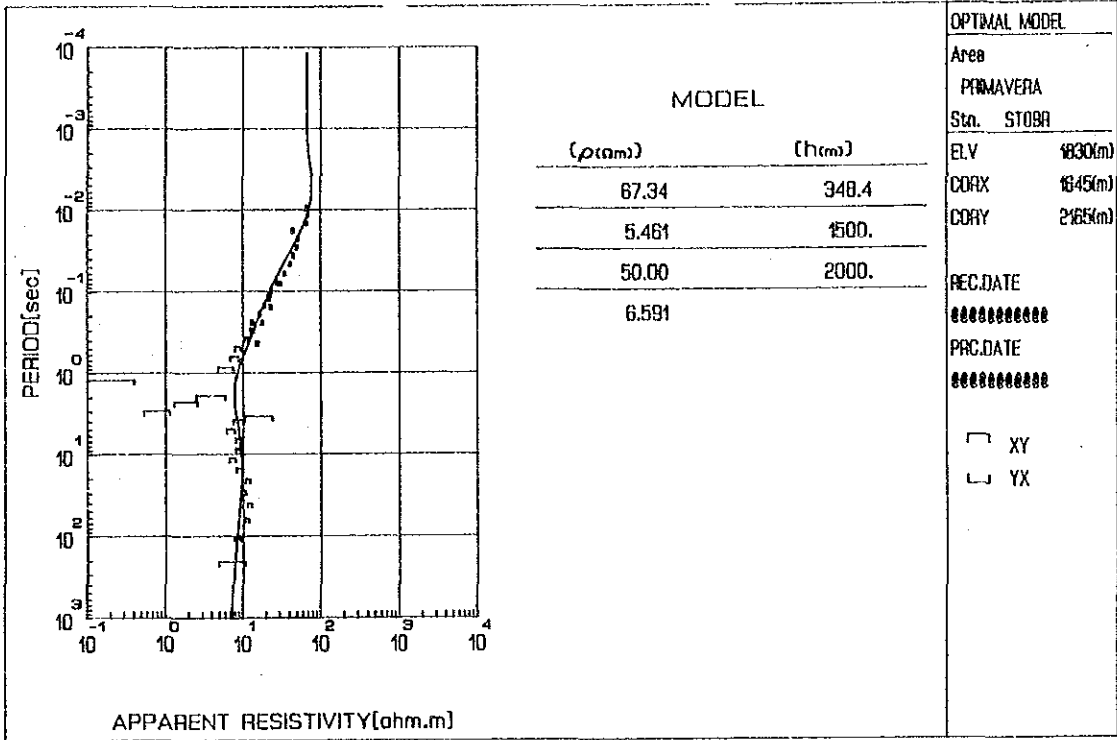

Sta. ST09

May 10 1986

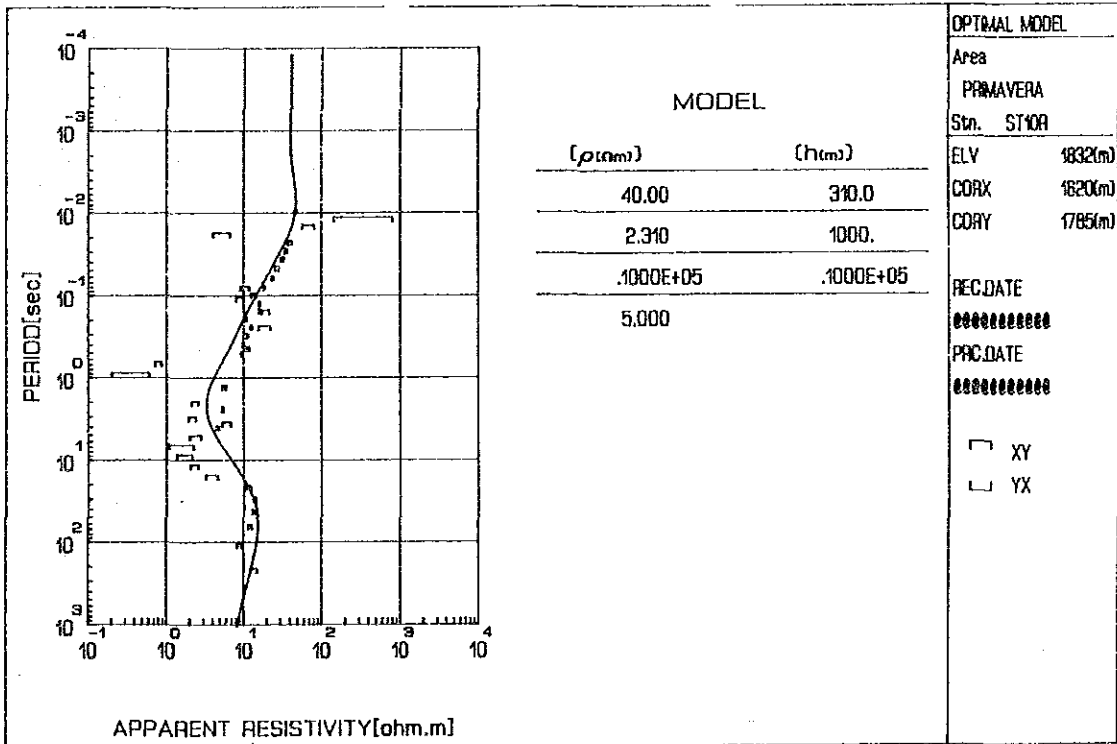

Sta. ST10

May 10 1986

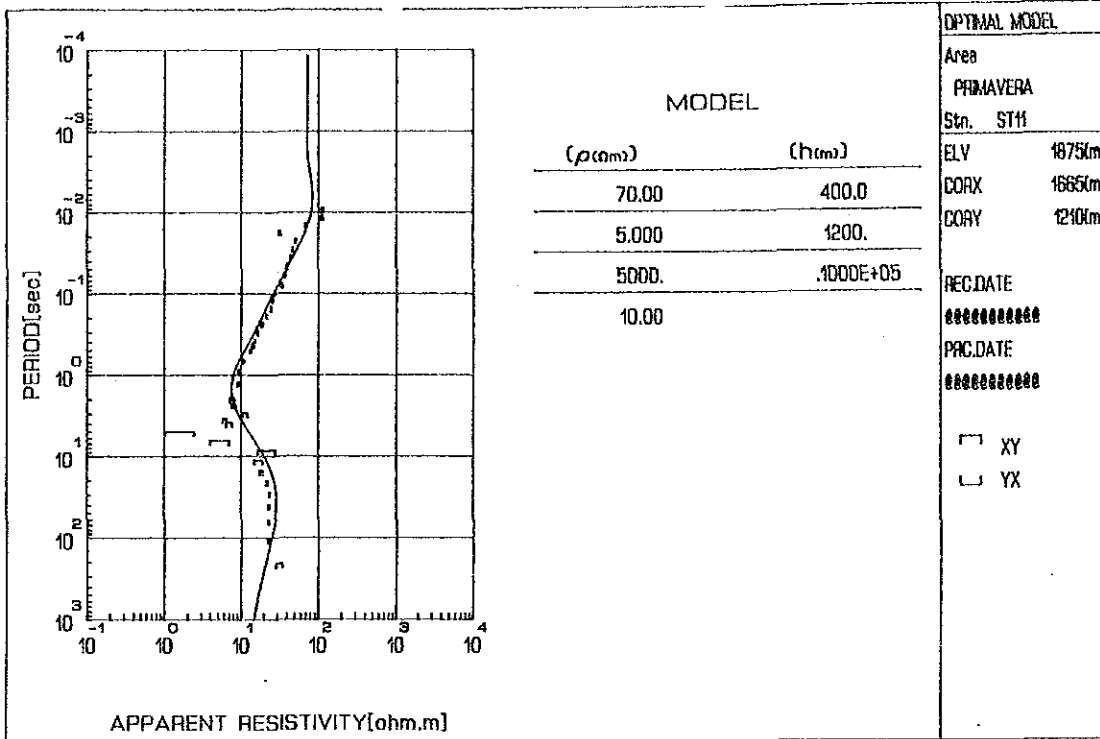

Sta. ST11

May 10 1986

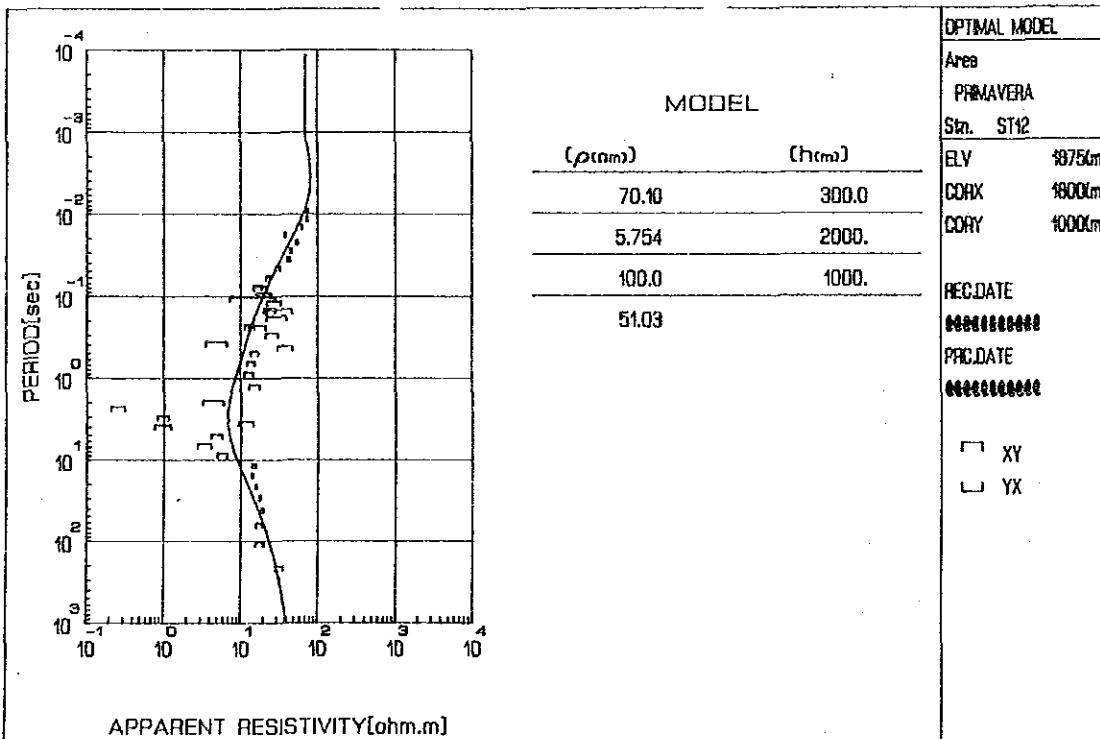

Sta. ST12

May 10 1986

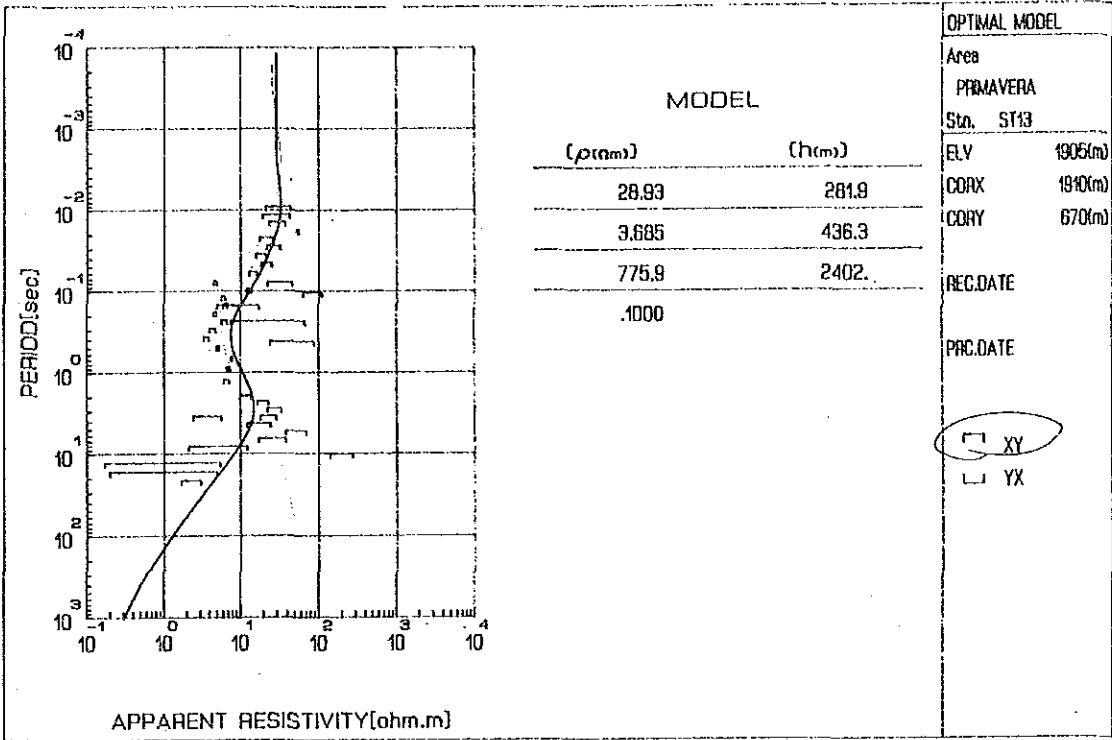

Sta. ST13

May 14 1966

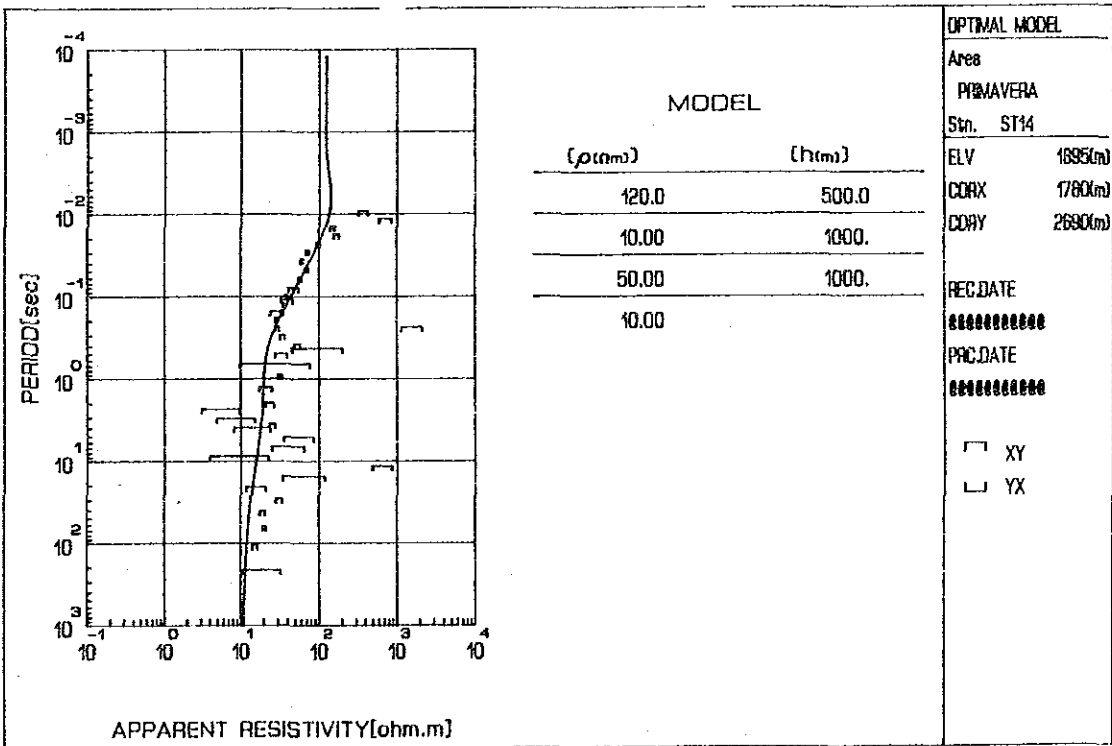

Sta. ST14

May 10 1966

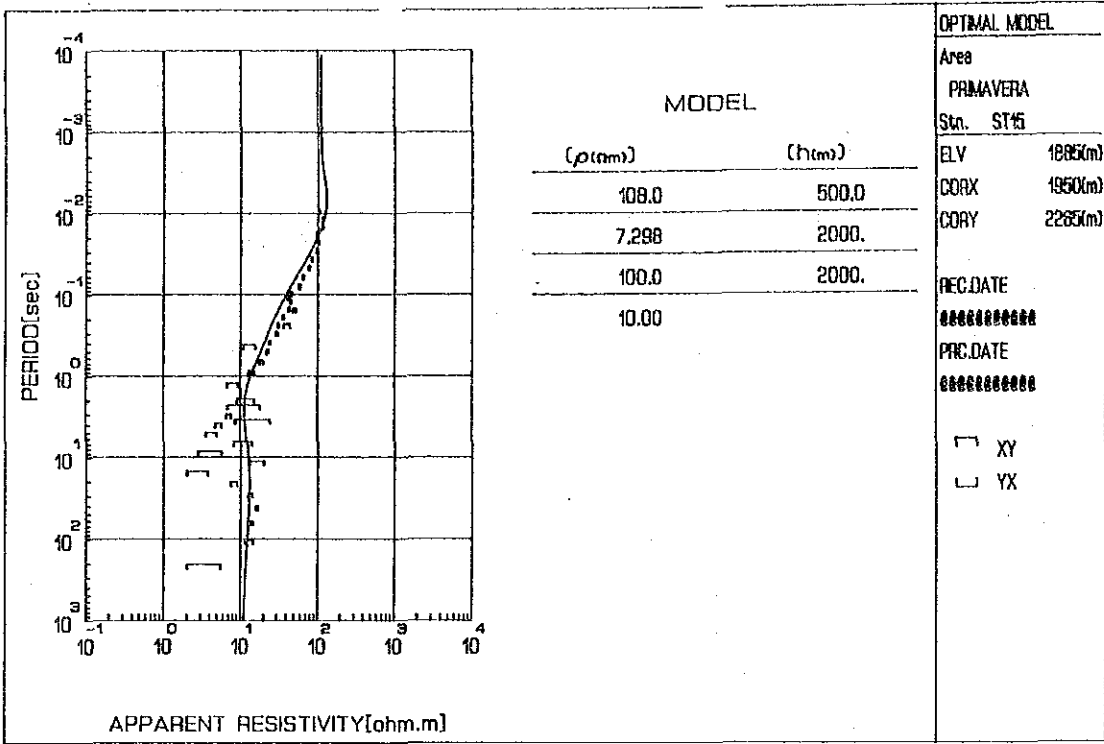

Sta. ST15

May 10 1986

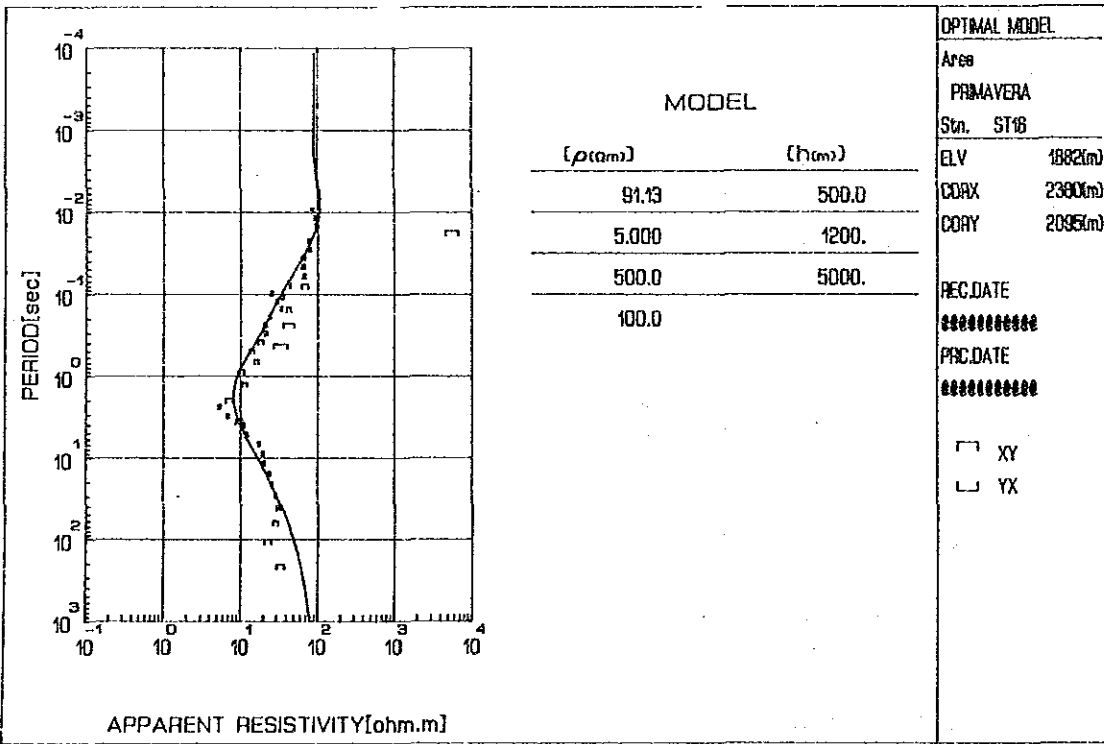

Sta. ST16

May 10 1986

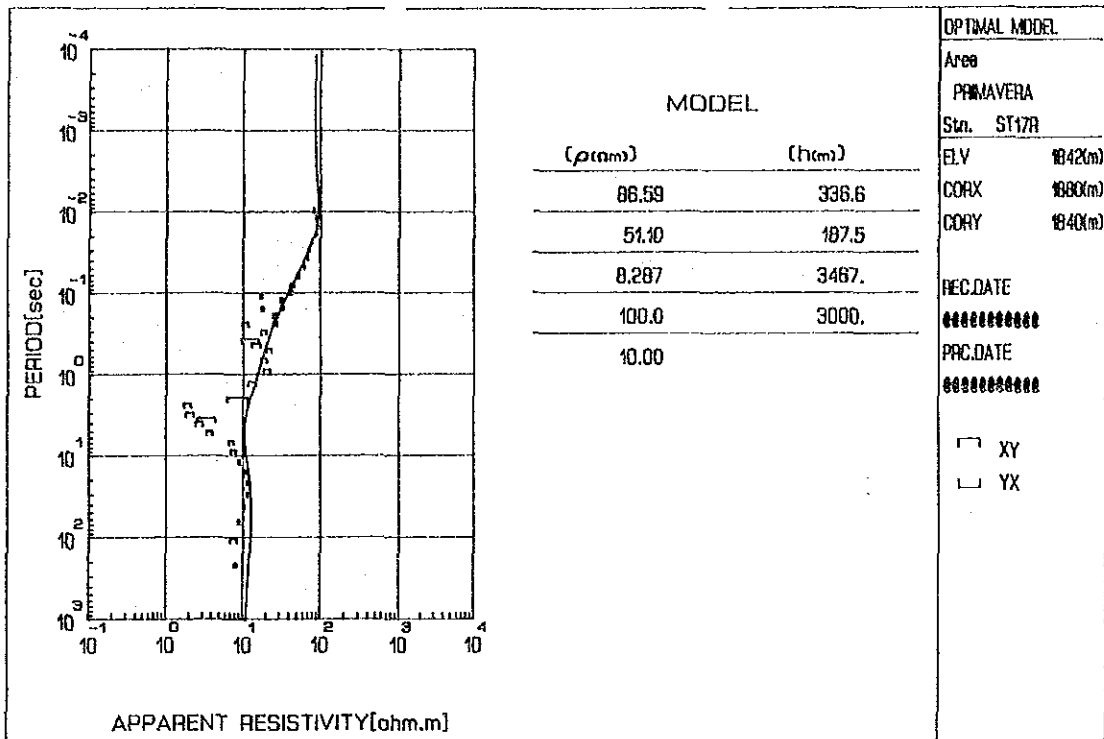

Sta. ST17

May 10 1986

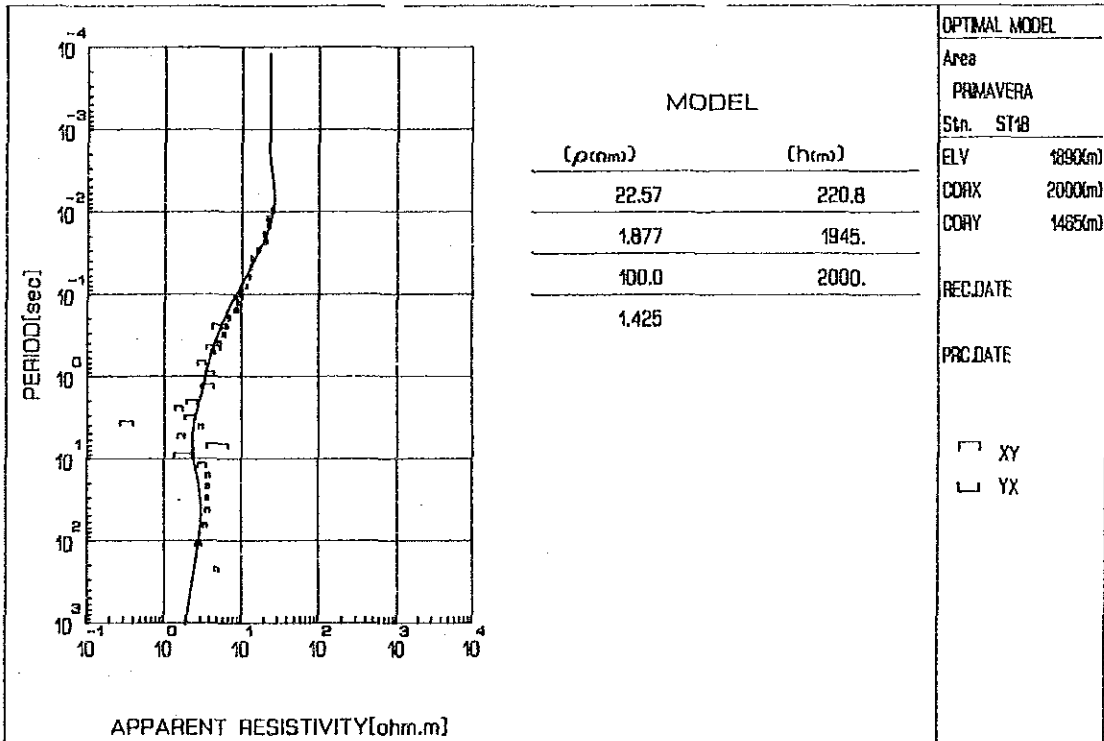

Sta. ST18

May 10 1986

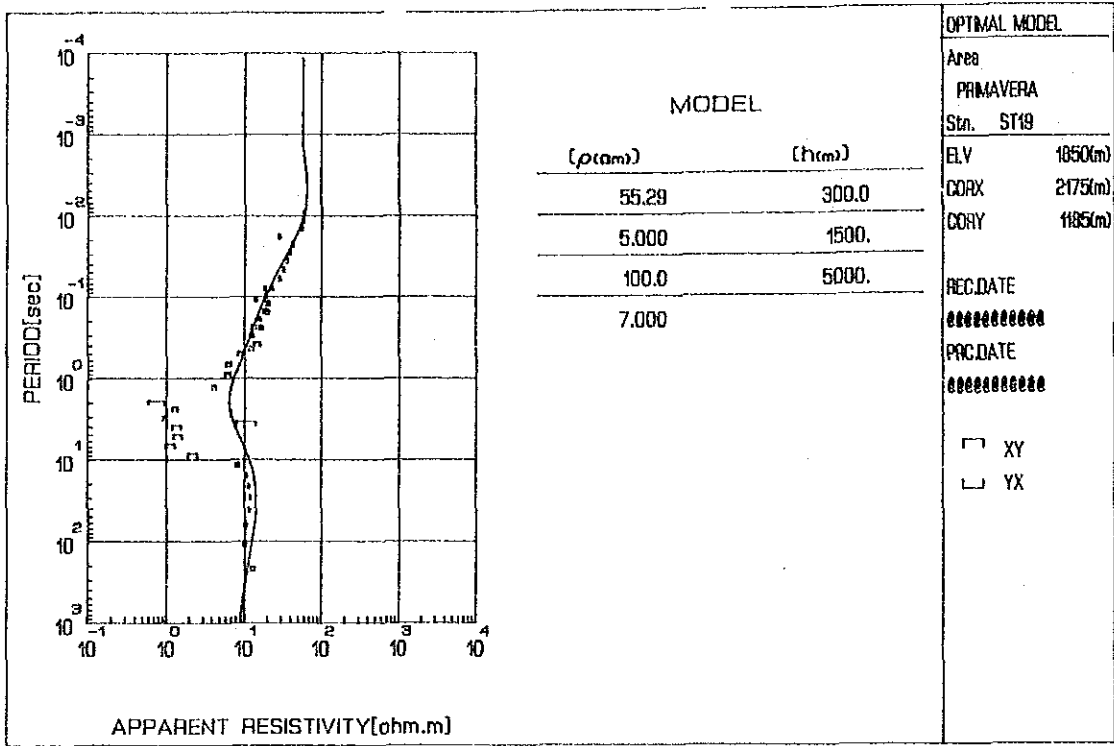

Sta. ST19

May 10 1986

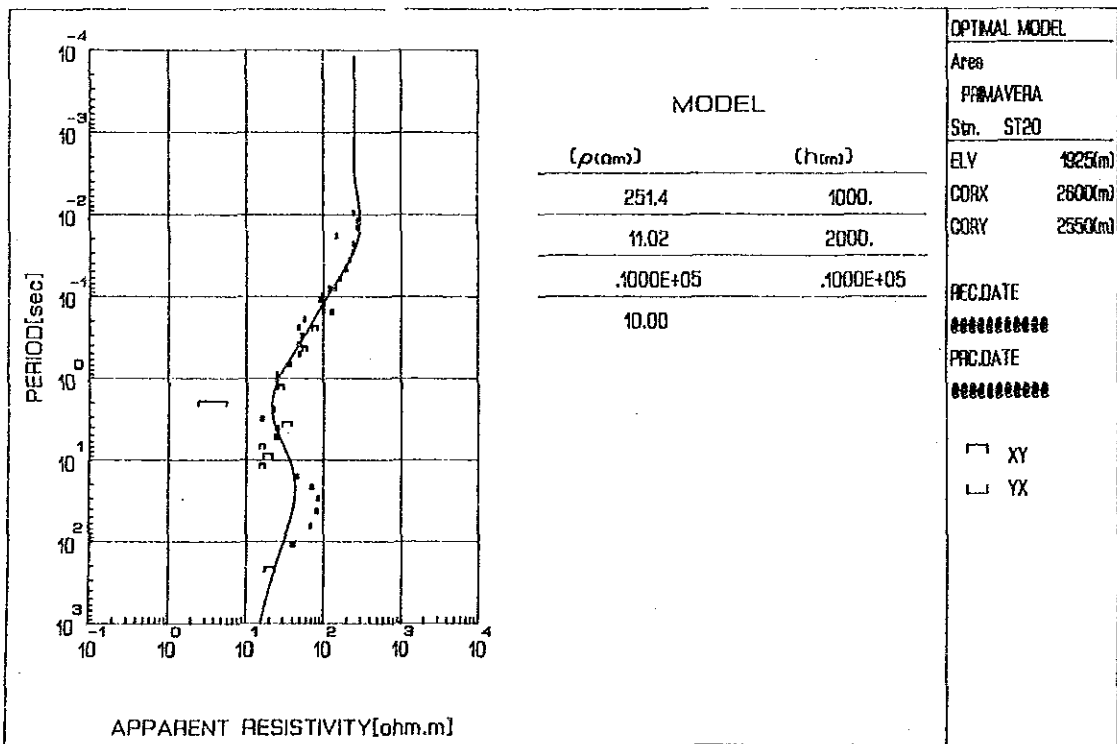

Sta. ST20

May 10 1986

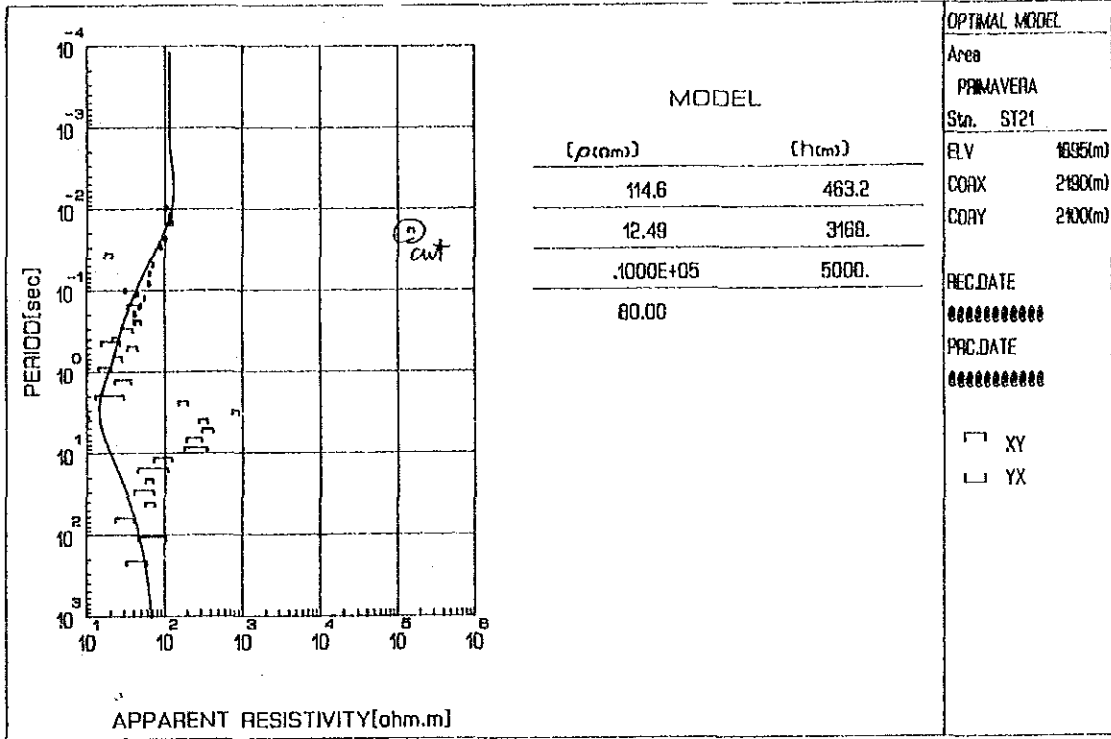

Sta. ST21

May 10 1986

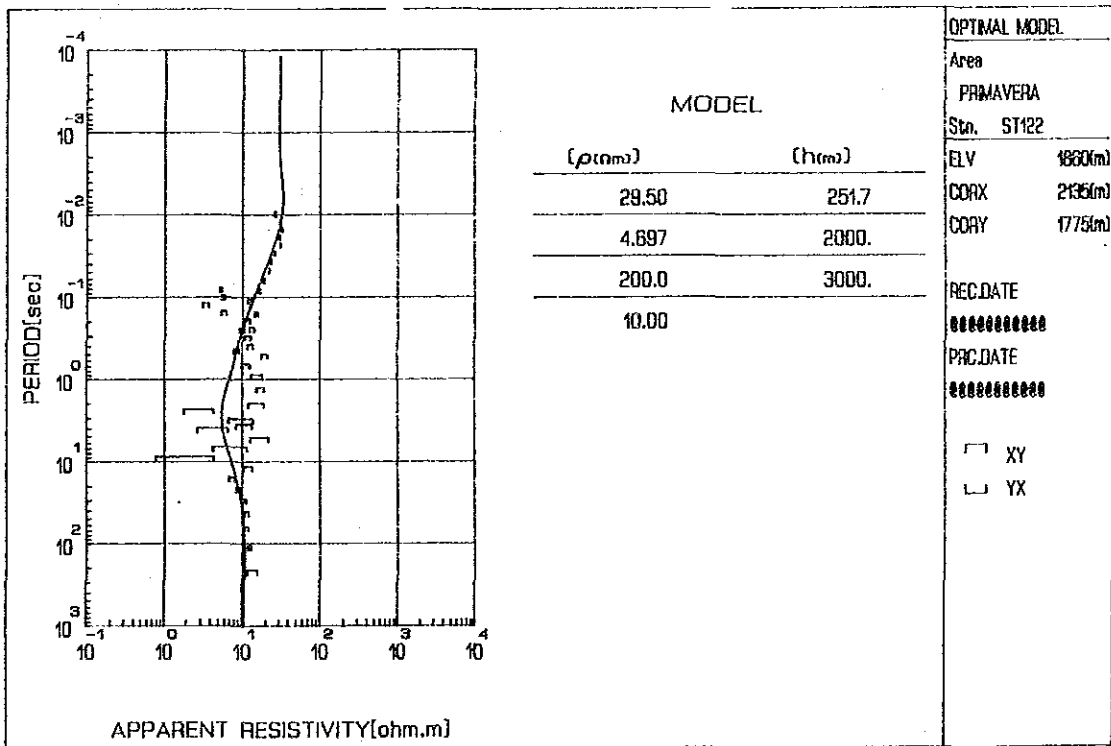

Sta. ST12

May 10 1986

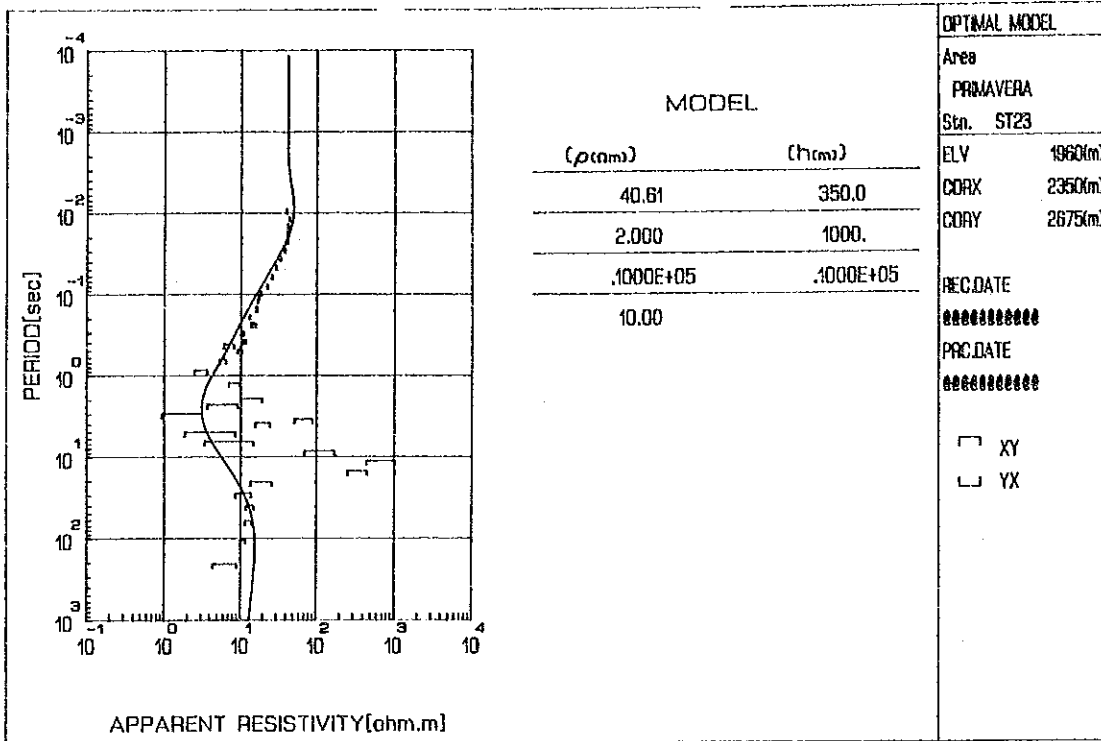

Sta. ST23

May 10 1986

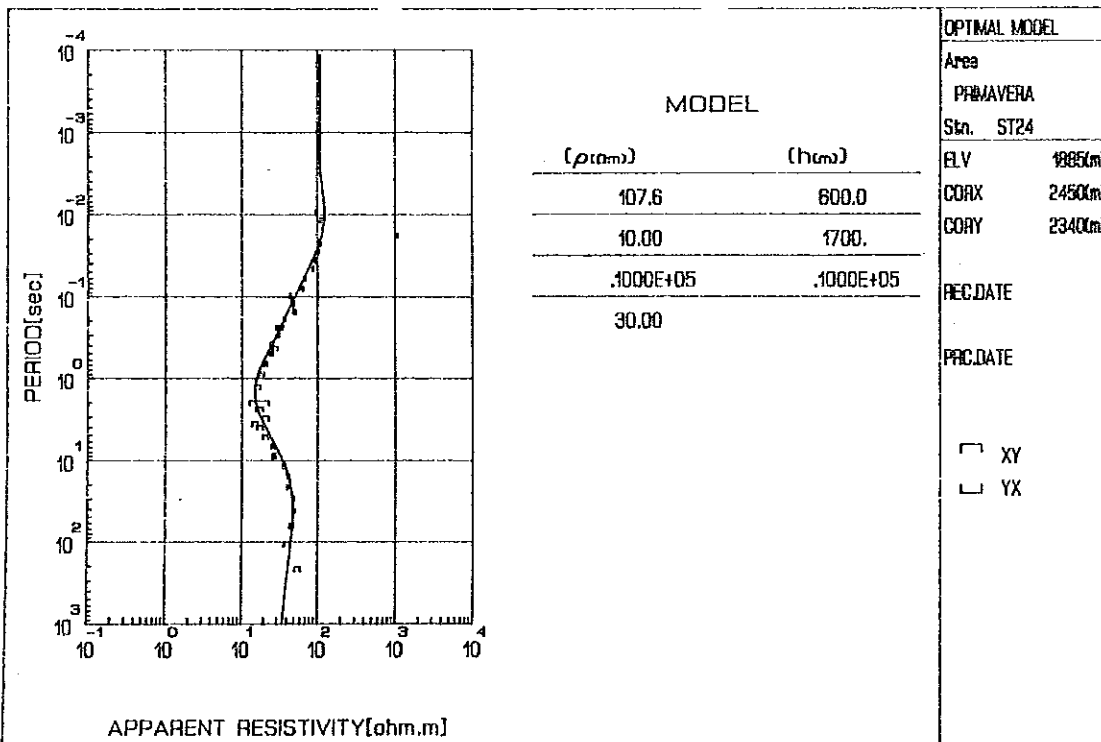

Sta. ST24

May 10 1986



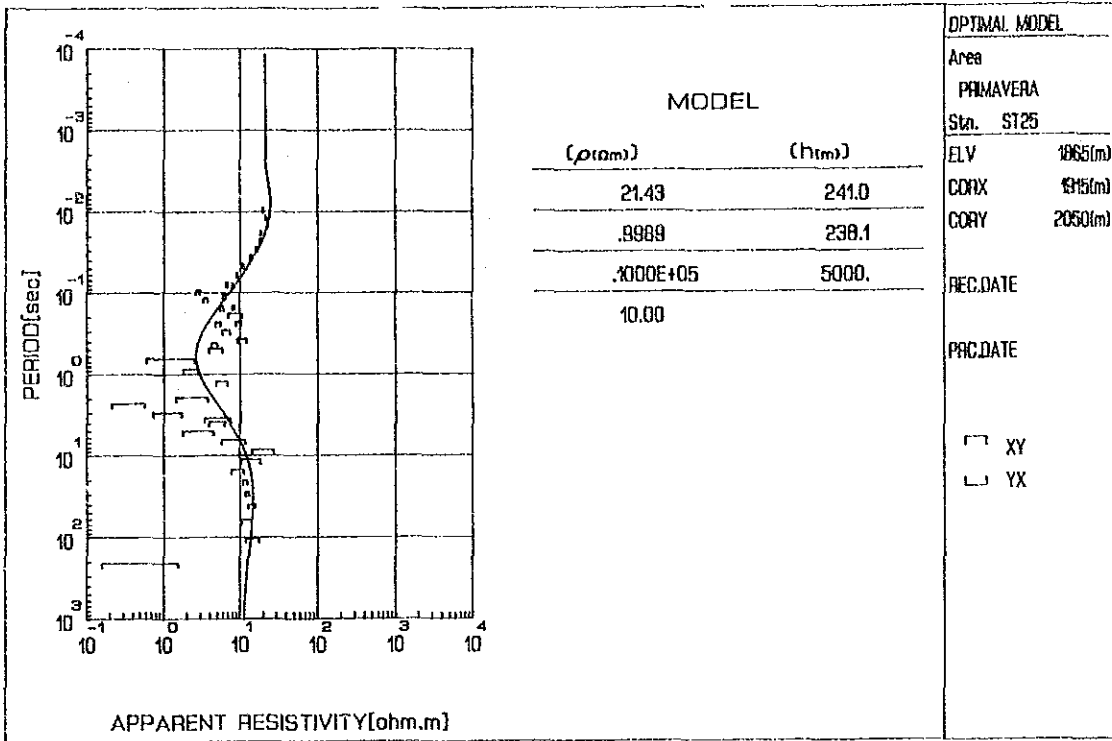

Sta. ST25

May 10 1986

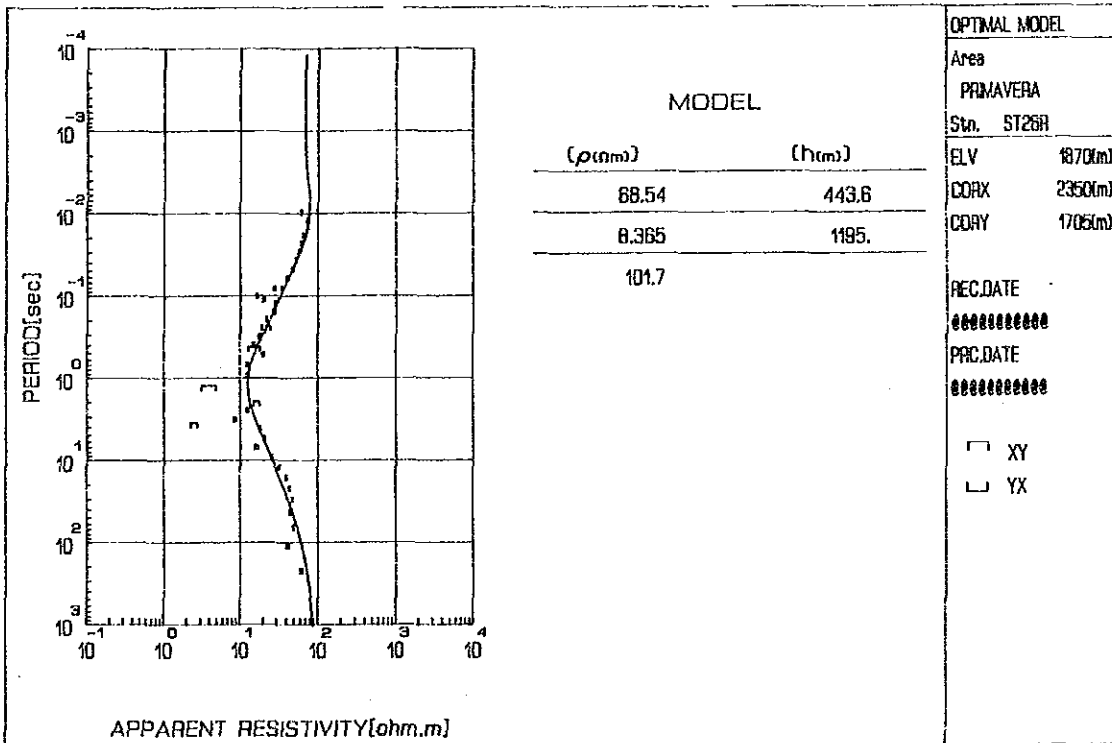

Sta. ST26

May 10 1986

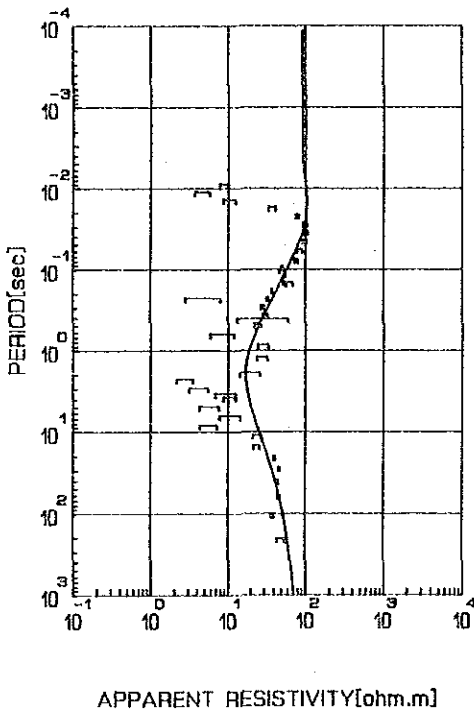

MODEL

$(\rho(\text{ohm.m}))$	$(h(\text{m}))$
90.00	700.0
10.00	1500.
80.00	

OPTIMAL MODEL  
 Area  
 PRIMAVERA  
 Stn. ST27  
 ELV 1918(m)  
 CORX 2420(m)  
 CORY 2435(m)  
 REC.DATE  
 #####  
 PRG.DATE  
 #####  
 XY  
 YX

Stn. ST27

May 10 1986

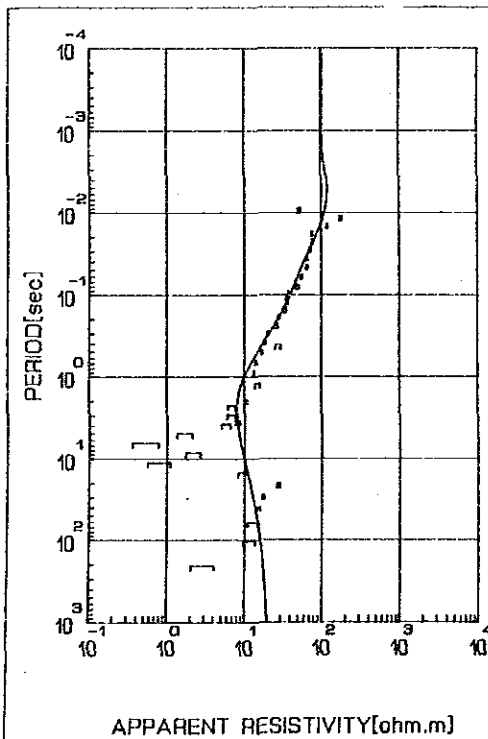

MODEL

$(\rho(\text{ohm.m}))$	$(h(\text{m}))$
103.7	438.6
10.19	442.0
252.2	10.00
1454.	10.00
1.978	347.8
21.82	

OPTIMAL MODEL  
 Area  
 PRIMAVERA  
 Stn. ST28  
 ELV 1887(m)  
 CORX 2580(m)  
 CORY 2265(m)  
 REC.DATE  
 #####  
 PRG.DATE  
 #####  
 XY  
 YX

Stn. ST28

May 12 1986

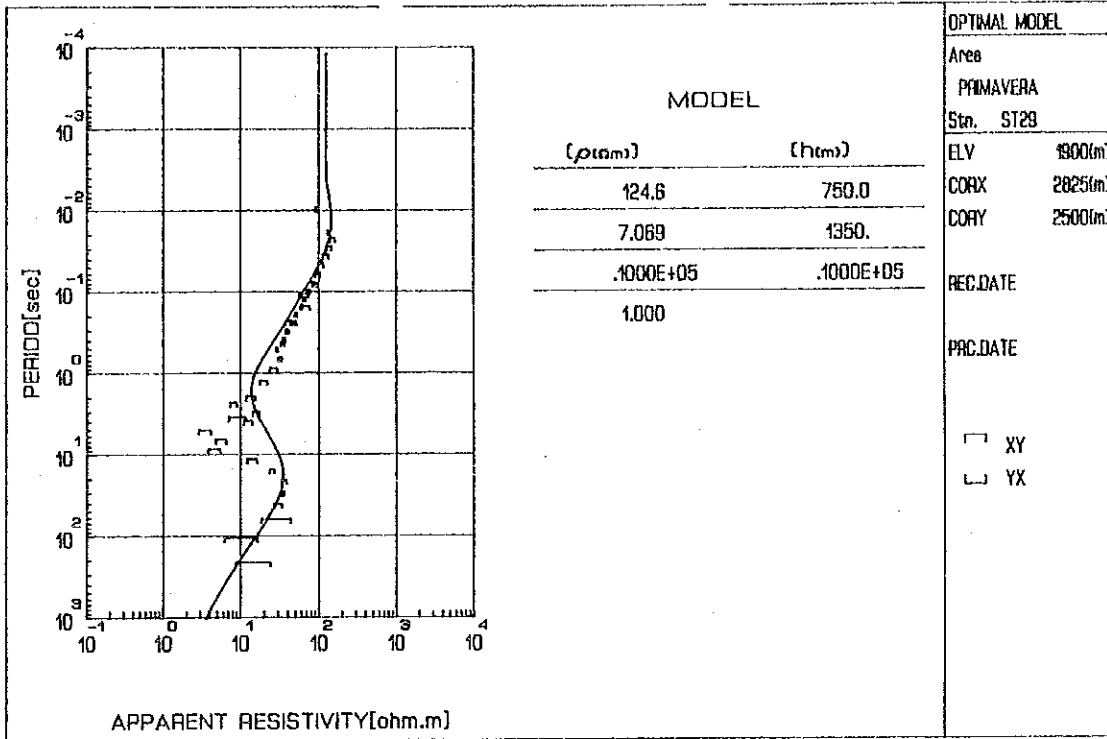

MODEL

$(\rho \text{ (ohm.m)})$	$(h \text{ (m)})$
124.6	750.0
7.069	1350.
.1000E+05	.1000E+05
1.000	

OPTIMAL MODEL

Area	PRIMAVERA
Sta.	ST29
ELV	1900(m)
CORX	2825(m)
CORY	2500(m)
REC.DATE	
PRC.DATE	
<input type="checkbox"/>	XY
<input type="checkbox"/>	YX

Sta. ST29

May 12 1986

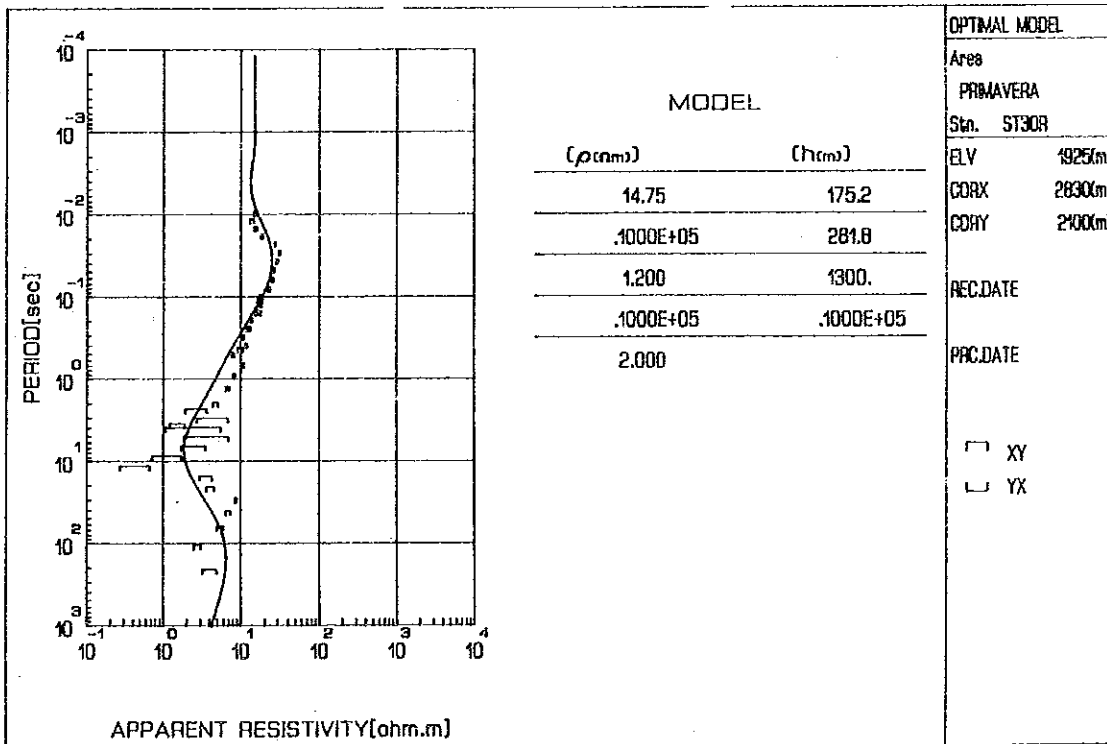

MODEL

$(\rho \text{ (ohm.m)})$	$(h \text{ (m)})$
14.75	175.2
.1000E+05	281.8
1.200	1300.
.1000E+05	.1000E+05
2.000	

OPTIMAL MODEL

Area	PRIMAVERA
Sta.	ST30R
ELV	1925(m)
CORX	2830(m)
CORY	2400(m)
REC.DATE	
PRC.DATE	
<input type="checkbox"/>	XY
<input type="checkbox"/>	YX

Sta. ST30

May 12 1986

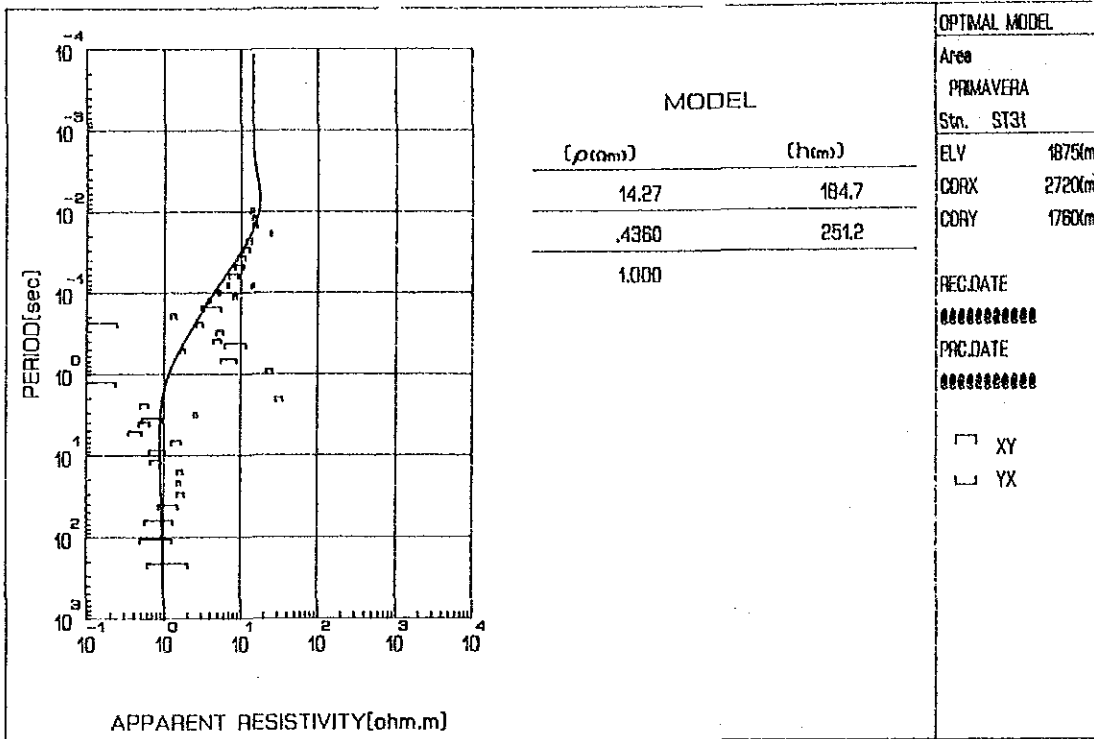

Stn. ST31

May 12 1986

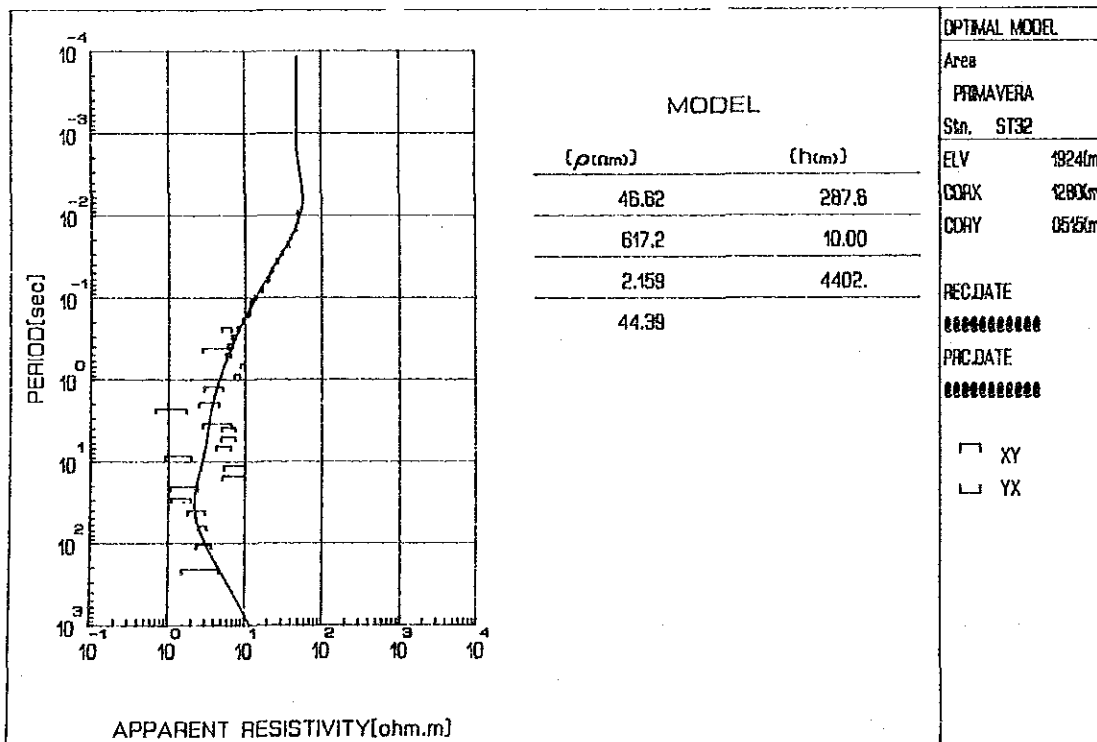

Stn. ST32

May 12 1986

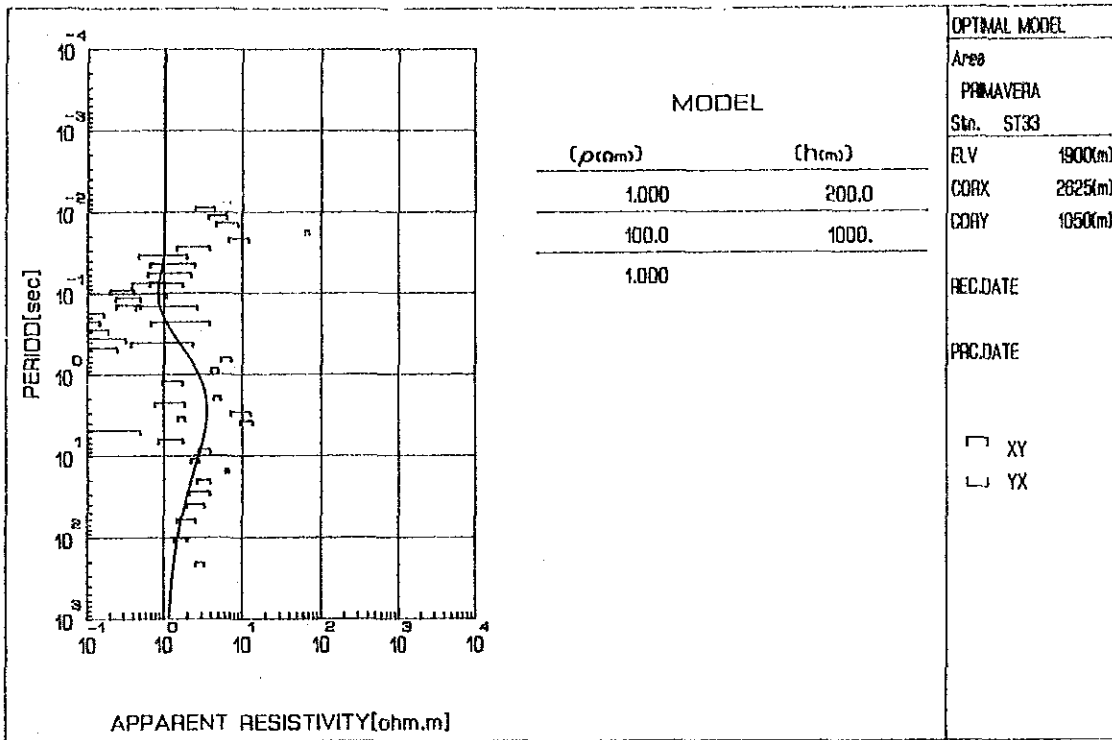

MODEL

$(\rho_{(cm)})$	$(h_{(m)})$
1.000	200.0
100.0	1000.
1.000	

OPTIMAL MODEL

Area	PRIMAVERA
Stn.	ST33
ELV	1900(m)
CORX	2825(m)
CORY	1050(m)
REC.DATE	
PRC.DATE	
<input type="checkbox"/>	XY
<input type="checkbox"/>	YX

Sta. ST33

May 12 1986

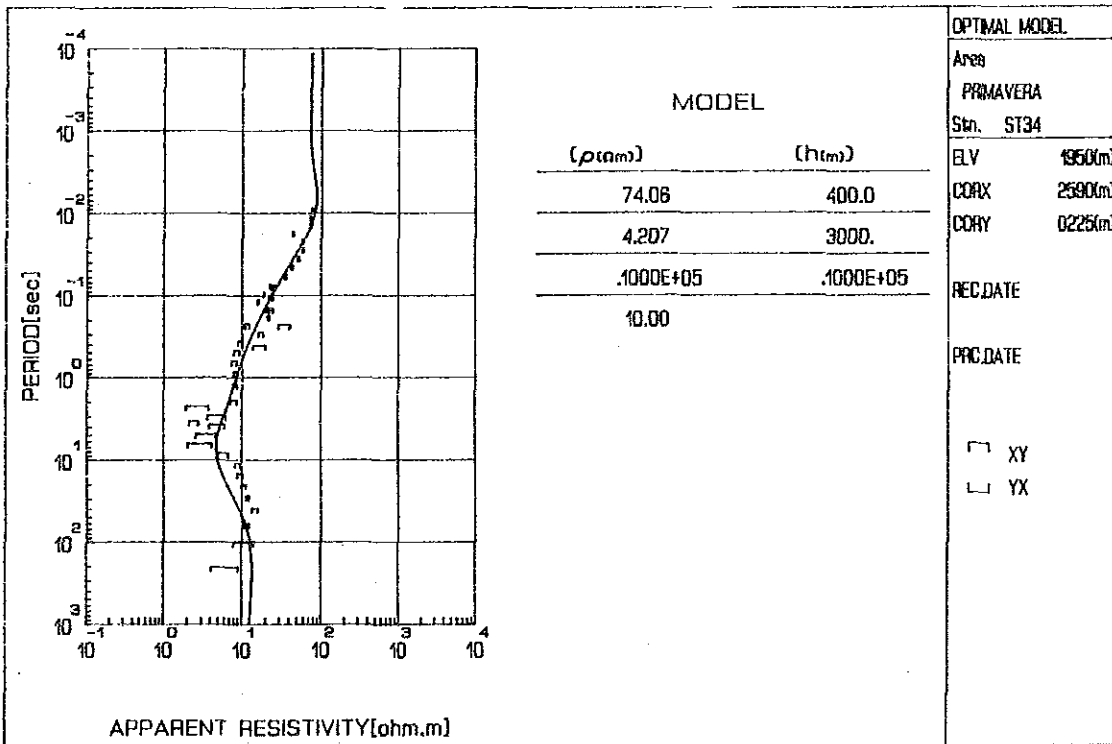

MODEL

$(\rho_{(cm)})$	$(h_{(m)})$
74.08	400.0
4.207	3000.
.1000E+05	.1000E+05
10.00	

OPTIMAL MODEL

Area	PRIMAVERA
Stn.	ST34
ELV	1950(m)
CORX	2590(m)
CORY	0225(m)
REC.DATE	
PRC.DATE	
<input type="checkbox"/>	XY
<input type="checkbox"/>	YX

Sta. ST34

May 12 1986

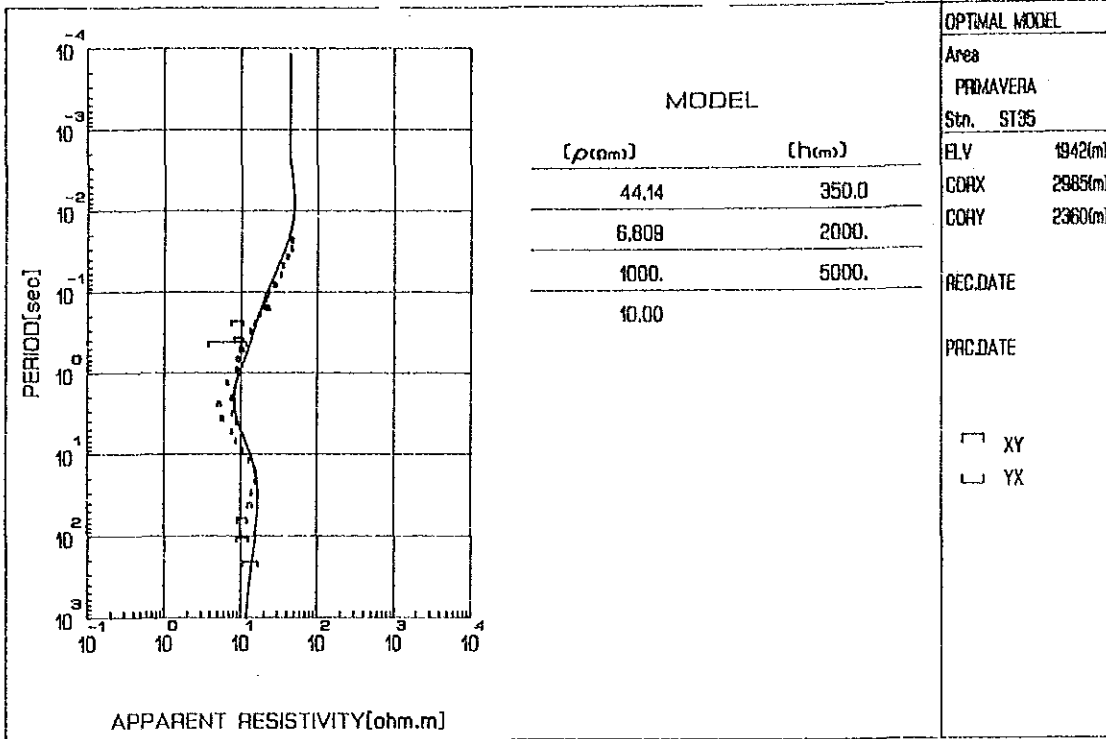

Sta. ST35

May 12 1986

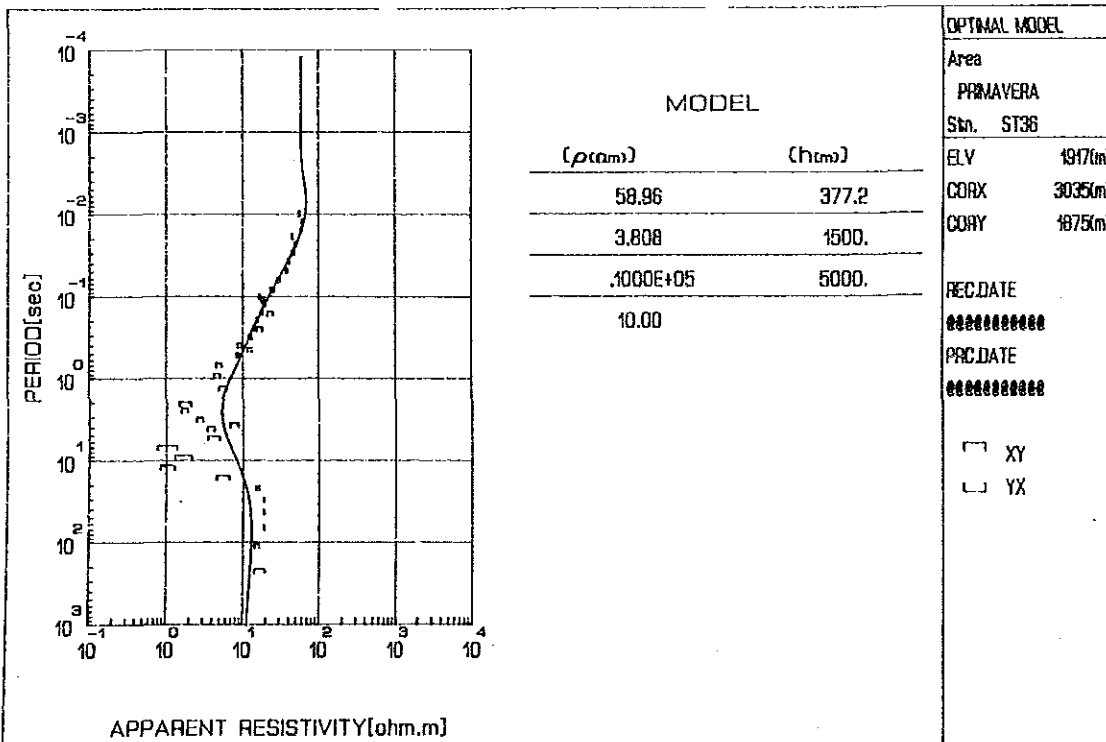

Sta. ST36

May 12 1986

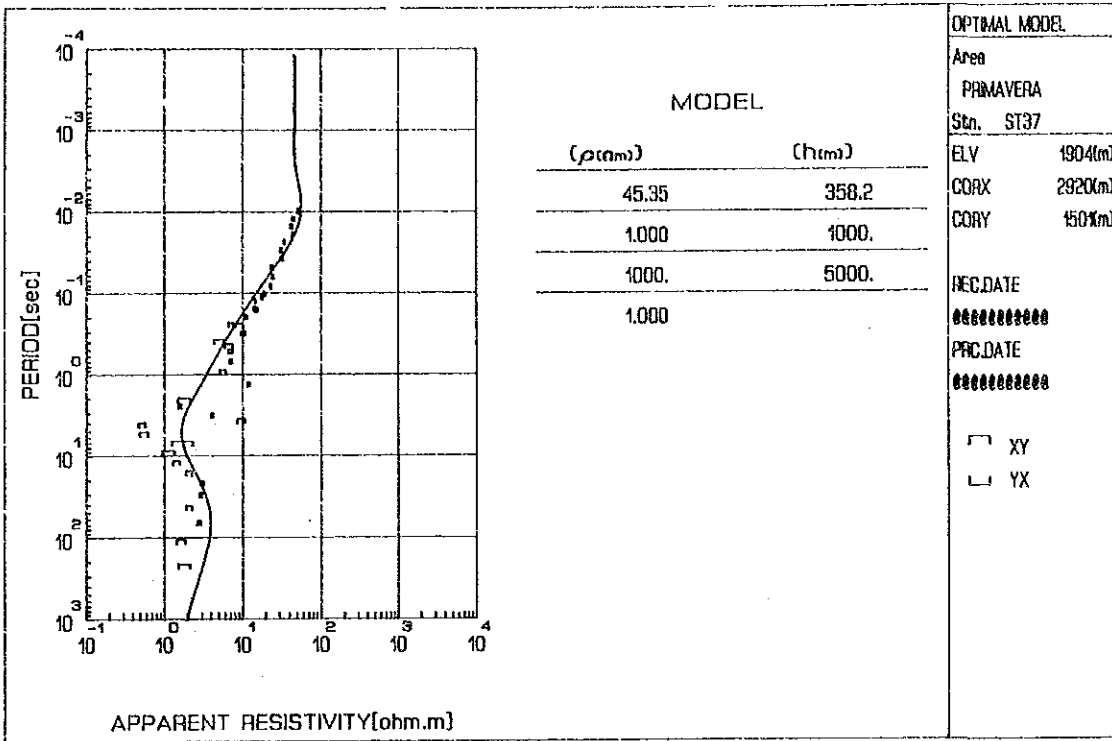

Stn. ST37

May 12 1986

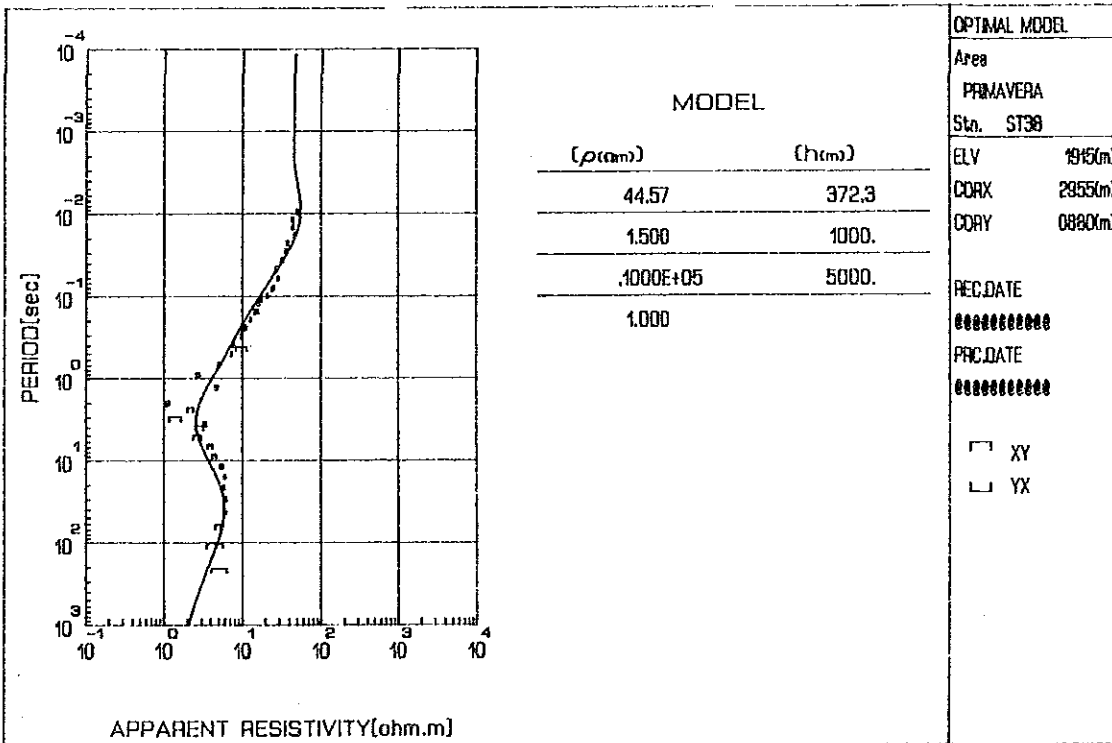

Stn. ST38

May 12 1986

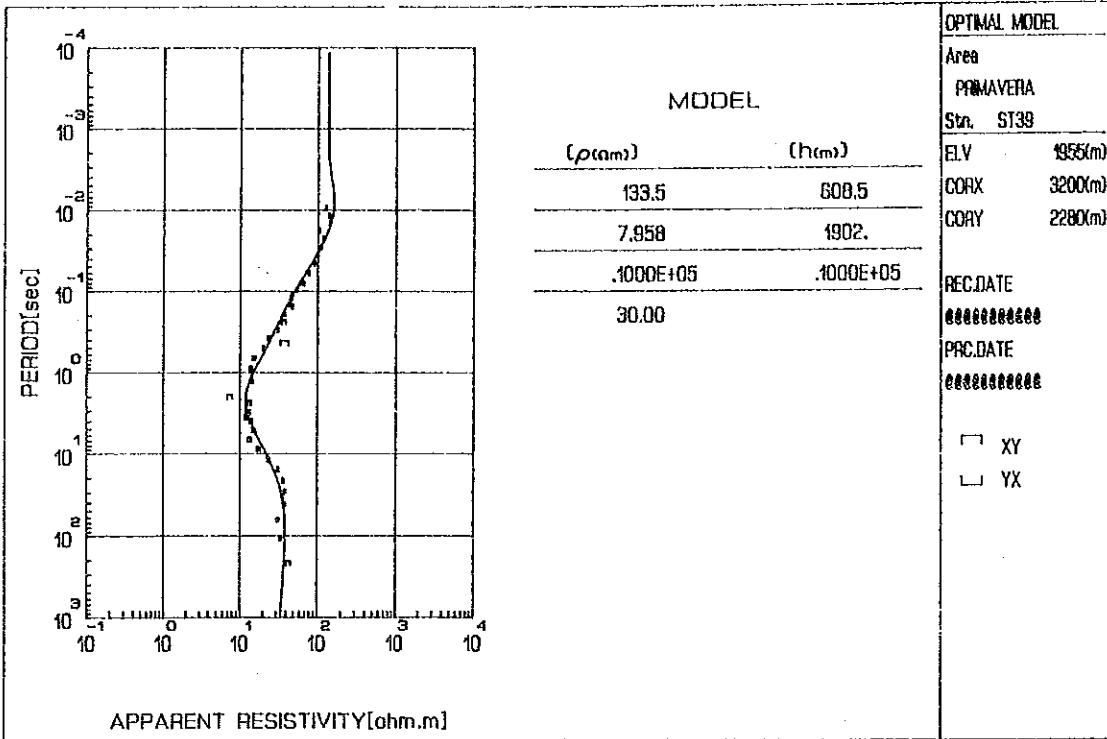

Sta. ST39

May 12 1986

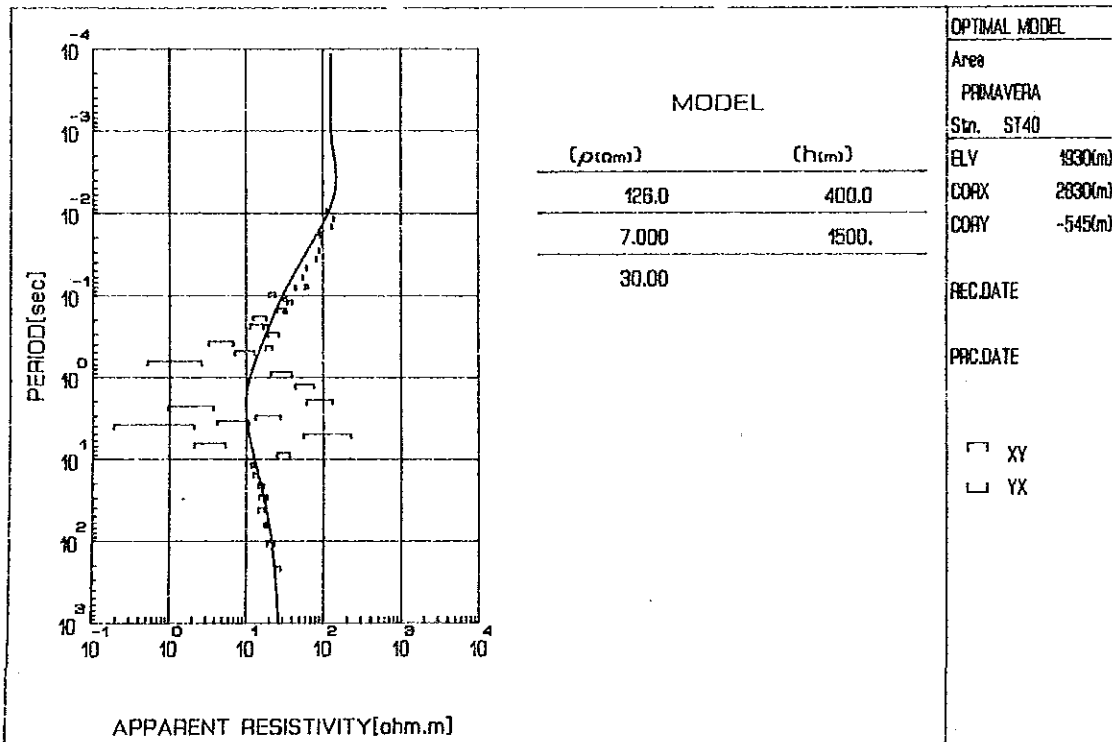

Sta. ST40

May 12 1986



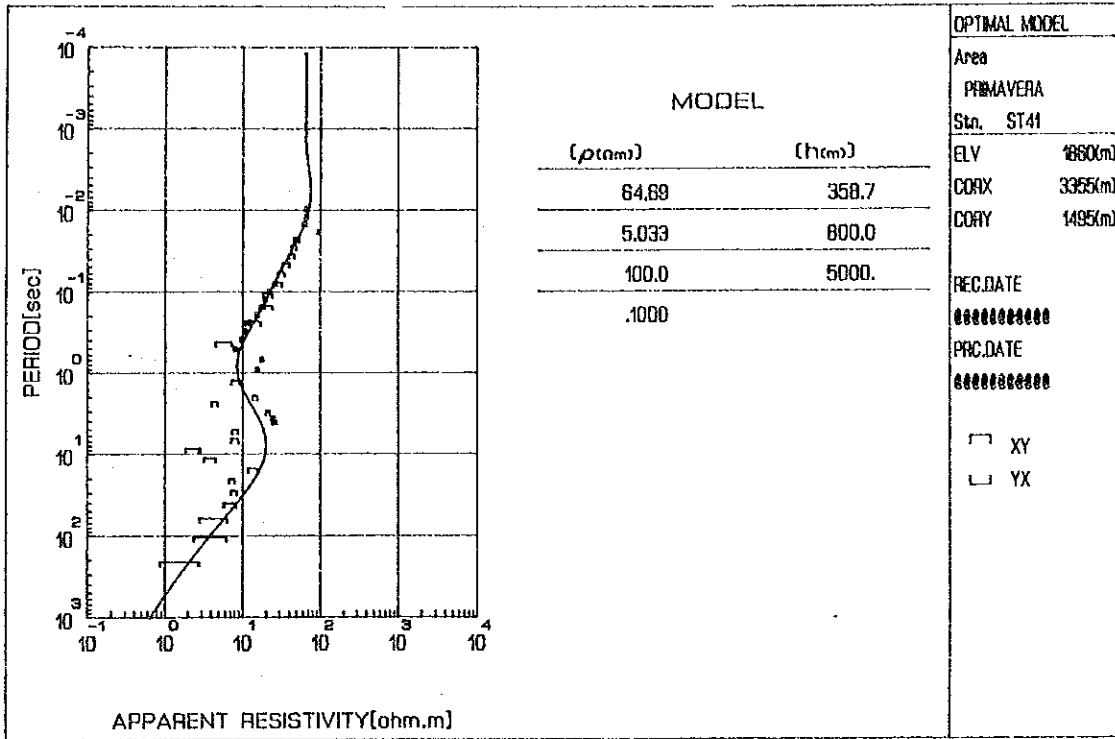

Stn. ST41

May 12 1986

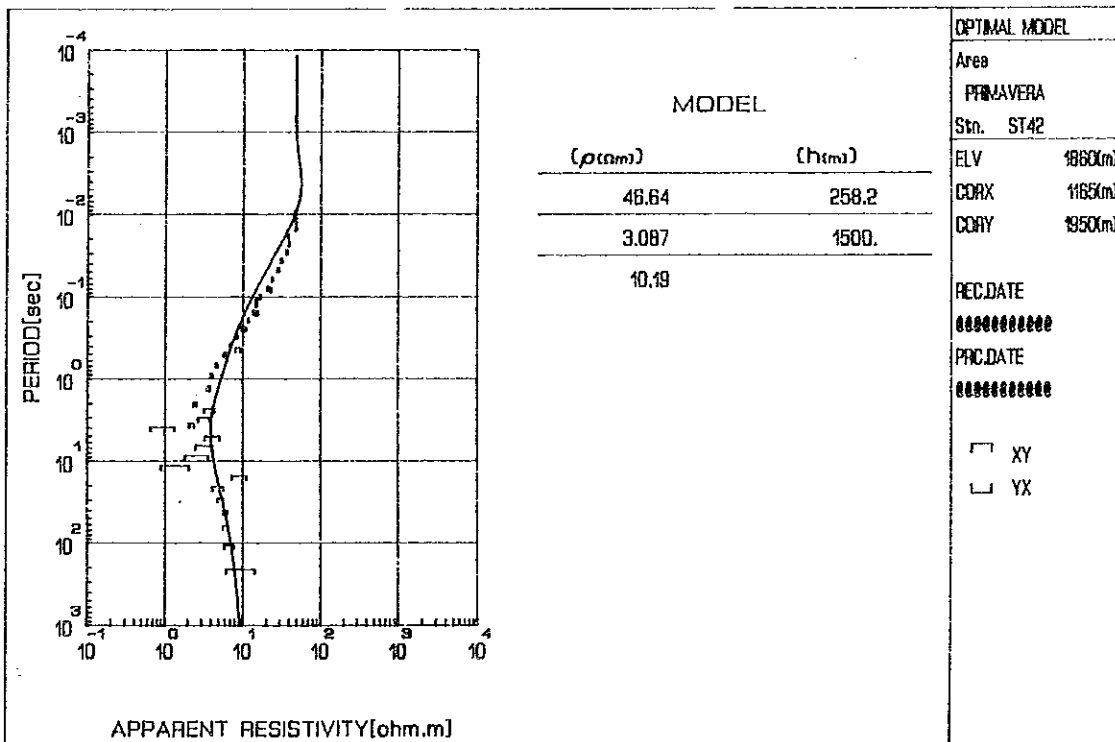

Stn. ST42

May 12 1986

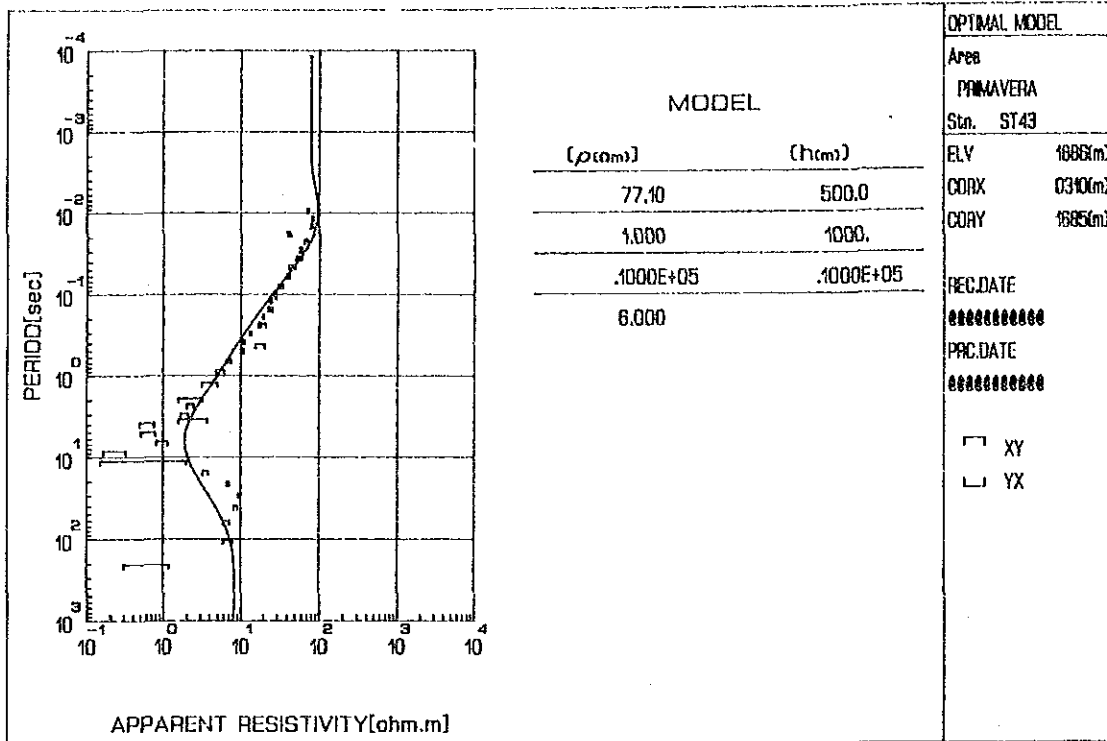

Stn. ST43

May 12 1986

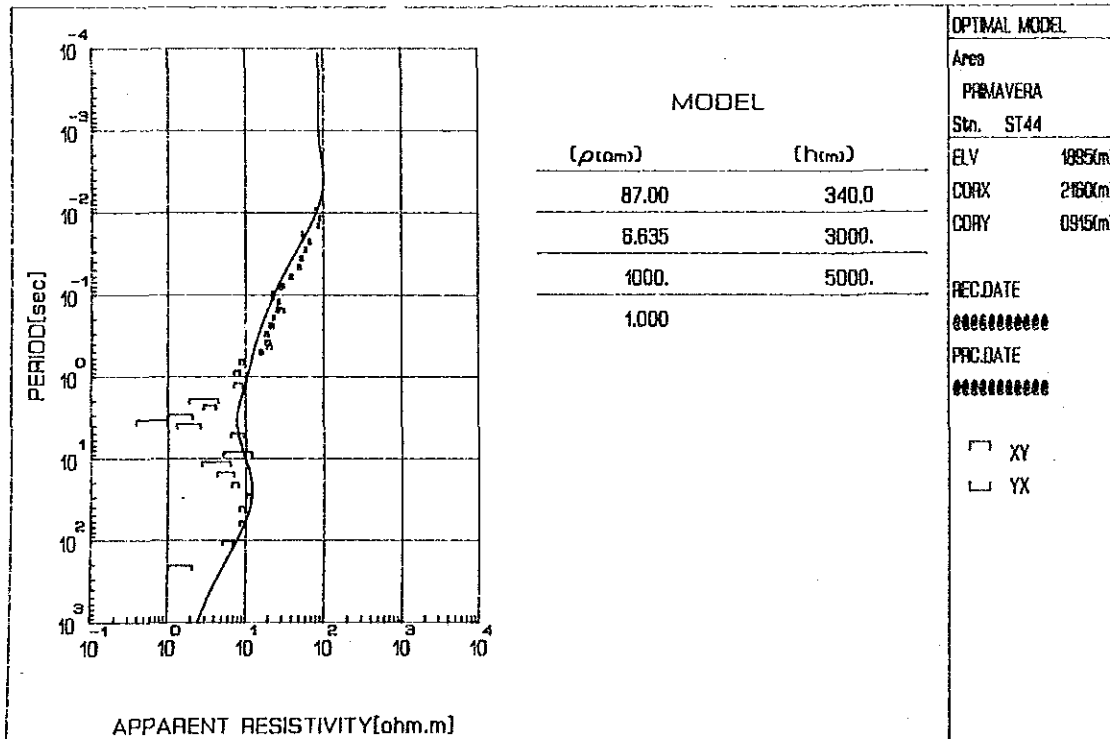

Stn. ST44

May 12 1986

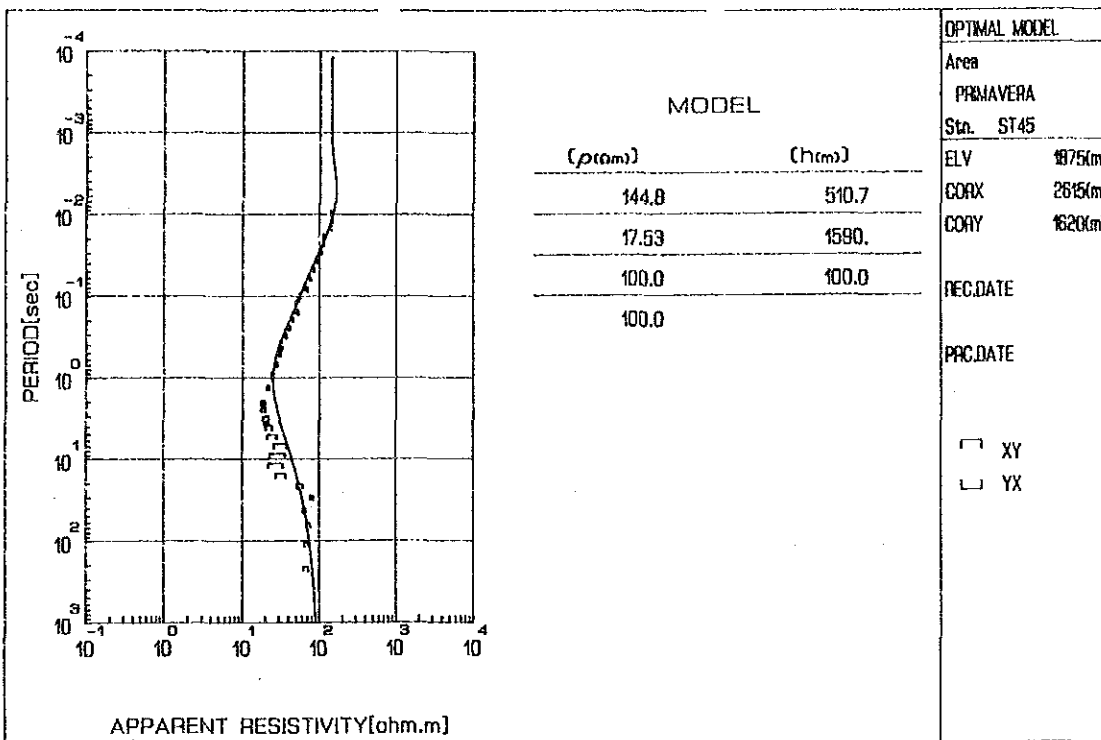

Sta. ST45

May 12 1986

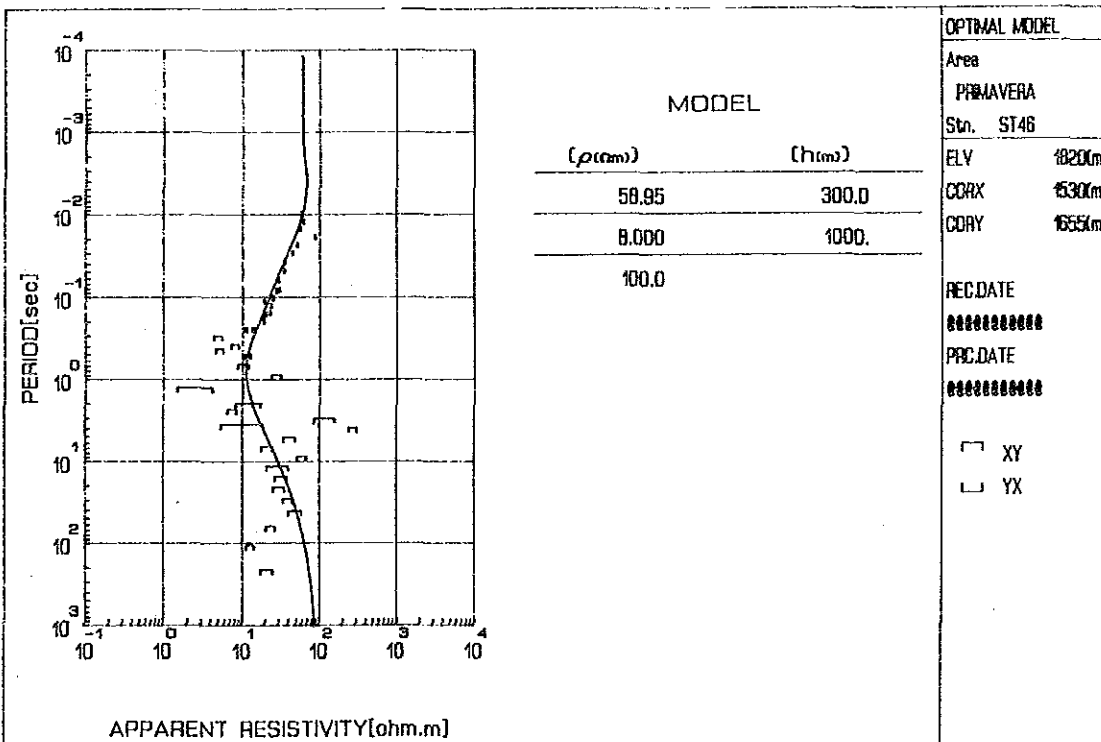

Sta. ST46

May 12 1986

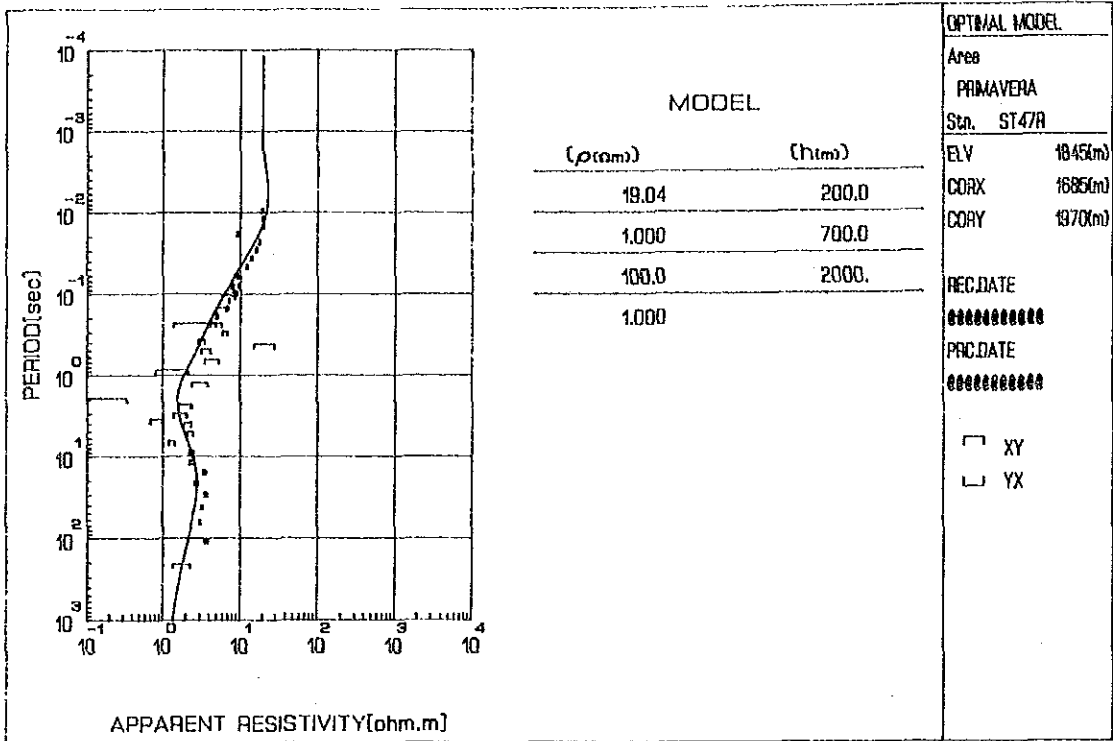

Stn. ST47

May 12 1986

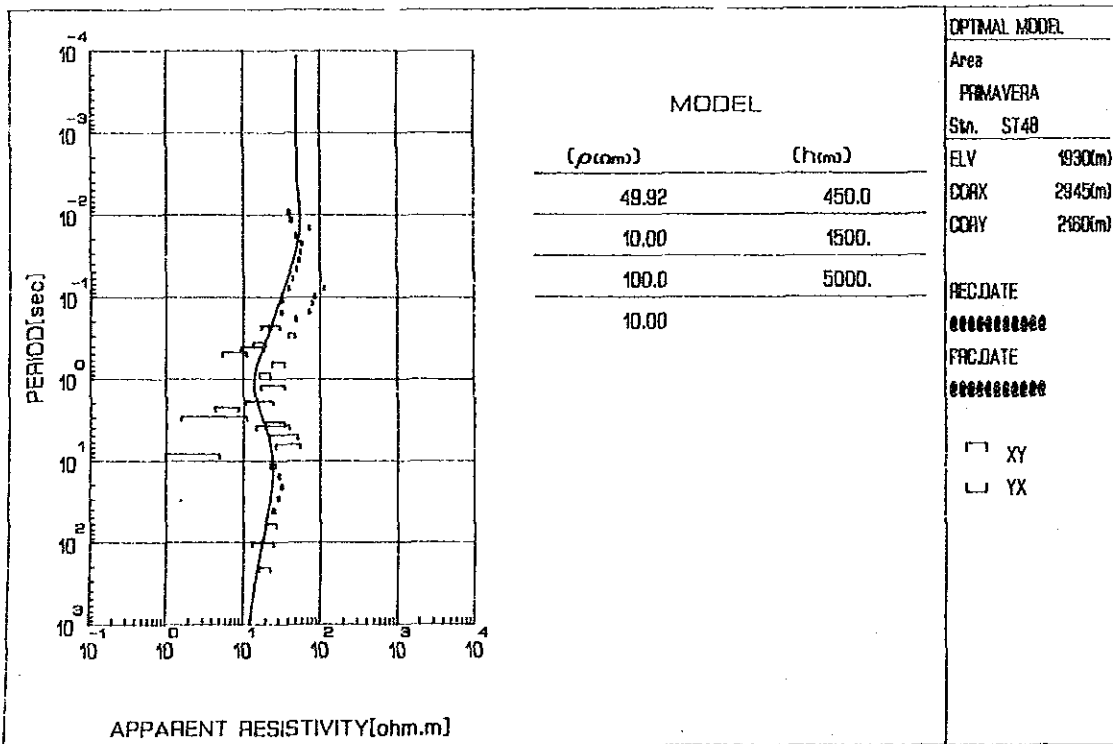

Stn. ST48

May 12 1986

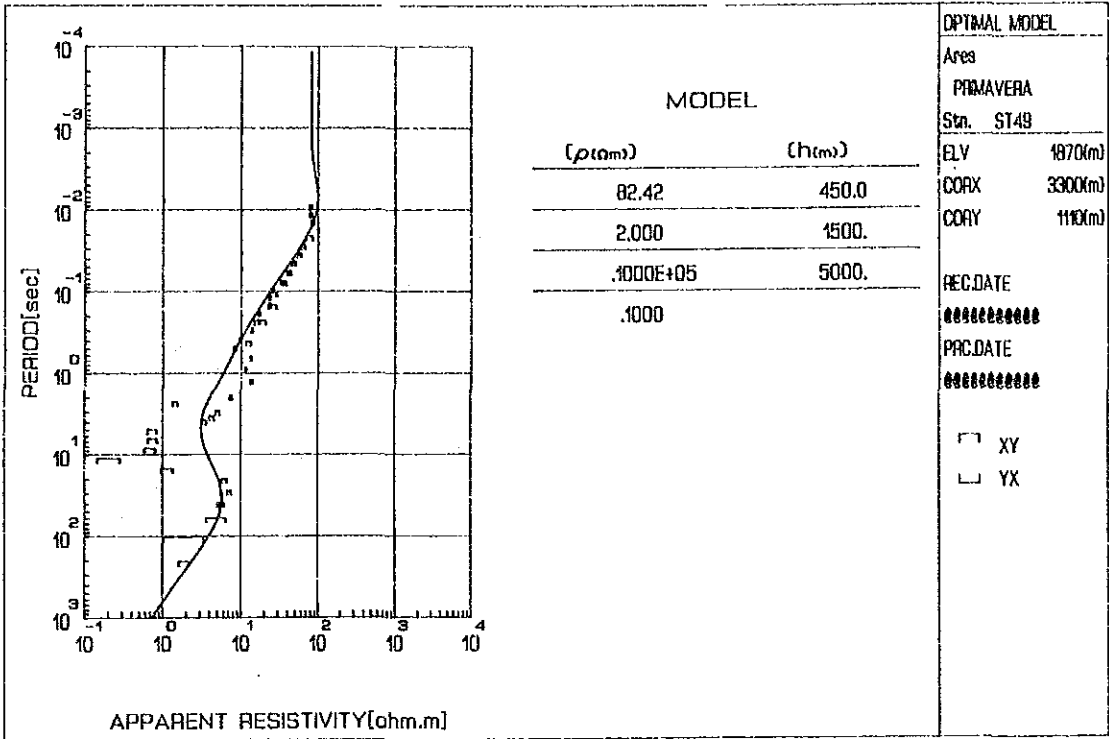

Sta. ST49

May 12 1986

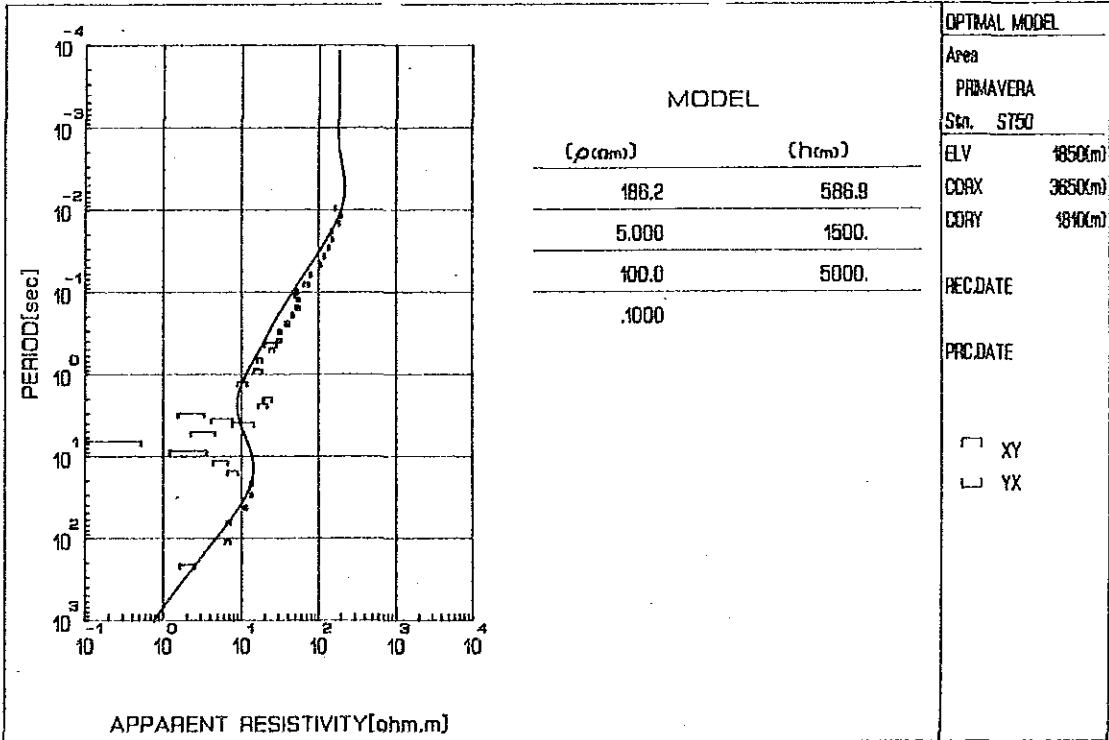

Sta. ST50

May 12 1986

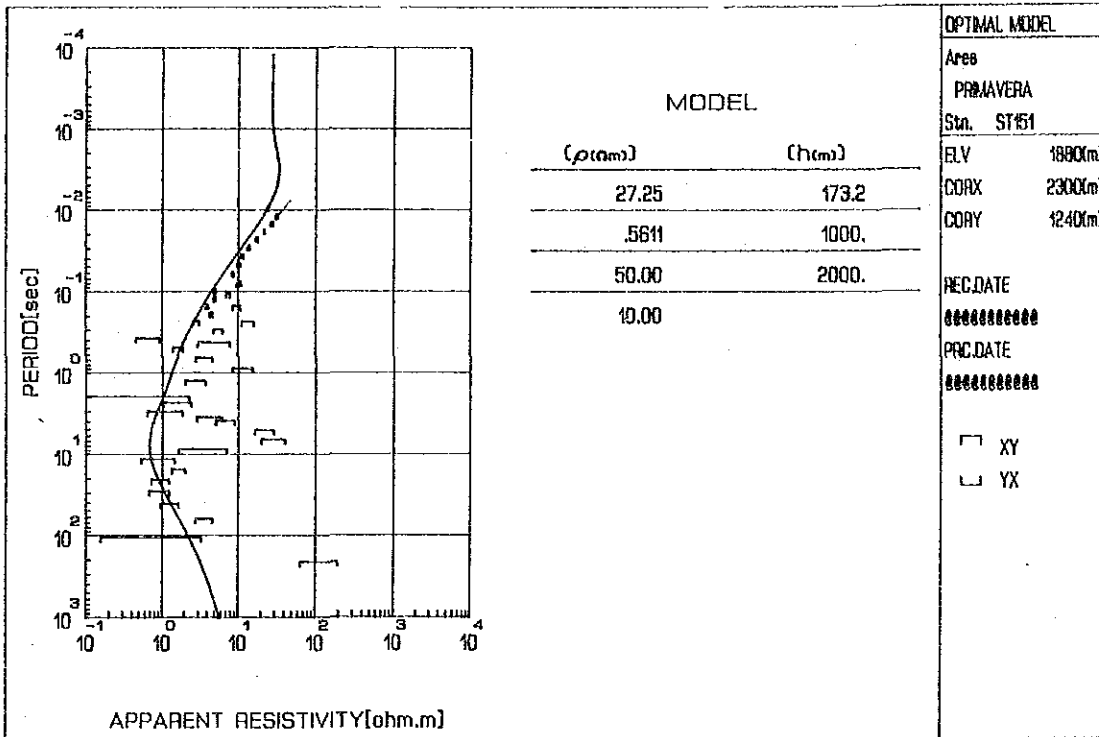

Sta. ST15

May 12 1986

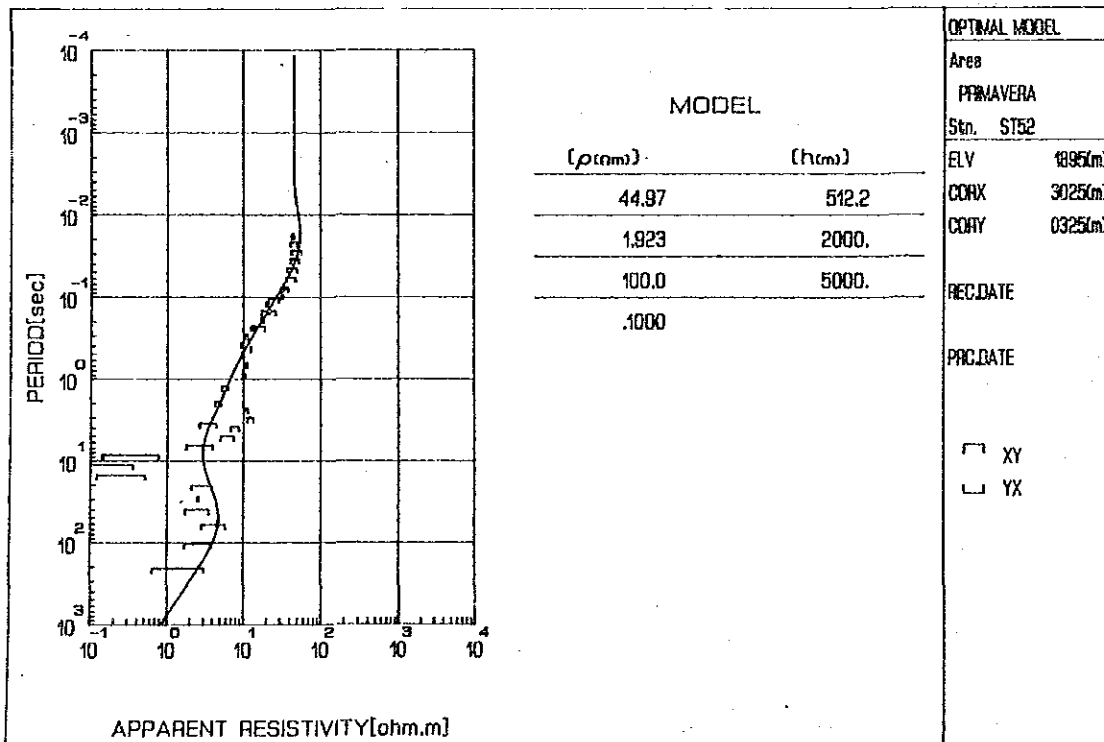

Sta. ST52

May 12 1986

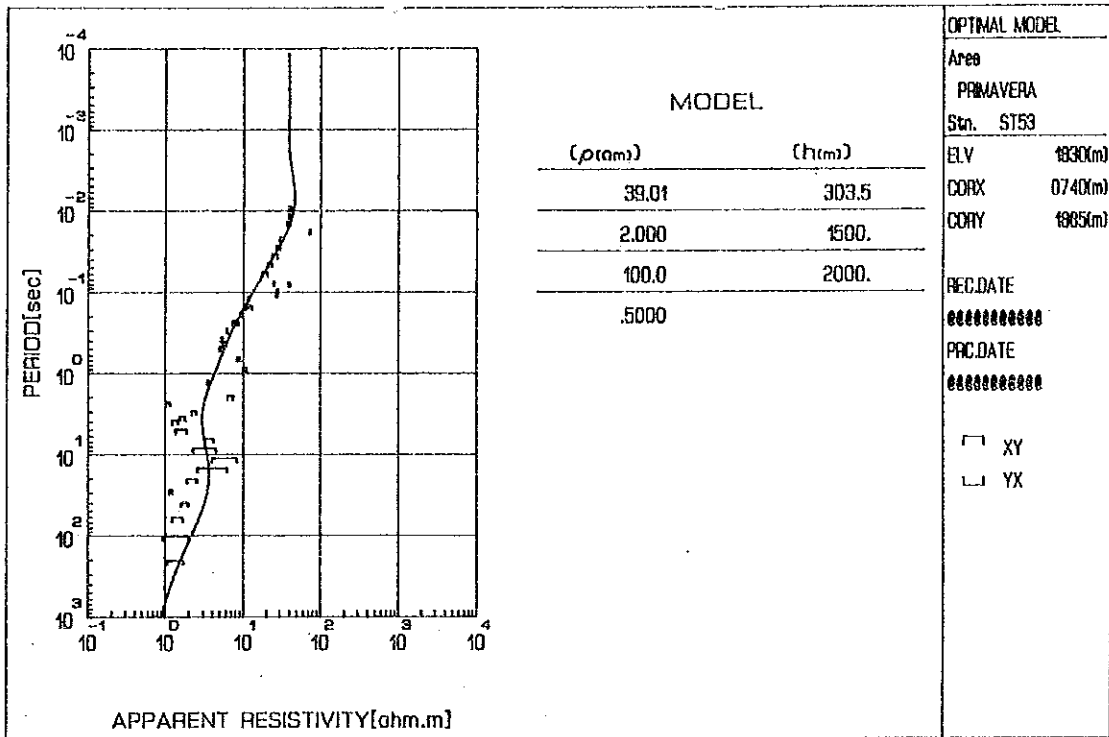

Stn. ST53

May 12 1986

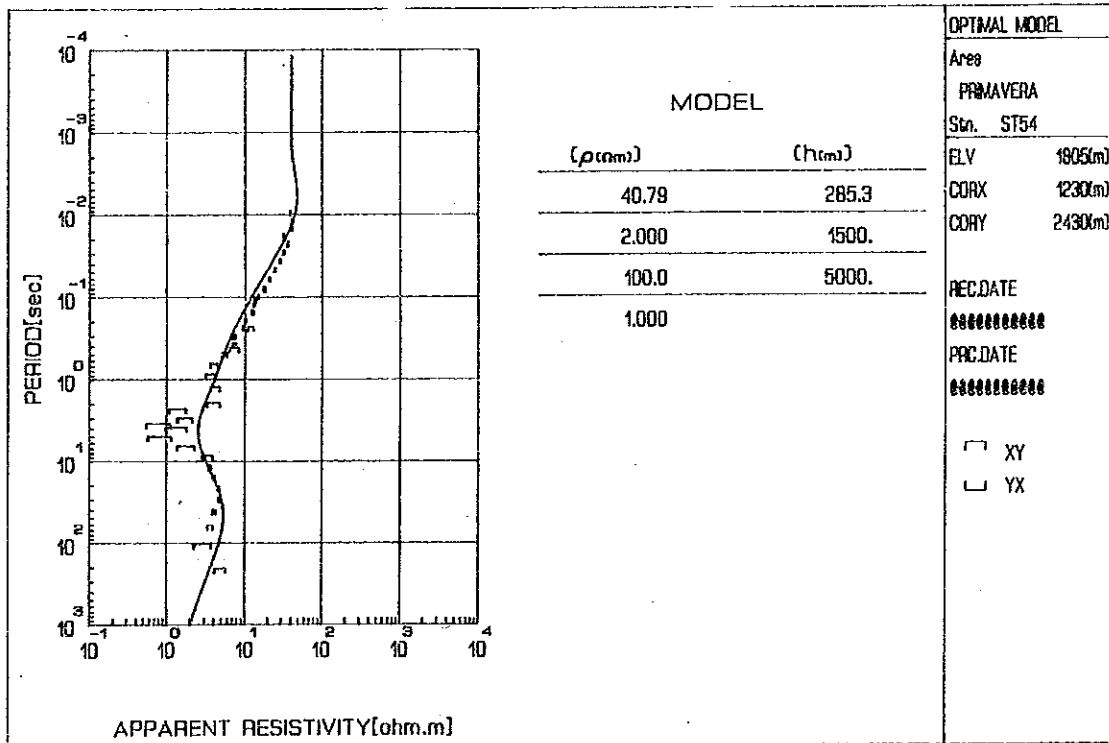

Stn. ST54

May 12 1986





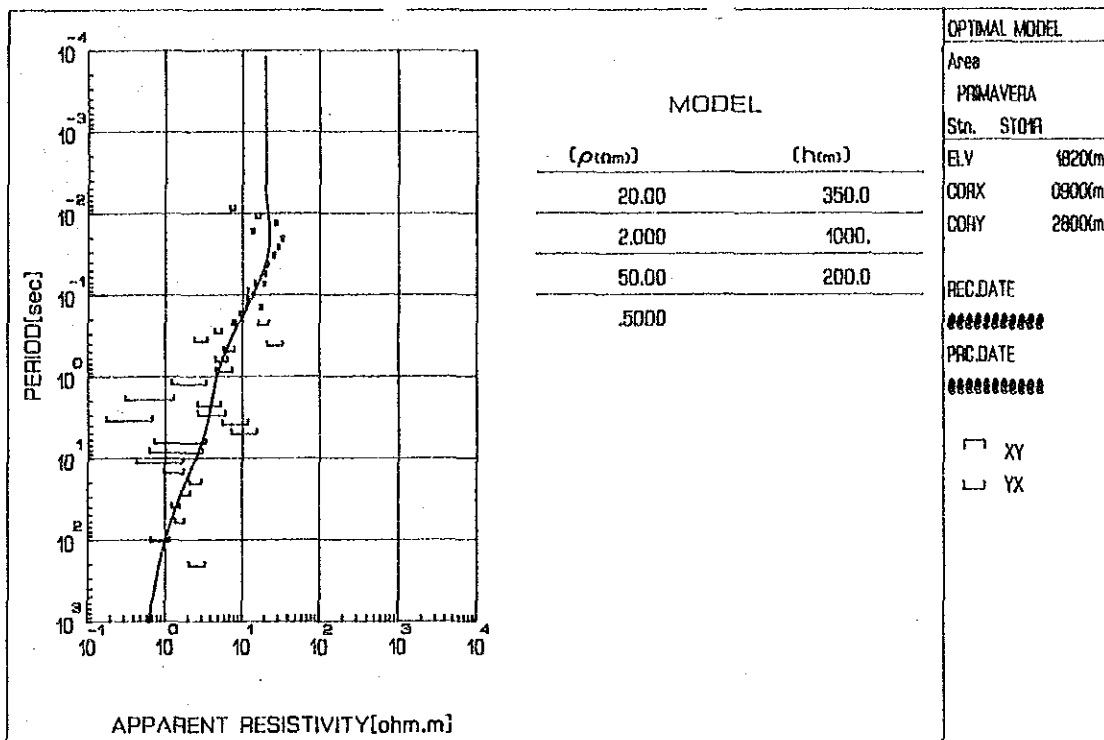

Sta. ST01

May 12 1986

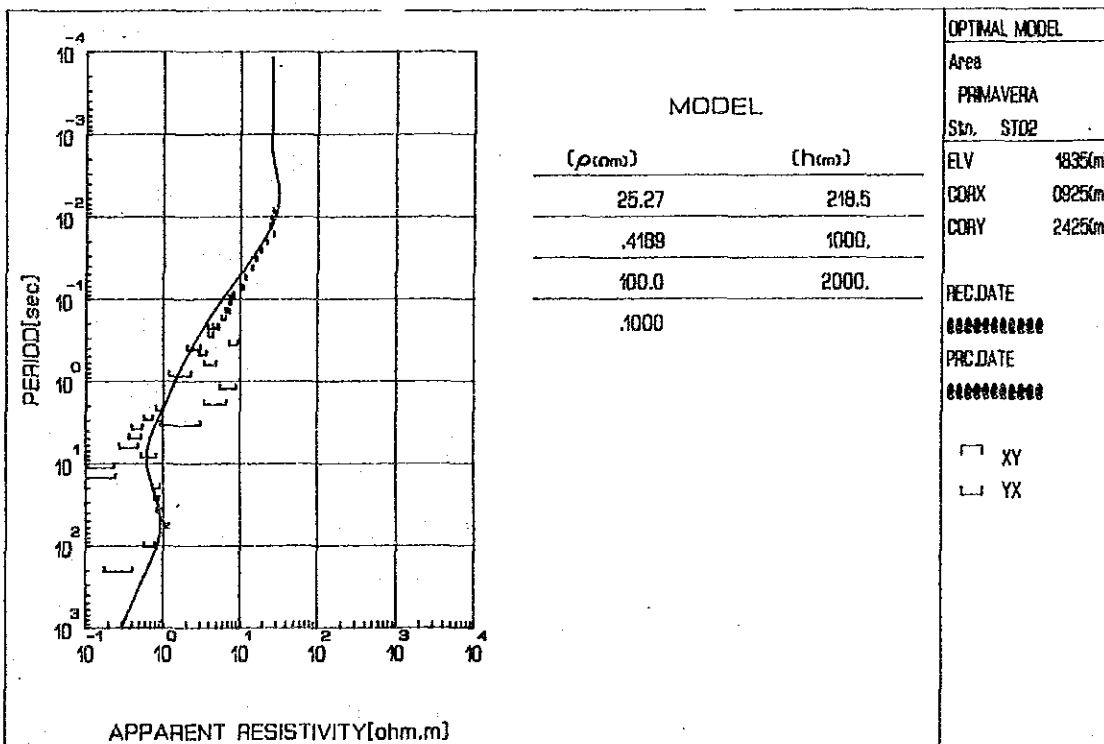

Sta. ST02

May 12 1986

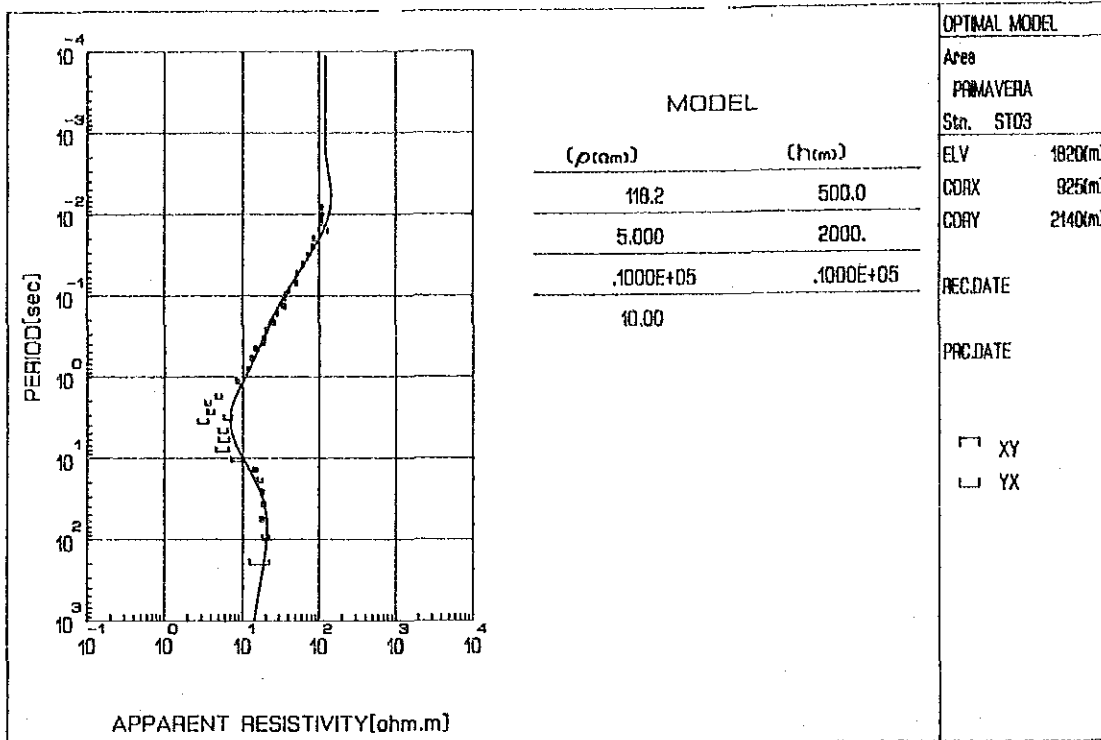

Stn. ST03

May 12 1986

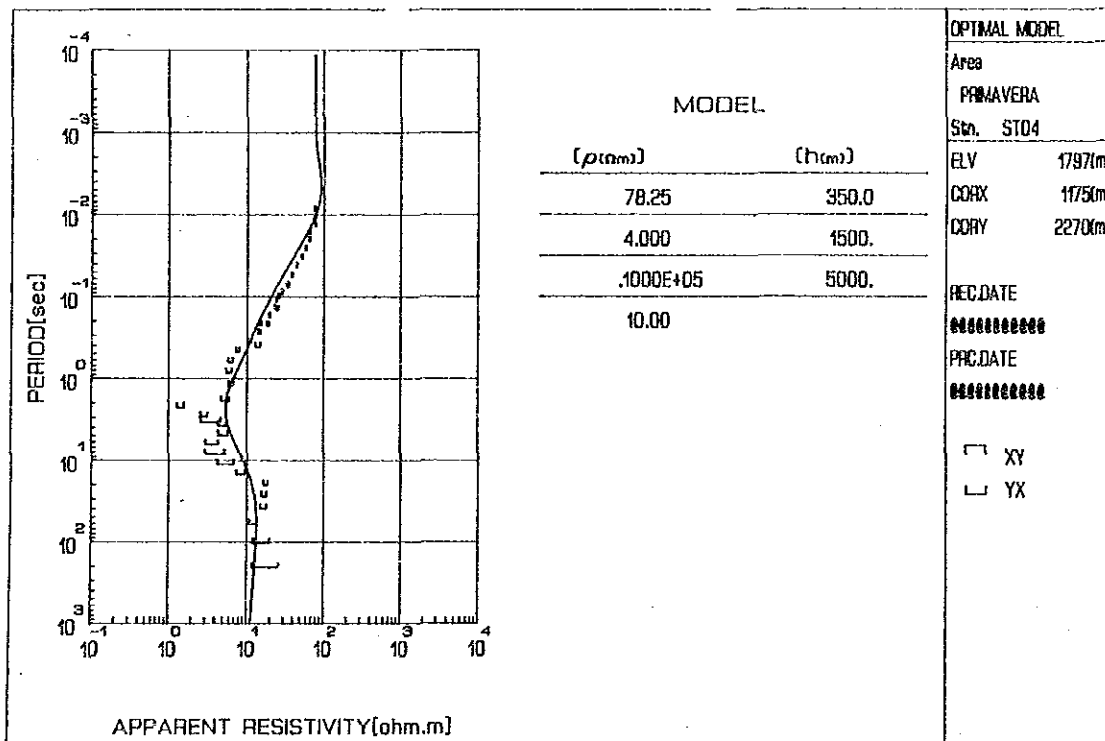

Stn. ST04

May 12 1986

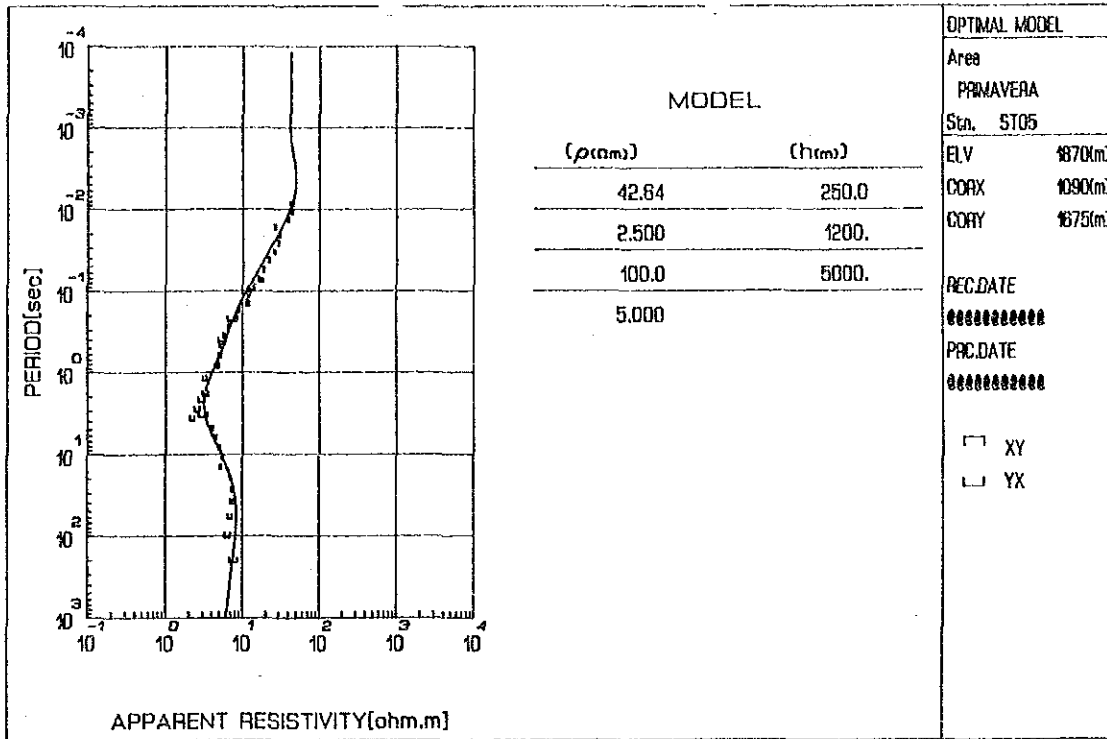

Stn. ST05

May 12 1986

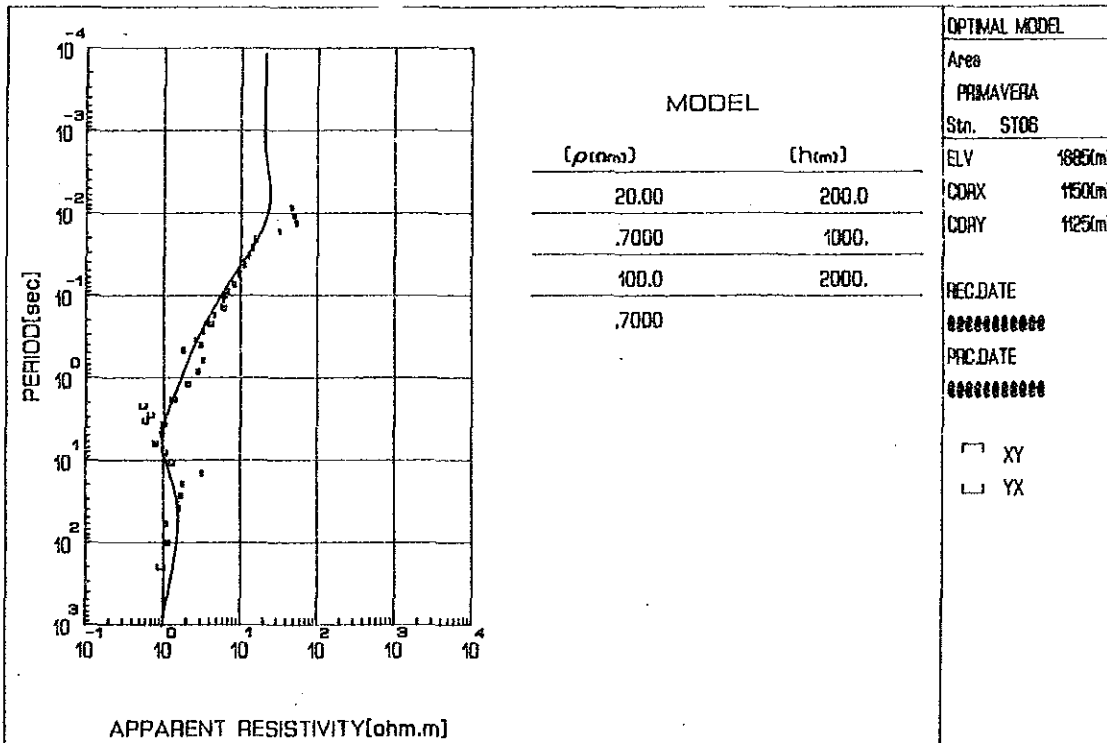

Stn. ST06

May 12 1986

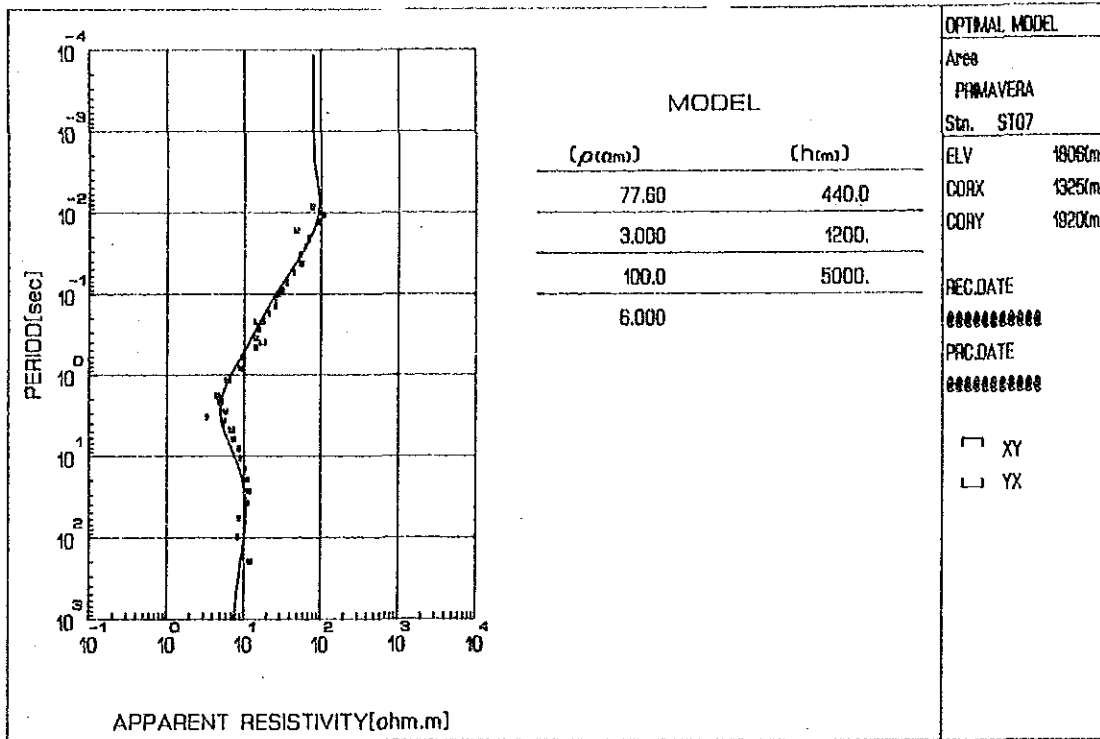

Sta. ST07

May 12 1986

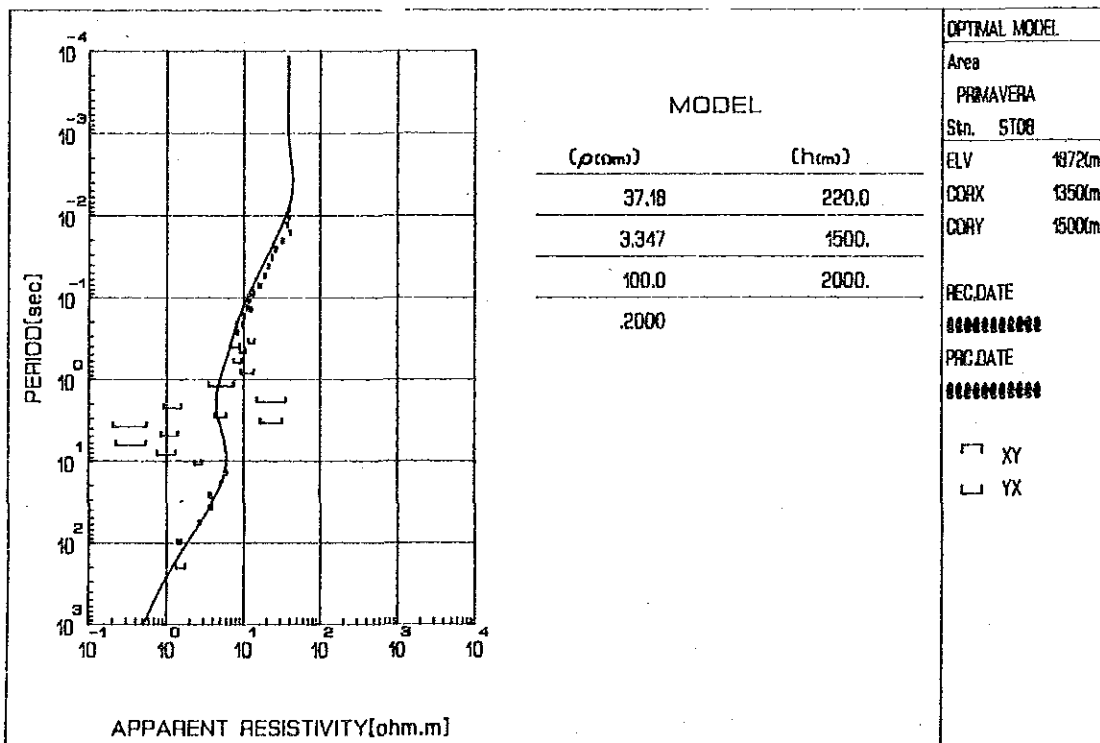

Sta. ST08

May 12 1986

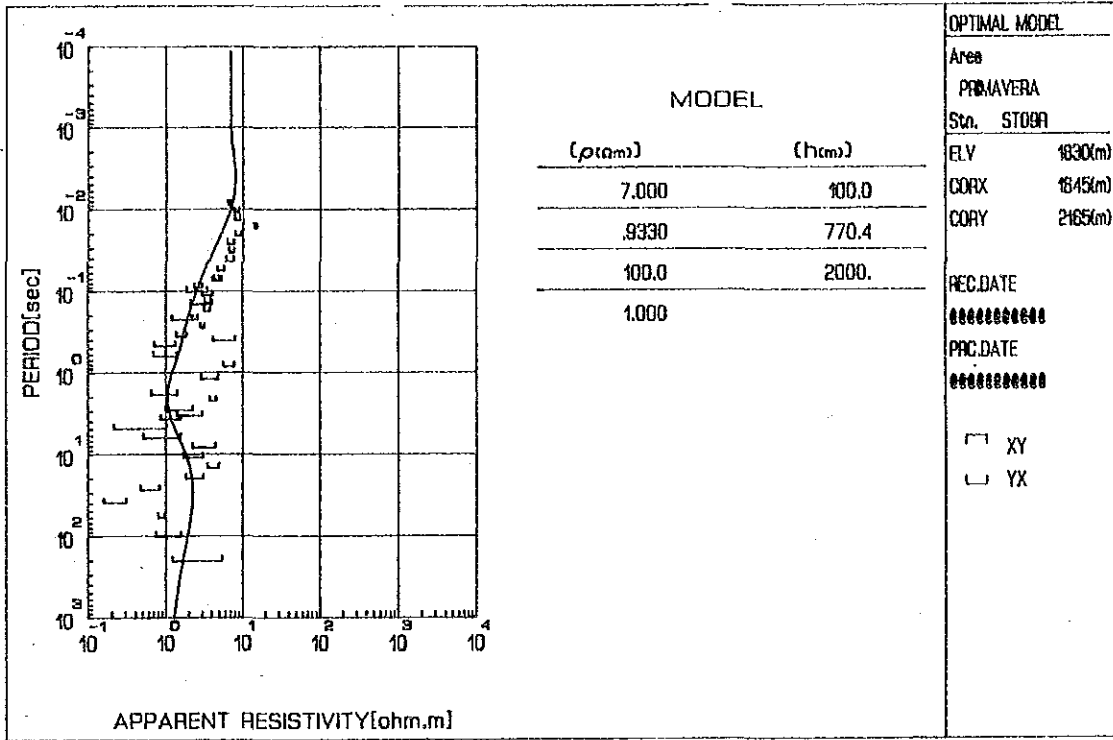

Sta. ST09

May 12 1986

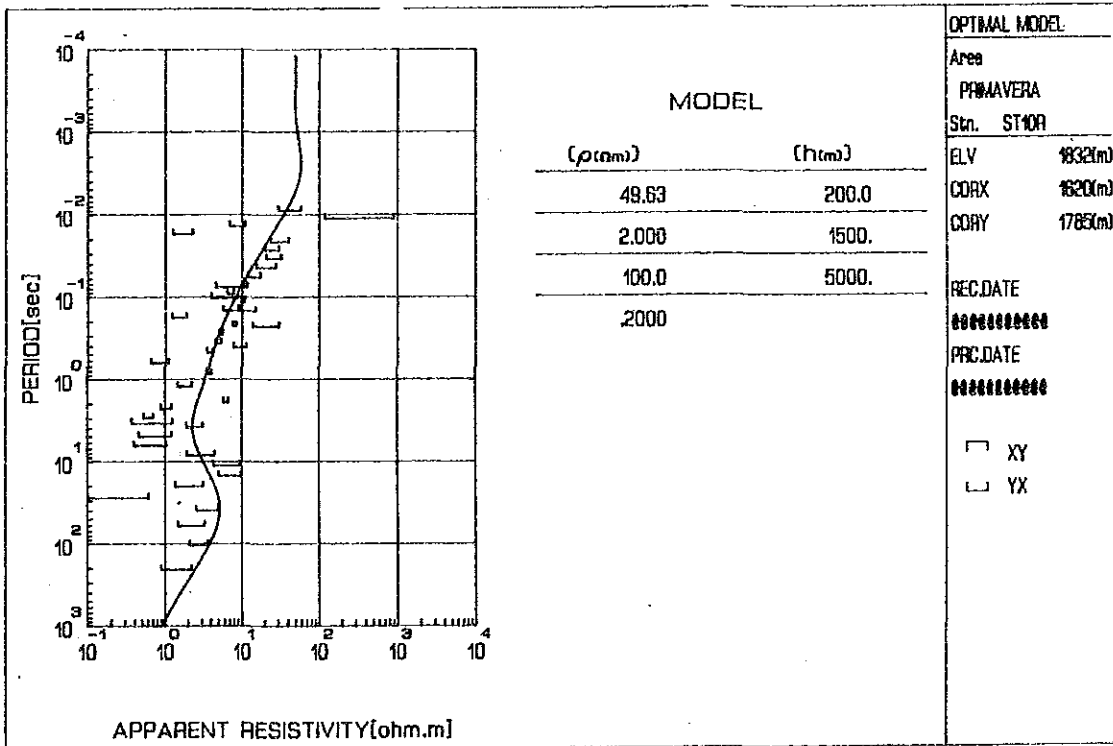

Sta. ST10

May 12 1986

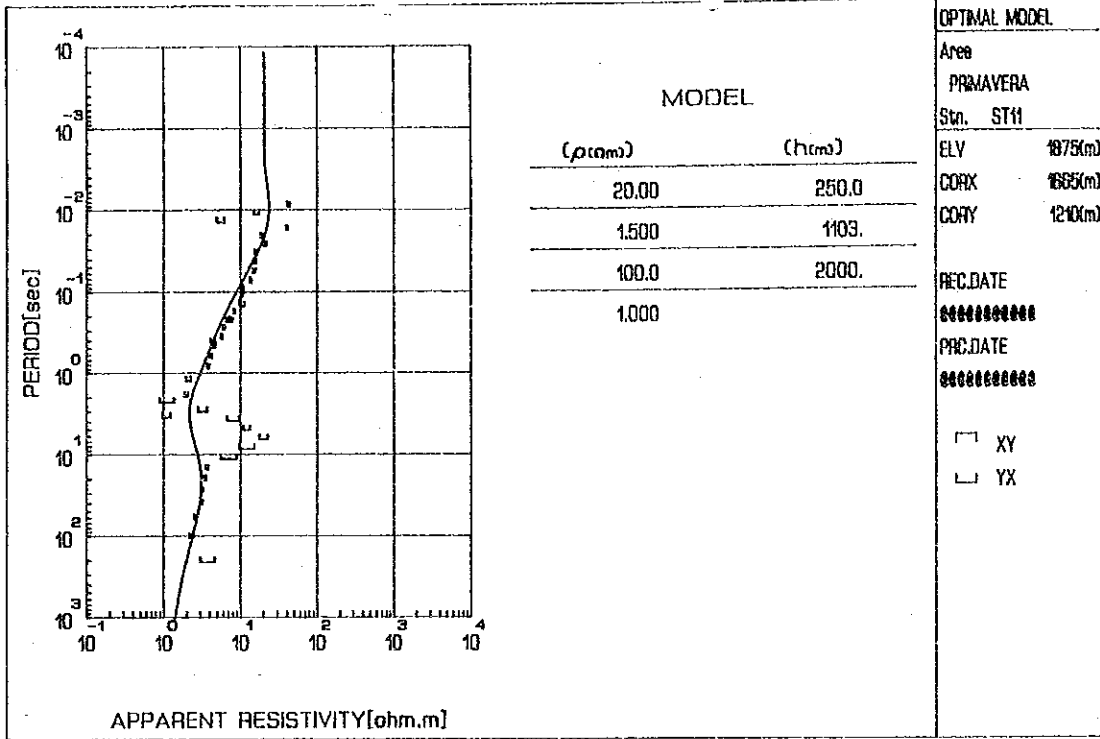

Sta. ST11

May 12 1986

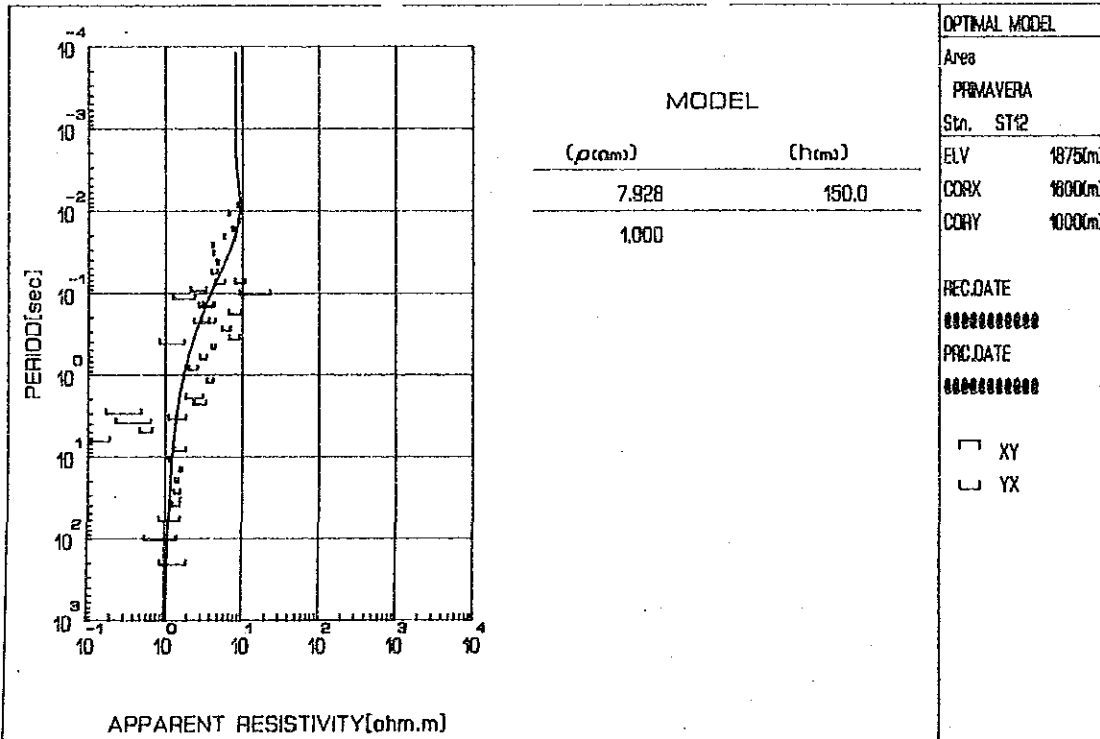

Sta. ST12

May 12 1986

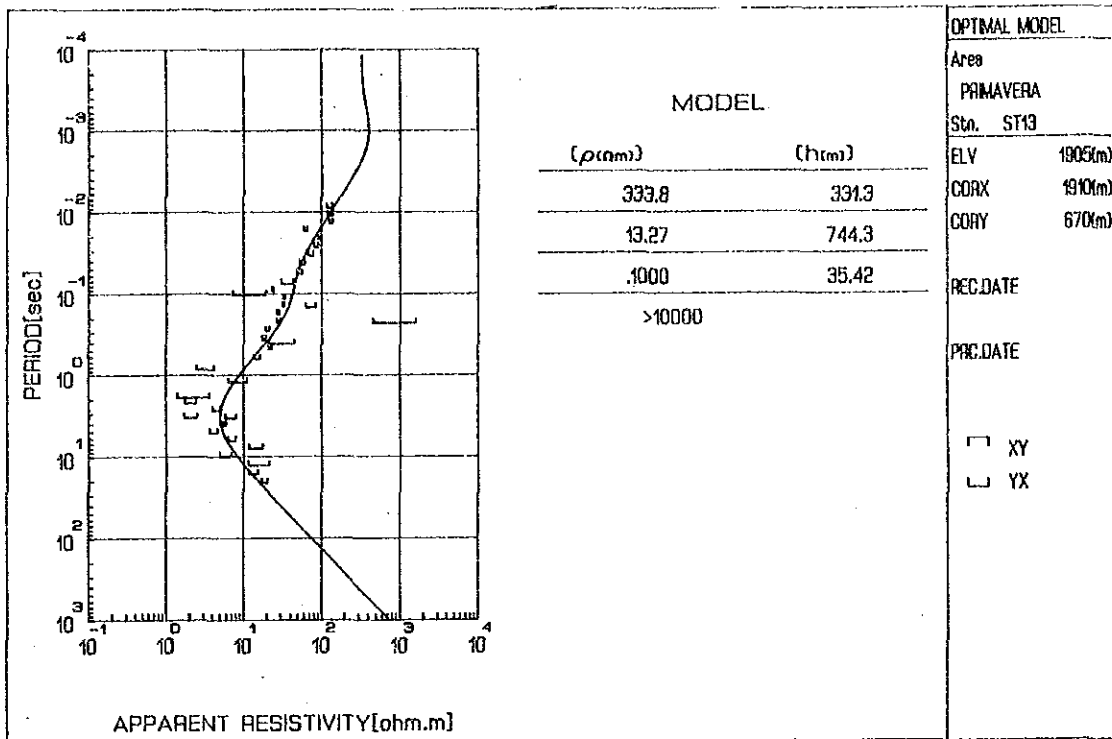

Sta. ST13

May 14 1986

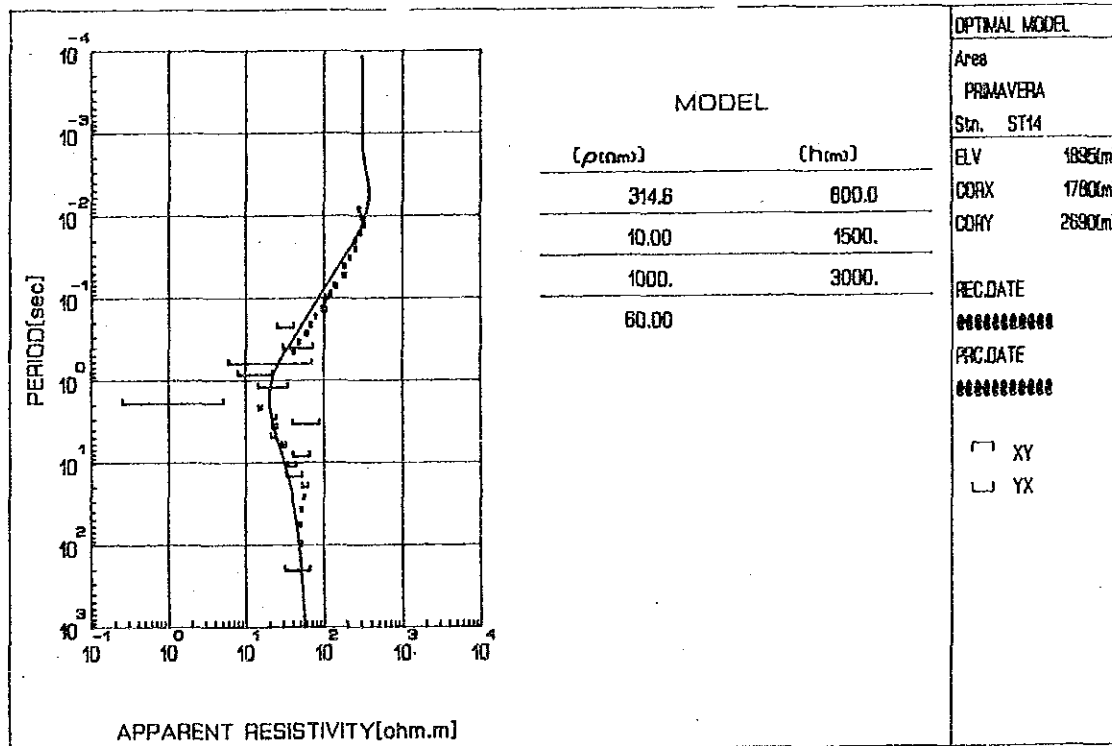

Sta. ST14

May 12 1986

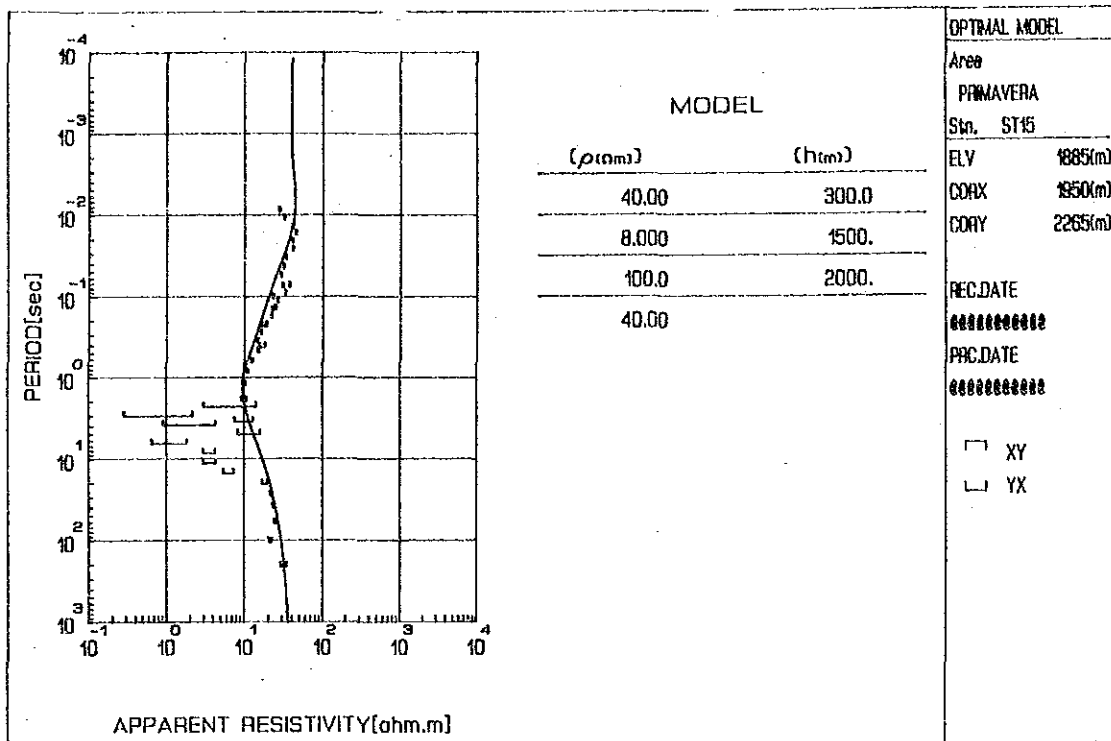

**OPTIMAL MODEL**

Area  
PRIMAVERA

Stn. ST15

ELV 1885(m)

CORX 1950(m)

CORY 2265(m)

REC.DATE  
\*\*\*\*\*

PRC.DATE  
\*\*\*\*\*

XY

YX

Stn. ST15

May 12 1986

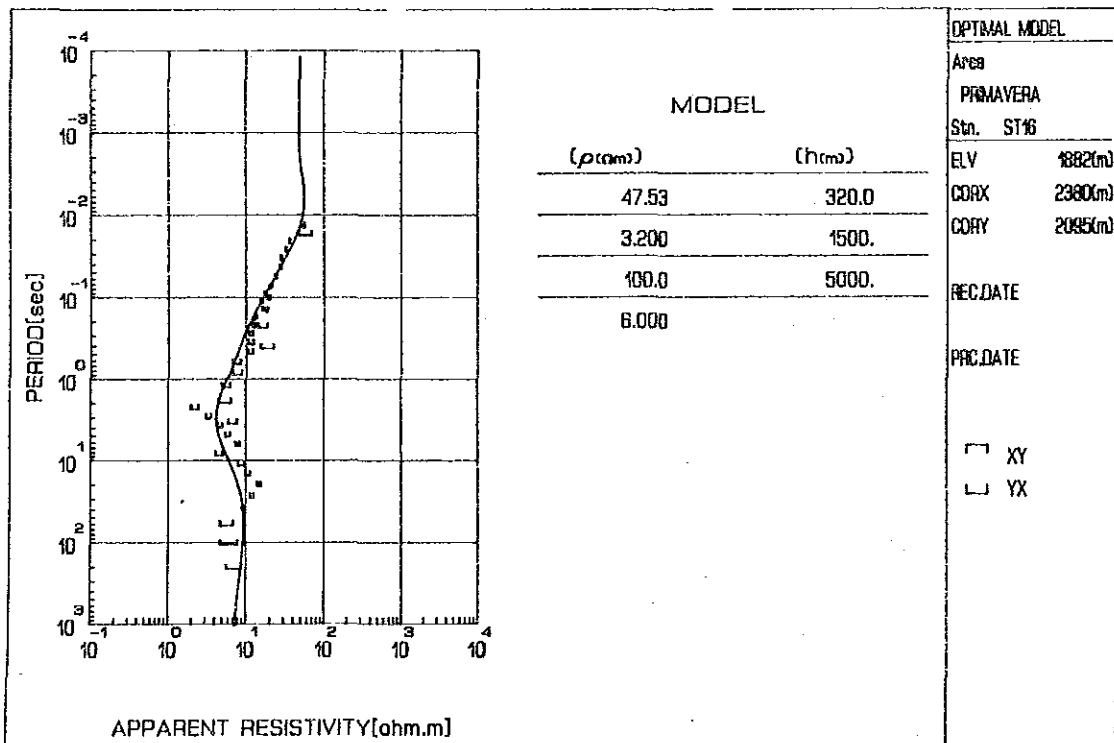

**OPTIMAL MODEL**

Area  
PRIMAVERA

Stn. ST16

ELV 1882(m)

CORX 2360(m)

CORY 2095(m)

REC.DATE

PRC.DATE

XY

YX

Stn. ST16

May 12 1986



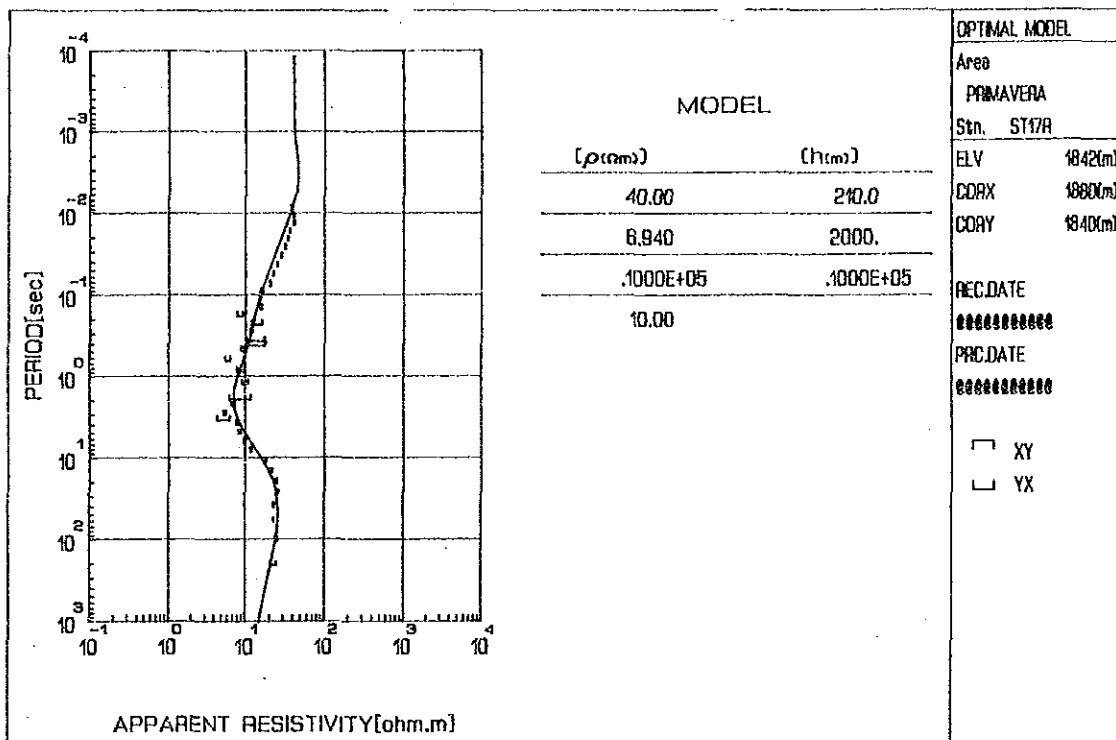

Sta. ST17

May 12 1986

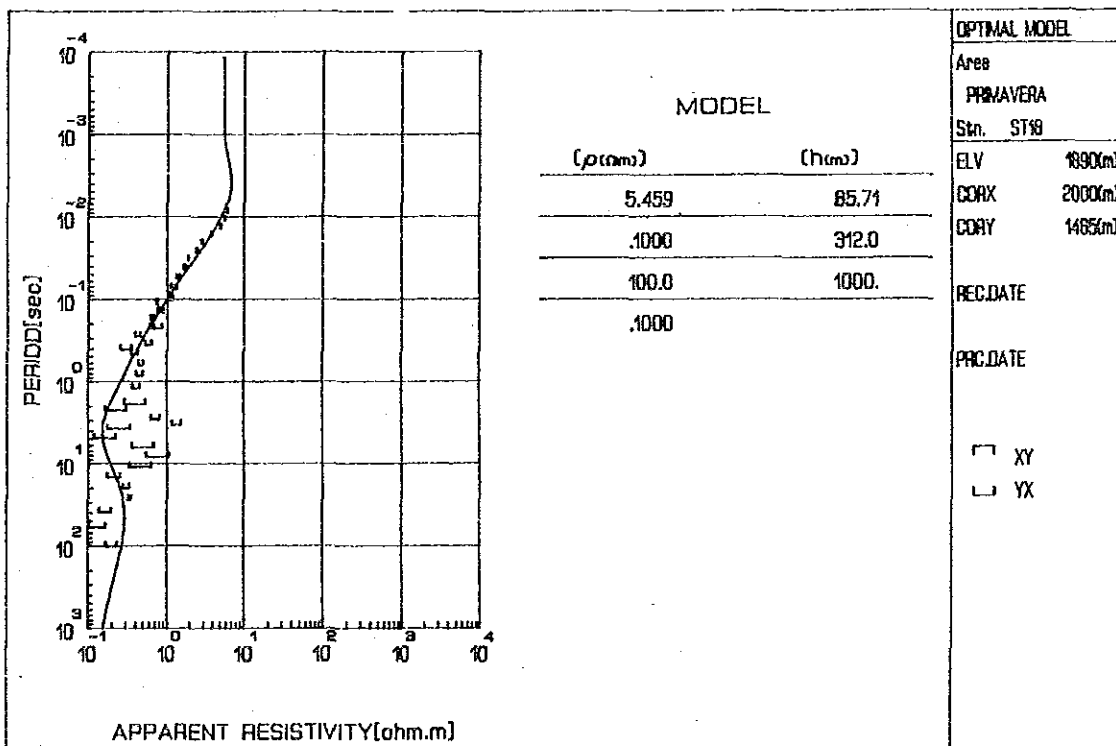

Sta. ST18

May 12 1986

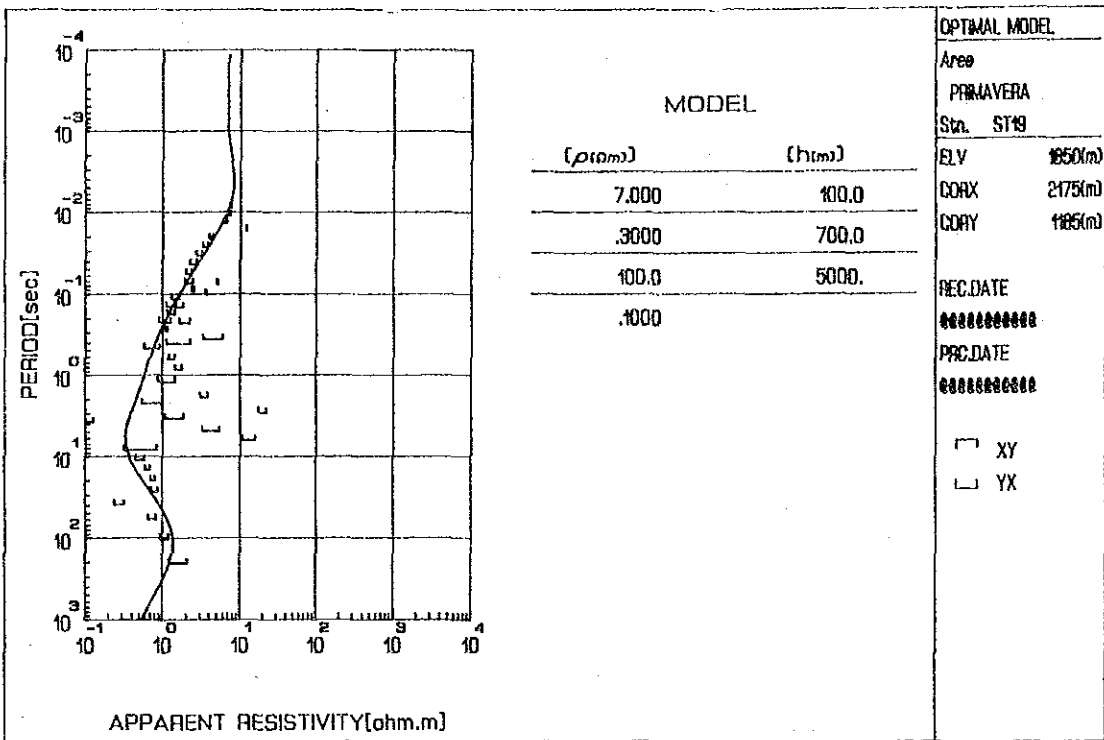

Sta. ST19

May 12 1986

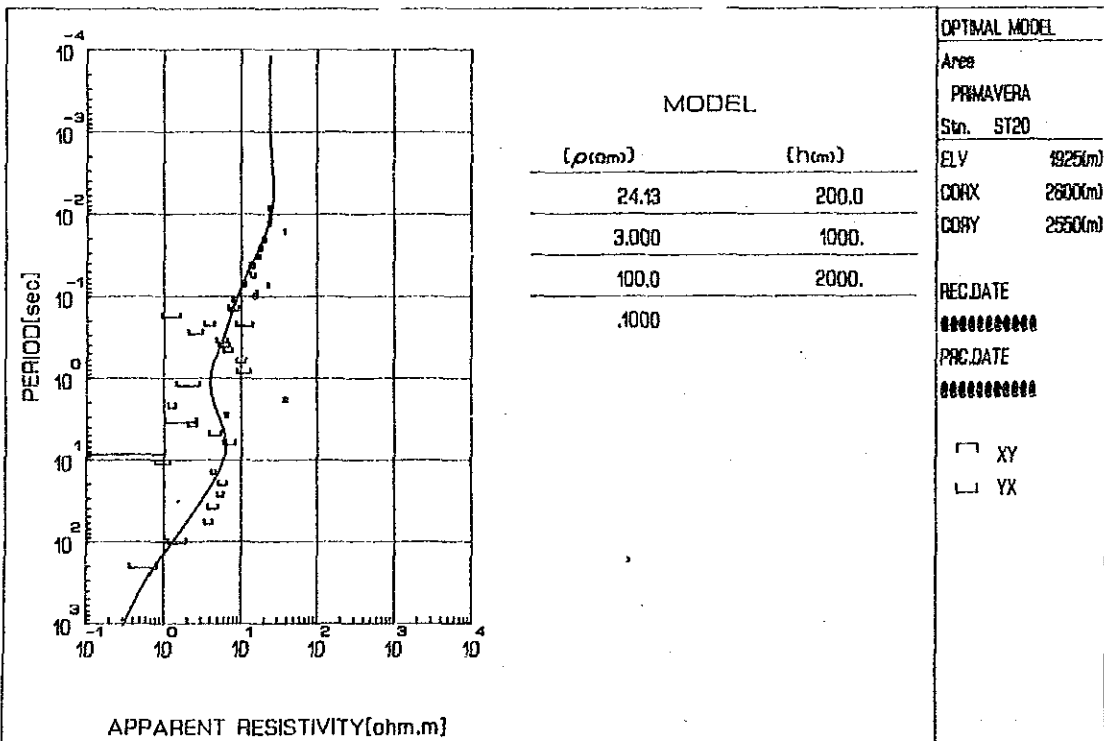

Sta. ST20

May 12 1986

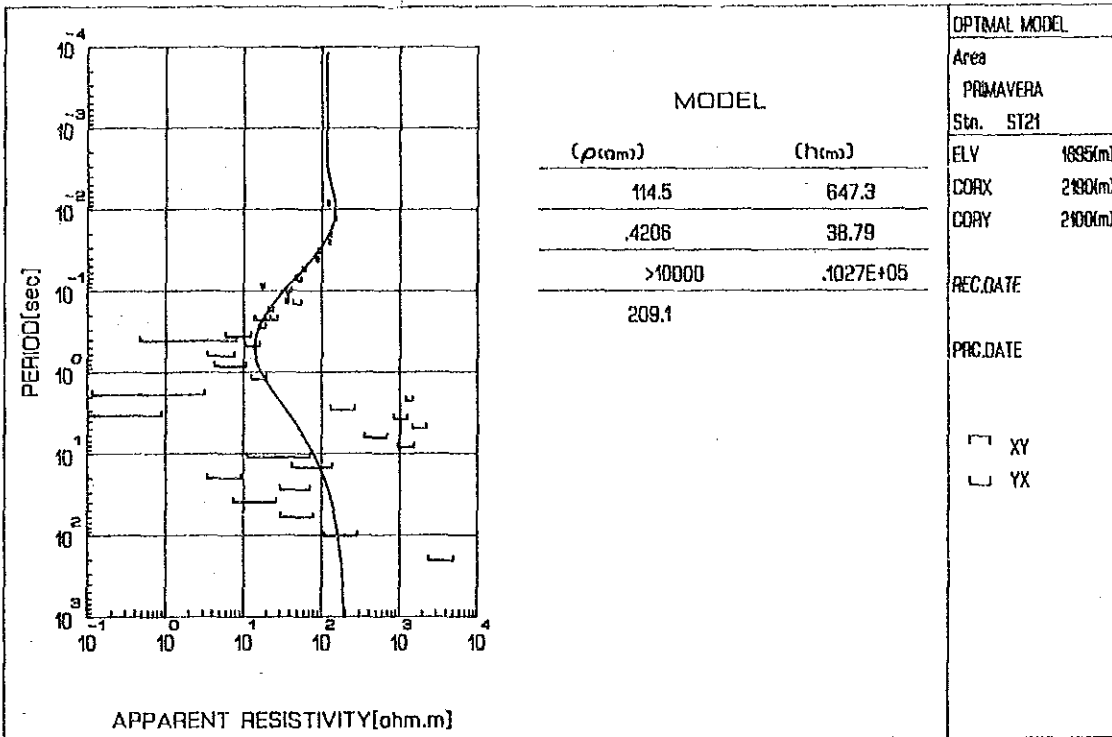

Sta. ST21

May 14 1986

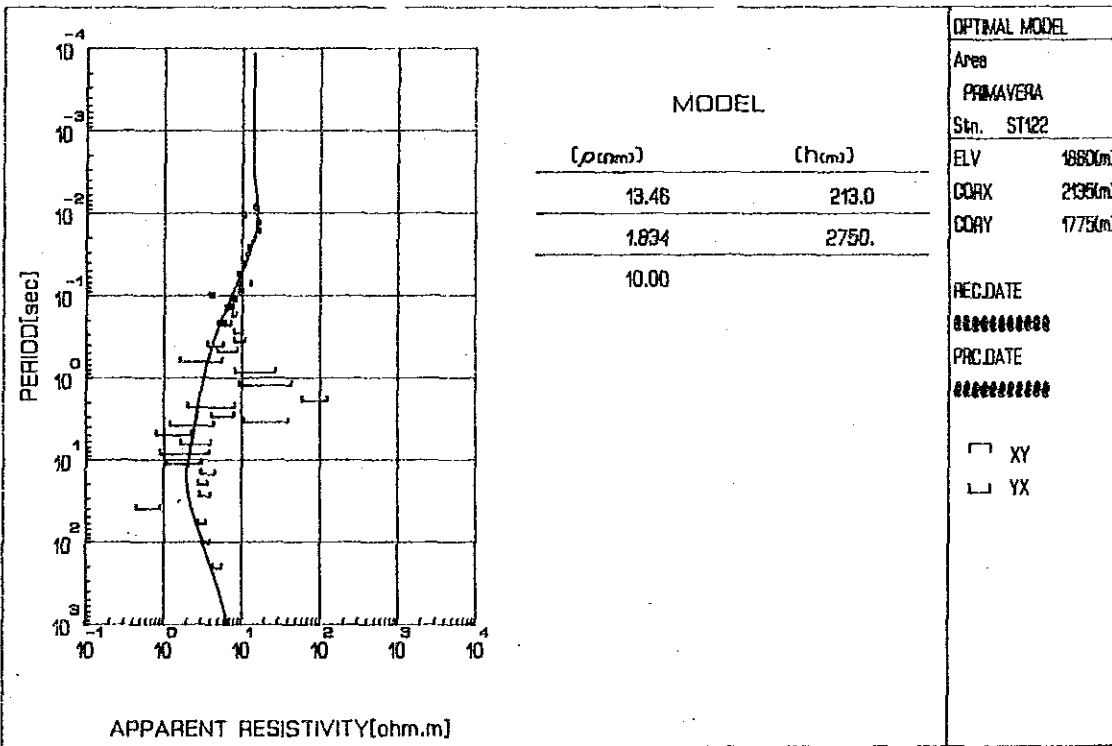

Sta. ST22

May 12 1986

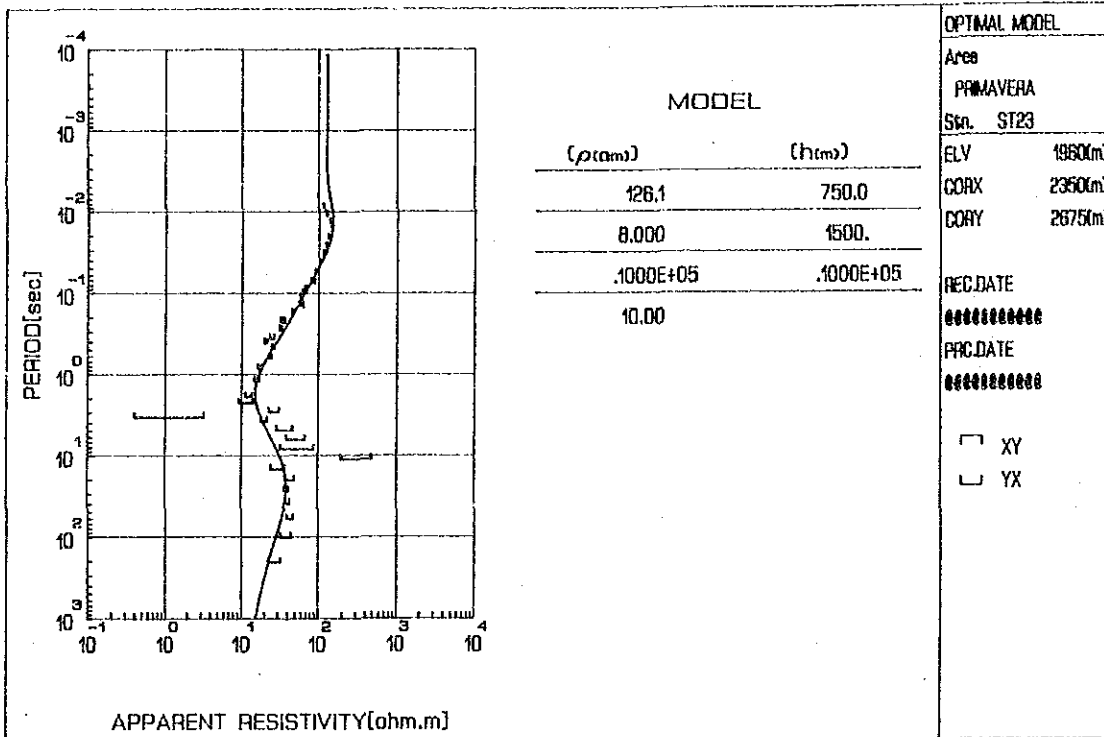

MODEL

$\rho$ (ohm)	(h(m))
126.1	750.0
8.000	1500.
.1000E+05	.1000E+05
10.00	

OPTIMAL MODEL

Area	PRIMAVERA
Sta.	ST23
ELV	1960(m)
CDRX	2350(m)
CORY	2675(m)
REC.DATE	*****
PRC.DATE	*****
<input type="checkbox"/>	XY
<input type="checkbox"/>	YX

Sta. ST23

May 12 1986

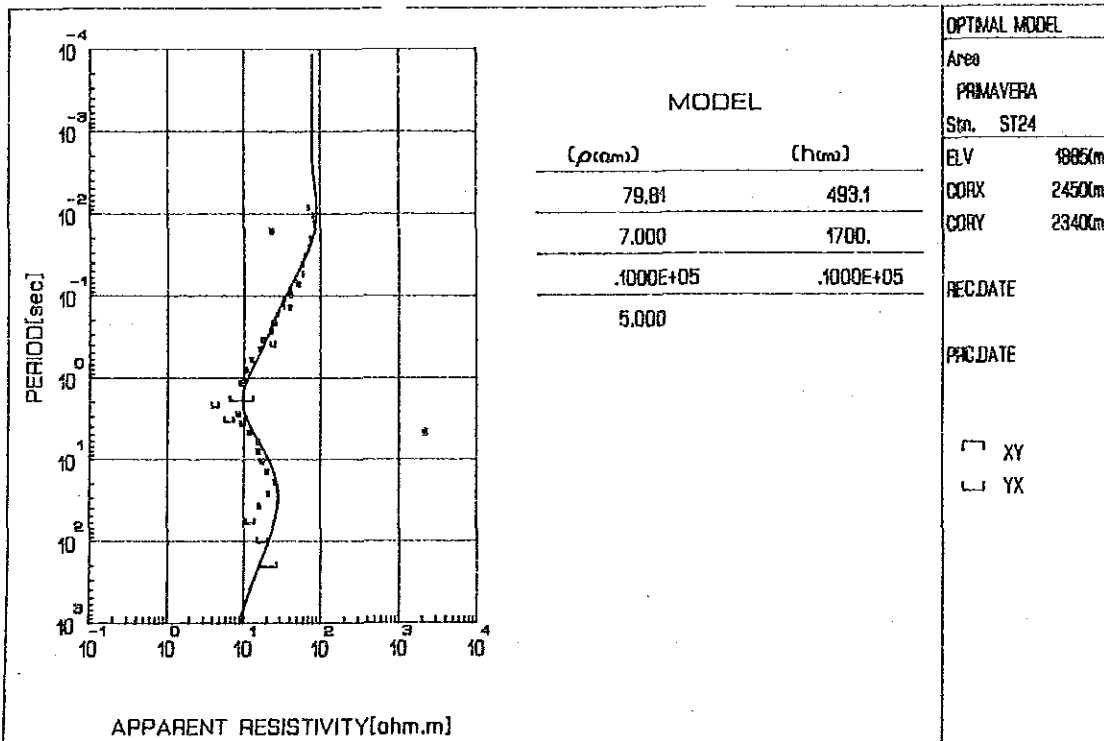

MODEL

$\rho$ (ohm)	(h(m))
79.81	493.1
7.000	1700.
.1000E+05	.1000E+05
5.000	

OPTIMAL MODEL

Area	PRIMAVERA
Sta.	ST24
ELV	1985(m)
CDRX	2450(m)
CORY	2340(m)
REC.DATE	
PRC.DATE	
<input type="checkbox"/>	XY
<input type="checkbox"/>	YX

Sta. ST24

May 12 1986

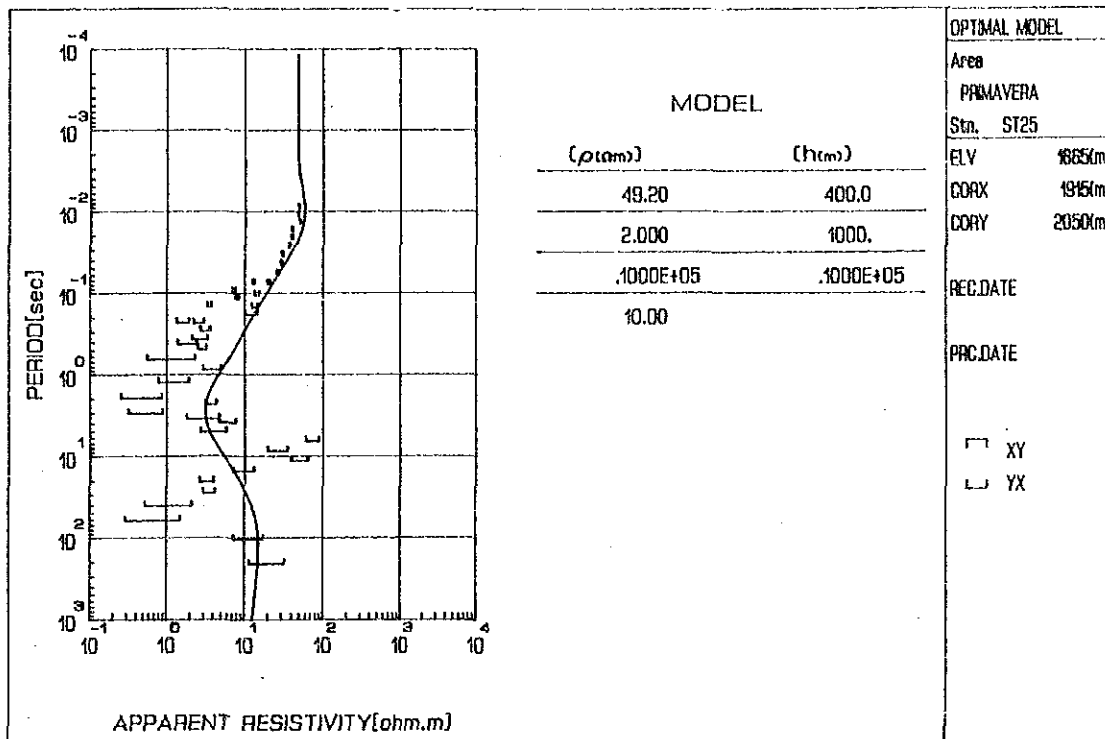

Sta. ST25

May 12 1996

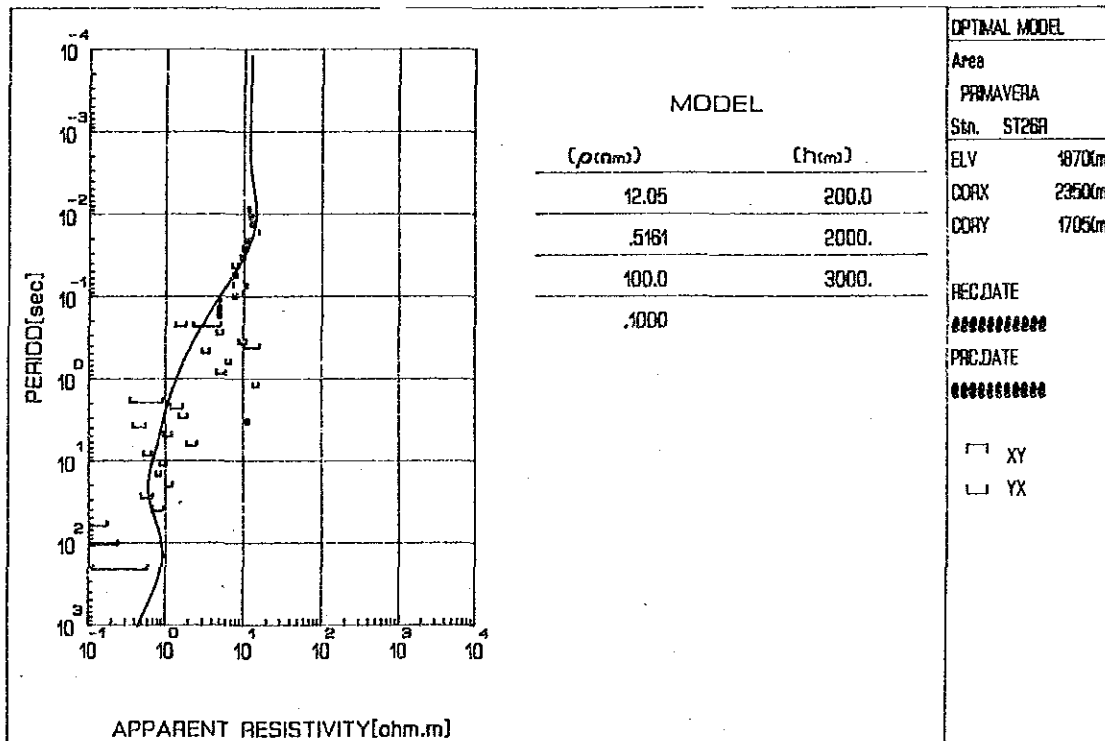

Sta. ST26

May 12 1996

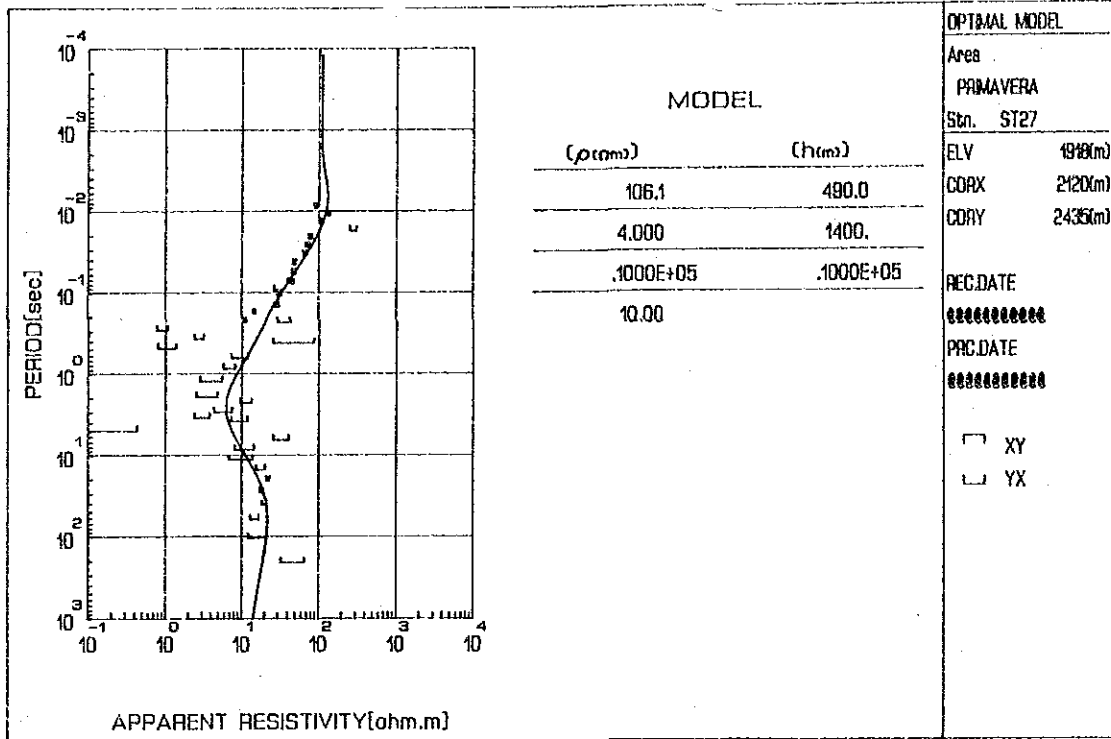

Sta. ST27

May 12 1986

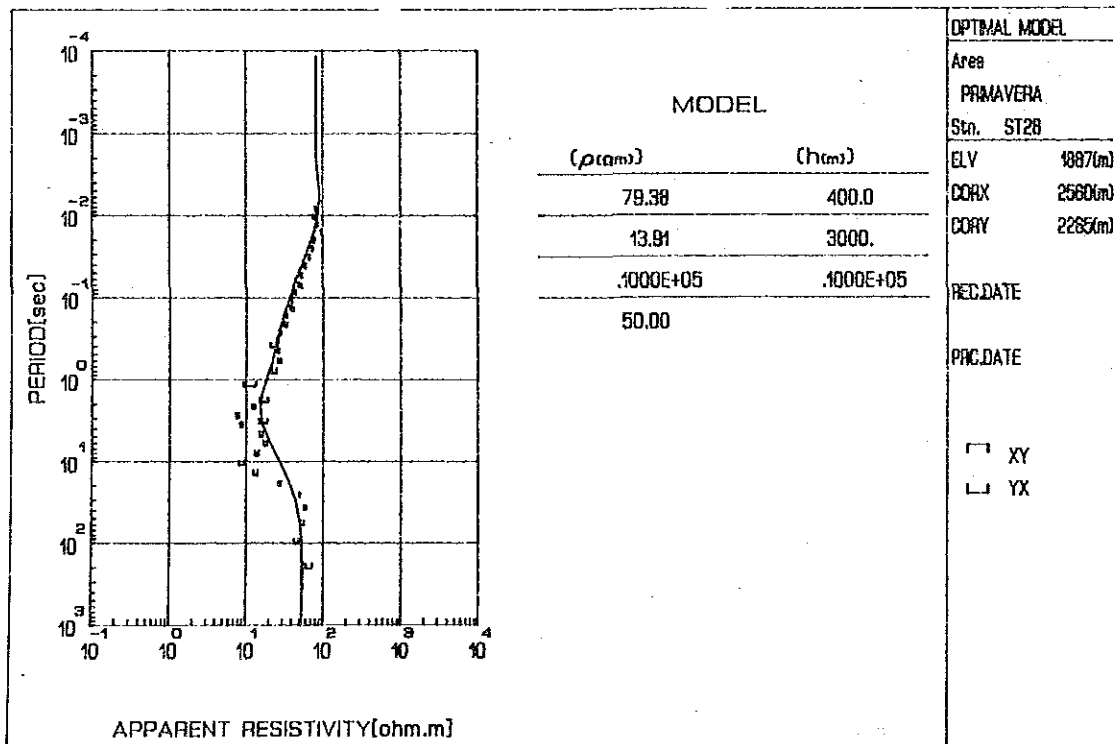

Sta. ST28

May 12 1986

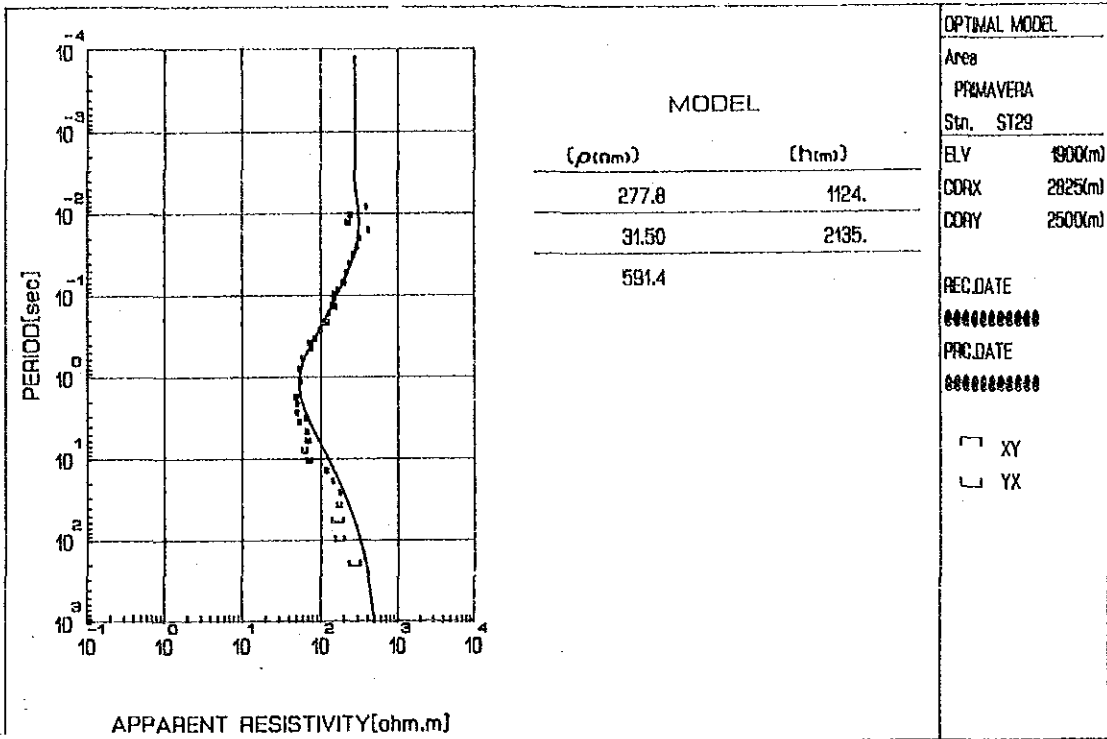

Sta. ST29

May 12 1986

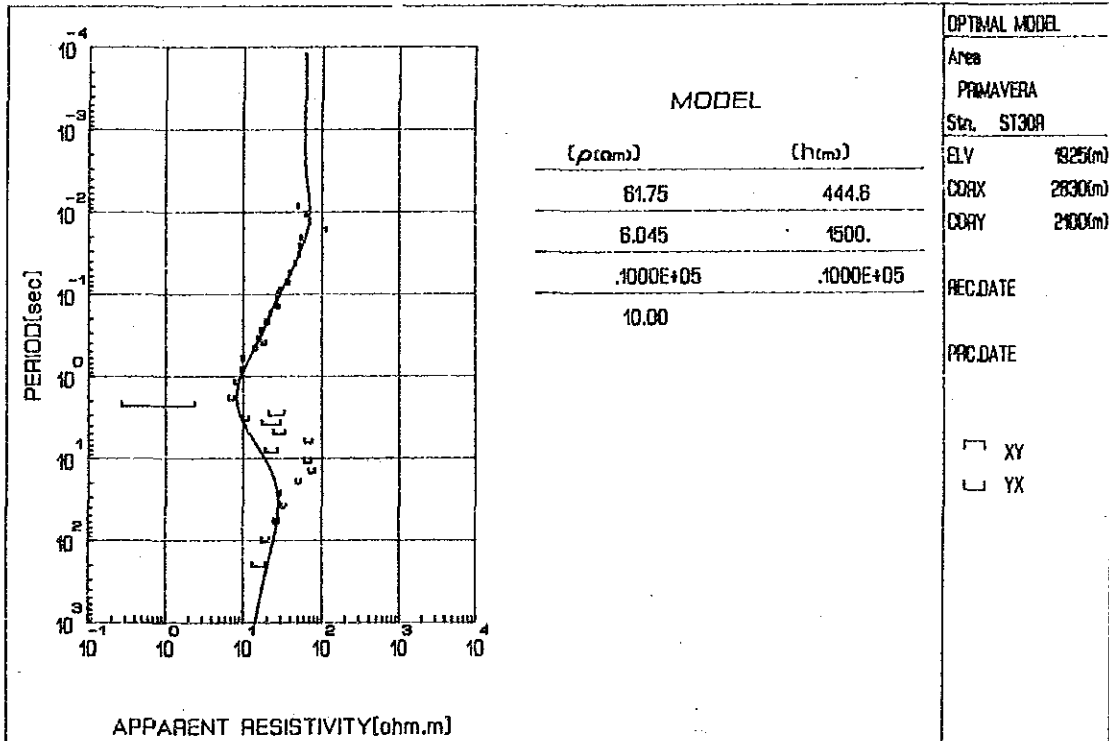

Sta. ST30

May 12 1986

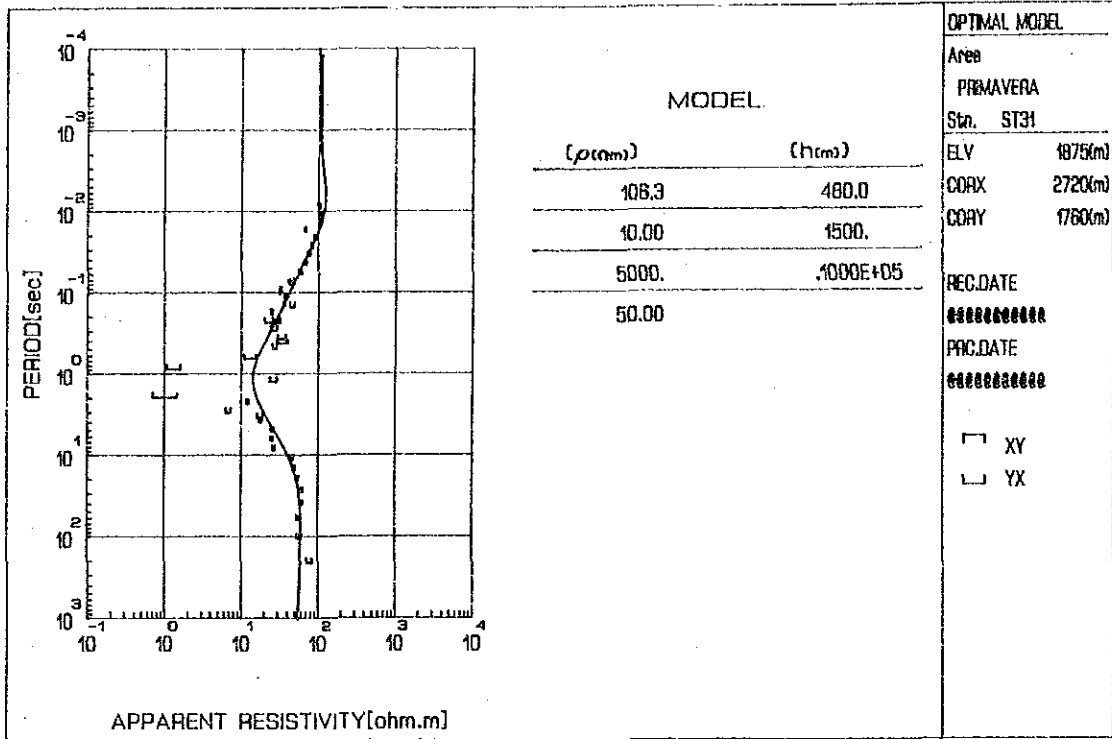

MODEL

$\rho$ (ohm)	h(m)
108.3	480.0
10.00	1500.
5000.	.1000E+05
50.00	

OPTIMAL MODEL

Area  
PRIMAVERA

Sta. ST31

ELV 1875(m)  
CORX 2720(m)  
CORY 1760(m)

REC.DATE  
#####

PRC.DATE  
#####

XY  
 YX

Sta. ST31

May 12 1986

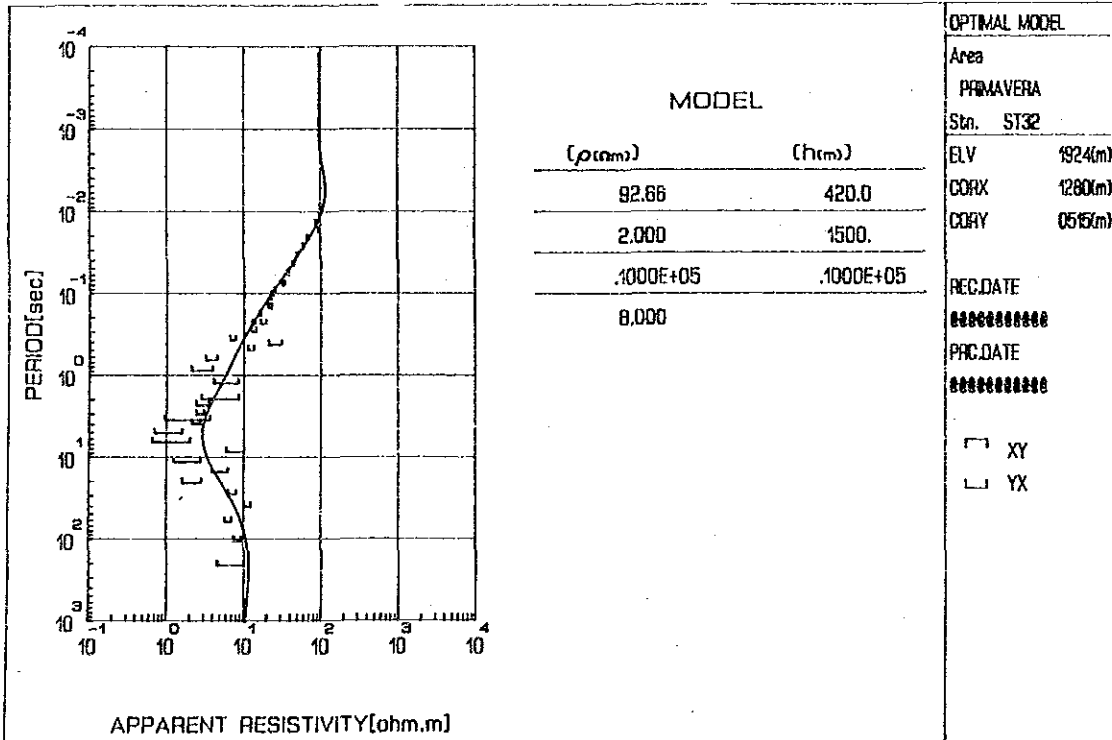

MODEL

$\rho$ (ohm)	h(m)
92.66	420.0
2.000	1500.
.1000E+05	.1000E+05
8.000	

OPTIMAL MODEL

Area  
PRIMAVERA

Sta. ST32

ELV 1924(m)  
CORX 1280(m)  
CORY 0515(m)

REC.DATE  
#####

PRC.DATE  
#####

XY  
 YX

Sta. ST32

May 12 1986



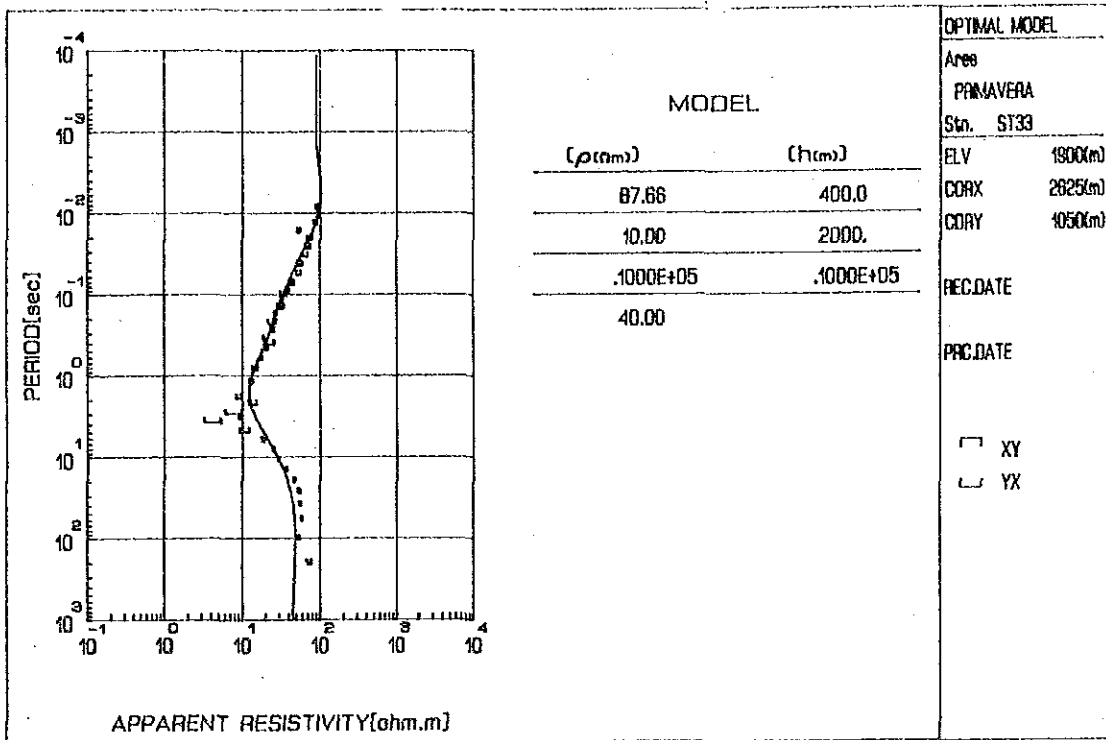

Sta. ST33

May 12 1986

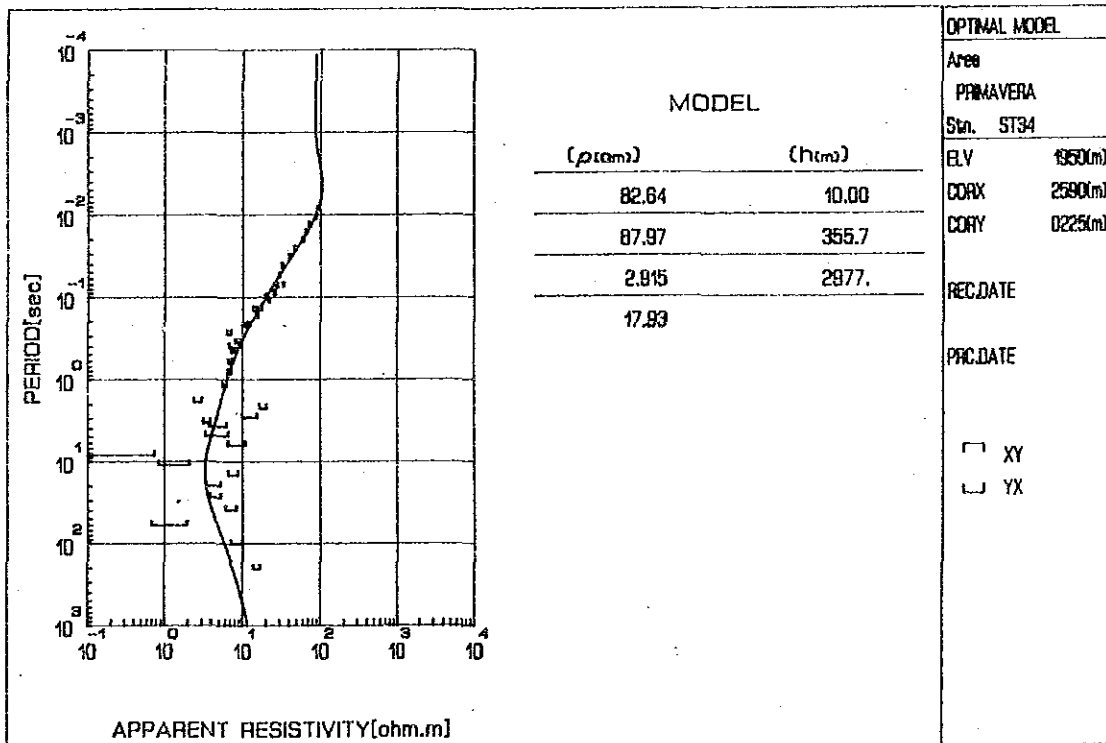

Sta. ST34

May 12 1986

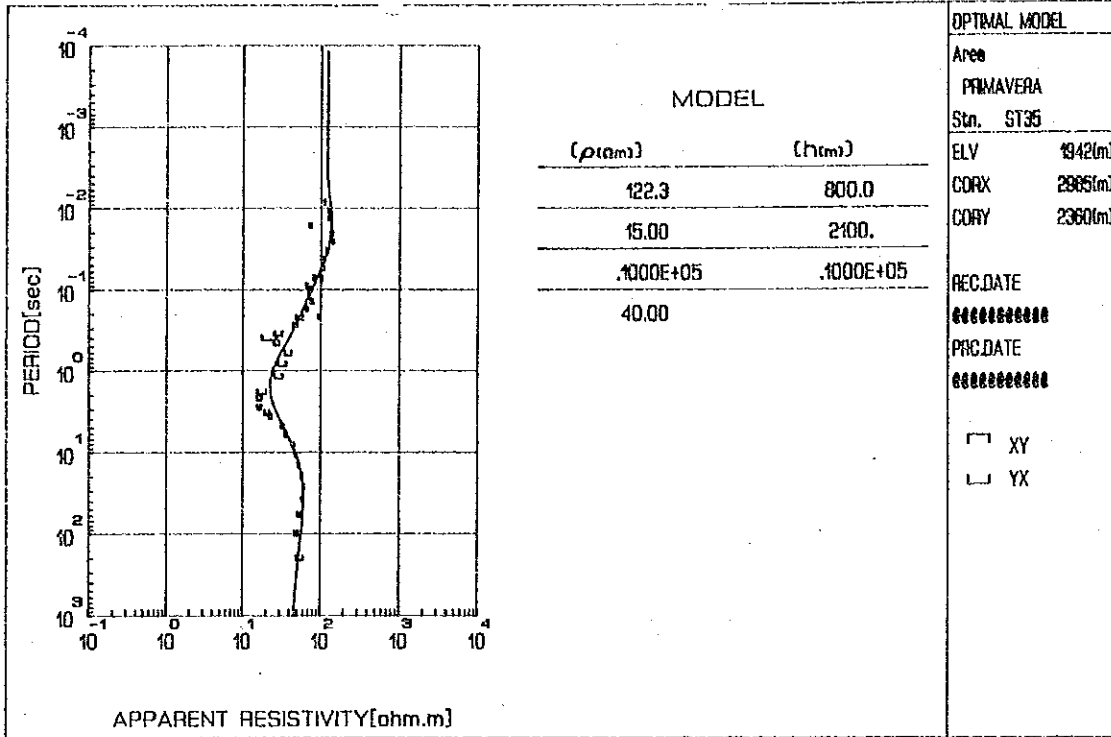

Stn. ST35

May 12 1986

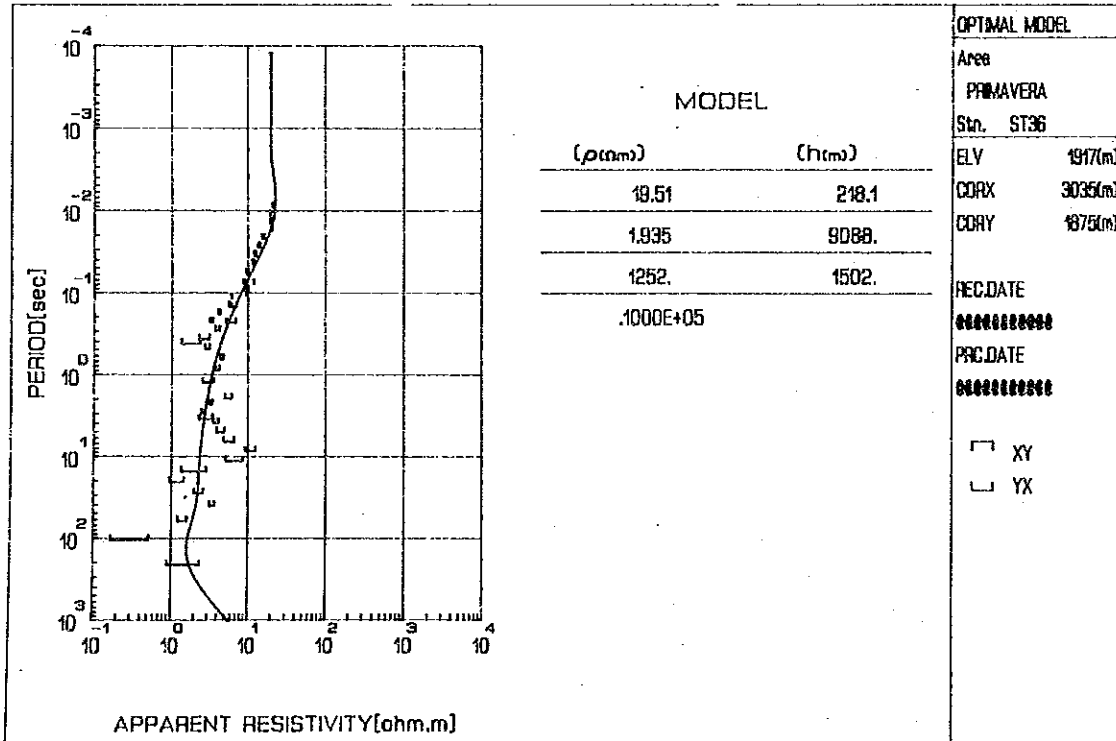

Stn. ST38

May 12 1986

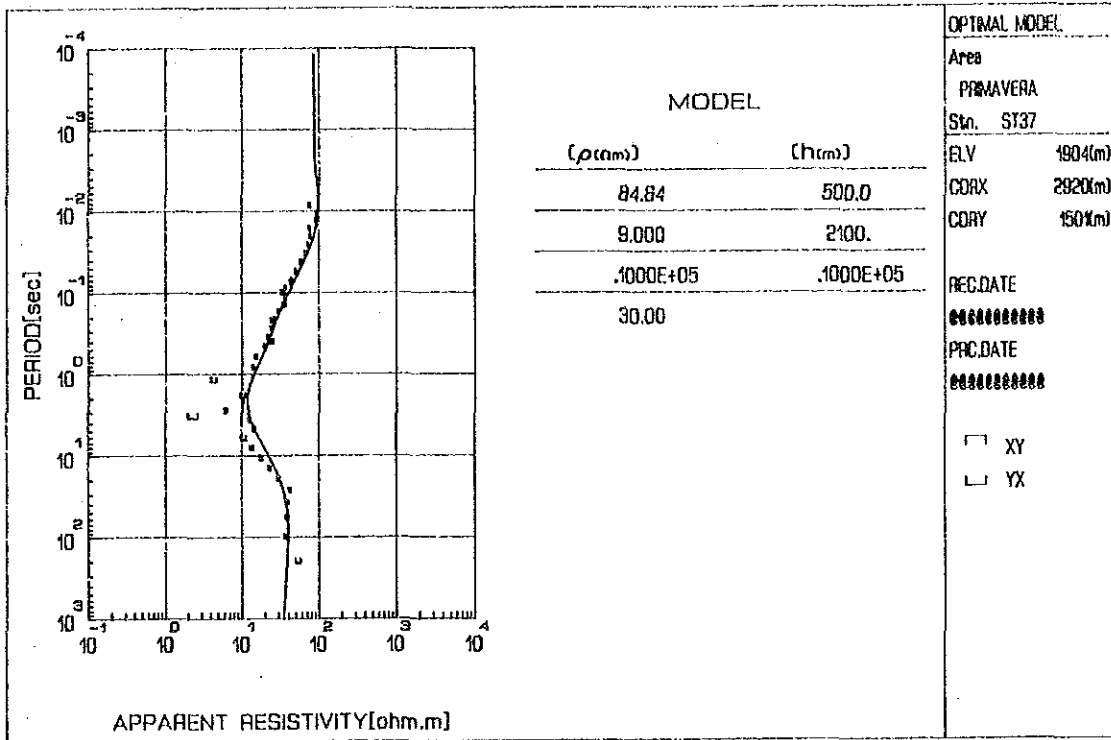

Stn. ST37

May 12 1986

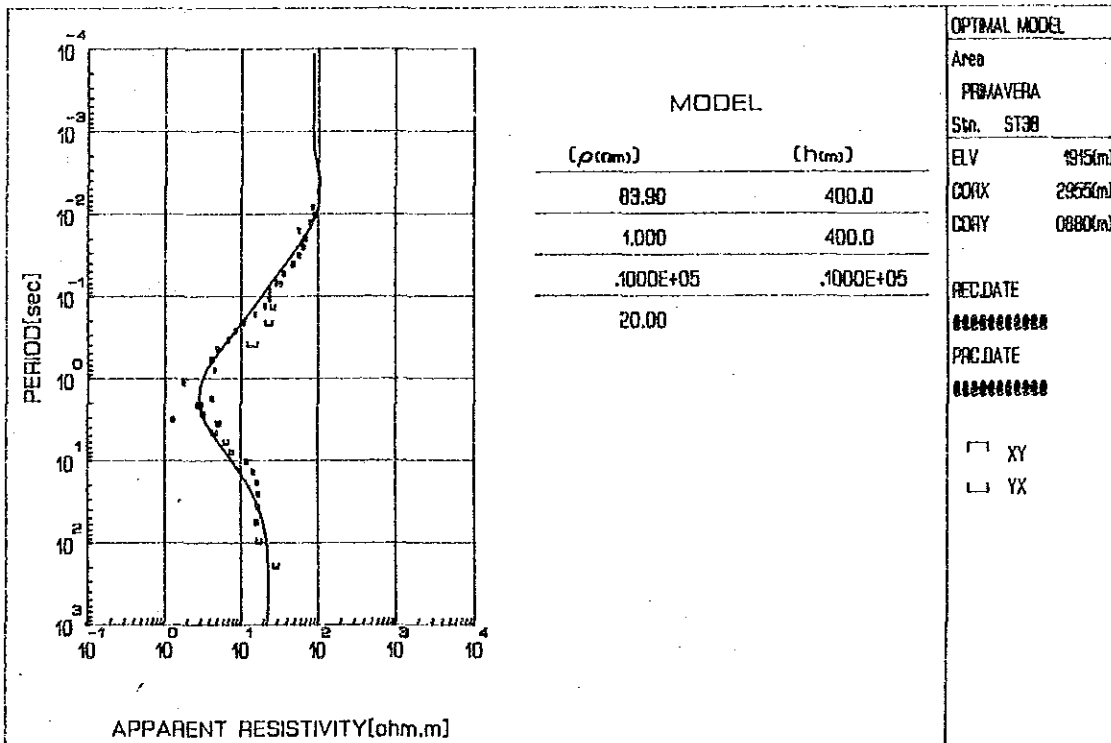

Stn. ST38

May 12 1986

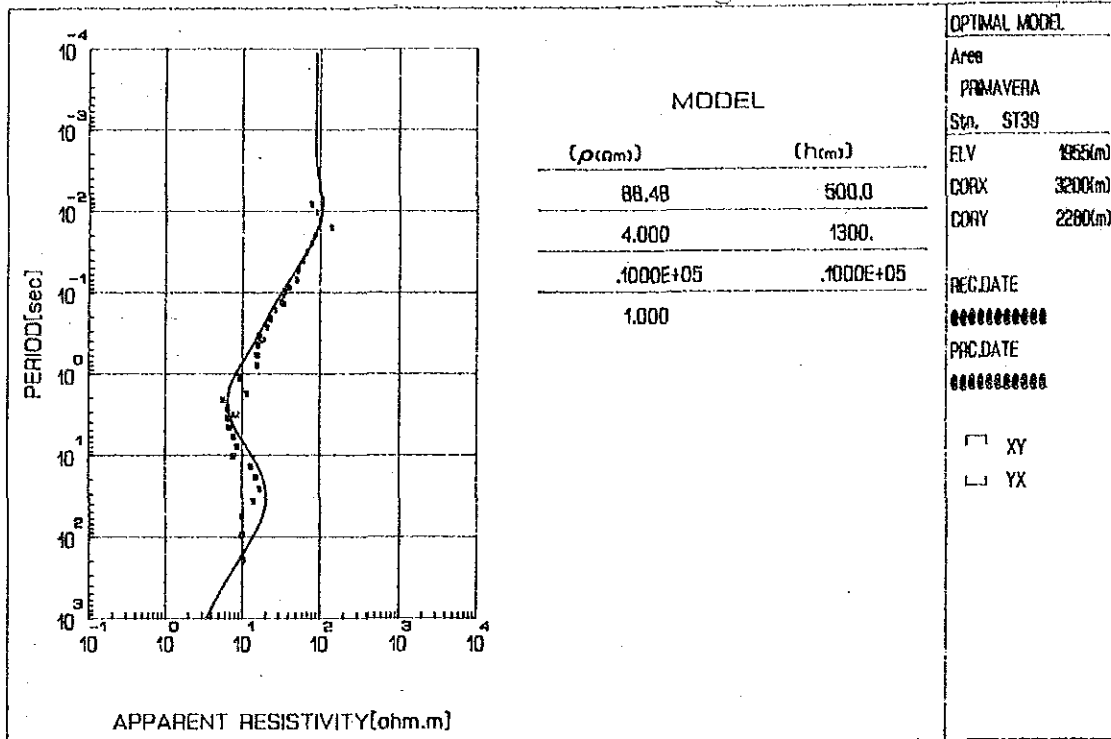

Sta. ST39

May 12 1986

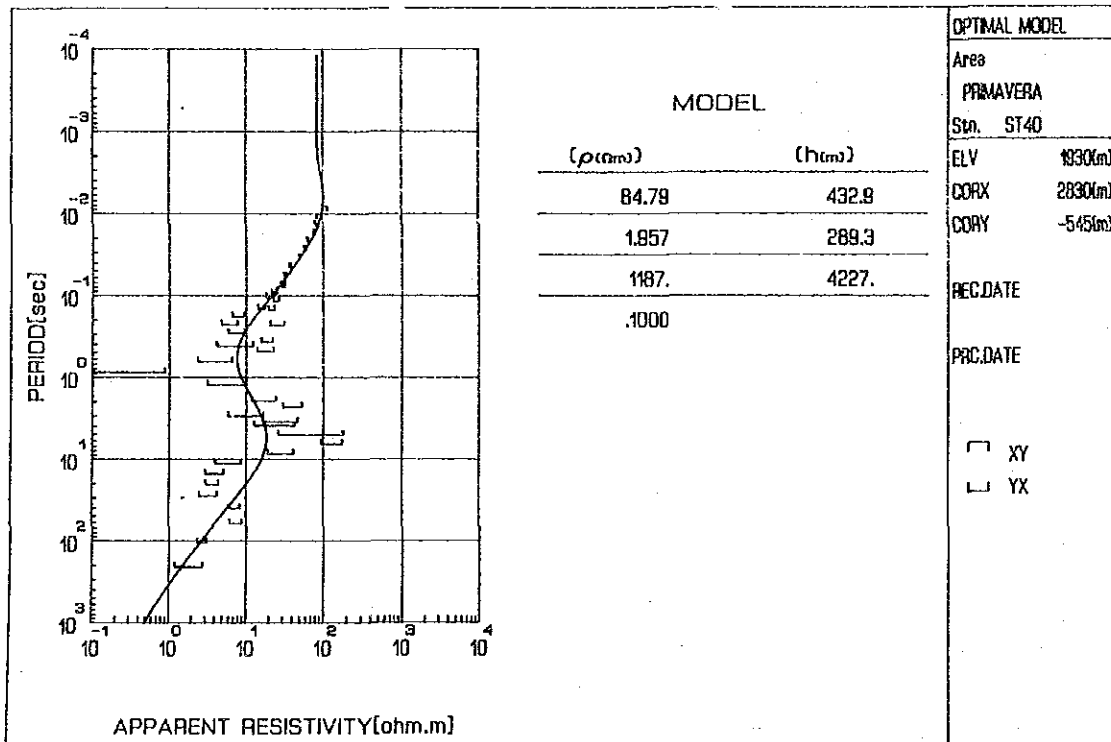

Sta. ST40

May 14 1986

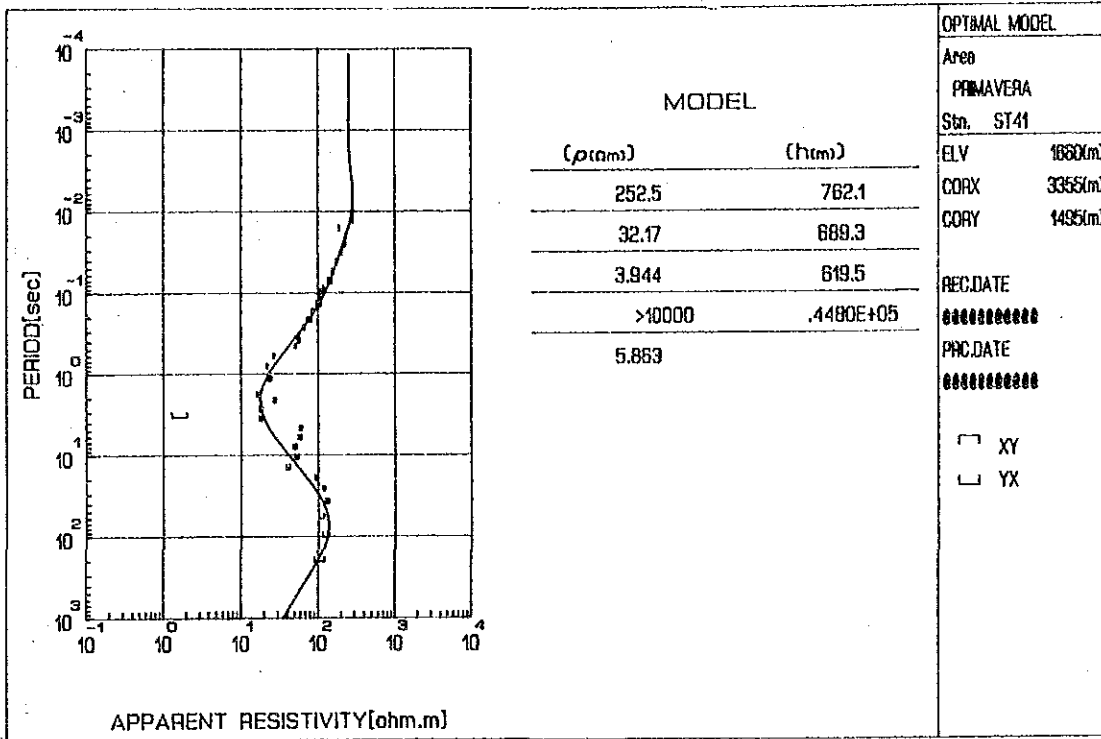

MODEL

( $\rho$ (ohm))	(h(m))
252.5	762.1
32.17	689.3
3.944	619.5
>10000	.4480E+05
5.863	

OPTIMAL MODEL

Area  
PRIMAVERA

Sta. ST41

ELV 1860(m)  
CORX 3355(m)  
CORY 1495(m)

REC.DATE  
#####

PRC.DATE  
#####

XY  
 YX

Sta. ST41

May 14 1986

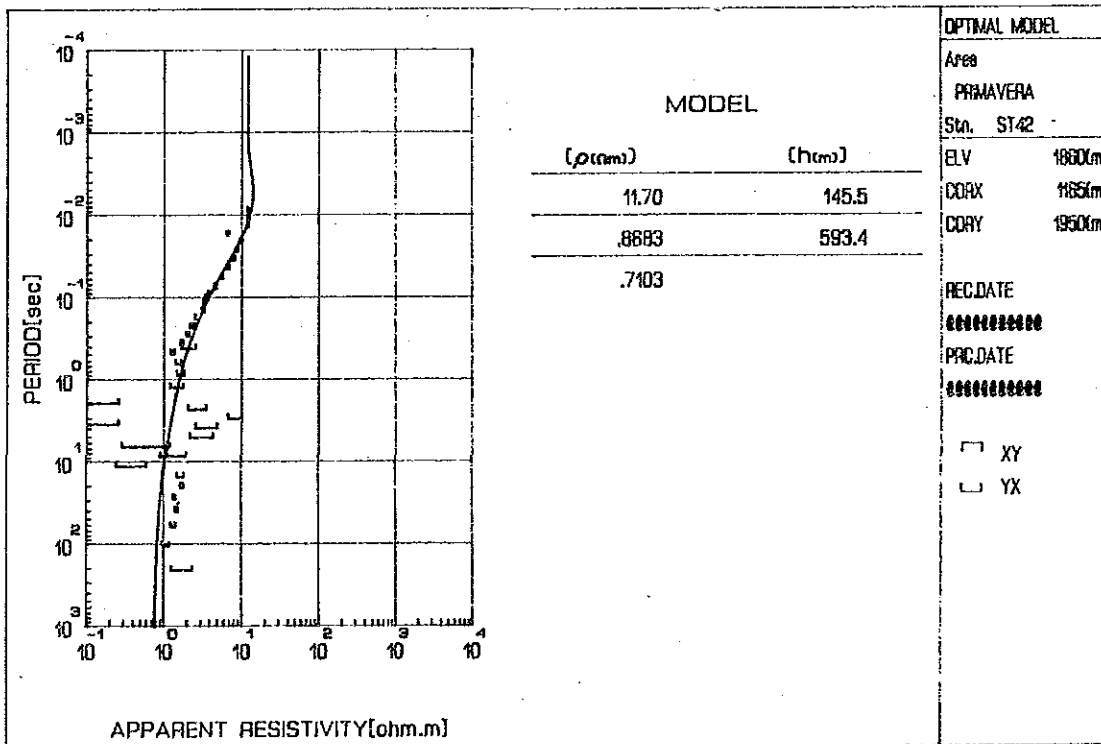

MODEL

( $\rho$ (ohm))	(h(m))
11.70	145.5
.8683	593.4
.7103	

OPTIMAL MODEL

Area  
PRIMAVERA

Sta. ST42

ELV 1860(m)  
CORX 1165(m)  
CORY 1950(m)

REC.DATE  
#####

PRC.DATE  
#####

XY  
 YX

Sta. ST42

May 12 1986

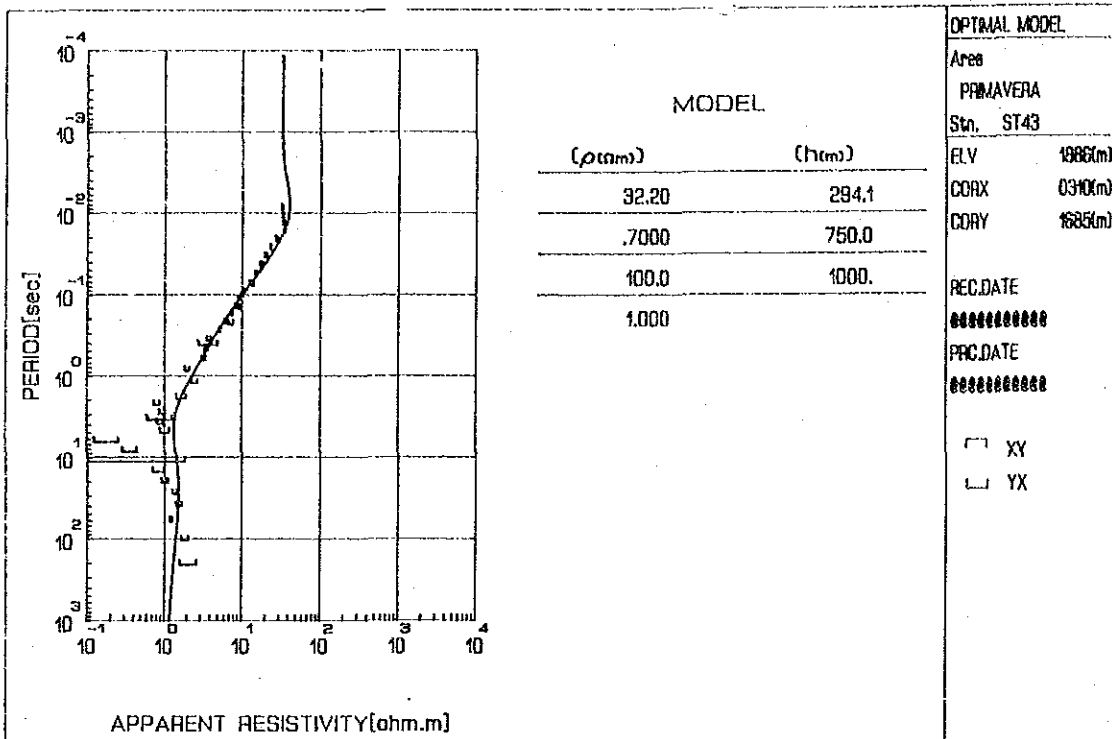

Sta. ST43

May 12 1986

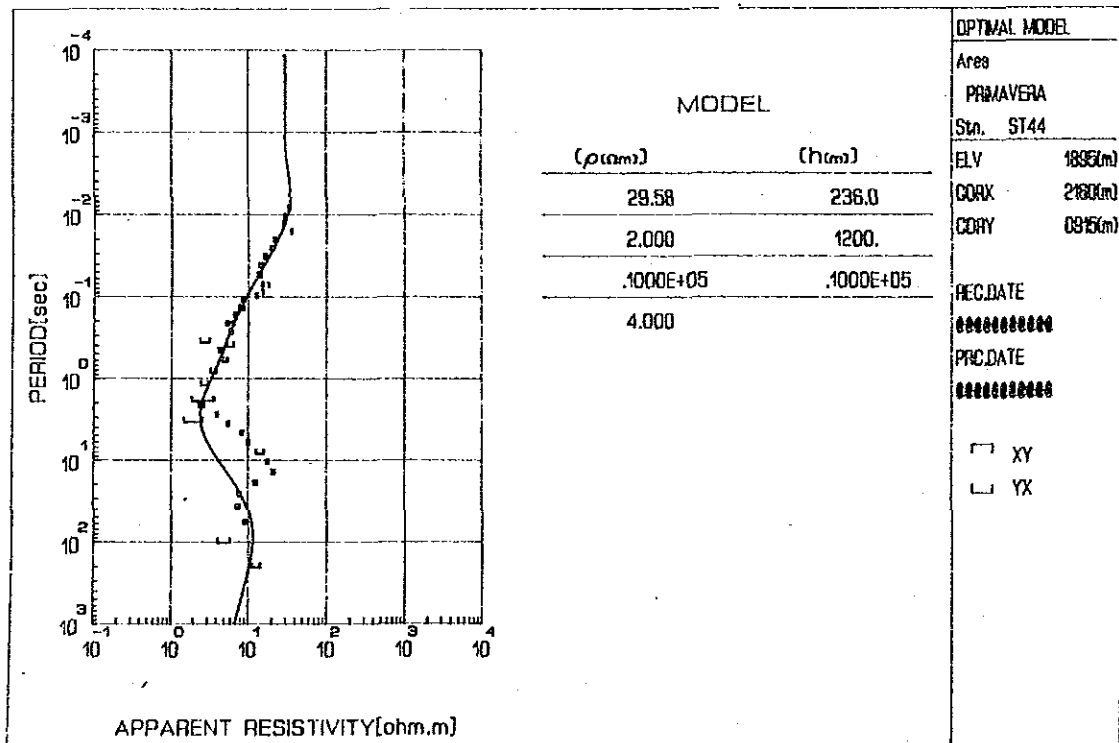

Sta. ST44

May 12 1986

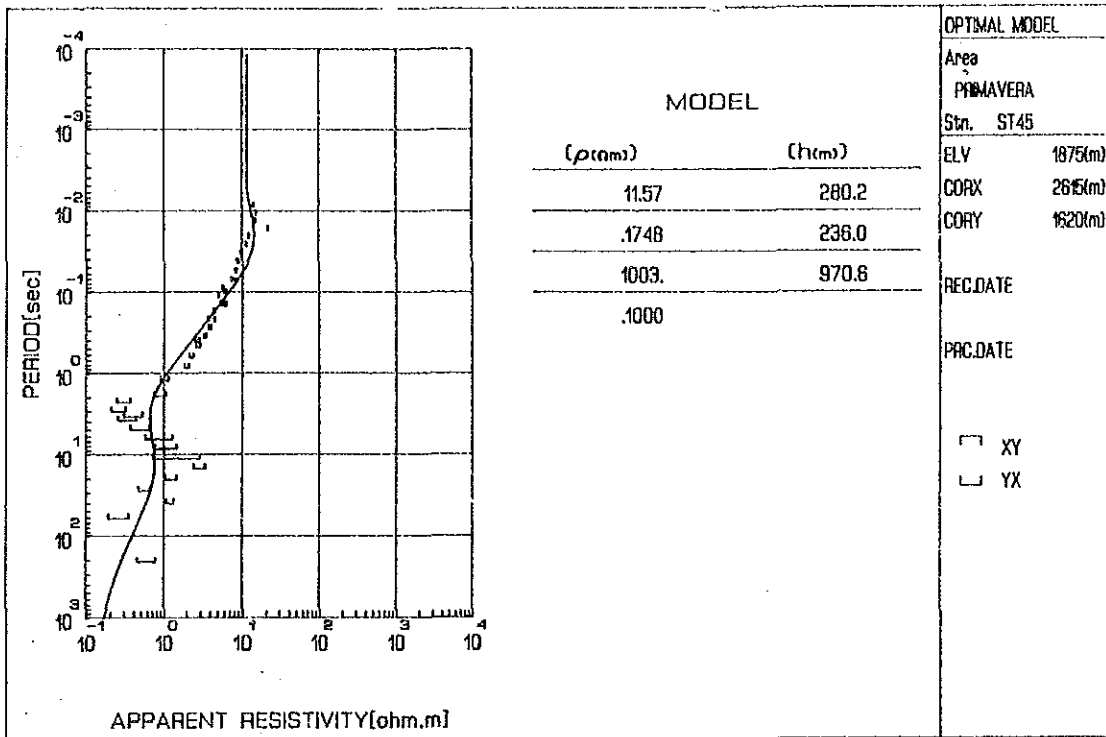

Stn. ST45

May 14 1986

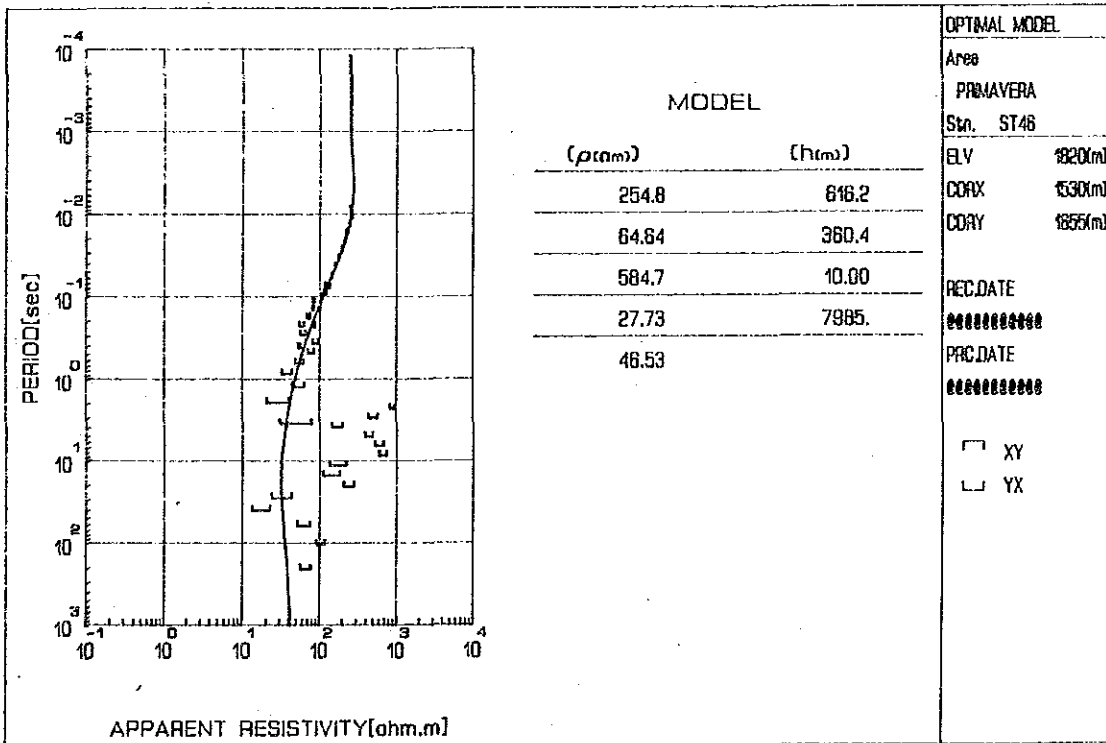

Stn. ST46

May 12 1986

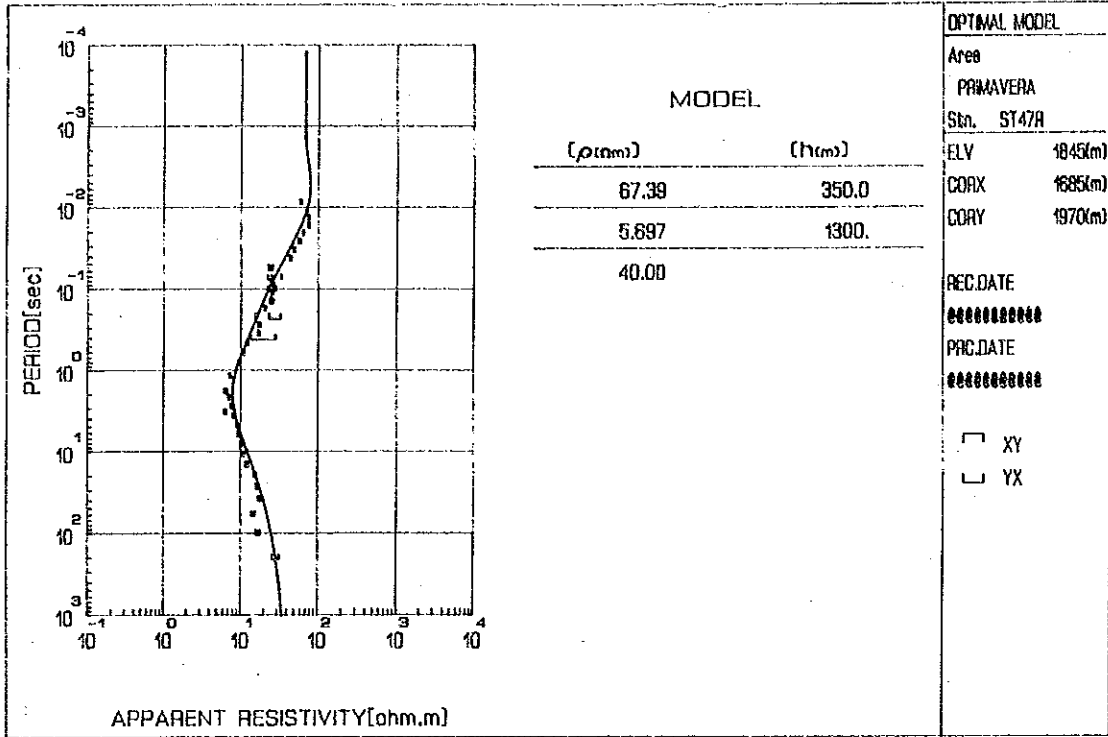

Stn. ST47

May 12 1986

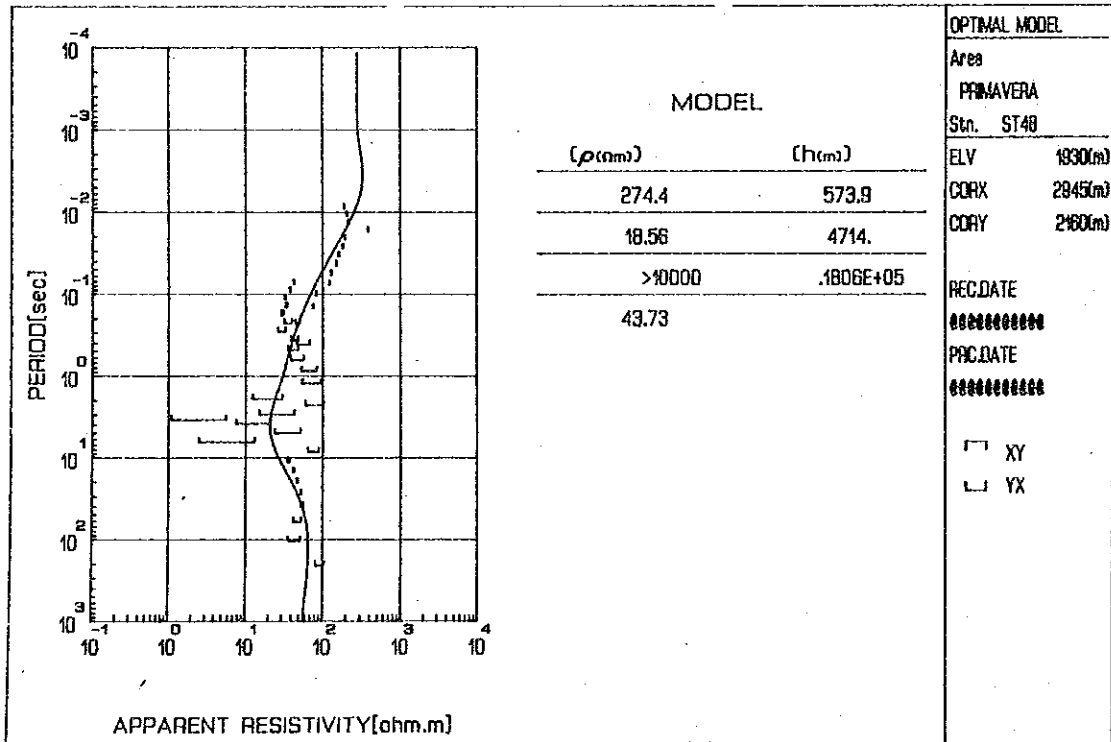

Stn. ST48

May 14 1986



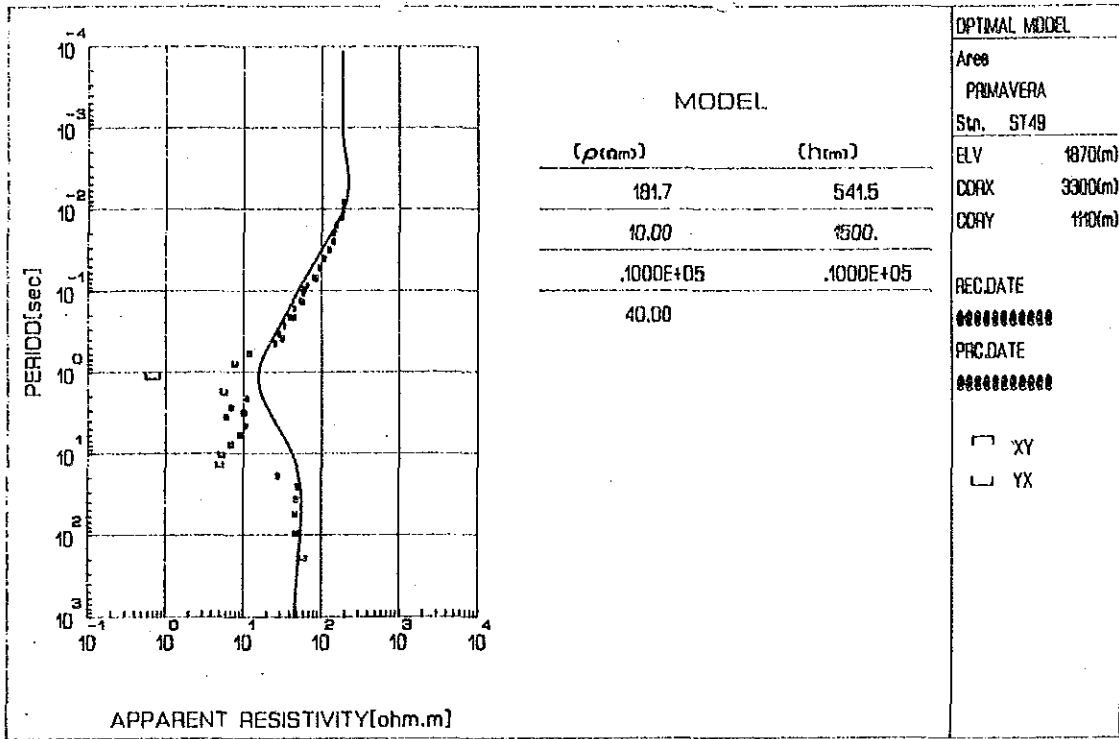

Sta. ST49

May 12 1986

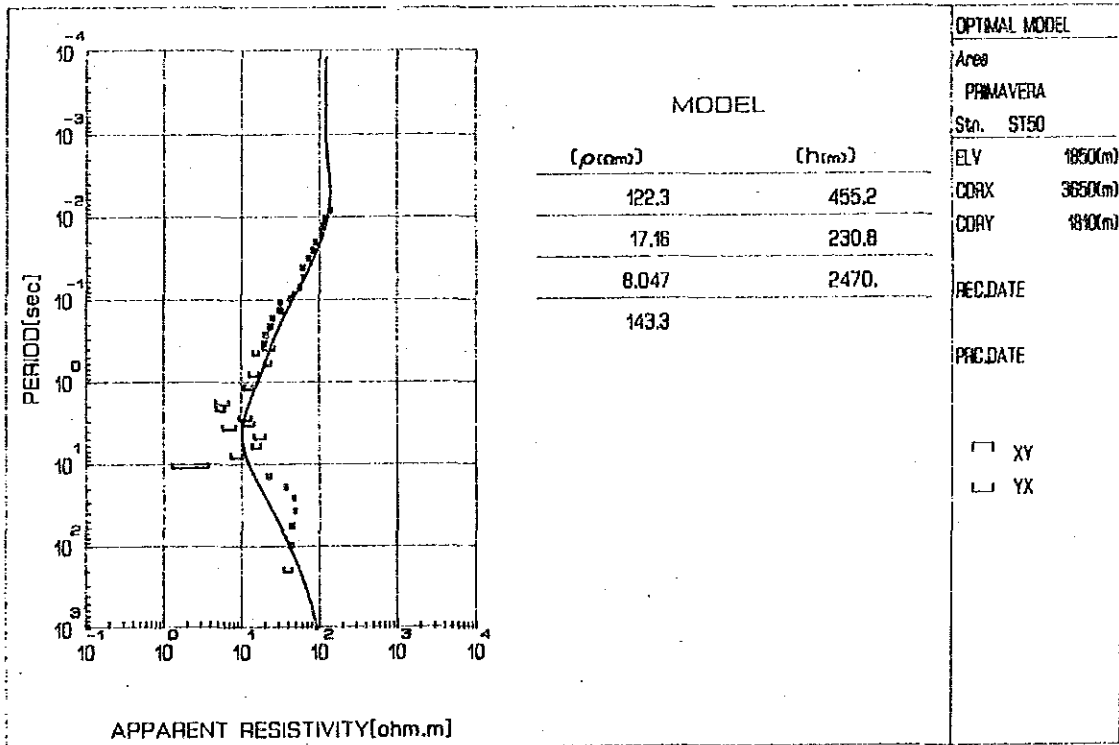

Sta. ST50

May 12 1986

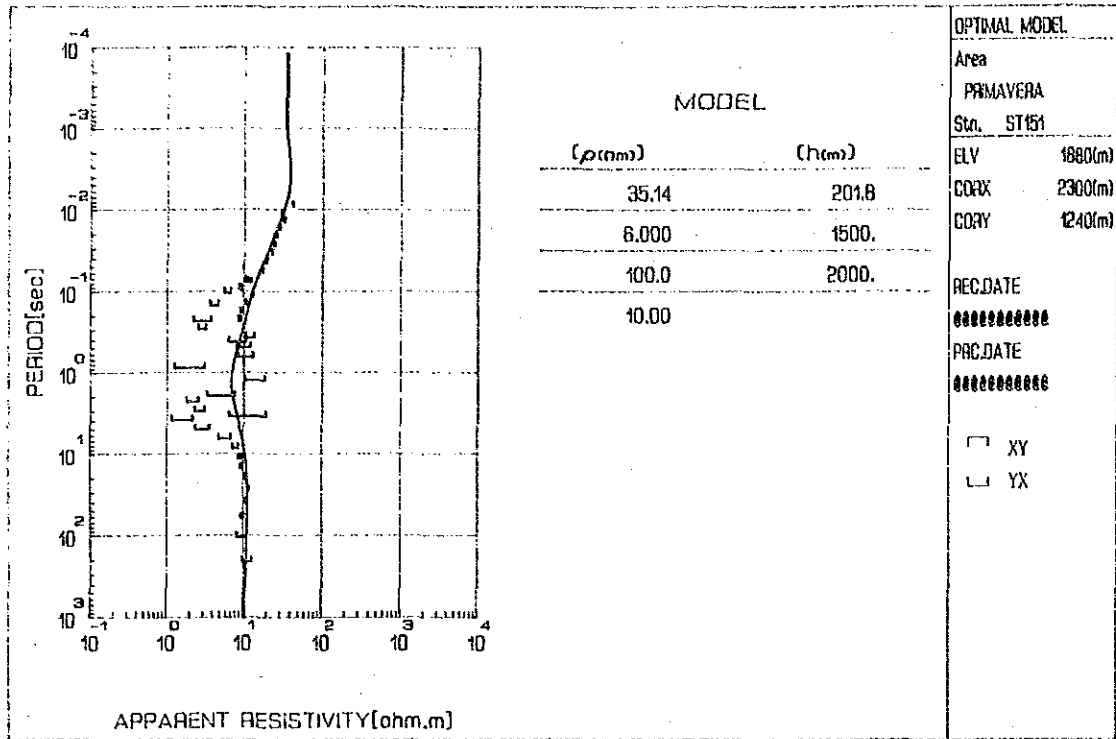

MODEL	
$\rho$ (ohm)	h(m)
35.14	201.8
6.000	1500.
100.0	2000.
10.00	

OPTIMAL MODEL  
 Area  
 PRIMAVERA  
 Sta. ST51  
 ELV 1880(m)  
 CORX 2300(m)  
 CORY 1240(m)  
 REC.DATE  
 #####  
 PRE.DATE  
 #####  
 XY  
 YX

Sta. ST51

May 12 1986

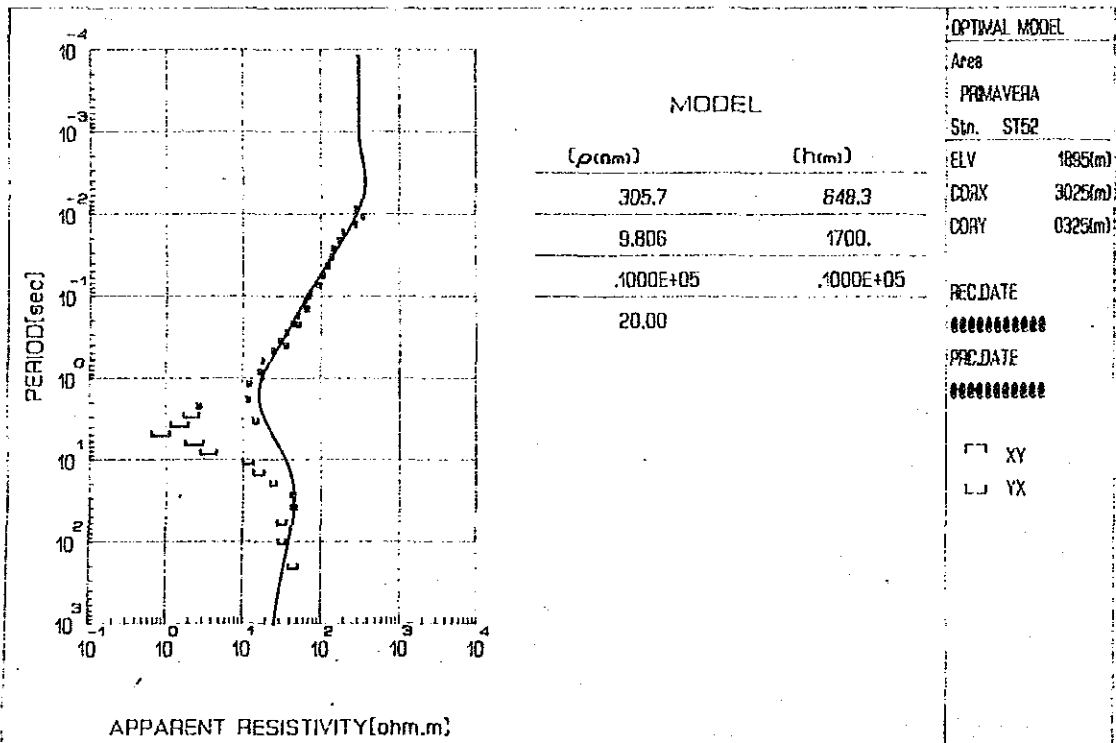

MODEL	
$\rho$ (ohm)	h(m)
305.7	848.3
9.806	1700.
.1000E+05	.1000E+05
20.00	

OPTIMAL MODEL  
 Area  
 PRIMAVERA  
 Sta. ST52  
 ELV 1895(m)  
 CORX 3025(m)  
 CORY 0325(m)  
 REC.DATE  
 #####  
 PRE.DATE  
 #####  
 XY  
 YX

Sta. ST52

May 12 1986

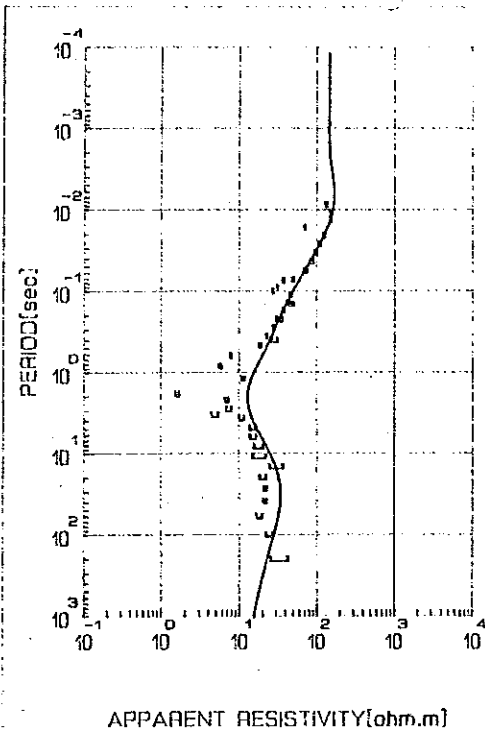

MODEL

$(\rho_{nm})$	$(h_{nm})$
139.6	550.0
8.847	2000.
.1000E+05	.1000E+05
10.00	

OPTIMAL MODEL

Area  
PRIMAVERA

Sta. S153

ELV 1830(m)

CORX 0740(m)

CORY 1885(m)

REC.DATE  
#####

PRC.DATE  
#####

XY  
 YX

Sta. S153

May 12 1986

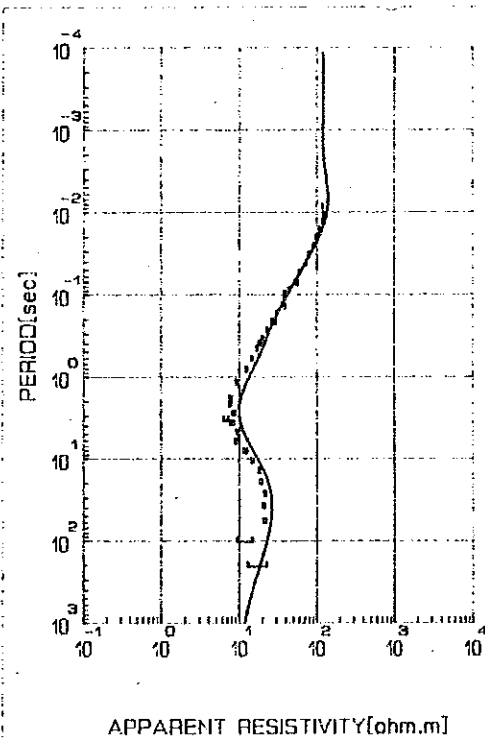

MODEL

$(\rho_{nm})$	$(h_{nm})$
116.2	524.0
7.177	2100.
.1000E+05	.1000E+05
7.000	

OPTIMAL MODEL

Area  
PRIMAVERA

Sta. S154

ELV 1805(m)

CORX 1230(m)

CORY 2430(m)

REC.DATE  
#####

PRC.DATE  
#####

XY  
 YX

Sta. S154

May 12 1986

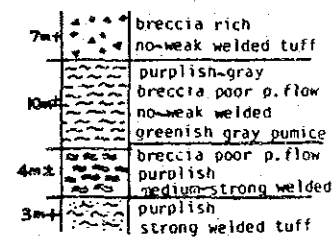
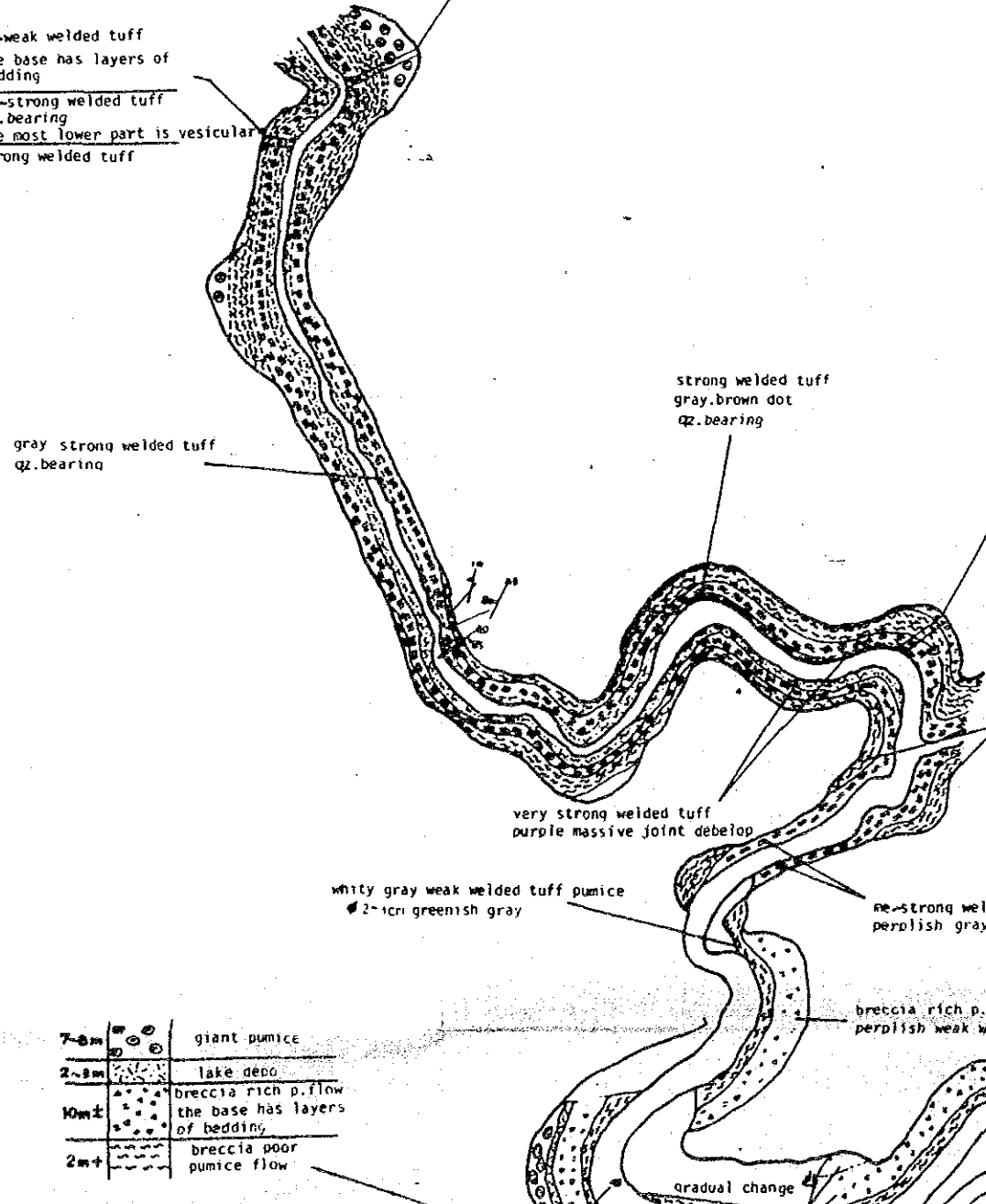
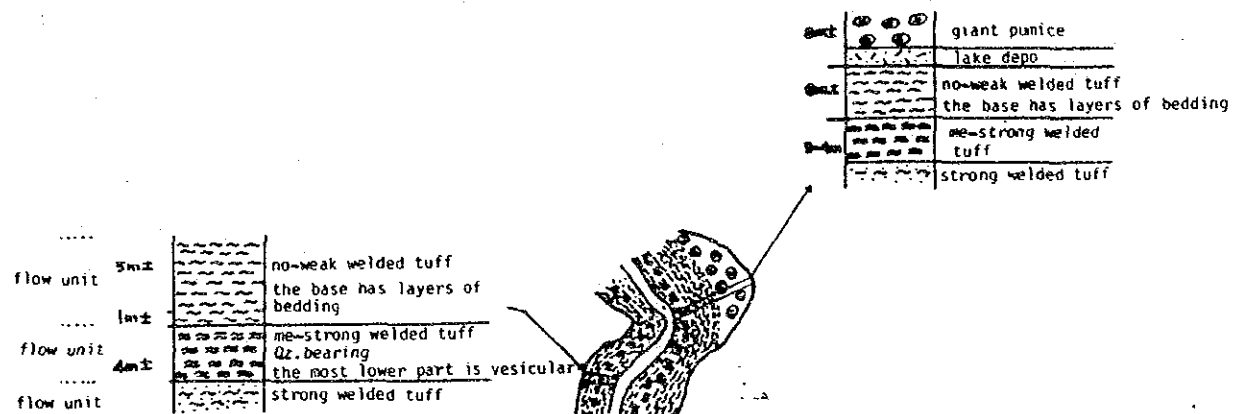

weak welded tuff  
this one grade into underlying welded tuff  
the base has partially layers of bedding

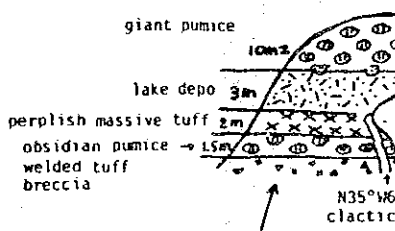
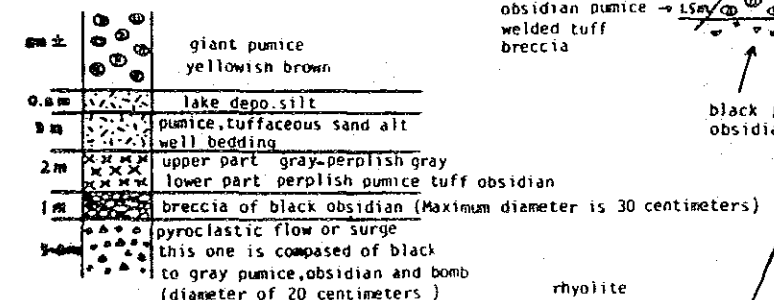
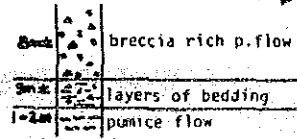
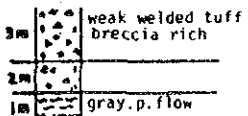
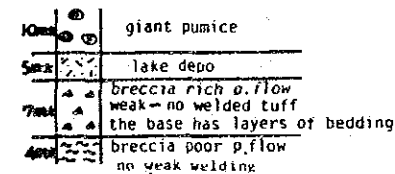
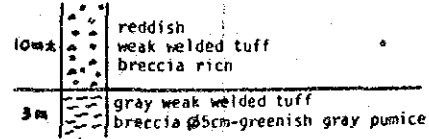

black pumice  
obsidian rich

rhyolite  
black-brownishgray  
perlitic  
0-85062201

rhyolite  
flow band  
platy.co

00-85062103

tuffaceous co s

the rock is partially silicified  
the sublimated white and yellow (s  
the rock is weakly heated  
the rock is weakly altered

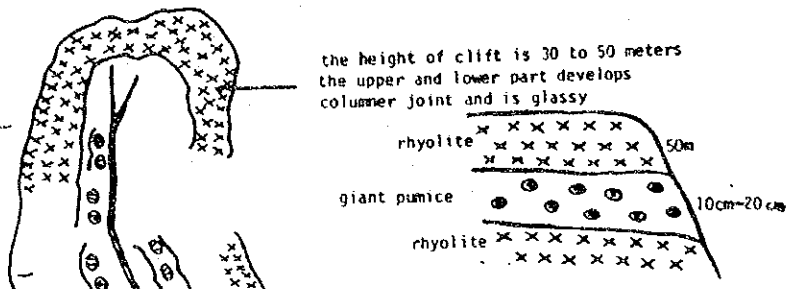

N15°W65°E  
fault throw = 0.7m

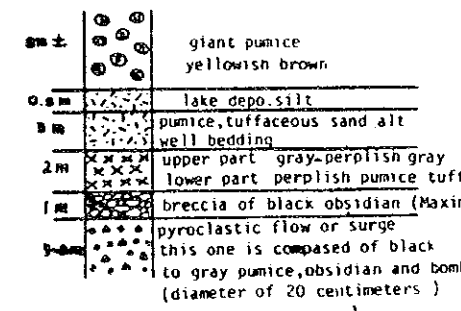
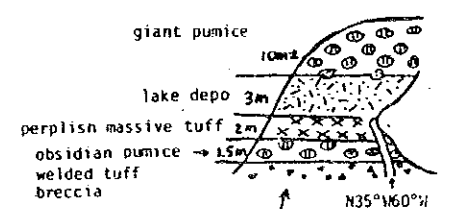

flow band clear rhyolite

black pumice obsidian rich

the flow-banded part is composed of black obsidian and brown glass and contains spherulitic

giant pumice

rhyolite black-brownish gray perlitic 0-85062201

rhyolite flow band clear platy, columnar jo

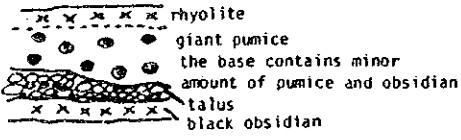

yellowish pumice

giant pumice 0p-85062201

tuffaceous co sand-silt

the rock is partially silicified  
the sublimated white and yellow (sulfur) mineral is formed on the surface of rock  
the rock is weakly altered

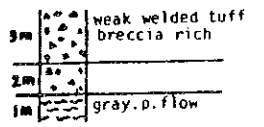

breccia rich p. flow  
this one contains breadcrust bomb (Maximum diameter of 30 centimeters), gray

grey compact rhyolite with flow structure, platy joint

platy joint

columnar joint

bluish grey hard and compact rhyolite with platy and columnar joints

1-20cm size bluish grey hard and compact rhyolite breccia

1cm size obsidian rich rhyolite with platy joint

glassy rhyolite breccia

giant pumice

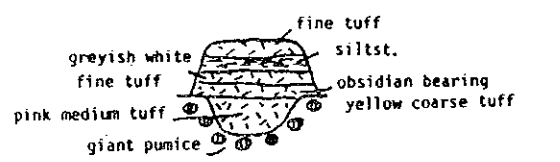

fumarole zone at the dir  
pale green giant pumice with brown argillization

rhyolite with reddish brown argillization

strong alteration  
pink rhyolite with structure, (E42°N) quartz bearing

2 10cm size angular rounded rhyolite breccia, under 1mm obsidian bearing

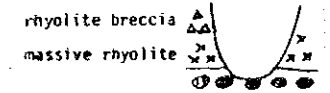

yellowish white hard and compact rhyolite

very hard and compact light brown rhyolite obsidian banding

light yellowish white giant pumice

yellowish white giant pumice, pure

greyish white giant pumice

yellow giant pumice

giant pumice

pale green compact and hard massive rhyolite

white giant pumice

brown rhyolite, obsidian banding perlitic

N50°W

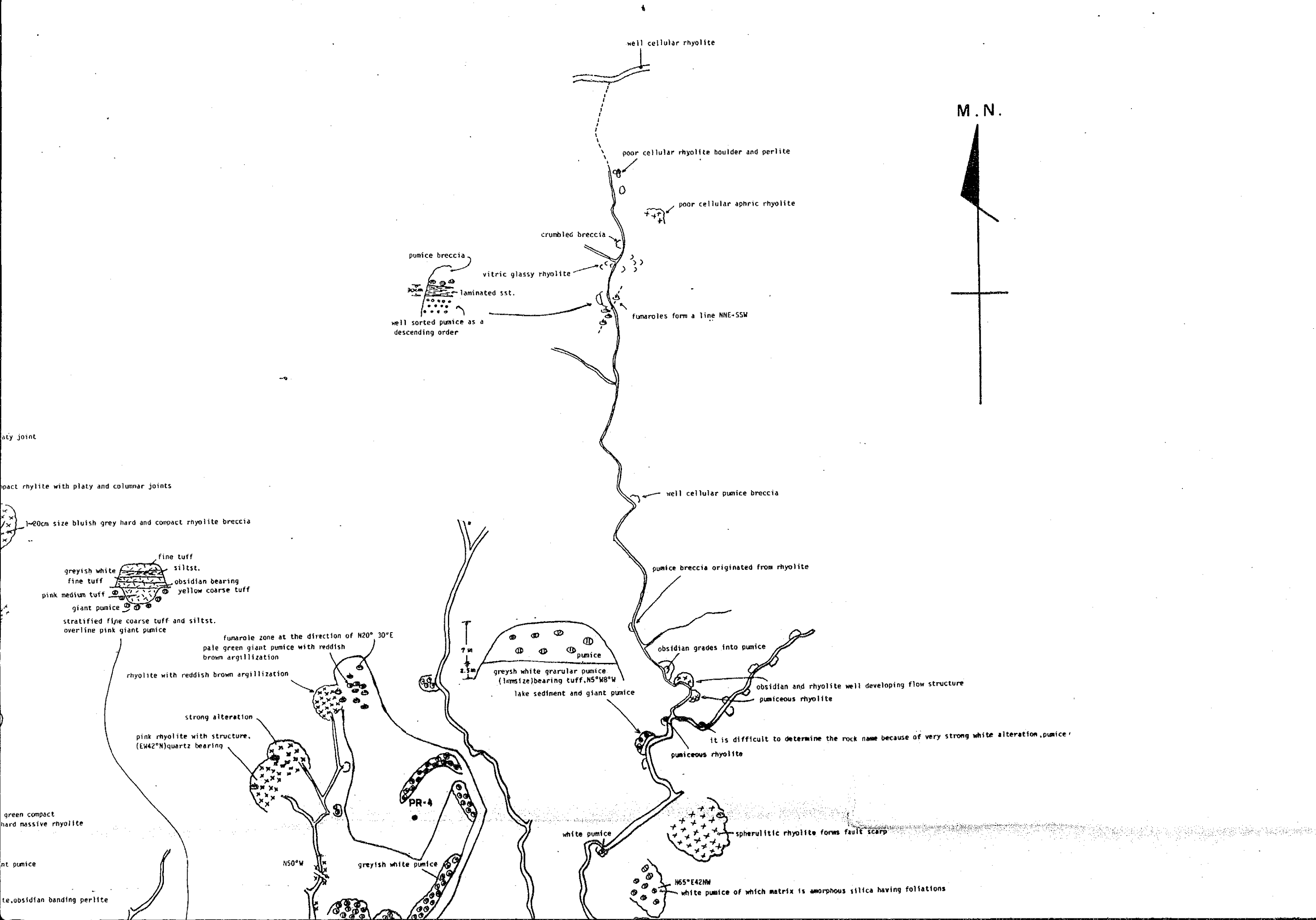









tuffaceous fine sand and pumice  
 brown coarse medium sand  
 gray fine massive tuff  
 reddish gray pumice tuff  
 the lower part grade into up word

