

PANAMPU RIVER

NO 00-04

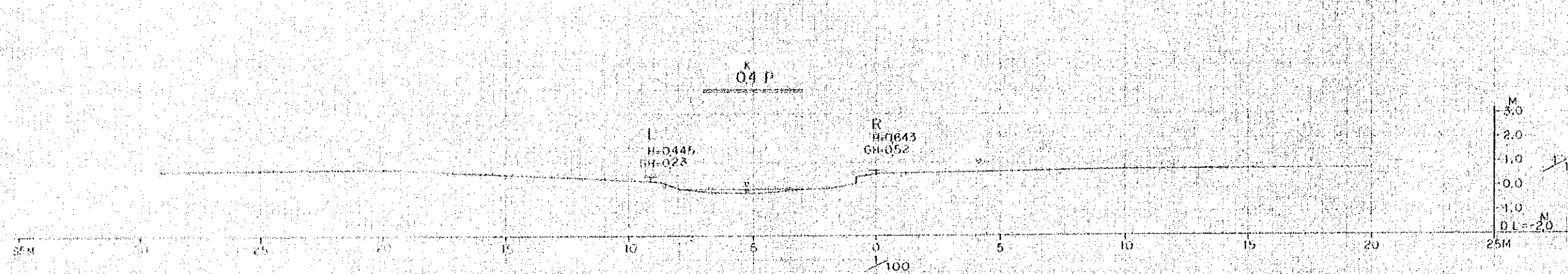

PANAMPI RIVER
NO 05-09

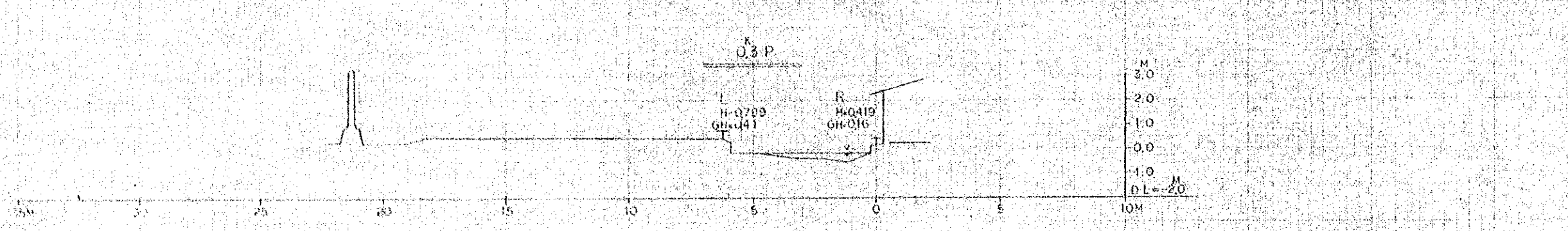
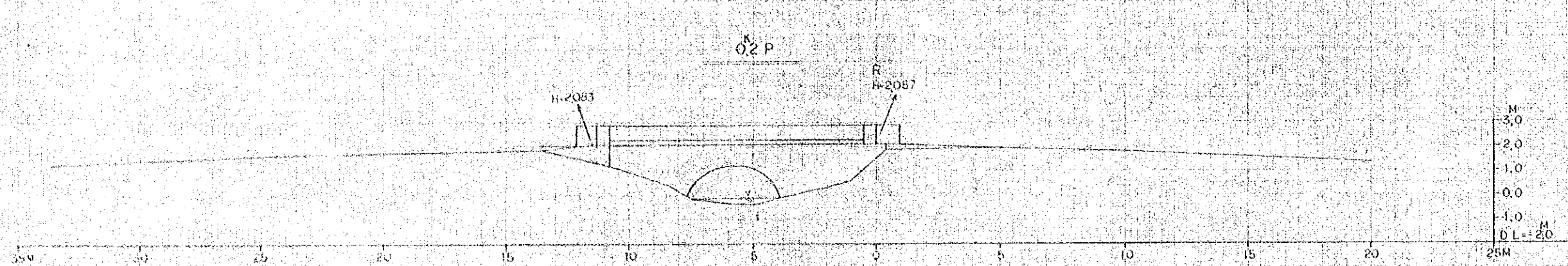
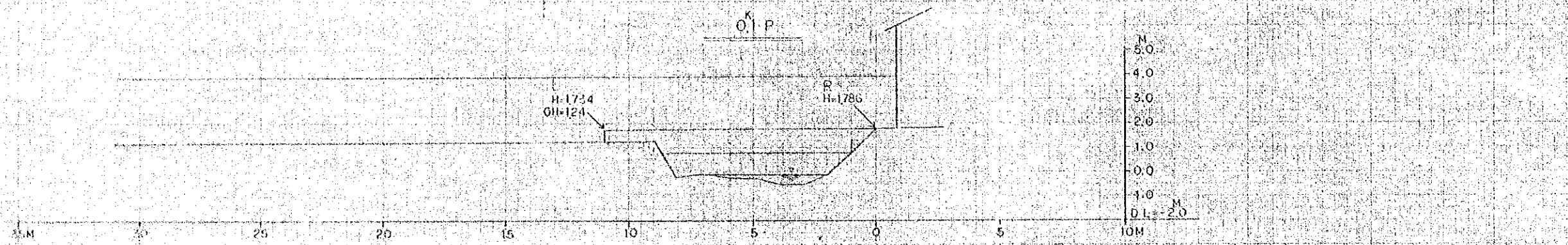
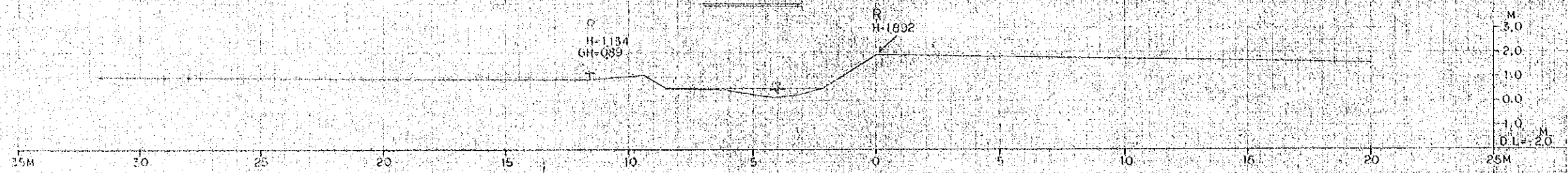
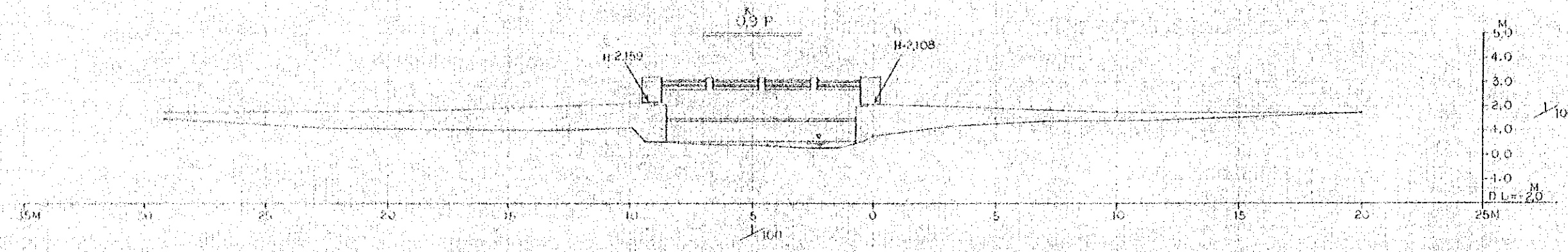
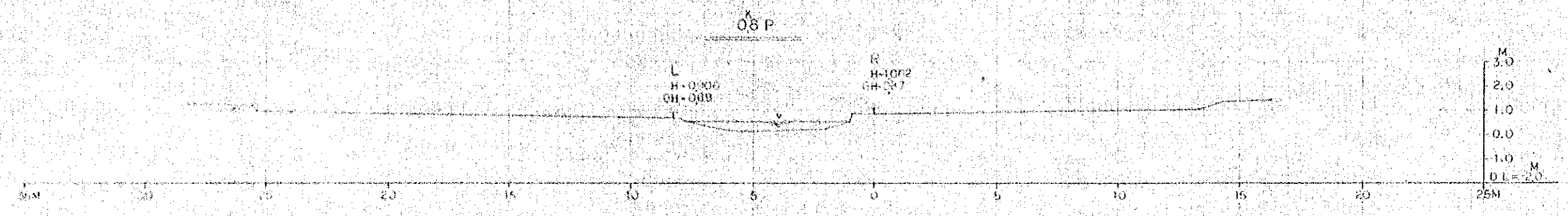
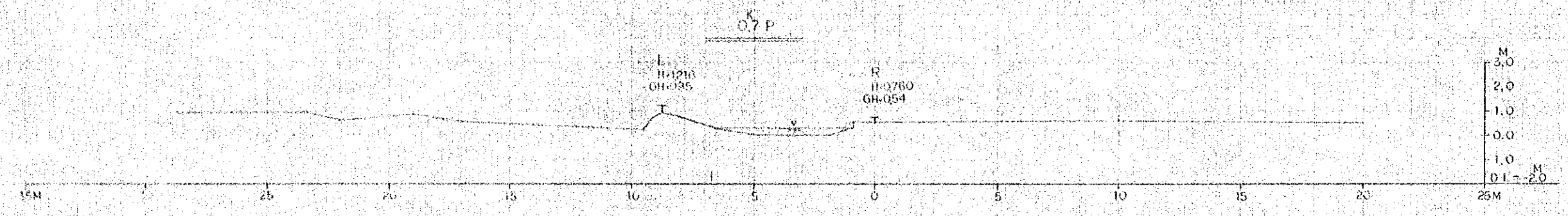
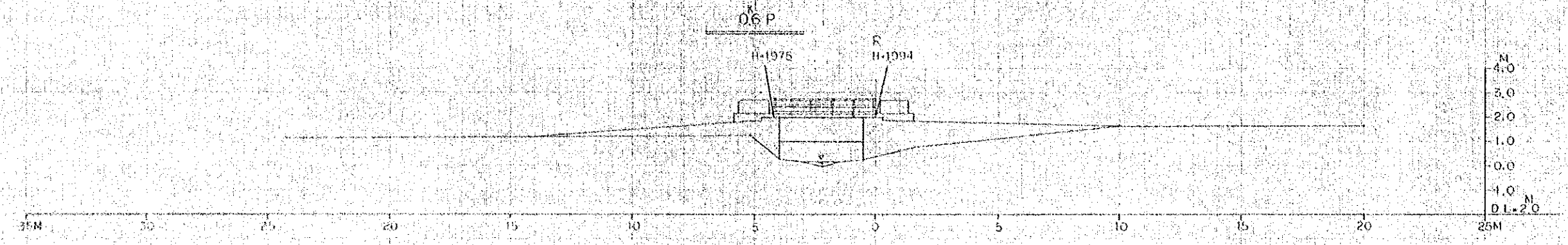
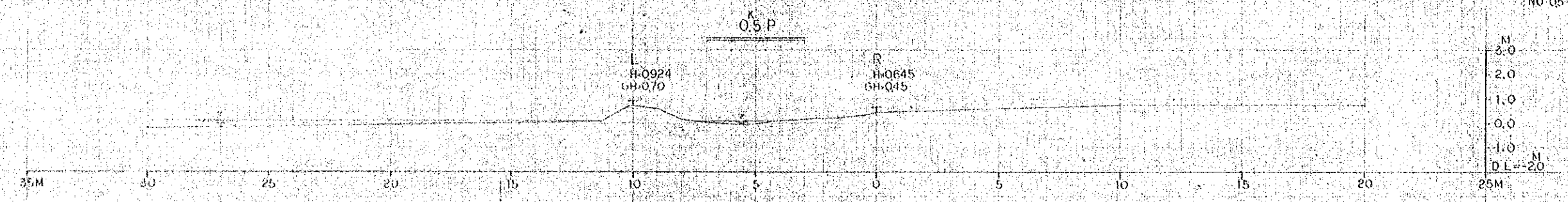

PANAMPU RIVER
NO. 10-11

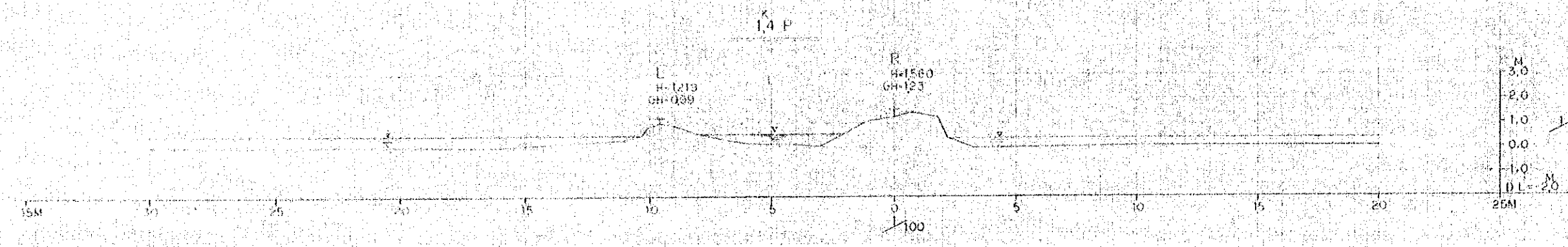
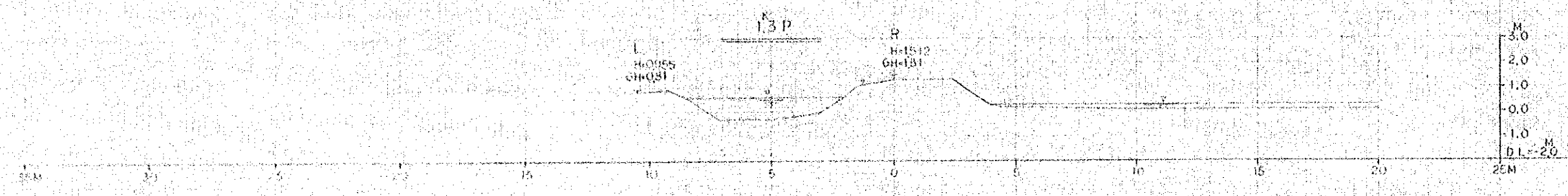
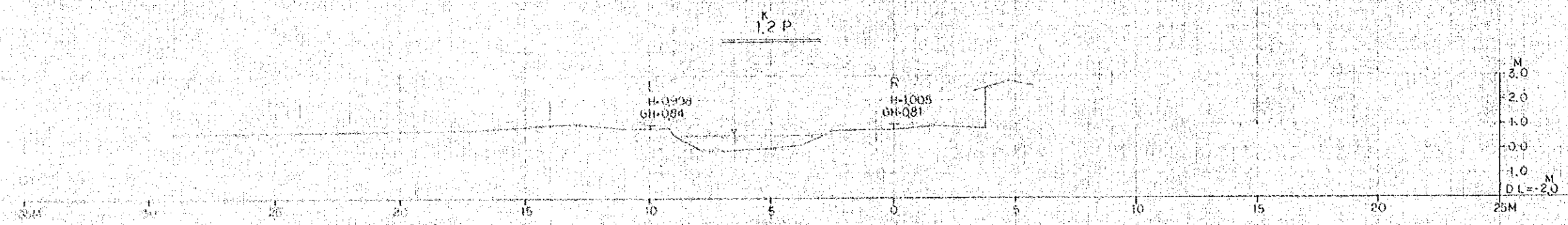
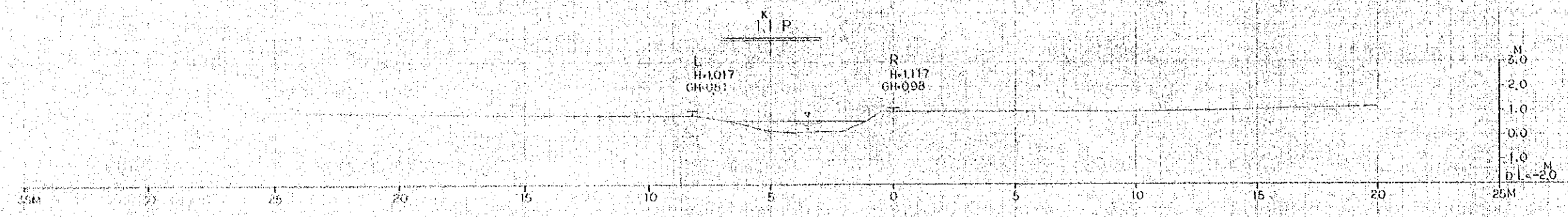
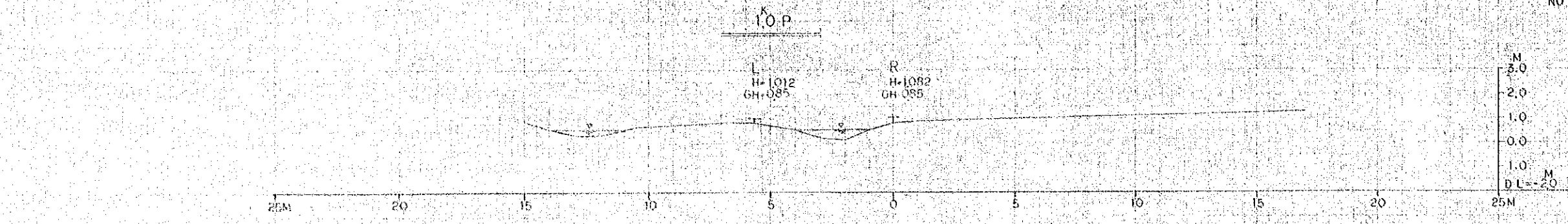

PANAMPU RIVER

NO. 15-19

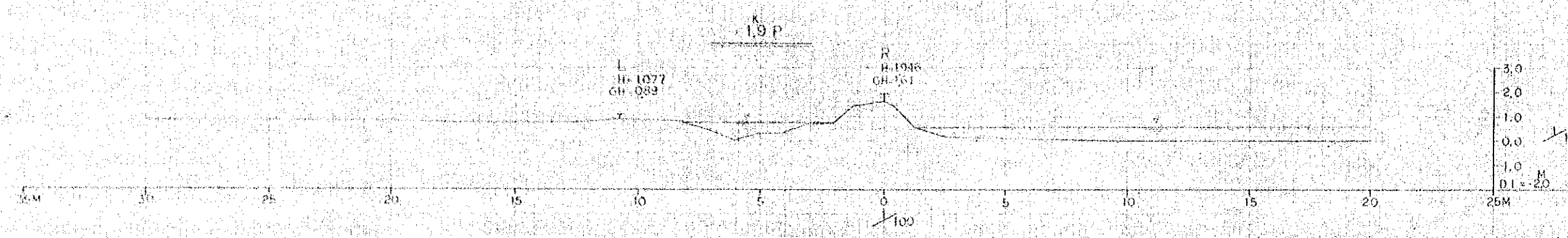
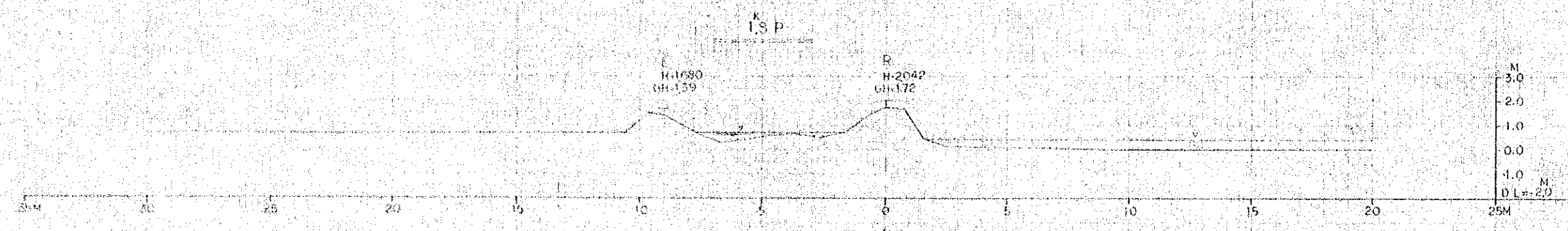
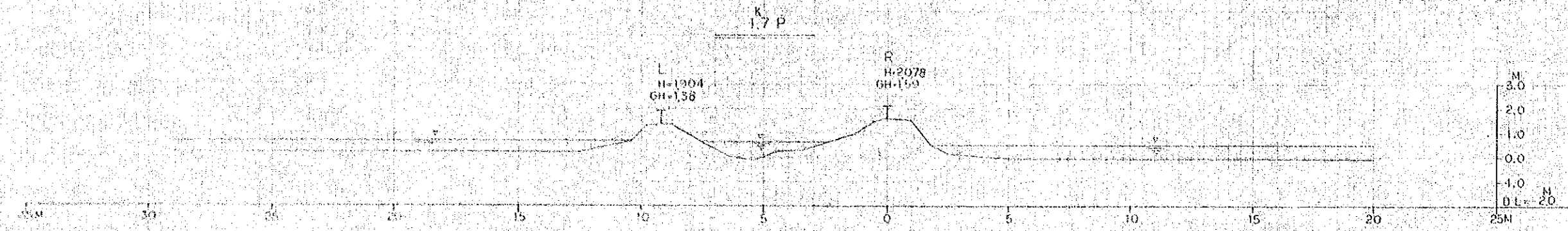
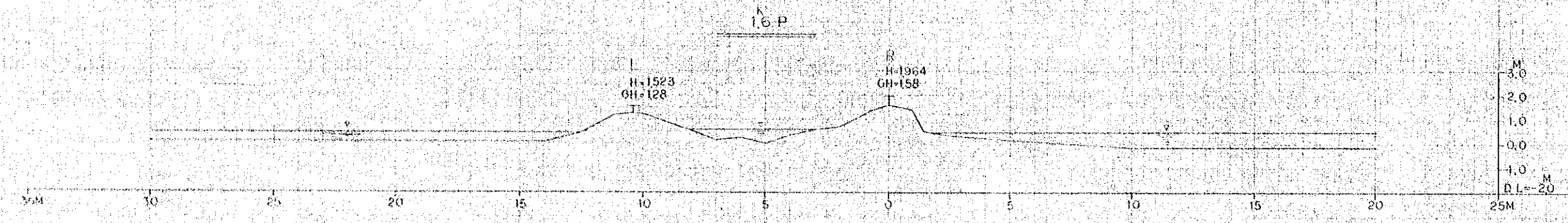
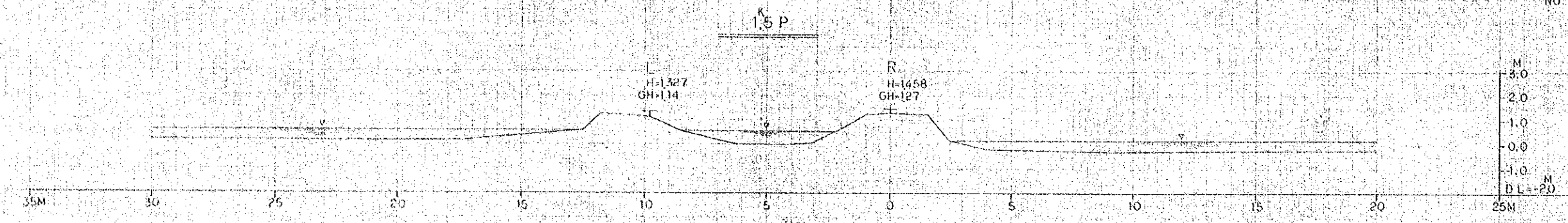

PANAMPU RIVER

NO 20-24

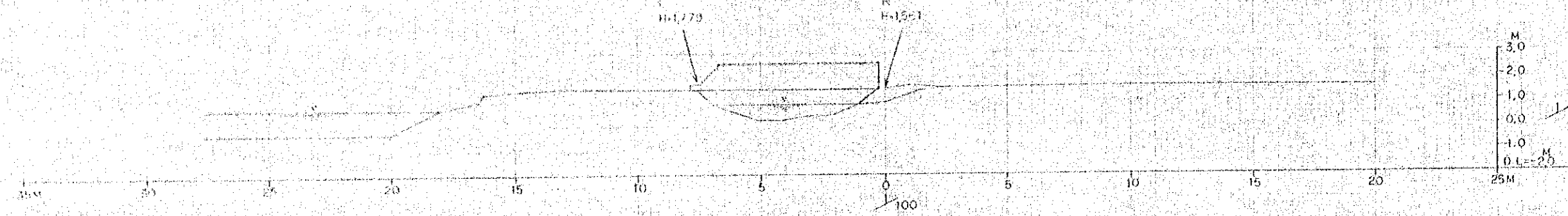
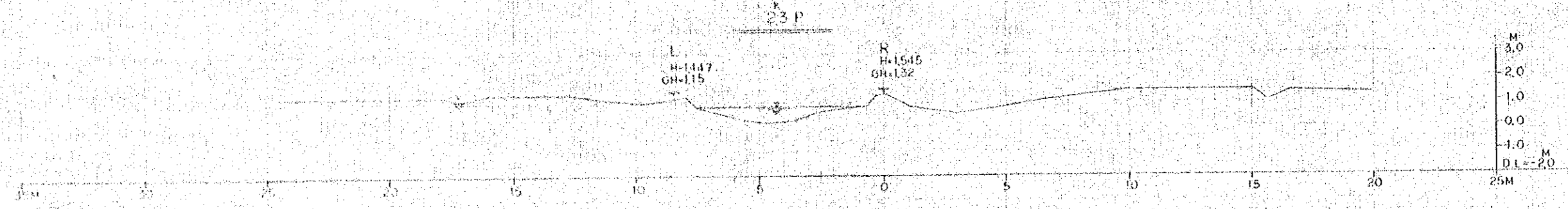
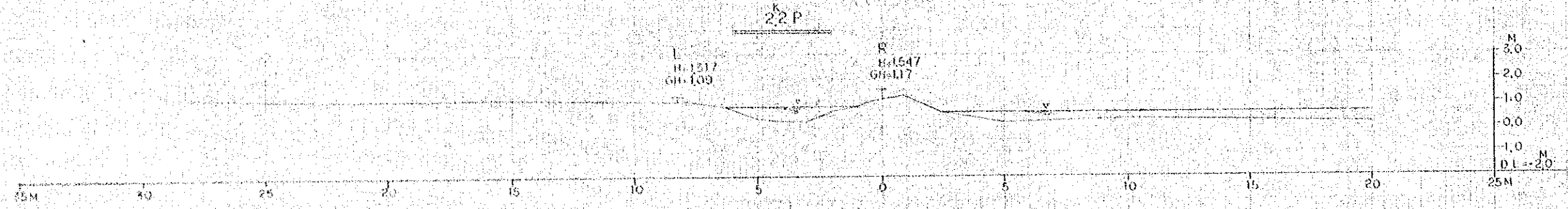
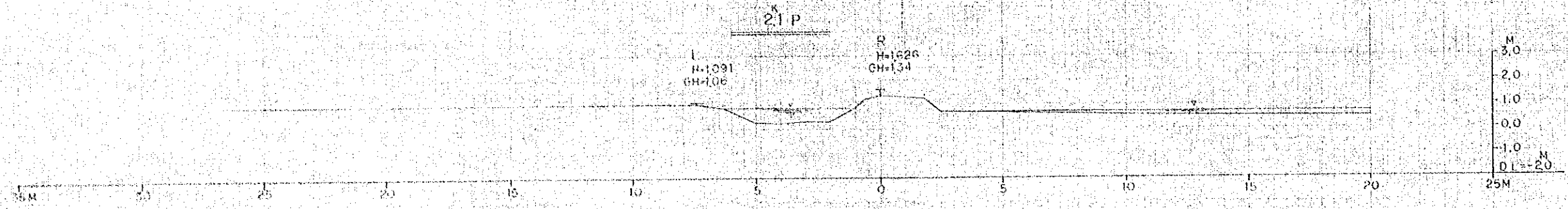
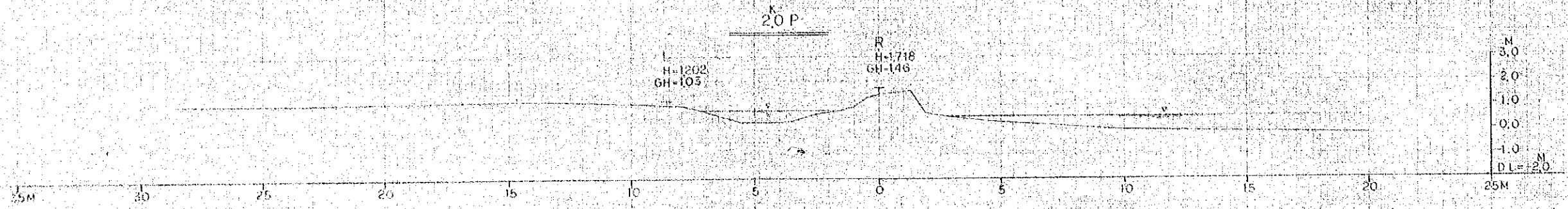

(1)

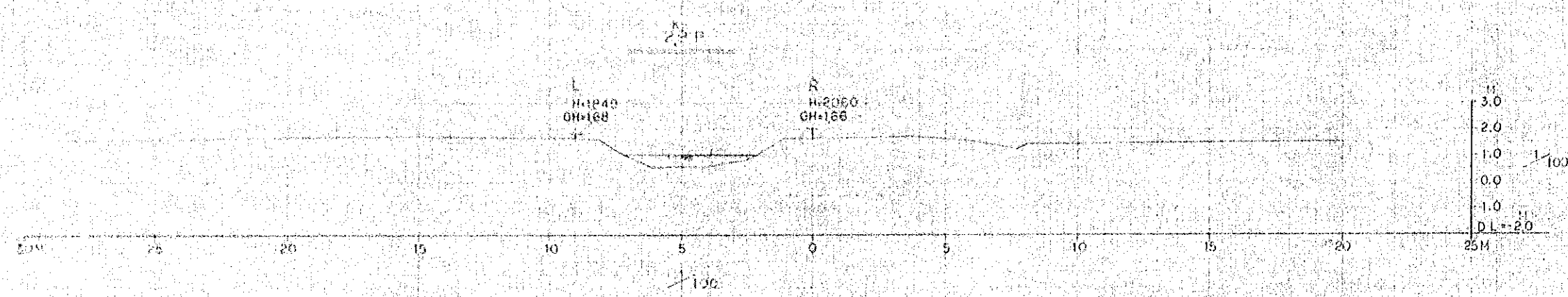
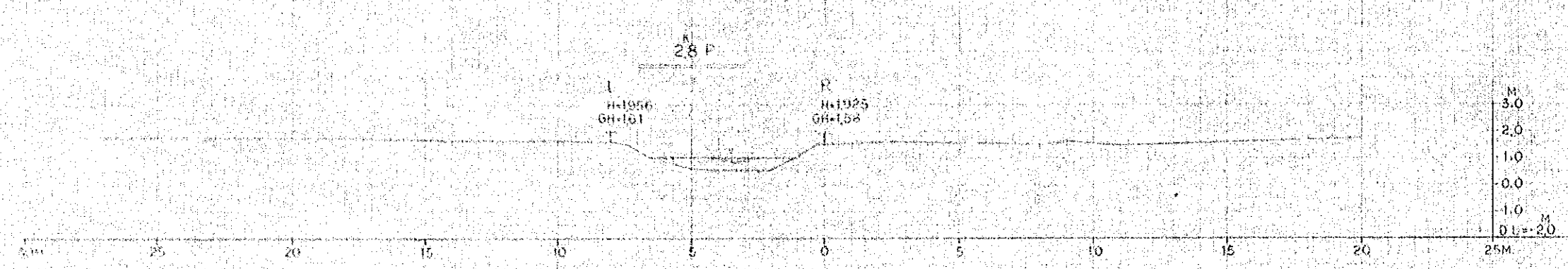
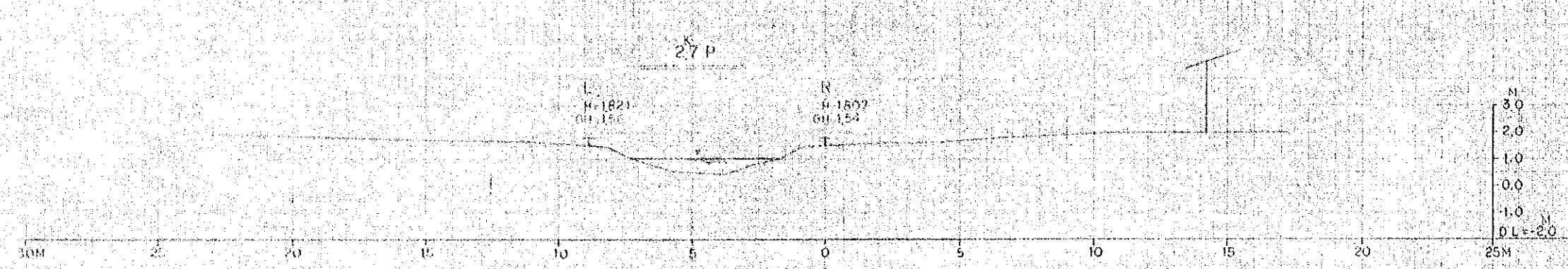
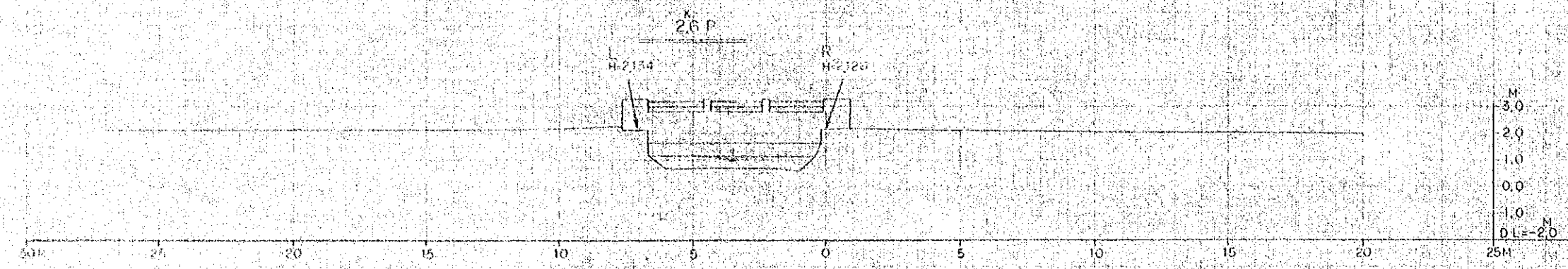
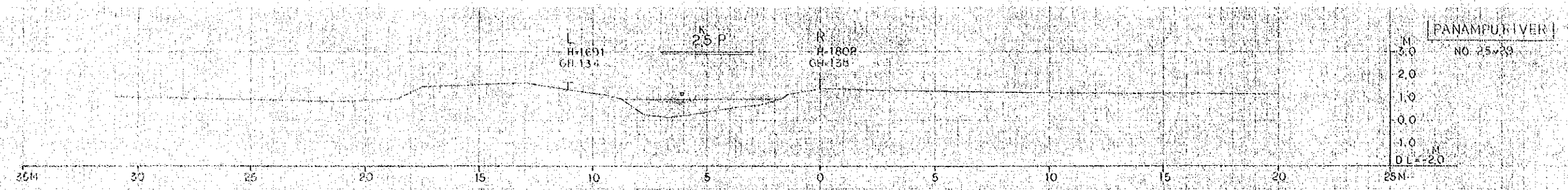

PANAMPU RIVER
NO. 30~34

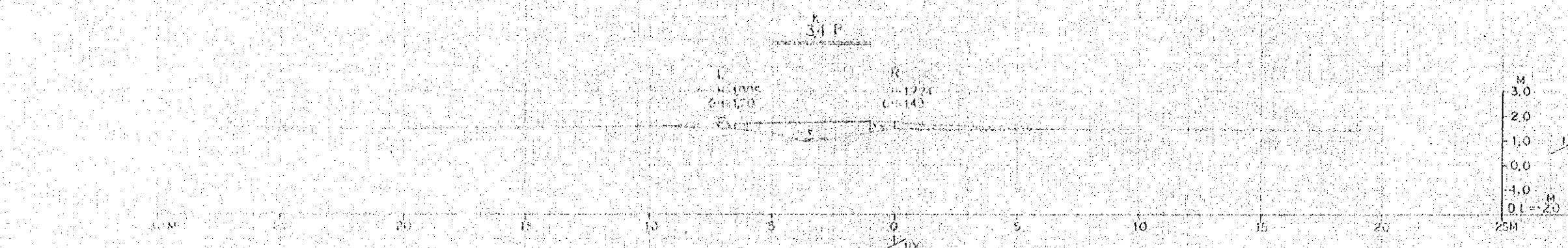
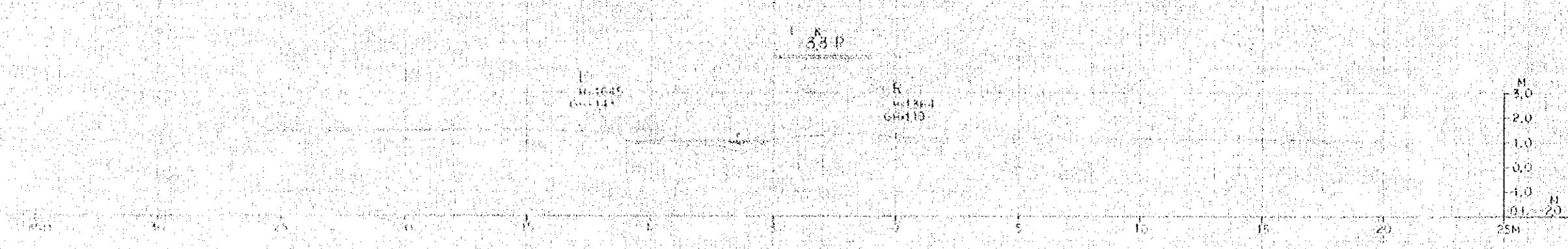
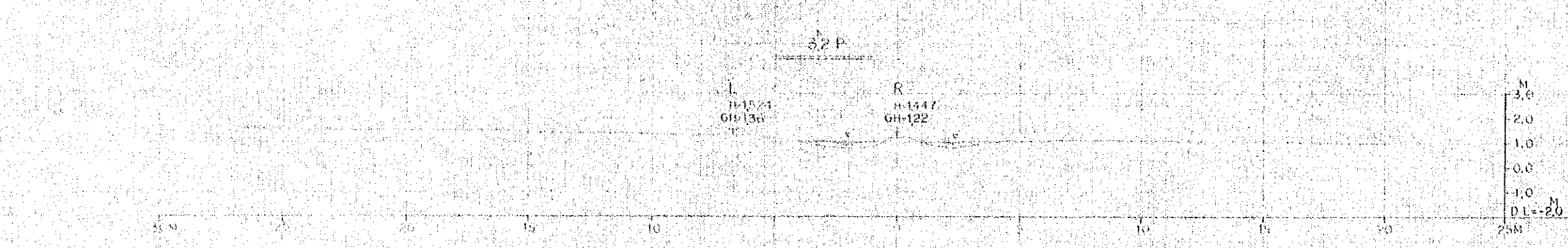
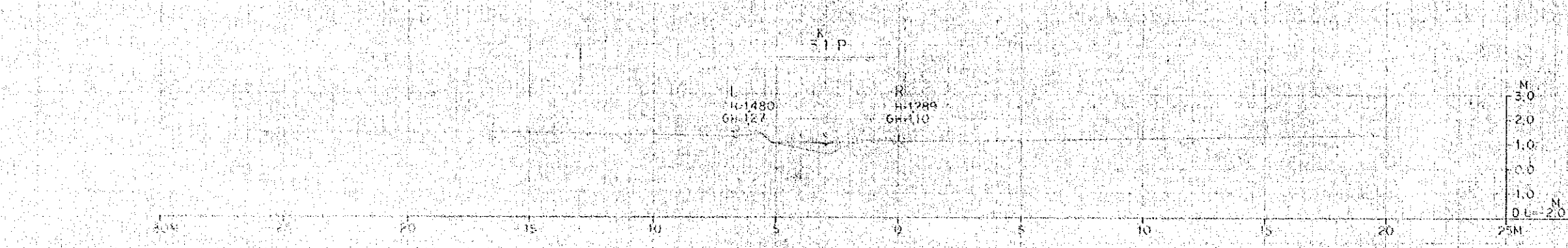
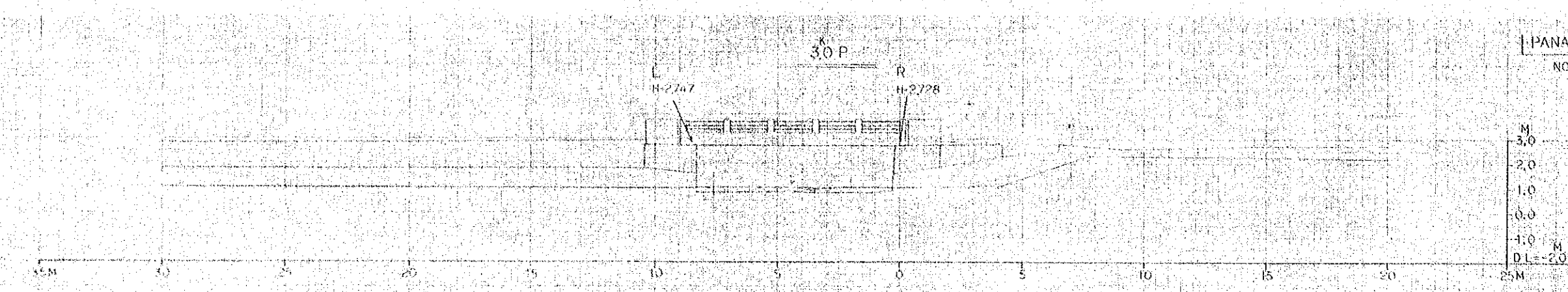

(1)
(1)

PANAMPU RIVER

NO. 35-39

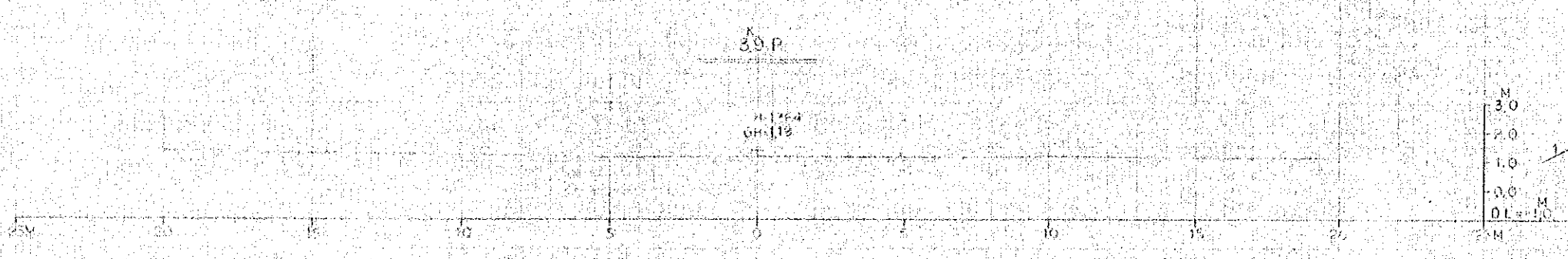
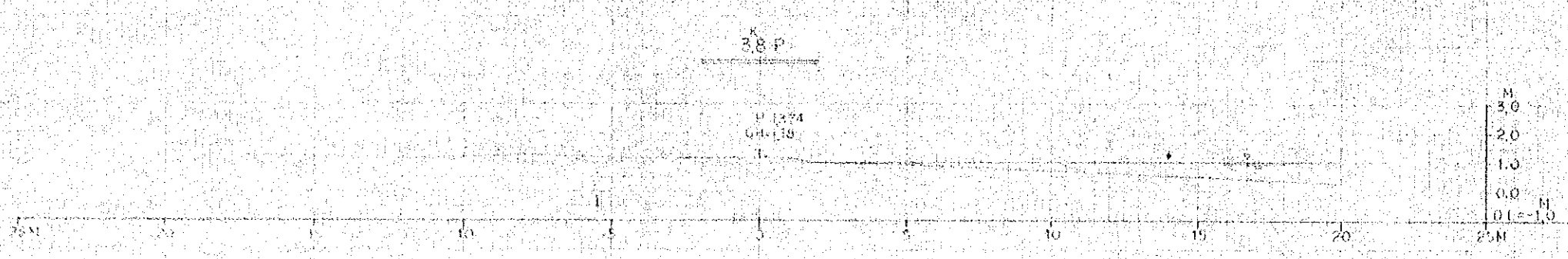
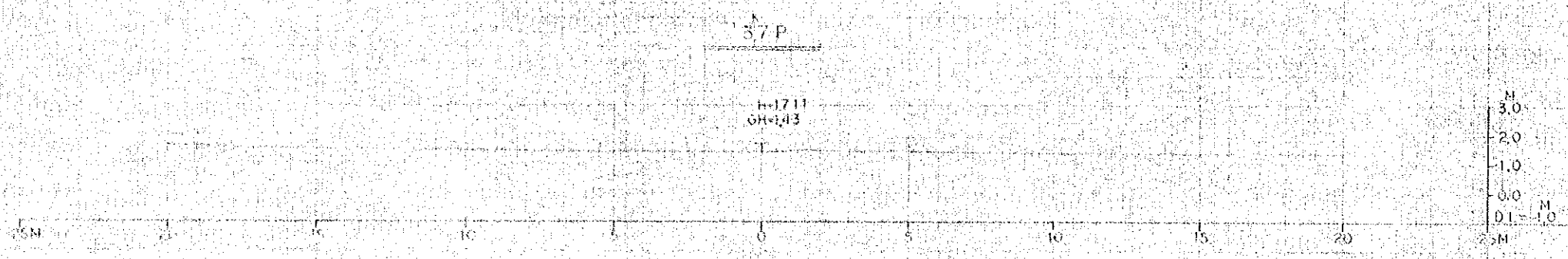
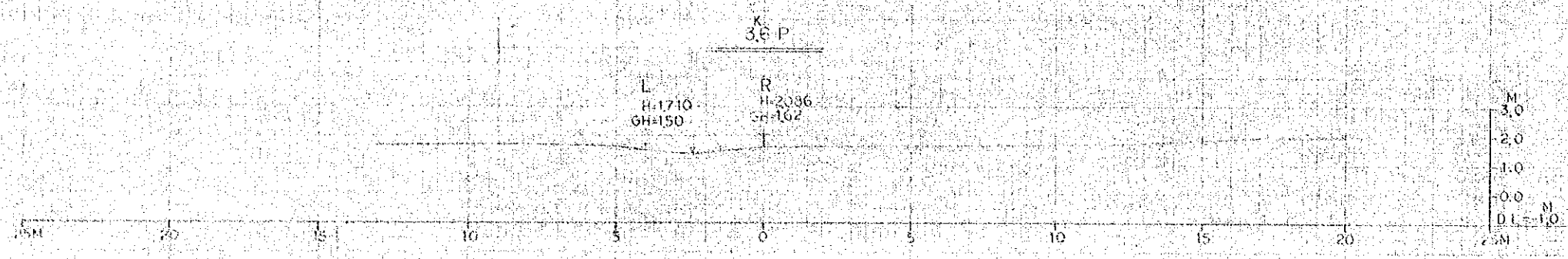
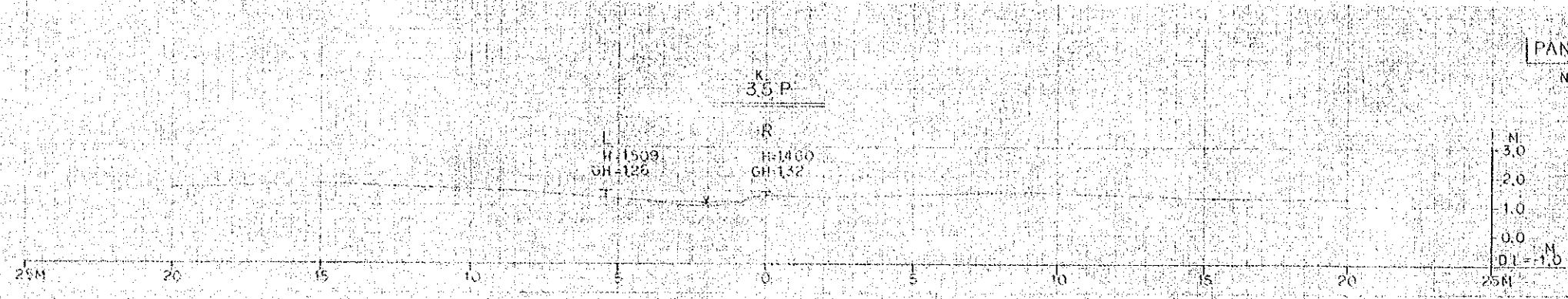

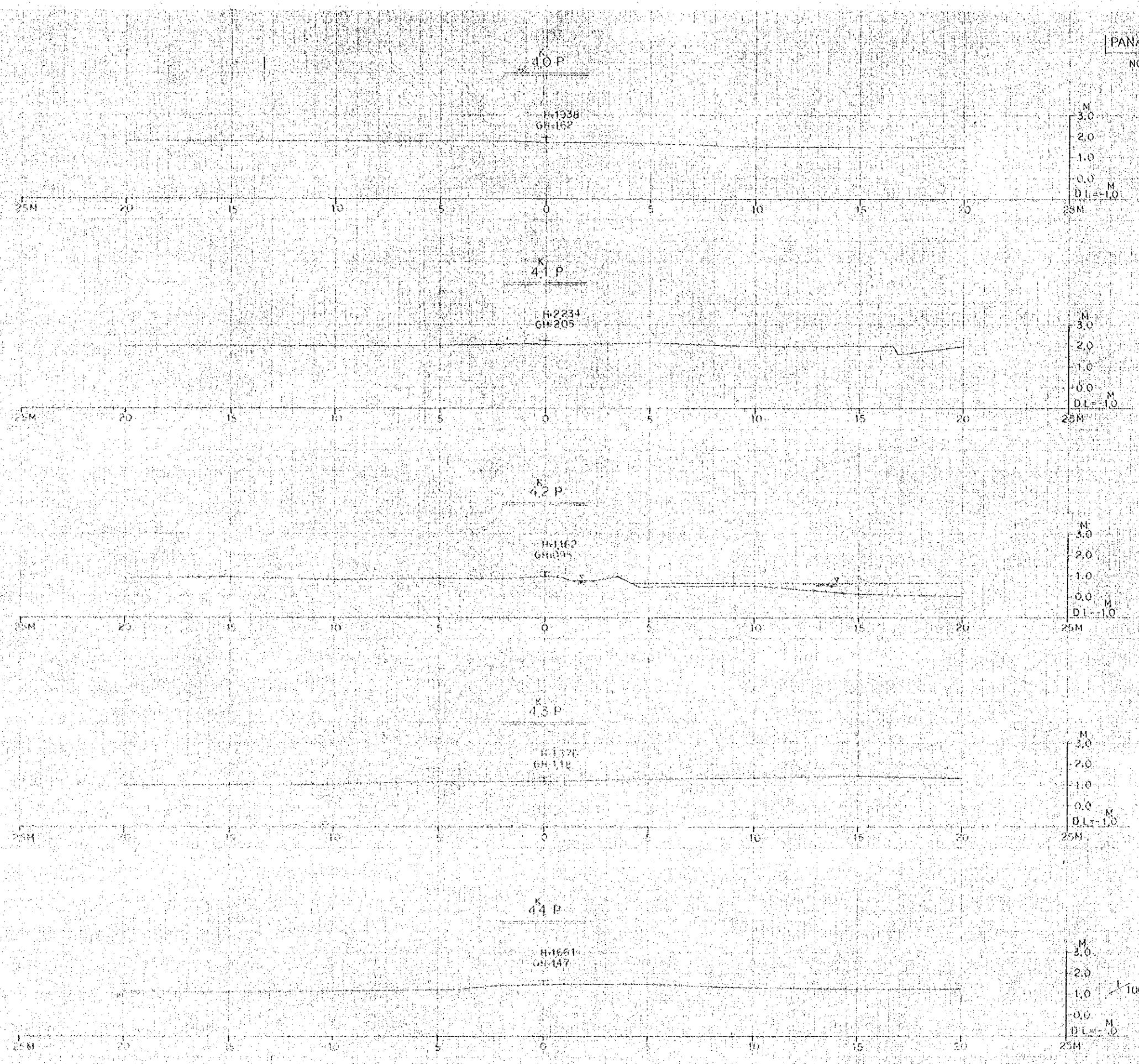

LONGITUDINAL PROFILE OF PAMPANG RIVER

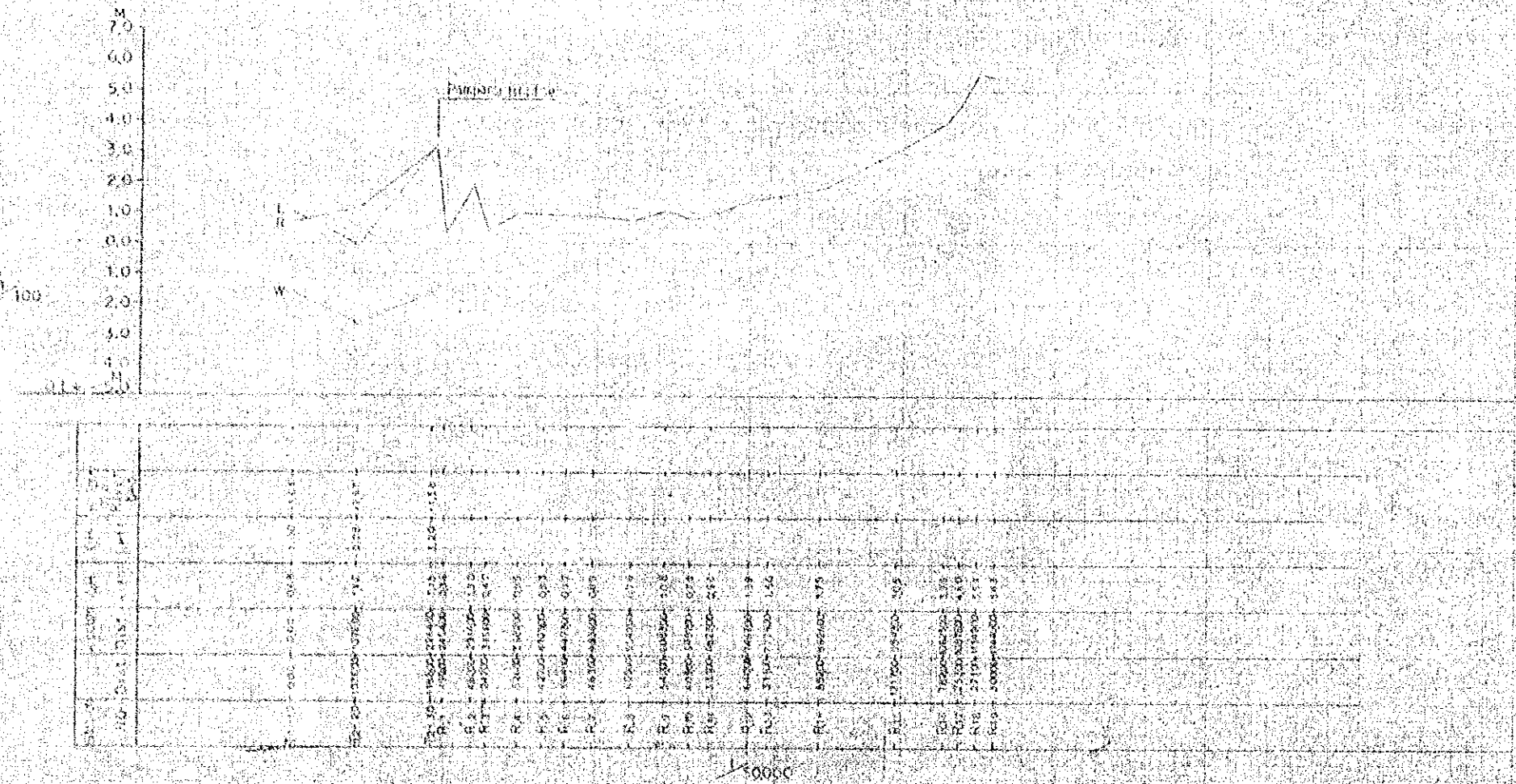

Stationing	Profile	W
0+00	0.00	0.00
100	0.50	0.50
200	1.00	1.00
300	1.50	1.50
400	2.00	2.00
500	2.50	2.50
600	3.00	3.00
700	3.50	3.50
800	4.00	4.00
900	4.50	4.50
0+000	5.00	5.00

PAMPNG RIVER
NO. 10/30

