

FIG. 13 LOCATION OF FARM POND.

FIG. 14. CONSOLIDATION PROJECT AREA

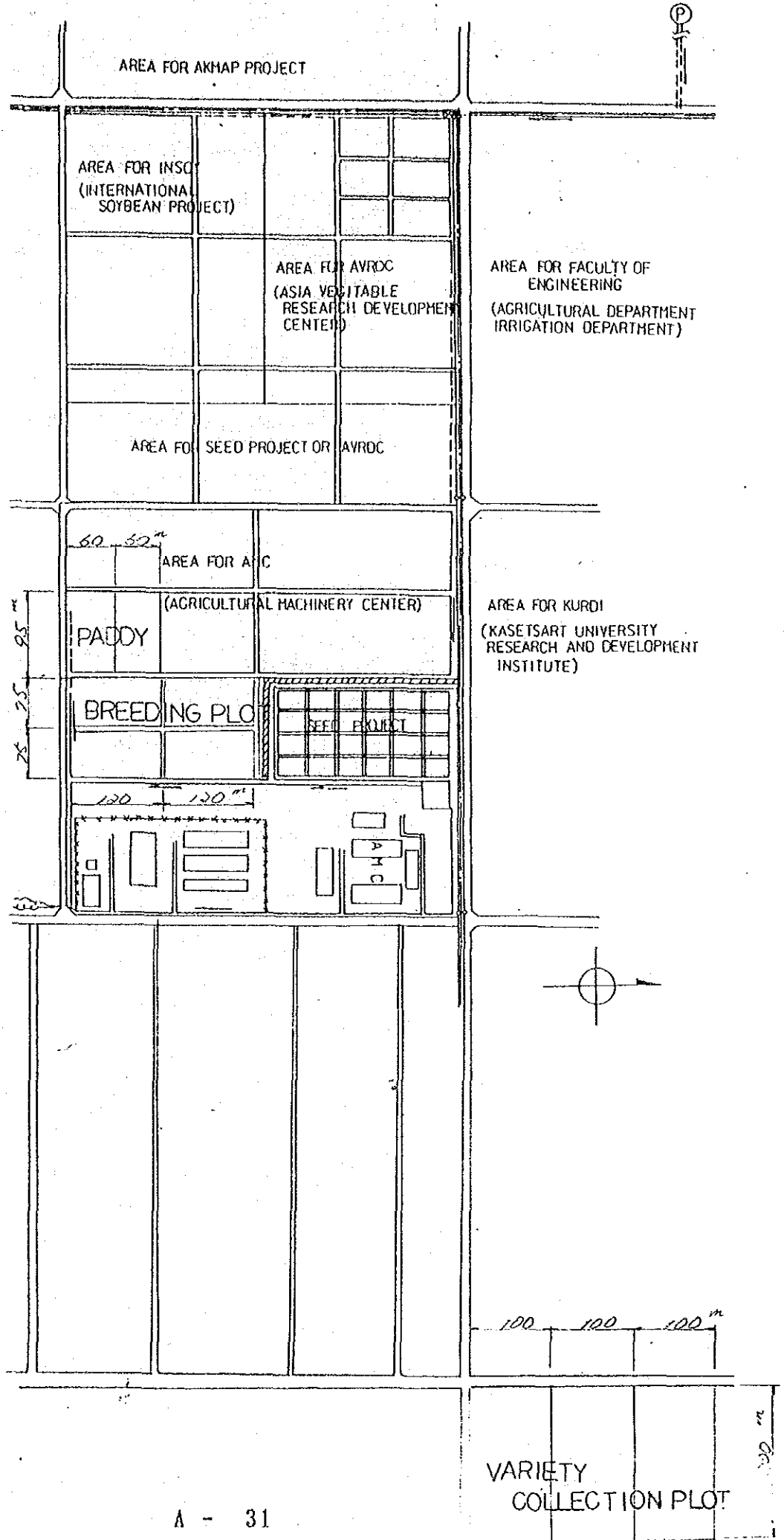
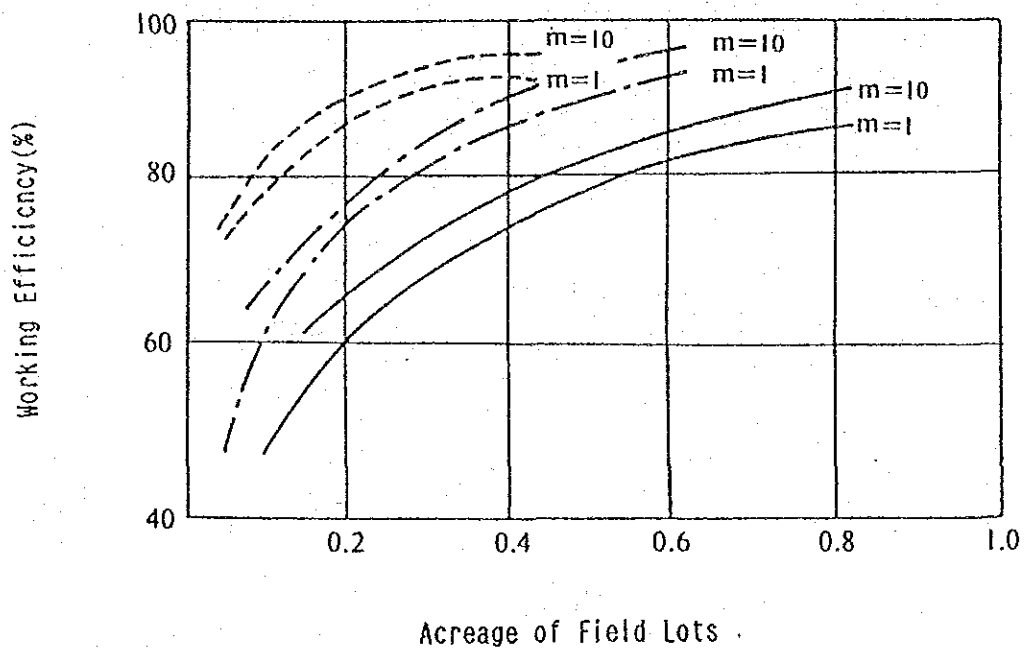

Fig.15 Working Efficiency and Length of Run of Field Lots



- Small-size tractor+0.5m Rotary
- . - . - . Medium-size tractor+1.0m Rotary
- Large-size tractor+1.5m Rotary

Ⓟ
Pipe line

Fig. 16 Plane of study area
Scale 1:500

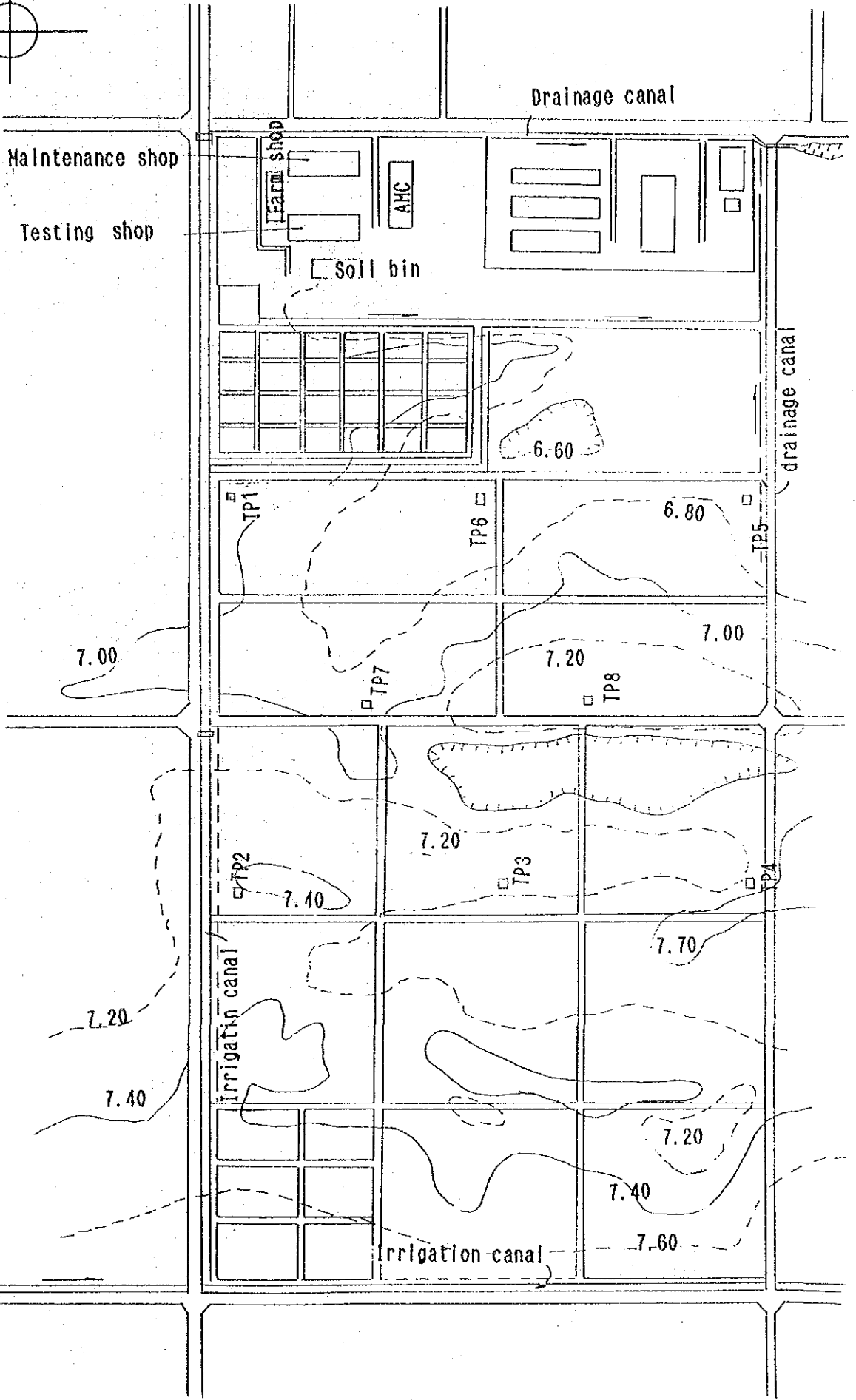
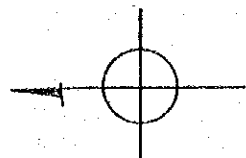
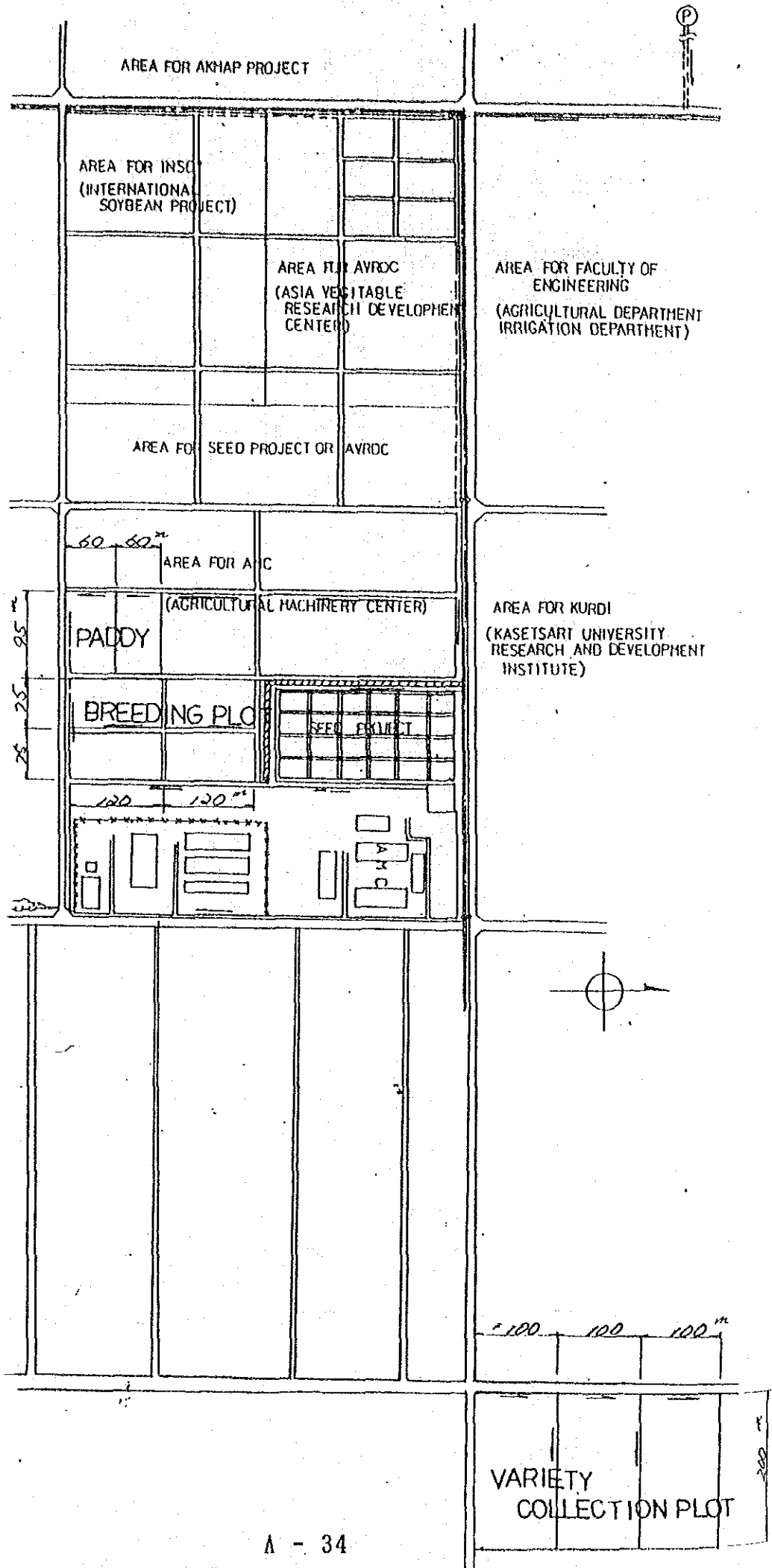

FIG. 17. IRRIGATION PLANS



A4 NO. 349 C

100

MAXIMUM DAILY RAINFALL IN A YEAR

Date	Max Rainfall (mm/day)
1973. 3. Oct	81.3
1974. 9. Oct	68.8
1975. 29. Sep	57.8
1976. 6. May	74.5
1977. 19. Apr	49.2
1978. 3. Jun	147.4
1979. 24. Apr	86.9
1980. 1. Jun	70.1
1981. 17. Nov	65.6
1982. 11. Sep	74.4
1983. 15. Oct	78.2
1984. 15. May	63.3
1985. 11. Jun	115.6
1986. 28. Oct	79.4
1987. 27. Nov	71.1

FIG. 18 PROBABILITY ANALYSIS

Return Period (year)

2
5
10
20
100

Rainfall (mm/day)

10 50 100 200

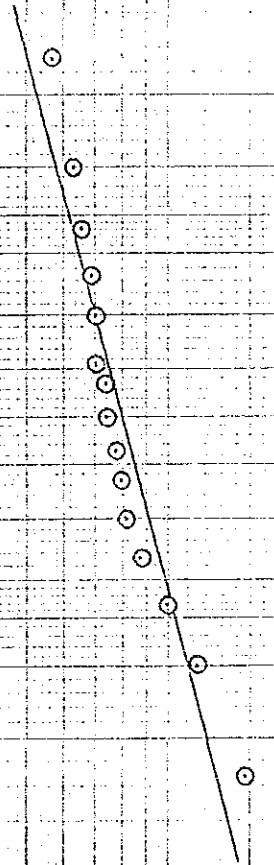

$$100F = 100 \int_0^{\log x} u \, dF(u) = 100F(100) - 100 \int_0^{\log x} u \, dF(u) = \frac{1}{2} (\log x)^2 + \dots$$

A - 25

FIG. 19. DRAINAG PLANS

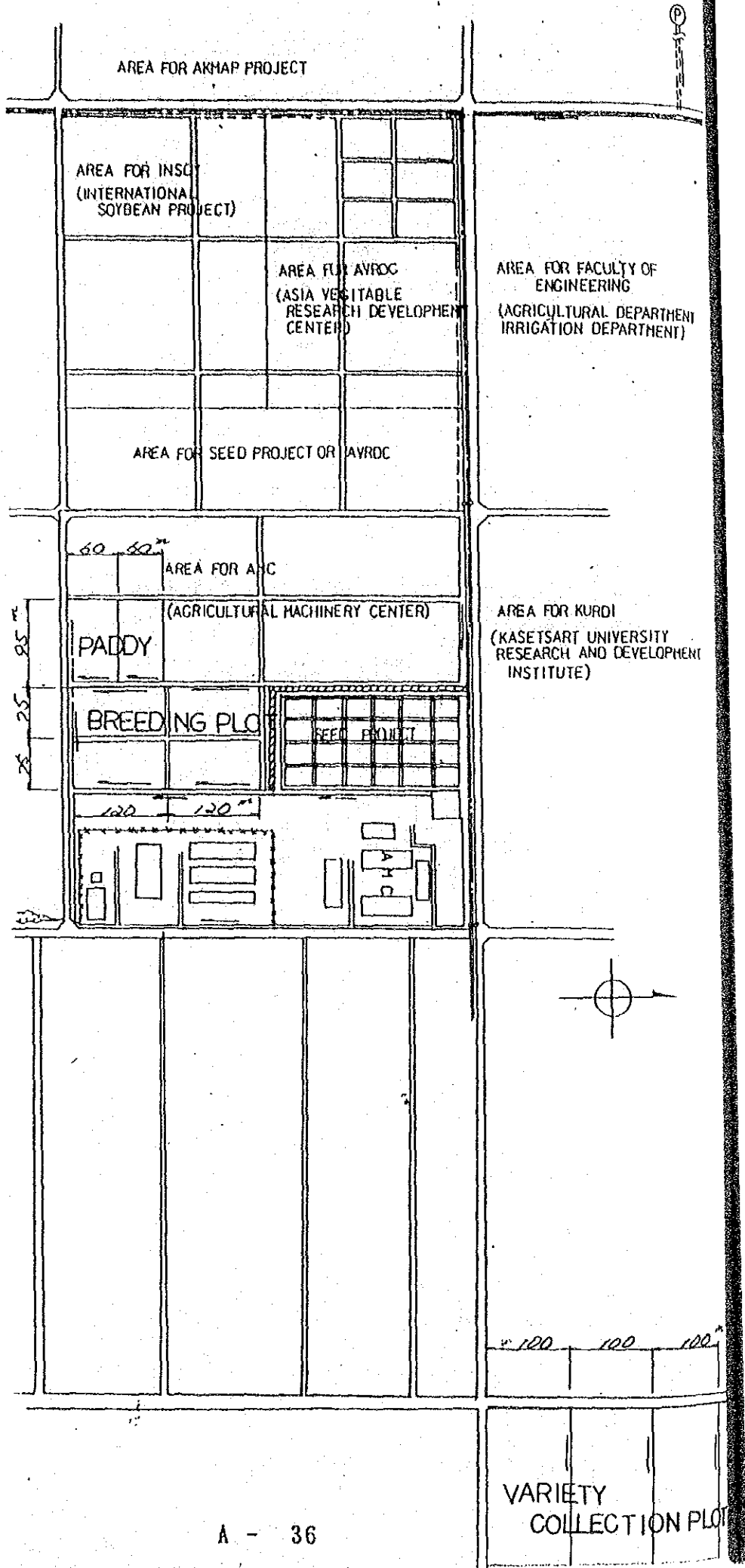

AREA FOR AKMAP PROJECT

AREA FOR INSOY
(INTERNATIONAL
SOYBEAN PROJECT)

AREA FOR AVROG
(ASIA VEGETABLE
RESEARCH DEVELOPMENT
CENTER)

AREA FOR FACULTY OF
ENGINEERING
(AGRICULTURAL DEPARTMENT
IRRIGATION DEPARTMENT)

AREA FOR SEED PROJECT OR AVROG

60 60'
AREA FOR A.M.C
(AGRICULTURAL MACHINERY CENTER)

AREA FOR KURDI
(KASETSART UNIVERSITY
RESEARCH AND DEVELOPMENT
INSTITUTE)

PADDY

BREEDING PLOT

SEED PROJECT

120 120'

100 100 100'

VARIETY
COLLECTION PLOT

FIG 20 DRAINAGE CANAL STANDARD CROSS SECTION

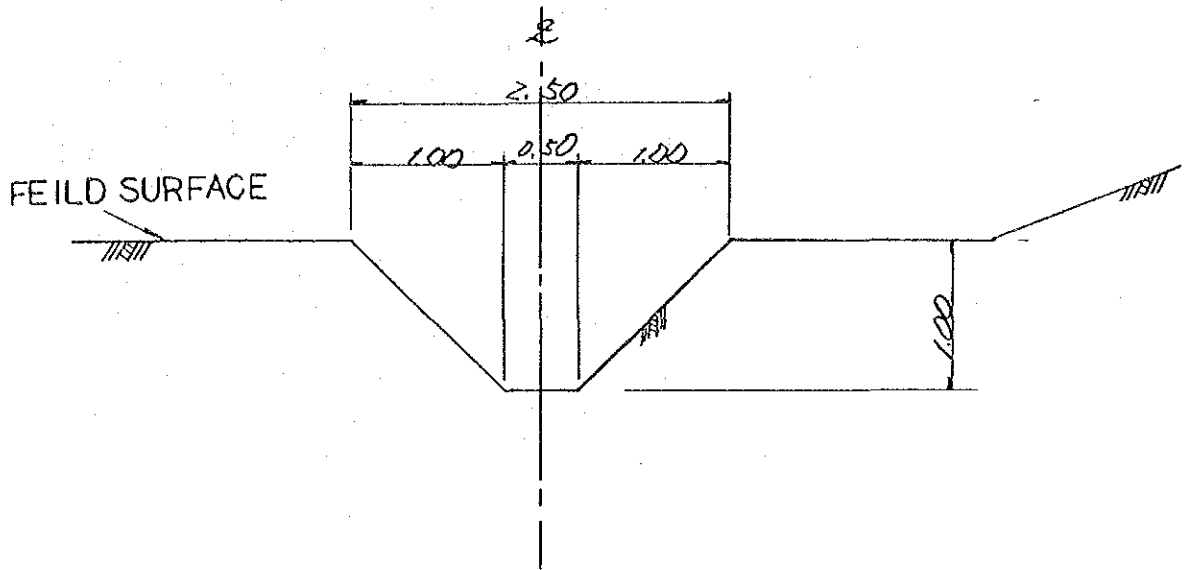
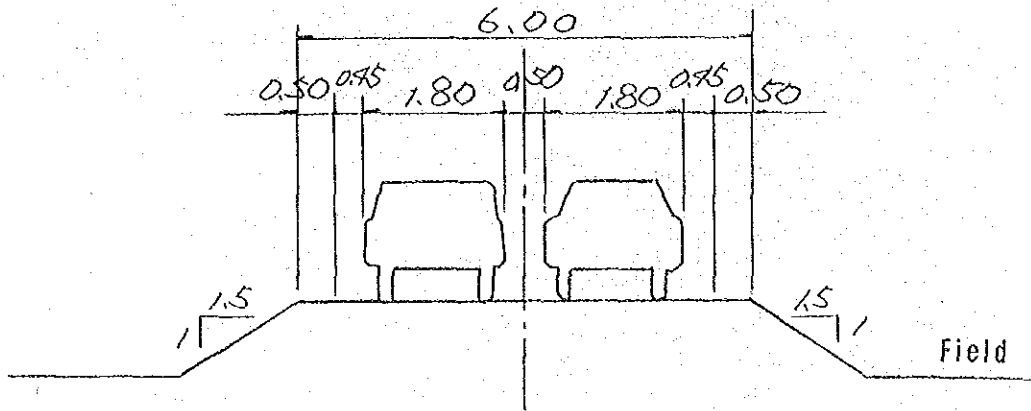
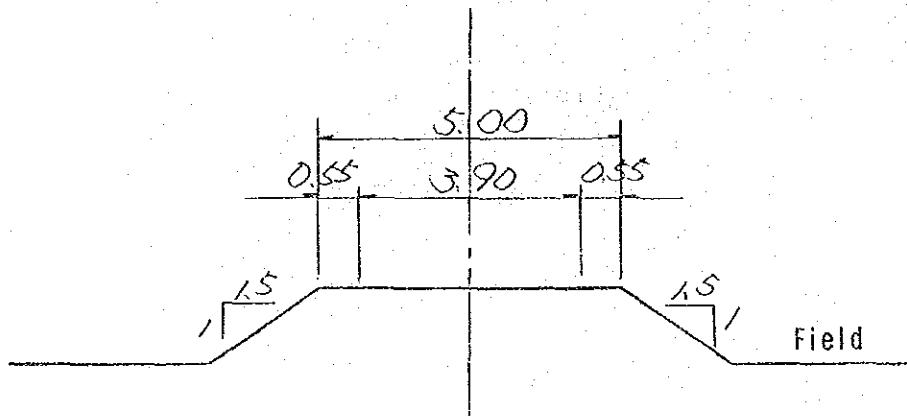

Fig. 21 FARM ROAD STANDARD CROSS SECTION



TRUNK ROADS



LATERAL ROADS

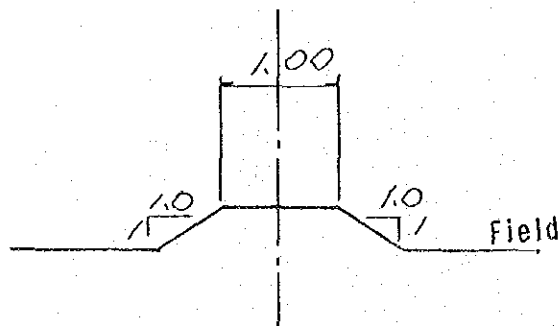

BRANCH ROADS

Ⅲ. 工事会社の選択基礎資料

本工事を遂行する施工会社を選定するため、下記の7社について基礎資料を収集した。

1. THAI OHBAYASHI CORPORATION LTD.
2. THAI TAKENAKA INTERNATIONAL LTD.
3. THAI JAPAN CONSTRUCTION CO.LTD.
4. THAI SUMICON CO.LTD.
5. THAI KONOIKE CONSTRUCTION CO.LTD.
6. AMORNWITHAYA LTD.PART.
7. S.POWER CONSTRUCTION CO.LTD.

これらの各施行会社は、タイ国では中堅クラスで本工事内容を十分理解でき、技術的信頼のおけるものと判断できる。各会社の代表者、住所等を次頁に示す。

施 工 業 者 リ ス ト

MAME	DIRECTOR	ADDRESS	Tel
1. THAI OHBAYASHI CORPORATION LTD.	松井 家弘	3rd. Floor, Thaniya Bldg. 62 Silom Road, Bangkok, Thailand	236-8050~4
2. THAI TAKENAKA INTERNATIONAL LTD.	Boonchitra keterainark	Boonmitr Bldg. 5th Floor, 138 Silom Road, Bangkok, Thailand	233-3337
3. THAI JAPAN CONSTRUCTION CO. LTD.	林 五十鈴	4rd Floor of Chong kolnee Building 56 Surawongse Road, Bangkok, Thailand	233-6115
4. THAI SUMICON CO. LTD.	田丸 達彦	3rd Floor, Olympia Thai Building, 958 Rama IV Road, Bangkok, Thailand	234-0772
5. THAI KONOIKE CONSTRUCTION CO. LTD.	小川 光	10th Floor, Silom Building 197-1 Silom Road, Bangkok, Thailand	233-2156
6. AMORNWITTHAYA LTD. PART.	Nichai	14/25 Srinakarin Road, Pakanhong, Bangkok	398-5231
7. S. POWER CONSTRUCTION CO. LTD.	Prasert	65 Linchee Road, Yanawa, Bangkok 10120	266-9500

SUMMARY REPORT

JAPAN INTERNATIONAL COOPERATION AGENCY (JICA)

BANGKOK OFFICE

September 15, 1988

Dr. Thira Sutabutra
Project Manager,
KU - Japan Project

Subject : Field Report of the Detail Design Survey for the Strengthening
Research Activities (Phase II) Project at Kasetsart University

Dear Sir,

We have pleasure of submitting herewith for your review and acceptance this field report of the detail design and survey for the Phase II Project.

Special consideration has been given in preparing this reports to exchange views and to have a series of discussions with Thai Authorities and Short Term Experts who were dispatched by JICA and stayed in Kamphaengsaen Campus of Kasetsart University from August 9th to September 10th in 1988.

This report presents the outline of the detail design of the farm land consolidation and the facilities which are considered to be necessary for the Project.

On the basis of the results of field investigation and after subsequent study in Japan, final report of the detail design survey for the project will be submitted on November, 1988. Scope of construction area and facilities will be finally determined by JICA HDQ in consideration of the above final report and budget for the Model Infrastructure construction work.

We express our deep appreciations for your kind cooperations.

Yours Sincerely

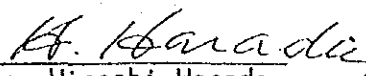
Dr. Hiroshi Harada
Team Leader
KU - Japan Project

HH/sv

Field Report
of
The Detail Design Survey
for
The Strengthening Research Activities
Phase II Project
at
Kasetsart University

September 15, 1988

JAPAN INTERNATIONAL COOPERATION AGENCY

C O N T E N T S

Preface

CHAPTER I	Field Investigation
I - 1	Location of job site
I - 2	Geology
I - 3	Topographical surveying
I - 4	Soil mechanics and soil test
I - 5	Water quality
I - 6	Meteorology
I - 7	Condition of water delivery
CHAPTER II	Planning of Irrigation Facilities
CHAPTER III	Planning of Drainage Facilities
CHAPTER IV	Outline of The Proposed Construction Work
CHAPTER V	Others

Preface

The Government of Thailand has made request for the technical cooperation of the Japanese Government concerning the Strengthening Research Activities (Phase II) Project at the Central Laboratory & Greenhouse Complex (C.L.G.C.) and the National Agricultural Machinery Center in Kamphaengsaen Campus of Kasetsart University.

Accepting this request, the Japanese Government dispatched the Preliminary Survey Team on October 1986 and then the Implementation Survey Team on April 1987. As a result, the agreement on technical cooperation between both Governments has been concluded.

After that Japan International Cooperation Agency (JICA) received the request for the construction of Model Infrastructure about consolidation of farm lands which are necessary for the research of plant breeding and crop production and for the testing of the agricultural machinery, and moreover about building of net houses which are necessary for the research of tissue culture.

In response to the request, JICA has dispatched the short term experts for detailed design and survey in order to make preparation for construction of the above mentioned facilities.

At the Project Site the team of the experts performed topographical survey, investigation of soil mechanics, soil test, water quality test, collection of meteorological data, and designing the outline of the farm land and facilities required for the Project.

This reports presents the results of these works.

CHAPTER I

I - 1 Location of the job site

The Kamphaengsaen Campus of Kasetsart University is belongs to the Nakhon Pathom Prefecture and locates at about 80 km off, north-west from Bangkok. Its area is 1250 ha. and there are several kinds of farm land and institutions in it.

The experimental farms of this Project to be planned to design are divided into three blocks; one is for the test of agricultural machinery and another are for the research of plant breeding and crop production. (refer to Fig. 1)

I - 2 Geology

The west area of the Central Plain of Thailand consists of four geological parts; old and recent delta zone of Chao Phraya River, calcareous area and tan complex area. (refer to Fig. 2)
Kamphaengsaen Campus is shown at 185 and is situated at 6 - 7 meters above see level.

I - 3 Topographical surveying

In order to get accuracy required for the detail design, topographical surveying was carried out by the specification shown as follows:

- 1) Farm land for crop production
 - i) Area: 3.6 ha
 - ii) Meshed leveling survey
- 2) Farm land for plant breeding
 - i) Area: 6.2 ha
 - ii) Meshed leveling survey

- 3) Paddy field for the testing of the agricultural machinery
 - i) Area: 0.57 ha
 - ii) Meshed leveling survey
 - iii) Profile leveling and cross sectional leveling for the irrigation canal ..

Then topographical maps (scal 1:500) and profile and lateral drawings were completed.

I - 4 Soil mechanics and soil test

I - 4 - 1 Field test

Location of the test pits are shown in Fig. 3. Depth and width of the test pit is 1.6m X 1.6m X 0.8m and additional drilling by hand-auger was also carried out from the bottom A of the test pit.

The result of the investigation of the column section shows that soil about 40cm depth from the ground surface is humus and under humus consists of silty fine sand. Ground water is observed at 1.7m to 1.8m depth and obvious daily variation of its water level cannot be observed.(Fig.4)

I - 4 - 2 Soil test

The items of the soil tests are as follows:

- 1) Specific gravity test (ASTM D854)
- 2) Liquid limit test (ASTM D423)
- 3) Plastic limit test (ASTM D424)
- 4) Grain size analysis (ASTM D422)
- 5) Penmeability test (undisturbed sample)

The soil was sampled at about 80cm depth under A point above mentioned. The results of the tests are shown in Table.1~4 .

Evaluating from "The coefficient of uniformity" and "The coefficient of currature", the soil is poorly graded. From the results of

the liquid and plastic limit test and permeability test, the soil is classified into CL-ML (Silty soils with slight plasticity).

(Table. 5)

I - 5 Water quality

The locations of sampling for the water quality test are shown in Fig. 3 , and result of the tests is shown in Table.6 ~ 9 .

Area	Point	Site	Sort of water
Kamphaengsaen Campus	1	Deep well of Seed Project	ground water
"	2	RID canal	flowing water
"	3	RID canal	flowing water
"	4	Reservoir (RID)	storage water
"	5	CLGC Office	ground water
"	6	Existing farm pond	storage water
"	7	Feed tank	ground water
"	8	Existing farm pond	storage water

According to "United State Department of Agriculture (USDA)", water samples are classified into four groups as shown in Fig. 5 , with respect to sodium hazard depending on the Sodium Adsorption Ratio (SAR) value and the specific conductance. The SAR is defined as:

$$SAR = \frac{Na^+}{\sqrt{(Ca^{++} + Mg^{++})/2}} \quad (USDA)$$

Where, the concentration of the ions is expressed in equivalents per million (epm)

The results of analysis of water samples are summarized below:

Site	Title of Sample	E.C. MMHOS/CM 20°	pH	SAR	Sodium Hazard	Salinity Hazard
Deep well of Seed Project	1	2,050	6.3	30.6	S 4	C 3
RID canal	2	195	6.5	0.05	S 1	C 1
RID canal	3	190	6.6	0.90	S 1	C 1
Reservoir (RID)	4	195	6.6	0.73	S 1	C 1
CLGC Office	5	750	6.7	19.1	S 4	C 3
Existing farm pond	6	1,250	7.1	25.0	S 4	C 3
Feed tank	7	610	7.1	16.4	S 3	C 2
Existing farm pond	8	1,750	7.5	32.9	S 4	C 3

From the above table it can be concluded that

- i) The ground water and existing farm pond are not adoptable for irrigation water resource.
- ii) If the ground water and pond are diluted by the rain water, it may be adoptable for irrigation.

I - 6 Meteorology

I - 6 - 1 Meteorological data

Meteorological data (from 1973 to 1987) was collected from the Meteorological Station situated in the Campus.

Result of analyzing the data is shown in Table.10~20.

I - 6 - 2 Precipitation

From the mean value of monthly rainfall, annual mean rainfall ranges from 1050mm to 1060mm and around 85% of it (900mm) falls in the term from May to October called rainy season.

I - 6 - 3 Wind velocity, Wind direction

From the data (refer to Table.16, 17) mean wind velocity in this area is about 2m/sec. Wind direction pattern is S~SW in May : SW~W from June to September : NE from October to December : NE~SE from January to February : SE~S from March to April.

I - 7 Conditions of water delivery

The water required in the Campus is delivered from RID Canal which is belongs to the Great Mae Klong Project and its water resources are supplied from Vajiralongkon Dam in Kanchana Buri.

The Great Mae Klong Project is separated to the several sub-Project in response to the beneficial areas and the Campus is belongs to the Banglien Project. Because of the insufficient budget, the area of the Banglien Project is almost not yet under constructing but the construction of the canals to the Air Force Base (canal No. 9L-2L) and the Campus (canal No. 6R-2L, 1L-6R-2L) had priority to the others. Consequently these canals have been completed on January in 1986 and water flow has started on December in 1986.

According to the water delivery plan of RID, constant water supply to the Campus will be expected through the year, except the two terms for maintainance and repairing. These terms to cut off the water supply to the Campus are settled under consideration of cropping pattern of the Project area; i.e. one is from the middle of June to the middle of July and another is from the end of December to the early of February.

Therefore, if the cropping pattern of the Campus side is corresponded to the water delivery plan of RID, there will be not so essential problem about these terms of no supply water for about two months and moreover be not necessary especially to use ground water that is said to be unsuitable for plants.

(1) Crop evapotranspiration

a) Potential evapotranspiration (ETo)

Potential evapotranspiration is calculated by the modified Penman method. The climatic data at Kasetsart University was adopted for calculation. The form of equation is as follows:

$$ETo = c \{ W \times Rn + (1-W) \times f(u) \times (ea-ed) \}$$

- Where, ETo : potential evapotranspiration in mm/day
 W : temperature-related weighting factor
 Rn : net radiation in equivalent evaporation
 in mm/day
 f (u) : wind-related function
 (ea-ed) : difference between the saturation vapour
 pressure at mean air temperature and the
 mean actual vapour pressure of the air,
 both in mbar
 c : adjustment factor to compensate for the
 effect of day and night weather conditions

The process of calculation is shown in Table.21 .

As the result of calculation by modified Penman Method, the potential evapotranspiration was evaluated at 6.8mm/day. (Table.21).

b) Crop evapotranspiration (ET crop)

Crop evapotranspiration was calculated by the following formula:

$$\text{Paddy} : ET \text{ crop} = KC \times ETo$$

+ water requirement needed for land preparation and nursery bed.

Field : $ET_{crop} = KC \times ETo$

where, ET_{crop} : crop evapotranspiration in mm/day

ETo : potential evapotranspiration in mm/day

KC : crop coefficient (shown in table.22~23)

Land preparation:

The water requirement for land preparation in paddy field is calculated in the following formula:

$$LP = (1/n) \times SS + (n-1)/n \times PE + SP$$

- Where,
- LP : water requirement for land preparation
 - SS : water requirement for land soaking
150mm/day
 - KC : coefficient for evaporation from muddy or shallow basin of water, 0.7
 - n : number of days for land preparation, 2 days
 - PE : pan evaporation (mm/day)
 - SP : water depth of ponding for transplanting, 75mm (average). It is necessary to keep different water depth on each plot, for the purpose of efficiency test of agricultural machine.

Nursery Water Requirement:

The value of nursery water requirement is not influenced of the peak value of net water requirement, because the area is a little area of compaired with total paddy field.

(2) Water requirement

The net water requirement was calculation by using the following formula:

$$W_n = ET_{crop} - Re + (Ge + W_b)$$

- Where, W_n : net water requirement in mm/day
- ET_{crop} : crop evapotranspiration in mm/day
 - Re : effective rainfall in mm/day

Ge : groundwater contribution in mm/day

Wb : stored soil water in mm/day

The value of effective rainfall (Re) was neglected as a safety factor in consideration of the irregular distribution of rainfall. The value of "Ge" and "Wb" are too difficult to evaluate exactly, because these values are affected by method of field cultivation, control of irrigation water, and so on. In consideration of the above, 3mm/day was adopted as a percolation loss.

(3) Unit design irrigation requirement

The unit design irrigation requirement is calculated by the following formula:

$$DW = 0.116 \times W_n \times 100/E$$

Where, Dw : unit design irrigation requirement in lit/sec/ha.

Wn : net water requirement in mm/day

E : irrigation efficiency in %

The value of irrigation efficiency was evaluated at 70%, then the value of the unit design irrigation requirement is shown in Table.24

The data of the maximum daily rainfall records in a year are used for probability analysis and shown in Fig. 6. The rainfall intensity of 100mm/day with 5 years return period is determined as the design rainfall intensity for the drainage in the farm. Design discharge for drainage is given by following equation.

$$Q = 10 \times f \times Ra \times A/3,600$$

Where, Q : Design discharge

f : Run-off coefficient $f = 0.6$

Ra : Design rainfall intensity $Ra = \frac{R24}{24} \times \frac{24}{T}^{2/3}$ (mm/hr.)

T : Duration of drainage $T = 4$ hr.

A : Unit area $A = 1$ ha.

$$\therefore Q = 10 \times 0.6 \times 13.8 \times 1.0^{(ha)}/3,600 = 0.023 \text{ (m}^3\text{/sec/ha)}.$$

CHAPTER IV OUTLINE OF THE PROPOSED CONSTRUCTION WORK

Outline of the proposed construction works are shown Fig. 7~ 9.

CHAPTER V OTHERS (Procedure to the implementation of the Project)

- (1) A letter of the request addressed to JICA Bangkok Office.

If it is necessary to cooperate with JICA on the construction of the experimental farm as Model Infrastructure, a formal letter to request for the Japanese Cooperation to implement the Construction Work should be forwarded in the name of the Permanent Secretary of MOAC to JICA Bangkok Office.

- (2) Dispatch of the Short Expert.

If necessity arises, the construction supervisor will be dispatched, and Form A1 will be forwarded to the Embassy of Japan.

- (3) Preparation of the Site

Removing of clearing the plants on the site, if necessary, will be completed by KURDI until beginning of the construction work and these flow chart will be attached.

OUTLINE OF THE SCHEDULE ON PROJECT
INFRASTRUCTURE IMPROVEMENT WORK

1988	JAPANESE SIDE	THAI SIDE
	Detail Design Survey (2 Experts)	Preparation of land
	Basic Plan of Work	
September	Field Report of the Experts (information of outline on construction work) -- 16th Sep. --	
	Detail Designing (in Japan) * -- 17th Sep. -- * * * * -- 16th Oct. --	Preparation of *Form A1 for Supervising Expert
October		
November		Request of Construction work -- early in Nov. -- through JICA Office
	JICA HDQ ←	
		Form A1 -- early in Nov. --
	Consultation with Ministry of Foreign Affairs -- late in Nov. --	
		Exchange of Verbal Note -- late in Nov. --
December	Dispatch of Supervising Expert -- late in Dec. --	
	Remittance of Budget -- late in Dec. --	
January	Process for Contract -- late in Jan. --	
	Start of Construction work -- late in Jan. --	

Tables List

No.	Title
1	Specific Gravity Test
2	Liquid Limit & Plastic Limit Test
3	Gradation Analysis
4	Permeability Test
5	Suitability of Soil for Banking and Foundation
6	Water Quality Test
7	- ditto -
8	- ditto -
9	- ditto -
10	Monthly Mean Air Temp (Max)
11	- ditto - (Average)
12	- ditto - (Min)
13	Monthly Mean Humidity (Max)
14	- ditto - (Average)
15	- ditto - (Min)
16	Monthly Mean Wind Velocity
17	Prevailing Wind Direction
18	Average Mean Monthly Rainfall Distribution
19	Monthly Mean Evaporation
20	Total Duration of Sunshine
21	Caluculation of Evapotranspiration
22	kc Values for Rice
23	kc Values for Field and Vegetable Crops
24	Unit Design Irrigation Requirement

Figures List

No.	Title
1	Location Map
2	Locality Map of the Outcrops
3	Location of Sampling for the Water Quality Test and Soil Test
4	Standard Section of Test Pit
5	Water Quality
6	Probability Analysis Classification
7	Location of RID Canal

TABLE 1 SPECIFIC GRAVITY TEST

No. _____

LOCATION foundation, Paddy Field

DATE 26 Aug

SAMPLE NO. 1

TESTED BY: _____

Determination NO.		1	2	3	4
No. of Pycnometer		No. 1	No. 2		
Wt. of Pycnometer W_f in g		218.9	163.6		
Wt. (Pycnometer + water) W'_a in g		318.9	263.6		
Temperature of calibration corresponding with W'_a) T' °C		33.0	33.0		
Wt. (Pycnometer + soil + water) W_b in g		337.7	282.2		
Temperature of Calibration (corresponding to W_b) T °C		30.0	30.0		
Weight of dry Soil W_b	No. of Container	—	—		
	Wt. (Container + dry soil) in g	—	—		
	Wt. Container in g	—	—		
	W_o in g	29.8	29.9		
Deflocculating agent and its amount		—	—		
Wt. (Pycnometer + water) calculated for T °C W_s in g		318.975	263.675		
$W_s + (W_o - W_b)$ in g		11.075	11.375		
Deflocculant correction		—	—		
$W_s + (W_o - W_b)$ corrected		—	—		
Specific Gravity at T °C $G(T°C) = \frac{W_s}{W_s + (W_o - W_b)}$		2.69	2.62		
Coefficient for temperature correction K		0.9965	0.9965		
Specific Gravity at 15°C $G(15°C) = K \times G(T°C)$		2.68	2.61		
Mean value		Specific gravity (15°C) = 2.65			

*"W_s" is determined from the diagram peculiar to each pycnometer.

Remarks:

TABLE 2 LIQUID LIMIT & PLASTIC LIMIT TEST
(ESSAI DE LIMITE DE LIQUIDITE ET DE LIMITE DE PLASTICITE)

FOR REPORT
(POUR LE RAP)

NAME OF SURVEY & LOCALITY (DENOMINATION DE L'ENQUETE ET LOCALITE) foundation, Paddy Field

DATE (DATE) 1988. 19. Aug TESTED BY (ESSAI PAR)

SAMPLE NO. & DEPTH (N° DE L'ÉCHANTILLON ET PROFONDEUR)			No 1 (0.60m - 0.80m)	
LIQUID LIMIT TEST (LIMITE DE LIQUIDITÉ)			PLASTIC LIMIT TEST (LIMITE DE PLASTICITÉ)	
TEST. NO. (N° DE L'ESSAI)	NO. OF BLOWS (NOMBRE DE COUP)	WATER CONTENT (TENEUR EN EAU)	TEST. NO. (N° DE L'ESSAI)	WATER CONTENT (TENEUR EN EAU)
1	26	10.83%	1	7.50%
2	34	9.60%	2	7.11%
3	27	10.74%	3	7.04%
4	13	11.11%		
5	23	11.58%		
6		%	MEAN VALUE (VALEUR MOYENNE)	
LIQUID LIMIT (LIMITE DE LIQUIDITÉ)		PLASTIC LIMIT (LIMITE DE PLASTICITÉ)	PLASTICITY INDEX (INDICE DE PLASTICITÉ)	
w _L 10.74%		w _p 4.22%	I _p 6.52	

SAMPLE NO. & DEPTH (N° DE L'ÉCHANTILLON ET PROFONDEUR)			No (m - m)	
LIQUID LIMIT TEST (LIMITE DE LIQUIDITÉ)			PLASTIC LIMIT TEST (LIMITE DE PLASTICITÉ)	
TEST. NO. (N° DE L'ESSAI)	NO. OF BLOWS (NOMBRE DE COUP)	WATER CONTENT (TENEUR EN EAU)	TEST. NO. (N° DE L'ESSAI)	WATER CONTENT (TENEUR EN EAU)
1		%	1	%
2		%	2	%
3		%	3	%
4		%		
5		%		
6		%	MEAN VALUE (VALEUR MOYENNE)	
LIQUID LIMIT (LIMITE DE LIQUIDITÉ)		PLASTIC LIMIT (LIMITE DE PLASTICITÉ)	PLASTICITY INDEX (INDICE DE PLASTICITÉ)	
w _L %		w _p %	I _p	

FLOW CURVE
(COURBE DE DÉTERMINATION DE LA LIMITE DE LIQ)

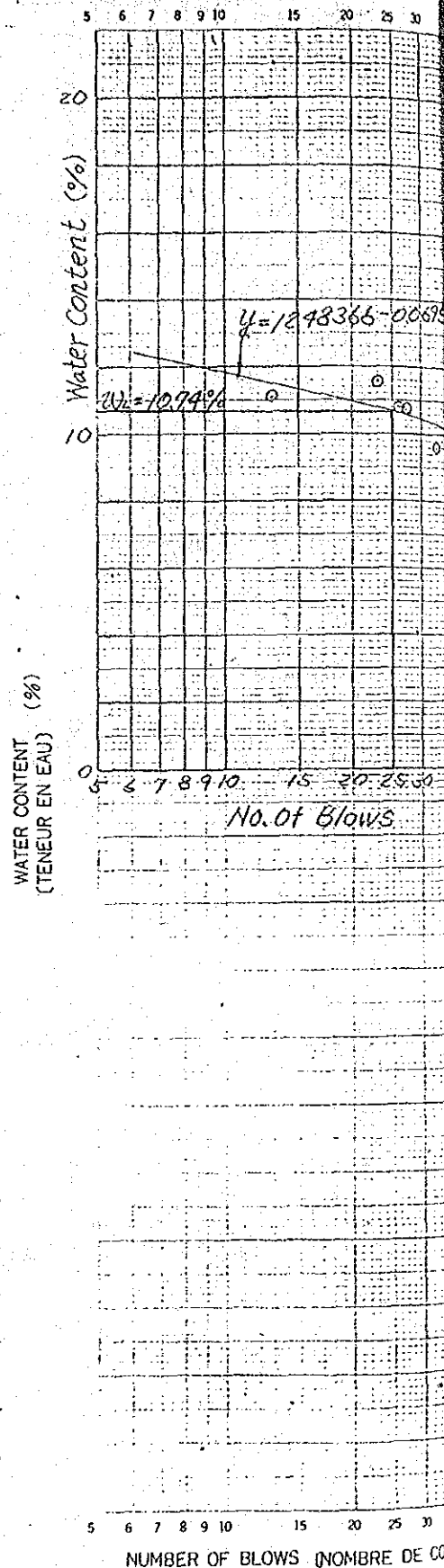

TABLE 3 GRADATION ANALYSIS
(ANALYSE GRANULOMÉTRIQUE)

FOR REPORTING
(POUR LE RAPPORT)

NAME OF SURVEY & LOCALITY (DÉNOMINATION DE L'ENQUÊTE ET LOCALITÉ)	foundation Paddy Field	DATE (DATE)	1988. 19. Aug
SAMPLE NO. & DEPTH (N° DE L'ÉCHANTILLON ET PROFONDEUR)	No. 1 (0.60m ~ 0.80m)	TESTED BY (ESSAI PAR)	

PARTICLE SIZE & WEIGHT PERCENTAGE OF PARTICLES UNDER THE SIZE
(DIMENSION DES PARTICULES ET POURCENTAGE DE POIDS DES PARTICULES DE DIMENSION INFÉRIEURE AUX PRÉCÉDENTES)

SPECIFIC GRAVITY
(POIDS SPÉCFIQUE) G_s 2.65

SIEVE (CRIBLAGE)	GRAIN SIZE (mm) (GRANULOMÉTRIE)	50.8	38.1	25.4	19.1	9.52	4.76	2.00	0.84	0.42	0.25	0.105	0.074
	TOTAL PASSING (%) (TOTAL PASSANT)	100.0	100.0	100.0	100.0	100.0	100.0	99.9	98.3	97.5	89.5	46.1	36.3
HYDROMETER (AÉROMÉTRIE)	GRAIN SIZE (mm) (GRANULOMÉTRIE)	0.053	0.037	0.024	0.014	0.0099	0.0076	0.0035	0.0014				
	TOTAL PASSING (%) (TOTAL PASSANT)	20.9	16.8	13.8	9.7	6.2	5.7	4.8	4.2				

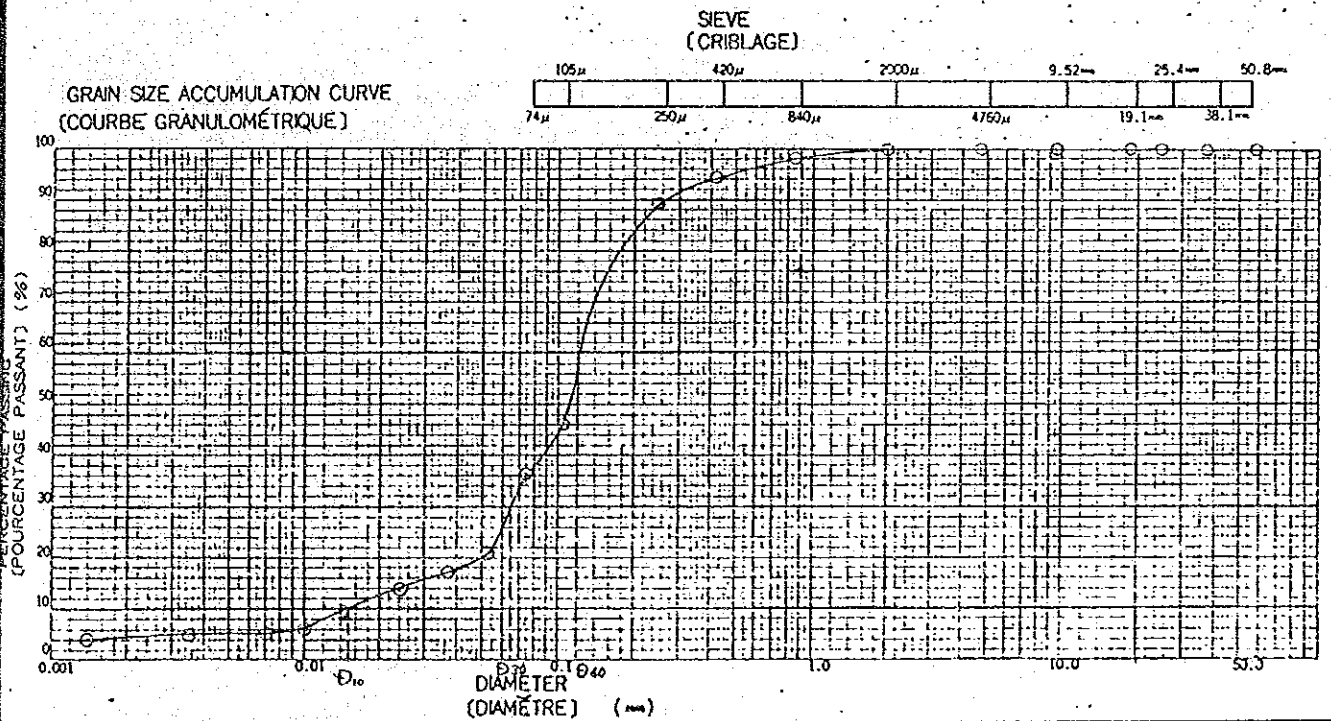

CLAY (ARGILE)	SLT (SLT)	SAND (SABLE)	GRAVEL (GRAVIER)
0.001	0.005	0.074	2.0

COLLOID
(COLLOÏDE)

PROPORTION (PROPORTION)	4.76mm <	0.0%	MAXIMUM DIAMETER (DIAMÈTRE MAXIMUM)	4.76 mm
	4.76~2.00mm	0.094%	60% DIAMETER (DIAMÈTRE 60%)	0.12 mm
	2.00~0.42mm	5.74%	30% DIAMETER (DIAMÈTRE 30%)	0.065 mm
	0.42~0.074mm	58.19%	10% DIAMETER (DIAMÈTRE 10%)	0.015 mm
	0.074~0.005mm	31.98%	COEFFICIENT OF UNIFORMITY (COEFFICIENT D'UNIFORMITÉ)	4.33
	0.005mm >	4.8%	COEFFICIENT OF CURVATURE (COEFFICIENT DE COURBURE)	2.35

TABLE 4 PERMEABILITY TEST
(ESSAI DE PERMÉABILITÉ)

NAME OF SURVEY & LOCALITY (DÉNOMINATION DE L'ENQUÊTE ET LOCALITÉ)		DATE (DATE)	20 ~ 21, Aug
SAMPLE NO. & DEPTH (N° DE L'ÉCHANTILLON ET PROFONDEUR)	foundation, Paddy Field	TESTED BY (ESSAI PAR)	

APPARATUS NO. (N° DE L'APPAREIL)		CONTAINER NO. (N° DU RÉCIPENT)		SAMPLE (ÉCHANTILLON)	UNDISTURBED - DISTURBED (INTACT - REMANIÉ)
-------------------------------------	--	-----------------------------------	--	-------------------------	---

BURETTE (BURETTE)	DIAMETER (DIAMÈTRE)		CONDITIONS OF SPECIMEN (CONDITIONS DU SPÉCIMEN)	BEFORE TEST	AFTER TEST
	(cm)	(cm)		(AVANT ESSAI)	(APRÈS ESSAI)
SPECIMEN (SPÉCIMEN)	CROSS SECTIONAL AREA (SURF. DE LA SECTION)	$a(\text{cm}^2)$	WEIGHT (CONTAINER + SPECIMEN) (POIDS (RÉCIPENT + SPÉCIMEN))	W' (g)	289.7
	DIAMETER (DIAMÈTRE)	(cm)	WEIGHT OF SPECIMEN (POIDS DU SPÉCIMEN)	$W_1 = W' - W_2$ (g)	207.1
	CROSS SECTIONAL AREA (SURF. DE LA SECTION)	$A(\text{cm}^2)$	WET DENSITY (DENSITÉ HUMIDE)	$\gamma_1 = W_1/V$ (g/cm ³)	2.07
	LENGTH (LONGUEUR)	L (cm)	DEGREE OF SATURATION (DEGRÉ DE SATURATION)	S_r (%)	43.9
	VOLUME (VOLUME)	$V = AL$ (cm ³)	WATER CONTENT (TENEUR EN EAU)	w (%)	5.9
WEIGHT OF CONTAINER (POIDS DU RÉCIPENT)	W_2 (g)	DRY DENSITY (DENSITÉ SÈCHE)	$\gamma_d = \gamma_1 / (1 + w)$ (g/cm ³)	1.95	
SPECIFIC GRAVITY (POIDS SPÉCIFIQUE)	G_s	VOID RATIO (INDICE DES VIDES)	e	0.356	

TEST NO. (N° DE L'ESSAI)	1	2	3
TIME OF INITIAL OBSERVATION (MOMENT OÙ L'OBSERVATION COMMENCE)	9:37	10:22	10:23
TIME OF FINAL OBSERVATION (MOMENT OÙ L'OBSERVATION FINIT)	10:10	10:54	11:10
ELAPSED TIME (TEMPS ÉCOULÉ)	1,950	2,880	3,150
CONSTANT HEAD METHOD (MÉTHODE DES NIVEAUX CONSTANTS)	* HEAD (DIFFÉRENCE DE NIVEAU)	h (cm)	
	$A \cdot (t_2 - t_1)$		
	L/h		
	VOLUME OF DISCHARGE IN $t_2 - t_1$ (VOLUME D'ÉPANCHEMENT EN $t_2 - t_1$)	Q (cm ³)	
	$Q/A \cdot (t_2 - t_1)$		
$k_r = \frac{L}{h} \cdot \frac{Q}{A(t_2 - t_1)}$ (cm/sec)			
FALLING HEAD METHOD (MÉTHODE DES NIVEAUX VARIABLES)	* HEAD AT t_1 (DIFF. DE NIVEAU À t_1)	h_1 (cm)	17.0
	* HEAD AT t_2 (DIFF. DE NIVEAU À t_2)	h_2 (cm)	7.0
	h_1/h_2		$\frac{17.0}{7.0}$
	$\log_{10}(h_1/h_2)$		0.385351
	$a \cdot L$		0.45×5.1
	aL/A		$\frac{2.295}{19.6}$
	$2.3/(t_2 - t_1)$		1.179×10^{-3}
	** $k_r = \frac{aL}{A} \cdot \frac{2.3}{(t_2 - t_1)} \cdot 10 \log_{10} \frac{h_1}{h_2}$ (cm/sec)		5.3×10^{-5}
	WATER TEMPERATURE (TEMPÉRATURE DE L'EAU)	T (°C)	
	*** $\mu T / \mu_{15}$		
** $k_{15} = k_r \frac{\mu T}{\mu_{15}}$			
MEAN VALUE OF k_{15} (VALEUR MOYENNE DE k_{15})			4.1×10^{-5} cm/sec (= 35 mm/day)

WATER CONTENT BEFORE TEST (TENEUR EN EAU AVANT ESSAI)	
No. K30	
W_s 291.1	W_b 279.6
W_w 279.6	W_c 82.6
W_u	W_d
$w = 5.8$	
No. K23	
W_s 300.5	W_b 288.2
W_w 288.2	W_c 82.6
W_u	W_d
$w = 6.0$	
MEAN WATER CONTENT (TENEUR MOYENNE EN EAU)	
$w = 5.9$	
WATER CONTENT AFTER TEST (TENEUR EN EAU APRÈS ESSAI)	
No.	
W_s 304.2	W_b 273.9
W_w 273.9	W_c 82.6
W_u	W_d
$w = 15.8$	
No.	
W_s	W_b
W_w	W_c
W_u	W_d
$w =$	
MEAN WATER CONTENT (TENEUR MOYENNE EN EAU)	
$w =$	

* DIFFERENCE BETWEEN HEAD WATER AND TAIL WATER
(DIFFÉRENCE ENTRE LE NIVEAU D'EAU EN TÊTE DE COLONNE ET LE NIVEAU D'ÉPANCHEMENT)
*** μT IS THE COEFFICIENT OF VISCOSITY OF THE WATER AT T °C.
(μT EST LE COEFFICIENT DE VISCOSITÉ DE L'EAU À T °C.)

** COEFFICIENT OF PERMEABILITY AT T °C.
(COEFFICIENT DE PERMÉABILITÉ À T °C.)

TABLE 5 suitability of soil for banking and foundation

Symbol	Suitability for banking	Compaction	Dry density (t/m ³)	Permeability cm/sec.	Suitability for foundation	Adjustment for permeability
GW	Very good used for pervious zone of bank or dam	Good by tractor, rubber tired roller, steel wheel roller	2.00 ~ 2.16	> 10 ⁻²	Good	Cut off wall required
GP	Good used for pervious zone of bank or dam	Good by tractor, rubber tired roller, steel wheel roller	1.84 ~ 2.00	> 10 ⁻²	Good	Cut off wall required
GM	Fair not so suitable as impervious zone, but used for impervious core or blanket	Good by close management, by rubber tired roller, sheeps food roller etc.	1.92 ~ 2.16	10 ⁻³ ~ 10 ⁻⁶	Good	Toe trench required ~ needless
GC	Barely fair used for impervious core	Fair by rubber tired roller, sheeps foot roller	1.84 ~ 2.08	10 ⁻⁶ ~ 10 ⁻³	Good	Needless
SW	Very good used for pervious zone with slope protection	Good by tractor	1.76 ~ 2.08	> 10 ⁻³	Good	Upstream blanket, toe drain or drain well required
SP	Fair used for gentle slope banking	Good by tractor	1.60 ~ 1.92	> 10 ⁻³	Good-poor according their density	Upstream blanket, toe drain or drain well required
SM	Barely fair not so suitable for impervious zone, used for impervious core or bank	Good careful operation required. by rubber tired roller, sheeps foot roller	1.72 ~ 2.00	10 ⁻³ ~ 10 ⁻⁵	Good-poor according their density	Upstream blanket, toe drain or drain well required
SC	Barely fair used for impervious core of flood protection bank	Fair by sheeps foot roller, rubber tired roller	1.68 ~ 2.00	10 ⁻⁵ ~ 10 ⁻³	Good-poor	Needless
ML	Poor used on proper adjustment	Good - poor careful operation is important. by rubber tired roller, sheeps foot roller	1.52 ~ 1.92	10 ⁻³ ~ 10 ⁻⁵	Very poor in danger of liquefaction	Toe drain ~ needless
CL	Barely fair used for impervious core or blanket	Fair - good by sheeps foot roller, rubber tired roller	1.52 ~ 1.92	10 ⁻⁶ ~ 10 ⁻³	Good-poor	Needless
OL	Unsuitable for banking materials	Fair - poor by sheeps foot roller	1.28 ~ 1.60	10 ⁻⁴ ~ 10 ⁻⁵	Fair-poor in danger large settlement	Needless
MH	Poor used for core in hydraulic fill but unsuitable for roll fill	Poor - unsuitable by sheeps foot roller	1.12 ~ 1.52	10 ⁻⁴ ~ 10 ⁻⁵	Poor	Needless
CH	Fair for gentle slope, used for thin core, blanket	Fair - poor by sheeps foot roller	1.20 ~ 1.68	10 ⁻⁵ ~ 10 ⁻³	Fair-poor	Needless
OH	Unsuitable for banking materials	Poor - unsuitable by sheeps foot roller	1.04 ~ 1.60	10 ⁻⁶ ~ 10 ⁻⁸	Very poor	Needless
Pt	Can't use for construction materials	Practically impossible	-	-	Can't use for foundation	-



NISSHIN ENGINEERING (THAILAND) CO., LTD.

BANGKOK, THAILAND
TEL. 2521692

TABLE 6 WATER QUALITY TEST

Date Aug. 24, 1988
No. SW-88-001

Messrs. _____

REPORT OF WATER ANALYSIS BY PHYSICAL AND CHEMICAL EXAMINATIONS

Sampling date	Aug. 13, 1988		
Sampling place	NAKHONPATHOM		
Sample name	SUPPLY WATER		
ANALYSIS RESULT (S)			
Item	Sample name	NO. 1	NO. 2
1. Appearance		Clear	Clear
2. Colour		0'	0'
3. Odour		-	-
4. Turbidity		0'	0'
5. PH value		6.25	6.45
6. Electrical conductivity at 20°C, micromhos/cm		2,050	195
7. Total solids (ppm)		1,060	125
8. Suspended solids (ppm)		0	0
9. Dissolved solids (ppm)		1,060	125
10. Total hardness (ppm as CaCO ₃)		358.80	96.80
11. Temporary hardness (ppm as CaCO ₃)		358.80	96.80
12. Permanent hardness (ppm as CaCO ₃)		0	0
13. M-Alkalinity (ppm as CaCO ₃)		292	109
14. P-Alkalinity (ppm as CaCO ₃)		0	0
15. Residual-Alkalinity (ppm as CaCO ₃)			
16. Chlorides Ion (ppm as Cl ⁻)		421.90	12.80
17. Sulfates Ion (ppm as SO ₄ ⁻²)			
18. Phosphates Ion (ppm as PO ₄ ⁻³)			
19. Nitrates Ion (ppm as NO ₃ ⁻)		None	None
20. Nitrites Ion (ppm as NO ₂ ⁻)		Detection	None
21. Ammonium Ion (ppm as NH ₄ ⁺)		None	None
22. Silica (ppm as SiO ₂)			
23. Total Iron (ppm)		0.12	0.14
24. Total Manganese (ppm)			
25. Residual Chlorine (ppm)			
26. COD-Mn (ppm)		6.00	2.00
REMARKS.			
	LABORATORY MANAGER <i>[Signature]</i>		



NISSHIN ENGINEERING (THAILAND) CO., LTD.

BANGKOK, THAILAND

TEL. 2521692

TABLE 7 WATER QUALITY TEST

Date Aug 24, 1988.

Messrs _____

No. SW-88-002

REPORT OF WATER ANALYSIS BY PHYSICAL AND CHEMICAL EXAMINATIONS

Sampling date	Aug 13, 1988		
Sampling place	NAKHONPATHOM		
Sample name	SUPPLY WATER		
ANALYSIS RESULT (S)			
Item	Sample name	NO. 3	NO. 4
1. Appearance		Clear	Clear
2. Colour		0'	0'
3. Odour		-	-
4. Turbidity		0'	0'
5. PH value		6.58	6.62
6. Electrical conductivity		190	195
	at 20°C, micromhos/cm		
7. Total solids	(ppm)	100	80
8. Suspended solids	(ppm)	0	0
9. Dissolved solids	(ppm)	100	80
10. Total hardness	(ppm as CaCO ₃)	96.8	102.8
11. Temporary hardness	(ppm as CaCO ₃)	96.8	102.8
12. Permanent hardness	(ppm as CaCO ₃)	0	0
13. M--Alkalinity	(ppm as CaCO ₃)	108	114
14. P--Alkalinity	(ppm as CaCO ₃)	0	0
15. Residual--Alkalinity	(ppm as CaCO ₃)		
16. Chlorides Ion	(ppm as Cl ⁻)	11.0	11.0
17. Sulfates Ion	(ppm as SO ₄ ⁻²)		
18. Phosphates Ion	(ppm as PO ₄ ⁻³)		
19. Nitrates Ion	(ppm as NO ₃ ⁻)	None	None
20. Nitrites Ion	(ppm as NO ₂ ⁻)	None	None
21. Ammonium Ion	(ppm as NH ₄ ⁺)	None	None
22. Silica	(ppm as SiO ₂)		
23. Total Iron	(ppm)	0.06	0.06
24. Total Manganese	(ppm)		
25. Residual Chlorine	(ppm)		
26. COD - Mn	(ppm)	2.4	2.4
REMARKS.		LABORATORY MANAGER	



NISSHIN ENGINEERING (THAILAND) CO., LTD.

BANGKOK, THAILAND
TEL. 2521692

TABLE 8 WATER QUALITY TEST

Date Aug 24, 1988.
No. SW-88-003

Messrs _____

REPORT OF WATER ANALYSIS BY PHYSICAL AND CHEMICAL EXAMINATIONS

Sampling date	Aug 13, 1988.	
Sampling place	NAKHONPATHOM	
Sample name	SUPPLY WATER	
ANALYSIS RESULT (S)		
Item	Sample name	
		NO. 5 NO. 6
1. Appearance		Clear Little yellow
2. Colour		0' 5'
3. Odour		
4. Turbidity		0' 0'
5. PH value		6.65 7.05
6. Electrical conductivity at 20°C, micromhos/cm		750 1,250
7. Total solids (ppm)		400 720
8. Suspended solids (ppm)		0 0
9. Dissolved solids (ppm)		400 720
10. Total hardness (ppm as CaCO ₃)		152.2 213.8
11. Temporary hardness (ppm as CaCO ₃)		152.2 213.8
12. Permanent hardness (ppm as CaCO ₃)		0 0
13. M-Alkalinity (ppm as CaCO ₃)		302 245
14. P-Alkalinity (ppm as CaCO ₃)		0 0
15. Residual-Alkalinity (ppm as CaCO ₃)		
16. Chlorides Ion (ppm as Cl ⁻)		84.80 173.9
17. Sulfates Ion (ppm as SO ₄ ⁻²)		
18. Phosphates Ion (ppm as PO ₄ ⁻³)		
19. Nitrates Ion (ppm as NO ₃ ⁻)		None None
20. Nitrites Ion (ppm as NO ₂ ⁻)		None None
21. Ammonium Ion (ppm as NH ₄ ⁺)		None None
22. Silica (ppm as SiO ₂)		
23. Total Iron (ppm)		0.05 0.06
24. Total Manganese (ppm)		
25. Residual Chlorine (ppm)		
26. COD - Mn (ppm)		0.8 7.2
REMARKS.		

LABORATORY MANAGER

[Signature]



NISSHIN ENGINEERING (THAILAND) CO., LTD.

BANGKOK, THAILAND
TEL. 2521692

TABLE 9 WATER QUALITY TEST

Date Aug 24, 1988.

Messrs. _____

No. SW-88-004

REPORT OF WATER ANALYSIS BY PHYSICAL AND CHEMICAL EXAMINATIONS			
Sampling date	Aug 13, 1988.		
Sampling place	NAKHONPATHOM		
Sample name	SUPPLY WATER		
ANALYSIS RESULT (S)			
Item	Sample name	NO. 7	NO. 8
1. Appearance		Clear.	Little yellow
2. Colour		0'	5'
3. Odour			
4. Turbidity		0'	5'
5. PH value		7.12	7.45
6. Electrical conductivity		610	1,750
at 20°C, micromhos/cm			
7. Total solids	(ppm)	380	1,020
8. Suspended solids	(ppm)	0	8
9. Dissolved solids	(ppm)	380	1,012
10. Total hardness	(ppm as CaCO ₃)	143.1	266.1
11. Temporary hardness	(ppm as CaCO ₃)	143.1	266.1
12. Permanent hardness	(ppm as CaCO ₃)	0	0
13. M--Alkalinity	(ppm as CaCO ₃)	250	138
14. P--Alkalinity	(ppm as CaCO ₃)	0	0
15. Residual--Alkalinity	(ppm as CaCO ₃)		
16. Chlorides Ion	(ppm as Cl ⁻)	67.0	335.0
17. Sulfates Ion	(ppm as SO ₄ ⁻²)		
18. Phosphates Ion	(ppm as PO ₄ ⁻³)		
19. Nitrates Ion	(ppm as NO ₃ ⁻)	None	None
20. Nitrites Ion	(ppm as NO ₂ ⁻)	None	None
21. Ammonium Ion	(ppm as NH ₄ ⁺)	None	None
22. Silica	(ppm as SiO ₂)		
23. Total Iron	(ppm)	0.10	0.08
24. Total Manganese	(ppm)		
25. Residual Chlorine	(ppm)		
26. COD-Mn	(ppm)	14.16	37.46
REMARKS.		LABORATORY MANAGER	

Table 10 Monthly Mean Air Temp (Max)

	(°c)											
	Jan	Feb	Mar	Apr	May	Jun	Jul	Aug	Sep	Oct	Nov	Dec
1973	31.9	35.0	35.5	38.5	35.6	34.0	33.1	32.9	32.1	30.6	28.5	27.9
1974	30.7	32.9	34.4	34.6	33.5	33.3	33.2	32.1	32.0	31.0	29.6	29.8
1975	29.5	33.8	36.2	37.2	34.0	32.8	33.0	32.4	31.3	30.9	29.0	26.8
1976	29.1	32.5	34.5	36.6	33.0	34.3	33.5	32.5	32.1	31.3	28.6	29.8
1977	31.5	31.9	33.7	36.2	34.8	35.2	33.8	33.7	33.0	32.2	29.9	31.0
1978	32.3	32.5	37.2	37.1	34.7	34.0	33.0	32.4	32.7	30.7	30.0	30.0
1979	33.3	34.8	37.5	37.0	36.5	34.1	34.4	34.2	31.8	31.6	30.2	30.4
1980	32.5	34.3	37.0	38.1	37.2	33.6	33.8	33.7	32.5	30.8	30.3	30.2
1981	30.8	33.9	36.3	36.3	34.8	32.3	33.0	33.2	32.7	32.0	29.4	27.4
1982	30.7	34.6	35.9	35.5	35.4	32.8	33.0	31.6	31.7	32.0	31.9	28.7
1983	31.3	35.0	36.4	37.9	37.2	35.0	34.6	32.8	32.8	31.4	28.2	28.6
1984	30.0	33.2	35.3	36.7	35.5	33.1	33.8	33.0	32.7	31.2	31.1	30.6
1985	32.5	35.5	36.4	37.0	34.3	32.6	32.2	33.0	32.1	31.2	30.9	29.7
1986	30.4	33.8	35.4	36.8	34.4	34.1	33.1	33.4	33.1	31.6	30.3	29.7
1987	31.4	33.3	35.2	37.1	35.6	34.7	35.3	34.6	33.4	32.6	31.2	27.8
Mean	31.2	31.6	35.8	36.8	35.1	33.7	33.5	33.0	32.4	31.4	29.9	29.2

Table.11 Monthly Mean Air Temp (Average)

	(°c)											
	Jan	Feb	Mar	Apr	May	Jun	Jul	Aug	Sep	Oct	Nov	Dec
1973	25.0	28.2	29.7	32.1	30.2	29.3	28.7	28.4	27.8	26.7	24.2	21.9
1974	23.4	25.6	28.0	28.8	28.5	28.2	28.2	27.7	27.4	26.8	25.3	24.4
1975	24.5	26.7	29.4	30.4	28.6	27.7	27.4	27.4	26.9	26.5	24.6	20.9
1976	21.1	25.9	27.8	29.9	27.9	28.4	28.3	28.1	27.8	27.2	24.4	24.1
1977	25.1	25.2	27.5	29.8	29.1	29.5	28.6	28.4	28.1	27.4	24.5	22.6
1978	25.7	26.7	30.2	30.6	29.3	28.7	28.1	27.6	27.6	26.2	24.6	23.3
1979	26.0	27.6	29.7	30.2	30.2	28.9	28.8	28.3	27.8	26.0	23.8	22.8
1980	24.1	26.7	29.6	31.7	31.4	29.9	29.1	28.8	28.0	26.8	25.8	24.2
1981	23.1	26.8	29.1	30.3	30.0	28.2	28.7	28.0	28.1	27.6	25.7	22.1
1982	23.2	28.0	29.6	29.4	29.9	28.4	28.3	27.6	27.5	27.3	26.9	21.8
1983	23.1	27.5	29.4	31.7	31.1	29.8	29.5	28.5	28.2	27.4	24.2	23.3
1984	23.7	27.2	28.7	30.6	29.9	28.5	28.7	29.2	28.1	26.8	25.8	24.2
1985	25.5	28.7	30.0	31.1	29.8	28.8	28.0	28.7	28.0	27.4	26.5	23.3
1986	22.9	27.1	28.6	30.7	29.4	29.0	28.3	28.8	28.6	27.7	25.9	24.0
1987	24.6	26.6	28.5	30.5	30.3	29.5	29.5	29.1	28.3	27.7	27.3	21.9
Mean	24.1	27.0	29.1	30.5	29.7	28.9	28.5	28.3	27.9	27.0	25.3	23.0

Table 12 Monthly Mean Air Temp (Min)

	(°c)											
	Jan	Feb	Mar	Apr	May	Jun	Jul	Aug	Sep	Oct	Nov	Dec
1973	18.0	21.4	23.8	25.6	24.7	24.5	24.2	20.9	23.4	22.7	19.7	15.9
1974	15.9	18.2	21.4	23.0	23.3	23.1	23.0	23.3	22.8	22.6	20.9	19.0
1975	19.4	19.7	22.7	20.5	23.2	22.5	21.7	22.4	22.5	22.0	20.1	15.1
1976	13.0	19.4	21.1	23.2	22.8	22.5	23.0	23.7	23.4	23.1	20.1	18.3
1977	18.7	18.5	21.2	23.3	23.4	23.6	23.3	23.2	23.2	22.6	19.2	17.4
1978	19.1	20.8	23.2	23.9	24.0	23.4	23.2	23.1	22.6	21.7	19.1	16.5
1979	18.7	20.4	21.9	23.4	24.1	23.6	23.2	23.1	22.6	20.3	17.3	15.2
1980	15.6	19.1	22.4	25.2	25.7	24.3	24.3	23.9	23.5	22.9	20.8	18.0
1981	15.3	19.7	21.8	24.2	24.5	24.6	24.3	23.7	23.6	23.1	22.0	16.7
1982	15.5	21.4	23.2	23.2	24.3	24.1	23.5	23.5	23.3	22.6	21.8	15.0
1983	16.5	20.0	22.3	25.3	25.3	24.5	24.3	24.1	23.6	23.4	20.1	18.0
1984	17.4	21.2	22.1	24.4	24.2	23.9	23.6	24.2	23.5	22.3	20.5	17.7
1985	18.4	21.8	23.5	25.2	25.2	24.9	23.8	24.3	23.9	23.5	22.0	16.9
1986	15.5	20.3	21.7	24.6	24.4	23.9	23.4	24.3	24.0	23.8	21.6	18.3
1987	17.8	20.0	21.7	23.9	24.3	24.2	23.6	23.6	23.2	22.8	23.3	15.9
Mean	17.0	20.1	22.3	23.9	24.2	23.8	23.5	23.4	23.3	22.6	20.6	16.9

Table 13

Monthly Mean Humidity (Maximum)

(%)

	Jan	Feb	Mar	Apr	May	Jun	Jul	Aug	Sep	Oct	Nov	Dec
1973	96	95	94	93	95	98	95	96	96	97	98	93
1974	94	94	96	99	99	97	93	94	95	97	98	98
1975	98	98	95	93	97	92	93	95	97	96	98	98
1976	99	98	97	95	97	92	93	98	96	96	96	99
1977	99	98	98	100	100	98	99	98	99	99	98	98
1978	99	97	92	94	95	98	98	97	98	99	100	99
1979	99	98	97	97	95	95	95	95	98	98	98	98
1980	100	98	99	96	95	100	98	99	97	99	99	99
1981	98	95	95	96	95	95	93	93	97	95	98	94
1982	92	95	95	95	96	97	98	97	97	97	96	97
1983	96	99	98	88	89	94	95	95	95	98	97	94
1984	96	95	95	90	95	96	97	97	96	97	97	95
1985	94	94	93	88	95	93	97	99	97	98	99	97
1986	95	95	92	95	95	97	97	96	97	97	94	96
1987	96	97	96	96	98	91	91	92	95	97	98	98
Mean	97	96	96	94	96	96	96	96	97	97	98	97

Table.14 Monthly Mean Humidity (Average)

	(%)											
	Jan	Feb	Mar	Apr	May	Jun	Jul	Aug	Sep	Oct	Nov	Dec
1973	66	64	66	62	69	76	74	74	77	79	77	66
1974	64	63	67	73	76	74	71	75	76	79	77	73
1975	76	68	64	63	72	71	70	74	79	78	79	71
1976	67	68	66	63	74	67	69	76	77	76	79	72
1977	70	68	68	68	72	70	73	72	76	76	72	67
1978	68	68	59	62	70	73	75	76	74	77	74	70
1979	67	64	61	64	66	69	67	69	75	71	68	67
1980	67	64	63	65	66	75	73	74	73	78	73	68
1981	65	62	61	65	68	72	69	70	73	71	79	67
1982	59	62	62	65	69	73	71	82	75	73	71	66
1983	63	63	60	63	68	73	75	78	79	83	79	73
1984	73	73	69	66	70	75	75	73	76	77	75	71
1985	69	67	66	65	76	77	78	79	79	80	80	71
1986	67	67	62	69	74	76	78	78	77	80	74	72
1987	67	69	68	69	74	71	68	72	78	80	83	74
Mean	67	66	64	66	71	73	72	75	76	77	76	70

Table 15 Monthly Mean Humidity (Minimum)

	(%)											
	Jan	Feb	Mar	Apr	May	Jun	Jul	Aug	Sep	Oct	Nov	Dec
1973	37	32	39	30	44	53	52	52	57	60	56	39
1974	33	52	38	47	52	51	48	54	56	61	56	47
1975	53	36	33	34	48	49	46	53	61	59	55	44
1976	34	38	34	32	49	41	44	53	57	57	62	44
1977	39	38	48	36	44	42	47	45	52	53	46	36
1978	37	39	26	30	44	48	51	54	51	55	47	40
1979	35	33	25	32	37	43	39	43	52	42	38	36
1980	34	30	28	34	35	50	47	48	49	58	47	37
1981	32	29	27	34	40	49	44	47	50	47	60	39
1982	25	28	30	34	42	49	44	51	53	48	45	34
1983	30	26	25	38	45	51	55	61	61	67	61	51
1984	48	49	42	43	45	54	53	49	56	58	52	46
1985	43	39	40	41	55	59	59	58	60	62	60	45
1986	37	38	32	44	57	55	57	57	56	62	54	48
1987	39	40	40	41	48	51	45	51	60	63	68	50
Mean	37	36	34	37	46	50	49	52	55	57	54	42

Table.16

Monthly Mean Wind Velocity

(m/sec)

	Jan	Feb	Mar	Apr	May	Jun	Jul	Aug	Sep	Oct	Nov	Dec
1973	1	1	2	2	1	2	2	2	1	2	2	3
1974	2	2	2	2	2	3	3	2	1	1	3	3
1975	2	2	2	3	2	2	2	2	1	1	3	3
1976	2	2	2	2	2	3	2	2	2	2	3	2
1977	2	2	3	2	2	2	2	3	2	2	2	2
1978	2	2	3	2	2	2	2	2	2	2	2	2
1979	1	2	3	2	3	2	2	2	1	2	3	2
1980	1	2	2	2	2	1	2	2	2	1	2	1
1981	1	1	2	2	2	1	2	2	1	2	2	2
1982	1	2	2	2	2	1	2	2	1	1	1	2
1983	2	3	3	3	2	2	2	2	1	1	2	2
1984	1	2	2	2	2	2	1	2	1	1	2	2
1985	1	2	2	2	1	1	2	2	1	1	1	1
1986	1	1	2	1	2	1	1	1	1	1	1	1
1987	1	1	2	1	1	1	2	1	1	1	1	2
Mean	1	2	2	2	2	2	2	2	1	1	2	2

Table 17

Prevailing Wind Direction

	Jan	Feb	Mar	Apr	May	Jun	Jul	Aug	Sep	Oct	Nov	Dec
1973	NE	SE	SE	S	S	SW	WSW	SW	SW	NE	NE	NE
1974	E	ESE	SE	SE	SW	WSW	SW	WSW	NE	NE	NE	NE
1975	NE	SE	SE	SSE	S	SW	SW	WSW	SW	NE	NE	NE
1976	NE	SSE	SE	SW	SW	SW	W	SW	SW	N	NE	NE
1977	ENE	E	SE	SE	SW	WSW	WSW	W	WNW	NE	NE	NE
1978	E	SE	SSE	SSE	SE	WSW	WSW	WSW	SW	NE	NE	NE
1979	SE	SE	SE	SE	W	SW	W	SW	SW	NE	NE	NE
1980	SE	SE	SSE	SSE	S	W	SW	W	W	NE	NE	NE
1981	NE	SSE	SSE	SSE	S	SW	SW	WSW	W	N	NE	NE
1982	ENE	SE	SE	SE	SSW	WSW	SW	W	W	NE	NE	NE
1983	ENE	SSE	SE	SE	S	SW	W	W	W	NE	NE	NE
1984	NE	SE	SE	SE	SW	SW	SW	WSW	SW	NE	NE	NE
1985	NE	SE	SE	SE	SE	SW	WSW	SW	SE	NE	N	NE
1986	NE	SE	SE	SE	SW	SW	W	W	W	NE	NE	NE
1987	NE	SE	SE	S	S	SW	WSW	SW	W	NNE	N	NNE

Table 18 AVERAGE MEAN MONTHLY RAINFALL DISTRIBUTION

	JAN	FEB	MAR	APR	MAY	JUN	JUL	AUG	SEP	OCT	NOV	DEC	TOTAL
1973	0	0	33.2	9.5	173.5	156.6	161.7	106.9	178.8	261.7	73.3	1.0	1,156.2
1974	0	0	30.9	173.8	43.1	122.6	172.8	119.4	322.3	320.9	48.2	1.1	1,355.1
1975	60.9	-	0.1	5.0	166.3	153.7	68.3	99.8	243.0	272.7	60.6	18.7	1,149.1
1976	0	64.0	2.5	14.5	199.8	66.8	76.4	237.7	235.6	154.8	88.8	0	1,140.9
1977	0	0	11.5	110.5	156.0	106.4	108.0	80.3	200.3	140.4	11.3	0.6	925.3
1978	9.8	26.7	0.5	101.1	208.1	165.0	266.0	40.2	271.1	87.6	6.1	0	1,132.2
1979	0	15.4	0	136.3	69.2	96.0	73.4	29.6	306.1	52.1	22.6	0	800.7
1980	0	1.8	2.2	0	63.8	207.7	70.3	147.4	157.7	342.7	16.4	0	1,010.0
1981	0	3.2	1.5	53.1	147.8	82.0	157.3	113.1	256.1	48.1	244.3	-	1,106.5
1982	0	0	14.9	114.3	125.5	117.9	80.4	80.3	213.2	170.3	8.5	5.1	930.4
1983	-	0.0	0.3	0.0	64.7	75.4	279.1	175.1	276.3	380.6	144.9	11.5	1,407.9
1984	-	8.7	19.2	20.9	117.6	40.9	70.2	46.6	120.2	107.3	8.7	0.1	560.4
1985	0.3	6.0	1.5	88.4	136.4	48.8	175.8	89.3	241.0	103.3	104.7	0.0	995.5
1986	0.0	0.0	5.0	40.3	141.4	117.9	151.9	179.8	288.6	301.5	36.4	14.0	1,276.8
1987	0.0	0.3	1.4	87.3	21.5	18.4	5.2	80.1	136.9	270.9	213.8	0.0	835.8
TOTAL	71.0	126.1	124.7	955.0	1834.7	1576.1	1916.8	1625.6	3447.2	3014.9	1088.6	52.1	15,832.8
MEAN													

Table 19 Monthly Mean Evaporation

(mm)

	Jan	Feb	Mar	Apr	May	Jun	Jul	Aug	Sep	Oct	Nov	Dec
1973	5.48	6.93	7.31	9.84	7.80	6.41	7.01	6.44	5.28	5.40	4.82	5.57
1974	5.17	6.14	7.11	6.60	5.42	6.10	6.65	4.94	5.38	4.55	4.74	5.26
1975	4.37	6.07	7.34	8.96	6.33	6.18	6.36	5.55	4.47	4.74	5.25	5.20
1976	4.76	5.20	6.76	8.65	5.67	7.39	5.93	5.46	5.49	4.79	5.39	4.78
1977	4.92	5.66	7.12	7.80	6.25	6.56	5.43	6.04	5.05	4.74	5.05	4.89
1978	4.93	5.19	8.03	8.04	5.08	5.91	5.14	4.64	5.04	4.54	4.67	5.07
1979	4.90	5.87	8.22	8.23	8.41	5.54	5.87	5.65	4.65	5.30	5.81	4.94
1980	4.88	6.30	7.05	8.27	7.54	5.54	5.76	6.33	4.90	4.55	4.53	4.57
1981	4.82	5.27	7.14	7.20	6.18	4.4	5.4	5.1	4.8	4.3	3.7	4.2
1982	4.3	5.5	6.7	6.8	6.5	4.6	5.1	4.2	4.2	4.4	4.2	4.2
1983	4.4	6.2	7.8	7.8	7.2	6.3	6.2	5.6	4.9	4.5	4.0	4.3
1984	3.8	4.8	6.7	6.8	6.4	5.0	5.7	6.5	4.4	4.2	4.9	4.6
1985	5.0	6.3	7.3	7.5	5.8	4.5	4.6	5.1	4.0	3.7	3.9	4.4
1986	4.4	4.9	6.4	6.8	6.1	6.6	5.0	5.5	4.9	4.1	4.1	4.0
1987	0.3	4.8	6.1	6.9	6.1	5.3	6.2	6.0	4.6	3.9	3.6	4.2
MEAN	4.70	5.68	7.14	7.75	6.45	5.76	5.76	5.54	4.80	4.51	4.58	4.68

Table 20

Total Duration of Sunshine

(hours)

	Jan	Feb	Mar	Apr	May	Jun	Jul	Aug	Sep	Oct	Nov	Dec	Tot
1973	288.7	261.4	224.1	270.9	227.6	167.8	139.2	138.2	144.4	208.0	184.2	276.0	2530
1974	252.2	234.0	251.1	211.3	175.1	148.8	186.2	141.6	188.9	181.9	213.6	235.5	2420
1975	160.2	230.7	238.7	241.0	177.1	110.8	188.1	93.0	127.0	178.9	238.7	238.9	2223
1976	281.3	234.7	242.6	255.4	165.1	211.4	138.3	136.6	196.1	187.9	231.0	256.2	2536
1977	237.9	222.0	224.5	261.9	231.9	217.3	128.0	146.6	143.0	240.1	251.4	269.2	2573
1978	219.7	176.1	280.8	267.3	210.3	165.9	147.4	84.1	130.9	201.2	240.9	276.2	2400
1979	265.4	231.9	284.1	238.7	227.8	139.7	197.9	119.5	143.7	260.7	278.9	271.2	2659
1980	259.3	257.4	252.2	255.0	241.0	128.6	163.0	180.0	127.3	177.6	205.4	272.8	2519
1981	262.6	209.8	278.9	244.2	214.0	94.0	138.0	126.0	142.0	191.0	142.0	233.0	2275
1982	272.0	242.0	255.0	256.0	218.0	103.0	144.0	74.0	119.0	211.0	245.0	244.0	2383
1983	258.0	249.0	255.0	243.0	240.0	189.0	208.0	156.0	173.0	154.0	185.0	239.0	2549
1984	243.0	236.0	275.0	227.0	218.0	130.0	195.0	125.0	145.0	187.0	239.0	252.0	2472
1985	250.0	240.0	270.0	230.0	204.0	80.0	126.0	127.0	124.0	166.0	215.0	285.0	2317
1986	271.0	243.0	271.0	242.0	192.0	167.0	145.0	152.0	182.0	182.0	256.0	251.0	2554
1987	266.0	244.0	262.0	269.0	254.0	172.0	191.0	186.0	152.0	199.0	163.0	250.0	2608
Mean	252.5	234.1	257.7	232.5	213.1	148.4	162.3	132.4	149.2	195.1	219.3	256.7	2468

(1) Modified Penman Method $(ETo = C \{ W \cdot Rn + (1-W) \cdot f(u) \cdot (ea - ed) \})$

	Jan.	Feb.	Mar.	Apr.	May	Jun	Jul.	Aug.	Sep.	Oct.	Nov.	Dec.	Remarks
METEOROLOGICAL DATA													
Air Temperature (°C) (Mean)	24.1	27.0	29.1	30.5	29.7	28.9	28.5	28.3	27.9	27.0	25.3	23.0	
Relative Humidity (%) (Mean)	67	66	64	66	71	73	72	75	76	77	76	70	
Wind Velocity (m/s)	1	2	2	2	2	2	2	2	1	1	2	2	
Sun Shine Duration (n/N)	0.72	0.72	0.69	0.62	0.59	0.58	0.41	0.34	0.41	0.53	0.64	0.77	
CALCULATION													
ea	30.0	35.7	40.3	43.7	41.7	39.9	39.0	38.5	37.6	35.7	32.9	28.1	
ed = ea x RH mean / 100	20.1	23.6	25.8	22.7	29.6	29.1	28.1	28.9	28.6	27.5	24.5	19.7	
(ea - ed)	9.9	12.1	14.5	14.9	12.1	10.3	10.9	9.6	9.0	8.2	7.6	8.4	
$U \left(\frac{km}{day} = \frac{1000}{365 \times 24} \frac{m}{sec} \right)$	8.6	17.3	17.3	17.3	17.3	17.3	17.3	17.3	26	86	17.3	17.3	
$f(u) = 0.27(1+u/100)$	0.50	0.74	0.74	0.74	0.74	0.74	0.74	0.74	0.50	0.50	0.74	0.74	
(1-W)	0.27	0.24	0.22	0.22	0.22	0.23	0.23	0.23	0.23	0.24	0.26	0.28	
W	0.73	0.76	0.78	0.78	0.78	0.77	0.77	0.77	0.77	0.76	0.74	0.72	
Ra (mm/day)	12.4	13.6	14.9	15.7	15.6	15.7	15.7	15.7	15.1	14.1	12.8	12.0	
$Rs = (0.25 + 0.50n/N) Ra$ (")	7.56	2.30	8.87	2.74	2.22	2.91	7.14	2.59	6.87	7.26	7.30	7.44	
$Rns = (1-\alpha)Rs$ $\alpha = 0.25$	5.7	1.72	6.7	2.6	2.2	2.2	5.2	2.9	5.2	5.4	5.5	5.6	
f(T)	15.4	16.1	16.5	16.5	16.6	16.5	16.4	16.4	16.3	16.1	15.7	15.2	
f(ed)	0.14	0.12	0.12	0.11	0.10	0.10	0.11	0.11	0.11	0.11	0.12	0.12	
f(n/N)	0.75	0.75	0.72	0.66	0.59	0.44	0.47	0.41	0.47	0.58	0.68	0.77	
Rnl (mm/day)	1.6	1.4	1.4	1.2	1.0	0.7	0.8	0.7	0.8	1.0	1.3	1.6	
$Rn = Rns - Rnl$	4.1	4.0	5.3	5.2	5.2	5.5	4.6	4.2	4.4	4.4	4.2	4.0	
C	1.04	1.02	1.07	1.03	1.02	0.98	0.99	0.98	1.03	1.04	0.99	1.00	
$ETo = C(W \cdot Rn + (1-W) \cdot f(u) \cdot (ea - ed))$	4.5	5.9	4.6	4.8	4.1	5.2	5.3	4.8	4.6	4.5	4.6	4.6	

Table.22

kc Values for Rice

	Planting	Harvest	First & Second Month	Mid-season	Last 4 weeks
<u>Humid Asia</u>	Jun-Jul	Nov-Dec			
Wet season (monsoon)			1.1	1.05	.95
light to mod. wind			1.15	1.1	1.0
strong wind					
dry season ^{1/}	Dec-Jan	mid-May			
light to mod. wind			1.1	1.25	1.0
strong wind			1.15	1.35	1.05

^{1/} Only when RHmin > 70%, kc values for wet season are to be used.

Table.23

kc Values for Field and Vegetable Crops

Humidity		RHmin > 70%		RHmin < 20%	
Wind (m/sec)		0-5	5-8	0-5	5-8
Corn (sweet) (maize)	<u>Crop stage</u> Mid-season	1.05	1.1	1.15	1.2
	at harvest or maturity	0.95	1.0	1.05	1.1
Tomato	mid-season	1.05	1.1	1.2	1.25
	at harvest or maturity	0.6	0.6	0.65	0.65
Sugarcane	planting to 0.25 full canopy	.55	.6	.4	.45
	0.25-0.5 full canopy	.8	.85	.75	.8
	0.5-0.75 full canopy	.9	.95	.95	1.0
	0.75 to full canopy	1.0	1.1	1.1	1.2
	peak use	1.05	1.15	1.25	1.3
	early senescence	.8	.85	.95	1.05
	ripening	.6	.65	.7	.75

Table. 24

Unit Design Irrigation Requirement

Site	Crop	ETo max	Kc max	LP	ET crop	Wn	Dw
		Land preparation	0.70	152.4	-	152.4	25.3
Paddy Field	Rice	6.8	1.25	-	8.5	11.5	1.9
Breeding Field	Tomato and/or Sweet Corn	6.8	1.05		7.1	10.1	1.7
Variety Collection Field	Papaya	6.8		-			
	Sugarcane	6.8	1.05	-	7.1	10.1	1.7

- Where, ETo max : Maximum potential evapotranspiration (mm/day)
- Kc max : Maximum crop coefficient
- LP : Water requirement for land preparation (mm/day)
- ET crop : Crop evapotranspiration (mm/day)
- Wn : Net water requirement (mm/day)
- Dw : Unit design irrigation requirement (lit/sec/ha)

FIG. 1 LOCATION MAP

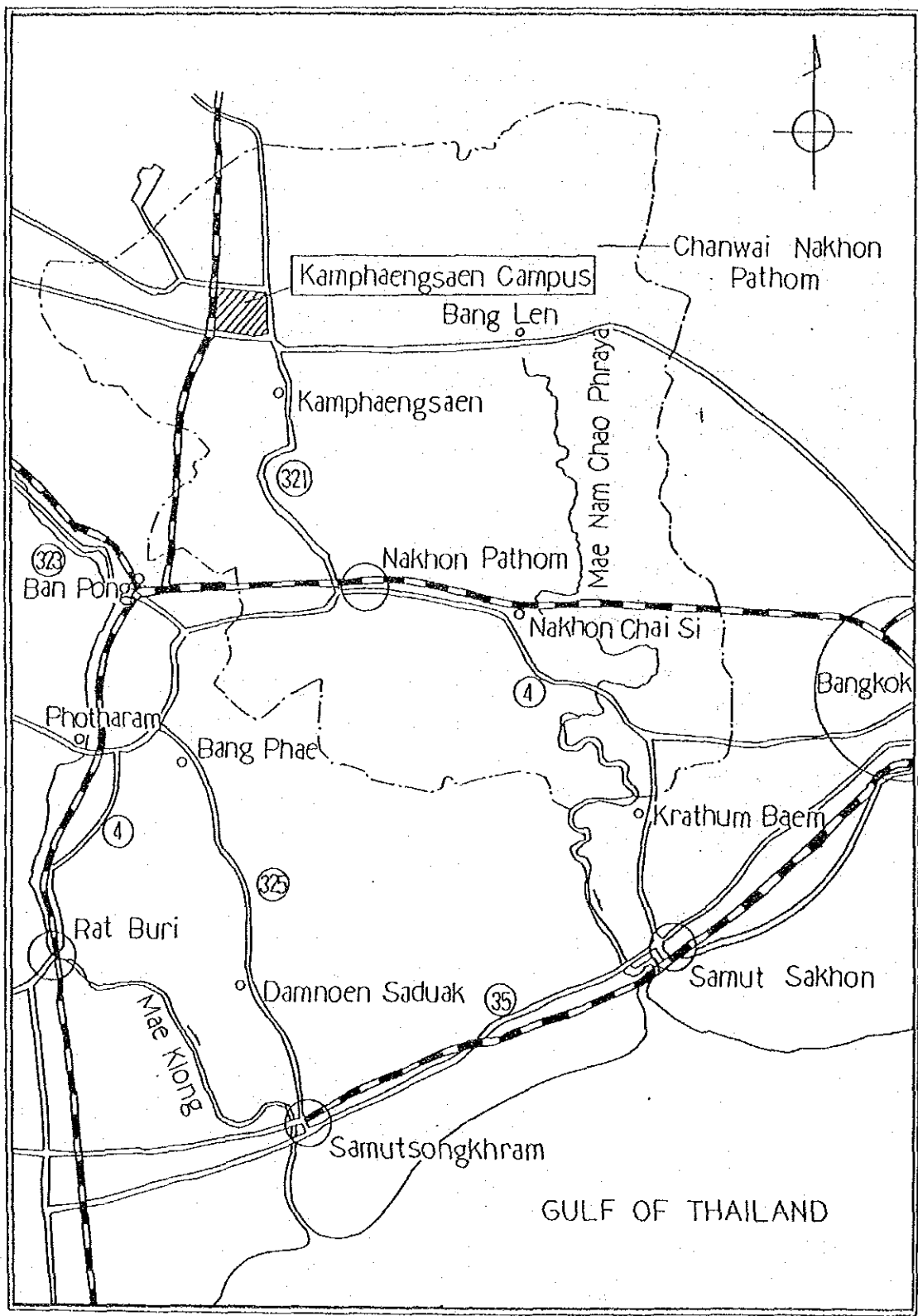
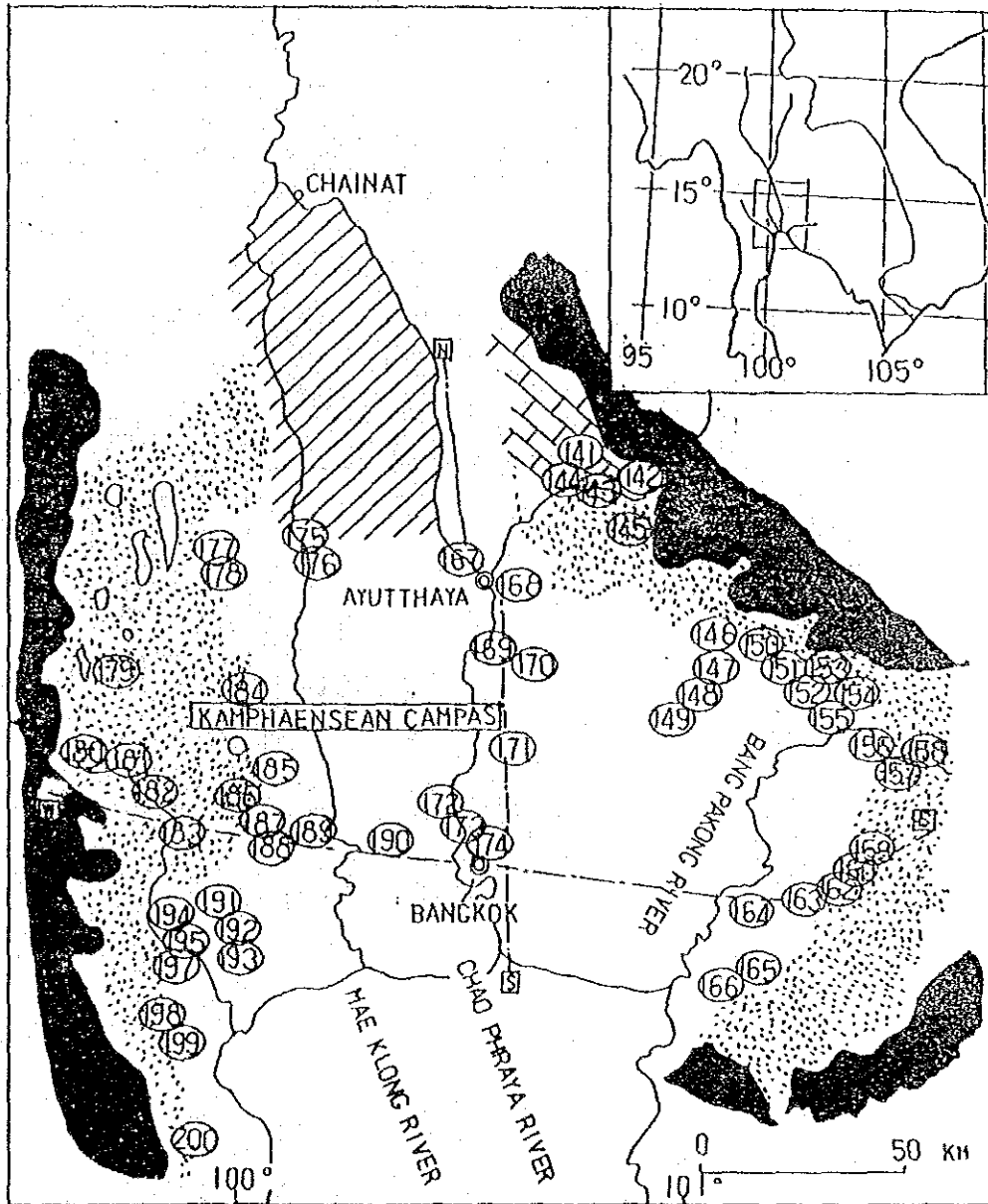





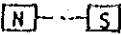
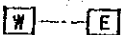

FIG. 2 LOCALITY MAP OF THE OUTCROPS
DESCRIBED IN THE PAPER



-  RECENT DELTA
 -  OLD DELTA
 -  FAN COMPLEX AREA
 -  CALCAREOUS AREA
 -  PRE-QUATERNARY AREA
-  N — S
 W — E
 CROSS-SECTIONS

water quality test : NO.1~NO.8

soil test : A~C

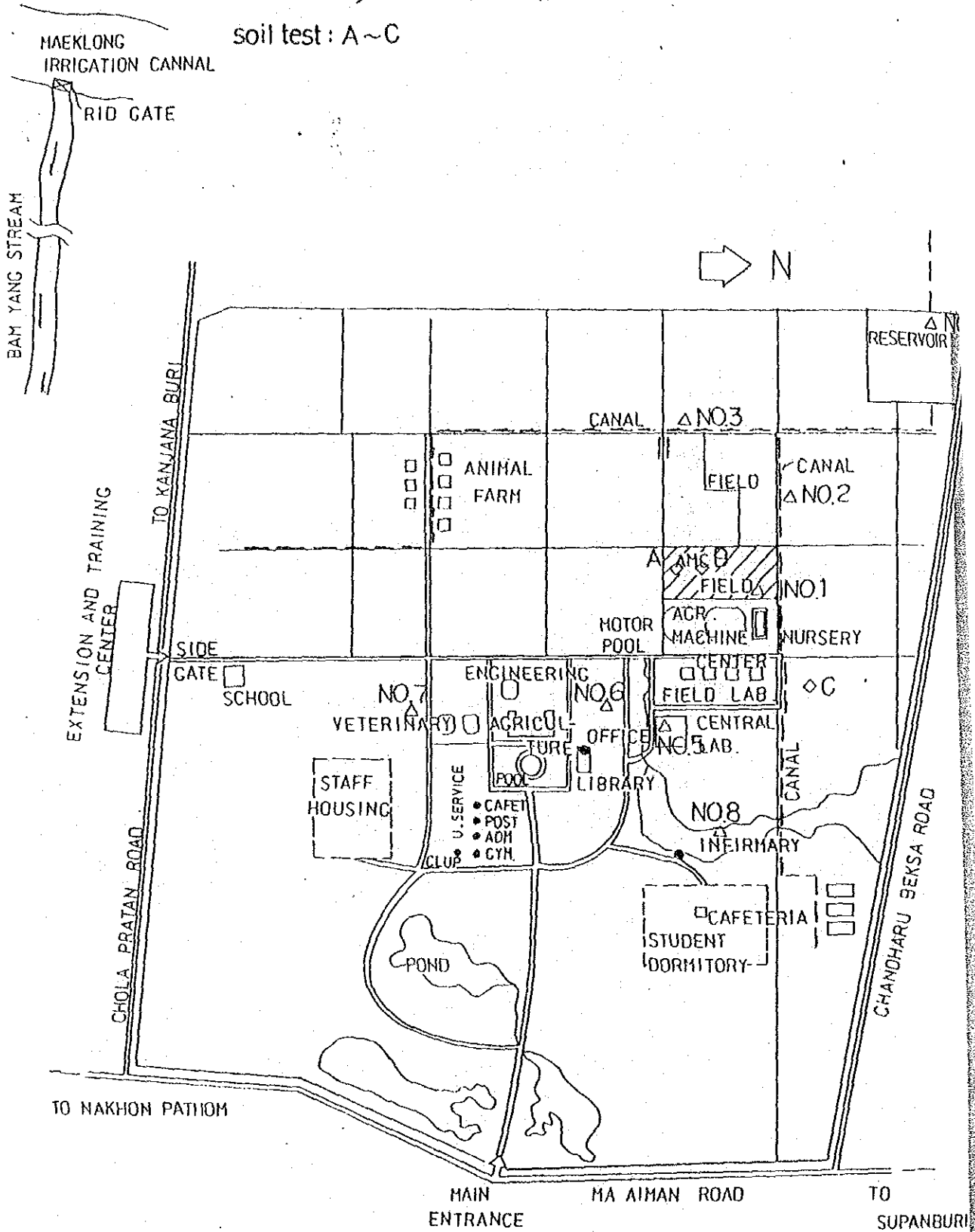

FIG. 3 LOCATION OF SAMPLING FOR THE WATERQUALITY AND SOI

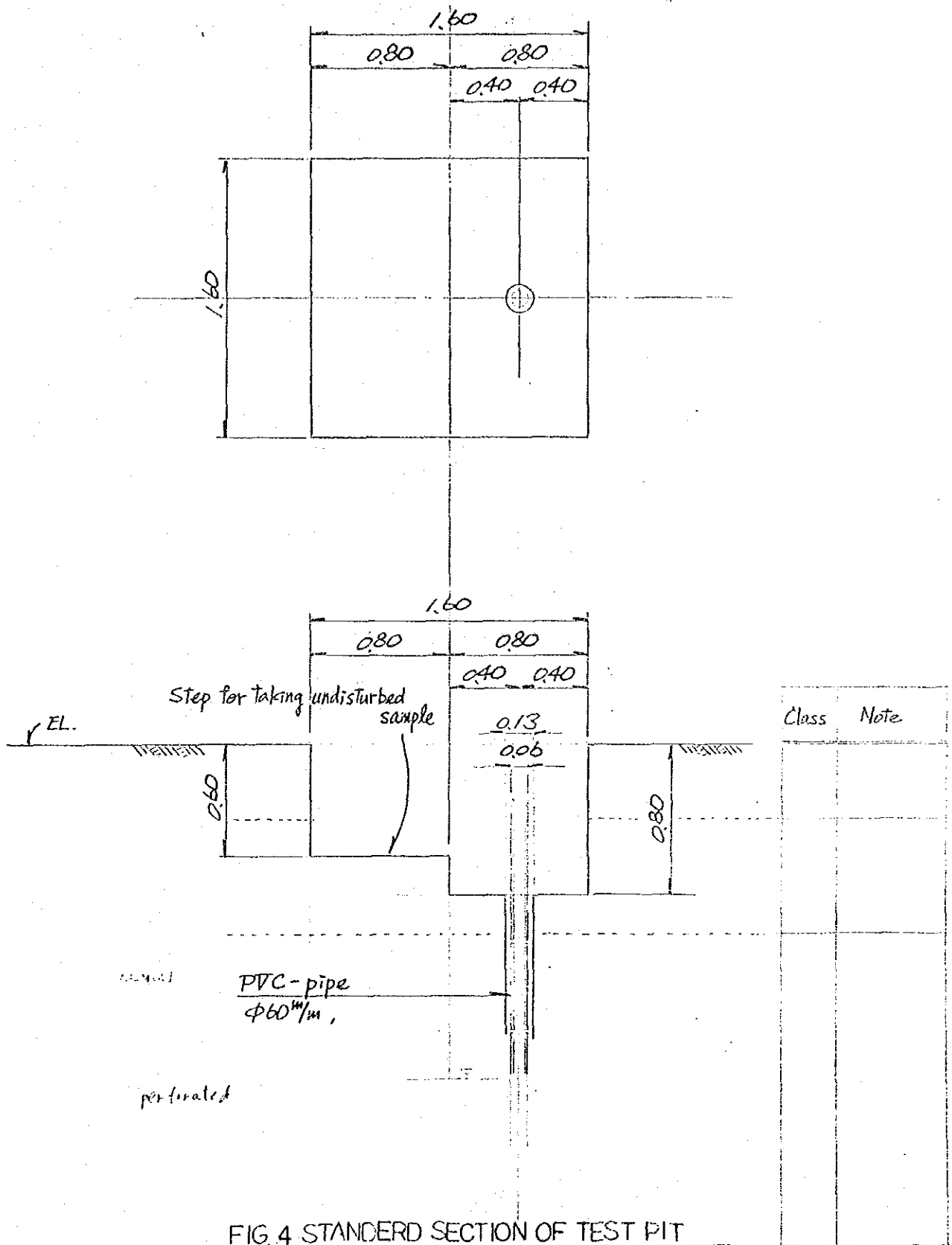
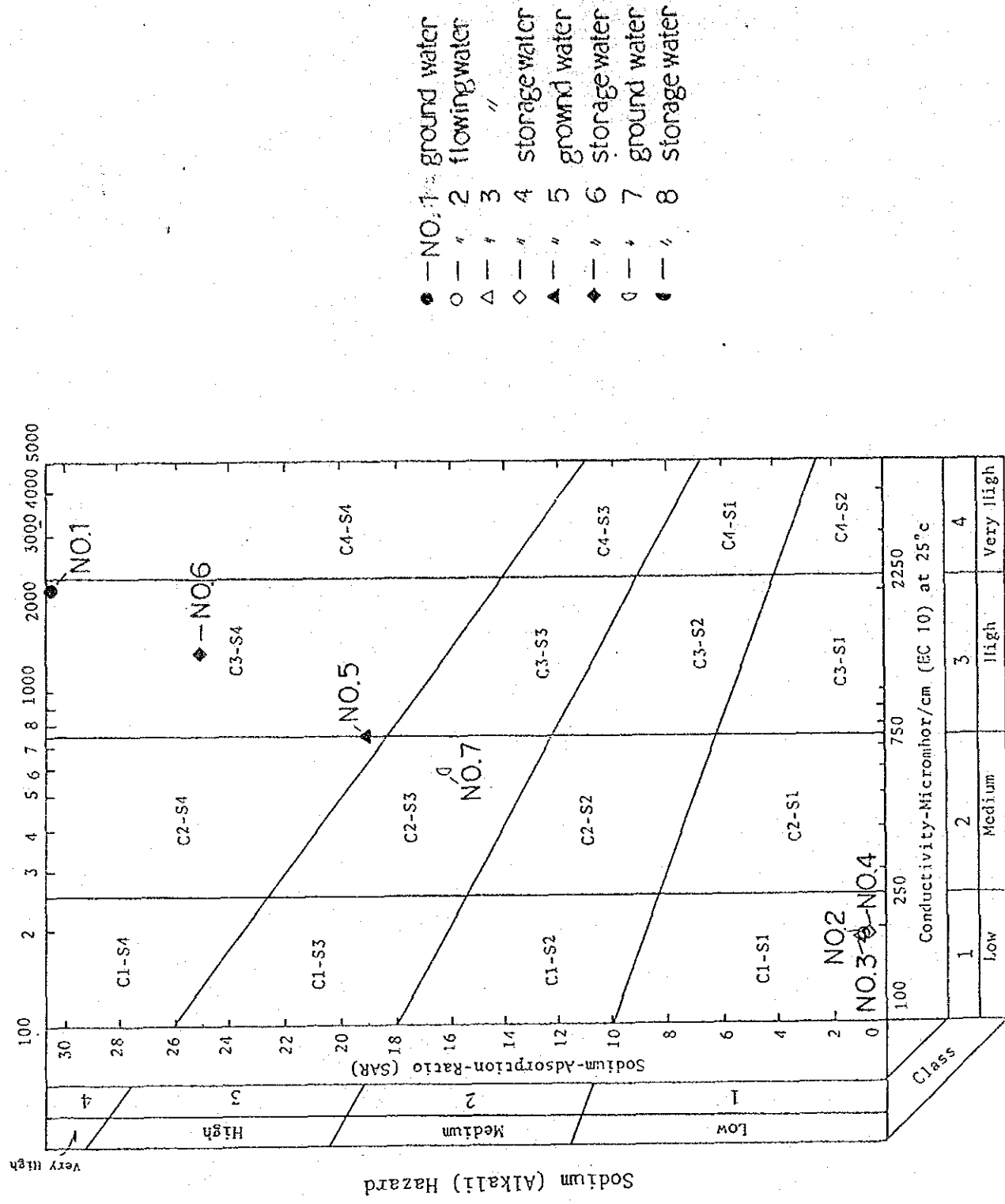

FIG. 4 STANDARD SECTION OF TEST PIT

Fig. 5 WATER QUALITY CLASSIFICATION
NO. 8



S ₁	Low sodium water can be used for irrigation in almost all soils with little danger of the development of harmful levels of exchangeable sodium. However, sodium sensitive crops such as stonefruit trees and avocados may accumulate injurious concentrations of sodium.	C ₁	Low salinity water can be used for irrigation with most crops on most soils with little likelihood that soil salinity will develop. Some leaching is required but this occurs under normal irrigation practices, except in soils of extremely low permeability.
S ₂	Medium water will present an appreciable sodium hazard in fine textured soils having high cation exchange capacity, especially under low leaching conditions unless gypsum is present in the soil. This water may be used on coarse textured or organic soils with good permeability.	C ₂	Medium salinity water can be used if a moderate amount of leaching occurs. Plants with moderate salt tolerance can be grown in most cases without special practices for salinity control.
S ₃	High sodium water may produce harmful levels of exchangeable sodium in most soils, and will require special soils management, good drainage, high leaching, and organic matter conditions. Gypsiferous soils may not develop harmful levels of exchangeable sodium from such water. Chemical amendments may be required for replacement of exchangeable sodium, except that amendments may not be feasible in the case of water of very high salinity.	C ₃	High salinity water cannot be used on soils with restricted drainage, even with adequate drainage, special treatment for salinity control may be required, and plants with good salt tolerance should be selected.
S ₄	Very high sodium water is generally unsatisfactory for irrigation purposes, except at low and perching medium salinity where the solution of calcium from the soil or used of gypsum or other amendments may make the use of these waters feasible.	C ₄	Very high salinity water is not suitable for irrigation under ordinary conditions, but may be used occasionally under very special circumstances. The soils must be permeable, drainage condition must be adequate, irrigation water must be applied in excess to provide considerable leaching and very salt-tolerance crops should be selected.

MAXIMUM DAILY RAINFALL
IN A YEAR

Date	Max Rainfall (mm/day)
1973. 3. Oct	81.3
1974. 9. Oct	68.8
1975. 29. Sep	57.8
1976. 6. May	74.5
1977. 19. Apr	99.2
1978. 3. Jun	147.4
1979. 24. Apr	86.9
1980. 1. Jun	70.1
1981. 17. Nov	65.6
1982. 11. Sep	74.4
1983. 15. Oct	78.2
1984. 15. May	63.3
1985. 11. Jun	115.6
1986. 28. Oct	79.4
1987. 27. Nov	71.1

FIG. 6 PROBABILITY ANALYSIS

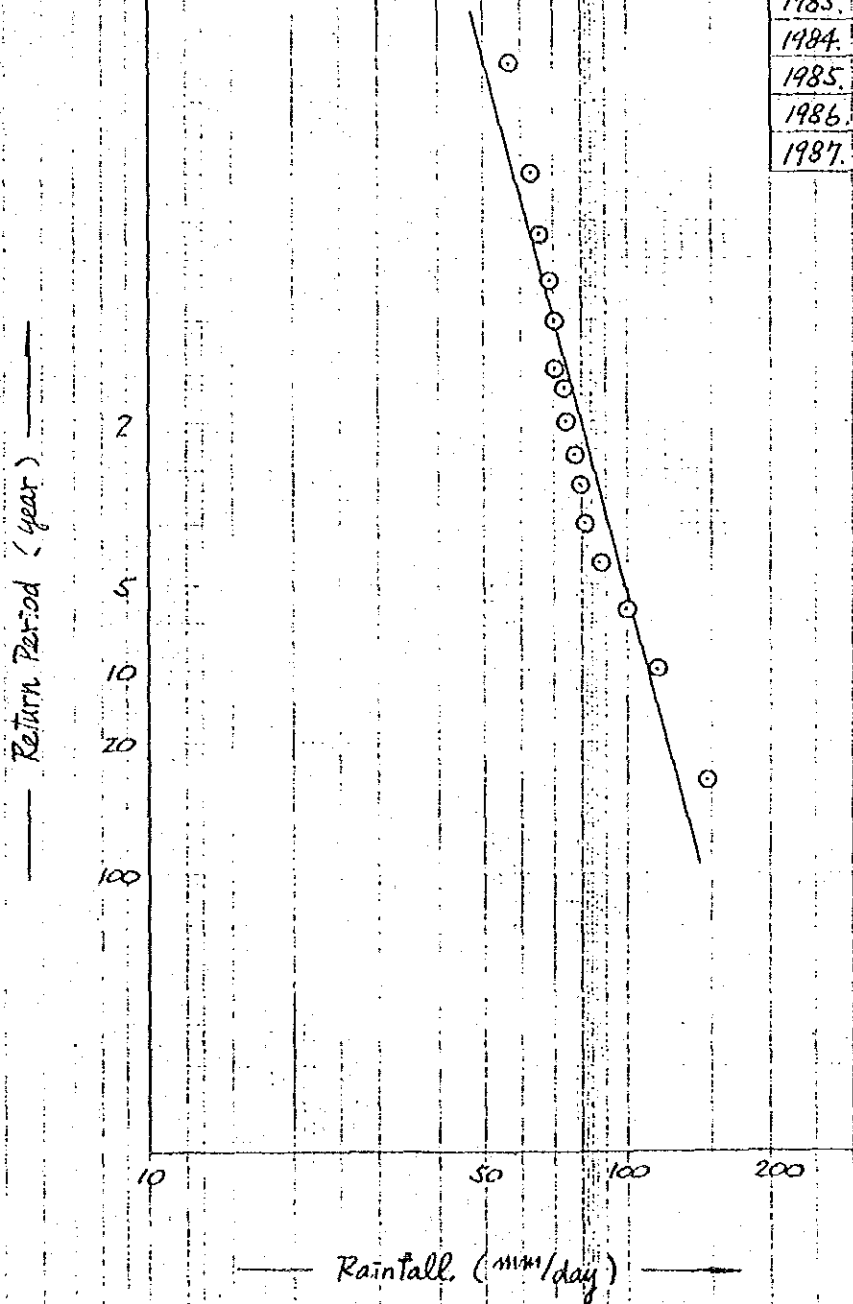

FIG. 7 LOCATION OF RID CANAL

