

FIGURES

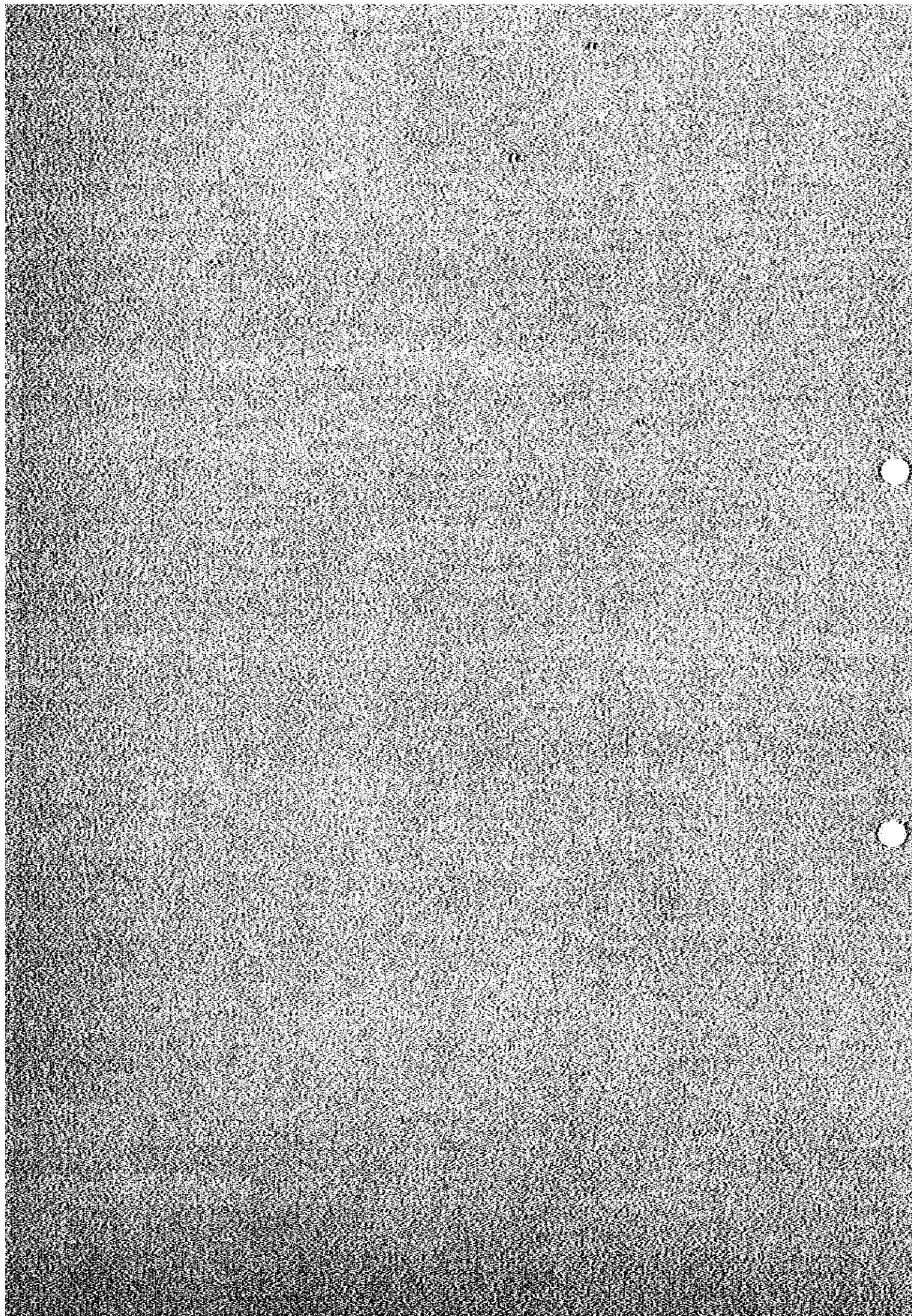

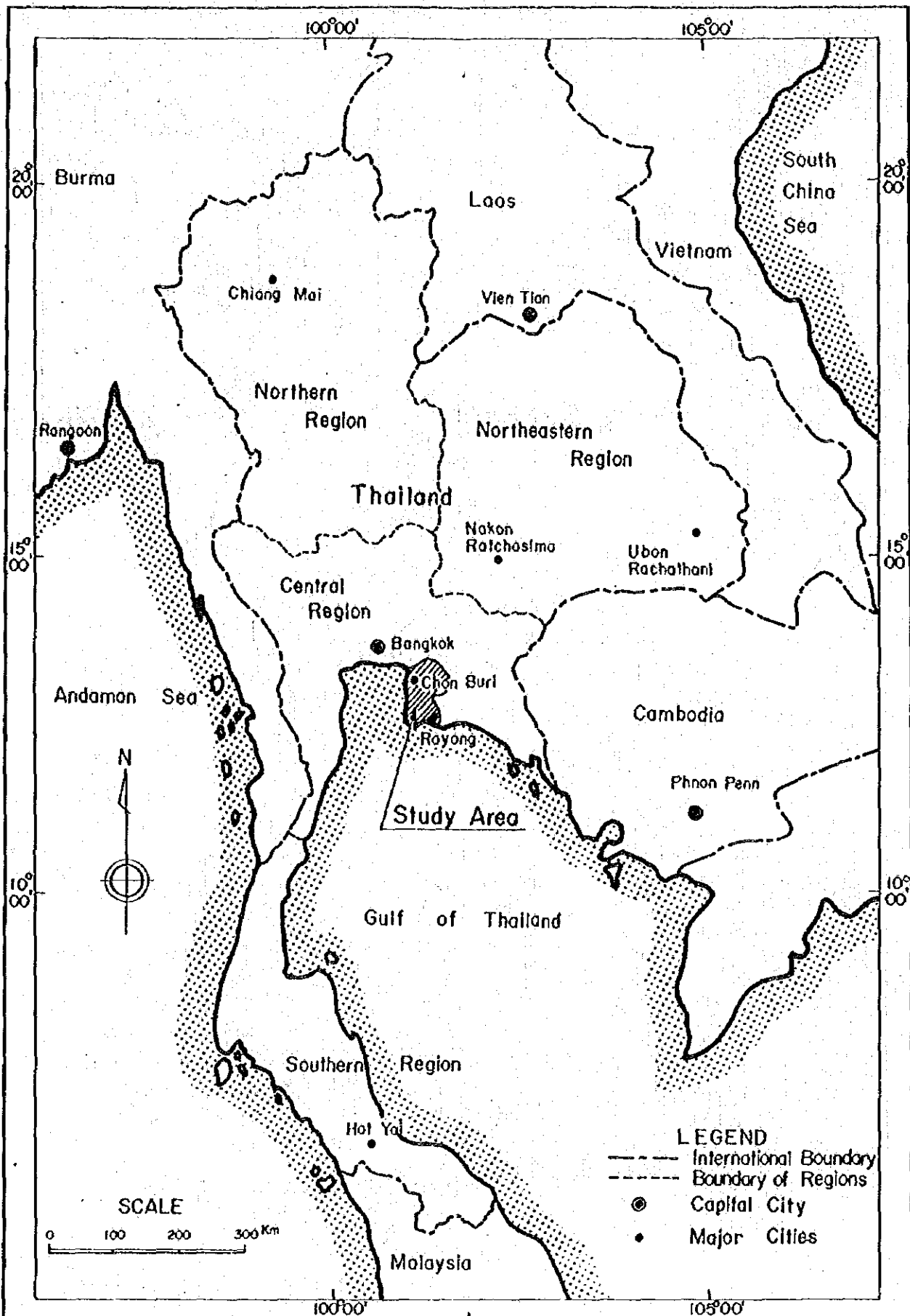

Fig. 1 Map of Thailand

KINGDOM OF THAILAND
 THE EAST COAST WATER RESOURCES
 DEVELOPMENT PROJECT PHASE II
 JAPAN INTERNATIONAL COOPERATION AGENCY

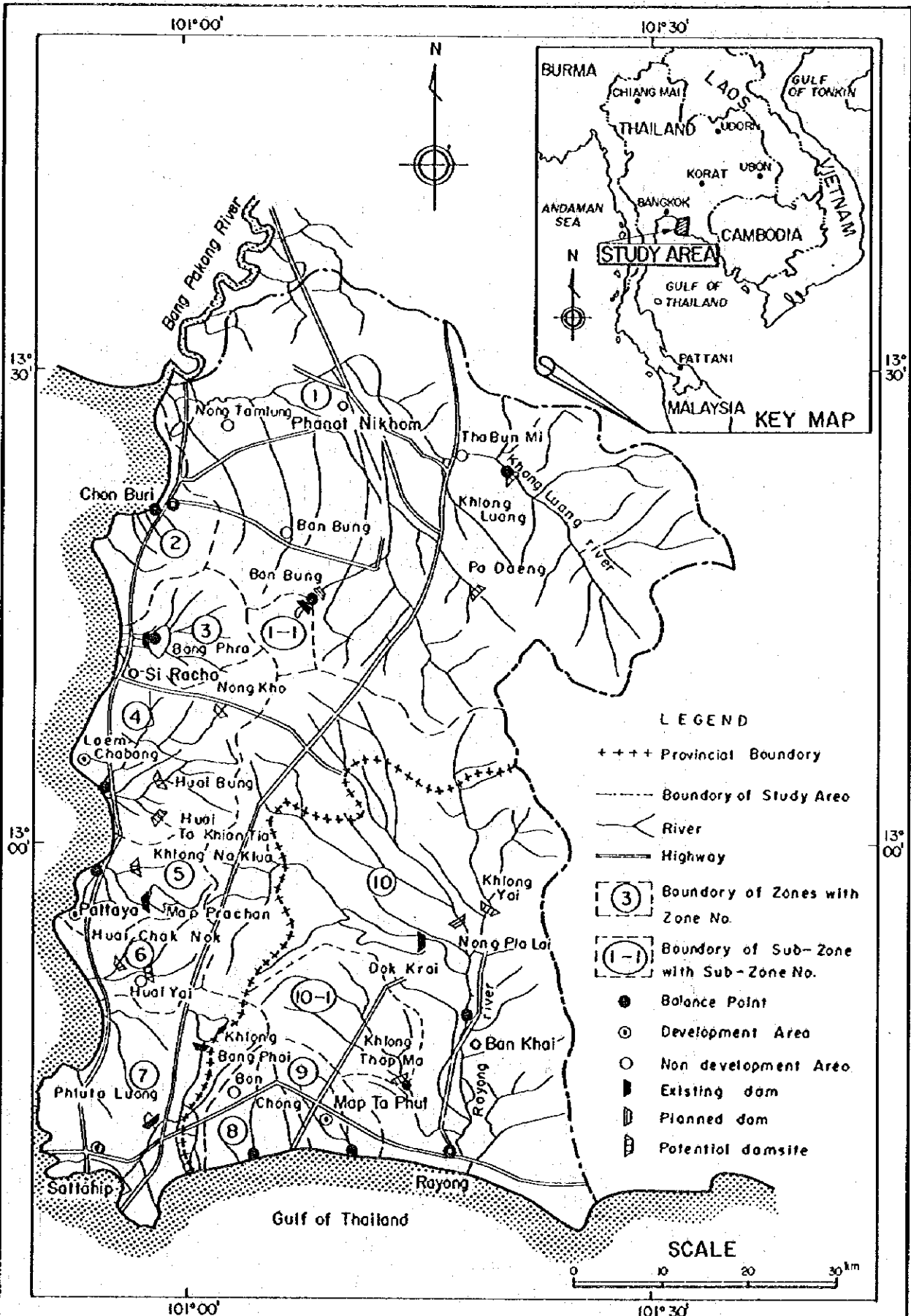
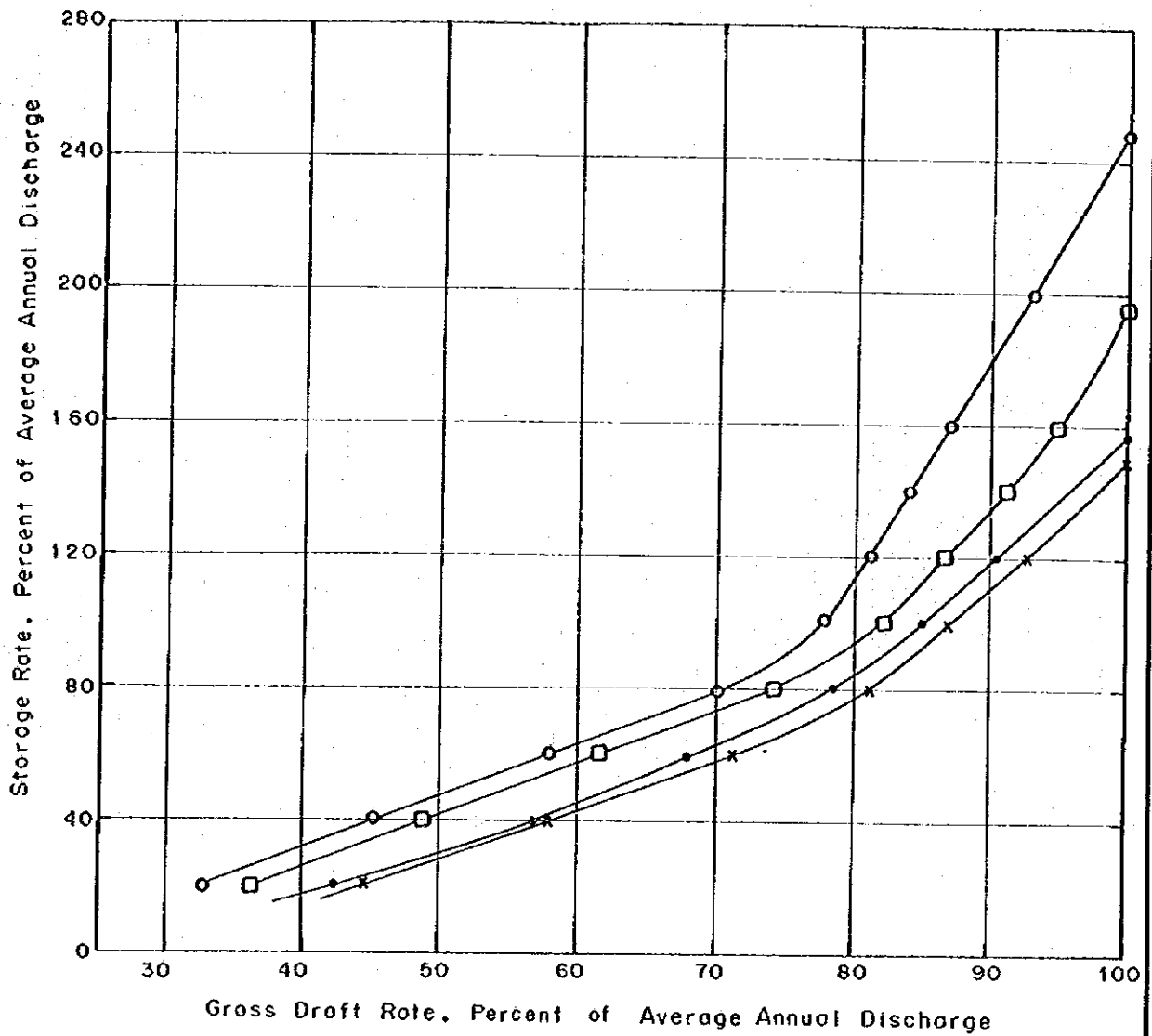

Fig. 2 Map of Study Area

KINGDOM OF THAILAND
 THE EAST COAST WATER RESOURCES
 DEVELOPMENT PROJECT PHASE II
 JAPAN INTERNATIONAL COOPERATION AGENCY



LEGEND

- —● Dok Kroi reservoir, applicable to all existing reservoirs, Khlong Thap Mo and all potential reservoirs, except Pa Doeng
- x —x Nong Plo Lai reservoir
- —○ Khlong Luong reservoir, applicable to Pa Doeng
- —□ Khlong Yoi reservoir

Fig. 3 Storage - Drift Curve

KINGDOM OF THAILAND
 THE EAST COAST WATER RESOURCES
 DEVELOPMENT PROJECT PHASE II
 JAPAN INTERNATIONAL COOPERATION AGENCY

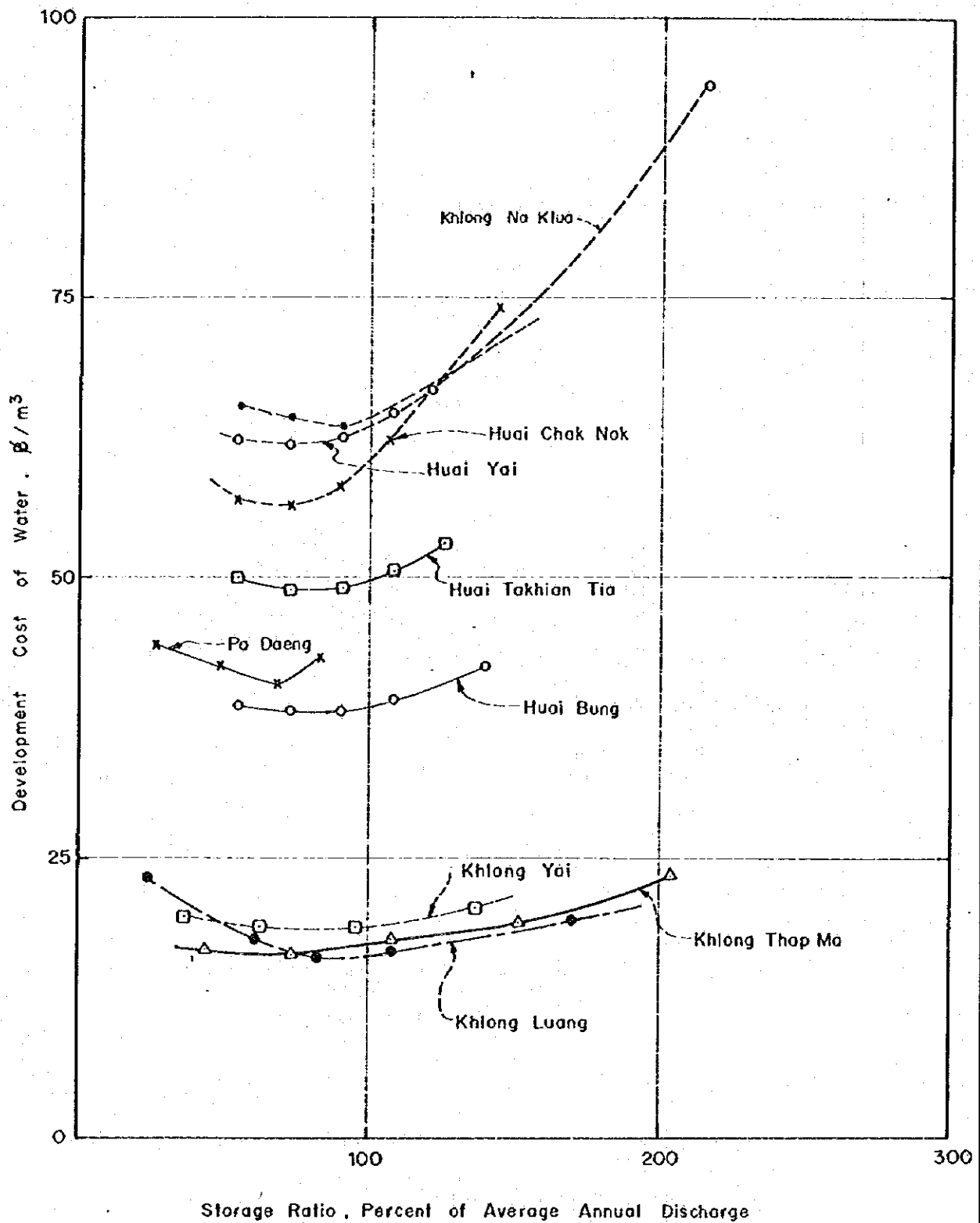

Fig. 4 Relation between Storage Ratio and Development Cost of Water

KINGDOM OF THAILAND
 THE EAST COAST WATER RESOURCES
 DEVELOPMENT PROJECT PHASE II
 JAPAN INTERNATIONAL COOPERATION AGENCY

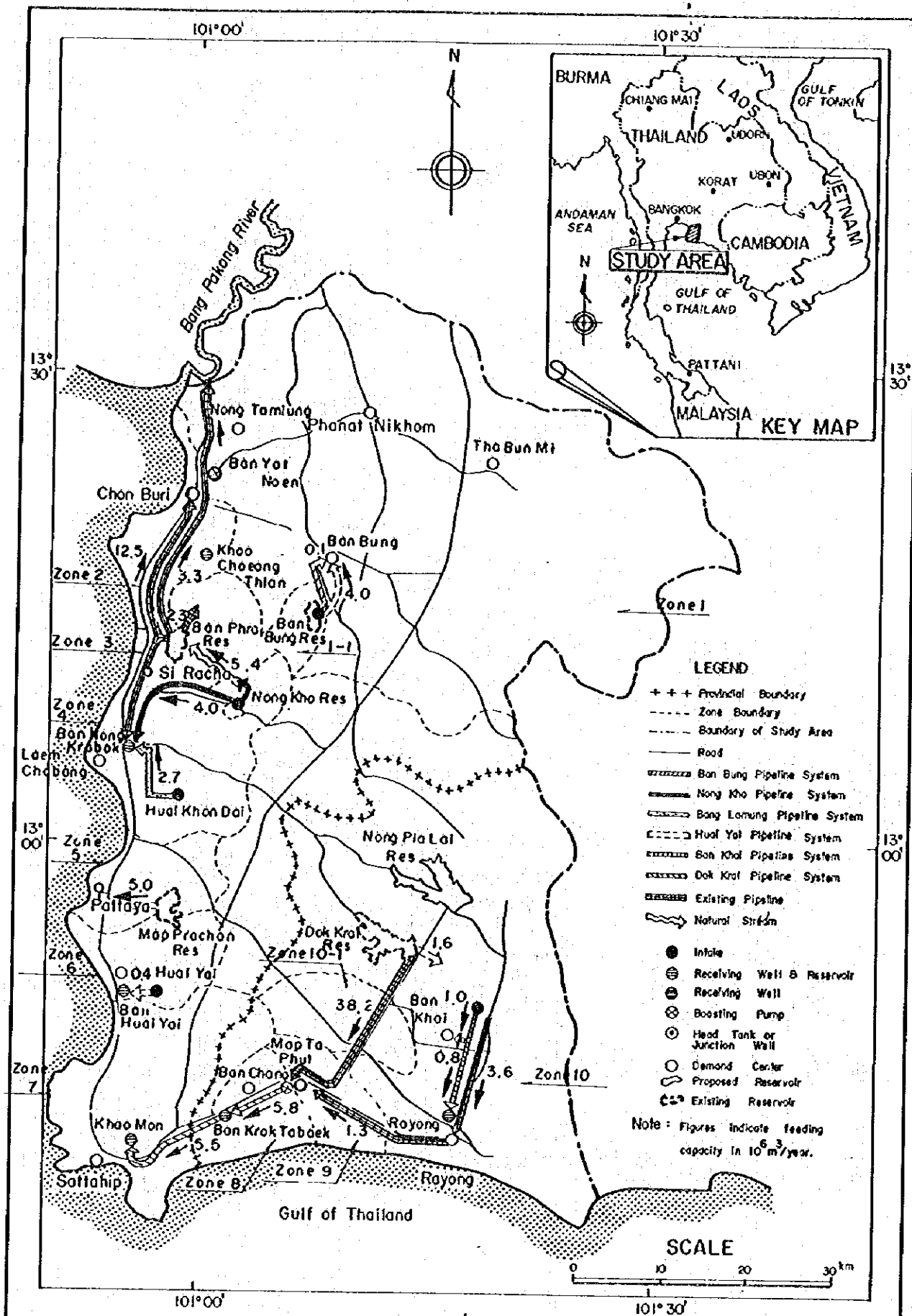

Fig. 5 General Layout of Proposed Development Plan for 1986

KINGDOM OF THAILAND
 THE EAST COAST WATER RESOURCES
 DEVELOPMENT PROJECT PHASE II
 JAPAN INTERNATIONAL COOPERATION AGENCY

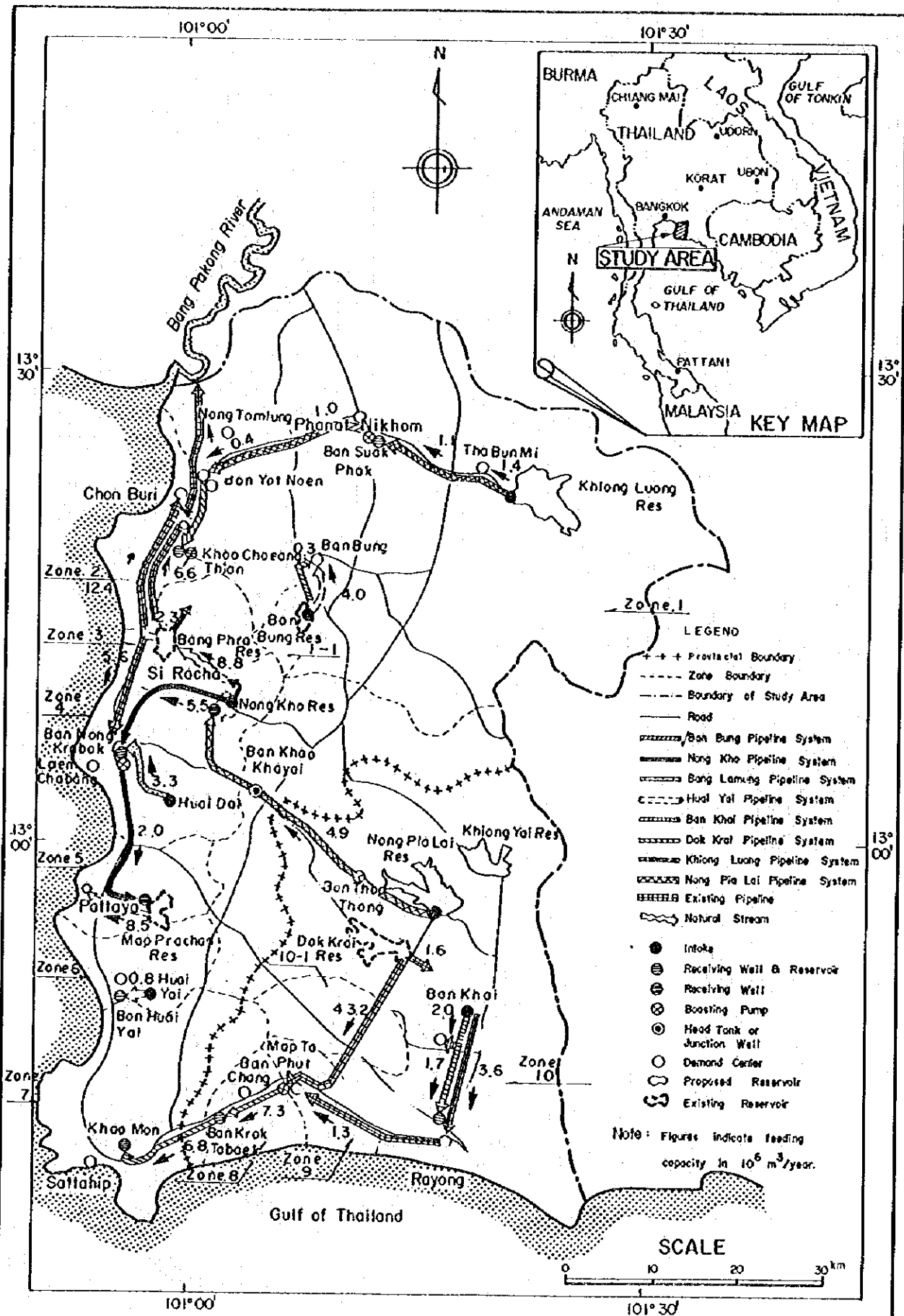

Fig. 6 General Layout of Proposed Development Plan for 1991

KINGDOM OF THAILAND
 THE EAST COAST WATER RESOURCES
 DEVELOPMENT PROJECT PHASE II
 JAPAN INTERNATIONAL COOPERATION AGENCY

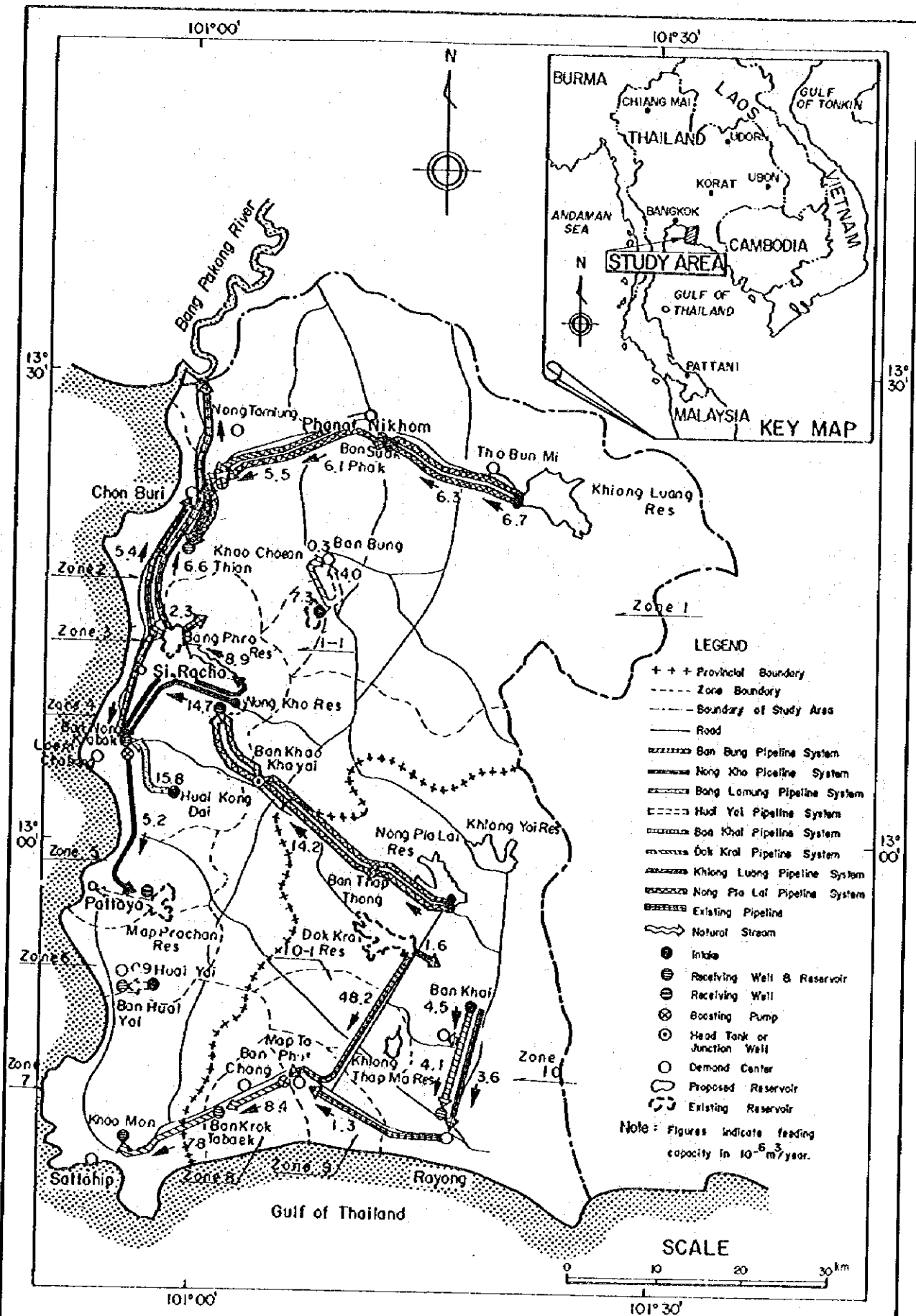

Fig. 7 General Layout of Proposed Development Plan for 1996

KINGDOM OF THAILAND
 THE EAST COAST WATER RESOURCES
 DEVELOPMENT PROJECT PHASE II
 JAPAN INTERNATIONAL COOPERATION AGENCY

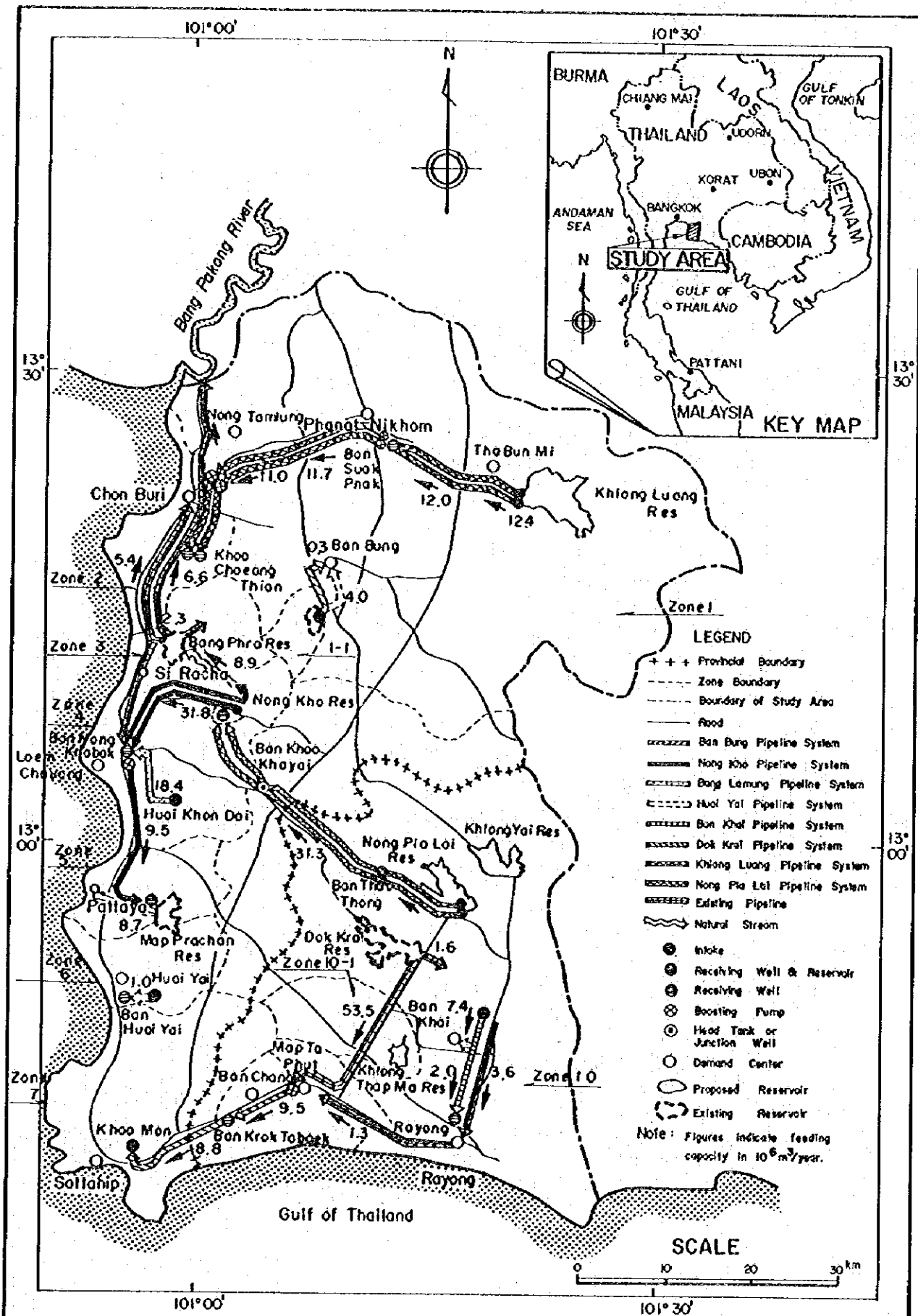

Fig. 8 General Layout of Proposed Development Plan for 2001

KINGDOM OF THAILAND
 THE EAST COAST WATER RESOURCES
 DEVELOPMENT PROJECT PHASE II
 JAPAN INTERNATIONAL COOPERATION AGENCY

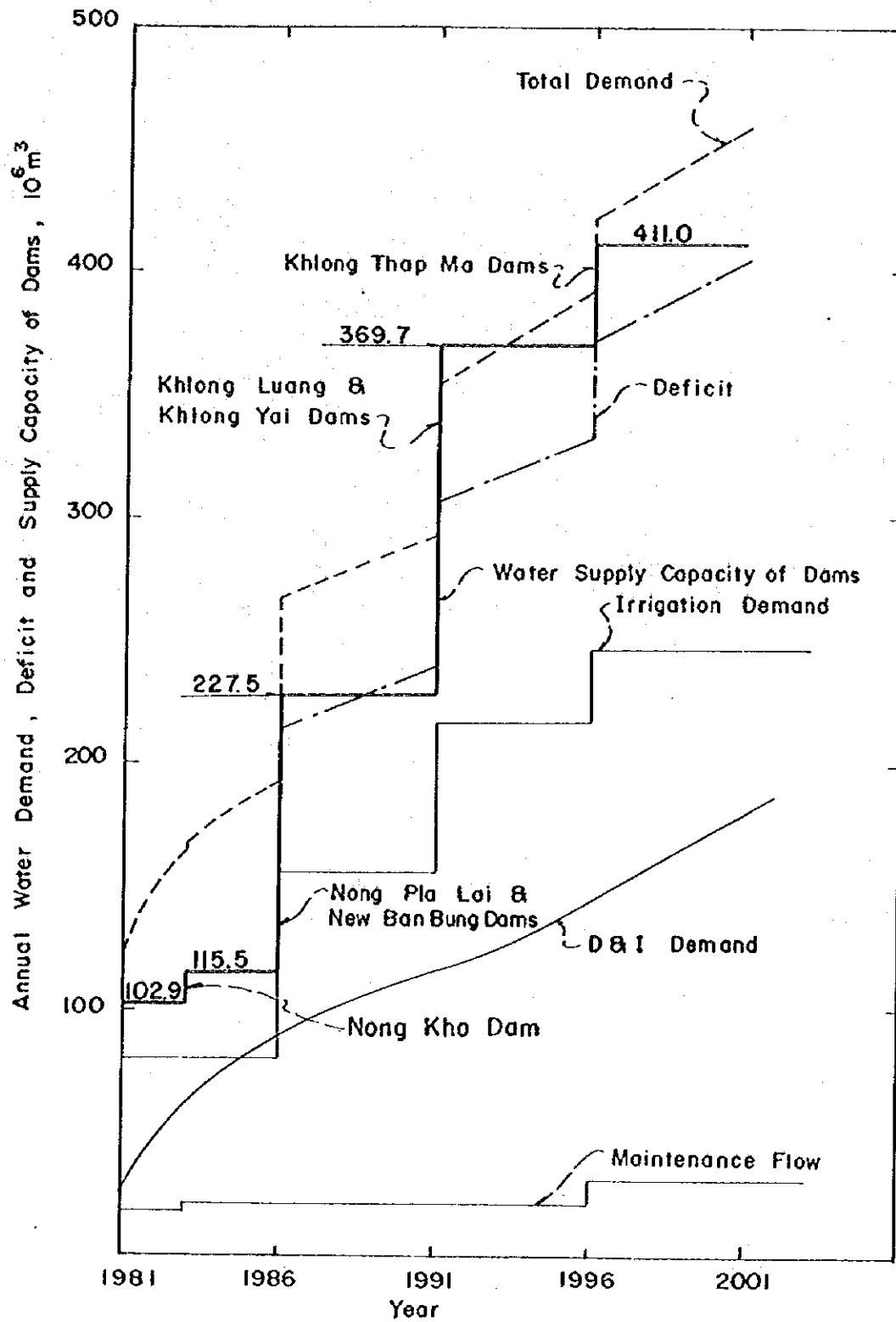
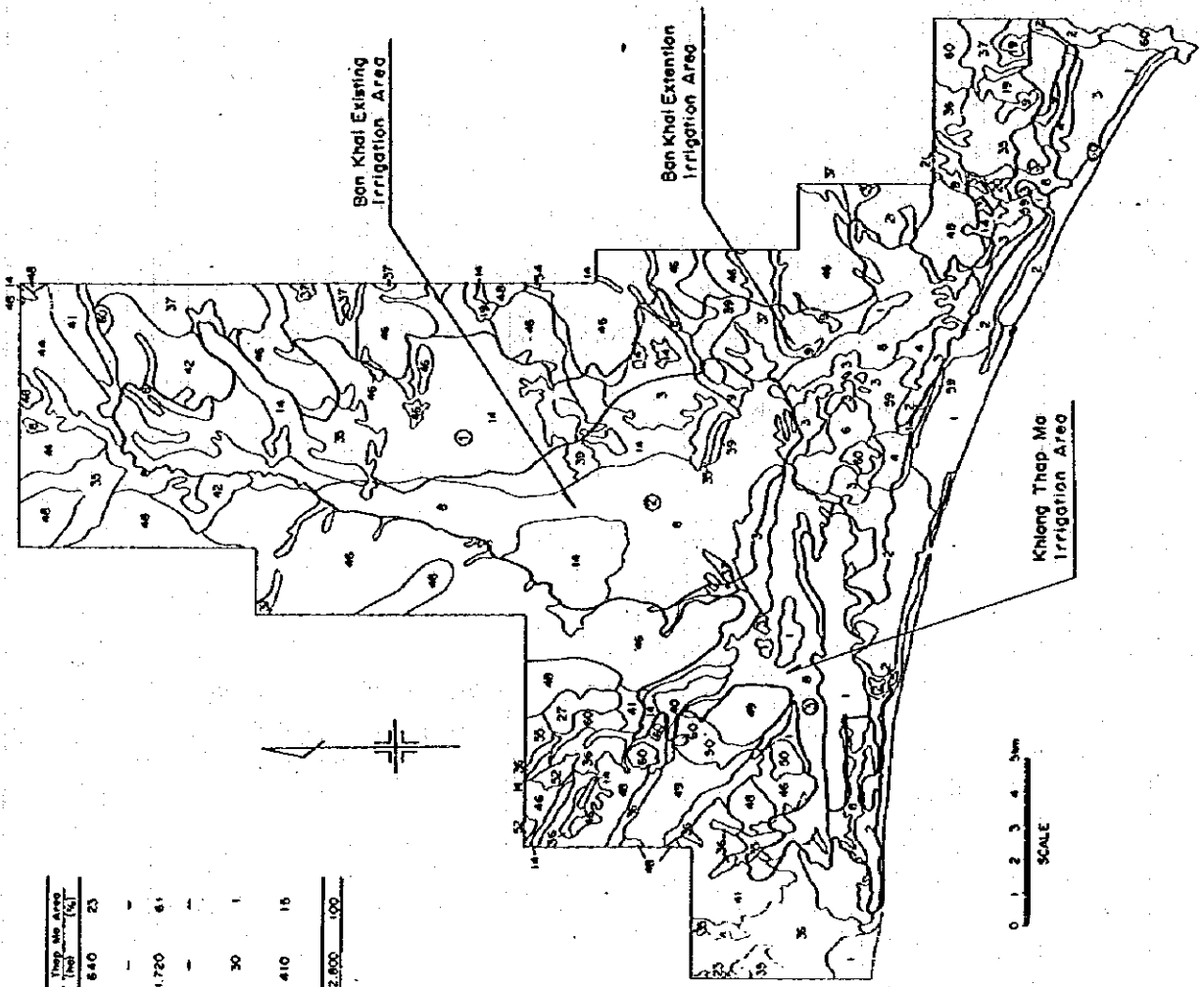

Fig. 9 Relationship among Water Demand, Deficit and Water Supply Capacity of Dams



Topography	Materials	Soil Series No.	Study Area	Soil Extention Area	Soil Extention Area	Soil Extention Area	Top. Slope Area
Beach and Sand Bars	Beach and Sand Bars	1, 2, 3, 4	Extent (Ha)	(No)	(No)	(No)	(No)
	Beach Deposits		(%)	(%)	(%)	(%)	(%)
Yield, Paddy	Beach Deposits	6	300	3	-	-	-
Altered Paddy	Alluvium	6, 9, 12, 14	12,480	30	4,280	48	1,720
Remnant of Low Residual Hill	Alluvium or Colluvium	19, 20, 21, 27, 34	770	2	30	-	-
Interspersed embankment and Residual from beach barriers	Transported Materials	36, 37	4,680	11	1,060	12	30
	Gravels and Bricks		38, 40, 41, 42, 43	16,590	39	1,780	20
	Other		44, 45, 46, 48, 49, 50				
	Residual (excluding the rolling topography)		52, 53, 55, 56				
			Total	42,290	100	3,400	100
							2,800
							100

- ① Ban Khai Extension Area
- ② Ban Khai Existing Area
- ③ Khlong Thap Ma Area

Fig.10 Soil Map of the Rayong Area

Capability Class	Study Area	Ban Khai Extension Area		Ban Khai Existing Area		Thap Ma Area	
		(ha)	(%)	(ha)	(%)	(ha)	(%)
II	12,460	4,620	31	4,700	87	760	27
IV	980	420	5	—	—	80	3
V	26,070	2,780	31	630	12	1,120	40
V/III	2,190	1,040	12	70	1	840	30
V/IV	990	140	1	—	—	—	—
Total	42,290	9,000	100	5,400	100	2,800	100

- ① Ban Khai Extension Area
- ② Ban Khai Existing Area
- ③ Khong Thap Ma Area

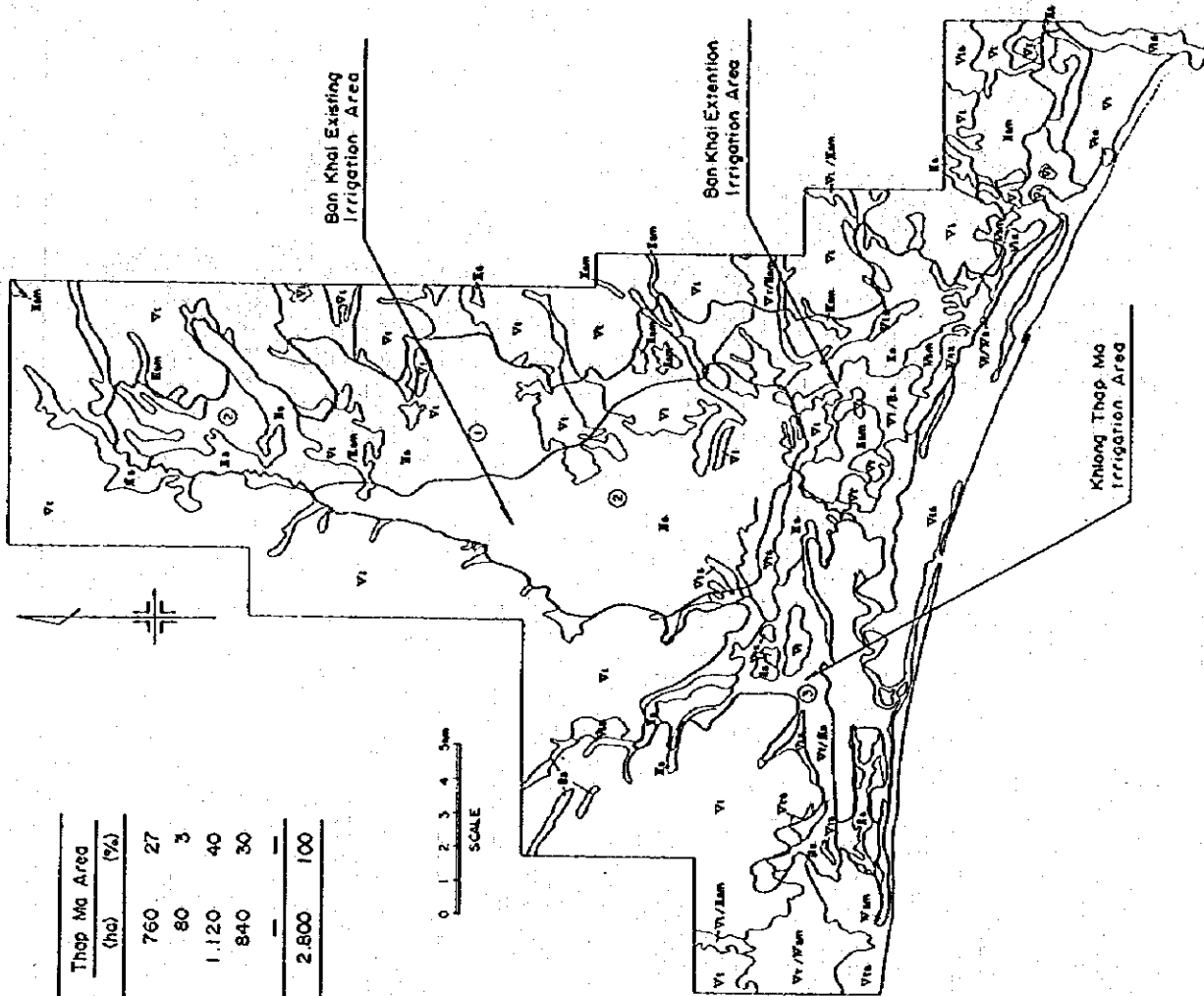

Fig.11 Land Capability Map for Paddy of the Rayong Area

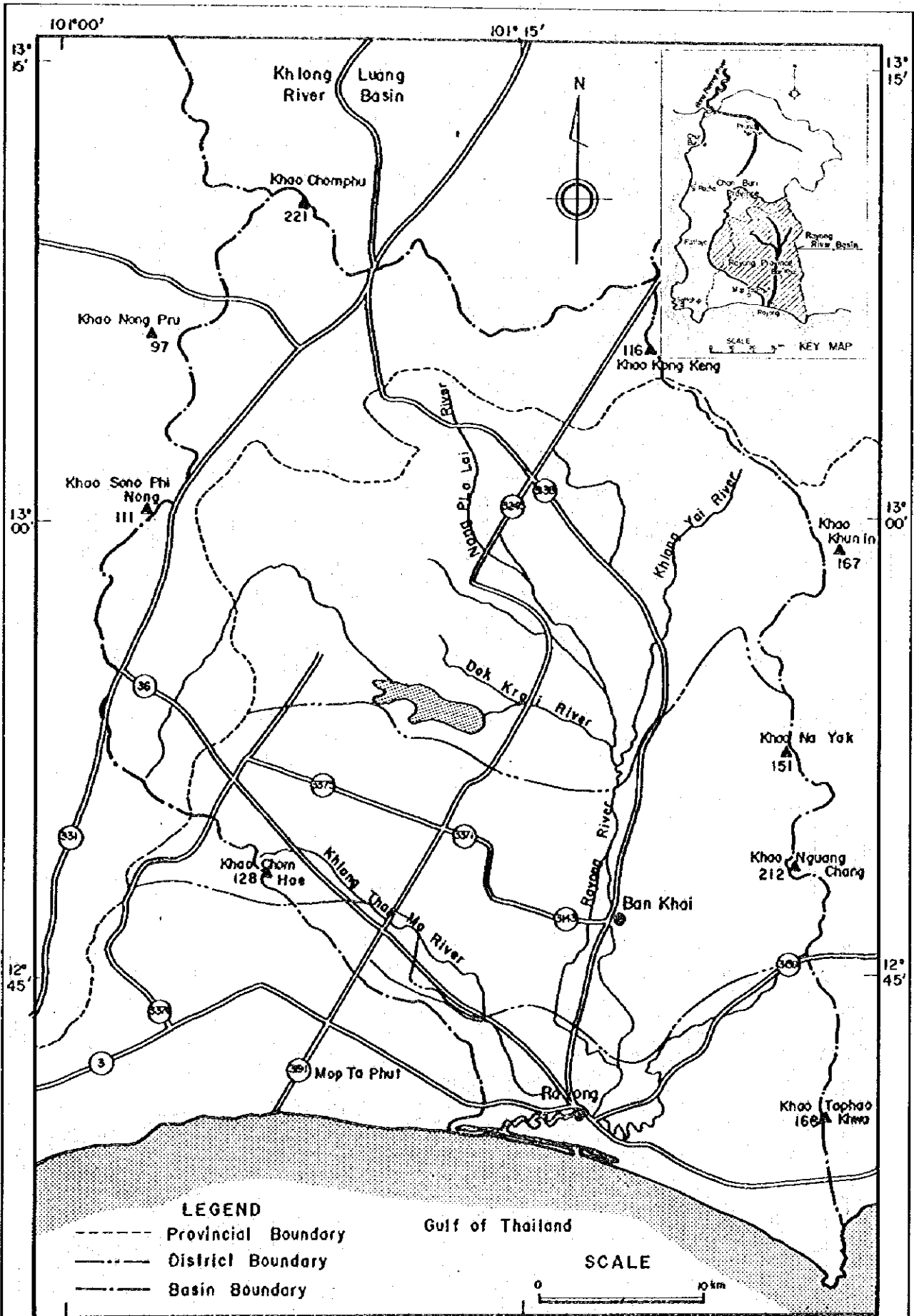

Fig.12 Map of Rayong River Basin

KINGDOM OF THAILAND
 THE EAST COAST WATER RESOURCES
 DEVELOPMENT PROJECT PHASE II
 JAPAN INTERNATIONAL COOPERATION AGENCY

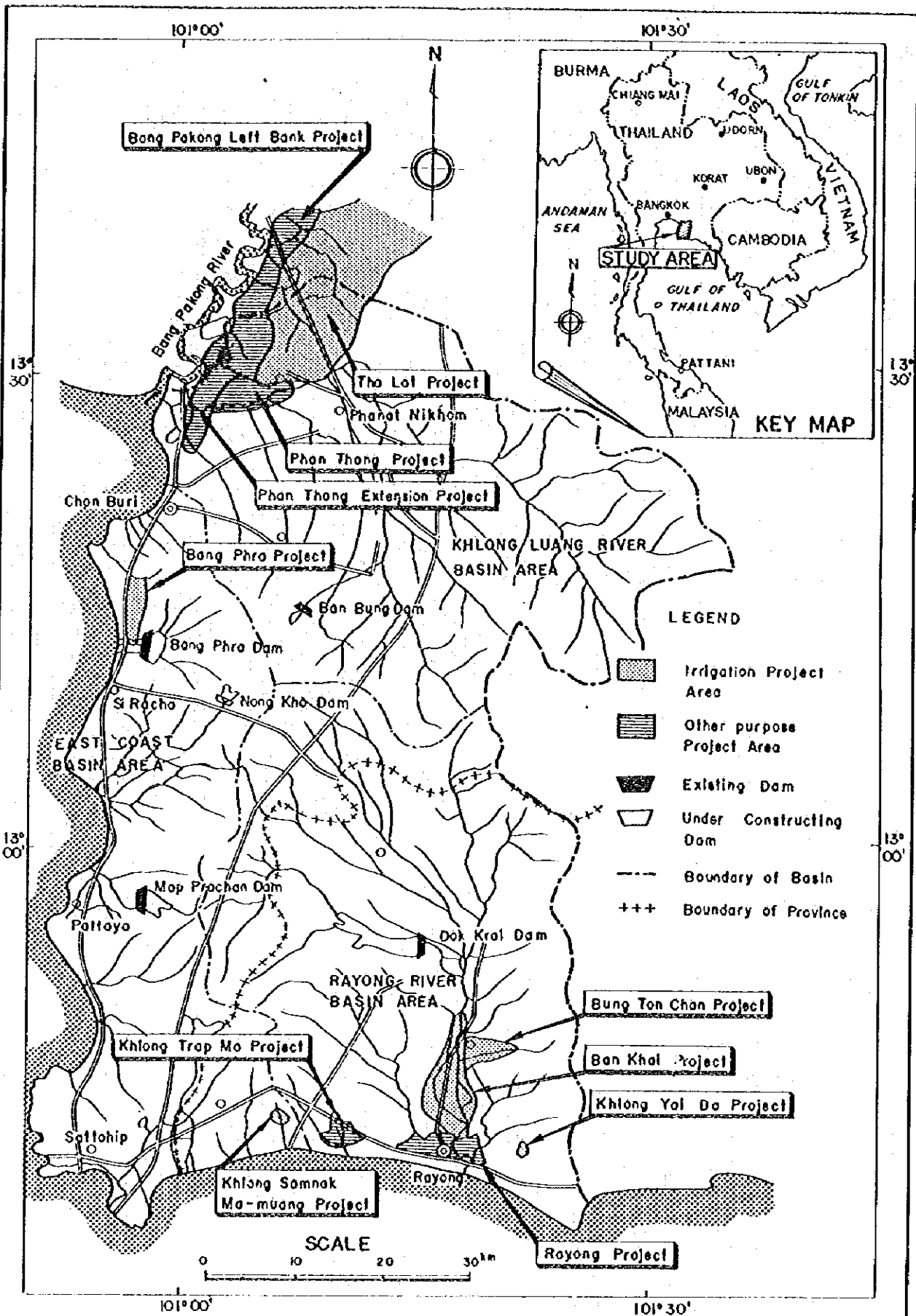
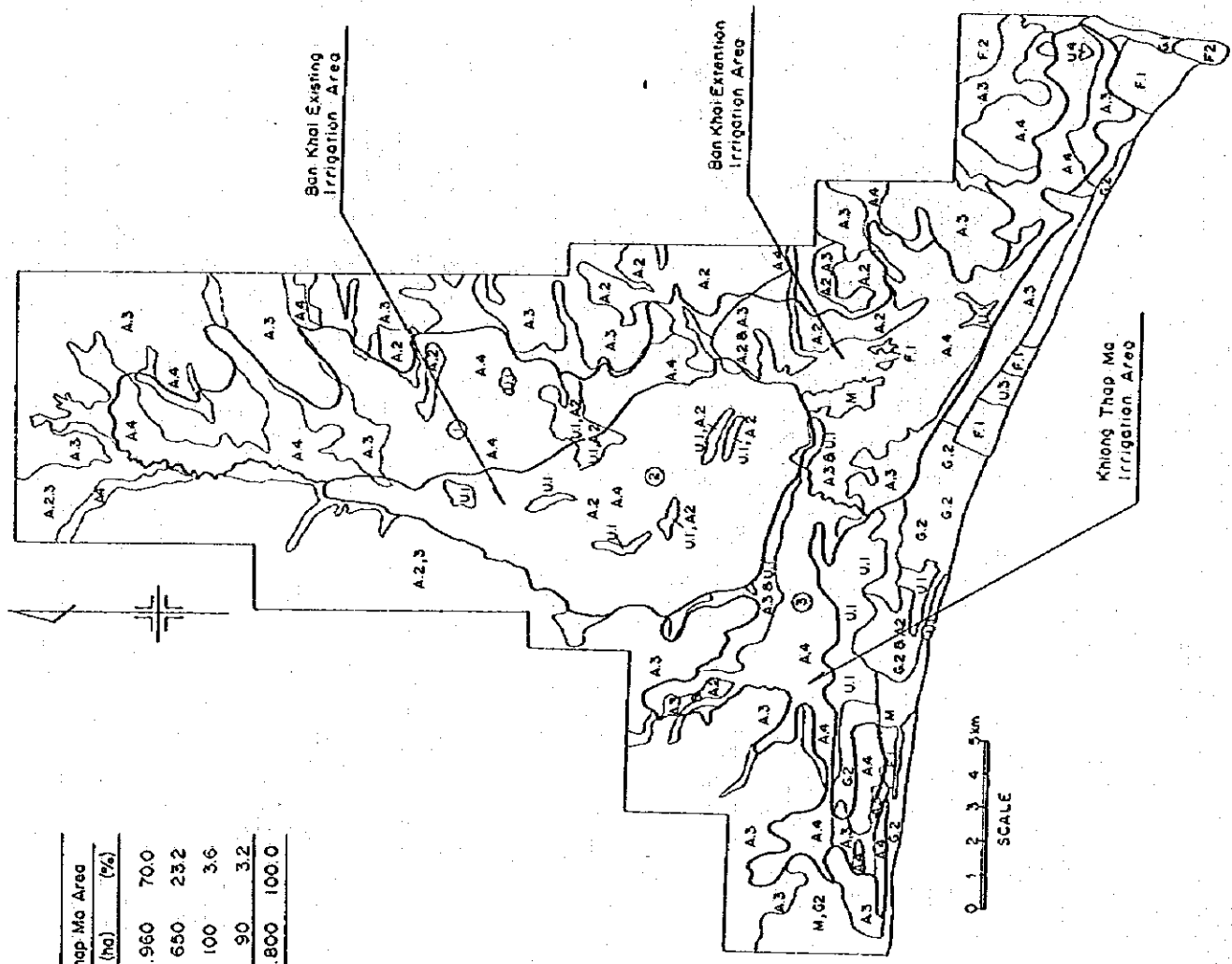

Fig.13 Location of Existing Irrigation Project

KINGDOM OF THAILAND
 THE EAST COAST WATER RESOURCES
 DEVELOPMENT PROJECT PHASE II
 JAPAN INTERNATIONAL COOPERATION AGENCY



Land Use	Ban Khai Extension Area		Ban Khai Existing Area		Thap Ma Area	
	(ha)	(%)	(ha)	(%)	(ha)	(%)
Rice Field	6,310	70.1	4,800	88.9	1,960	70.0
Upland Crop Field	1,900	21.1	100	1.9	650	23.2
Perennial Crop	580	6.4	-	-	100	3.6
Others	210	2.4	500	9.2	90	3.2
Total	9,000	100.0	5,400	100.0	2,800	100.0

- ① Ban Khai Extension Area
- ② Ban Khai Existing Area
- ③ Khlong Thap Ma Area

LEGEND

Class	Subclass	Map Symbol
Urban area	Residential and commercial	U.1
	Institutional	U.3
	Agricultural land	A.2
Crop	Perennial crop	A.2
	Field crop	A.3
	Raddy field	A.4
Grassland	Unimproved grassland	G.2
Forest	Lowland and peatmoor forest	F.1
	Hill and mountain	F.2 *
Marsh and Swamp		M

Fig.14 Present Land Use Map of the Rayong Area

Ban Khai Extension Irrigation Scheme

Present

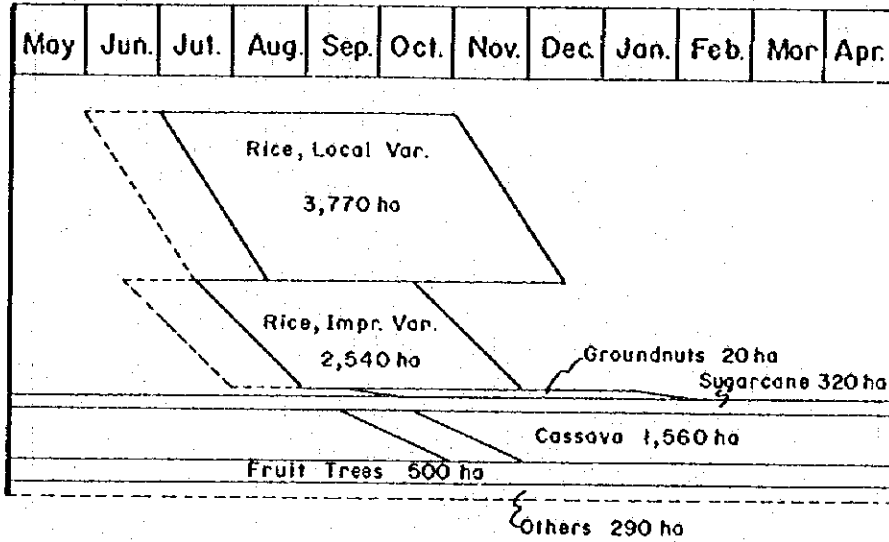

Proposed

(Cropping Intensity 1.4)

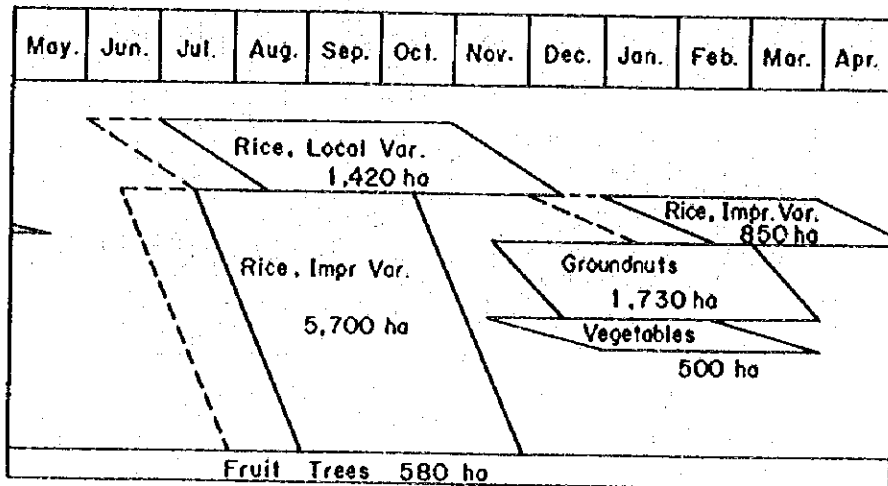
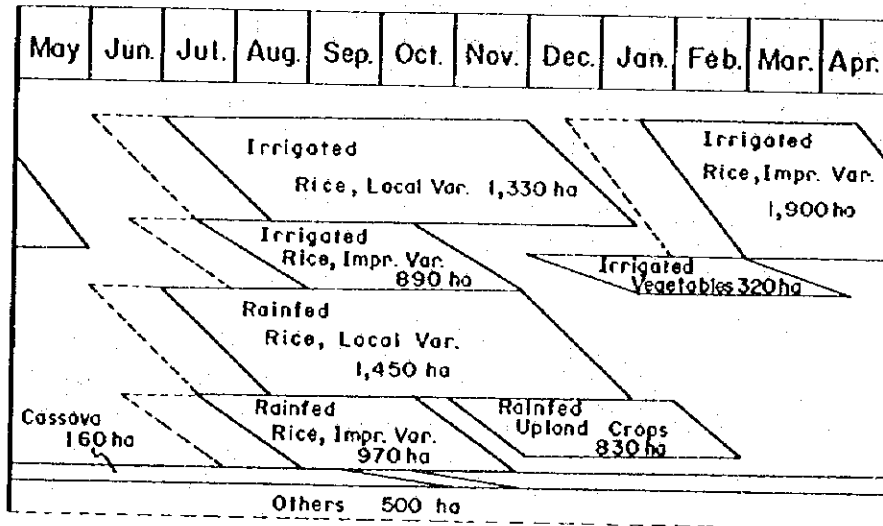

Fig.15 Present and Proposed Cropping Patterns

Ban Khai Existing Irrigation Scheme

Present



Proposed

(Cropping Intensity : 1.4)

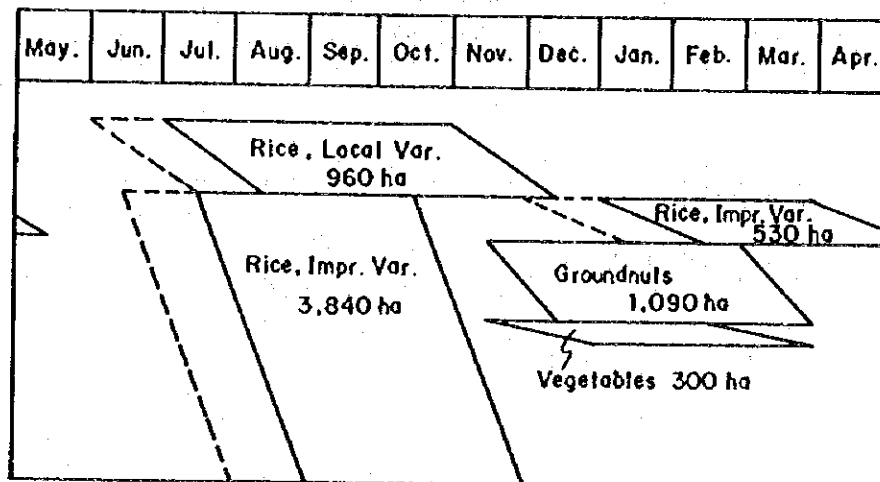

Fig. 16 Present and Proposed Cropping Patterns

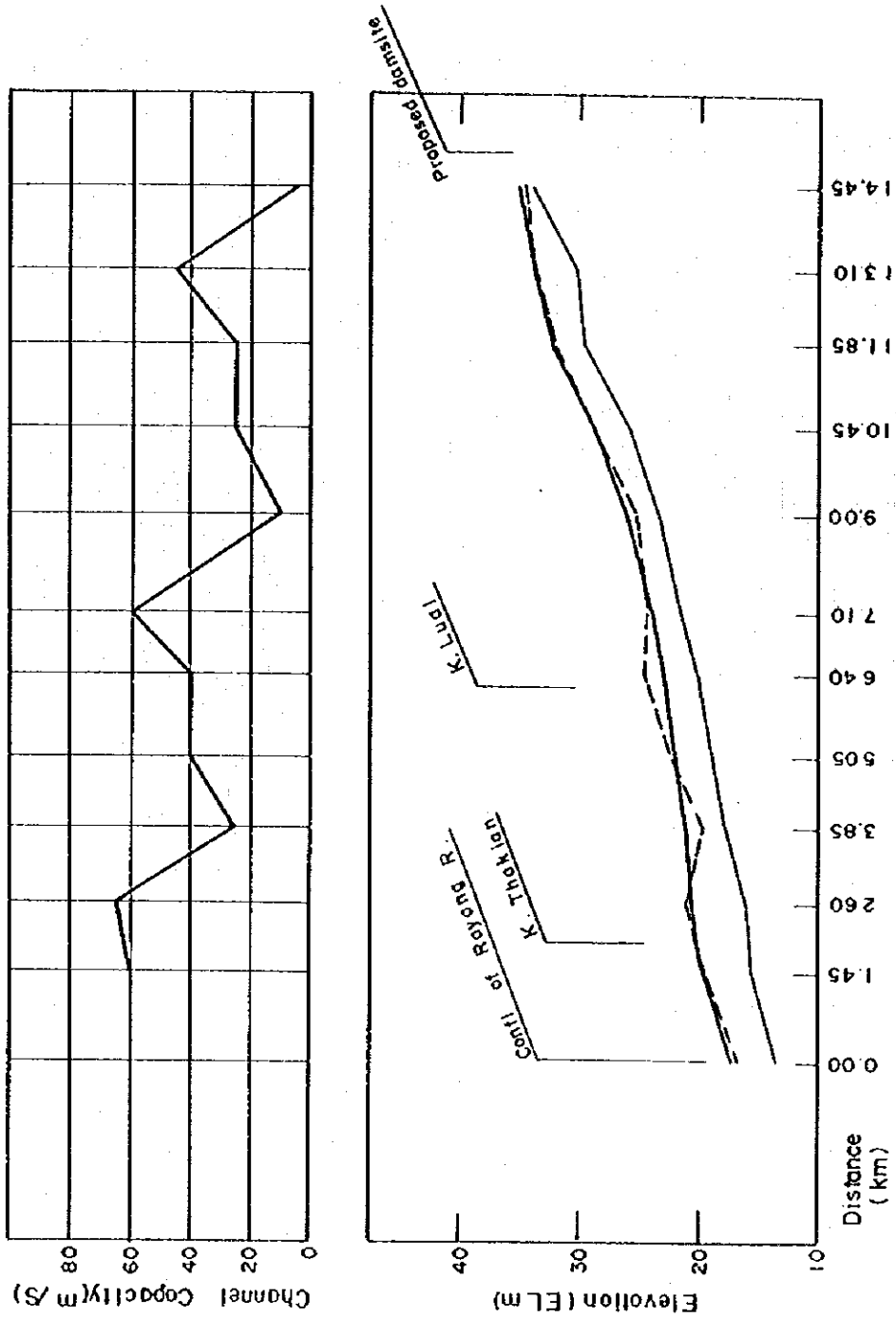

Fig.17 Longitudinal Profile and Channel Capacity of Khlong Yai River

KINGDOM OF THAILAND
 THE EAST COAST WATER RESOURCES
 DEVELOPMENT PROJECT PHASE II
 JAPAN INTERNATIONAL COOPERATION AGENCY

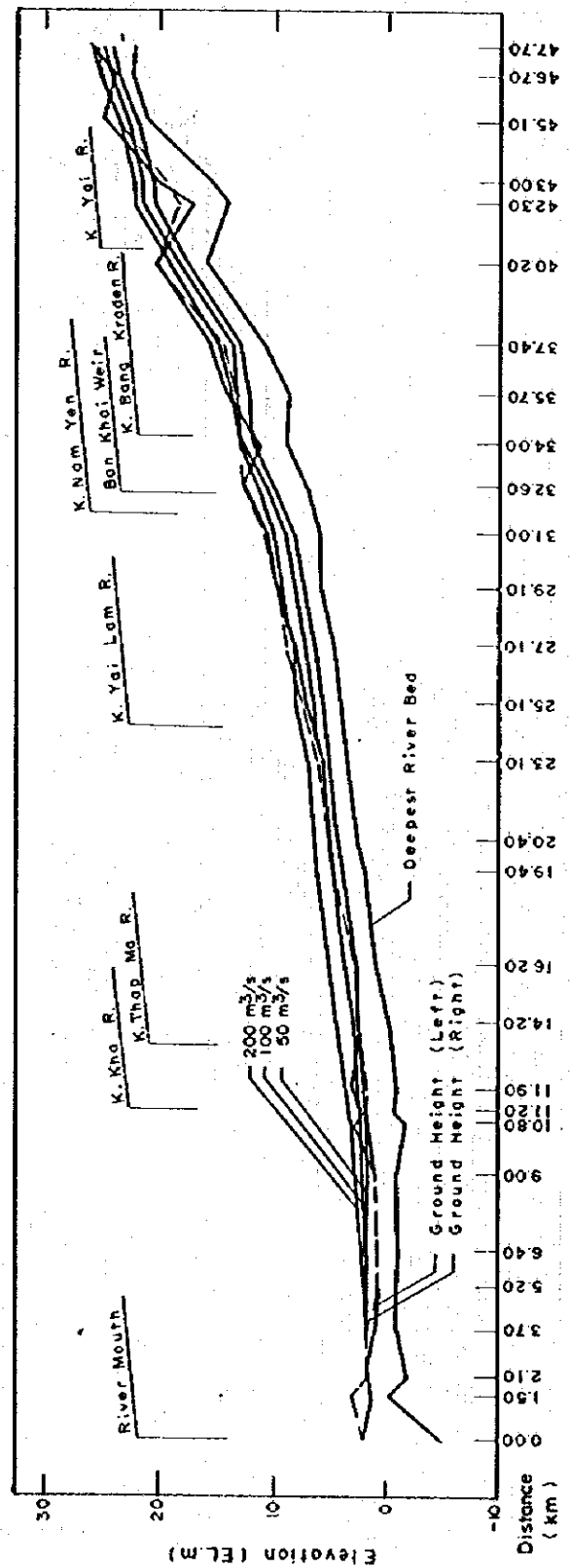
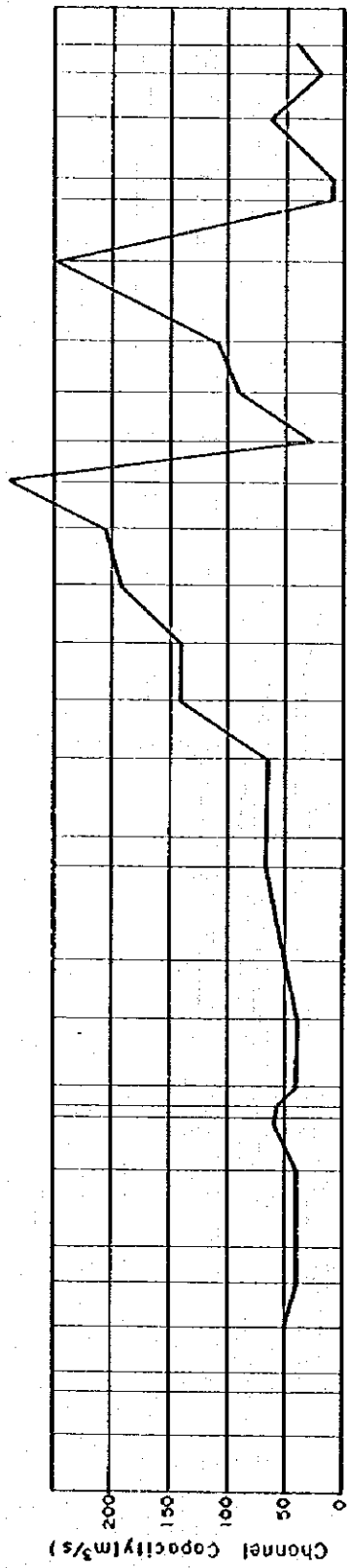
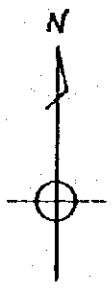

Fig.18 Longitudinal Profile and Channel Capacity of Rayong River

KINGDOM OF THAILAND
 THE EAST COAST WATER RESOURCES
 DEVELOPMENT PROJECT PHASE II
 JAPAN INTERNATIONAL COOPERATION AGENCY



Legend

- Drainage Boundary of Rayong River
- Drainage Boundary of Sub-basin
- Existing dam
- Dam under planning
- No. of sub-basin
- Weir

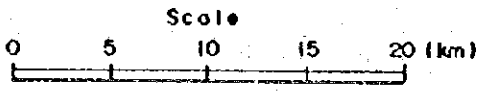
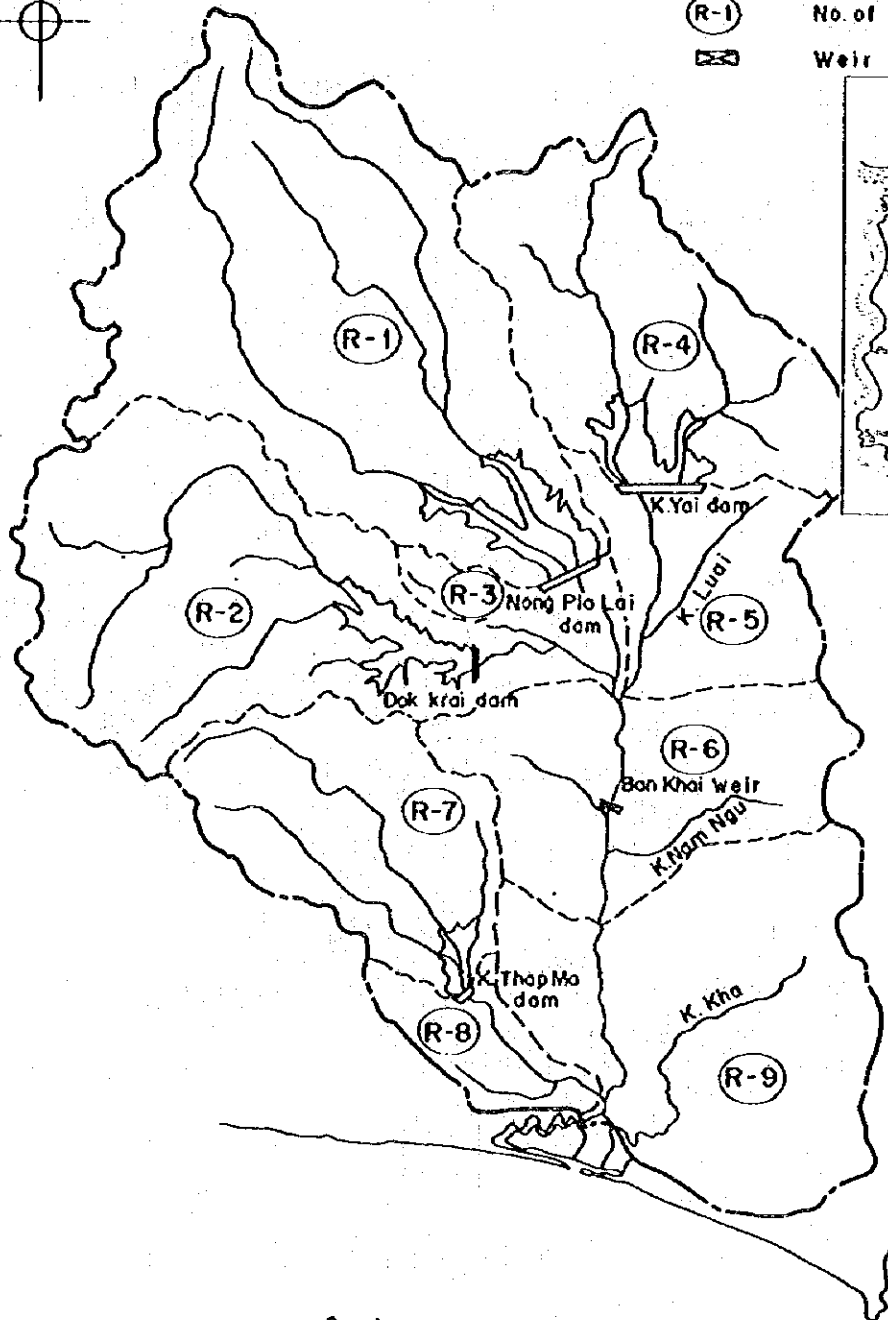
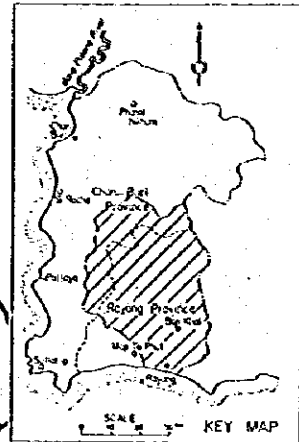

Fig.19 Sub-basins of Rayong River Basin for Runoff Analysis

KINGDOM OF THAILAND
THE EAST COAST WATER RESOURCES DEVELOPMENT PROJECT PHASE II
 JAPAN INTERNATIONAL COOPERATION AGENCY

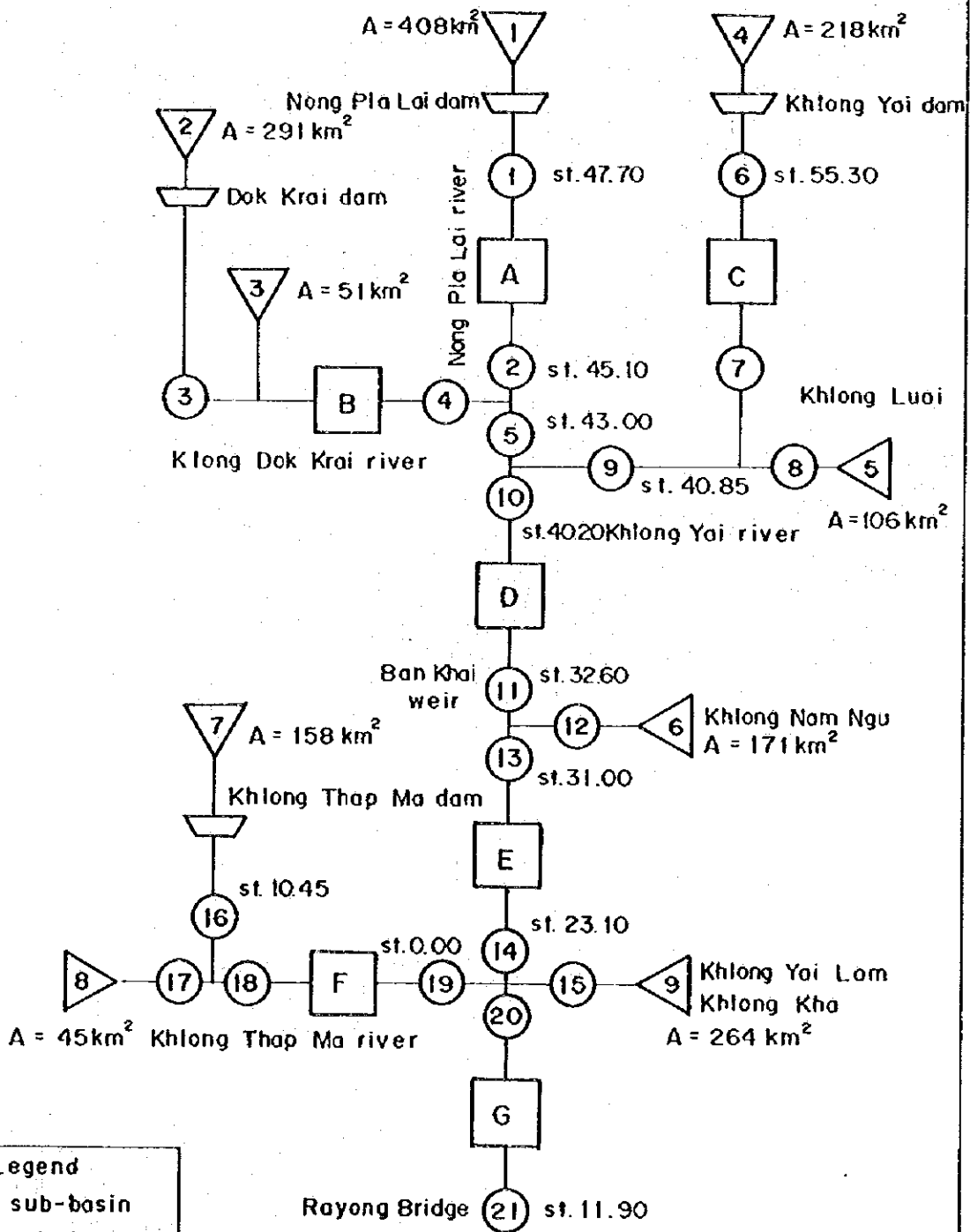

Fig.20 Runoff Calculation Model Diagram, Rayong River Basin

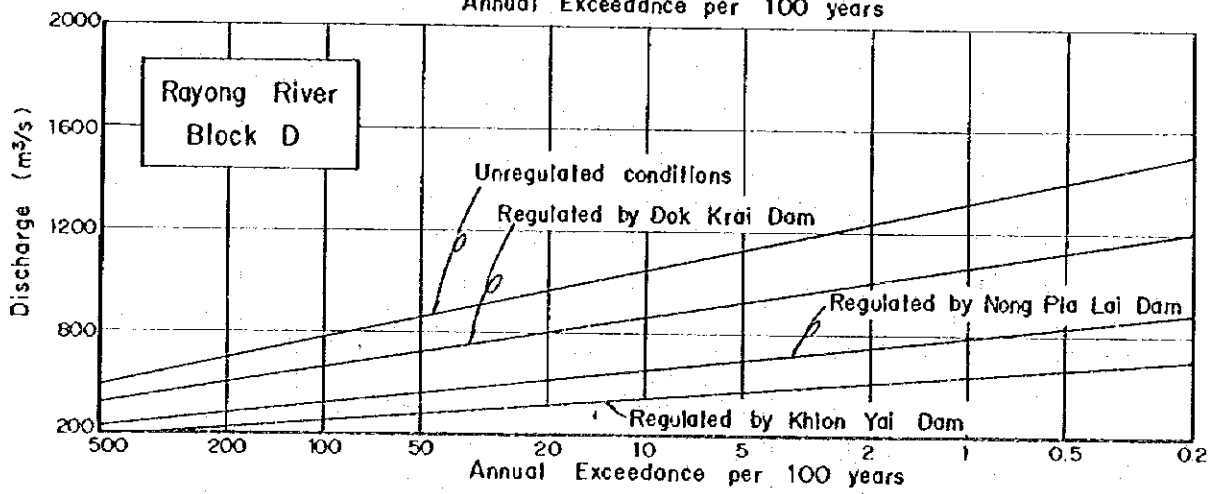
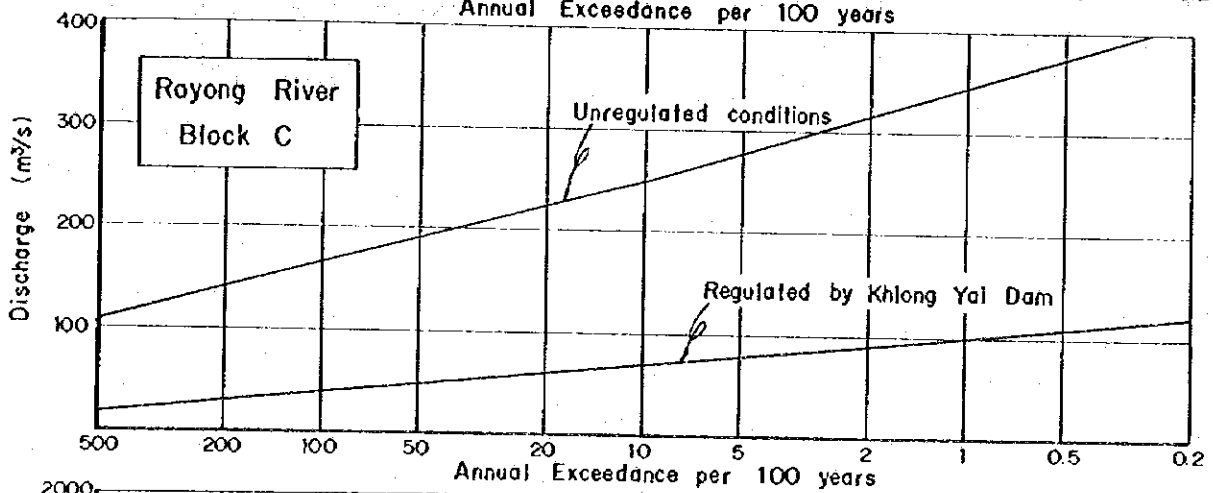
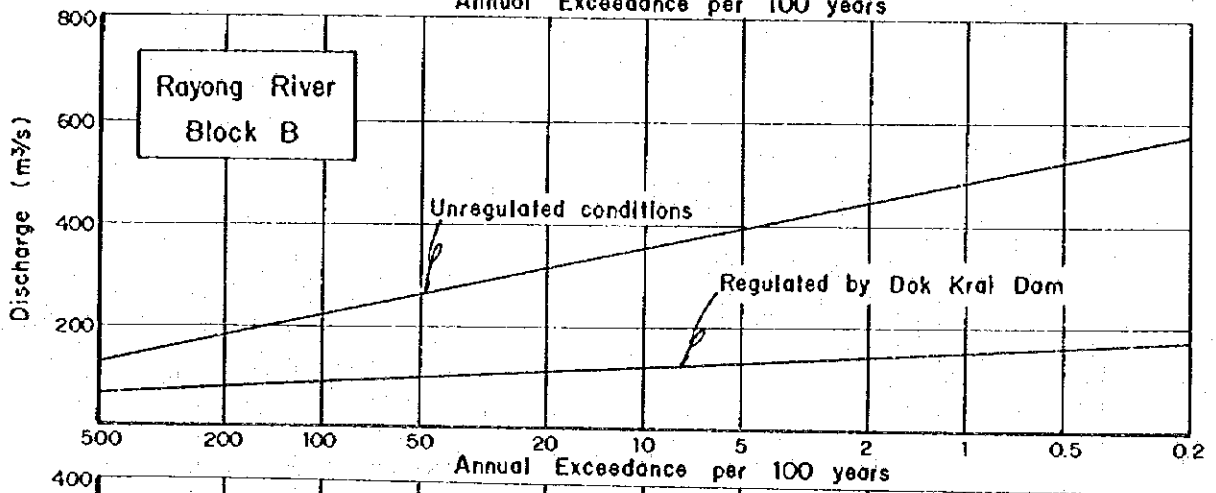
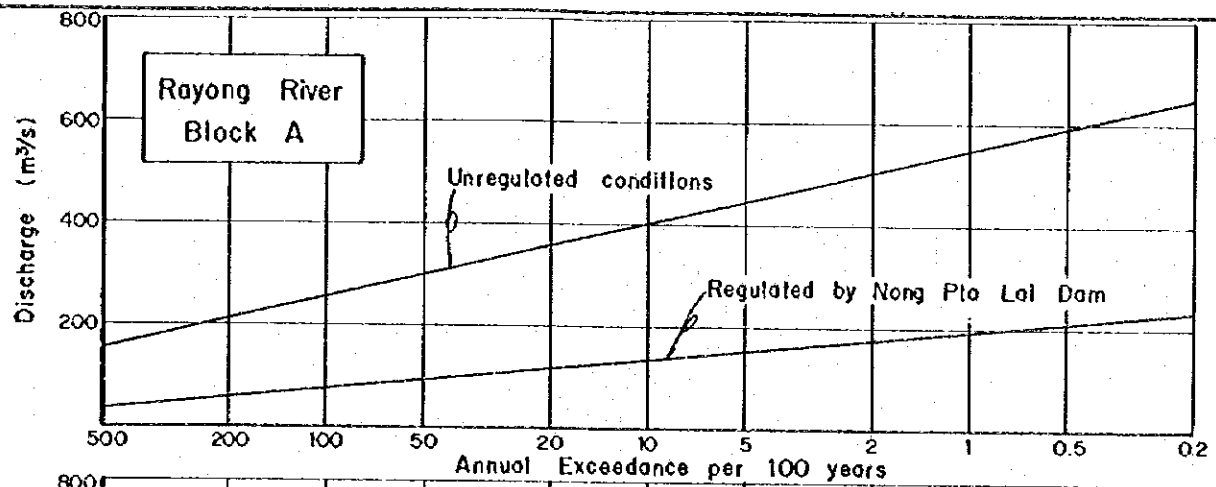

Fig. 21 Flood Frequency Curve of Rayong River (1/2)

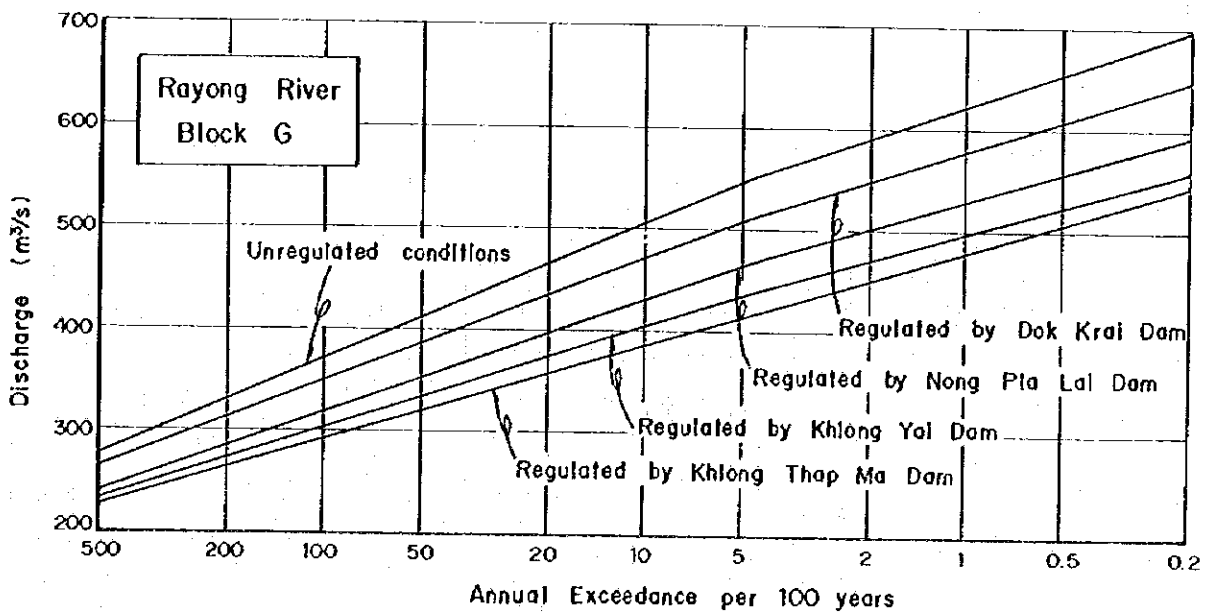
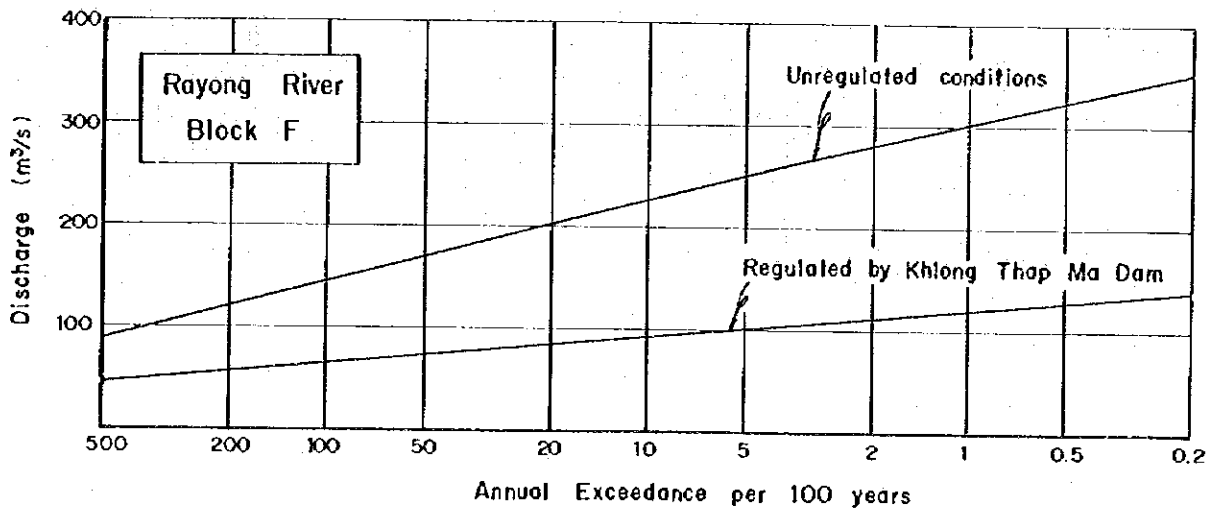
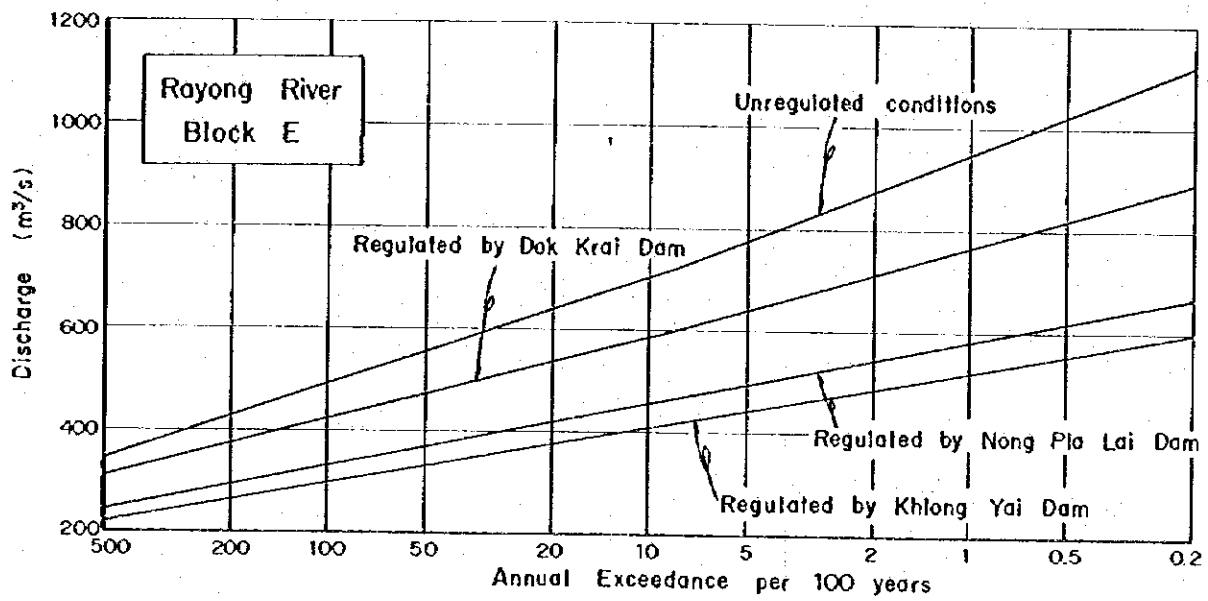

Fig. 21 Flood Frequency Curve of Rayong River (2/2)

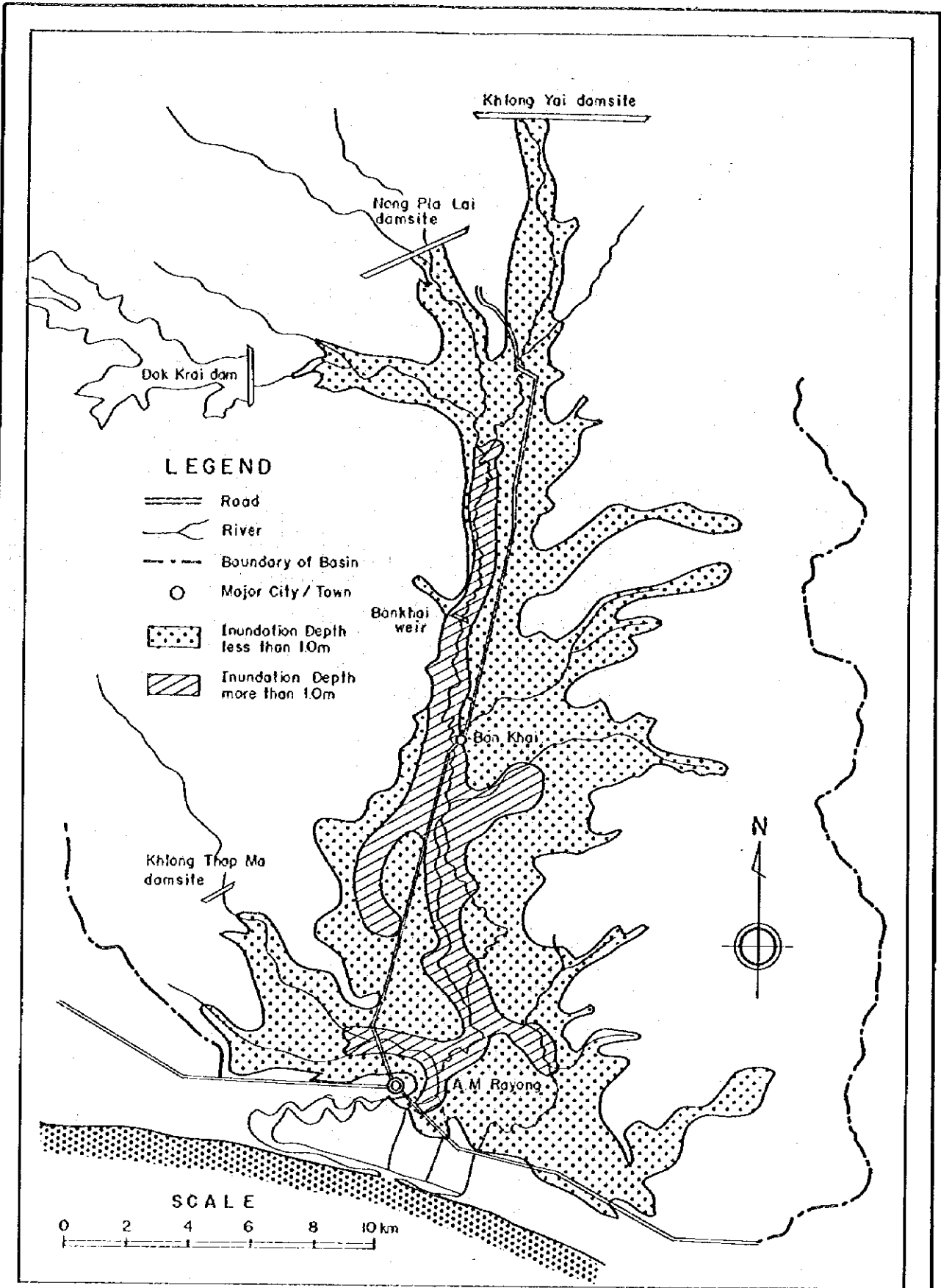

Fig.22 Inundation Area of Rayong River Basin (1974)

KINGDOM OF THAILAND
 THE EAST COAST WATER RESOURCES
 DEVELOPMENT PROJECT PHASE II
 JAPAN INTERNATIONAL COOPERATION AGENCY

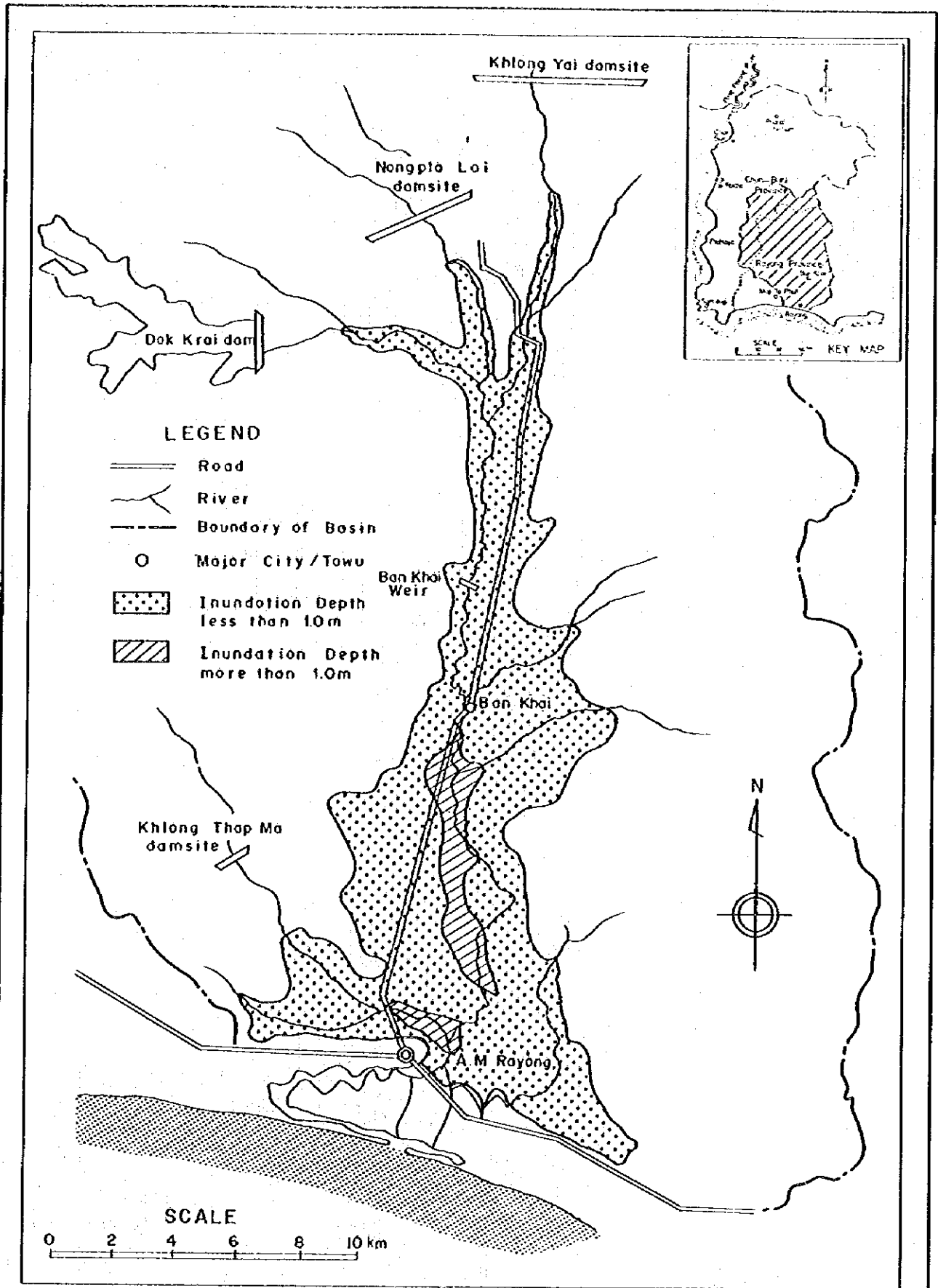

Fig.23 Inundation Area of Rayong River Basin (1981)

KINGDOM OF THAILAND
 THE EAST COAST WATER RESOURCES
 DEVELOPMENT PROJECT PHASE II
 JAPAN INTERNATIONAL COOPERATION AGENCY

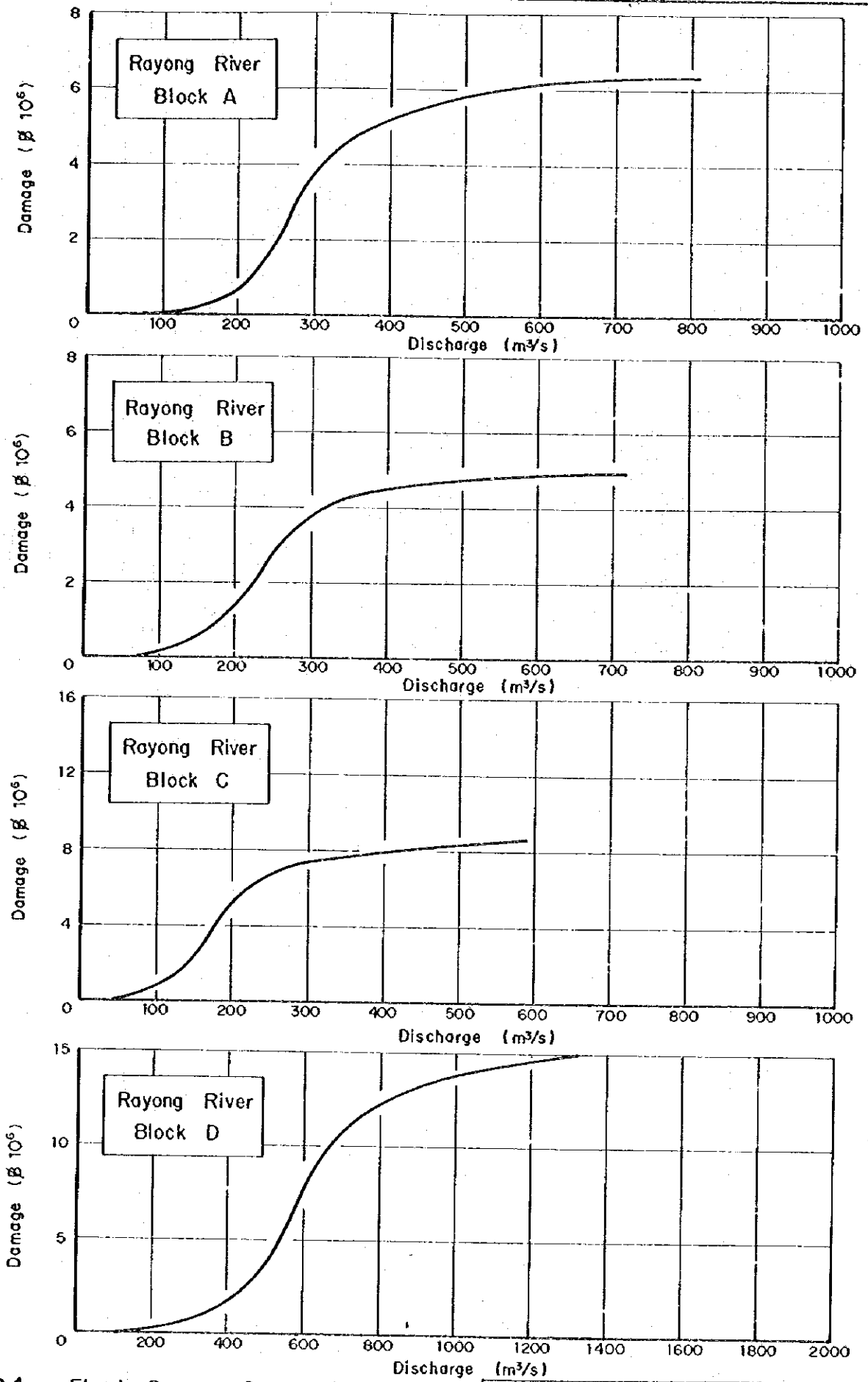

Fig. 24 Flood Damage Curve of Rayong River (1/2)

KINGDOM OF THAILAND
 THE EAST COAST WATER RESOURCES
 DEVELOPMENT PROJECT PHASE II
 JAPAN INTERNATIONAL COOPERATION AGENCY

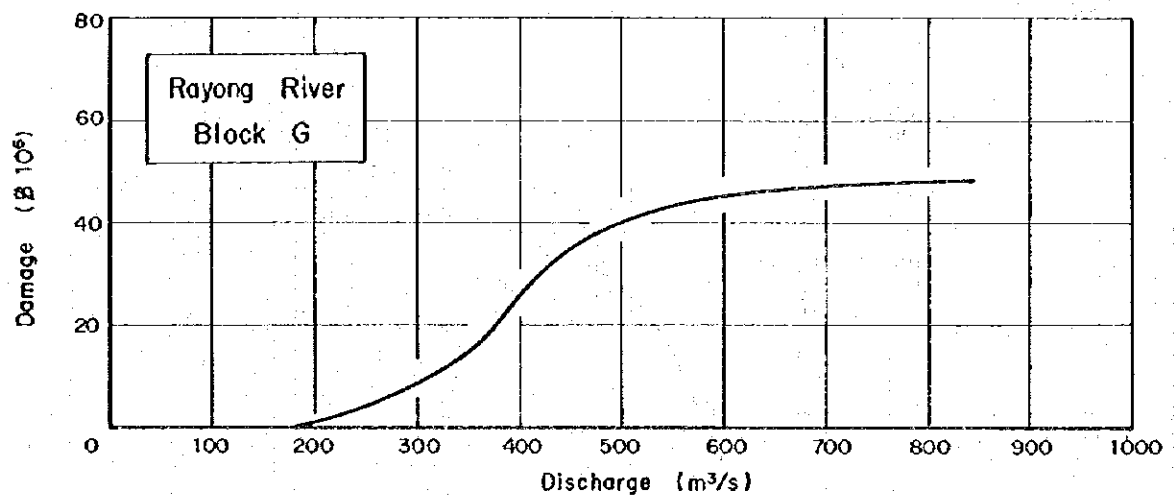
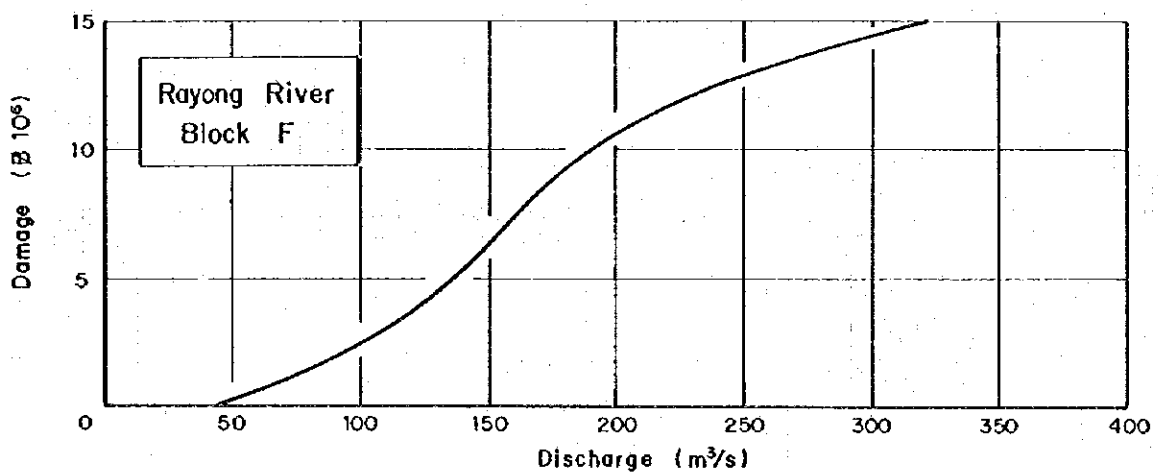
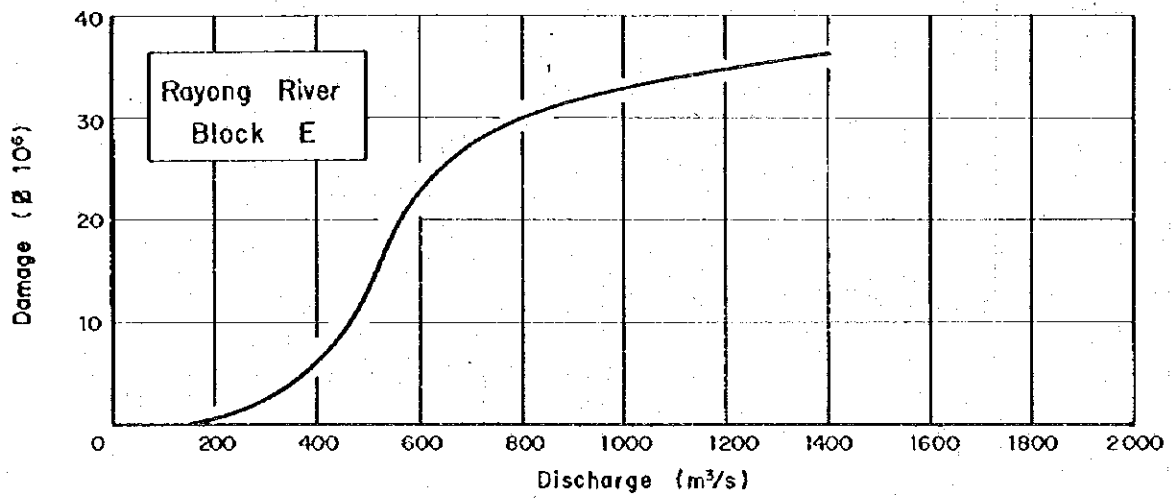

Fig.24 Flood Damage Curve of Rayong River (2/2)

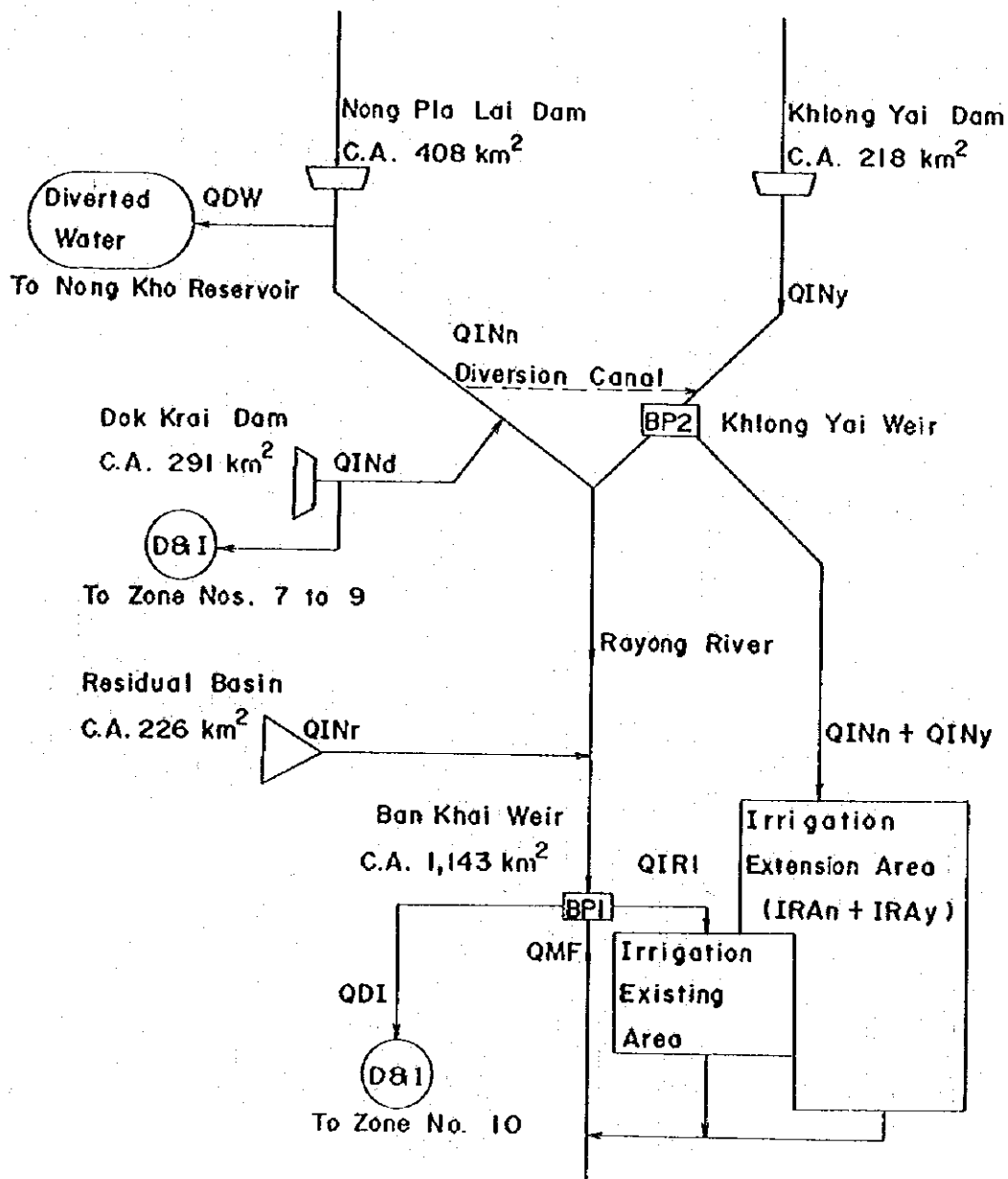

Fig. 25 Schematic Outline of Rayong River Basin

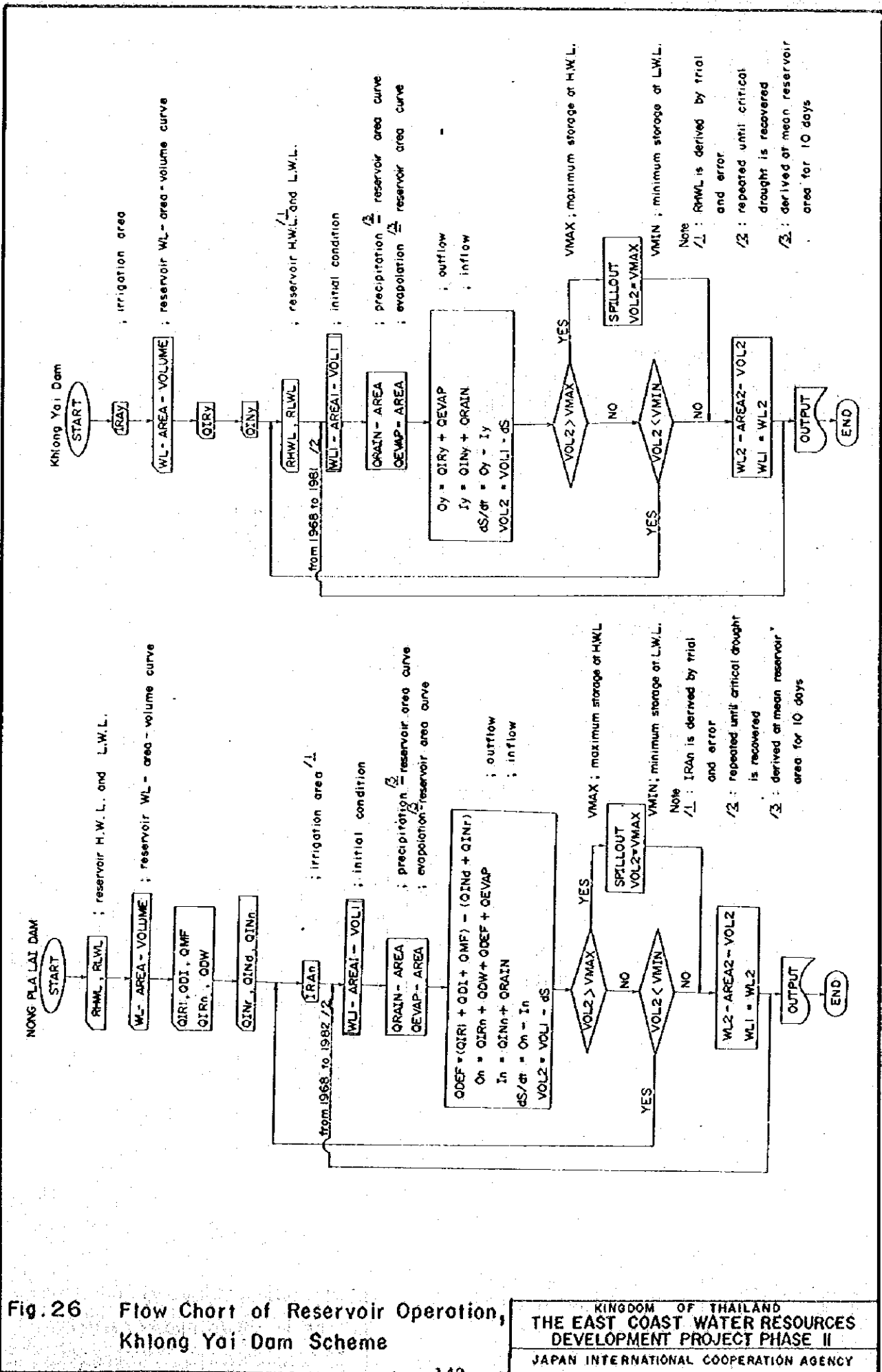
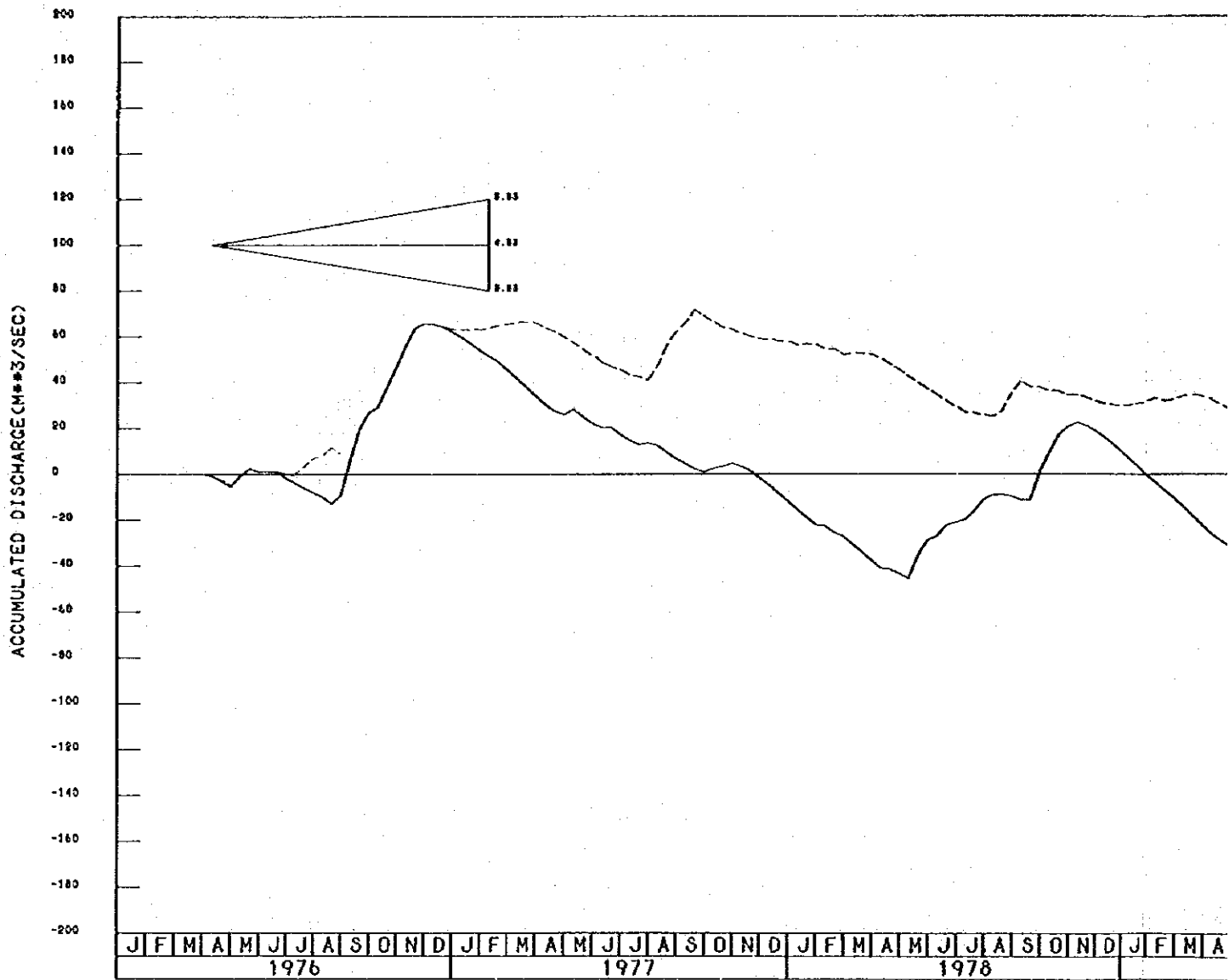

Fig. 26 Flow Chart of Reservoir Operation, Khlong Yai Dam Scheme



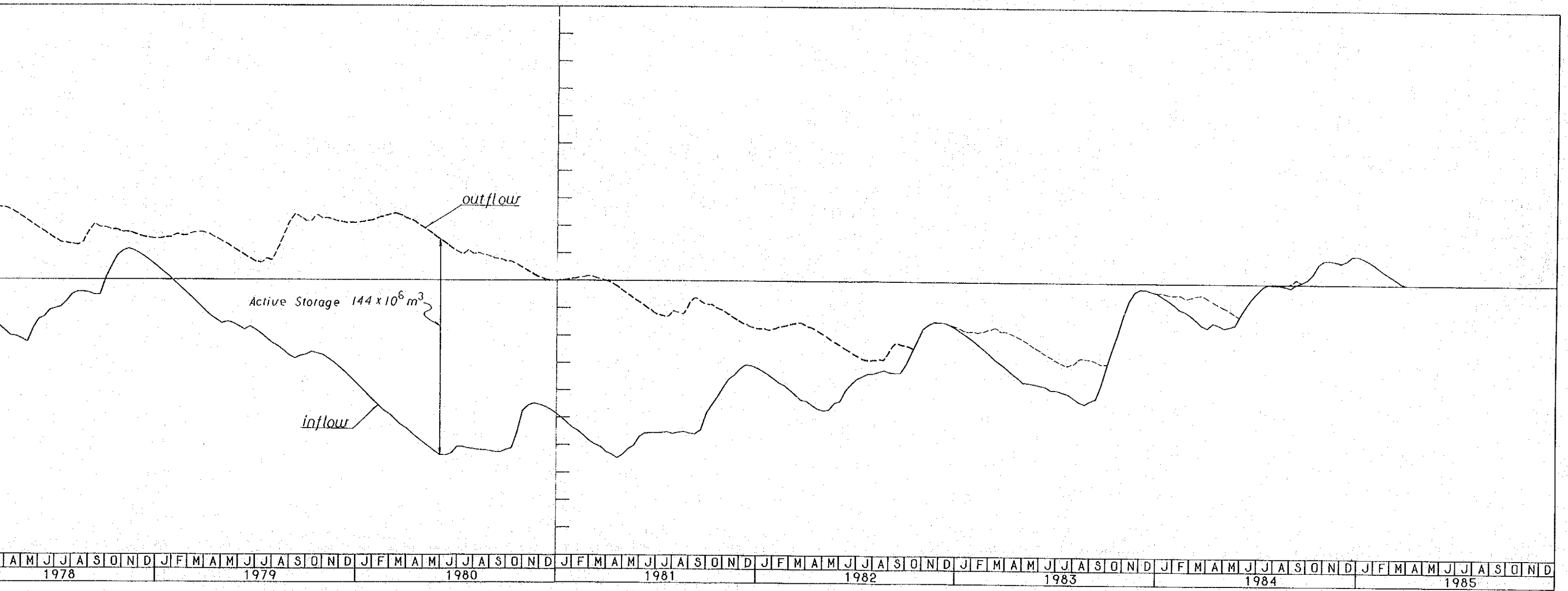

Fig. 27 Mass Curve of Inflow and Outflow at Nong Pla Lai Dam

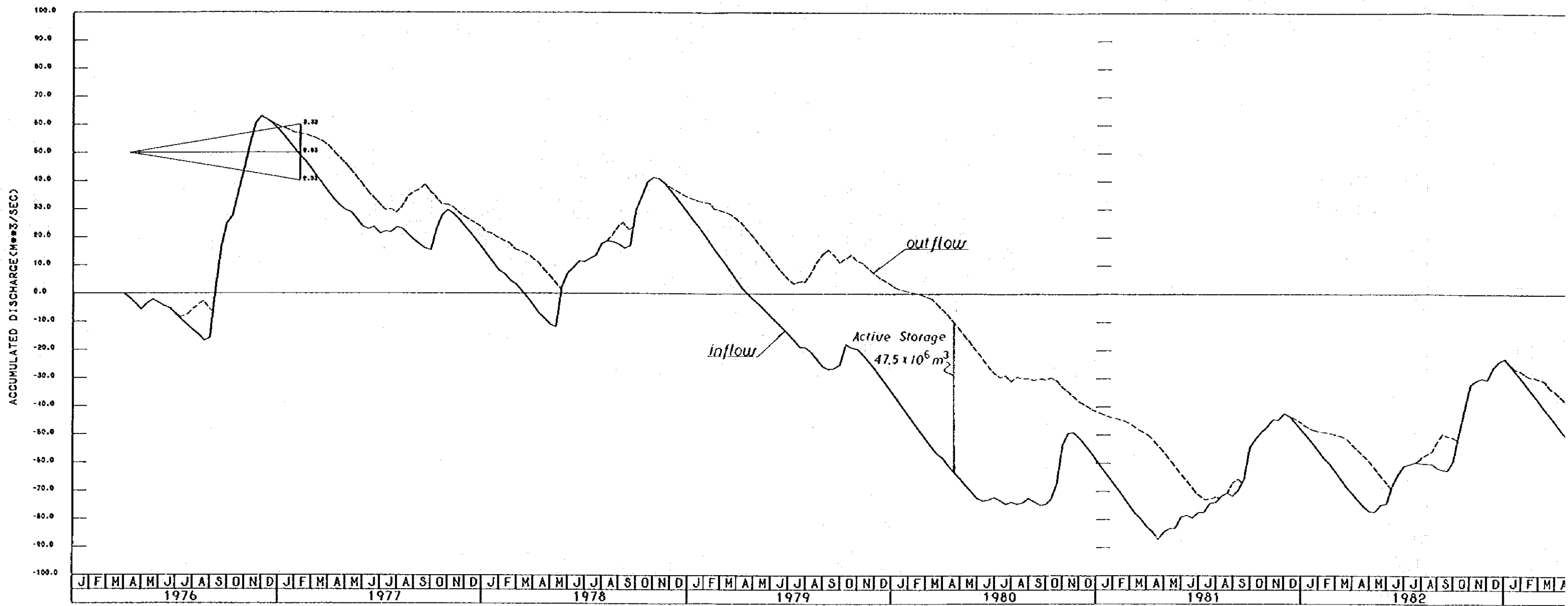

Fig. 28 Mass Curve of Inflow and Outflow at Khlong Yai Dam

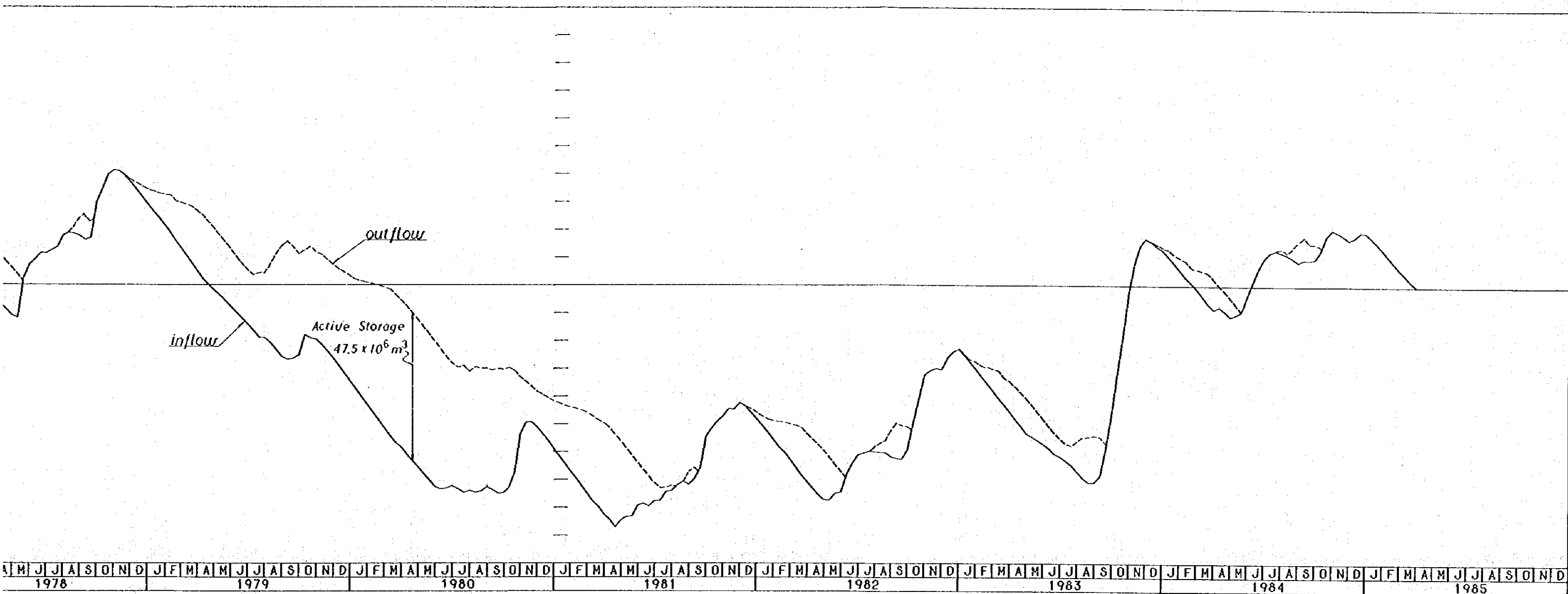
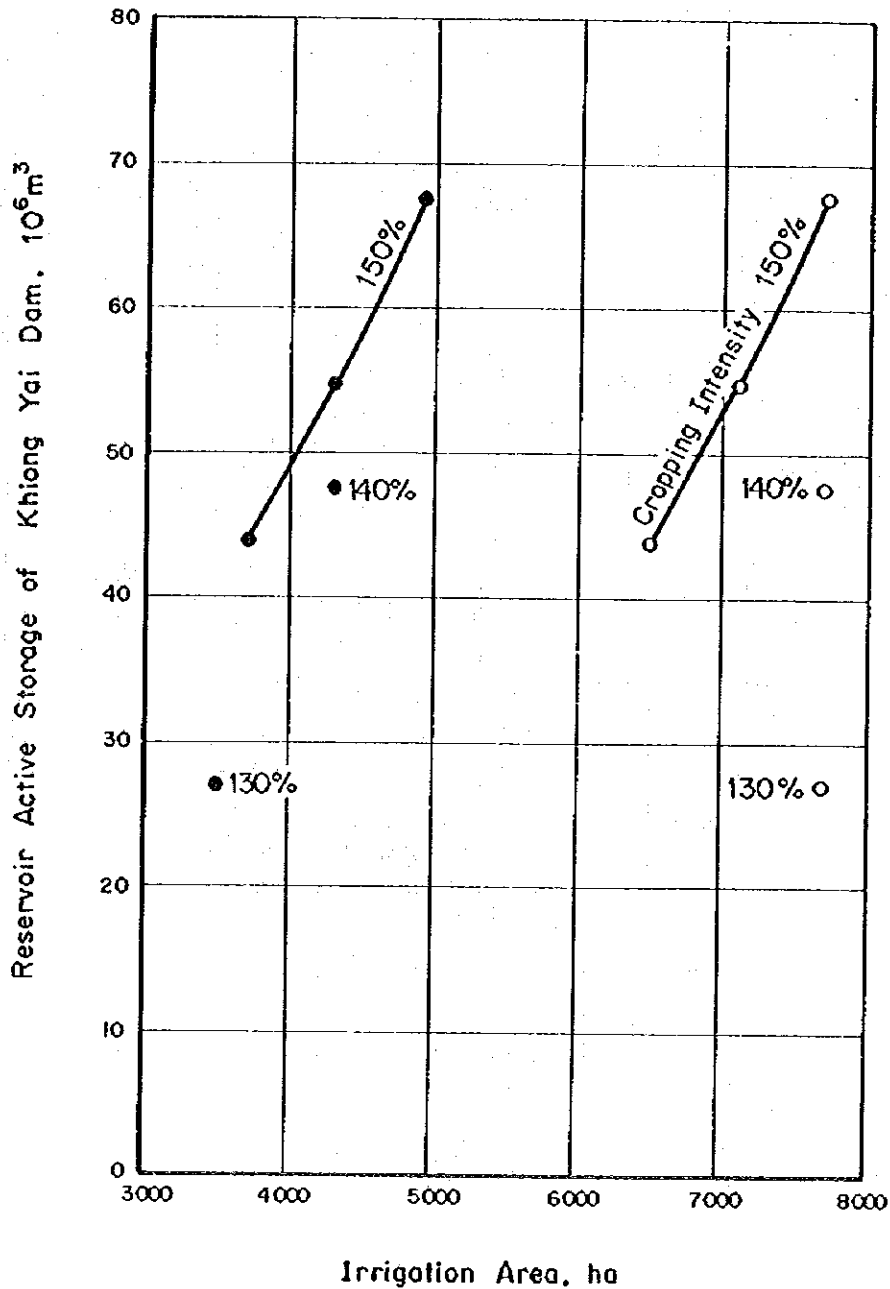

Fig.28 Mass Curve of Inflow and Outflow at Khlong Yai Dam



Irrigation Area, ha

LEGEND

- Combined operation of Nong Pla Loi Dam and Khlong Yai Dam
- Khlong Yai Dam individual operation

Fig. 29 Relationship between Irrigation Area, Cropping Intensity and Reservoir Active Storage Capacity, Khlong Yai Dam Scheme

KINGDOM OF THAILAND
 THE EAST COAST WATER RESOURCES
 DEVELOPMENT PROJECT PHASE II
 JAPAN INTERNATIONAL COOPERATION AGENCY

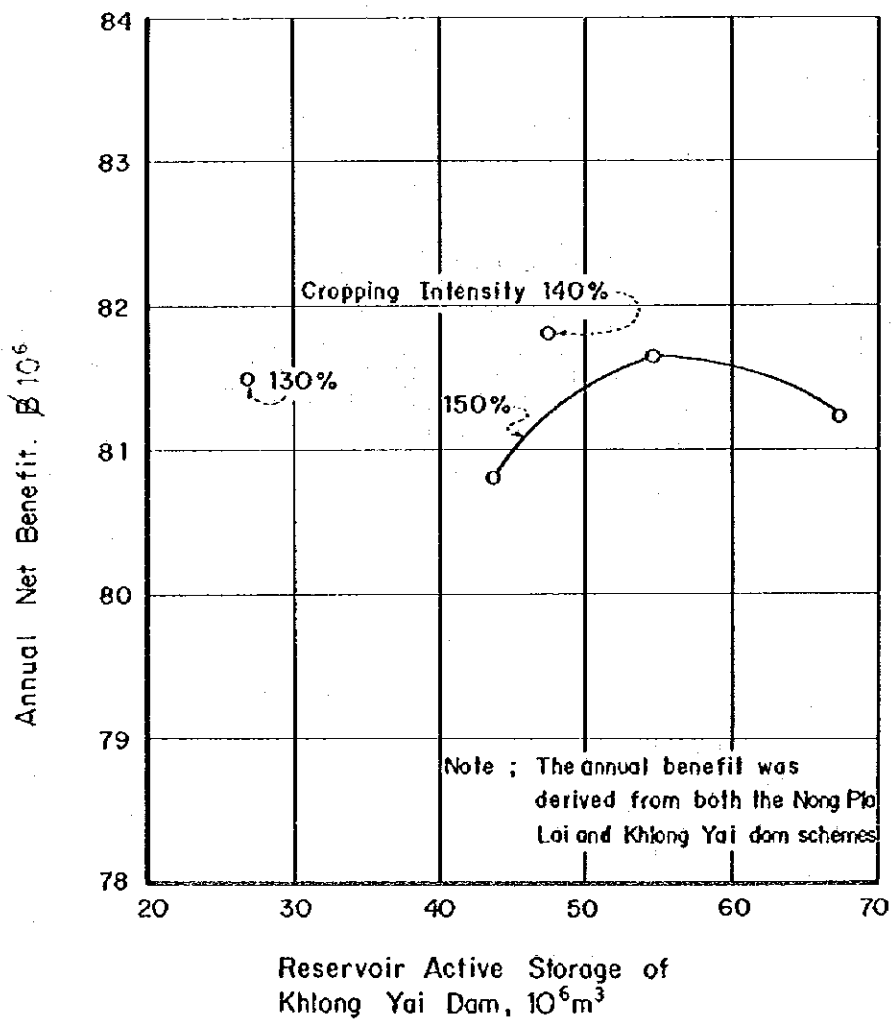

Fig. 30 Economic Comparison of Alternatives Combined Development of Nong Plo Lai and Khlong Yai Dams

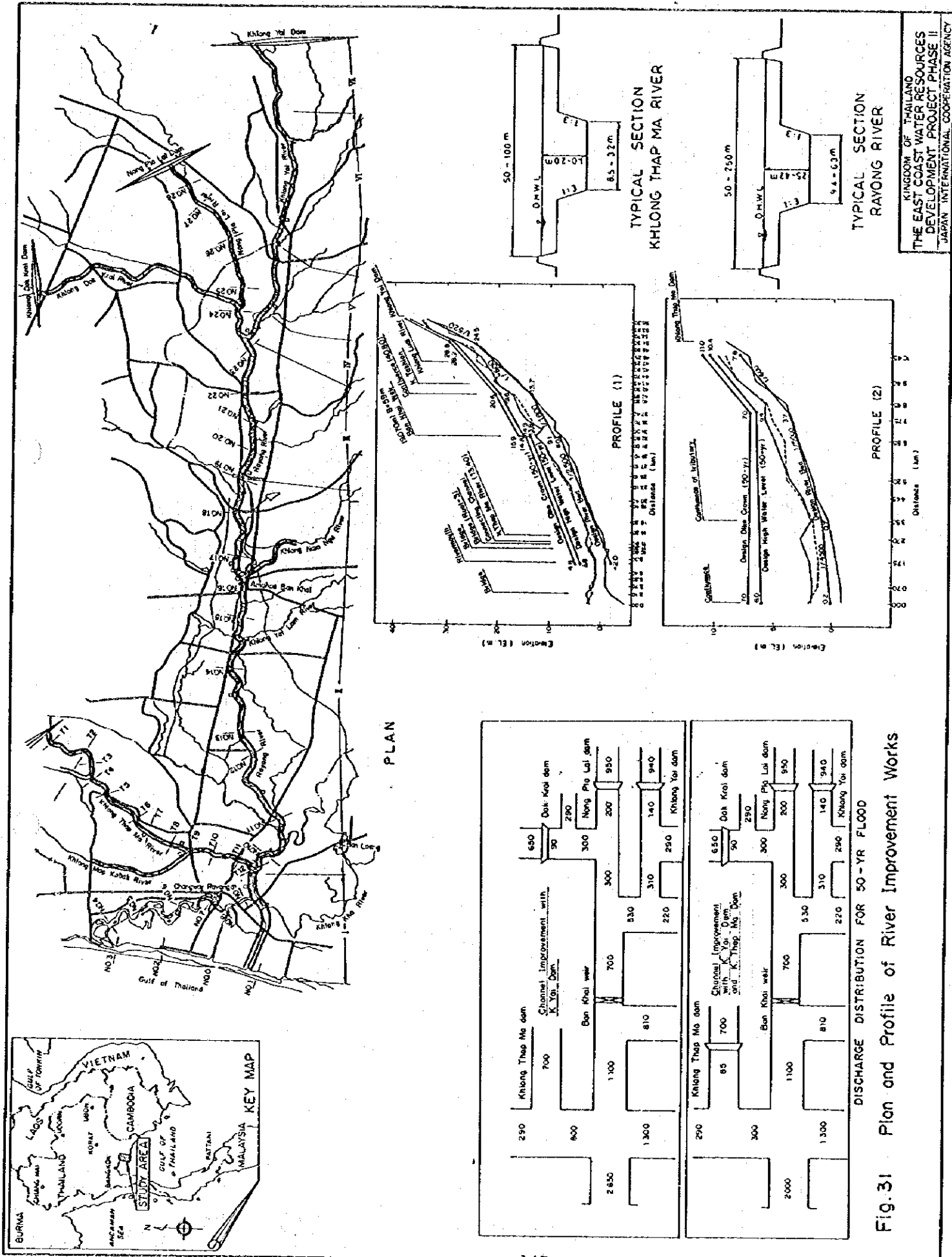

Fig. 31 Plan and Profile of River Improvement Works

KINGDOM OF THAILAND
THE EAST COAST WATER RESOURCES
DEVELOPMENT PROJECT PHASE II
JAPAN - INTERNATIONAL COOPERATION AGENCY

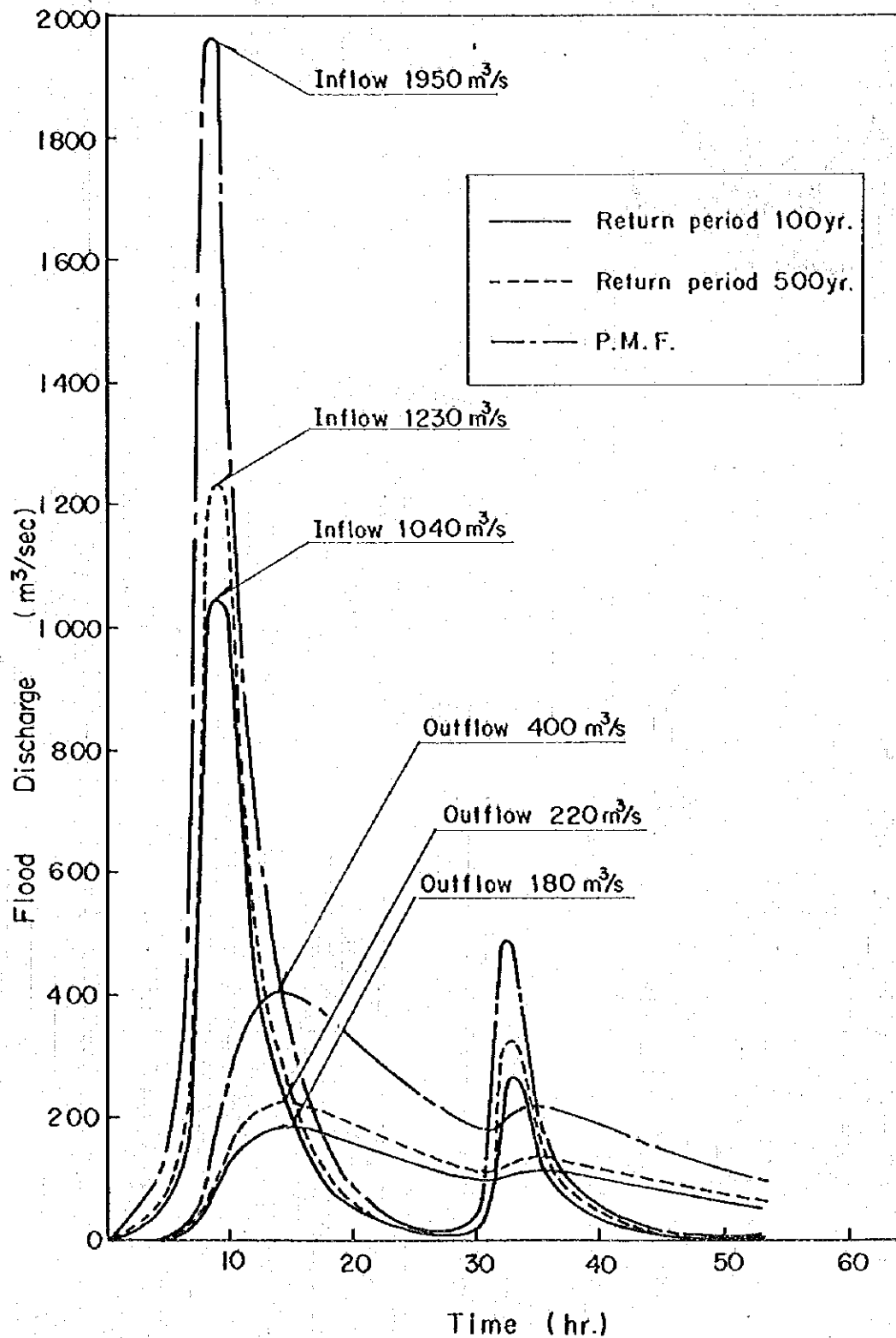

Fig. 32 Flood Routing, Khlong Yai Dam

KINGDOM OF THAILAND
 THE EAST COAST WATER RESOURCES
 DEVELOPMENT PROJECT PHASE II
 JAPAN INTERNATIONAL COOPERATION AGENCY

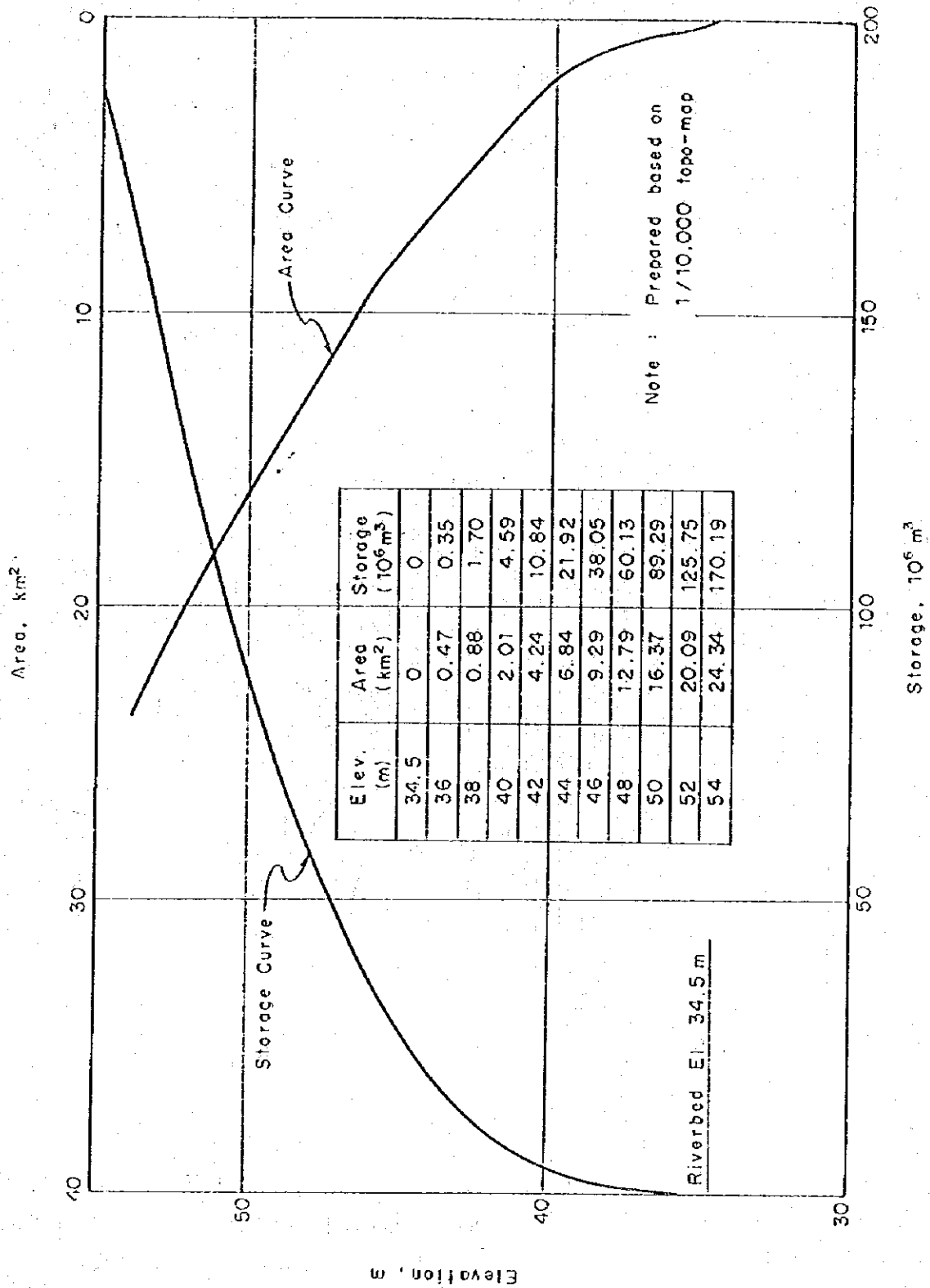

Fig. 33 Area - Storage Curve
Khlong Yai Reservoir

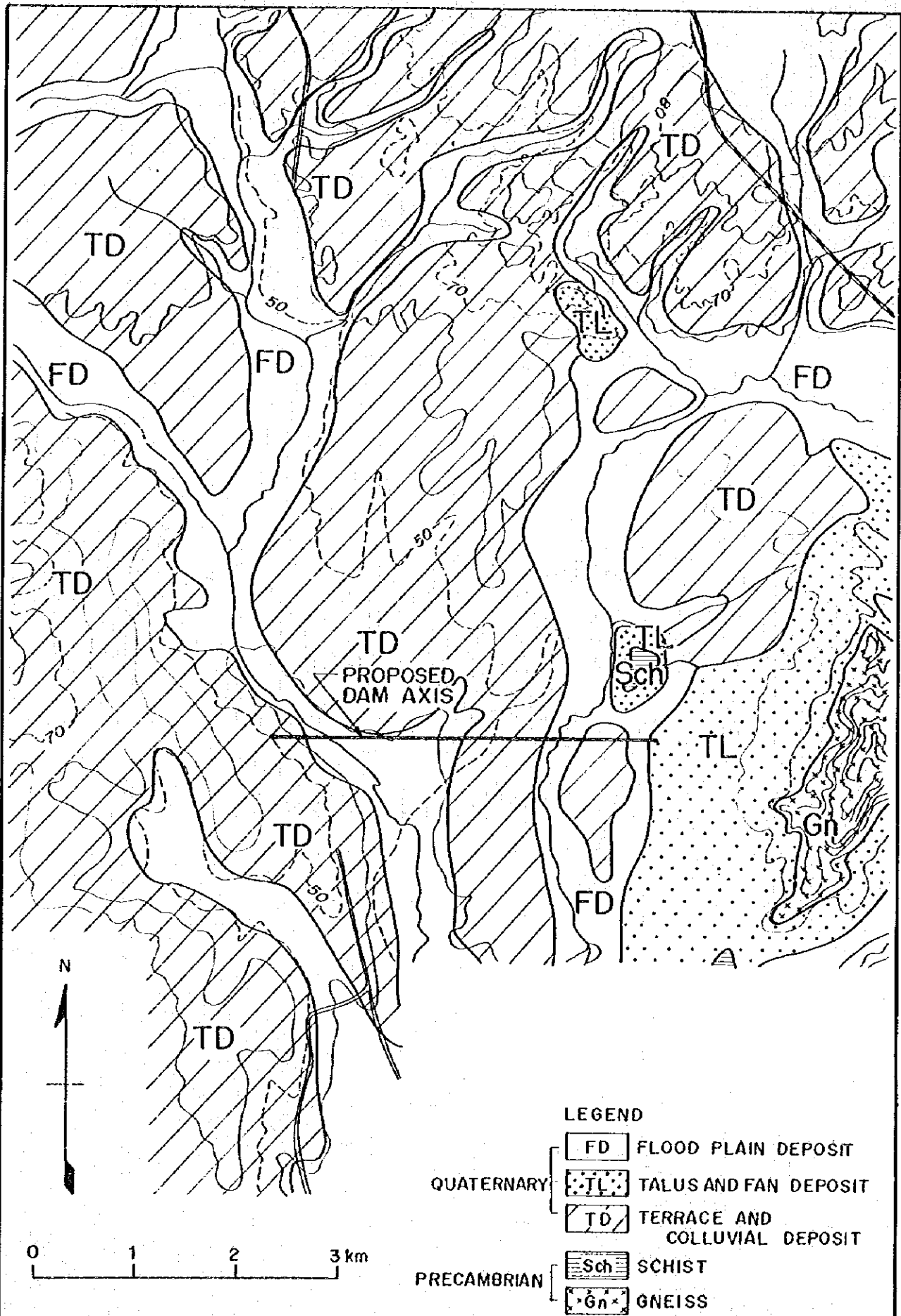

Fig. 34 Geological Map Of Khlong Yai Reservoir Area

KINGDOM OF THAILAND
 THE EAST COAST WATER RESOURCES
 DEVELOPMENT PROJECT PHASE II
 JAPAN INTERNATIONAL COOPERATION AGENCY

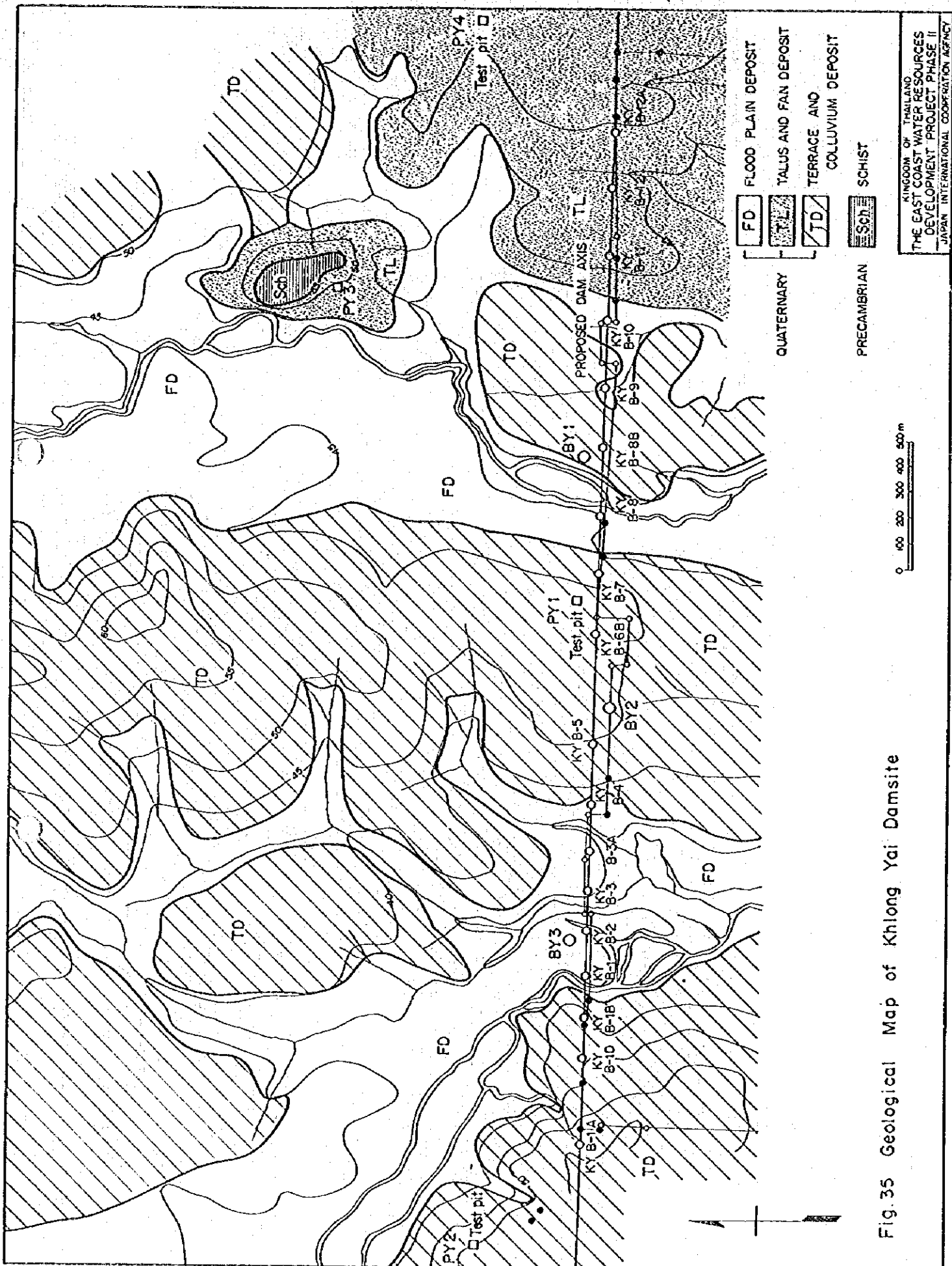

Fig 35 Geological Map of Khlong Yai Dam site

KINGDOM OF THAILAND
 THE EAST COAST WATER RESOURCES
 DEVELOPMENT PROJECT PHASE II
 JAPAN INTERNATIONAL COOPERATION AGENCY

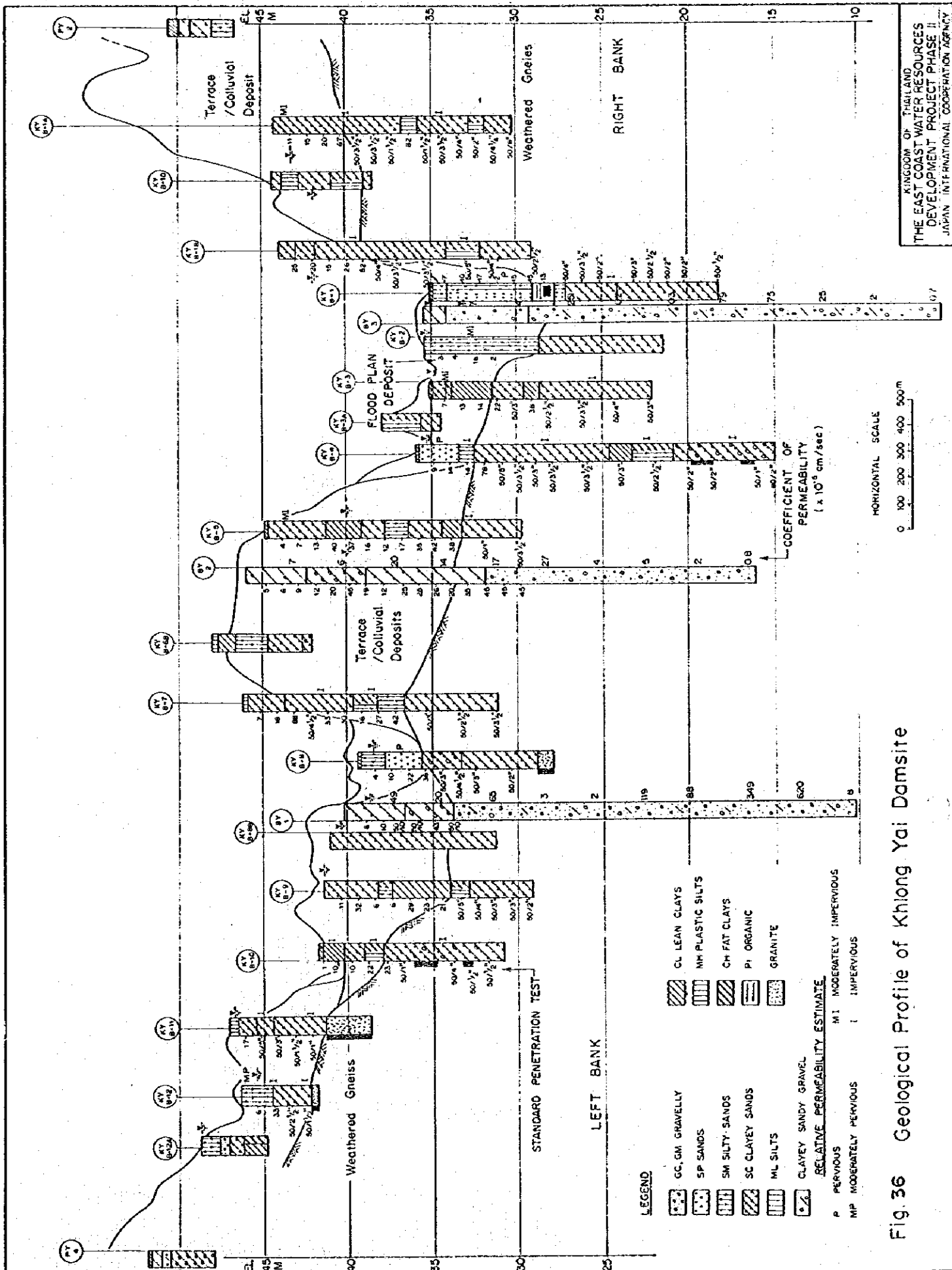
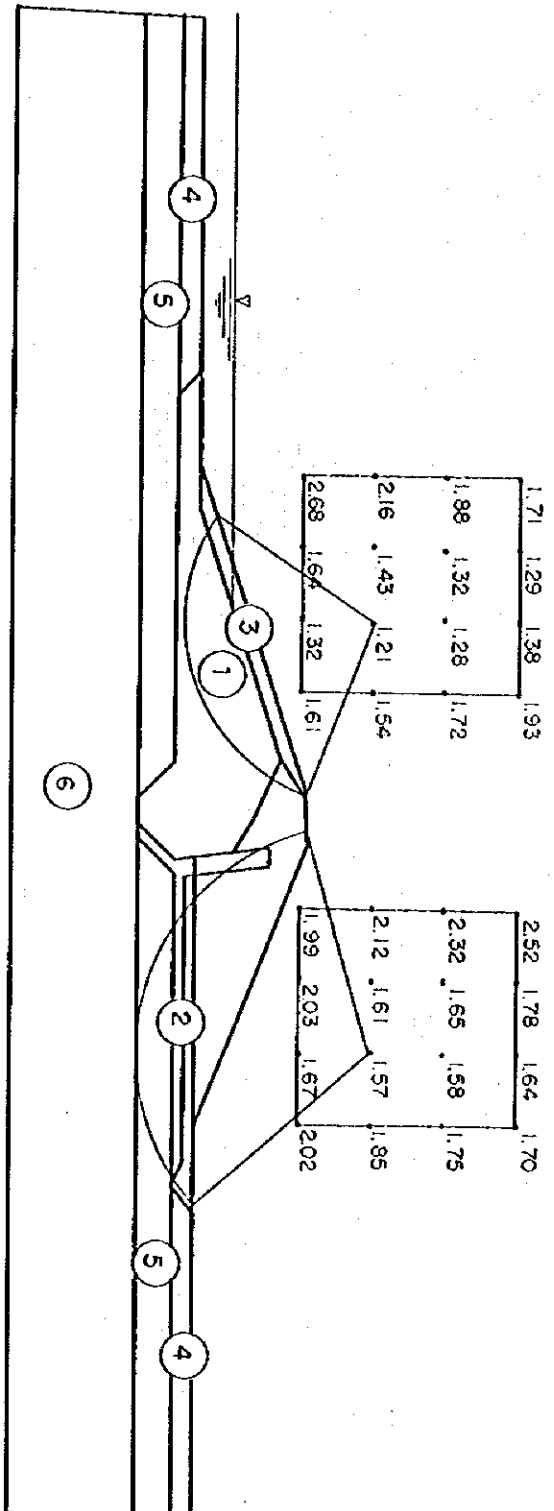

Fig. 36 Geological Profile of Khlong Yai Damsite



MATERIAL	COHESION (T/M ²)	FRICTION (DEC)	W (WET) (T/M ³)	W (SAT) (T/M ³)	W (SUB) (T/M ³)
1	1.00	28.00	2.00	2.10	1.10
2	0.00	35.00	1.85	2.15	1.15
3	0.00	40.00	1.90	2.15	1.15
4	2.00	25.00	1.80	1.85	0.85
5	2.00	28.00	1.85	1.94	0.94
6	10.00	35.00	2.10	2.30	1.30

MINIMUM SAFETY FACTOR (SEISMIC)		
	UP STREAM SIDE	DOWN STREAM SIDE
NORMAL	—	—
SEISMIC	1.213	1.567

Fig.37 Stability Analysis (1/2) (Low Water Surface)

MATERIAL	COHESION (T/M ²)	FRICTION (DEC)	W (WET) (T/M ²)	W (SAT) (T/M ²)	W (SUB) (T/M ³)
1	1.00	28.00	2.00	2.10	1.10
2	0.00	35.00	1.85	2.15	1.15
3	0.00	40.00	1.90	2.15	1.15
4	2.00	25.00	1.80	1.85	0.85
5	2.00	28.00	1.85	1.94	0.94
6	10.00	35.00	2.10	2.30	1.30

MINIMUM SAFETY FACTOR (NORMAL)		
NORMAL	UP STREAM SIDE	DOWN STREAM SIDE
SEISMIC	1.350	1.251

0 50.0 M
SCALE = 1/1,000

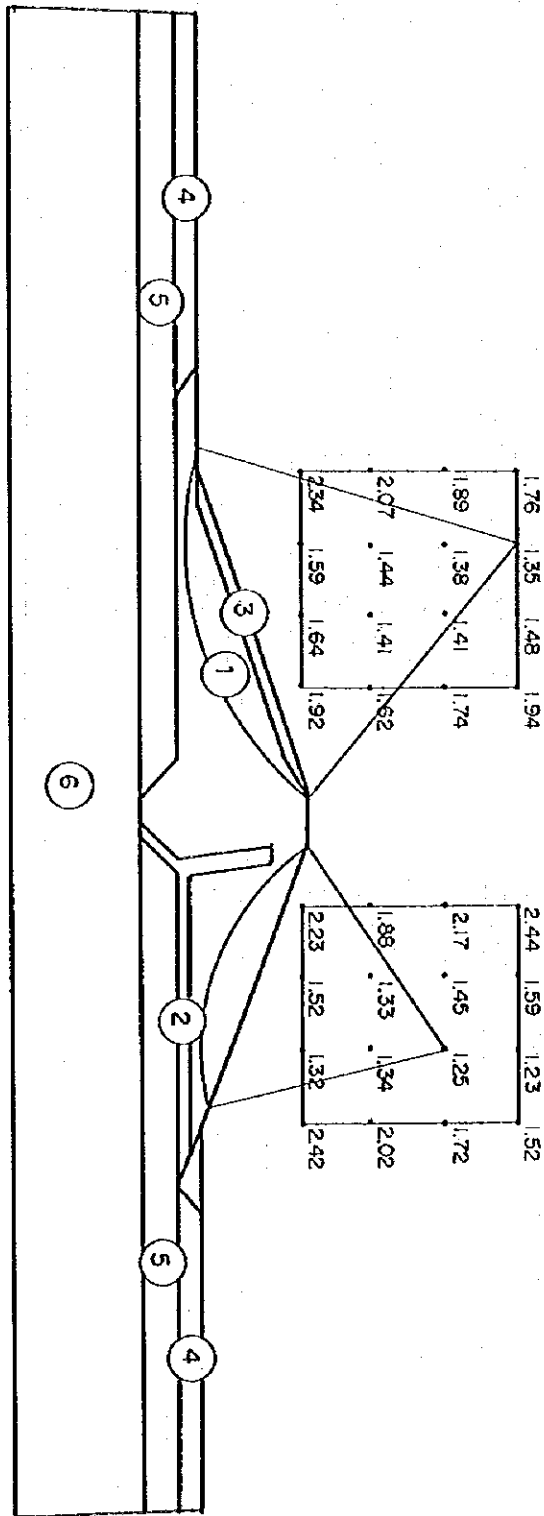
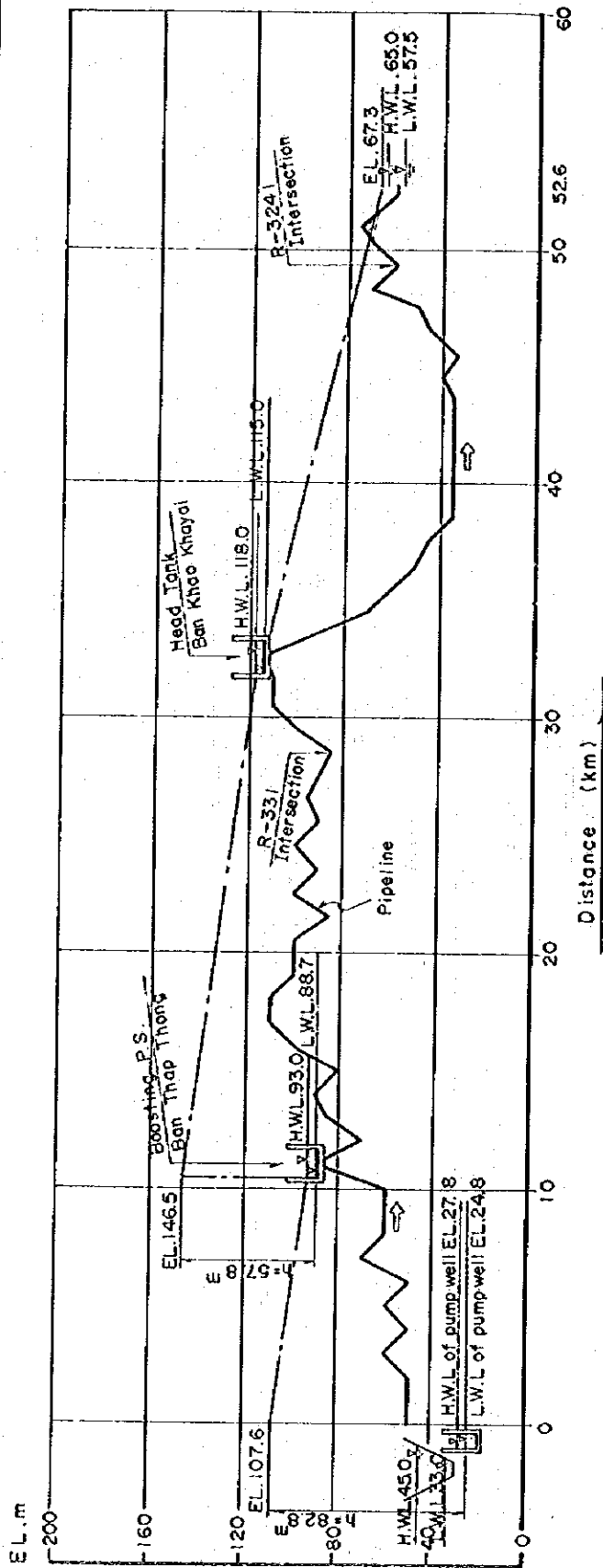

Fig.37 Stability Analysis (2/2)
(Reservoir Empty After Completion)



Discharge (m ³ /s)	1.30 (1st. phase 0.65) (2nd. phase 0.65)	20.2 km
Diameter (mm)	900 x 2	800 x 2
Hydraulic Gradient/1000m	1.33	2.36
Length (m)	11.0	20.2
Friction Loss (m)	14.6	47.7
Velocity (m/s)	1.02	1.29
Net Head (m)	82.8	50.0
Gross Head (m)	85.0	—

Fig.38 Hydraulic Gradient Line of Nong Pra Lai Pipeline System

(from Nong Pla Lai Dam to Nong Kho Dam)

KINGDOM OF THAILAND
THE EAST COAST WATER RESOURCES
DEVELOPMENT PROJECT PHASE II

JAPAN INTERNATIONAL COOPERATION AGENCY

Fig. 39 Implementation Schedule of Khlong Yai Dam Scheme

WORK ITEMS	Q'ty	1993	1994	1995	1996	1997	1998	1999	2000
1. Main Pile Lot. Dam									
1.1. Investigation & Design									
1.2. Tender & Contract Award									
1.3. Land Acquisition & Compensation									
1.4. Mobilization & Preparatory Work									
1.5. Core of River	2,500,000 m ³								
1.6. Main Dam	1,000,000 m ³								
1.7. Spillway	1,000,000 m ³								
1.8. Abutment	1,000,000 m ³								
2. Abutment Yai Dam									
2.1. Investigation & Design									
2.2. Tender & Contract Award									
2.3. Land Acquisition & Compensation									
2.4. Mobilization & Preparatory Work									
2.5. Core of River	1,000,000 m ³								
2.6. Main Dam	1,000,000 m ³								
2.7. Spillway	1,000,000 m ³								
3. Water Conveyance System									
3.1. Investigation & Design									
3.2. Tender & Contract Award									
3.3. Land Acquisition & Compensation									
3.4. Mobilization & Preparatory Work									
3.5. Intake	1,000 m ³								
3.6. Pipeline	1,000 m								
3.7. Booster P/g	1,000 m								
3.8. Head Tank	1,000 m ³								
4. Irrigation & Drainage System									
4.1. Investigation & Design									
4.2. Tender & Contract Award									
4.3. Land Acquisition & Compensation									
4.4. Mobilization & Preparatory Work									
4.5. Main Pile Lot	1,000 m ³								
4.6. Main Pile Lot	1,000 m ³								
4.7. Main Canal	40.2 km								
4.8. Lateral Canal	12.3 km								
4.9. Drainage Canal	12.4 km								
5. Water Conveyance System									
5.1. Investigation & Design									
5.2. Tender & Contract Award									
5.3. Mobilization & Preparatory Work									
5.4. Intake	1,000 m ³								
5.5. Pipeline	1,000 m								
5.6. Booster P/g	1,000 m								

LEGEND
 Ex. : Excavation
 Em. : Embankment
 Con. : Concrete
 ☐ : Wet Season
 ☐ : Dry Season
 10 : Months

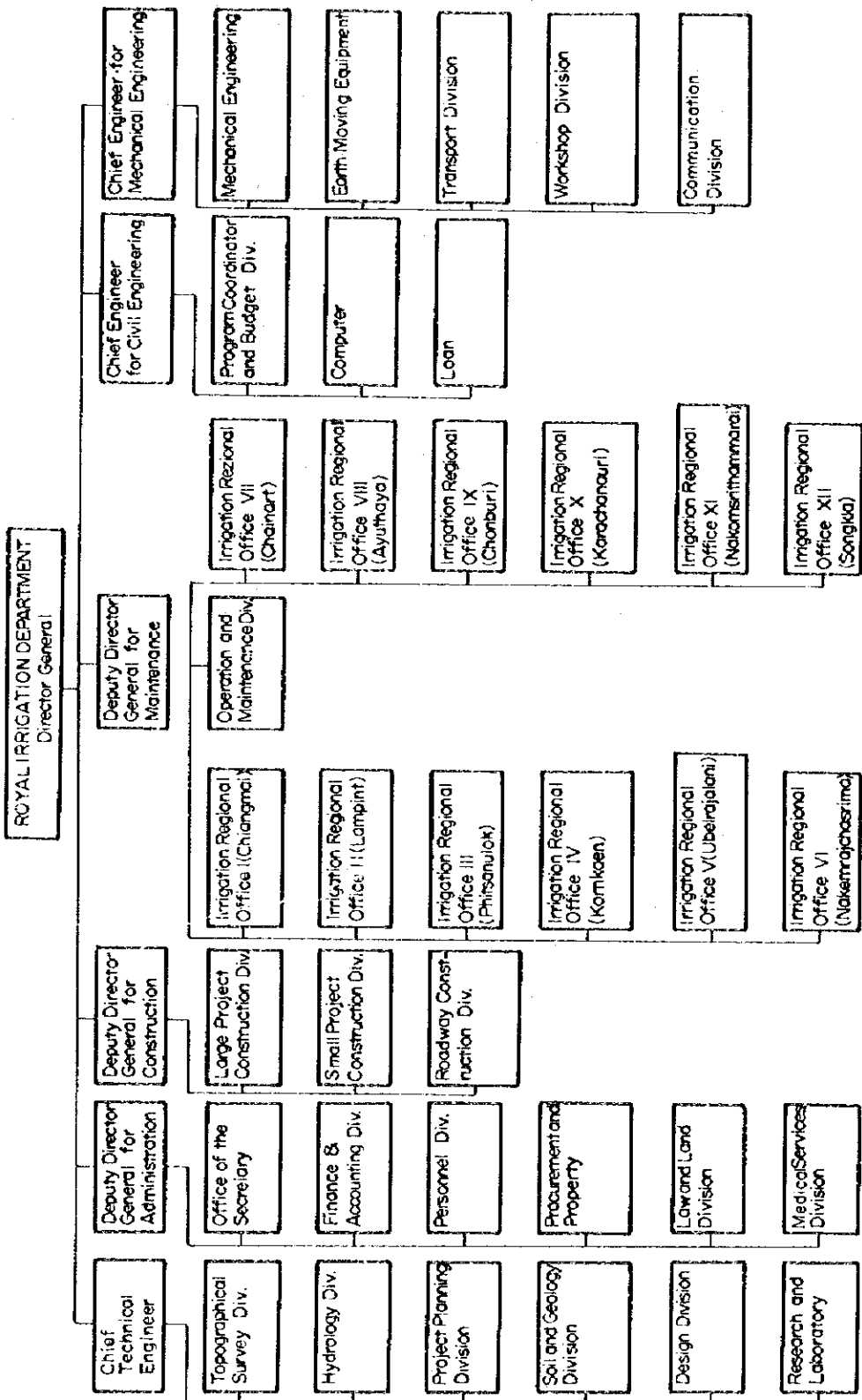

Fig. 40 Organization Chart of Royal Irrigation Department

KINGDOM OF THAILAND
 THE EAST COAST WATER RESOURCES
 DEVELOPMENT PROJECT PHASE II
 JAPAN INTERNATIONAL COOPERATION AGENCY

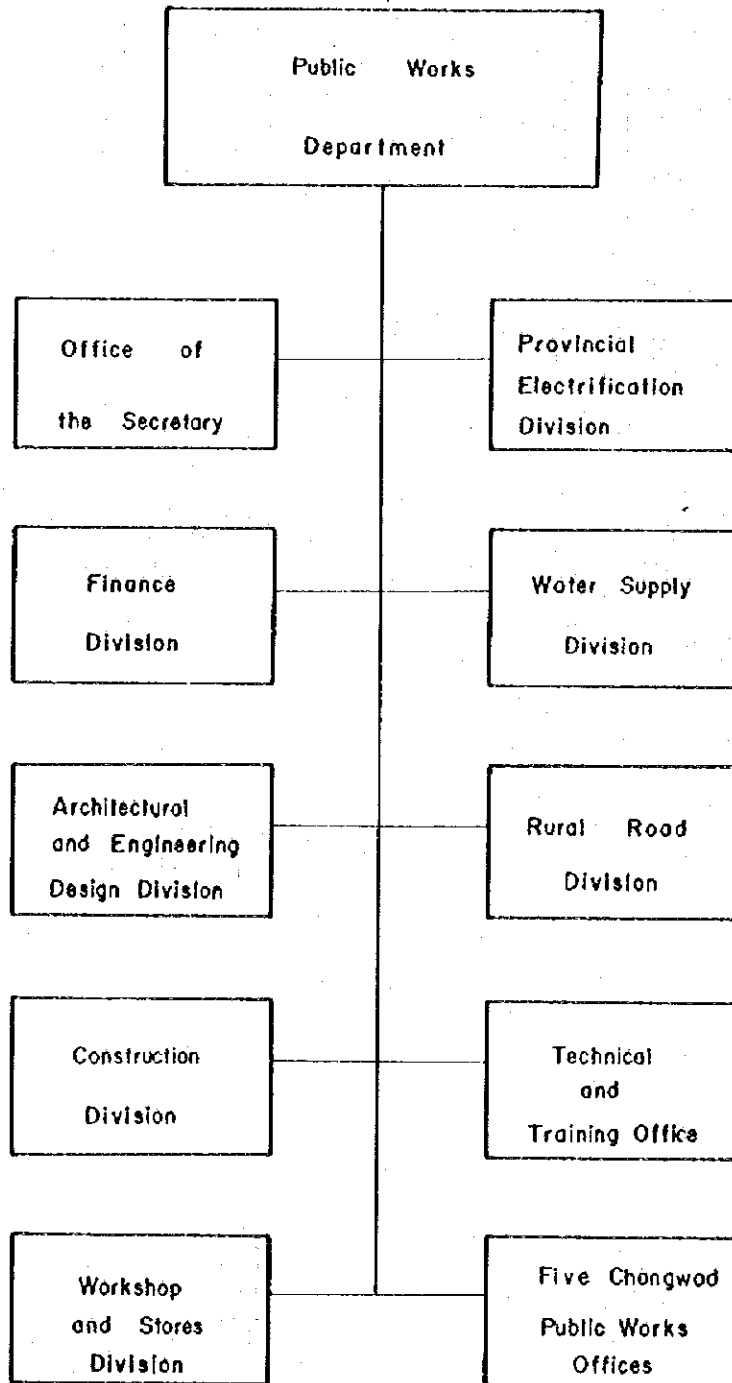

Fig. 41 Organization Chart of Public Works Department

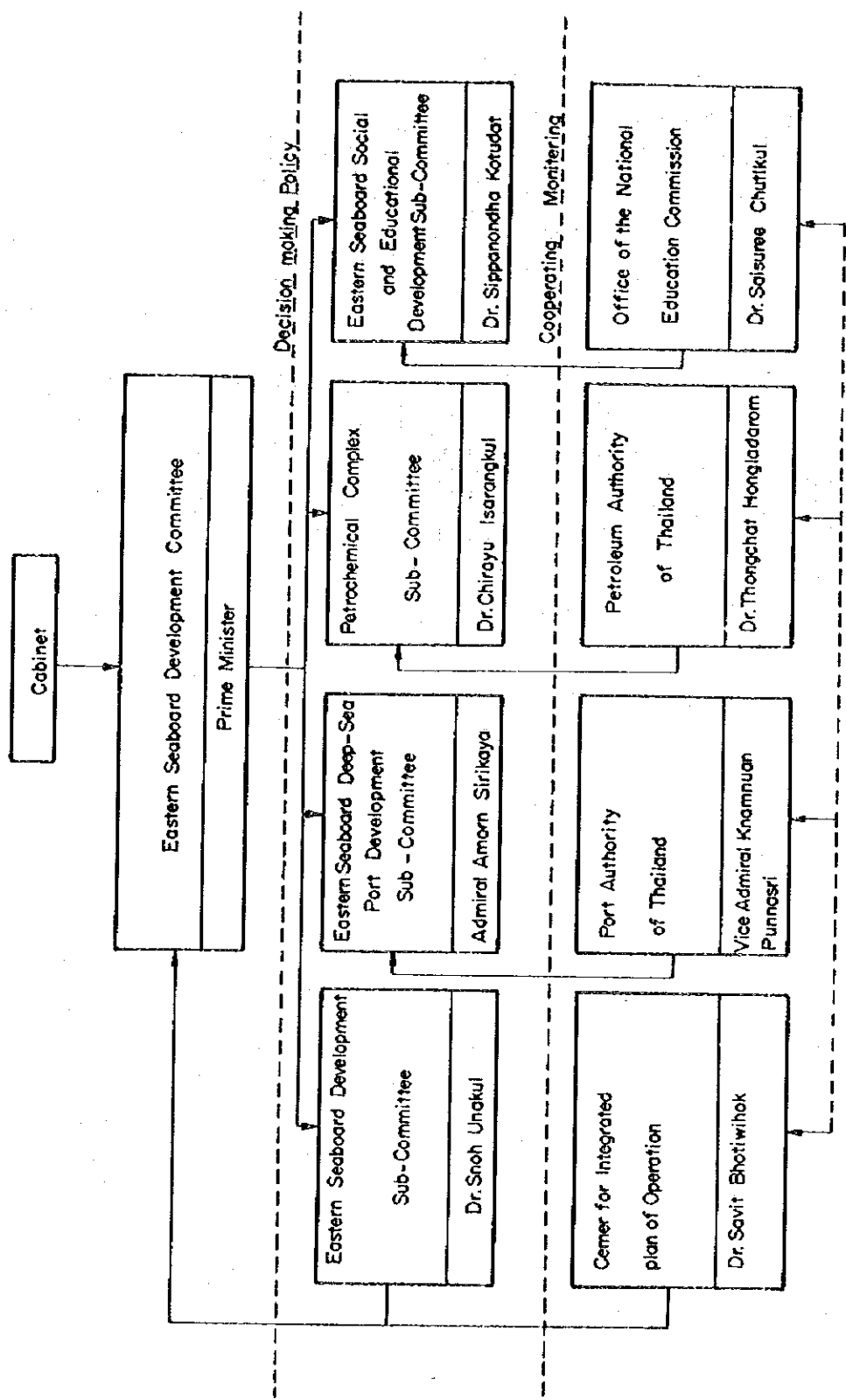

Fig. 42 Organization Chart of Eastern Seaboard Development Committee

KINGDOM OF THAILAND
 THE EAST COAST WATER RESOURCES
 DEVELOPMENT PROJECT PHASE II
 JAPAN INTERNATIONAL COOPERATION AGENCY

